

Singh, Bindeshwar; Singh, Swati

Article

GA-based optimization for integration of DGs, STATCOM and PHEVs in distribution systems

Energy Reports

Provided in Cooperation with:

Elsevier

Suggested Citation: Singh, Bindeshwar; Singh, Swati (2019) : GA-based optimization for integration of DGs, STATCOM and PHEVs in distribution systems, Energy Reports, ISSN 2352-4847, Elsevier, Amsterdam, Vol. 5, pp. 84-103, <https://doi.org/10.1016/j.egyr.2018.09.005>

This Version is available at:

<https://hdl.handle.net/10419/243567>

Standard-Nutzungsbedingungen:

Die Dokumente auf EconStor dürfen zu eigenen wissenschaftlichen Zwecken und zum Privatgebrauch gespeichert und kopiert werden.

Sie dürfen die Dokumente nicht für öffentliche oder kommerzielle Zwecke vervielfältigen, öffentlich ausstellen, öffentlich zugänglich machen, vertreiben oder anderweitig nutzen.

Sofern die Verfasser die Dokumente unter Open-Content-Lizenzen (insbesondere CC-Lizenzen) zur Verfügung gestellt haben sollten, gelten abweichend von diesen Nutzungsbedingungen die in der dort genannten Lizenz gewährten Nutzungsrechte.

Terms of use:

Documents in EconStor may be saved and copied for your personal and scholarly purposes.

You are not to copy documents for public or commercial purposes, to exhibit the documents publicly, to make them publicly available on the internet, or to distribute or otherwise use the documents in public.

If the documents have been made available under an Open Content Licence (especially Creative Commons Licences), you may exercise further usage rights as specified in the indicated licence.



<https://creativecommons.org/licenses/by-nc-nd/4.0/>

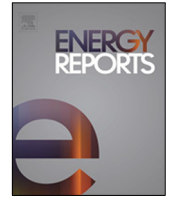

Research paper

GA-based optimization for integration of DGs, STATCOM and PHEVs in distribution systems

Bindeshwar Singh*, Swati Singh

Kamla Nehru Institute of Technology, Sultanpur 228118, U.P., India

ARTICLE INFO

Article history:

Received 26 July 2018

Received in revised form 1 September 2018

Accepted 13 September 2018

Available online xxxx

Keywords:

Distributed Generations (DGs)

Location and size

Static Synchronous Compensator (STATCOM)

Plug-in-Hybrid Electric Vehicle (PHEVs)

Genetic Algorithms (GAs)

Distribution systems

ABSTRACT

This paper presents a Genetic Algorithms (GAs) for integration of various types of Distributed Generations (DGs), Static Synchronous Compensator (STATCOM) and Plug-in-Hybrid Electric Vehicle (PHEVs) with different static load models (DSLMS) such as LM-1, LM-2, LM-3, LM-4 and LM-5, respectively in distribution systems from minimization of total real power loss of the system viewpoint. In this analysis, the system power factor taken as power system performances in various cases such as without DGs, with various types of DGs, integration of DGs and STATCOM, integration of DGs, STATCOM and PHEVs in distribution system with DSLMS. The proposed methodology has been tested for IEEE-37 bus distribution test system. This research work is very much useful for researchers, scientific, industrial, academicians and practitioners for whose are working in the fields of integration of renewable energy sources, FACTS controllers and PHEVs in distribution systems with DSLMS from minimization of total real power loss of the system viewpoint. This research work also is useful for practical implementations of integration of renewable energy sources, FACTS controllers and PHEVs in distribution systems with DSLMS for enhancement of different power system performances from minimization of total real power loss of the system viewpoint.

© 2018 Published by Elsevier Ltd. This is an open access article under the CC BY-NC-ND license (<http://creativecommons.org/licenses/by-nc-nd/4.0/>).

1. Introduction

The open literature review is, strongly, focused on the need for the integration of DGs with the power system highlighting both technical as well as economical benefits arisen out of such venture. The impacts of DGs on power system are, mainly, oriented towards the enhancement of various power system operational indices. As the concept of DGs involves many technologies and their proper applications, different countries use different terms for the same like “embedded generation” or “dispersed generation” or “decentralized generation” or “distributed energy resources (DERs)”. According to Keane and O'malley (2005), Darabian and Jalilvand (2018), Keane et al. (2009), Zhang et al. (2008) and Senjyu et al. (2008), the definition of DGs goes like DGs is an electric power source connected directly to the distribution network or on the customer site. In Senjyu et al. (2008), DGs is defined as a generator with small capacity close to its load that is not part of a centralized generation system.

1.1. Literature review

GA and an improved Hereford ranch algorithm (variant of GA) are proposed by Kim et al. (1998) for optimal sizing and placement of DGs in distribution systems from different objective function viewpoints. GA is applied in Borges and Falcao (2006) to solve an optimal DG planning (ODGP) problem with reliability constraints in Ref. Borges and Falcao (2006). GA is used to solve an ODGP (Singh and Goswami, 2009; Shukla et al., 2010) that considers variable power concentrated load models, distributed loads and constant power concentrated loads. GA is employed to solve ODGP that maximizes the profit of the distribution network operator (DNO) by the way of optimal placement of DG (Singh and Goswami, 2010b). A GA methodology is implemented to optimally allocate renewable DG units in distribution network to maximize the worth of the connection to the local distribution company as well as the customers connected to the system (Shaaban et al., 2014). A value-based approach, taking into account the benefits and costs of DGs, is developed and solved by GA that computes the optimal number, type, location and size of DGs (Teng et al., 2007). GA based method allocates, simultaneously, DGs and remote controllable switches

* Corresponding author.

E-mail addresses: bindeshwar.singh2025@gmail.com (B. Singh), swatisingh5444@gmail.com (S. Singh).

Nomenclature

Abbreviation

DGs	Distribution generations
DSs	Distribution systems
DG1, DG2, DG3 and DG4	Various types of distributed generations, respectively
DSLIM	Different static load models
FACTS	Flexible alternating current transmission system
GAs	Genetic algorithms
LM-1, LM-2, LM-3, LM-4 and LM-5	Constant (CON), industrial (INS), residential (RES), commercial (COM), reference (REF) static load models, respectively
lg and ld	Lagging and leading operating power factors of DGs, respectively
PHEVs	Plug in hybrid electric vehicles
STATCOM	Static synchronous compensator
WODGs and WDGs	Without DGs and with DGs, respectively

Symbols

$P_C(p.u.)$ and $Q_C(p.u.)$	Real and reactive power delivered to the system by substation generator, respectively
$\cos \theta_{WODGs}$	System power factor without DGs
$P_{DG1}(p.u.)$, $P_{DG2}(p.u.)$ and $P_{DG4}(p.u.)$	Real power delivered/absorbed by DG1, DG2 and DG4, respectively
$\cos \theta_{WDGs}$	System power factors with DGs
$\cos \theta_{WDG1}$, $\cos \theta_{WDG2}$, $\cos \theta_{WDG3}$ and $\cos \theta_{WDG4}$	System power factor with DG1, DG2, DG3 and DG4, respectively
$Q_{DG2}(p.u.)$, $Q_{DG3}(p.u.)$ and $Q_{DG4}(p.u.)$	Reactive power delivered/absorbed by DG2, DG3 and DG4, respectively
Q_{STAT}	Reactive power delivered by STATCOM
$\cos \theta_{WDG1+STAT}$, $\cos \theta_{WDG2+STAT}$, $\cos \theta_{WDG3+STAT}$ and $\cos \theta_{WDG4+STAT}$	System power factor with various types of DGs (DG1, DG2, DG3 and DG4) and STATCOM, respectively
$S_{SYS_WODGs}(p.u.)$	System MVA intake of main substation without DGs
$P_{PHEVs}(p.u.)$	Real power delivered by PHEVs
$\cos \theta_{WDG1+STAT+PHEVs}$, $\cos \theta_{WDG2+STAT+PHEVs}$, $\cos \theta_{WDG3+STAT+PHEVs}$ and $\cos \theta_{WDG4+STAT+PHEVs}$	System power factor with integration of various types of DGs (DG1, DG2, DG3 and DG4), STATCOM and PHEVs, respectively
$S_{SYS_WDG1}(p.u.)$, $S_{SYS_WDG2}(p.u.)$, $S_{SYS_WDG3}(p.u.)$ and $S_{SYS_WDG4}(p.u.)$	Total MVA intake of main substation with DG1, DG2, DG3 and DG4, respectively
$S_{SYS_WDG1+STAT}(p.u.)$, $S_{SYS_WDG2+STAT}(p.u.)$, $S_{SYS_WDG3+STAT}(p.u.)$ and $S_{SYS_WDG4+STAT}(p.u.)$	Total MVA intake of main substation with various types of DGs (DG1, DG2, DG3 and DG4) and STATCOM, respectively
$S_{SYS_WDG1+STAT+PHEVs}(p.u.)$, $S_{SYS_WDG2+STAT+PHEVs}(p.u.)$, $S_{SYS_WDG3+STAT+PHEVs}(p.u.)$ and $S_{SYS_WDG4+STAT+PHEVs}(p.u.)$	Total MVA intake of main substation with various types of DGs (DG1, DG2, DG3 and DG4), STATCOM and PHEVs, respectively
LOC_{DG}	Location of DGs
$S_{system}(p.u.)$	Total MVA of system
SPFs	System power factors
$V_{max}(p.u.)$	Maximum value of bus voltage (1.03)
$V_{min}(p.u.)$	Minimum value of bus voltage (0.95)
T_1 , T_2 , T_3 and T_4	Various types of DGs such as DG-1, DG-2, DG-3 and DG-4, respectively
α , β	Real and reactive power exponent values, respectively
f	Supply frequency (50 Hz)

in the distribution networks (Raooft, 2011). The Chu–Beasley GA solves a nonlinear bi-level ODGP problem that maximizes the profits of DGs owner subject to the minimization of payments procured by the DNO (López et al., 2012). Goal programming transforms a multi-objective ODGP into a single objective one which is solved by GA in Ref. Vinothkumar and Selvan (2012). GA and decision theory are applied to solve an ODGP problem under uncertainty including power quality issues (Caprinelli et al., 2003). GA and optimal power flow are combined to solve the ODGP in Ref. Harrison et al. (2008). A fuzzy based GA is used in an ODGP model (Kim et al., 2002) that minimizes the real power loss cost taken as objective function. A fuzzy embedded GA is employed to solve weighted multi-objective ODGP model (Akorede et al., 2011; Vinothkumar and Selvan, 2011). A hybrid GA and fuzzy logic

based goal programming ODGP is proposed by Kim et al. (2008). A combined GA and Tabu Search were suggested by Gandomkar et al. (2005). A hybrid immune GA algorithm is used in Ref. Soroudi and Ehsan (2011) to solve an ODGP that maximizes the profit of the DNO. GA is used by Ela et al. (2010) to solve a weighted multi-objective ODGP model. Multi-objective ODGP is formulated and solved by employing GA in Refs. Singh et al. (2016b), Singh et al. (2007) and Singh et al. (2016a).

The four broad categories of DGs on the basis of real and reactive delivered/absorbed to the systems are as explained in Refs. Singh et al. (2016b), Singh et al. (2007), Singh et al. (2016a), Singh et al. (2009), Bansal (2017), Singh et al. (2017), Morteza and Shakarami (2018), Ibrahim et al. (2018) and Xinkai et al. (2018).

Morteza and Shakarami (2018), presented an analytical and probabilistic method to determine wind DGs penetration for distribution networks based on time-dependent loads. Ibrahim et al. (2018), suggested a comprehensive battery energy storage optimal sizing model for micro-grid applications. Xinkai et al. (2018), discussed the coordinated control of DC grid and offshore wind farms to improve rotor-angle stability.

The custom power devices such as Static Var Compensator (SVC), STATCOM, distributed-STATCOM, dynamic voltage restorer (DVR), unified power quality conditioner (UPQC), unified dynamic quality conditioner (UDQC), hybrid power flow controller (HPFC), generalized unified power flow controller (GUPFC) etc. are useful for enhancement of power quality parameters point of view (Singh et al., 2015).

STATCOM is based on a power electronics voltage-source converter and can act as either a source or sink of reactive alternating current power to an electricity network. If connected to a source of power it can also provide active alternating current power. Usually a STATCOM is installed to support electricity networks that have a poor power factor and often poor voltage regulation. The most common use is for voltage stability (Singh et al., 2015).

PHEVs are a hybrid electric vehicle whose battery can be recharged by plugging it in to an external source of electric power as well by its on-board engine and generator. PHEVs have the potential to reduce fossil fuel use, decrease pollution, and allow renewable energy sources for transportation, but their lithium ion battery subsystems are presently too expensive (Luo et al., 2013). PHEVs configurations are classified in two basic categories such as series and parallel or blended PHEVs (Luo et al., 2013; ElNozahy and Salama, 2015; Roy et al., 2014; Amjadi and Williamson, 2014; Shojaabadi et al., 2016; Mohsen et al., 2018; Kang et al., 2017; Han et al., 2008; Hossain et al., 2012; Li et al., 2017; Tahboub et al., 2018; Darabian and Jalilv, 2018; Liu et al., 2018). The series PHEVs (Luo et al., 2013; ElNozahy and Salama, 2015) also called Extended Range Electric Vehicles (EREVs). Only the electric motor turns the wheels; the gasoline engine only generates electricity. The series PHEVs can run solely on electricity until the battery needs recharging. The gasoline engine will then generate the electricity needed to power the electric motor. For shorter trips, these vehicles might use no gasoline at all. The parallel or blended PHEVs (Roy et al., 2014) both the engine and electric motor are mechanically connected to the wheels and both propel the vehicle under most driving conditions. Electric-only operation usually occurs only at low speeds. The benefits and challenges of PHEVs are as follows: minimum petroleum required for operations of PHEVs (Amjadi and Williamson, 2014), minimum greenhouse gas (GHG) emissions by PHEVs (Mohsen et al., 2018; Kang et al., 2017; Han et al., 2008; Hossain et al., 2012), higher PHEVs costs but lower fuel costs for PHEVs operations (Li et al., 2017; Tahboub et al., 2018), PHEVs charging take time (Darabian and Jalilv, 2018) and PHEVs measuring fuel economy (Liu et al., 2018).

Daud et al. (2016), presented a comparison of heuristic optimization techniques for optimal placement and sizing of photovoltaic based distributed generation in a distribution system. Chaurasia et al. (2017), suggested a meta-heuristic firefly algorithm based smart control strategy and analysis of a grid connected hybrid photovoltaic/wind distributed generation system. Babacan et al. (2017), presented a novel techniques for siting and sizing of distributed energy storage to mitigate voltage impact by solar PV in distribution systems. Parvez et al. (2016), suggested a current control techniques for three-phase grid interconnection of renewable power generation systems: A review. Mohammadi et al. (2012), addressed an optimization of hybrid solar energy sources/wind turbine systems integrated to utility grids as micro-grid (MG) under pool/bilateral/hybrid electricity market using PSO. Wafa et al. (2018), presented the modeling and optimization of a solar system based on concentrating photovoltaic/thermal collector.

Ali et al. (2016), presented ant lion optimization algorithm for renewable distributed generations. Abd-Elazim and Ali (2016), suggested the imperialist competitive algorithm for optimal STATCOM design in a multi-machine power system. Shahrzad et al. (2017), suggested a grasshopper optimization algorithm: Theory and application. Seyedali and Andrew (2016), addressed the whale optimization algorithm for different engineering problems. Seyedali and Andrew (2014), suggested a novel approach such as grey wolf optimizer for different engineering problems. Seyedali et al. (2017), suggested the salp swarm algorithm: A bio-inspired optimizer for engineering design problems. Maziar and Fariborz (2016) addressed the lion optimization algorithm (LOA): A nature-inspired meta-heuristic algorithm for engineering applications.

1.2. Motivation of the present work

Refs. Keane and O'malley (2005), Darabian and Jalilvand (2018), Keane et al. (2009), Zhang et al. (2008), Senjyu et al. (2008), Kim et al. (1998), Borges and Falcao (2006), Singh and Goswami (2009), Shukla et al. (2010), Singh and Goswami (2010b), Shaaban et al. (2014), Teng et al. (2007), Raoufat (2011), López et al. (2012), Vinothkumar and Selvan (2012), Caprinelli et al. (2003), Harrison et al. (2008), Kim et al. (2002), Akorede et al. (2011), Vinothkumar and Selvan (2011), Kim et al. (2008), Gandomkar et al. (2005), Soroudi and Ehsan (2011), Ela et al. (2010), Celli et al. (2005b), Caprinelli et al. (2005), Singh and Goswami (2011), Gallego et al. (2001), Lee and Park (2009), Carvalho et al. (2008), Singh and Sharma (2017), Singh et al. (2016b), Singh et al. (2007), Singh et al. (2016a), Akorede et al. (2011a), Singh et al. (2015), Chiradeja and Ramakumar (2004), Singh et al. (2009), IEEE (2010), Al Abri et al. (2013), Varma et al. (2009), Bahram et al. (2016), Arash and Moradi (2015), Othman et al. (2015), Gregorio et al. (2015), Celli et al. (2005a), Singh and Goswami (2010a), Ackermann et al. (2001), Hegazy et al. (2003), Injeti and Kumar (2013), Sheng et al. (2015), Singh et al. (2010), Ochoa et al. (2006), Hong and Ho (2005), Luo et al. (2013), ElNozahy and Salama (2015), Roy et al. (2014), Amjadi and Williamson (2014), Shojaabadi et al. (2016), Mohsen et al. (2018), Kang et al. (2017), Han et al. (2008), Hossain et al. (2012), Li et al. (2017), Tahboub et al. (2018), Darabian and Jalilv (2018), Liu et al. (2018), Bansal (2017), Singh et al. (2017), Morteza and Shakarami (2018), Ibrahim et al. (2018), Xinkai et al. (2018), Daud et al. (2016), Chaurasia et al. (2017), Babacan et al. (2017), Parvez et al. (2016), Mohammadi et al. (2012), Wafa et al. (2018), Ali et al. (2016), Abd-Elazim and Ali (2016), Shahrzad et al. (2017), Seyedali and Andrew (2016), Seyedali and Andrew (2014), Seyedali et al. (2017) and Maziar and Fariborz (2016), discussed about the impact assessment of distribution power system performance such as system power factor with single type of DG having different loading conditions such as static load models by applying different novel approaches such as GA in Senjyu et al. (2008), Kim et al. (1998), Borges and Falcao (2006), Singh and Goswami (2009), Shukla et al. (2010), Singh and Goswami (2010b), Shaaban et al. (2014), Teng et al. (2007), Raoufat (2011), López et al. (2012), Vinothkumar and Selvan (2012), Caprinelli et al. (2003), Harrison et al. (2008), Kim et al. (2002), Akorede et al. (2011), Vinothkumar and Selvan (2011), Kim et al. (2008), Gandomkar et al. (2005), Soroudi and Ehsan (2011), Ela et al. (2010), Celli et al. (2005b), Caprinelli et al. (2005), Singh and Goswami (2011) and Gallego et al. (2001) and exhaustive search approach such as deterministic approach in Gallego et al. (2001). Literature review reveals that the investigation of the distribution power system performance such as system power factor having integration of different types of DGs (such as T_1 , T_2 , T_3 and T_4) with DLMs and FACTS controller like STATCOM has not been used in the open literature.

1.3. Contribution of paper

Literature review reveals that the investigation of the power system performances of distribution power systems having integration of different types of DGs (such as DG1, DG2, DG3 and DG4), STATCOM and PHEVs in distribution system with DLMs has not been used in the open literatures (Keane and O'malley, 2005; Darabian and Jalilvand, 2018; Keane et al., 2009; Zhang et al., 2008; Senjyu et al., 2008; Kim et al., 1998; Borges and Falcao, 2006; Singh and Goswami, 2009; Shukla et al., 2010; Singh and Goswami, 2010b; Shaaban et al., 2014; Teng et al., 2007; Raoofat, 2011; López et al., 2012; Vinothkumar and Selvan, 2012; Caprinelli et al., 2003; Harrison et al., 2008; Kim et al., 2002; Akorede et al., 2011; Vinothkumar and Selvan, 2011; Kim et al., 2008; Gandomkar et al., 2005; Soroudi and Ehsan, 2011; Ela et al., 2010; Celli et al., 2005b; Caprinelli et al., 2005; Singh and Goswami, 2011; Gallego et al., 2001; Lee and Park, 2009; Carvalho et al., 2008; Singh and Sharma, 2017; Singh et al., 2016b, 2007, 2016a; Akorede et al., 2011a; Singh et al., 2015; Chiradeja and Ramakumar, 2004; Singh et al., 2009; IEEE, 2010; Al Abri et al., 2013; Varma et al., 2009; Bahram et al., 2016; Arash and Moradi, 2015; Othman et al., 2015; Gregorio et al., 2015; Celli et al., 2005a; Singh and Goswami, 2010a; Ackermann et al., 2001; Hegazy et al., 2003; Injeti and Kumar, 2013; Sheng et al., 2015; Singh et al., 2010; Ochoa et al., 2006; Hong and Ho, 2005; Luo et al., 2013; ElNozahy and Salama, 2015; Roy et al., 2014; Amjadi and Williamson, 2014; Shojaabadi et al., 2016; Mohsen et al., 2018; Kang et al., 2017; Han et al., 2008; Hossain et al., 2012; Li et al., 2017; Tahboub et al., 2018; Darabian and Jalilv, 2018; Liu et al., 2018; Bansal, 2017; Singh et al., 2017; Morteza and Shakarami, 2018; Ibrahim et al., 2018; Xinkai et al., 2018; Daud et al., 2016; Chaurasia et al., 2017; Babacan et al., 2017; Parvez et al., 2016; Mohammadi et al., 2012; Wafa et al., 2018; Ali et al., 2016; Abd-Elazim and Ali, 2016; Shahrzad et al., 2017; Seyedali and Andrew, 2016, 2014; Seyedali et al., 2017; Maziar and Fariborz, 2016). To the best knowledge of the authors of the present work, this type of work is yet to be published. This paper considers integration of all possible types of DGs (such as DG1, DG2, DG3 and DG4), STATCOM and PHEVs in distribution system with DSLMs for impact assessment of distribution systems performances from minimum real power loss of the system viewpoint by using GA.

1.4. Organization of paper

The organization of the rest of the paper is as follows: The next Section discusses about the mathematical problem formulations of the present work. Section 3 discusses about the proposed algorithms. In Section 4, simulation results and discussions are focused. Finally, the conclusions of the paper and future research scopes are presented in Section 5.

2. Mathematical problem formulations

The different types of DGs and mathematical problem formulations are presented in Sections 2.1 and 2.2, subsequently.

2.1. Different types of DGs

(i) **DG-1 (termed as T_1):** This type of DGs is capable of delivering only the real power to the system such as photovoltaic, micro turbines, fuel cells, bio-gas, which are integrated to the main grid with the help of converters/inverters. However, according to current situation and grid codes, the photovoltaic can be (and in sometimes is) require to provide the reactive power as well so that only the real power is supplied at unity operating power factor (Singh et al., 2016b, 2007, 2016a, 2009; Bansal, 2017; Singh et al., 2017; Morteza and Shakarami, 2018; Ibrahim et al., 2018; Xinkai et al., 2018).

(ii) **DG-2 (termed as T_2):** This type of DGs is capable of delivering both the real and reactive power to the system. DG units based on diesel engines as diesel generators and synchronous machines (cogeneration and gas turbine etc.) come under this type of DGs. For it, both the real and reactive power are supplied at various operating power factors (e.g. 0.80–0.99 leading) (Singh et al., 2016b, 2007, 2016a, 2009; Bansal, 2017; Singh et al., 2017; Morteza and Shakarami, 2018; Ibrahim et al., 2018; Xinkai et al., 2018).

(iii) **DG-3 (termed as T_3):** This type of DGs is capable of delivering only the reactive power to the system. Synchronous compensators, capacitor bank, inductor bank, on-line tap changing transformers, FACTS controllers and gas turbines are examples of this type of DGs and operate at zero power factor. So, only the reactive power is supplied at zero operating power factors for this type of DGs (Singh et al., 2016b, 2007, 2016a, 2009; Bansal, 2017; Singh et al., 2017; Morteza and Shakarami, 2018; Ibrahim et al., 2018; Xinkai et al., 2018).

(iv) **DG-4 (termed as T_4):** This type of DGs is capable of delivering the real power to the systems but consumes the reactive power from the system. Mainly, induction generators which are used in wind farms come under this category. However, doubly fed induction generators (DFIG) may consume or produce reactive power i.e. operates similar to synchronous generators. Here, only the real power is supplied and the reactive power is drawn from the system at different operating power factors (e.g. 0.80–0.99 lagging) (Singh et al., 2016b, 2007, 2016a, 2009; Bansal, 2017; Singh et al., 2017; Morteza and Shakarami, 2018; Ibrahim et al., 2018; Xinkai et al., 2018).

2.2. Mathematical problem formulation

Total MVA intake of main substation without DGs, STATCOM and PHEVs can be expressed as Eq. (1):

$$S_{SYS_WODGs} = \sqrt{P_G^2 + Q_G^2} \quad (1)$$

Total MVA intake of main substation with various types of DGs (i.e. DG1, DG2, DG3 and DG4, respectively) are expressed as Eqs. (2)–(5):

$$S_{SYS_WDG1} = \sqrt{(P_G + P_{DG1})^2 + Q_G^2} \quad (2)$$

$$S_{SYS_WDG2} = \sqrt{(P_G + P_{DG2})^2 + (Q_G - Q_{DG2})^2} \quad (3)$$

$$S_{SYS_WDG3} = \sqrt{P_G^2 + (Q_G - Q_{DG3})^2} \quad (4)$$

$$S_{SYS_WDG4} = \sqrt{(P_G + P_{DG4})^2 + (Q_G + Q_{DG4})^2} \quad (5)$$

Total system MVA intake of main substation with integration of various types of DGs (DG1, DG2, DG3 and DG4, respectively) and STATCOM in distribution systems are expressed as Eqs. (6)–(9):

$$S_{SYS_WDG1+STAT} = \sqrt{(P_G + P_{DG1})^2 + (Q_G \pm Q_{STAT})^2} \quad (6)$$

$$S_{SYS_WDG2+STAT} = \sqrt{(P_G + P_{DG2})^2 + (Q_G - Q_{DG2} \pm Q_{STAT})^2} \quad (7)$$

$$S_{SYS_WDG3+STAT} = \sqrt{P_G^2 + (Q_G - Q_{DG3} \pm Q_{STAT})^2} \quad (8)$$

$$S_{SYS_WDG4+STAT} = \sqrt{(P_G + P_{DG4})^2 + (Q_G + Q_{DG4} \pm Q_{STAT})^2} \quad (9)$$

The system MVA intake powers of main substation with integration of various types of DGs (DG1, DG2, DG3 and DG4, respectively),

STATCOM and PHEVs in distribution systems are expressed as Eqs. (10)–(13):

$$S_{SYS_WDG1+STAT+PHEVs} = \sqrt{(P_G + P_{DG1} + P_{PHEVs})^2 + (Q_G \pm Q_{STAT})^2} \quad (10)$$

$$S_{SYS_WDG2+STAT+PHEVs} = \sqrt{(P_G + P_{DG2} + P_{PHEVs})^2 + (Q_G - Q_{DG2} \pm Q_{STAT})^2} \quad (11)$$

$$S_{SYS_WDG3+STAT+PHEVs} = \sqrt{(P_G + P_{PHEVs})^2 + (Q_G - Q_{DG3} \pm Q_{STAT})^2} \quad (12)$$

$$S_{SYS_WDG4+STAT+PHEVs} = \sqrt{(P_G + P_{DG4} + P_{PHEVs})^2 + (Q_G + Q_{DG4} \pm Q_{STAT})^2} \quad (13)$$

The *SPF* without various types of DGs (*i.e.* DG1, DG2, DG3 and DG4, respectively) can be expressed as Eq. (14):

$$\cos \theta_{WODGs} = \frac{P_G}{\sqrt{P_G^2 + Q_G^2}} \quad (14)$$

The *SPFs* with various types of DGs (*i.e.* DG1, DG2, DG3 and DG4, respectively) are expressed as Eqs. (15)–(18):

$$\cos \theta_{WDG1} = \frac{P_G + P_{DG1}}{\sqrt{(P_G + P_{DG1})^2 + Q_G^2}} \quad (15)$$

$$\cos \theta_{WDG2} = \frac{P_G + P_{DG2}}{\sqrt{(P_G + P_{DG2})^2 + (Q_G - Q_{DG2})^2}} \quad (16)$$

$$\cos \theta_{WDG3} = \frac{P_G}{\sqrt{P_G^2 + (Q_G - Q_{DG3})^2}} \quad (17)$$

$$\cos \theta_{WDG4} = \frac{P_G + P_{DG4}}{\sqrt{(P_G + P_{DG4})^2 + (Q_G + Q_{DG4})^2}} \quad (18)$$

The *SPFs* with integration of various types of DGs (DG1, DG2, DG3 and DG4, respectively) and STATCOM in distribution systems are expressed as Eqs. (19)–(22):

$$\cos \theta_{WDG1+STAT} = \frac{P_G + P_{DG1}}{\sqrt{(P_G + P_{DG1})^2 + (Q_G \pm Q_{STAT})^2}} \quad (19)$$

$$\cos \theta_{WDG2+STAT} = \frac{P_G + P_{DG2}}{\sqrt{(P_G + P_{DG2})^2 + (Q_G - Q_{DG2} \pm Q_{STAT})^2}} \quad (20)$$

$$\cos \theta_{WDG3+STAT} = \frac{P_G}{\sqrt{P_G^2 + (Q_G - Q_{DG3} \pm Q_{STAT})^2}} \quad (21)$$

$$\cos \theta_{WDG4+STAT} = \frac{P_G + P_{DG4}}{\sqrt{(P_G + P_{DG4})^2 + (Q_G + Q_{DG4} \pm Q_{STAT})^2}} \quad (22)$$

The *SPFs* with integration of various types of DGs (DG1, DG2, DG3 and DG4, respectively), STATCOM and PHEVs in distribution systems are expressed as Eqs. (23)–(26):

$$\cos \theta_{WDG1+STAT+PHEVs} = \frac{P_G + P_{DG1} + P_{PHEVs}}{\sqrt{(P_G + P_{DG1} + P_{PHEVs})^2 + (Q_G \pm Q_{STAT})^2}} \quad (23)$$

$$\cos \theta_{WDG2+STAT+PHEVs} = \frac{P_G + P_{DG2} + P_{PHEVs}}{\sqrt{(P_G + P_{DG2} + P_{PHEVs})^2 + (Q_G - Q_{DG2} \pm Q_{STAT})^2}} \quad (24)$$

$$\cos \theta_{WDG3+STAT+PHEVs} = \frac{P_G + P_{PHEVs}}{\sqrt{(P_G + P_{PHEVs})^2 + (Q_G - Q_{DG3} \pm Q_{STAT})^2}} \quad (25)$$

$$\cos \theta_{WDG4+STAT+PHEVs} = \frac{P_G + P_{DG4} + P_{PHEVs}}{\sqrt{(P_G + P_{DG4} + P_{PHEVs})^2 + (Q_G + Q_{DG4} \pm Q_{STAT})^2}} \quad (26)$$

The real and reactive power exponential values for DSLMs (Singh and Goswami, 2011; Singh et al., 2007) such as LM-1, LM-2, LM-3, LM-4 and LM-5, respectively are given in Table 1.

Table 1

The real and reactive power exponential values for DSLMs.

DSLMS	α	β
LM-1	0.00	0.00
LM-2	0.18	6.00
LM-3	0.92	4.04
LM-4	1.51	3.40
LM-5	0.91	1.00

3. Proposed algorithm

GA is one of the most popular types of evolutionary algorithms for engineering optimization problems. To be more precise, it constitutes a computing model for simulating natural and genetic selection that is related to the biological evolution described in Darwin's theory (Singh et al., 2015; Chiradeja and Ramakumar, 2004). In this computing model, a population of abstract representations (called as chromosomes) or the genome of candidate solutions (called as individuals to an optimization problem) could result in better solutions which are, traditionally, represented in binary form as strings comprises of 0s and 1s with fixed length. But other kinds of encoding are also possible which include real values and order chromosomes. The program then assigns proper number of bits and coding (Singh et al., 2009). Being a member of the evolutionary computation family, the first step in GA is population initialization which is, usually, done stochastically. Generally, GA uses three basic operators called as *selection*, *recombination* or *crossover* and *mutation* for engineering optimization problems (Singh et al., 2009). The GA flowchart for impact assessment of integration of DGs, STATCOM and PHEVs in distribution system with DSLMs (such as LM-1, LM-2, LM-3, LM-4 and LM-5 respectively) from minimization of total real power loss of the system viewpoint is shown in Fig. 1.

The various steps for GA based optimization for integration of DGs, STATCOM and PHEVs in distribution system with DSLMs from minimization of total real power loss of the system viewpoint

- [Read the data]:** Read the IEEE 37-bus distribution system data, different static load models data (*i.e.* LM-1, LM-2, LM-3, LM-4 and LM-5), and different types of DGs data (*i.e.* DG-1, DG-2, DG-3 and DG-4, respectively), STATCOM and PHEVs data.
- [Run load flow for base case (initial fitness solution)]:** Run load flow for base case (initial solution fitness) and calculate the *SPF* for base case. Registry the base case (initial fitness solution) characteristic.
- [Binary coding]:** Binary coding of the IEEE 37-bus distribution system data, different load models data (select one load model at a time *i.e.* LM-1, LM-2, LM-3, LM-4 and LM-5), and different types of DGs data (select one DGs at a time *i.e.* DG-1, DG-2, DG-3 and DG-4, respectively), STATCOM and PHEVs data.
- [Initialization]** Create the initial population and fitness function value: Generate the random population of n chromosomes (suitable solutions for the problem); randomly generate size-placement pairs of different types of DGs (*i.e.* select one DGs at a time *i.e.* DG-1, DG-2, DG-3 and DG-4, respectively) with DSLMs (*i.e.* select one load model at a time *i.e.* LM-1, LM-2, LM-3, LM-4 and LM-5) in a predefined range of size-placement of various types of DGs, STATCOM and PHEVs.
- [Fitness function value]** Evaluate the fitness function value [$f(x)$] of each size-placement of various types of DGs (chromosome), STATCOM (chromosome) and PHEVs (chromosome) x in the population: run load flow and calculate the

system power factor for each size–placement pairs under uniform loading condition. Record the *SPF* and its corresponding size–placement pairs.

6. [**New population**] Create a new population by repeating following steps until the new population is complete:
 - (a) [**Selection**] Select two parent chromosomes from a population according to their fitness (better the fitness, bigger is the chance to be selected).
 - (b) [**Crossover**] With a crossover probability the parents crossover to form a new offspring (children). If no crossover is performed, offspring would be an exact copy of parents.
 - (c) [**Mutation**] With a mutation probability method new offspring mutates (children) at each locus (position in chromosome).
 - (d) [**Accepting**] Place new offspring in a new population. It satisfies the constraints such as power flow conservation limits, distribution line thermal capacity limit and voltage deviation limit? Otherwise go to step 6.
7. [**Replacement**] Use new generated population for a further run of algorithm. Run load flow and calculate the new fitness solution for each size–placement pairs of different types of DGs, STATCOM and PHEVs (chromosome). Also calculate the corresponding system power factor. Compare new fitness solution with base case (initial fitness solution) characteristic
8. [**Test**] If one of the stopping criteria is satisfied then stop, and retain the best solution in current population.
9. [**Loop**] Use the new generated population size *i.e.* offspring and parents as new generation. It satisfies the objective function (OF) should be minimized? Otherwise, set generation $Gen = Gen + 1$. Go to step 6.

The flowchart for proposed methodology for GA based optimization for integration of DGs, STATCOM and PHEVs in distribution system with DSLMs from minimization of total real power loss of the system viewpoint is shown in Fig. 1.

4. Simulation results and discussions

The IEEE-37 bus distribution test system and data are given in Fig. 2 and Table 2.

4.1. Analysis of SPFs with various types of DGs with DSLMs

The analyses of *SPFs* with various types of DGs results are presented in this *sub-section* are as follows:

Table 3, shows that the *SPFs* profile with various types of DGs (*i.e.* DG1, DG2, DG3 and DG4, respectively) with DSLMs in distribution systems.

Fig. 3, shows that the *SPFs* having different values with integration of various types DGs (*i.e.* DG1, DG2, DG3 and DG4, respectively) with DSLMs (*i.e.* LM-1, LM-2, LM-3, LM-4 and LM-5, respectively) in distribution systems from minimization of total real power loss of the system point of view. The best *SPFs* with DSLMs are achieved in case of DG2 whereas the poorest *SPFs* with DSLMs are achieved in case DG3. The descending order of *SPFs* with DSLMs are as follows: $DG2 > DG1 > DG4 > DG3$.

4.2. Analysis of SPFs with integration of various types of DGs and STATCOM (as generating mode operation)

The analyses of *SPFs* with integration of various types of DGs and STATCOM (as generating mode operation) results are presented in this *sub-section* are as follows:

Table 2
IEEE-37 bus distribution test system data.

From	To	Line impedance in p. u.			Load on to node (p. u.)			
		R _{p.u.}	X _{p.u.}	L	S _L	P _L	Q _L	L _T
1	2	0.000574	0.000293	1	4.6	0.1	0.06	R
2	3	0.00307	0.001564	6	4.1	0.09	0.04	I
3	4	0.002279	0.001161	11	2.9	0.12	0.08	C
4	5	0.002373	0.001209	12	2.9	0.06	0.03	R
5	6	0.0051	0.004402	13	2.9	0.06	0.02	I
6	7	0.001166	0.003853	22	1.5	0.2	0.1	C
7	8	0.00443	0.001464	23	1.05	0.2	0.1	C
8	9	0.006413	0.004608	25	1.05	0.06	0.02	I
9	10	0.006501	0.004608	27	1.05	0.06	0.02	C
10	11	0.001224	0.000405	28	1.05	0.045	0.03	C
11	12	0.002331	0.000771	29	1.05	0.06	0.035	R
12	13	0.009141	0.007192	31	0.5	0.06	0.035	C
13	14	0.003372	0.004439	32	0.45	0.12	0.08	R
14	15	0.00368	0.003275	33	0.3	0.06	0.01	C
15	16	0.004647	0.003394	34	0.25	0.06	0.02	I
16	17	0.008026	0.010716	35	0.25	0.06	0.02	C
17	18	0.004558	0.003574	36	0.1	0.09	0.04	I
2	19	0.001021	0.000974	2	0.5	0.09	0.04	R
19	20	0.009366	0.00844	3	0.5	0.09	0.04	C
20	21	0.00255	0.002979	4	0.21	0.09	0.04	I
21	22	0.004414	0.005836	5	0.11	0.09	0.04	R
3	23	0.002809	0.00192	7	1.05	0.09	0.04	C
23	24	0.005592	0.004415	8	1.05	0.42	0.2	C
24	25	0.005579	0.004366	9	0.5	0.42	0.2	C
6	26	0.001264	0.000644	14	1.5	0.06	0.025	C
26	27	0.00177	0.000901	15	1.5	0.06	0.025	I
27	28	0.006594	0.005814	16	1.5	0.06	0.02	C
28	29	0.005007	0.004362	17	1.5	0.12	0.07	C
29	30	0.00316	0.00161	18	1.5	0.2	0.6	C
30	31	0.006067	0.005996	19	0.5	0.15	0.07	R
31	32	0.001933	0.002253	20	0.5	0.21	0.1	R
32	33	0.002123	0.003301	21	0.1	0.06	0.04	C
8	34	0.012453	0.012453	24	0.5	0	0	
9	35	0.012453	0.012453	26	0.5	0	0	
12	36	0.012453	0.012453	30	0.5	0	0	
18	37	0.003113	0.003113	37	0.5	0	0	
25	38	0.00313	0.003113	10	0.1	0	0	

L=Line number, S_L=Line MVA limit in p. u., P_L=Real MW load in p. u., Q_L=Reactive MVA load in p. u., L_T=Load type, R=Residential, I=Industrial, C=Commercial.

Table 4, shows that the *SPF* profiles with integration of various types of DGs (*i.e.* DG1, DG2, DG3 and DG4, respectively) and STATCOM (−0.30 p. u.) with DSLMs in distribution systems.

Fig. 4, shows that the *SPFs* profile having different values with integration of various types DGs (*i.e.* DG1, DG2, DG3 and DG4, respectively) and STATCOM (−0.30 p. u.) with DSLMs such as LM-1, LM-2, LM-3, LM-4 and LM-5 respectively in distribution systems from minimization of total real power loss of the system point of view. The best *SPFs* with DSLMs are achieved in case of DG2+STATCOM (−0.30 p. u.) whereas the poorest *SPFs* with DSLMs are achieved in case DG3+STATCOM (−0.30 p. u.). The descending orders of *SPFs* with DSLMs are as follows:

$$\begin{aligned}
 DG2 + STATCOM(-0.30 p.u.) &> DG1 + STATCOM(-0.30 p.u.) \\
 &> DG4 + STATCOM(-0.30 p.u.) \\
 &> DG3 + STATCOM(-0.30 p.u.)
 \end{aligned}$$

Table 5, shows that the *SPF* profiles with integration of various types of DGs (*i.e.* DG1, DG2, DG3 and DG4, respectively) and STATCOM (−0.40 p. u.) with DSLMs in distribution systems.

Fig. 5, shows that the *SPF* profiles having different values with integration of various types DGs (*i.e.* DG1, DG2, DG3 and DG4, respectively) with DSLMs (*i.e.* LM-1, LM-2, LM-3, LM-4 and LM-5, respectively) in distribution systems from minimization of total real power loss of the system point of view. The best *SPFs* with DSLMs are achieved in case of DG2 and STATCOM (−0.40 p. u.) whereas the poorest *SPFs* with DSLMs are achieved in case DG3 and

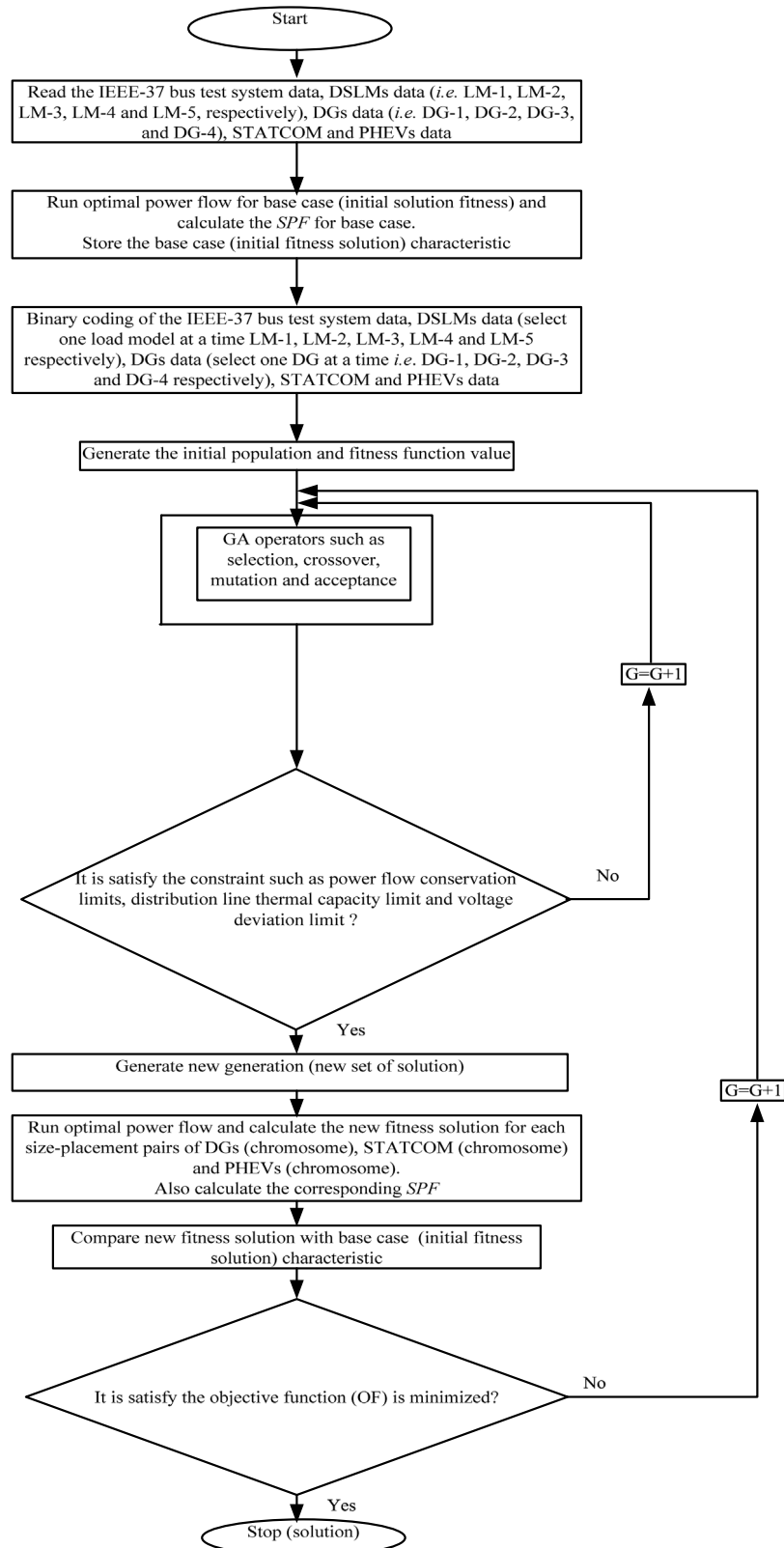

Fig. 1. The GA flowchart for integration of DGs, STATCOM and PHEVs in distribution system with DSLMs.

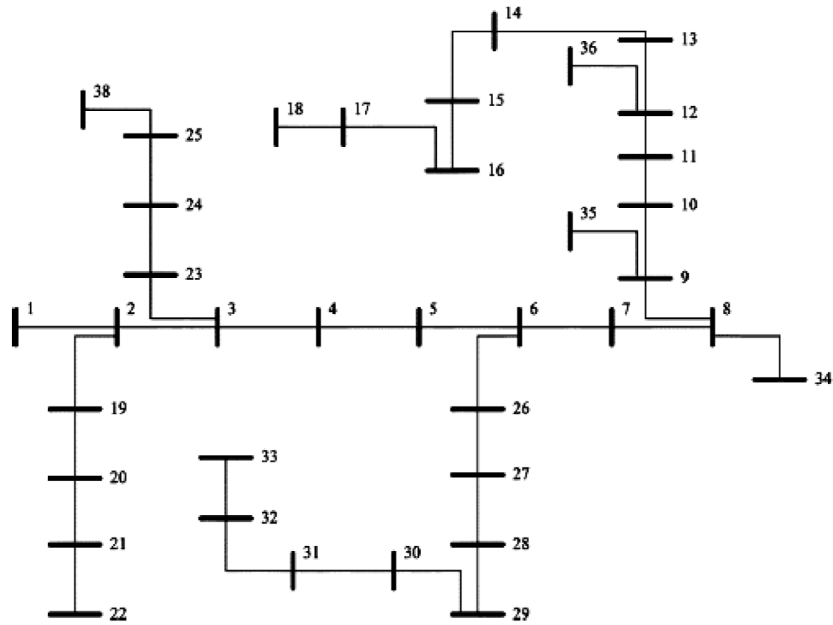

Fig. 2. Single-line diagram of IEEE-37 bus (38-node) distribution test system (Singh and Goswami, 2011; Singh et al., 2007; Singh and Goswami, 2010a).

SPF profiles with various types of DGs

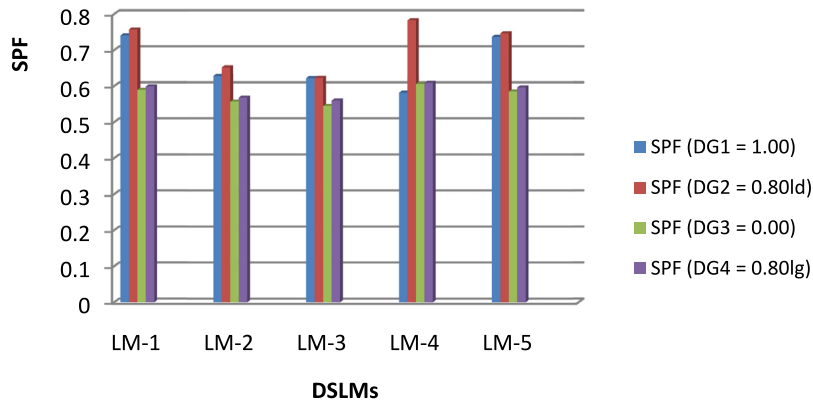

Fig. 3. SPF profiles with various types of DGs (i.e. DG1, DG2, DG3 and DG4, respectively) with DSLMs.

SPF Profiles with integration of various types of DGs and STATCOM (-0.30 p.u.)

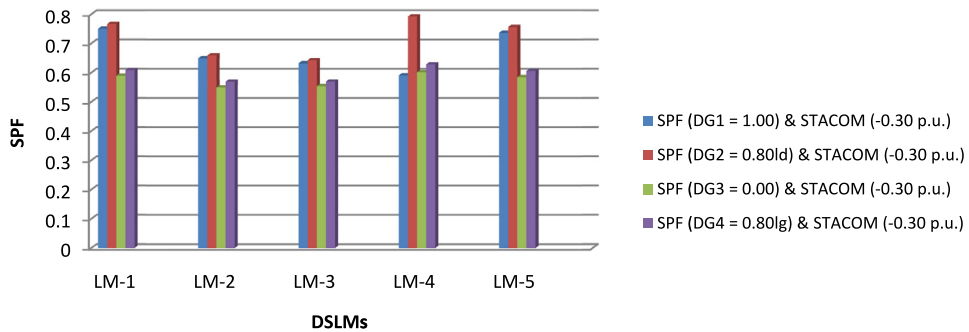

Fig. 4. SPF profiles with integration of various types of DGs (such as DG1, DG2, DG3 and DG4) and STATCOM (-0.30 p. u.) with DSLMs.

Table 3

SPF profiles with various types of DGs (i.e. DG1, DG2, DG3 and DG4, respectively) with DSLMs.

DSLMS	Cos θ_{WDG1} with DG1 (1.00)	Cos θ_{WDG2} with DG2 (0.80ld)	Cos θ_{WDG3} with DG3 (0.00)	Cos θ_{WDG4} with DG4 (0.80lg)
LM-1	0.7406 (0.1014; 2.0083; 6)	0.7569 (0.0924; 1.4018; 26)	0.5896 (0.1342; 1.2131; 30)	0.5988 (0.0924; 1.4018; 26)
LM-2	0.6283 (0.1098; 0.9324; 10)	0.6521 (0.1047; 0.6852; 30)	0.5568 (0.1316; 1.1189; 30)	0.5675 (0.1047; 0.6852; 30)
LM-3	0.6221 (0.1190; 0.6765; 13)	0.6228 (0.1179; 0.5334; 29)	0.5443 (0.1291; 1.1014; 30)	0.5596 (0.1179; 0.53334; 29)
LM-4	0.5813 (0.1340; 0.3631; 15)	0.7824 (0.1272; 1.5950; 24)	0.6058 (0.1313; 0.7391; 30)	0.6084 (0.1272; 1.5950; 24)
LM-5	0.7368 (0.1010; 1.8290; 7)	0.7465 (0.0900; 1.3266; 27)	0.5852 (0.1300; 1.1812; 30)	0.5959 (0.0900; 1.3266; 27)

Table 4

SPF profiles with integration of various types of DGs (i.e. DG1, DG2, DG3 and DG4, respectively) and STATCOM (−0.30 p. u.) with DSLMs.

DSLMS	Cos $\theta_{WDG1+STAT}$ with DG1 (1.00) +STATCOM (−0.30 p. u.)	Cos $\theta_{WDG2+STAT}$ with DG2 (0.80ld) +STATCOM (−0.30 p. u.)	Cos $\theta_{WDG3+STAT}$ with DG3 (0.00) +STATCOM (−0.30 p. u.)	Cos $\theta_{WDG4+STAT}$ with DG4 (0.80lg) +STATCOM (−0.30 p. u.)
LM-1	0.7506 (0.1014; 2.0083; 6)	0.7669 (0.0924; 1.4018; 26)	0.5896 (0.1342; 1.2131; 30)	0.6088 (0.0924; 1.4018; 26)
LM-2	0.6493 (0.1098; 0.9324; 10)	0.6591 (0.1047; 0.6852; 30)	0.5498 (0.1316; 1.1189; 30)	0.5695 (0.1047; 0.6852; 30)
LM-3	0.6321 (0.1190; 0.6765; 13)	0.6428 (0.1179; 0.5334; 29)	0.5543 (0.1291; 1.1014; 30)	0.5696 (0.1179; 0.53334; 29)
LM-4	0.5913 (0.1340; 0.3631; 15)	0.7924 (0.1272; 1.5950; 24)	0.6018 (0.1313; 0.7391; 30)	0.6284 (0.1272; 1.5950; 24)
LM-5	0.7368 (0.1010; 1.8290; 7)	0.7565 (0.0900; 1.3266; 27)	0.5852 (0.1300; 1.1812; 30)	0.6059 (0.0900; 1.3266; 27)

Table 5

SPF profiles with integration of various types of DGs (i.e. DG1, DG2, DG3 and DG4, respectively) and STATCOM (−0.40 p. u.) with DSLMs.

DSLMS	Cos $\theta_{WDG1+STAT}$ with DG1 (1.00) +STATCOM (−0.40 p. u.)	Cos $\theta_{WDG2+STAT}$ with DG2 (0.80ld) +STATCOM (−0.40 p. u.)	Cos $\theta_{WDG3+STAT}$ with DG3 (0.00) +STATCOM (−0.40 p. u.)	Cos $\theta_{WDG4+STAT}$ with DG4 (0.80lg) +STATCOM (−0.40 p. u.)
LM-1	0.7596 (0.1014; 2.0083; 6)	0.7769 (0.0924; 1.4018; 26)	0.5996 (0.1342; 1.2131; 30)	0.6188 (0.0924; 1.4018; 26)
LM-2	0.6483 (0.1098; 0.9324; 10)	0.6621 (0.1047; 0.6852; 30)	0.5568 (0.1316; 1.1189; 30)	0.5775 (0.1047; 0.6852; 30)
LM-3	0.6321 (0.1190; 0.6765; 13)	0.6498 (0.1179; 0.5334; 29)	0.5443 (0.1291; 1.1014; 30)	0.5796 (0.1179; 0.53334; 29)
LM-4	0.5993 (0.1340; 0.3631; 15)	0.7994 (0.1272; 1.5950; 24)	0.6048 (0.1313; 0.7391; 30)	0.6294 (0.1272; 1.5950; 24)
LM-5	0.7468 (0.1010; 1.8290; 7)	0.7665 (0.0900; 1.3266; 27)	0.6052 (0.1300; 1.1812; 30)	0.6159 (0.0900; 1.3266; 27)

SPF profiles with integration of various types of DGs and STATCOM (−0.40 p.u.)**Fig. 5.** SPF with integration of various types of DGs (i.e. DG1, DG2, DG3 and DG4, respectively) and STATCOM (−0.40 p. u.) with DSLMs.

Table 6
SPF with integration of various types of DGs (i.e. DG1, DG2, DG3 and DG4, respectively) and STATCOM (−0.50 p. u.)

DSLMS	Cos $\theta_{WDG1+STAT}$ with DG1 (1.00) +STATCOM (−0.50 p.u.)	Cos $\theta_{WDG2+STAT}$ with DG2 (0.80ld) +STATCOM (−0.50 p.u.)	Cos $\theta_{WDG3+STAT}$ with DG3 (0.00) +STATCOM (−0.50 p.u.)	Cos $\theta_{WDG4+STAT}$ with DG4 (0.80lg) +STATCOM (−0.50 p.u.)
LM-1	0.7706 (0.1014; 2.0083; 6)	0.7769 (0.0924; 1.4018; 26)	0.6126 (0.1342; 1.2131; 30)	0.6228 (0.0924; 1.4018; 26)
LM-2	0.6683 (0.1098; 0.9324; 10)	0.6691 (0.1047; 0.6852; 30)	0.5768 (0.1316; 1.1189; 30)	0.5795 (0.1047; 0.6852; 30)
LM-3	0.6491 (0.1190; 0.6765; 13)	0.6528 (0.1179; 0.5334; 29)	0.5743 (0.1291; 1.1014; 30)	0.5896 (0.1179; 0.53334; 29)
LM-4	0.6013 (0.1340; 0.3631; 15)	0.8024 (0.1272; 1.5950; 24)	0.6138 (0.1313; 0.7391; 30)	0.6284 (0.1272; 1.5950; 24)
LM-5	0.7598 (0.1010; 1.8290; 7)	0.7765 (0.0900; 1.3266; 27)	0.6152 (0.1300; 1.1812; 30)	0.6239 (0.0900; 1.3266; 27)

SPF profiles with integration of various types of DGs and STATCOM (−0.50 p.u.)

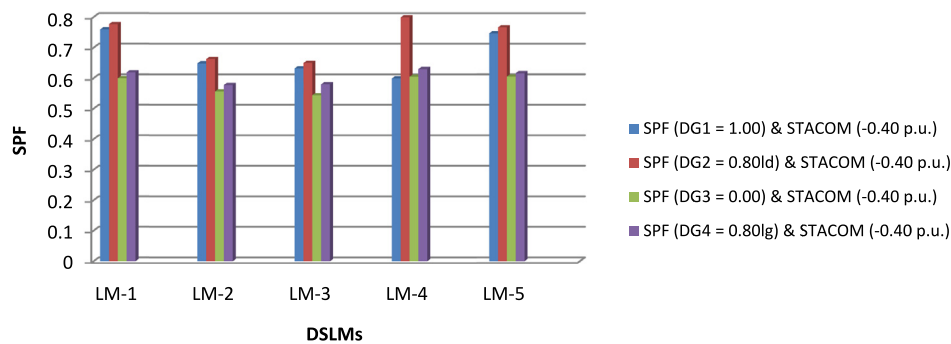
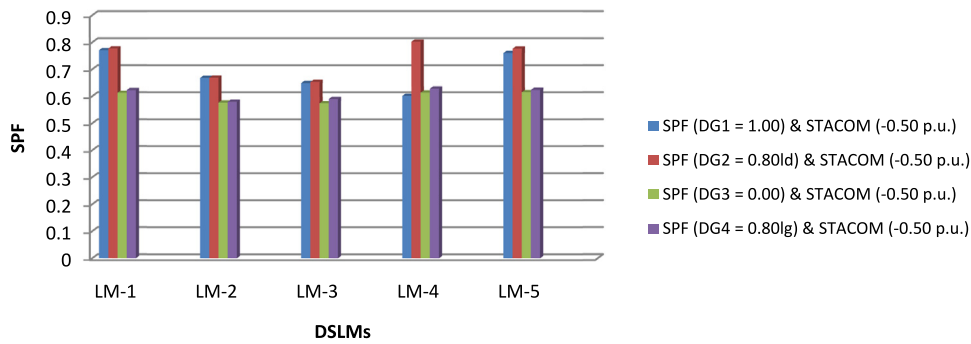

Fig. 6. SPF profiles with integration of various types of DGs (such as DG1, DG2, DG3 and DG4) and STATCOM (−0.50 p. u.) with DSLMs.

STATCOM (−0.40 p. u.). The descending orders of *SPFs* with DSLMs are as follows:

$$\begin{aligned}
 DG2 + STATCOM(-0.40 p.u.) &> DG1 + STATCOM(-0.40 p.u.) \\
 &> DG4 + STATCOM(-0.40 p.u.) \\
 &> DG3 + STATCOM(-0.40 p.u.)
 \end{aligned}$$

Table 6, shows that the *SPF* profiles with integration of various types of DGs (i.e. DG1, DG2, DG3 and DG4) and STATCOM (−0.50 p. u.) with DSLMs in distribution systems.

Fig. 6, shows that the *SPF* having different values with integration of various types DGs (i.e. DG1, DG2, DG3 and DG4, respectively) with DSLMs (i.e. LM-1, LM-2, LM-3, LM-4 and LM-5, respectively) in distribution systems from minimization of total real power loss of the system point of view. The best *SPFs* with DSLMs are achieved in case of DG2 and STATCOM (−0.50 p. u.) whereas the poorest *SPFs* with DSLMs are achieved in case DG3 and STATCOM (−0.50 p. u.). The descending orders of *SPFs* with DSLMs are as follows:

$$\begin{aligned}
 DG2 + STATCOM(-0.50 p.u.) &> DG1 + STATCOM(-0.50 p.u.) \\
 &> DG4 + STATCOM(-0.50 p.u.) \\
 &> DG3 + STATCOM(-0.50 p.u.)
 \end{aligned}$$

4.3. Analysis of *SPF* with integration of various types of DGs and STATCOM (as load mode operation)

The analyses of *SPF* with integration of various types of DGs and STATCOM (as load mode operation) results are presented in this sub-section as follows:

Table 7, shows that the *SPF* profiles with integration of various types of DGs (i.e. DG1, DG2, DG3 and DG4, respectively) and STATCOM (+0.30 p. u.) with DSLMs in distribution systems.

Fig. 7, shows that *SPF* profiles having different values with integration of various types DGs (i.e. DG1, DG2, DG3 and DG4, respectively) and STATCOM (+0.30 p. u.) with DSLMs (i.e. LM-1, LM-2, LM-3, LM-4 and LM-5, respectively) in distribution systems from minimization of total real power loss of the system point of view. The best *SPFs* with DSLMs are achieved in case of integration of DG2 and STATCOM (+0.30 p. u.) whereas the poorest *SPFs* with DSLMs are achieved in case integration of DG3 and STATCOM (+0.30 p. u.). The descending orders of *SPFs* with DSLMs are as follows:

$$\begin{aligned}
 DG2 + STATCOM(+0.30 p.u.) &> DG1 + STATCOM(+0.30 p.u.) \\
 &> DG4 + STATCOM(+0.30 p.u.) \\
 &> DG3 + STATCOM(+0.30 p.u.)
 \end{aligned}$$

Table 8, shows that the *SPF* profile with integration of various types of DGs (i.e. DG1, DG2, DG3 and DG4, respectively) and STATCOM (+0.40 p. u.) with DSLMs in distribution systems.

Fig. 8, shows that *SPFs* having different values with integration of various types DGs (DG1, DG2, DG3 and DG4) and STATCOM (+0.40 p. u.) with DSLMs such as LM-1, LM-2, LM-3, LM-4 and LM-5 respectively in distribution systems from minimization of total real power loss of the system point of view. The best *SPFs* with DSLMs are achieved in case of integration of DG2 and STATCOM (+0.40 p. u.) whereas the poorest *SPFs* with DSLMs are achieved in case integration of DG3 and STATCOM (+0.40 p. u.). The descending orders of *SPFs* with DSLMs are as follows:

$$\begin{aligned}
 DG2 + STATCOM(+0.40 p.u.) &> DG1 + STATCOM(+0.40 p.u.) \\
 &> DG4 + STATCOM(+0.40 p.u.) \\
 &> DG3 + STATCOM(+0.40 p.u.)
 \end{aligned}$$

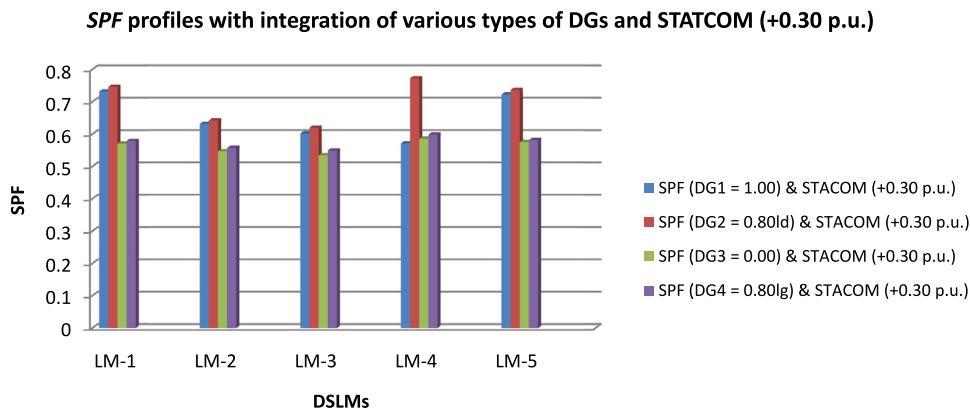

Fig. 7. SPF profile with integration of various types of DGs (i.e. DG1, DG2, DG3 and DG4, respectively) and STATCOM (+0.30 p. u.) with DSLMs.

Table 7

SPF with integration of various types of DGs (i.e. DG1, DG2, DG3 and DG4, respectively) and STATCOM (+0.30 p. u.) with DSLMs.

DSLMS	Cos $\theta_{WDG1+STAT}$ with DG1 (1.00) +STATCOM (+0.30 p. u.)	Cos $\theta_{WDG2+STAT}$ with DG2 (0.80ld) +STATCOM (+0.30 p. u.)	Cos $\theta_{WDG3+STAT}$ with DG3 (0.00) +STATCOM (+0.30 p. u.)	Cos $\theta_{WDG4+STAT}$ with DG4 (0.80lg) +STATCOM (+0.30 p. u.)
LM-1	0.7316 (0.1014; 2.0083; 6)	0.7459 (0.0924; 1.4018; 26)	0.5706 (0.1342; 1.2131; 30)	0.5788 (0.0924; 1.4018; 26)
LM-2	0.6313 (0.1098; 0.9324; 10)	0.6421 (0.1047; 0.6852; 30)	0.5468 (0.1316; 1.1189; 30)	0.5575 (0.1047; 0.6852; 30)
LM-3	0.6021 (0.1190; 0.6765; 13)	0.6198 (0.1179; 0.5334; 29)	0.5343 (0.1291; 1.1014; 30)	0.5496 (0.1179; 0.53334; 29)
LM-4	0.5713 (0.1340; 0.3631; 15)	0.7724 (0.1272; 1.5950; 24)	0.5858 (0.1313; 0.7391; 30)	0.5984 (0.1272; 1.5950; 24)
LM-5	0.7228 (0.1010; 1.8290; 7)	0.7365 (0.0900; 1.3266; 27)	0.5752 (0.1300; 1.1812; 30)	0.5819 (0.0900; 1.3266; 27)

Table 8

SPF profiles with integration of various types of DGs (i.e. DG1, DG2, DG3 and DG4, respectively) and STATCOM (+0.40 p. u.) with DSLMs.

DSLMS	Cos $\theta_{WDG1+STAT}$ with DG1 (1.00) +STATCOM (+0.40 p. u.)	Cos $\theta_{WDG2+STAT}$ with DG2 (0.80ld) +STATCOM (+0.40 p. u.)	Cos $\theta_{WDG3+STAT}$ with DG3 (0.00) +STATCOM (+0.40 p. u.)	Cos $\theta_{WDG4+STAT}$ with DG4 (0.80lg) +STATCOM (+0.40 p. u.)
LM-1	0.7206 (0.1014; 2.0083; 6)	0.7349 (0.0924; 1.4018; 26)	0.5596 (0.1342; 1.2131; 30)	0.5648 (0.0924; 1.4018; 26)
LM-2	0.6243 (0.1098; 0.9324; 10)	0.6341 (0.1047; 0.6852; 30)	0.5378 (0.1316; 1.1189; 30)	0.5445 (0.1047; 0.6852; 30)
LM-3	0.6011 (0.1190; 0.6765; 13)	0.6198 (0.1179; 0.5334; 29)	0.5293 (0.1291; 1.1014; 30)	0.5336 (0.1179; 0.53334; 29)
LM-4	0.5923 (0.1340; 0.3631; 15)	0.7614 (0.1272; 1.5950; 24)	0.5718 (0.1313; 0.7391; 30)	0.5854 (0.1272; 1.5950; 24)
LM-5	0.7178 (0.1010; 1.8290; 7)	0.7295 (0.0900; 1.3266; 27)	0.5692 (0.1300; 1.1812; 30)	0.5759 (0.0900; 1.3266; 27)

Table 9, shows that the SPF profile with integration of various types of DGs (i.e. DG1, DG2, DG3 and DG4, respectively) and STATCOM (+0.50 p. u.) with DSLMs in distribution systems.

Fig. 9, shows that the SPFs having different values with integration of various types DGs (i.e. DG1, DG2, DG3 and DG4, respectively) and STATCOM (+0.50 p. u.) with DSLMs (i.e. LM-1, LM-2, LM-3, LM-4 and LM-5 respectively) in distribution systems from minimization of total real power loss of the system point of view. The best SPFs with DSLMs are achieved in case of integration of DG2 and STATCOM (+0.50 p. u.) whereas the poorest SPFs with DSLMs are achieved in case DG3 and STATCOM (+0.50 p. u.). The descending orders of SPFs with DSLMs are as follows:

$$DG2 + STATCOM(+0.50 p.u.) > DG1 + STATCOM(+0.50 p.u.) > DG4 + STATCOM(+0.50 p.u.)$$

$$> DG3 + STATCOM(+0.50 p.u.)$$

4.4. Analysis of SPF with integration of various types of DGs, STATCOM (as generating mode operation) and PHEVs

The analysis of SPFs with integration of various types of DGs, STATCOM (as generating mode operation) and PHEVs results are presented in this sub-section are as follows:

Table 10, shows that the SPF profile with integration of various types of DGs (i.e. DG1, DG2, DG3 and DG4, respectively), STATCOM (−0.30 p. u.) and PHEVs (−0.10 p. u.) with DSLMs in distribution systems.

Fig. 10, shows that SPFs having different values with integration of various types DGs (i.e. DG1, DG2, DG3 and DG4, respectively), STATCOM (−0.30 p. u.) and PHEVs (−0.10 p. u.) with DSLMs (i.e.

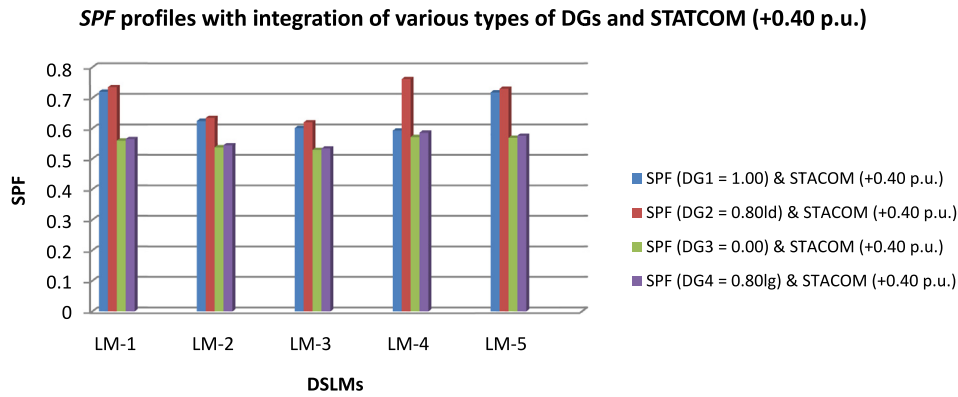

Fig. 8. SPF profiles with integration of various types of DGs (such as DG1, DG2, DG3 and DG4) and STATCOM (+0.40 p. u.) with DSLMs.

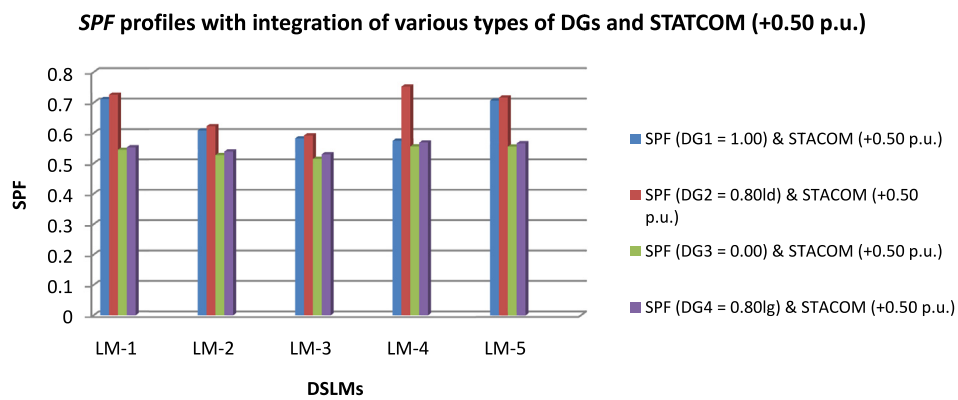

Fig. 9. SPF profiles with integration of various types of DGs (i.e. DG1, DG2, DG3 and DG4, respectively) and STATCOM (+0.50 p. u.) with DSLMs.

Table 9
SPF profiles with integration of various types of DGs (i.e. DG1, DG2, DG3 and DG4, respectively) and STATCOM (+0.50 p. u.) with DSLMs.

DSLMS	Cos $\theta_{WDG1+STAT}$ with DG1 (1.00) +STATCOM (+0.50 p. u.)	Cos $\theta_{WDG2+STAT}$ with DG2 (0.80ld) +STATCOM (+0.50 p. u.)	Cos $\theta_{WDG3+STAT}$ with DG3 (0.00) +STATCOM (+0.50 p. u.)	Cos $\theta_{WDG4+STAT}$ with DG4 (0.80lg) +STATCOM (+0.50 p. u.)
LM-1	0.7116 (0.1014; 2.0083; 6)	0.7259 (0.0924; 1.4018; 26)	0.5446 (0.1342; 1.2131; 30)	0.5528 (0.0924; 1.4018; 26)
LM-2	0.6083 (0.1098; 0.9324; 10)	0.6221 (0.1047; 0.6852; 30)	0.5268 (0.1316; 1.1189; 30)	0.5385 (0.1047; 0.6852; 30)
LM-3	0.5821 (0.1190; 0.6765; 13)	0.5918 (0.1179; 0.5334; 29)	0.5143 (0.1291; 1.1014; 30)	0.5296 (0.1179; 0.53334; 29)
LM-4	0.5743 (0.1340; 0.3631; 15)	0.7524 (0.1272; 1.5950; 24)	0.5558 (0.1313; 0.7391; 30)	0.5684 (0.1272; 1.5950; 24)
LM-5	0.7068 (0.1010; 1.8290; 7)	0.7165 (0.0900; 1.3266; 27)	0.5552 (0.1300; 1.1812; 30)	0.5659 (0.0900; 1.3266; 27)

LM-1, LM-2, LM-3, LM-4 and LM-5, respectively) in distribution systems from minimization of total real power loss of the system point of view. The best SPFs with DSLMs are achieved in case of integration of DG2, STATCOM (−0.30 p. u.) and PHEVs (−0.10 p. u.) whereas the poorest SPFs with DSLMs are achieved in case of integration of DG3, STATCOM (−0.30 p. u.) and PHEVs (−0.10 p. u.) The descending orders of SPFs with DSLMs are as follows:

- $DG2 + STATCOM(-0.30 p.u.) + PHEVs(-0.10 p.u.)$
 > $DG1 + STATCOM(-0.30 p.u.) + PHEVs(-0.10 p.u.)$
 > $DG4 + STATCOM(-0.30 p.u.) + PHEVs(-0.10 p.u.)$
 > $DG3 + STATCOM(-0.30 p.u.) + PHEVs(-0.10 p.u.)$

Table 11, shows that the SPF profile with integration of various types of DGs (i.e. DG1, DG2, DG3 and DG4, respectively), STATCOM (−0.40 p. u.) and PHEVs (−0.10 p. u.) with DSLMs in distribution systems.

Fig. 11, shows that the SPFs having different values with integration of various types DGs (i.e. DG1, DG2, DG3 and DG4, respectively), STATCOM (−0.40 p. u.) and PHEVs (−0.10 p. u.) with DSLMs (i.e. LM-1, LM-2, LM-3, LM-4 and LM-5, respectively) in distribution systems from minimization of total real power loss of the system point of view. The best SPFs with DSLMs are achieved in case of integration of DG2, STATCOM (−0.40 p. u.) and PHEVs (−0.10 p. u.) whereas the poorest SPFs with DSLMs are achieved in

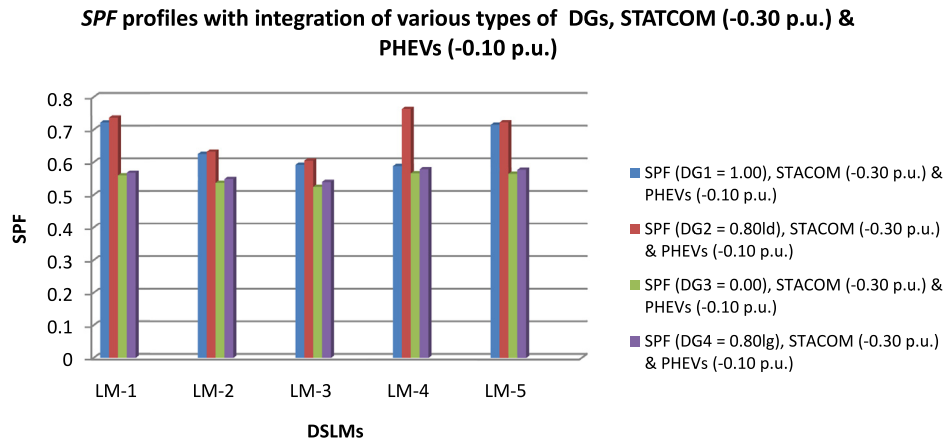

Fig. 10. SPF profiles with integration of various types of DGs (i.e. DG1, DG2, DG3 and DG4, respectively), STATCOM (-0.30 p. u.) and PHEVs (-0.10 p. u.) with DSLMs.

Table 10

SPF profiles with integration of various types of DGs (i.e. DG1, DG2, DG3 and DG4, respectively), STATCOM (-0.30 p.u.) and PHEVs (-0.10 p.u.) with DSLMs.

DSLMS	$\text{Cos } \theta_{WDG1+STAT}$ with DG1 (1.00) + STATCOM (-0.30 p. u.) + PHEVs (-0.10 p. u.)	$\text{Cos } \theta_{WDG2+STAT}$ with DG2 (0.80ld) + STATCOM (-0.30 p. u.) + PHEVs (-0.10 p. u.)	$\text{Cos } \theta_{WDG3+STAT}$ with DG3 (0.00) + STATCOM (-0.30 p. u.) + PHEVs (-0.10 p. u.)	$\text{Cos } \theta_{WDG4+STAT+PHEVs}$ with DG4 (0.80lg) + STATCOM (-0.30 p. u.) + PHEVs (-0.10 p. u.)
LM-1	0.7219 (0.1014; 2.0083; 6)	0.7369 (0.0924; 1.4018; 26)	0.5596 (0.1342; 1.2131; 30)	0.5678 (0.0924; 1.4018; 26)
LM-2	0.6253 (0.1098; 0.9324; 10)	0.6321 (0.1047; 0.6852; 30)	0.5368 (0.1316; 1.1189; 30)	0.5485 (0.1047; 0.6852; 30)
LM-3	0.5921 (0.1190; 0.6765; 13)	0.6048 (0.1179; 0.5334; 29)	0.5243 (0.1291; 1.1014; 30)	0.5396 (0.1179; 0.53334; 29)
LM-4	0.5883 (0.1340; 0.3631; 15)	0.7634 (0.1272; 1.5950; 24)	0.5658 (0.1313; 0.7391; 30)	0.5784 (0.1272; 1.5950; 24)
LM-5	0.7148 (0.1010; 1.8290; 7)	0.7225 (0.0900; 1.3266; 27)	0.5642 (0.1300; 1.1812; 30)	0.5767 (0.0900; 1.3266; 27)

Table 11

SPF profiles with integration of various types of DGs (such as DG1, DG2, DG3 and DG4), STATCOM (-0.40 p. u.) and PHEVs (-0.10 p. u.) with DSLMs.

DSLMS	$\text{Cos } \theta_{WDG1+STAT+PHEVs}$ with DG1 (1.00) + STATCOM (-0.40 p. u.) + PHEVs (-0.10 p. u.)	$\text{Cos } \theta_{WDG2+STAT+PHEVs}$ with DG2 (0.80ld) + STATCOM (-0.40 p. u.) + PHEVs (-0.10 p. u.)	$\text{Cos } \theta_{WDG3+STAT+PHEVs}$ with DG3 (0.00) + STATCOM (-0.40 p. u.) + PHEVs (-0.10 p. u.)	$\text{Cos } \theta_{WDG4+STAT+PHEVs}$ with DG4 (0.80lg) + STATCOM (-0.40 p. u.) + PHEVs (-0.10 p. u.)
LM-1	0.7326 (0.1014; 2.0083; 6)	0.7449 (0.0924; 1.4018; 26)	0.5686 (0.1342; 1.2131; 30)	0.5748 (0.0924; 1.4018; 26)
LM-2	0.6383 (0.1098; 0.9324; 10)	0.6451 (0.1047; 0.6852; 30)	0.5478 (0.1316; 1.1189; 30)	0.5535 (0.1047; 0.6852; 30)
LM-3	0.6041 (0.1190; 0.6765; 13)	0.6128 (0.1179; 0.5334; 29)	0.5383 (0.1291; 1.1014; 30)	0.5489 (0.1179; 0.53334; 29)
LM-4	0.5723 (0.1340; 0.3631; 15)	0.7724 (0.1272; 1.5950; 24)	0.5578 (0.1313; 0.7391; 30)	0.5694 (0.1272; 1.5950; 24)
LM-5	0.7218 (0.1010; 1.8290; 7)	0.7384 (0.0900; 1.3266; 27)	0.5752 (0.1300; 1.1812; 30)	0.5869 (0.0900; 1.3266; 27)

case integration of DG3, STATCOM (-0.40 p. u.) and PHEVs (-0.10 p. u.). The descending orders of SPFs with DSLMs are as follows:

- $DG2 + STATCOM(-0.40 p.u.) + PHEVs(-0.10 p.u.)$
 $> DG1 + STATCOM(-0.40 p.u.) + PHEVs(-0.10 p.u.)$
 $> DG4 + STATCOM(-0.40 p.u.) + PHEVs(-0.10 p.u.)$
 $> DG3 + STATCOM(-0.40 p.u.) + PHEVs(-0.10 p.u.)$

Table 12, shows that the SPF profile with integration of various types of DGs (i.e. DG1, DG2, DG3 and DG4), STATCOM (-0.50 p. u.) and PHEVs (-0.10 p. u.) with DSLMs in distribution systems.

Fig. 12, shows that the SPFs having different values with integration of various types DGs (DG1, DG2, DG3 and DG4), STATCOM

(-0.50 p. u.) and PHEVs (-0.10 p. u.) with DSLMs (i.e. LM-1, LM-2, LM-3, LM-4 and LM-5 respectively) in distribution systems from minimization of total real power loss of the system point of view. The best SPFs with DSLMs are achieved in case of integration of DG2, STATCOM (-0.50 p. u.) and PHEVs (-0.10 p. u.) whereas the poorest SPFs with DSLMs are achieved in case integration of DG3, STATCOM (-0.50 p. u.) and PHEVs (-0.10 p. u.) The descending orders of SPFs with DSLMs are as follows:

- $DG2 + STATCOM(-0.50 p.u.) + PHEVs(-0.10 p.u.)$
 $> DG1 + STATCOM(-0.50 p.u.) + PHEVs(-0.10 p.u.)$
 $> DG4 + STATCOM(-0.50 p.u.) + PHEVs(-0.10 p.u.)$
 $> DG3 + STATCOM(-0.50 p.u.) + PHEVs(-0.10 p.u.)$

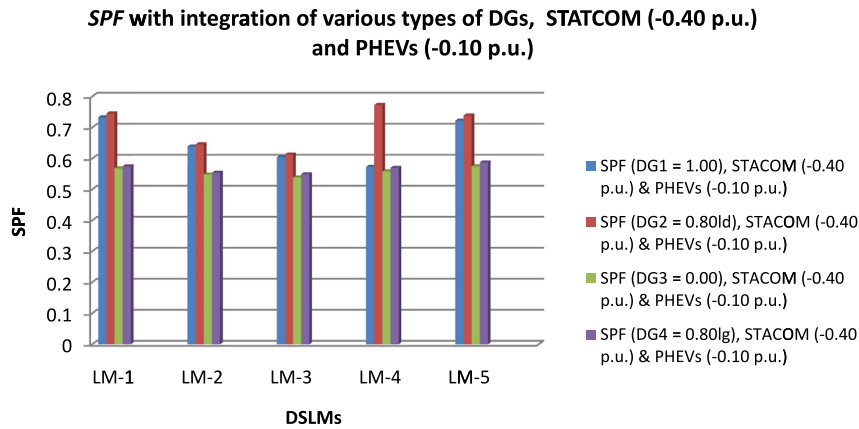

Fig. 11. SPF profiles with integration of various types of DGs (i.e. DG1, DG2, DG3 and DG4), STATCOM (−0.40 p. u.) and PHEVs (−0.10 p. u.) with DSLMs.

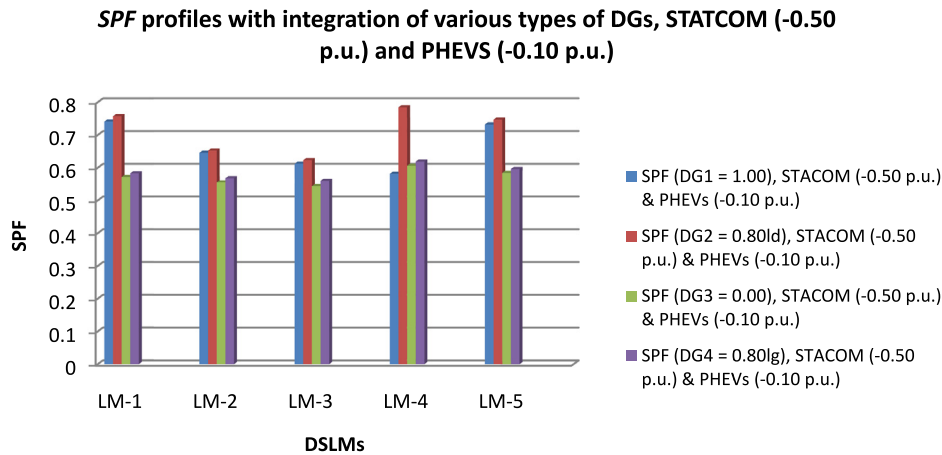

Fig. 12. SPF profiles with integration of various types of DGs (i.e. DG1, DG2, DG3 and DG4), STATCOM (−0.50 p. u.) and PHEVs (−0.10 p. u.) with DSLMs.

Table 12

SPF profiles with integration of various types of DGs (i.e. DG1, DG2, DG3 and DG4), STATCOM (−0.50 p. u.) and PHEVs (−0.10 p. u.) with DSLMs.

DSLMS	$\text{Cos } \theta_{W\text{DG1}+\text{STAT}+\text{PHEVs}}$ with DG1 (1.00) +STATCOM (−0.50 p. u.) +PHEVs (−0.10 p. u.)	$\text{Cos } \theta_{W\text{DG2}+\text{STAT}+\text{PHEVs}}$ with DG2 (0.80ld) + STATCOM (−0.50 p. u.) +PHEVs (−0.10 p. u.)	$\text{Cos } \theta_{W\text{DG3}+\text{STAT}+\text{PHEVs}}$ with DG3 (0.00) + STATCOM (−0.50 p. u.) +PHEVs (−0.10 p. u.)	$\text{Cos } \theta_{W\text{DG4}+\text{STAT}+\text{PHEVs}}$ with DG4 (0.80lg) + STATCOM (−0.50 p. u.) +PHEVs (−0.10 p. u.)
LM-1	0.7406 (0.1014; 2.0083; 6)	0.7569 (0.0924; 1.4018; 26)	0.5716 (0.1342; 1.2131; 30)	0.5828 (0.0924; 1.4018; 26)
LM-2	0.6453 (0.1098; 0.9324; 10)	0.6521 (0.1047; 0.6852; 30)	0.5548 (0.1316; 1.1189; 30)	0.5675 (0.1047; 0.6852; 30)
LM-3	0.6121 (0.1190; 0.6765; 13)	0.6228 (0.1179; 0.5334; 29)	0.5433 (0.1291; 1.1014; 30)	0.5596 (0.1179; 0.53334; 29)
LM-4	0.5813 (0.1340; 0.3631; 15)	0.7842 (0.1272; 1.5950; 24)	0.6058 (0.1313; 0.7391; 30)	0.6184 (0.1272; 1.5950; 24)
LM-5	0.7316 (0.1010; 1.8290; 7)	0.7465 (0.0900; 1.3266; 27)	0.5842 (0.1300; 1.1812; 30)	0.5959 (0.0900; 1.3266; 27)

Table 13, shows that the SPF profile with integration of various types of DGs (i.e. DG1, DG2, DG3 and DG4, respectively), STATCOM (−0.30 p. u.) and PHEVs (−0.20 p. u.) with DSLMs in distribution systems.

Fig. 13, shows that SPFs having different values with integration of various types DGs (i.e. DG1, DG2, DG3 and DG4, respectively), STATCOM (−0.30 p. u.) and PHEVs (−0.20 p. u.) with DSLMs (i.e. LM-1, LM-2, LM-3, LM-4 and LM-5, respectively) in distribution systems from minimization of total real power loss of the system point of view. The best SPFs with DSLMs are achieved in case of integration of DG2, STATCOM (−0.30 p. u.) and PHEVs (−0.20 p.

u.) whereas the poorest SPFs with DSLMs are achieved in case integration of DG3, STATCOM (−0.30 p. u.) and PHEVs (−0.20 p. u.) The descending orders of SPFs with DSLMs are as follows:

$$\begin{aligned}
 & DG2 + \text{STATCOM}(-0.30 \text{ p.u.}) + \text{PHEVs}(-0.20 \text{ p.u.}) \\
 & > DG1 + \text{STATCOM}(-0.30 \text{ p.u.}) + \text{PHEVs}(-0.20 \text{ p.u.}) \\
 & > DG4 + \text{STATCOM}(-0.30 \text{ p.u.}) + \text{PHEVs}(-0.20 \text{ p.u.}) \\
 & > DG3 + \text{STATCOM}(-0.30 \text{ p.u.}) + \text{PHEVs}(-0.20 \text{ p.u.})
 \end{aligned}$$

Table 14, shows that the SPFs profile with various types of DGs (i.e. DG1, DG2, DG3 and DG4, respectively), STATCOM (−0.40 p. u.) and PHEVs (−0.20 p. u.) with DSLMs in distribution systems.

Table 13

SPF profiles with various types of DGs (i.e. DG1, DG2, DG3 and DG4, respectively), STATCOM (−0.30 p.u.) and PHEVs (−0.20 p.u.) with DSLMs.

DSLMS	$\text{Cos } \theta_{WDC1+STAT+PHEVs}$ with DG1 (1.00) + STATCOM (−0.30 p. u.) + PHEVs (−0.20 p. u.)	$\text{Cos } \theta_{WDC2+STAT+PHEVs}$ with DG2 (0.80ld) + STATCOM (−0.30 p. u.) + PHEVs (−0.20 p. u.)	$\text{Cos } \theta_{WDC3+STAT+PHEVs}$ with DG3 (0.00) + STATCOM (−0.30 p. u.) + PHEVs (−0.20 p. u.)	$\text{Cos } \theta_{WDC4+STAT+PHEVs}$ with DG4 (0.80lg) + STATCOM (−0.30 p. u.) + PHEVs (−0.20 p. u.)
LM-1	0.7516 (0.1014; 2.0083; 6)	0.7649 (0.0924; 1.4018; 26)	0.5894 (0.1342; 1.2131; 30)	0.5998 (0.0924; 1.4018; 26)
LM-2	0.6543 (0.1098; 0.9324; 10)	0.6621 (0.1047; 0.6852; 30)	0.5668 (0.1316; 1.1189; 30)	0.5795 (0.1047; 0.6852; 30)
LM-3	0.6221 (0.1190; 0.6765; 13)	0.6348 (0.1179; 0.5334; 29)	0.5543 (0.1291; 1.1014; 30)	0.5696 (0.1179; 0.53334; 29)
LM-4	0.5913 (0.1340; 0.3631; 15)	0.7924 (0.1272; 1.5950; 24)	0.6188 (0.1313; 0.7391; 30)	0.6294 (0.1272; 1.5950; 24)
LM-5	0.7468 (0.1010; 1.8290; 7)	0.7595 (0.0900; 1.3266; 27)	0.5942 (0.1300; 1.1812; 30)	0.6049 (0.0900; 1.3266; 27)

Table 14

SPF profiles with integration of various types of DGs (i.e. DG1, DG2, DG3 and DG4), STATCOM (−0.40 p.u.) and PHEVs (−0.20 p.u.) with DSLMs.

DSLMS	$\text{Cos } \theta_{WDC1+STAT+PHEVs}$ with DG1 (1.00) + STATCOM (−0.40 p. u.) + PHEVs (−0.20 p. u.)	$\text{Cos } \theta_{WDC2+STAT+PHEVs}$ with DG2 (0.80ld) + STATCOM (−0.40 p. u.) + PHEVs (−0.20 p. u.)	$\text{Cos } \theta_{WDC3+STAT+PHEVs}$ with DG3 (0.00) + STATCOM (−0.40 p. u.) + PHEVs (−0.20 p. u.)	$\text{Cos } \theta_{WDC4+STAT+PHEVs}$ with DG4 (0.80lg) + STATCOM (−0.40 p. u.) + PHEVs (−0.20 p. u.)
LM-1	0.7626 (0.1014; 2.0083; 6)	0.7769 (0.0924; 1.4018; 26)	0.5916 (0.1342; 1.2131; 30)	0.6098 (0.0924; 1.4018; 26)
LM-2	0.6623 (0.1098; 0.9324; 10)	0.6761 (0.1047; 0.6852; 30)	0.5748 (0.1316; 1.1189; 30)	0.5875 (0.1047; 0.6852; 30)
LM-3	0.6341 (0.1190; 0.6765; 13)	0.6458 (0.1179; 0.5334; 29)	0.5663 (0.1291; 1.1014; 30)	0.5796 (0.1179; 0.53334; 29)
LM-4	0.6019 (0.1340; 0.3631; 15)	0.8064 (0.1272; 1.5950; 24)	0.6258 (0.1313; 0.7391; 30)	0.6384 (0.1272; 1.5950; 24)
LM-5	0.7523 (0.1010; 1.8290; 7)	0.7685 (0.0900; 1.3266; 27)	0.6052 (0.1300; 1.1812; 30)	0.6169 (0.0900; 1.3266; 27)

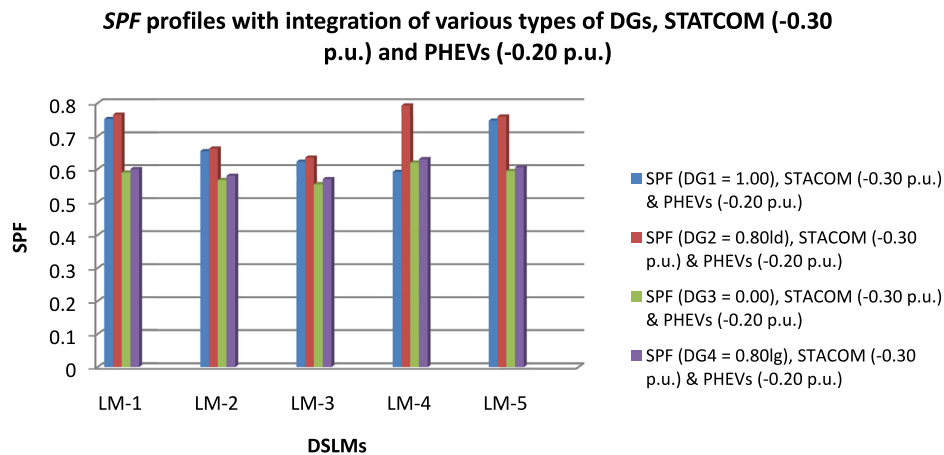

Fig. 13. SPF profiles with integration of various types of DGs (i.e. DG1, DG2, DG3 and DG4), STATCOM (−0.30 p.u.) and PHEVs (−0.20 p.u.) with DSLMs.

Fig. 14, shows that the SPFs having different values with integration of various types DGs (i.e. DG1, DG2, DG3 and DG4, respectively), STATCOM (−0.40 p.u.) and PHEVs (−0.20 p.u.) with DSLMs (i.e. LM-1, LM-2, LM-3, LM-4 and LM-5, respectively) in distribution systems from minimization of total real power loss of the system point of view. The best SPFs with DSLMs are achieved in case of integration of DG2, STATCOM (−0.40 p.u.) and PHEVs (−0.20 p.u.) whereas the poorest SPFs with DSLMs are achieved in case integration of DG3, STATCOM (−0.40 p.u.) and PHEVs (−0.20

p.u.) The descending orders of SPFs with DSLMs are as follows:

$$\begin{aligned}
 & DG2 + \text{STATCOM}(-0.40 \text{ p.u.}) + \text{PHEVs}(-0.20 \text{ p.u.}) \\
 & > DG1 + \text{STATCOM}(-0.40 \text{ p.u.}) + \text{PHEVs}(-0.20 \text{ p.u.}) \\
 & > DG4 + \text{STATCOM}(-0.40 \text{ p.u.}) + \text{PHEVs}(-0.20 \text{ p.u.}) \\
 & > DG3 + \text{STATCOM}(-0.40 \text{ p.u.}) + \text{PHEVs}(-0.20 \text{ p.u.})
 \end{aligned}$$

Table 15, shows that the SPF profile with integration of various types of DGs (i.e. DG1, DG2, DG3 and DG4, respectively), STATCOM (−0.50 p.u.) and PHEVs (−0.20 p.u.) with DSLMs in distribution systems.

SPF profiles with integration of various types of DGs, STATCOM (-0.40 p.u.) and PHEVs (-0.20 p.u.)

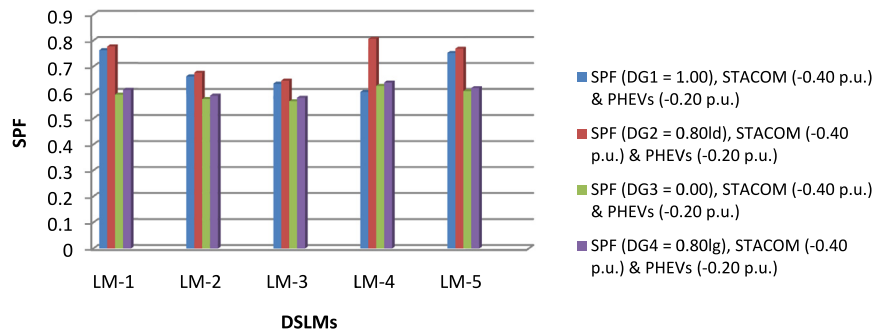

Fig. 14. SPF profiles with integration of various types of DGs (i.e. DG1, DG2, DG3 and DG4), STATCOM (-0.40 p. u.) and PHEVs (-0.20 p. u.) with DSLMs.

Table 15

SPF profiles with integration of various types of DGs (i.e. DG1, DG2, DG3 and DG4, respectively), STATCOM (-0.50 p. u.) and PHEVs (-0.20 p. u.) with DSLMs.

DSLMs	Cos $\theta_{WDG1+STAT+PHEVs}$ with DG1 (1.00) + STATCOM (-0.50 p. u.) + PHEVs (-0.20 p. u.)	Cos $\theta_{WDG2+STAT+PHEVs}$ with DG2 (0.80ld) + STATCOM (-0.50 p. u.) + PHEVs (-0.20 p. u.)	Cos $\theta_{WDG3+STAT+PHEVs}$ with DG3 (0.00) + STATCOM (-0.50 p. u.) + PHEVs (-0.20 p. u.)	Cos $\theta_{WDG4+STAT+PHEVs}$ with DG4 (0.80lg) + STATCOM (-0.50 p. u.) + PHEVs (-0.20 p. u.)
LM-1	0.7626 (0.1014; 2.0083; 6)	0.7799 (0.0924; 1.4018; 26)	0.5916 (0.1342; 1.2131; 30)	0.6098 (0.0924; 1.4018; 26)
LM-2	0.6623 (0.1098; 0.9324; 10)	0.6761 (0.1047; 0.6852; 30)	0.5748 (0.1316; 1.1189; 30)	0.5875 (0.1047; 0.6852; 30)
LM-3	0.6341 (0.1190; 0.6765; 13)	0.6458 (0.1179; 0.5334; 29)	0.5663 (0.1291; 1.1014; 30)	0.5796 (0.1179; 0.53334; 29)
LM-4	0.6019 (0.1340; 0.3631; 15)	0.8064 (0.1272; 1.5950; 24)	0.6258 (0.1313; 0.7391; 30)	0.6384 (0.1272; 1.5950; 24)
LM-5	0.7523 (0.1010; 1.8290; 7)	0.7695 (0.0900; 1.3266; 27)	0.6052 (0.1300; 1.1812; 30)	0.6199 (0.0900; 1.3266; 27)

Fig. 15, shows that the SPFs having different values with integration of various types DGs (i.e. DG1, DG2, DG3 and DG4, respectively), STATCOM (-0.50 p. u.) and PHEVs (-0.20 p. u.) with DSLMs (i.e. LM-1, LM-2, LM-3, LM-4 and LM-5, respectively) in distribution systems from minimization of total real power loss of the system point of view. The best SPFs with DSLMs are achieved in case of integration of DG2, STATCOM (-0.50 p. u.) and PHEVs (-0.20 p. u.) whereas the poorest SPFs with DSLMs are achieved in case integration of DG3, STATCOM (-0.50 p. u.) and PHEVs (-0.20 p. u.) The descending orders of SPFs with DSLMs are as follows:

- $DG2 + STATCOM(-0.50 p.u.) + PHEVs(-0.20 p.u.)$
 $> DG1 + STATCOM(-0.50 p.u.) + PHEVs(-0.20 p.u.)$
 $> DG4 + STATCOM(-0.50 p.u.) + PHEVs(-0.20 p.u.)$
 $> DG3 + STATCOM(-0.50 p.u.) + PHEVs(-0.20 p.u.)$

4.5. Comparisons of results

The comparisons of results are presented in this sub-section are as follows:

Table 16, shows the comparisons of the SPF for integration of DG1 (operating at 1.00 p. f.) and STATCOM vs. SPF for integration of DGs, STATCOM and PHEVs with DSLMs. Table 16, it is concluded that:

- Integration of DG1 and STATCOM in generating mode operation (i.e. STATCOM provide the reactive power support to the system) achieved the better SPF compared to when DG1 is used only.
- Integration of DG1 and STATCOM in load mode operation (i.e. STATCOM absorb the reactive power from the system) achieved the poor SPF compared to when DG1 is used only.

- Integration of DG1 and STATCOM in generating mode operation achieved the better SPF compared to when integration of DG1 and STATCOM in load mode operation.
- Integration of DG1, STATCOM and PHEVs achieved the better SPF compared to integration of DG1 and STATCOM. After increasing the value of active power support (in p. u.) by PHEVs gives the best SPF compared to previous condition.

Table 17, shows the comparisons of the SPF for DG2 (operating at 0.80 leading p. f.) and STATCOM vs. SPF for integration of DG2, STATCOM and PHEVs in distribution systems with DSLMs. Table 17, it is concluded that integration of DG2 and STATCOM in generating mode (i.e. STATCOM provide the reactive power support to the system) achieved better power factor compared to when DG2 is used only.

- Integration of DG2 and STATCOM in load mode (i.e. STATCOM absorb the reactive power from the system) achieved less SPF compared to when DG1 is used only.
- Integration of DG2 and STATCOM in generating mode achieved the better SPF compared to when DG2 incorporated STATCOM in load mode.
- Integration of DG2, STATCOM and PHEVs achieved better SPF compared to DG2 incorporated STATCOM. After increasing the value of active power support (in p. u.) of PHEVs gives best SPF compared to previous condition.

Table 18, shows comparison of the SPF of DG3 (operating at 0.00 p. f.) and STATCOM vs. SPF for integration of DG3, STATCOM and PHEVs with DSLMs. Table 18, it is concluded that integration DG3 and STATCOM in generating mode (i.e. STATCOM provide

SPF profiles with integration of various types of DGs, STATCOM (-0.50 p.u.) and PHEVs (-0.20 p.u.)

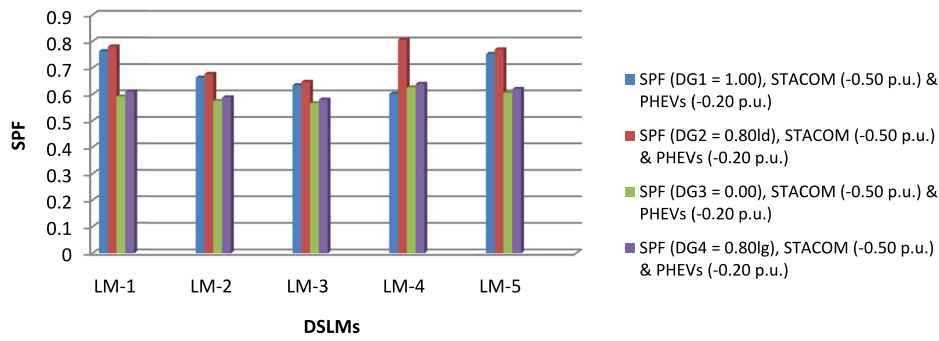

Fig. 15. SPF profiles with integration of various types of DGs (i.e. DG1, DG2, DG3 and DG4, respectively), STATCOM (-0.50 p. u.) and PHEVs (-0.20 p. u.) with DSLMs.

Table 16

The comparisons of the SPF for integration of DG 1 (operating at 1.00 p. f.) and STATCOM vs. SPF for integration of DGs, STATCOM and PHEVS with DSLMs.

SPF for integration of DG1 and STATCOM					
Operating state of STATCOM and PHEVs	DSLMS				
	LM-1	LM-2	LM-3	LM-4	LM-5
WDG	0.7406	0.6283	0.6221	0.5821	0.7368
WDG+STAT(-0.30)	0.7506	0.6493	0.6321	0.5913	0.7368
WDG+STAT(-0.40)	0.7596	0.6483	0.6331	0.5993	0.7468
WDG+STAT(-0.50)	0.7706	0.6683	0.6491	0.6013	0.7598
WDG+STAT(+0.30)	0.7316	0.6263	0.6021	0.5713	0.7228
WDG+STAT(+0.40)	0.7206	0.6243	0.6011	0.5923	0.7178
WDG+STAT(+0.50)	0.7116	0.6083	0.5821	0.5743	0.7068
SPF for integration of DG1, STATCOM and PHEVs					
WDG+STAT(-0.30)+PHEVs(-0.10)	0.7519	0.6553	0.6351	0.6093	0.7394
WDG+STAT(-0.40)+PHEVs(-0.10)	0.7621	0.6495	0.6371	0.6124	0.7498
WDG+STAT(-0.50)+PHEVs(-0.10)	0.7795	0.6692	0.6520	0.6245	0.7623
WDG+STAT(-0.30)+PHEVs(-0.20)	0.7548	0.6577	0.6372	0.6121	0.7423
WDG+STAT(-0.40)+PHEVs(-0.20)	0.7645	0.6521	0.6399	0.6256	0.7523
WDG+STAT(-0.50)+PHEVs(-0.20)	0.7813	0.6734	0.6556	0.6376	0.7667

Table 17

The comparisons of the SPF for integration of DG2 (operating at 0.80 leading p. f.) and STATCOM vs. SPF for integration of DGs, STATCOM and PHEVs with DSLMs.

SPF for integration of DG2 and STATCOM					
Operating state of STATCOM and PHEVs	DSLMS				
	LM-1	LM-2	LM-3	LM-4	LM-5
WDG	0.7569	0.6521	0.6228	0.7824	0.7465
WDG+STAT(-0.30)	0.7669	0.6591	0.6428	0.7924	0.7565
WDG+STAT(-0.40)	0.7769	0.6621	0.6498	0.7994	0.7665
WDG+STAT(-0.50)	0.7779	0.6691	0.6528	0.8024	0.7765
WDG+STAT(+0.30)	0.7459	0.6421	0.6198	0.7724	0.7365
WDG+STAT(+0.40)	0.7349	0.6341	0.6198	0.7614	0.7295
WDG+STAT(+0.50)	0.7259	0.6221	0.5918	0.7524	0.7165
SPF for integration of DG2, STATCOM and PHEVs					
WDG+STAT(-0.30)+PHEVs(-0.10)	0.7699	0.6632	0.6487	0.7967	0.7589
WDG+STAT(-0.40)+PHEVs(-0.10)	0.7798	0.6673	0.6526	0.8014	0.7695
WDG+STAT(-0.50)+PHEVs(-0.10)	0.7813	0.6734	0.6247	0.8127	0.7799
WDG+STAT(-0.30)+PHEVs(-0.20)	0.7721	0.6667	0.6521	0.7999	0.7614
WDG+STAT(-0.40)+PHEVs(-0.20)	0.7815	0.6698	0.6567	0.8076	0.7721
WDG+STAT(-0.50)+PHEVs(-0.20)	0.7845	0.6788	0.6298	0.8149	0.7831

the reactive power support to the system) achieved better SPF compared to when DG3 is used only.

- Integration of DG3 and STATCOM in load mode operation (i.e. STATCOM absorb the reactive power from the system) achieved the poor SPF compared to when DG3 is used only.

- Integration of DG3 and STATCOM in generating mode operation achieved the better SPF compared to when DG3 incorporated STATCOM in load mode operation.
- Integration of DG3, STATCOM and PHEVs achieved the better SPF compared to DG3 and STATCOM. After increasing the

Table 18

The comparisons of the *SPF* for integration of DG3 (operating at 0.00 power factor) and STATCOM vs. *SPF* of integration of DG3, STACOM and PHEVs with DSLMs.

<i>SPF</i> for integration of DG3 and STATCOM					
Operating state of STATCOM and PHEVs	DSLMS				
	LM-1	LM-2	LM-3	LM-4	LM-5
WDG	0.5896	0.5568	0.5443	0.6058	0.5852
WDG+STAT(−0.30)	0.5926	0.5598	0.5543	0.6098	0.5883
WDG+STAT(−0.40)	0.5996	0.5668	0.5598	0.6124	0.5921
WDG+STAT(−50)	0.6126	0.5768	0.5743	0.6138	0.6152
WDG+STAT(+0.30)	0.5706	0.5468	0.5343	0.5858	0.5752
WDG+STAT(+0.40)	0.5596	0.5378	0.5293	0.5718	0.5692
WDG+STAT(+50)	0.5446	0.5268	0.5143	0.5558	0.5552
<i>SPF</i> for integration of DG3, STATCOM and PHEVs					
WDG+STAT(−0.30)+PHEVs(−0.10)	0.6026	0.6627	0.5598	0.6134	0.5921
WDG+STAT(−0.40)+PHEVs(−0.10)	0.6035	0.5687	0.5634	0.6276	0.5978
WDG+STAT(−0.50)+PHEVs(−0.10)	0.6178	0.5823	0.5789	0.6298	0.6192
WDG+STAT(−0.30)+PHEVs(−0.20)	0.6076	0.6677	0.5613	0.6189	0.5983
WDG+STAT(−0.40)+PHEVs(−0.20)	0.6085	0.5731	0.5683	0.6299	0.6021
WDG+STAT(−0.50)+PHEVs(−0.20)	0.6212	0.5858	0.5824	0.6345	0.6251

Table 19

The comparisons of the *SPF* for integration of DG4 (operating at 0.80 lagging p. f.) and STATCOM vs. *SPF* of integration of DGs, STACOM and PHEVs with DSLMs.

<i>SPF</i> for integration of DG4 and STATCOM					
Operating state of STATCOM and PHEVs	DSLMS				
	LM-1	LM-2	LM-3	LM-4	LM-5
WDG	0.5988	0.5675	0.5596	0.6084	0.5959
WDG+STAT(−0.30)	0.6088	0.5695	0.5696	0.6284	0.6059
WDG+STAT(−0.40)	0.6188	0.5775	0.5796	0.6294	0.6159
WDG+STAT(−50)	0.6288	0.5795	0.5896	0.6284	0.6239
WDG+STAT(+0.30)	0.5788	0.5575	0.5496	0.5984	0.5819
WDG+STAT(+0.40)	0.5648	0.5445	0.5336	0.5854	0.5759
WDG+STAT(+50)	0.5528	0.5385	0.5296	0.5684	0.5659
<i>SPF</i> for integration of DG4, STATCOM and PHEVs					
WDG+STAT(−0.30)+PHEVs(−0.10)	0.6123	0.5732	0.5721	0.6311	0.6098
WDG+STAT(−0.40)+PHEVs(−0.10)	0.6234	0.5812	0.5834	0.6345	0.6189
WDG+STAT(−0.50)+PHEVs(−0.10)	0.6324	0.5824	0.5928	0.6385	0.6278
WDG+STAT(−0.30)+PHEVs(−0.20)	0.6177	0.5793	0.5778	0.6356	6142
WDG+STAT(−0.40)+PHEVs(−0.20)	0.6288	0.5888	0.5896	0.6425	0.6231
WDG+STAT(−0.50)+PHEVs(−0.20)	0.6399	0.5912	0.5987	0.6396	0.6336

value of active power support (in p. u.) by PHEVs gives best *SPF* compared to previous condition.

Table 19, shows comparison of the *SPF* of integration of DG4 (operating at 0.80 lagging p. f.) and STATCOM vs. *SPF* of integration of DG4, STACOM and PHEVs with DLMS. Table 19, it is concluded that integration of DG4 and STATCOM in generating mode (i.e. STATCOM provide the reactive power support to the system) achieved better *SPF* compared to when DG4 is used only.

- Integration of DG4 and STATCOM in load mode operation (i.e. STATCOM absorb the reactive power from the system) achieved poor *SPF* compared to when DG4 is used only.
- Integration of DG4 and STATCOM in generating mode operation achieved better *SPF* compared to when DG4 and STATCOM in load mode operation.
- Integration of DG4, STATCOM and PHEVs achieved better *SPF* compare to integration of DG4 and STATCOM. After increasing the value of active power support (in p. u.) of PHEVs gives best *SPF* compared to previous condition.

5. Conclusions and future scopes of research work

The conclusions and future scope of research work are presented in Sections 5.1 and 5.2, subsequently.

5.1. Conclusions

The following conclusions made from this research work are as follows:

- Enhance the system power factor depends on the sizes and locations of DGs, incorporated STATCOM and PHEVs in distribution systems with DSLMs.
- The system power factor when DGs, incorporated STATCOM (i.e. operating in generating mode that means the reactive power delivered to the system) and PHEVs, is better than the system power factor when STATCOM (i.e. operating in load mode that means the reactive power absorbed from the system bus).
- Enhance the real and reactive power support to the system by integration of DGs, incorporated STATCOM and PHEVs in distribution systems with DSLMs.
- The real and reactive power losses of the system should be minimized by optimally placed and properly coordinated of DGs, incorporated STATCOM and PHEVs in distribution systems with DSLMs.

5.2. Future scopes of research work

The following future scopes of this research work in this direction are as follows:

- The proposed methodology also used for other FACTS controllers such as dynamic voltage restorer (DVR), unified power flow controller (UPQC), distributed-STATCOM, and hybrid power flow controllers (HPFC) and generalized unified power flow controllers (GUPFC) etc.
- In future, enhance the system power factor by integration of DGs, incorporated STATCOM and PHEVs for dynamic load models.
- In future, enhance the system power factor by integration of DGs, incorporated D-STATCOM and PHEVs for dynamic load models.
- In future, enhance the system power factor by integration of DGs, incorporated DVR and PHEVs for dynamic load models.
- In future, enhance the system power factor by integration of DGs, incorporated UPQC and PHEVs for dynamic load models.
- In future, also improved other power system performances such as power quality parameters (distortion harmonic factor, voltage sag and swell etc.) by integration of DGs, incorporated STATCOM and PHEVs in distribution systems with time dependent load models.
- The proposed methodology also used for higher IEEE bus test system like IEEE-57, IEEE-75 246-indian test system etc. for validation of proposed methodology robustness.
- Practical implementations are possible for integration of renewable energy sources, incorporated FACTS controllers and PHEVs in distribution systems with time dependent load models.

References

- Abd-Elazim, SM., Ali, ES., 2016. Imperialist competitive algorithm for optimal STATCOM design in a multi-machine power system. *Int. J. Electr. Power Energy Syst.* 76, 136–146.
- Ackermann, T., Andersson, Soder, GL., 2001. Distributed generations: a definition. *Electr. Power Syst. Res.* 57, 195–204.
- Akorede, H., Hizam, I., Aris, M.Z.A., Ab Kadir, M.F., 2011a. Effective method for optimal allocation of distributed generation units in meshed electric power systems. *IET Gen. Transm. Distrib.* 5 (2), 20–28.
- Akorede, M.F., Hizam, H., Aris, I., Kadir, M.Z.A., 2011. Effective method for optimal allocation of distributed generation units in meshed electric power systems. *IET Gen. Transm. Distrib.* 5 (2), 276–287.
- Al Abri, RS., El-Saadany, EF., Atwa, YM., 2013. Optimal placement and sizing method to improve the voltage stability margin in a distribution system using distributed generation. *IEEE Trans. Power Syst.* 28 (1), 326–334.
- Ali, ES., Elazim, SM., Abdelaziz, AY., 2016. Ant lion optimization algorithm for renewable distributed generations. *Energy J.* 116, 445–458.
- Amjadi, Z., Williamson, SS., 2014. Digital Control of a Bidirectional DC/DC Switched Capacitor Converter for Hybrid Electric Vehicle Energy Storage System Applications. *IEEE Trans. Smart Grid.* 5 (1), 158–166.
- Arash, Z.M., Moradi, H., 2015. Optimal multi objective placement and sizing of multiple DGs and shunt capacitor banks simultaneously considering load uncertainty via MOPSO approach. *Int. J. Electr. Power Energy Syst.* 67, 336–349.
- Babacan, O., William, T., Jan, K., 2017. Siting and sizing of distributed energy storage to mitigate voltage impact by solar PV in distribution systems. *Sol. Energy* 146, 199–208.
- Bahram, P., Peyman, K., Gharehpetian, GB., Abedi, M., 2016. Optimal allocation and sizing of DG units considering voltage stability, losses and load variations. *Int. J. Electr. Power Energy Syst.* 79, 45–52.
- Bansal, Ramesh, 2017. *Handbook of Distributed Generation, Electric Power Technologies, Economics and Environmental Impacts.*
- Borges, CLT., Falcao, DM., 2006. Optimal distributed generation allocation for reliability, losses, and voltage improvement. *Int. J. Electr. Power Energy Syst.* 28 (6), 413–420.
- Caprinelli, G., Celli, G., Mocci, S., Pilo, F., Russo, A., 2005. Optimization of embedded generation sizing and siting by using a double trade-off method. *IET Gen. Transm. Distrib.* 152 (4), 503–513.
- Caprinelli, G., Celli, G., Pilo, F., Russo, A., 2003. Embedded generation planning under uncertainty including power quality issues. *European Trans. Electr. Power* 13 (6), 381–390.
- Carvalho, P.M.S., Correia, P.F., Ferreira, L.A.F.M., 2008. Distributed reactive power generation control for voltage rise mitigation in distribution networks. *IEEE Trans. Power Syst.* 23 (2), 766–772.
- Celli, G., Ghiani, E., Mocci, S., Pilo, F., 2005a. A multi-objective evolutionary algorithm for the sizing and siting of distributed generation. *IEEE Trans. Power Syst.* 20 (2), 750–757.
- Celli, G., Ghiani, E., Mocci, S., Pilo, F., 2005b. A multi-objective evolutionary algorithm for the sizing and siting of DGs. *IEEE Trans. Power Syst.* 20 (2), 750–771.
- Chaurasia, GS., Singh, AK., Agrawal, S., Sharma, NK., 2017. A meta-heuristic firefly algorithm based smart control strategy and analysis of a grid connected hybrid photovoltaic/wind distributed generation system. *Sol. Energy* 150, 265–274.
- Chiradeja, P., Ramakumar, R., 2004. An approach to quantify the technical benefits of DG. *IEEE Trans. Energy Convers.* 19 (4), 764–773.
- Darabian, M., Jalilv, A., 2018. Improving power system stability in the presence of wind farms using STATCOM and predictive control strategy. *IET Renew. Power Gen.* 12 (1), 98–111.
- Darabian, Mohsen, Jalilvand, Abolfazl, 2018. Improving power system stability in the presence of wind farms using STATCOM and predictive control strategy. *IET Renew. Power Gen.* 12 (1), 98–111.
- Daud, AS., Kadir, FA., Gan, CK., Mohamed, A., Tamer, K., 2016. A comparison of heuristic optimization techniques for optimal placement and sizing of photovoltaic based distributed generation in a distribution system. *Sol. Energy* 140, 219–226.
- Ela, A.A.E., Allam, SM., Shatla, MM., 2010. Maximal optimal benefits of distributed generation using genetic algorithms. *Electr. Power Syst. Res.* 80 (7), 869–877.
- ElNozahy, MS., Salama, MMA., 2015. Uncertainty-based design of a bilayer distribution system for improved integration of PHEVs and PV Arrays. *IEEE Trans. Sustainable Energy.* 6 (3), 659–674.
- Gallego, RA., Monticell, AJ., Romero, R., 2001. Optimal capacitor placement in radial distribution networks. *IEEE Trans. Power Systems.* 16 (4), 630–637.
- Gandomkar, M., Vakilian, M., Ehsan, M., 2005. A genetic-based tabu search algorithm for optimal dg allocation in distribution networks. *Electr. Power Compon. Syst.* 33 (12), 1351–1362.
- Gregorio, MD., Javier, C., Jose, M.A., 2015. A joint expansion planning of distributed generation and distribution networks. *IEEE Trans. Power Syst.* 30 (5), 2579–2590.
- Han, C., Huang, AQ., Baran, ME., Bhattacharya, S., Litzenberger, W., Anderson, L., Johnson, AL., Edris, AA., 2008. STATCOM impact study on the integration of a large wind farm into a weak loop power system. *IEEE Trans. Energy Convers.* 23 (1), 226–233.
- Harrison, GP., Piccolo, A., Siano, P., Wallace, AR., 2008. Hybrid GA and OPF evaluation of network capacity for distributed generation connections. *Electr. Power Syst. Res.* 78 (3), 392–408.
- Hegazy, YG., Salama, MMA., Chikhani, AY., 2003. Adequacy assessment of distributed generation systems using Monte Carlo simulation. *IEEE Trans. Power Syst.* 18 (1), 48–52.
- Hong, YY., Ho, SY., 2005. Determination of network configuration considering multi-objective in distribution systems using genetic algorithms. *IEEE Trans. Power Syst.* 20 (2), 1062–1069.
- Hossain, MJ., Pota, HR., Ramos, RA., 2012. Improved low-voltage-ride-through capability of fixed speed wind turbines using decentralized control of statcom with energy storage system. *IET Gen. Transm. Distrib.* 6 (8), 719–730.
- Ibrahim, Alsaaidan, Khodaei, Amin, Gao, Wenzhong, 2018. A comprehensive battery energy storage optimal sizing model for micro-grid applications. *IEEE Trans. ON Power Syst.* 33 (4), 3968–3980.
2010. IEEE task force on load representation for dynamic performance. 1993. Load representation for dynamic performance analysis. *IEEE Trans. Power Syst.* 8 (2), 472–82.
- Injeti, SK., Kumar, NP., 2013. A novel approach to identify optimal access point and capacity of multiple DGs in small, medium and large scale radial distribution systems. *Int. J. Electr. Power Energy Syst.* 45 (1), 142–151.
- Kang, Q., Feng, S., Zhou, M., Ammari, AC., Sedraoui, K., 2017. Optimal load scheduling of plug-in hybrid electric vehicles via weight-aggregation multi-objective evolutionary algorithms. *IEEE Trans. Intell. Transp. Syst.* 18 (9), 2557–2568.
- Keane, A., O'malley, M., 2005. Optimal allocation of embedded generation on distribution networks. *IEEE Trans. Power Syst.* 20 (3), 1640–1646.
- Keane, A., Zhou, Q., Bialek, J., O'Malley, M., 2009. Planning and operating non-firm distributed generation. *IET Renew. Power Gen.* 3 (4), 455–464.
- Kim, KH., Lee, YJ., Rhee, SB., Lee, SK., You, SK., 2002. Dispersed generator placement using fuzzy-GA in distribution systems. In: *Proc. IEEE Power Eng. Soc. Summer Meeting*, Vol. 23 pp. 1148–53.
- Kim, JO., Nam, SW., Park, SK., Singh, C., 1998. Dispersed generation planning using improved herford ranch algorithm. *Electr. Power Syst. Res.* 47 (1), 47–55.
- Kim, KH., Song, KB., Joo, SK., Lee, YJ., Kim, JO., 2008. Multi-objective distributed generation placement using fuzzy goal programming with genetic algorithm. *European Trans. Electr. Power* 18 (3), 217–230.
- Lee, SH., Park, JW., 2009. Selection of optimal location and size of multiple distributed generators by using kalman filter algorithm. *IEEE Trans Power Syst.* 24 (3), 1393–1400.
- Li, C., Deng, J., Zhang, XP., 2017. Coordinated design and application of robust damping controllers for shunt FACTS devices to enhance small-signal stability of large-scale power systems. *CSEE J. Power Energy Syst.* 3 (4), 399–407.
- Liu, J., Xu, Y., Dong, ZY., Wong, KP., 2018. Retirement-driven dynamic VAR planning for voltage stability enhancement of power systems with high-level wind power. *IEEE Trans. Power Syst.* 33 (2), 2282–2291.

- López, LJM., Contreras, J., Padilha, FA., 2012. Location and contract pricing of distributed generation using a genetic algorithm. *Int. J. Electr. Power Energy Syst.* 36 (1), 117–126.
- Luo, Z., Hu, Z., Song, Y., Xu, Z., Lu, H., 2013. Optimal coordination of plug-in electric vehicles in power grids with cost-benefit analysis—part II: A case study in China. *IEEE Trans. Power Syst.* 28 (4), 3556–3565.
- Maziar, Y., Fariborz, J., 2016. Lion Optimization Algorithm (LOA): A nature-inspired meta-heuristic algorithm. *J. Comput. Des. Eng.* 3 (1), 24–36.
- Mohammadi, M., Hosseinian, SH., G. B. Gharehpetian, GB., 2012. Optimization of hybrid solar energy sources/wind turbine systems integrated to utility grids as microgrid (MG) under pool/bilateral/hybrid electricity market using PSO. *Sol. Energy* 86, 112–125.
- Mohsen, S., Hosseinienejad, M., Fereidunian, A., Lesani, H., 2018. Reliability improvement considering plug-in hybrid electric vehicles parking lots ancillary services: a stochastic multi-criteria approach. *IET Gen. Transm. Distrib.* 12 (4), 824–833.
- Morteza, Yarahmadi, Shakarami, Mahmoud Reza, 2018. An analytical and probabilistic method to determine wind distributed generators penetration for distribution networks based on time-dependent loads. *Int. J. Electr. Power Energy Syst.* 103, 404–413.
- Ochoa, LF., Padilha-Feltrin, A., Harrison, GP., 2006. Evaluating distributed generation impacts with a multi-objective index. *IEEE Trans. Power Deliv.* 21 (3), 1452–1458.
- Othman, MM., Elk, Walid., Yasser, GH., Almoataz, YA., 2015. Optimal placement and sizing of distributed generators in unbalanced distribution systems using supervised big bang-big crunch method. *IEEE Trans. Power Syst.* 30 (2), 911–919.
- Parvez, M., Elias, MFM., Rahim, NA., Osman, N., 2016. Current control techniques for three-phase grid interconnection of renewable power generation systems: A review. *Sol. Energy* 135, 29–42.
- Raoufat, M., 2011. Simultaneous allocation of DG and remote controllable switches in distribution networks considering multilevel load model. *Int. J. Electr. Power Energy Syst.* 33 (8), 1429–1436.
- Roy, JB., Leemput, N., Geth, F., Büscher, J., Salenbien, R., Driesen, J., 2014. Electric vehicle charging in an office building micro-grid with distributed energy resources. *IEEE Trans. Sustainable Energy* 5 (4), 1389–1396.
- Senjyu, T., Miyazato, Y., Yona, A., Urasaki, N., Funabashi, T., 2008. Optimal distribution voltage control and coordination with distributed generation. *IEEE Trans. Power Deliv.* 23 (2), 1236–1242.
- Seyedali, M., Amir, HG., Seyedeh, ZM., Shahrzad, S., Hossam, F., Seyed, MM., 2017. Salp swarm algorithm: A bio-inspired optimizer for engineering design problems. *Adv. Eng. Softw.* 114, 163–191.
- Seyedali, M., Andrew, L., 2014. Grey wolf optimizer. *Adv. Eng. Softw.* 69, 46–61.
- Seyedali, M., Andrew, L., 2016. The whale optimization algorithm. *Adv. Eng. Softw.* 95, 51–67.
- Shaaban, MF., Atwa, YM., El-Saadany, EF., 2014. DG allocation for benefit maximization in distribution networks. *IEEE Trans. Power Syst.* 28 (2), 639–649.
- Shahrzad, S., Seyedali, M., Andrew, L., 2017. Grasshopper optimization algorithm: theory and application. *Adv. Eng. Softw.* 105, 30–47.
- Sheng, W., Liu, KY., Liu, Y., Meng, X., Li, Y., 2015. Optimal placement and sizing of DG via an improved non dominated sorting genetic algorithm-II. *IEEE Trans. Power Delivery* 30 (2), 569–578.
- Shojaabadi, S., Abapour, S., Abapour, M., Nahavandi, A., 2016. Optimal planning of plug-in hybrid electric vehicle charging station in distribution network considering demand response programs and uncertainties. *IET Generation, Transm. Distrib.* 10 (13), 3330–3340.
- Shukla, TN., Singh, SP., Shrinivasarao, V., Naik, KB., 2010. Optimal sizing of distributed generation placed on radial distribution systems. *Electr. Power Compon. Syst.* 38 (3), 260–274.
- Singh, RK., Goswami, SK., 2009. Optimum siting and sizing of distributed generations in radial and networked systems. *Electr. Power Compon. Syst.* 37 (2), 127–145.
- Singh, RK., Goswami, SK., 2010a. Optimum allocation of DGs based on nodal pricing for profit, loss reduction, and voltage improvement including voltage rise issue. *Int. J. Electr. Power Energy Syst.* 32 (6), 637–644.
- Singh, RK., Goswami, SK., 2010b. Optimum allocation of distributed generations based on nodal pricing for profit, loss reduction, and voltage improvement including voltage rise issue. *Int. J. Electr. Power Energy Syst.* 32 (6), 637–644.
- Singh, RK., Goswami, SK., 2011. Multi-objective optimization of distributed generation planning using impact indices and trade-off technique. *Electr. Power Syst. Res.* 39 (11), 1175–1190.
- Singh, D., Mishra, RK., Singh, D., 2007. Mishra RK Singh D Effect of load models in distributed generation planning. *IEEE Trans. Power Syst.* 22 (4), 2204–2212.
- Singh, Bindeswar, Mukherjee, V., Tiwari, Prabhakar, 2015. A survey on impact assessment of DG and FACTS controllers in power systems. *Renewable and Sustainable Energy Rev.* 42, 846–882.
- Singh, B., Mukherjee, V., Tiwari, P., 2016a. Genetic algorithm for impact assessment of optimally placed distributed generations with different load models from minimum total MVA intake viewpoint of main substation. *Renewable Sustainable Energy Rev.* 57, 1611–1636.
- Singh, Bindeshwar, Mukherjee, V., Tiwari, Prabhakar, 2016b. Genetic algorithm optimized impact assessment of optimally placed DGs and FACTS controller with different load models from minimum total real power loss viewpoint. *Energy Build.* 126, 194–219.
- Singh, Bindeshwar, Mukherjee, V., Tiwari, Prabhakar, 2017. GA-based multi-objective optimization for distributed generations planning with DLMs in distribution power systems. *J. Electr. Syst. Inf. Technol.*
- Singh, Bindeshwar, Sharma, Janmejy, 2017. A review on distributed generation planning. *Renew. Sustainable Energy Rev.* 26, 529–544.
- Singh, B., Sharma, NK., Tiwari, AN., 2010. A comprehensive survey of optimal placement and coordinated control techniques of FACTS controllers in multi-machine power system environments. *J. Electr. Eng. Technol. (JEET)*, 5 (1), 79–102.
- Singh, D., Singh, D., Verma, KS., 2009. Multi-objective optimization for DG planning with load models. *IEEE Trans. Power Syst.* 24 (1), 427–436.
- Soroudi, A., Ehsan, M., 2011. Efficient immune-GA method for DNOs in sizing and placement of distributed generation units. *European Trans. Electr. Power* 21 (3), 1361–1375.
- Tahboub, AM., Moursi, MSE., Woon, WL., Kirtley, JL., 2018. Multi-objective dynamic VAR planning strategy with different shunt compensation technologies. *IEEE Trans. Power Syst.* 33 (3), 2429–2439.
- Teng, JH., Liu, YH., Chen, CY., Chen, CF., 2007. Value-based distributed generator placements for service quality improvements. *Int. J. Electr. Power Energy Syst.* 29 (3), 268–274.
- Varma, RK., Vinod, K., Ravi, S., 2009. Nighttime Application of PV Solar Farm as STATCOM to Regulate Grid Voltage. *IEEE Trans. Energy Convers.* 24 (4), 983–985.
- Vinothkumar, K., Selvan, MP., 2011. Fuzzy embedded genetic algorithm method for distribution generations planning. *Electr. Power Compon. Syst.* 39 (4), 346–366.
- Vinothkumar, K., Selvan, MP., 2012. Distributed generation planning: a new approach based on goal programming. *Electr. Power Compon. Syst.* 40 (5), 497–512.
- Wafa, BY., Taher, M., Christophe, M., Sassi, BN., 2018. Modeling and optimization of a solar system based on concentrating photovoltaic/thermal collector. *Sol. Energy* 170, 301–313.
- Xinkai, Fan, Jin, Shu, Baohui, Zhang, 2018. Coordinated control of DC grid and offshore wind farms to improve rotor-angle stability. *IEEE Trans. Power Syst.* 33 (4), 4625–4633.
- Zhang, D., Fu, Z., Zhang, L., 2008. Joint optimization for power loss reduction in distribution system. *IEEE Trans. Power Syst.* 23 (1), 161–169.



Bindeshwar Singh received the M.Tech. in electrical engineering from the Indian Institute of Technology, Roorkee, in 2001. He received Ph. D. Degree from IIT (ISM) Dhanbad, Jharkhand, India in 2017. His research interests are in Coordination of FACTS controllers, DGs and Power system Engg. Currently, he is an Assistant Professor with Department of Electrical Engineering, Kamla Nehru Institute of Technology, Sultanpur, U.P., and India, where he has been since August 2009.



Swati Singh received the B.Tech. in electrical & electronics engineering from the Rajarshi Rananjay Sinh Institute of Management & Technology, Amethi, in 2015. Swati Singh is a student of M.Tech final year in electrical engineering from Kamla Nehru Institute of technology, Sultanpur, U.P. India., in 2017. Her interest is in DGS and custom power devices planning in distribution power systems.