

Witada Anukoonwattaka; Romao, Pedro; Lobo, Richard S.

Working Paper

If the US-China trade war is here to stay, what are the risks and opportunities for other GVC economies outside the war zone?

ARTNeT Working Paper Series, No. 209

Provided in Cooperation with:

Asia-Pacific Research and Training Network on Trade (ARTNeT), Bangkok

Suggested Citation: Witada Anukoonwattaka; Romao, Pedro; Lobo, Richard S. (2021) : If the US-China trade war is here to stay, what are the risks and opportunities for other GVC economies outside the war zone?, ARTNeT Working Paper Series, No. 209, Asia-Pacific Research and Training Network on Trade (ARTNeT), Bangkok

This Version is available at:

<https://hdl.handle.net/10419/243135>

Standard-Nutzungsbedingungen:

Die Dokumente auf EconStor dürfen zu eigenen wissenschaftlichen Zwecken und zum Privatgebrauch gespeichert und kopiert werden.

Sie dürfen die Dokumente nicht für öffentliche oder kommerzielle Zwecke vervielfältigen, öffentlich ausstellen, öffentlich zugänglich machen, vertreiben oder anderweitig nutzen.

Sofern die Verfasser die Dokumente unter Open-Content-Lizenzen (insbesondere CC-Lizenzen) zur Verfügung gestellt haben sollten, gelten abweichend von diesen Nutzungsbedingungen die in der dort genannten Lizenz gewährten Nutzungsrechte.

Terms of use:

Documents in EconStor may be saved and copied for your personal and scholarly purposes.

You are not to copy documents for public or commercial purposes, to exhibit the documents publicly, to make them publicly available on the internet, or to distribute or otherwise use the documents in public.

If the documents have been made available under an Open Content Licence (especially Creative Commons Licences), you may exercise further usage rights as specified in the indicated licence.



If the US-China trade war is here to stay, what are the risks and opportunities for other GVC economies outside the war zone?

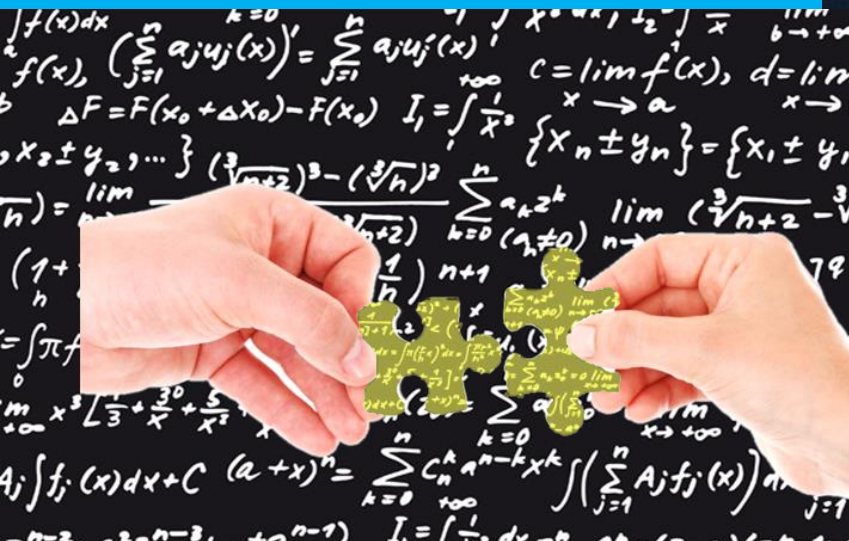

Witada Anukoonwattaka
Pedro Romao
Richard S. Lobo

ASIA-PACIFIC RESEARCH AND TRAINING NETWORK ON TRADE

Working Paper

No. 209 | 2020

The Asia-Pacific Research and Training Network on Trade (ARTNeT) is an open regional network of research and academic institutions specializing in international trade policy and facilitation issues. ESCAP, WTO and UNCTAD, as key core network partners, and a number of bilateral development partners, provide substantive and/or financial support to the network. The Trade, Investment and Innovation Division of ESCAP, the regional branch of the United Nations for Asia and the Pacific, provides the Secretariat of the network and a direct regional link to trade policymakers and other international organizations.

The ARTNeT Working Paper Series disseminates the findings of work in progress to encourage the exchange of ideas about trade issues. An objective of the series is to publish the findings quickly, even if the presentations are less than fully polished. ARTNeT Working Papers are available online at <https://artnet.unescap.org>. All material in the Working Papers may be freely quoted or reprinted, but acknowledgment is requested together with a copy of the publication containing the quotation or reprint. The use of the Working Papers for any commercial purpose, including resale, is prohibited.

Disclaimer:

The designations employed and the presentation of the material in this Working Paper do not imply the expression of any opinion whatsoever on the part of the Secretariat of the United Nations concerning the legal status of any country, territory, city or area, or of its authorities, or concerning the delimitation of its frontiers or boundaries. Where the designation “country or area” appears, it covers countries, territories, cities or areas. Bibliographical and other references have, wherever possible, been verified. The United Nations bears no responsibility for the availability or functioning of URLs. The views expressed in this publication are those of the author(s) and do not necessarily reflect the views of the United Nations. The opinions, figures and estimates set forth in this publication are the responsibility of the author(s) and should not necessarily be considered as reflecting the views or carrying the endorsement of the United Nations. Any errors are the responsibility of the author(s). The mention of firm names and commercial products does not imply the endorsement of the United Nations.



If the US-China trade war is here to stay, what are the risks and opportunities for other GVC economies outside the war zone?

Witada Anukoonwattaka , Pedro Romao, and Richard S. Lobo¹

Please cite this paper as:

Anukoonwattaka, W., P. Romao, and R.S. Lobo. (2021). "If the US-China trade war is here to stay, what are the risks and opportunities for other GVC economies outside the war zone?", **ARTNeT Working Paper Series** No. 209, August, 2021, Bangkok, ESCAP

Available at <https://artnet.unescap.org>

¹ Corresponding author and Economic Affairs Officer, Trade Policy and Facilitation Section, Trade, Investment and Innovation Division, UN ESCAP. Email: anukoonwattaka@un.org. The authors would like to acknowledge useful suggestions and comments from Yann Duval and Preety Bhogal. Nattabhon Narongkachavana provides support on formatting and publishing the paper.

Abstract

Over the last three years, trade tensions between the United States (US) and China have transformed a fairly open bilateral trading environment into a rather protectionist one. The new administration of the United States has maintained most of the bilateral tariffs and non-tariff barriers put in place by the previous administration. Moreover, incentives to diversify trade partners and localisation have been intensified following COVID-19-induced global supply-chain disruptions.

Continuing bilateral trade tensions between the world's largest economic powerhouse can be expected to have significant impacts on the rest of the world. While it is intuitive to conclude that bilateral trade restrictions create new opportunities for others, deep economic interdependence through Global Value Chains (GVCs) complicate matters considerably. Impact assessment needs to consider supply-side relationships between each economy and the two GVC giants. Therefore, in this paper, we develop an analytical framework based on input-output data to assess how existing trade flows will be affected by tariff escalation between the US and China. The aim is to identify potential winners and losers among third-party economies.

More specifically, we used product-level data and a new UN-ESCAP WWZ decomposition technique of MRIO trade in value-added data to (1) model tariff's impacts on US-China bilateral trade and then (2) track how third-countries might be impacted via international supply-chains: both negatively, via lower exports in affected (tariffed) links, as well as positively via enhanced exports demand in alternative ones. We find that the current trade war has been overall positive for third-party economies, shifting US\$ 61.1 billion in net exports away from the US-China link towards other economies. Due to export asymmetries in the US-China bilateral trade relationship, opportunities for third-party economies emerge more from the US tariff imposition than a vice versa. Indeed, our model indicates that the supply-side reconfiguration to avoid US tariffs accounted for more than 80% of third-party economies' gains, equivalent to US\$ 49.5 billion in net exports coming from China to the US diverted. Mexico, Canada, Republic of Korea, Germany and Japan are among the top beneficiaries. Ultimately, lingering trade tensions between the world's two largest economies will continue to pressure international trade downwards, while accelerating pre-existing trends, such as diversification of supply chains.

Keywords: global value chains, trade war, protectionism, trade policy, bilateral trade, tariffs

JEL Codes: C67, F02, F13

Contents

Abstract	ii
1. Introduction	1
2. Background	1
3. Conceptual Framework	10
4. Data and Methodology	15
4.1 Data sources and variables used	15
4.2 Estimating the bilateral trade loss and diverted trade	18
4.3 Risks and opportunities – indicators	19
4.3.1 Pass-through risk from GVC integration with the US	19
4.3.2 Direct risk from demand drop in the US	20
4.3.3 Import substitution opportunity in China:	20
5. Results	22
5.1 China’s retaliatory tariffs	22
5.1.1 Risks	22
5.1.2 Opportunities.....	26
5.1.3 Risks v Opportunities	28
5.2 US tariffs.....	30
5.2.1 Risks	30
5.2.2 Opportunities.....	34
5.2.3 Risks vs Opportunities	37
6. Discussion	38
7. Conclusion	48
List of references	51
Annex A	54
Annex B	56

List of figures

Figure 1 a. US tariffs on China’s exports – timeline	4
Figure 2. US’ implemented tariffs on China’s exports – sectoral coverage, 2018/2021	6
Figure 3. China’s implemented tariffs on US exports– sectoral coverage, 2018/21....	8
Figure 4. The impact of tariffs – partial equilibrium import-export model	11
Figure 5. China’s retaliatory tariffs: Direct and indirect links with US, China and Rest of the World – country i.....	13
Figure 6. Decomposition of value-added in exports.....	16
Figure 7. DVA and FVA as a share of total US exports to China.....	22
Figure 8. Pass-through risk from GVC integration with the US – selected economies	23
Figure 9. GVC pass-through risk from integration with the US as a % of DVA to the World and GDP – selected economies	24
Figure 10. Direct risk from a demand drop in the US as a % of DVA and GDP – selected economies.....	26
Figure 11. Overall opportunity from China’s tariffs – selected economies	27
Figure 12. Total opportunity from China’s tariffs as a % of DVA and GDP – selected economies	28
Figure 13. Opportunity-risk analysis – selected economies (ordered by highest to lowest difference as a % of GDP – not displayed).....	30
Figure 14. DVA and FVA as a share of total China exports to the US.....	31
Figure 15. Pass-through risk from GVC integration with China – selected economies	32
Figure 16. GVC pass-through losses from GVC integration with China as a % of DVA to the world and GDP – selected economies	33
Figure 17. Direct risk from demand drop in China as a % of DVA and GDP – selected economies	34
Figure 18. Overall opportunity from US tariffs – selected economies	35
Figure 19. Overall opportunity from US tariffs as % of DVA to the world and GDP – selected economies.....	36
Figure 20. Opportunity vs Risk analysis – selected economies	38

Figure 21. US and China bilateral relationship – trade-war impact..... 39

Figure 22. Total opportunity vs total risk in billions of US\$ and as a % of GDP – selected economies 41

Figure 23 a. Annual average change in the share of total US outward FDI and total US outward FDI, per country – 2010-19 (selected economies) 43

Figure 23 b. Annual average change in the share of China’s total outward FDI and China’s total outward FDI, per country – 2010-19 (selected economies) 43

Figure A. 1 US' tariffs on China’s exports per industry – escalation 54

Figure A. 2 China’s retaliatory tariffs on US exports per industry – escalation 55

Figure A. 3 Actual and estimated effect of tariffs on bilateral trade between the US and China – 2017 prices..... 56

Figure A. 4 US’s tariffs: Direct and indirect links with China, US and Rest of the World – country i..... 57

1. Introduction

Escalating trade tensions between the US and China – the world’s two largest economies – have left international trade in a precarious position. Indeed, apart from destabilising two of Asia-Pacific’s major import markets,² the conflict indirectly exposed other economies to both risks and opportunities (Anukoonwattaka and Lobo, 2019). As the world endures a particularly turbulent period, Sino-American relations are expected to remain heightened, albeit stable, until the end of 2021 and beyond. While the signing of the Phase I agreement brought some hope of an understanding, the agreement’s limited scope, the emergence of the COVID-19 pandemic, ongoing diplomatic tensions, and the new administration’s stance on China all cast some doubt on the path going forward. Overall, GVCs remain under pressure to restructure in the post-COVID-19 economic environment (ESCAP, 2020). Lingering trade tensions between the world’s two largest economies are accelerating ongoing longer-term trends such as decoupling away from China and diversification, while considerably reshaping the global trade and investment landscape.

In this paper, we analyse the impacts of the US-China trade war on third-party economies, with a special emphasis on Asia-Pacific region economies. In particular, we extended and updated the framework of Anukoonwattaka and Lobo (2019) by using disaggregated trade in value-added data³ to create a simplified model that captures the impacts of the tariff-hike between China and the US.

The paper is structured as follows. Section 2 provides a background and timeline of major trade tensions events between 2017 and March 2020 (latest developments), a glimpse of what might happen next, and an overall analysis of how these tariffs have impacted the US-China bilateral commercial relationship between 2017 and 2019. Section 3 looks at relevant literature and current trends to develop a conceptual framework on opportunities and risks arising from the introduction of tariffs for Asia-Pacific economies. Section 4 presents the data and methodology, while section 5 describes the results. Section 6 discusses our analysis and its limitations. Finally, section 7 offers policy recommendations and key takeaways.

2. Background

The advent of the US-China trade war can be traced back to President Trump’s *America First* stance, which led to increasing protectionism in US trade policies since

² In 2017, the US and China absorbed 16.4% and 13.6% of the region’s exports, respectively (ESCAP, 2020).

³ The disaggregation methodology is developed by UN-ESCAP and trade in value-added data is sourced from the Asian Development Bank Multi-Regional Input-Output (ADB MRIO) database.

early 2018.⁴ However, the so-called US-China trade war commenced in July 2018 when the US unilaterally imposed measures targeted at China.⁵ Since then, China adopted a “tit-for-tat” strategy, issuing retaliatory tariffs at each new round of US added duties. Tariffs have since stabilized following the signing of the Phase-I deal in January 2020 (Box 1). Tensions between US and China remain heightened albeit stable under the new US administration, with frontlines shifting towards strategic competition rather than a trade war. The US’s top concerns are China’s alleged unfair and market-distorting industrial policies and their impacts on national security.

Box 1: A timeline of trade war tariffs*

Since the beginning of July 2018, the US and China have increased bilateral tariffs on each other in four phases: in July/September 2018 (Phase 1), September-2018 (Phase 2), May 2019 (Phase 3) and September 2019 (Phase 4) (Figure 1a, Figure 1b). Thereafter, no major tariffs were additionally imposed.

As a result, the US’ average tariff rate on China’s exports has increased from 3.1% to 19.0%, while China’s average tariff rate on US exports has risen from 8.3% to 21.1%. In practise, the trade war has raised an estimated total worth US\$ 75.5 billion in tariff value** on China’s exports and worth US\$ 21.4 billion in tariff value on US exports. Below, each round of tariffs and the Phase I (PH 1) deal are addressed individually:

- *July and September 2018:* The US implements Phase 1 measures, levying 25% tariffs on US\$ 34.0 and US\$ 19.3 billion worth of China’s exports, respectively (Figure 1a – ‘Phase 1’). This move pushed the US’ average tariff rate on China’s exports by 4.4 percentage points (pp) – to 8.2% – and raised an estimated US\$ 13.3 billion in total tariff value. China retaliated by imposing its own 25% tariffs on US\$ 29.6 and US\$ 15.4 billion worth of US exports, respectively (Figure 1b – ‘Phase 1’), resulting in the single largest average tariff rate increase: 6.1pp, up to 14.4%. Phase 1 added US\$ 11.3 billion in levied duties on US exports.

* This analysis is based on Li’s (2019) CARD Trade Wars Tariffs Database combined with bilateral (US-China) pre-tariff trade data for 2017 from WITS. This chronology reflects all major events up until this paper’s release date.

** The tariff value is an indicative figure calculated by multiplying the weighted average tariff rate

⁴ During the first half of 2018, the US imposed two rounds of import-tariffs on all its exporting-partners: first, in February – safeguard tariffs on solar panels and washing machines under *Section 201* of the *Trade Act of 1974* –, and second in March – 10% to 25% tariffs on steel and aluminium under *Section 232* of the *Trade Expansion Act of 1962*. As a result, China saw roughly US\$ 2.8 billion worth of exports to the US (at pre-tariff prices) being affected by new tariffs. In line with other affected nations, China retaliated after the second-round of US tariffs, in March, by imposing 15% to 25% import-duties on 128 products from the US. These tariffs covered a roughly equivalent US\$ 2.4 billion worth of US exports to China (at pre-tariff prices).

⁵ Under *Section 301* of the *Trade Act of 1974*.

- September 2018:* The US moves forward with a 10% tariff on US\$ 195.6 billion worth of China's exports as a part of Phase 2 (Figure 1a – 'Phase 2'). A matching 5% to 10% retaliation tariff – 7.3% weighted average tariff rate – on US\$ 53.4 billion worth of US exports ensues in China (Figure 1b – 'Phase 2'). During Phase 2, the US raised its overall average tariff rate to 12.0% (3.8pp up) and the total trade war tariff value to US\$ 33.4 billion (US\$ 19.6 billion more), while China did so to 18.3% (3.9pp up) and US\$ 15.7 billion (US\$ 3.9 billion more), respectively.
- May 2019:* After months of negotiations broke down, the US moved forward with its largest tariff increase so far: 15% on US\$ 195.6 billion worth of previously tariffed China's exports (Figure 1a – 'Phase 3'). This resulted in a record 5.6pp jump in the US' average tariff on China's exports and on an additional US\$ 29.3 billion bill in tariff value, now totalling US\$ 62.7 billion. Accordingly, China responded with tariffs ranging from 5% to 15% tariffs – 10.2% on average – on a US\$ 35.5 billion subset of the September 2018 list (Figure 1b – 'Phase 3'). This raised once again the average tariff on US exports to 20.7% (4.2pp up), which had, prior to this, declined to 16.5% due to China's decision to cut its Most Favoured Nation (MFN) tariffs towards all WTO members. The total value of additional duties on US exports rose to US\$ 19.3 billion, US\$ 2.9 billion more.
- September 2019:* In the latest escalation of the conflict so far, the US' Phase 4 brought 15% tariffs on US\$ 145.1 billion worth of China's exports, while China responded with extra 5% to 10% tariffs – 7.3% added average tariff – on US\$ 26.7 billion worth of US exports. This move added US\$ 21.8 billion and US\$ 2.1 billion in export tariff value towards China's and US exports, respectively, and set the corresponding average tariff rate at 21.0% and 21.1%, respectively. Moreover, both nations pledged to impose further tariffs on December 15th to exert pressure on ongoing negotiations. On the one hand, the US planned to move forward with 15% tariffs on US\$ 162.5 billion worth of China's exports. On the other hand, China announced 5% to 10% extra tariffs – at 7.1% average – on US\$ 45.5 billion worth of US exports (Figure 1b – 'Phase 4').
- December 2019:* Ahead of the imposition of the December 15th scheduled tariffs, on December 13th, the US and China announced a pre-emptive agreement to halt any upcoming tariffs from coming into effect (Figure 1a – 'PH I Announced'). For that reason, previous plans that would have set the US' average tariff rate on China's exports at a whopping 23.8% and China's at 25.1% were suspended. This agreement also avoided US\$ 24.4 and US\$ 3.2 billion in tariff value on Chinese and US' exports, respectively, from coming into effect.

January 2020 -present: On January 15th, a Phase I deal was signed by both nations, marking a cease-fire on the ongoing trade war. According to USTR (2020), the deal included a 7.5pp decrease in US tariffs previously applied on US\$ 120.0 billion worth of China’s exports – from 15.0% to 7.5% –, while China pledged to steadily increase its purchases of US exports by US\$ 200 billion over the next 2 years. As a result, the current deal slightly eased the US’ tariffs on China’s exports from 21.0% to an estimated 19.0% and is expected to produce mild impacts on the weighted average tariff rate applied on US exports. All in all, the Phase I deal is expected to produce little impacts on the current situation with more significant advances pushed to later negotiations (Figure 1a – ‘PH I signed’, Figure 1b – ‘PH I signed’).

Figure 1 a. US tariffs on China’s exports – timeline

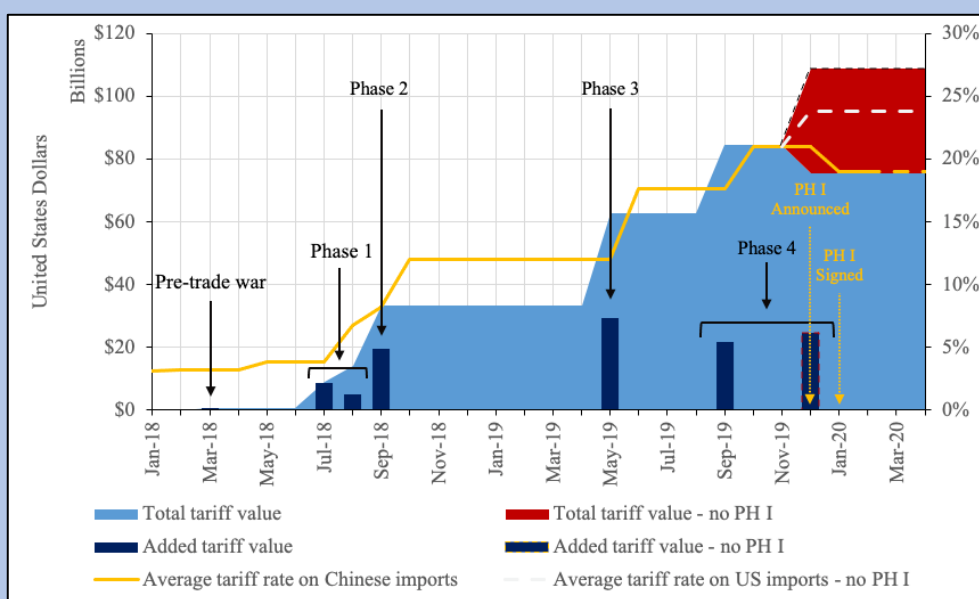
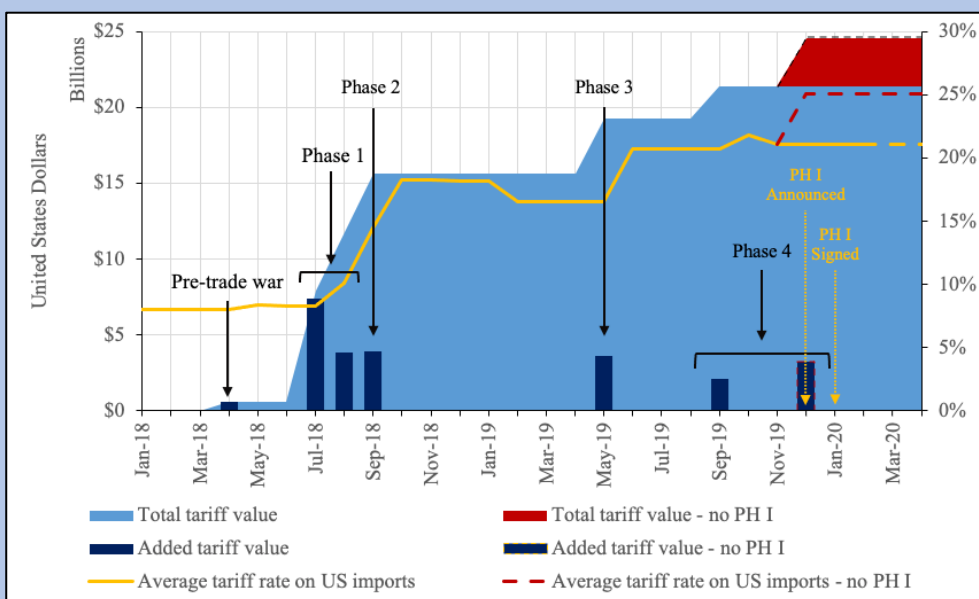

Figure 1b. China’s retaliatory tariffs on US exports – timeline



Source: Average tariff rate on Chinese (Figure 1a) or US (Figure 1b) exports – Bown (2019) up to 'PH I Signed' and authors based on USTR (2020) after; Total tariff value and Added tariff value – authors, based on CARD Trade War Tariffs Database and on 2017 product-level international bilateral trade data obtained from WITS Database (accessed January, 2020).

Notes: PH I corresponds to the Phase I deal. "No PH I" corresponds to the scenario where suspended and rolled back tariffs would be implemented (Annex A.). The Average tariff rate on China's exports is weighted by China's exports to the world in 2017. Likewise, the Average tariff rate on US exports is weighted by the US'. Since April 2020 no new developments to the situation portrayed occurred.

US' tariffs

Roughly 74% of China's exports to the US and 14% to the world are affected by the increase in tariffs. The weighted average tariff rate for China's exports to the US increased from 3.1% in 2017 to 19.1% in 2020 (after the Phase I deal). In the event of a further escalation – i.e., implementation of the second round of Phase 4 and rolled back tariffs from previous phases –, the average tariff rate on China's exports would be pushed to a record 25.1%, while covering 97.4% of the total import value from China.

China's exports to the US are mostly concentrated in 4 industries – Electrical and optical equipment, Machinery, Manufacturing, and Textiles. These sectors account for roughly 70% of both China's exports to the US and of the total tariff value (figure 2). Apart from a few exceptions, the average tariff rate per industry hovers around the overall 19% average tariff rate, with most sectors being almost entirely covered by new trade war-tariffs (86% average coverage rate).

The Electrical and optical equipment industry has been hit the hardest. The industry, capturing the largest share in total export value (40% of China's exports to the US – green dash in figure 2), is tariffed at a slightly above average 20.8% (yellow diamond in figure 2). Despite the sector's low coverage ratio – only 59% of the sector's imports' value is under new tariffs –, this industry represents 44% of the total tariff value (red dash in figure 2). In practice, this means that while large trade volumes in the sector remain un-tariffed (41%), exports that are tariffed are so at a much higher 35% average rate.

Next, the Machinery industry follows, registering a 22.9% average tariff rate and a 13% share of the total tariff value (compared with a 10% share of China's total exports). Lastly, the Manufacturing and Textiles sectors – combined, accounting for 22% of China's exports to the US – have thus far avoided the tariff hike, bearing together only 13% of the total tariff burden and enjoying the lowest tariff rates of all: 12.6% and 9.3%, respectively.

Figure 2. US' implemented tariffs on China's exports – sectoral coverage, 2018/2021⁶

(Billions of US\$ / %)

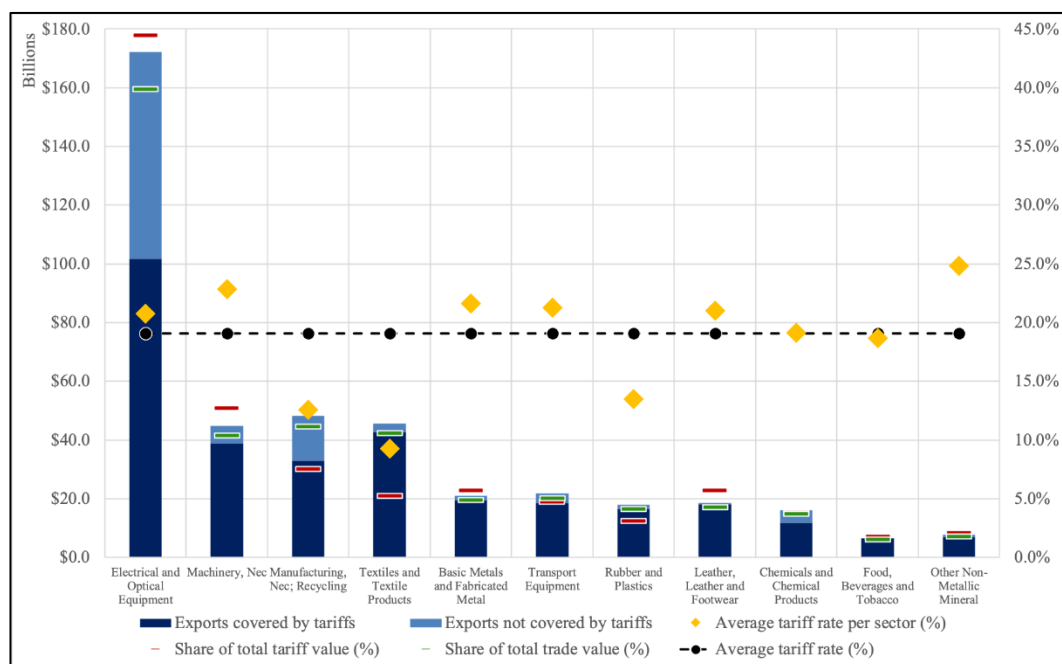

Source: Authors, based on CARD Trade War Tariffs Database and on 2017 product-level international bilateral trade data obtained from WITS Database (accessed April 2020).

Notes: Herein all tariffs implemented and in-force during the period 2018/21 are represented (PH I deal included). The *Average tariff rate* is aggregated at the sector level. *Share of total tariff value* is calculated as the product of a sector's export value in 2017 with the corresponding average tariff rate divided by the total tariff value for all sectors. Sectors are ordered by descending *Share of tariff value*. For brevity, all sectors with negligible tariff coverage (<2%) were excluded from the figure. Sectoral classifications follow ADB MRIO database nomenclature.

In case of a further escalation – i.e., implementation of the second round of Phase 4 and rolled back tariffs from previous phases –, all sectors apart from Transport equipment and Chemical products – each with 85% and 75% tariff coverage ratio, respectively – would become fully covered under the new tariffs. Moreover, average tariff rates per industry, now ranging between 9.3% and 32.5%, would sharply increase to span between 20.9% and 40%. For instance, in the Electrical and optical equipment sector, the average tariff rate would climb to 30.0% (9.2pp increase), in Machinery to 27.2% (4.4pp), in Manufacturing to 22.6% (10.0pp) and in Textiles to 20.9% (11.7pp).

⁶ In this analysis we utilise HS – ADB MRIO concordances to classify each product into a sector. We then calculate the value of tariffs on each product and aggregate them by sector. The absolute value of the tariffs for each sector is then scaled as a percentage of the total value of tariffs. All current tariffs imposed between Jan-2018 and April 2021 were included.

All other sectors would experience a roughly proportional increase in their average tariff rate to match the 6.6pp overall tariffs increase⁷.

In its entirety, we estimate that US tariffs on China have contributed to a 19.5% drop⁸ in the quantity of China's exports to the US (or US\$ 85.4 billion at 2017 prices and exchange rates).⁹ Would second round Phase 4 tariffs come into effect, this reduction could reach 25.9% or US\$ 113.2 billion (at pre-trade war 2017 prices).¹⁰

China's retaliatory tariffs

China's retaliatory tariffs have covered 75.0% of US exports to China and 6% to the world. These tariffs have raised the weighted average tariff rate for US exports to China from 8.0% to 21.1%. If the second round of Phase 4 were to take place, 90% of all products would then become tariffed at an average rate of 25.1%.

China's retaliatory tariffs vary widely across US exporting sectors: from 7.4% to 36.1%. Currently, these are mainly concentrated in Transport equipment and in Agricultural, hunting, forestry and fishing goods, which recorded the highest average tariff rates of all: 36% and 32%, respectively. Furthermore, these sectors comprised of over 50% of the total tariff value despite only accounting for 32% of US exports to China (figure 3). Moreover, Food, beverages and tobacco (30% average tariff), Coke, refined petroleum and nuclear fuel (25%) and Wood and products of wood and cork (25%) also saw high tariffs being imposed during the trade war.

On the other hand, other important sectors where China's GVCs are heavily integrated with the US have been relatively spared from very high tariffs in China. These include Electrical and optical equipment (18% of total US exports to China), Chemicals and chemical products (15%), and Machinery (8%), which so far have endured an extra 11%, 14%, and 16% average tariff rates, respectively, while only bearing 26% of the total tariff burden (compared to 41% of US exports to China).

⁷ See Annex figure A.1.

⁸ This figure is calculated as per the methodology described in equation (1) (section 4.3). More specifically, equation (1) uses import-price elasticities to compute the impact of tariffs on the volume of China's exports to the US (assuming a full pass-on of tariffs to US buyers, as explained in our Conceptual Framework – section 3).

⁹ Note that the mentioned reduction refers to export quantity – not value ($Value = P * Q$). This is due to the fact that when tariffs are applied it remains unclear whether the overall trade value actually rises or drops: tariffs drive prices up as the final purchasing price increases, while quantities go down due to this price hike. For that reason, prices are always kept at constant (pre-trade war) 2017 levels for a volume – i.e., *real* (as opposed to nominal) – comparison across years.

¹⁰ Figure A.3 compares the estimated reduction in trade calculated as per the methodology described in footnote 7 and reported herein with actual reported bilateral trade data deflated to 2017 prices. The similarity between our estimation of the trade fall and actual trade developments suggest that (1) tariffs are the main driver behind the downward trend in bilateral trade, (2) tariffs are almost completely being passed on to the demand and (3) our estimates used are a good proxy for the current situation. Our estimates are also in line with Nicita's (2019).

Figure 3. China’s implemented tariffs on US exports– sectoral coverage, 2018/21¹¹

(Billions of US\$ / %)

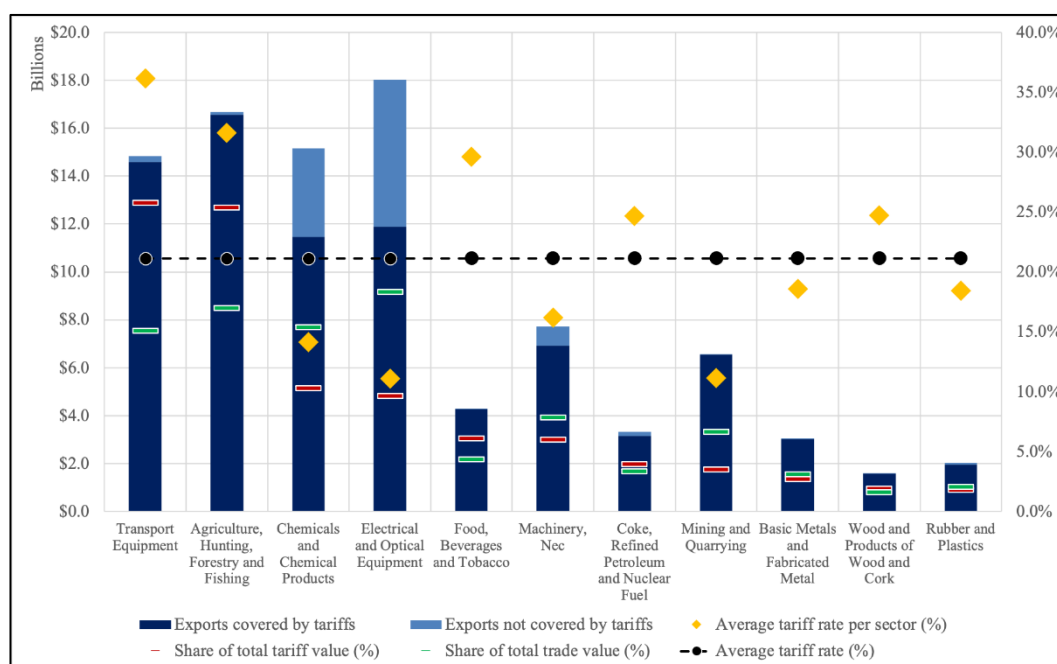

Source: Authors, based on CARD Trade War Tariffs Database and on 2017 product-level international bilateral trade data obtained from WITS Database (accessed April 2020).

Notes: Herein all tariffs implemented during the period 2018-2021 are represented (PH I deal inclusive). The *Average tariff rate* is calculated as explained above but aggregated at the sector level. *Share of total tariff value* corresponds to the share of tariff value in a specific sector, where the tariff value is calculated as the product of a sector’s export value in 2017 with the corresponding average tariff rate. Sectors are ordered by descending *Share of tariff value*. For brevity, all sectors with negligible tariff coverage (<1%) were excluded from the figure. Sectoral classifications follow ADB MRIO database nomenclature.

In the event of a further escalation – i.e., Phase 4 tariffs being imposed – Transport equipment would be the sector suffering the most: its average tariff rate would increase by 9pp, reaching 45%. Moreover, other sectors would experience a 1 to 3 percentage points increase in the average tariff rate applied, while the distribution of each sector’s share of total tariff value would remain unchanged at current values¹² (Figure A.2).

Overall, we estimate that China’s retaliatory tariffs have directly contributed to a 16.0% drop (US\$ 19.9 billion at 2017 prices and exchange rates) in the quantity of US exports

¹¹ In this analysis we utilise HS – ADB MRIO concordances to classify each product into a sector. We then calculate the value of tariffs on each product and aggregate them by sector. The absolute value of the tariffs for each sector is then scaled as a percentage of the total value of tariffs. All current tariffs imposed between Jan-2018 and this paper’s release date were included.

¹² See Annex figure A.2.

arriving in China.¹³ In the event of a further escalation (i.e., Phase 4 tariffs), this reduction could peak at about 18.3% or US\$ 22.7 billion (2017 prices).

Going forward post COVID-19

As of April 2021, US-China tensions remain heightened, albeit stable tariffs. While the signing of the Phase I agreement in January 2020 brought a small relief in US tariffs and some hope of an understanding, the agreement's limited scope and the ongoing diplomatic tensions between the US and China have all cast several doubts on the path moving forward

First, the Phase I agreement signed in January 2020 did not cover contentious issues like subsidies, technology transfer or the treatment of state-owned enterprises, among others (Olson, 2020). Moreover, as the emergence of the COVID-19 pandemic has delayed China's compliance to purchasing roughly US\$ 200 billion worth of US products (Phase I obligations), the adherence of both countries to the agreement is uncertain (Olson, 2021a).

Second, bilateral tensions between the US and China have grown over an array of multiple issues. On the commercial front, the US has doubled-down on its tech war against China's giants, imposing further restrictions on electronic and chip manufacturers such as Huawei as well as services providers such as Tik Tok and WeChat. On the diplomatic front, the national security law imposed over Hong Kong, China led the US to react by closing its consulate in Chengdu, suspending or terminating 3 bilateral agreements relating to extradition and tax exemptions with Hong Kong, China, among others measures (Feng, 2020; Swanson, 2020). On top of this, the US recognition of China's handling of the Uighurs in Xinjiang as genocide has added further strain to the already weakened bilateral relationship. All in all, the cumulative effect of these escalations has tainted any hopes for resuming bilateral negotiations on the trade war.

Lastly, while President Biden's administration has stated that returning to multilateral forums is a priority, the recently passed '*Buy American*' executive order and President Biden's campaign plan '*Made in All of America Plan*' – a form of so-called *soft protectionism* – highlights that reverting tariffs to a fairly liberalized trade environment with China might not be a key priority. Indeed, while it is highly unlikely that further tariffs will be imposed on China, a '*U*' turn should also not be expected as the current administration might use imposed tariffs as bargaining chips for future negotiations on issues such as climate change, trade policy, human rights abuses or the South China Sea disputes (The Economist, 2020).

¹³ This figure is calculated as per the methodology described in section 4.3. More specifically, equation (1) is further aggregated across all exporting sectors to compute the total drop in US exports to China.

Ultimately, the trade war is now expected to enter a steady-state, where high tariffs become the new normal for the foreseeable future. However, given the unpredictable nature of international relations and the turbulent moment for the world economy, developments in this dispute could happen at any time and swiftly.

3. Conceptual Framework

Tariffs are a protectionist tool designed to curb buyers' incentives away from specific imported goods. In an interlinked world, where the production of goods and services is carried out in different countries, a bilateral trade war could have significant impacts on third-party countries. Indeed, as trade between the US and China dampens, countries involved in tariff-affected GVCs will end up suffering from foregone activity. However, as part of the lost trade is redirected to other countries, an opportunity to seize some of it also arises.

In this section, we develop a conceptual framework to evaluate the risks and opportunities arising from trade war tariffs. This conceptual framework will form the basis of our analytical approach and is adapted, extended and updated from Anukoonwattaka and Lobo (2019).

First, to understand the potential negative impacts of tariffs on third-party nations, it is necessary to look at their direct effects on bilateral trade. As conventionally, we will be drawing on a partial equilibrium (demand-supply) model under perfect competition to reveal the influence of tariffs on trade (Amiti, Redding, & Weinstein, 2019). As Figure 4 shows, upon the introduction of a new tariff, the supply curve shift upwards (s') by the same amount as the tariff introduced. As a result, the equilibrium price increases from P_0^* to P_1^* and the quantity traded between both economies falls from q_0 to q_1 (demand-supply intersection).

However, depending on the slope of the supply curve, two situations can ensue: Panel (a) illustrating an elastic supply curve and Panel (b) reflecting a perfectly elastic (horizontal) one.¹⁴ While in the left panel, the supplier absorbs some of the tariff burden by reducing the export price on each unit sold¹⁵ – i.e., the export price after tariff (P_1^e)

¹⁴ The supply curve's price-elasticity measures how much output varies (in percentage terms) given a 1% price change. In other words, it measures whether markets will tend to absorb exogenous shocks more via price or quantity fluctuations. Whether a supply-curve is more or less elastic depends on a variety of factors such as the number of players in the market, inputs' availability and substitutability, cost structures, technology, among others. Below a further

¹⁵ The export price – i.e., the price received by the exporter – can be identified along the green curve s . In particular, the export price is given by the intersection of the quantity supplied – q_1 after tax and q_0 before – with the supply curve (s). Before tariffs, the price paid by the consumer (P_0^*) is the same as the price received by the exporter (P_0^e) since no other entity is involved in this transaction. However, after tariff, the price received by the exporter is now different from the price paid by the consumer (P^*) since the state now requires the tariff to be paid on each transaction: the consumer pays $P_1^e + t$ – i.e., the after-tariff equilibrium price P_1^* – the supplier receives P_1^e and the state t .

is smaller than before (P_0^e) –, in the right panel, the tariff burden is fully passed on to the buyer and export prices remain unchanged – i.e., the exporting price is the same both before and after the imposition of tariffs ($P_1^e = P_0^e$). As a result, the equilibrium price, given by the intersection of the demand curve d with the supply curves s (before tariff) or s' (after tariff), in panel (a) increases by a smaller amount – ($\Delta P < t$) – than in panel (b), where the price increase matches exactly the tariff imposed ($\Delta P = t$). Thus, the quantity traded between both nations also drops significantly less in panel (a) when compared to panel (b), as ($q_0 - q_1$) illustrate.

Accordingly, determining the elasticity of the supply curve is vital to understand how much of the tariff's burden is being passed-on to the importers, as well as the extent of the trade loss between both nations. Naturally, the elasticity of the demand curve (slope of the demand curve) is also needed to estimate the extent of the trade loss. However, no assumptions or need to be made in this regard since this paper uses HS6 product-level – country-specific – price import elasticities, available from the World Bank (2012) database as described below in section 4.

Figure 4. The impact of tariffs – partial equilibrium import-export model

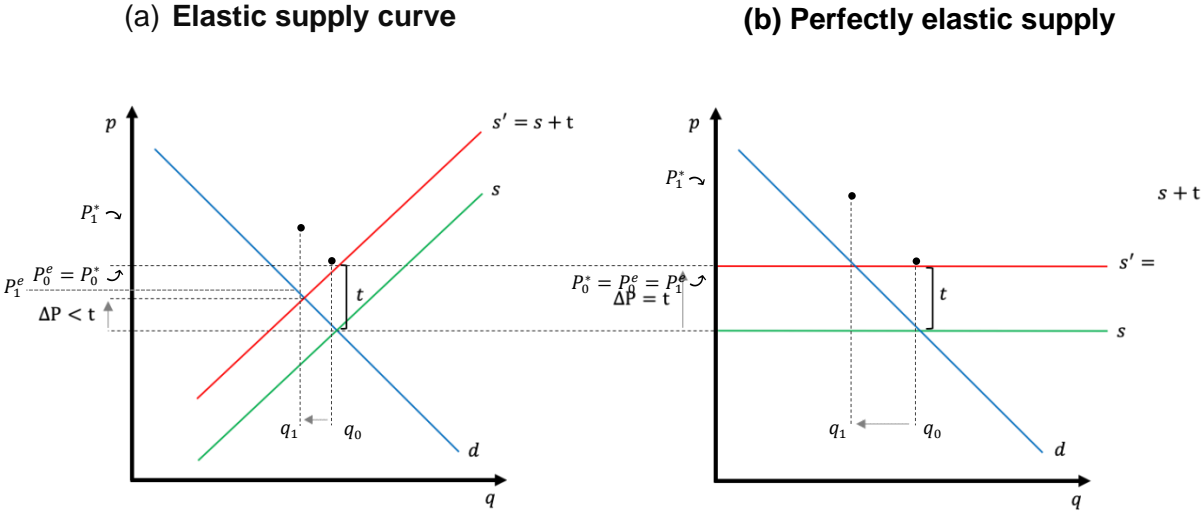

Source: Authors based on Amiti, Redding, and Weinstein (2019).

Notes: The horizontal axis represents the exported quantity (q); the vertical axis represents the import price (p), s stands for the supply curve, s' for the after-tariff supply curve (given by the sum of the previous supply curve and the tariff), d for the demand curve and t stands for tariff. P^e stands for exporting price and represents the price received by the exporter. P^* stands for equilibrium price and represents the market price or the price paid by the importer (buyer). The subscripts 0 and 1 represent the initial and the after-tax situation, respectively.

While a fully elastic supply curve virtually does not exist since suppliers will not completely halt production due to a marginal price fluctuation,¹⁶ a close to fully elastic one illustrates a market under perfect competition, where many players supply the same or alternative products, all share similar cost structures and technologies and operate close to the break-even point with little room for absorbing shocks via price changes.

As most research on the US-China trade war has empirically verified, the current situation is largely consistent with Panel (b) – i.e., a perfectly elastic supply curve (Amiti, Redding & Weinstein, 2019; Nicita, 2019). This means that international supply markets behave as almost perfectly competitive – i.e., many undifferentiated players operating at close to breakeven and thus with little margin to absorb additional tariff costs (Amiti, Redding & Weinstein, 2019; Nicita, 2019). For that reason, in this paper, we are going to follow the relevant literature and assume a fully elastic supply curve (Amiti, Redding & Weinstein, 2019; Nicita, 2019). This implies that consumers will be facing a price change equivalent to the tariff imposed – as shown in Panel (b) – and that the trade loss will be the highest possible for the imposed tariffs.

However, as Amiti, Redding and Weinstein (2019) and Nicita (2019) explain, this is likely to reflect a short-run situation as in the medium-run businesses are likely to gradually bear some of the tariff burden by restructuring production processes and sale contracts. Accordingly, the medium to long-run supply curve should lie somewhere in between Panels (a) and (b) as a largely elastic, but not perfectly elastic, supply curve. The situation portrayed herein can thus be understood as an accurate representation of a short-run situation.

Next, to estimate countries' opportunities, it is necessary to quantify how much of the foregone trade modelled in figure 4 is redirected abroad. Accordingly, in this paper, we drew from Nicita (2019), who estimated that, on average (across exporting sectors), 63% of the export loss verified in China was picked up by foreign economies. This means that of the estimated US\$ 85.4 billion in China's foregone exports to the US,¹⁷ US\$ 31.6 billion was effectively lost due to market inefficiencies and rigidities, while US\$ 53.8 billion was absorbed by other countries.

Despite Nicita's (2019) US-specific estimate, Doifode and Narayanan (2020) found that China's exports to the US are less substitutable than the converse (lower demand price import elasticity). This suggests that by considering the same figure for analysing both US' and China's tariffs, we are underestimating third-countries' opportunities with regards to the latter. Putting this into perspective, the effective opportunity for third-countries arising from China's tariff imposition is estimated to be at least US\$ 12.5

¹⁶ Furthermore, 'real world elasticities' are bounded to be finite, albeit possibly very large, numbers due to the estimation methods used to calculate them.

¹⁷ This figure is calculated as per the methodology described in section 4.3. More specifically, equation (1) is further aggregated across exporting sectors to compute the total drop in China's exports to the US.

billion, with US\$ 7.4 billion in US exports to China effectively lost (from the estimated US\$ 19.9 billion forgone US exports to China)¹⁸.

Last, it is necessary to identify possible international trade and GVCs channels through which tariffs might propagate the above-mentioned risks and opportunities to other economies. For brevity and clarity, in the main text, we will be only reviewing the current conceptual framework through the lenses of China’s retaliatory tariffs. For the US, the conceptual framework is symmetric and can be found in Annex B.

Figure 5 illustrates all relevant GVCs and international trade linkages through which tariffs might propagate to third-party nations. First, it lays out all of a general country *i*’s direct commercial relationships with the US (‘1. X_USA’), China (‘4. X_PRC’) and the Rest of the World (RoW) (‘5. X_RoW’). Second, it identifies relevant subsets of X_USA and X_RoW, such as ‘2. FVA_USA_PRC’ and ‘6. FVA_RoW_PRC’ – intermediates used in the production of exports to China through the US and RoW, respectively –, or ‘3. Exports to the US consumed domestically’. Third, ‘7. GVCs substitution as exporting country’ and 8. ‘GVCs substitution as a source country’ symbolize tariff-induced supply-side changes, where the former denotes businesses moving from the US to country *i* and the latter to other countries.

Figure 5. China’s retaliatory tariffs: Direct and indirect links with US, China and Rest of the World – country *i*

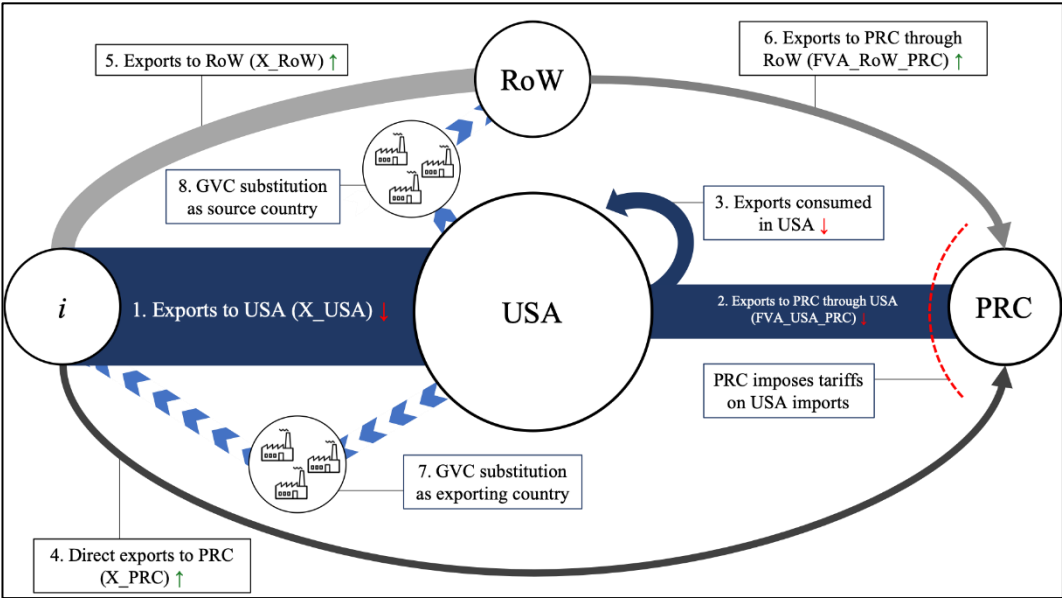

Source: Authors.

Notes: PRC stands for People’s Republic of China, USA for United States of America, and RoW for Rest of the World, as per the MRIO nomenclature used in this paper.

¹⁸ This figure is calculated as per the methodology described in section 4.3. More specifically, equation (1) is further aggregated across exporting sectors to compute the total drop in US exports to China.

Drawing from the figure above and from the perspective of China's tariffs, two main risks and one main opportunity can be identified for a generic country i :

1. *Pass-through risk from GVC integration with the tariffed economy;*
2. *Direct risk from demand drop in the tariffed economy;*
3. *Import substitution opportunity in the economy imposing tariffs.*

Risks

From the perspective of a third-country, China's retaliatory tariffs are passed-through country i 's exposure to the US:

1. *Pass-through risk from GVC integration with the US:* As the demand for tariffed US goods drops in China (as shown in Figure 4), country i faces a reduction in its intermediate exports to the US used for the production of further exports consumed in China (FVA_USA_PRC ↓).¹⁹
2. *Direct risk from demand drop in the US:* As tariffs negatively affect the US' economic performance, exports consumed domestically are expected to decrease proportionally to the drop in domestic demand (3. ↓).

Therefore, economies that are highly integrated with the US, either through GVCs to China or through the US domestic market, stand to suffer the most with imposed tariffs.

Opportunities

On the other hand, as China's tariffs hamper trade with the US, country i can become a potentially attractive partner by substituting the US in the supply chain:

3. *Import substitution opportunity in China:* Country i may see an increase in its direct exports to China (X_PRC↑) due to China's immediate substitution of US exports. Moreover, in the medium run, firms relying on China as an important market might look to relocate production outside of the US, further adding to country i 's increase in direct exports to China (X_PRC↑). On the other hand, depending on its connection to other nations who will benefit from enhanced exports to China, country i may also see an increase in its indirect exports to China through these other nations (FVA_RoW_PRC↑).

Accordingly, economies well integrated with China, either directly or indirectly through other countries, stand to benefit the most from redirected trade and investment.

¹⁹ Moreover, potential downward adjustment in export prices may happen if, ultimately, the tariff causes excess supply in the global market, limiting even further the decrease in export revenue of country i .

Ultimately, whether a country will benefit or lose from the current situation will depend on which of the forces above prevails. In this paper, we will be analysing each of the risks and opportunities individually, as well as together, to compute the overall effect of the trade war.

4. Data and Methodology

In this section, we provide details on the variables and data sources used, as well as a technical description of the indicators constructed in this paper at the country level from the perspective of China's retaliatory tariffs. Due to a high degree of similarity, and to avoid repetition in the main text, the methodology from the perspective of US tariffs can be found in Annex C.

4.1 Data sources and variables used

Uncovering the potential risks and opportunities for third-party countries requires the analysis of inter-country input-output (ICIO) tables. This study draws on trade in value-added data extracted from the Asian Development Bank's Multi-Regional Input-Output (ADB MRIO) database. The ADB MRIO database (accessed April 2020) contains data on bilateral trade in value-added between 62 economies, 28 of which are located in the Asia-Pacific region, as well as with the rest of the world (RoW) as an aggregate. The database provides information about the value-added exports of these economies, disaggregated across 35 sectors and decomposed into seven components as per the theoretical framework developed by Wang et al. (2018). Figure 6 represents each of these components from the perspective of a general exporter i .

Figure 6. Decomposition of value-added in exports

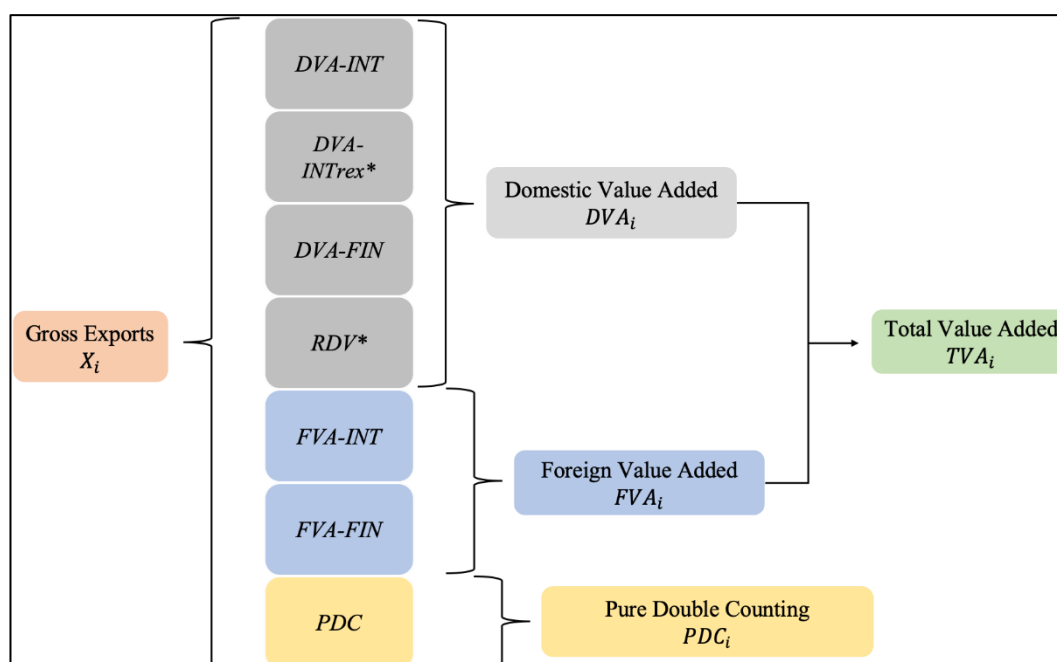

Source: Authors' adaptation of Wang et al. (2018).

Notes: *As explained below, $DVA_{INT_{Trex}}$ and RDV terms were replaced by equivalent FVA terms.

Additionally, this paper uses a pioneering decomposition methodology developed by ESCAP that breaks down the FVA term into a detailed 3-country production network (source, exporting, and importing country), instead of the commonly used 2-country one (exporting and importing country). By doing so, we were able to track trade in value-added flows between US, China and third-party economies as in the simplified 3-country model described above.

Looking at each of the components in Figure 6, three main categories of value value-added should be differentiated: (1) Domestic Value Added (DVA), (2) Foreign Value Added (FVA), and (3) Pure Double Counting (PDC).

As the name suggests, the first group of terms comprises all the value-added produced at home and used in country i 's exports. DVA_{FIN} is DVA in final exports directly consumed by the importer, DVA_{INT} is DVA in intermediate exports used to produce final goods consumed by the importer, $DVA_{INT_{Trex}}$ is DVA in intermediate exports used by the importer for producing further exports to be consumed in a third-country abroad, and RDV (Returned Domestic Value added) is DVA in intermediate exports used by the importer for producing further exports consumed by the initial exporter (country i).

The second group (FVA) comprises all value-added produced by other countries and used in country i 's exports to be consumed by the importer. FVA_{INT} is FVA in intermediate exports consumed by the importer and FVA_{FIN} is FVA in final exports

consumed by the importer. From the importer's point of view, DVA and FVA together represent total value-added in country i 's exports. In the context of a trade war, total value-added is fully tariffed by the importer.

Conceptually, FVA, RDV and DVA_INTrex are intimately connected. Indeed, all these rubrics encompass value-added moving across multiple borders. However, whereas the first two look at value addition through forward-linkages, the latter does so through backward-linkages. In other words, in a three-country model – with source, exporting, and importing country – DVA_INTrex and RDV from the source country correspond to FVA from the source country measured in the exporting country.²⁰ Accordingly, to maintain data consistency throughout the paper, DVA_INTrex and RDV terms were substituted by FVA ones, equivalently measuring the same flow.

The third group, Pure Double Counting Terms (PDC) encompass value-added from goods that cross borders multiple times and are thus registered more than once in gross exports. Since this paper is concerned with value-addition processes, PDC terms are excluded from all our analysis.

Additionally, this paper uses HS6 product-level – country-specific – price import elasticities, available from the World Bank (2012) database, to understand the bilateral drop in demand due to tariffs imposition. As per the usual statistical convention, t -statistics were calculated for each observation and only statistically significant ones at the 5% level of significance were selected.²¹

Finally, we follow Nicita's (2019) estimate of trade diversion on China's exports to the US and assume the same figure to hold for US exports to China. The author compared the drop in tariffed exports from China to the US at the product-level (HS8 aggregation) from the first two quarters of 2018 and 2019 with the increase in these products exports to the US coming from other countries (controlling for existing trends) to determine the tariff-induced diversion of foregone bilateral trade. As mentioned in section 3, assuming the same trade diversion index for both Chinese and US exports amounts to underestimating opportunities arising from the imposition of China's tariffs since China's exports to the US are less substitutable than the converse. However, given the relative size of the estimated opportunities²² arising from US tariffs – US\$ 53.8 billion

²⁰ On a world aggregate analysis, forward-linkage measures are roughly – but not precisely – equivalent to backward-linkage ones. In fact, while RDV is completely encompassed within FVA terms, DVA_INTrex is almost, but not completely encompassed within FVA. This has to do with the theoretical framework underlying the computations of each of these rubrics and that is why FVA substitutes DVA_INTrex and RDV in our analysis.

²¹ $t - statistic = \frac{\hat{\epsilon}}{s(\hat{\epsilon})}$, where $\hat{\epsilon}$ is the estimated mean elasticity and $s(\hat{\epsilon})$ is the standard deviation from the same distribution. A normal distribution ($n \rightarrow \infty$) was assumed to be followed given the large number of observations used. Thus, the cut off for 95% confidence level was set at the corresponding $t - statistics < -1.645$.

²² This figure is calculated as per the methodology described in section 4.3. More specifically, equation (1) is further aggregated across all exporting sectors to compute the total drop in US exports to China and *vice-versa*.

– and China’s – US\$ 12.5 billion – it is unlikely that the underestimation of the latter will produce significant effects in our analysis.

4.2 Estimating the bilateral trade loss and diverted trade

As mentioned above, this paper estimates both the extent of the bilateral trade loss and diverted trade to contextualize and compare each of the risks and opportunities indicators between themselves, as well as between the ones from US and China’s tariffs.

To compute the tariff-induced drop in US exports to China per sector, we looked at the product import price elasticities for each HS6 product and multiplied it by the sum of the given product’s tariff increases (the percentage price change), as per the assumption explored in section 3 of a full-pass on of the tariff’s burden to the buyer (1):

$$\Delta \% X_USA_PRC_e = \frac{\sum_h \varepsilon_{h,e}^m * tariff_{h,e} * X_USA_PRC_{h,e}}{\sum_{h,e} X_USA_PRC_{h,e}} \quad (1)$$

where, $\Delta \% X_USA_PRC_e$ is tariff induced percentage drop in US exports to China (X_USA_PRC) in exporting sector e , $\varepsilon_{h,e}^m$ is China’s import elasticity for product h in exporting sector e and $tariff_{h,e}$ is the sum of all trade-war tariff increases on product h in exporting sector e , and $X_USA_PRC_{h,e}$ is US exports to China of product h in exporting sector e . Equation (1) can be further aggregated at the country level to estimate total US exports to China lost. To compute the dollar value of US exports to China lost in sector e , one can simply multiply equation (1) by $\sum_h X_USA_PRC_{h,e}$ to cancel out the denominator.

Next, to calibrate redirected trade as an opportunity for third-party countries, we looked at the share of tariff-induced US exports to China lost that were absorbed by third-countries. To do so, we followed the conceptual framework laid down in section 3 and multiplied the percentage change in US exports to China – as in (1) – by the Nicita (2019) trade diversion index.

$$\Delta \% X_USA_PRC_e^{redirected} = \bar{\theta}_e * \Delta \% X_USA_PRC_e \quad (2)$$

where $\bar{\theta}_e$ – the trade diversion index in sector e – is a constant corresponding to the overall weighted average of 63%. Equation (2) can be further aggregated at the country level to estimate total US exports to China absorbed abroad. To compute the dollar value of US exports to China absorbed abroad in sector e , one can simply multiply equation (2) by $\sum_h X_USA_PRC_{h,e}$.

4.3 Risks and opportunities – indicators

4.3.1 Pass-through risk from GVC integration with the US

In this paper, we looked at indirect GVC pass-through risks to correctly map which countries and industries are most likely to withstand the largest indirect burden from tariffs imposed on the US.

Particularly, we studied country i 's exposure to US exports to China to understand how weakening trade might indirectly affect said country i . To do so, we computed the share of FVA (imported content) arriving in China through the US, weighted by each exporting sector's estimated drop in demand, with the total value added (TVA) arriving at China from the US, also weighted by each exporting sector's estimated drop in demand. In other words, this index measures source country i 's participation in lost exports to China passing through the US as a share of total foregone US exports to China. Accordingly, the *Indirect risk (%)* presented in (3) can be interpreted as country i 's exports loss as a share of the decrease in US exports to China:

$$Indirect Risk_i(\%) = \frac{\sum_e \left[\left[\sum_s FVA_USA_PRC_{\{i,s,e\}} \right] * \Delta \% X_USA_PRC_e \right]}{\sum_e TVA_USA_PRC_e * \Delta \% X_USA_PRC_e} \quad (3)$$

where, $FVA_USA_PRC_{\{i,s,e\}}$ represents FVA arriving in China through exporting sector e via the US from source country i and source sector s , $\Delta \% X_USA_PRC_e$ is tariff induced percentage drop in US exports to China (X_USA_PRC) in exporting sector e as explained in 4.2 and $TVA_USA_PRC_e$ is the US TVA to China in sector e as defined in 4.1: $TVA_USA_PRC_e = DVA_USA_PRC_i + FVA_USA_PRC_i$.²³ To retrieve the dollar value of the index computed above – *Indirect risk_i(\$)*– equation (3) can simply be multiplied by $\Delta \% X_USA_PRC_e * \sum_h X_USA_PRC_{h,e}$ – i.e., the dollar value of exports loss in sector e due to the introduction of tariffs.

Lastly, to compare each country's pass-through risk with its exports (DVA) and its economy (GDP is taken as a proxy of the value of the economy) and, we compared the dollar value of the indirect risk as defined above with each country i 's DVA to the world (4) and GDP (5).

$$\frac{Indirect Risk_i}{DVA} (\%) = \frac{Indirect Risk_i(\$)}{DVA} \quad (4)$$

$$\frac{Indirect Risk_i}{GDP} (\%) = \frac{Indirect Risk_i(\$)}{GDP} \quad (5)$$

²³ As mentioned in section 4.1, herein DVA_INTrex and RDV terms were substituted by corresponding FVA counterparts. Particularly, the $DVA_USA_PRC_i$ term includes DVA_INTrex which is substituted by its corresponding FVA counterpart – $FVA_PRC_W_{USA}$. This means that FVA from the US going through China to all countries was used herein for measuring the particular flow of interest.

4.3.2 Direct risk from demand drop in the US

To understand which countries are most exposed to the US domestic export consumption, we constructed two reliance indexes comparing each country's share of value-added absorbed in the US with its DVA to the world (6) or GDP (7):

$$DVA \text{ direct exposure}_i(\%) = \frac{\sum_s VAX_USA_{i,s}}{DVA_W_i} \quad (6)$$

$$GDP \text{ direct exposure}_i(\%) = \frac{\sum_s VAX_USA_{i,s}}{GDP_i} \quad (7)$$

where, VAX_USA_i stands for country i 's Domestic Value Added absorbed in the US via both direct and indirect exports, given by:

$$VAX_USA_i = DVA_INT_USA_i + DVA_FIN_USA_i + FVA_W_USA_i \quad (8)$$

where $DVA_INT_USA_i$ is DVA in country i 's intermediate exports to the US, $DVA_FIN_USA_i$ is DVA in country i 's final exports to the US, and $FVA_W_USA_i$ is country i 's value-added in intermediate exports to the world, consumed in the US.

4.3.3 Import substitution opportunity in China:

As tariffed goods become more expensive, Chinese businesses and consumers will gradually substitute away from US goods. As a result, countries outside of tariff reach stand to gain from this phenomenon in 2 ways: (1) by directly exporting more to China and (2) by providing intermediate goods in enhanced GVCs. Together both opportunities can be summed up to reveal a country i 's overall opportunity (9):

$$Opportunity_i^{Overall} = Opp_i^{Source} + Opp_i^{Direct} \quad (9)$$

As with the previous indirect risk index, herein we also compared the dollar value of the computed overall opportunity for country i , its DVA to the world (10) and GDP (11).

$$\frac{Opportunity_i^{Overall}}{DVA}(\%) = \frac{Opportunity_i^{Overall}(\$)}{DVA} \quad (10)$$

$$\frac{Opportunity_i^{Overall}}{GDP}(\%) = \frac{Opportunity_i^{Overall}(\$)}{GDP} \quad (11)$$

Below each of the opportunities is explored separately.

a. As an exporting country

Following UNCTAD (2005), we assume that the market share of a country in exports to China represents this given country's market potential. In other words, we assume that in the event of windfall gains in exports to China, each country – excluding the US

– would capture its respective share of trade. Behind this rationale lies the understanding that, in the short-run, all existing structures remain static and export substitution is supplied by increased production capacity from existing players.

Accordingly, we computed country i 's participation in all exports arriving in China weighted by each sector's relative drop in demand. The weights in equation (12) guarantee that we are looking at a country's participation in affected sectors and not as a share of overall exports. More, to account for the fact that not all exports lost are absorbed abroad, the trade redirection index is used to scale the opportunity index defined in (12).

$$Opportunity_i^{exp}(\%) = \frac{\sum_e DVA_PRC_{\{i,e\}} * \Delta \% X_USA_PRC_e * \bar{\theta}_e}{\sum_e [\sum_i TVA_ (W - USA)_PRC_{\{i,e\}}] * \Delta \% X_USA_PRC_e} \quad (12)$$

where $DVA_PRC_{i,e}$ represents country i 's domestic value-added to China in exporting sector e , $TVA_ (W - USA)_PRC_e$ is the TVA in the world's (excluding the US) exports to China. Note that in the numerator $\bar{\theta}_e * \Delta \% X_USA_PRC_e$ is simply $\Delta \% X_USA_PRC_e^{redirected}$ as defined in equation (2). Note as well that in the denominator $TVA_ (W - USA)_PRC_e$ all countries except for the US are considered as a part of total exports to China. This has to do with the fact that herein we are computing the opportunity from an increase in exporting flows to China coming from a reduction in the US', which naturally cannot capture part of this value. To retrieve the dollar value of the index computed above – $Opportunity_i^{exp}(\$)$ – equation (3) can simply be multiplied by $\Delta \% X_USA_PRC_e * \sum_h X_USA_PRC_{h,e}$ – i.e., the dollar value of exports loss in sector e due to the introduction of tariffs – since the current index is still looking at opportunity as a percentage of foregone exports from the US to China.

b. As a source country

In the same manner, a source country is going to benefit from being engaged in GVCs that are enhanced due to the trade war. As before, we assume that current structures do not change and that each country is going to capture its share of trade. Yet this time we look at the perspective of a source country, exporting intermediate products to a third-country, which then re-exports it to China. Accordingly, we constructed an average of FVA participation in gross exports through the World (except the US) to China, weighted by each exporting sector's redirected exports from the US to China, scaled to TVA in the corresponding flow. Equation (13) is in all aspects mirroring the dynamics and interpretations of equation (12)

$$Opportunity_i^{source}(\%) = \frac{\sum_e [\sum_s FVA_ (W - USA)_PRC_{i,s,e}] * \Delta \% X_USA_PRC_e * \bar{\theta}_e}{\sum_e [\sum_i TVA_ (W - USA)_PRC_e] * \Delta \% X_USA_PRC_e} \quad (13)$$

where $FVA_ (W - USA)_PRC_{i,s,e}$ represents FVA arriving in China through exporting sector e via the world (excluding the US) from source country i and source sector s . To retrieve the dollar value of the index computed above – $Opportunity_i^{source}(\$)$ –

equation (3) can simply be multiplied by $\Delta \%X_{USA_PRC_e} * \sum_h X_{USA_PRC_{h,e}}$ – i.e., the dollar value of exports loss in sector e due to the introduction of tariffs – since the current index is still looking at the opportunity as a percentage of foregone exports from the US to China.

5. Results

Based on the methodology described above, we constructed the aforementioned risk and opportunity metrics for each of the 62 available countries in the ADB MRIO database.

5.1 China’s retaliatory tariffs

5.1.1 Risks

5.1.1.1 Pass-through risk from GVC integration with the US

As US exports are hit by Chinese tariffs, upstream countries involved in the production of affected goods indirectly absorb some of this burden. Indeed, out of the US\$ 91.4 billion worth of US exports tariffed in China, over US\$ 11.2 billion (12.3%) come indirectly from other countries in the form of FVA (Figure 7). Accordingly, these intermediate exports are indirectly tariffed and are at risk of suffering a downturn.

Figure 7. DVA and FVA as a share of total US exports to China
(% of total US exports to China)

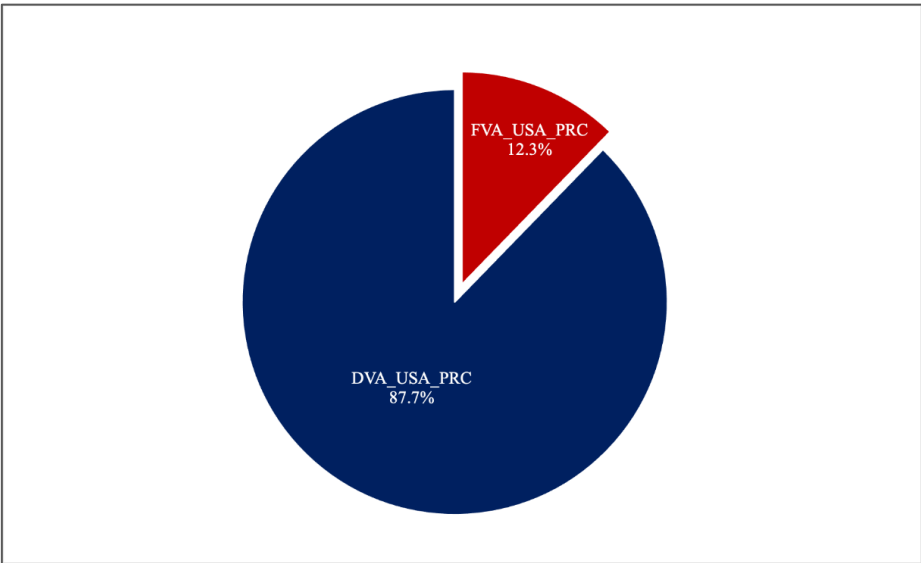

Source: Authors.

By looking at country *i*'s value-added share in total lost US exports to China, this metric captures a third-country's export loss through the US, arising from the introduction of retaliatory tariffs in China. In other words, we are looking at country *i*'s losses as a percentage of foregone US exports to China.

The results indicate that advanced economies that are highly integrated with the US are at the largest risk of being harmed when China imposes tariffs on US exports. Canada, Mexico, Japan, Germany, and Republic of Korea are among the top suppliers of intermediate goods reaching China through the US. Indeed, we estimate that these top three economies stand to lose between 1.0% and 1.6% of all foregone US-China exports. Considering the forecasted 16.0% (US\$ 19.9 billion at 2017 prices and exchange rates) drop in US exports to China, this translates to losses ranging from US\$ 220 million to US\$ 320 million for each of these economies in what could become a significant downside risk (Figure 8). Figure C.1 in Annex C displays results for all other available economies.

Figure 8. Pass-through risk from GVC integration with the US – selected economies

(% of foregone US exports to China / Billions of US\$)

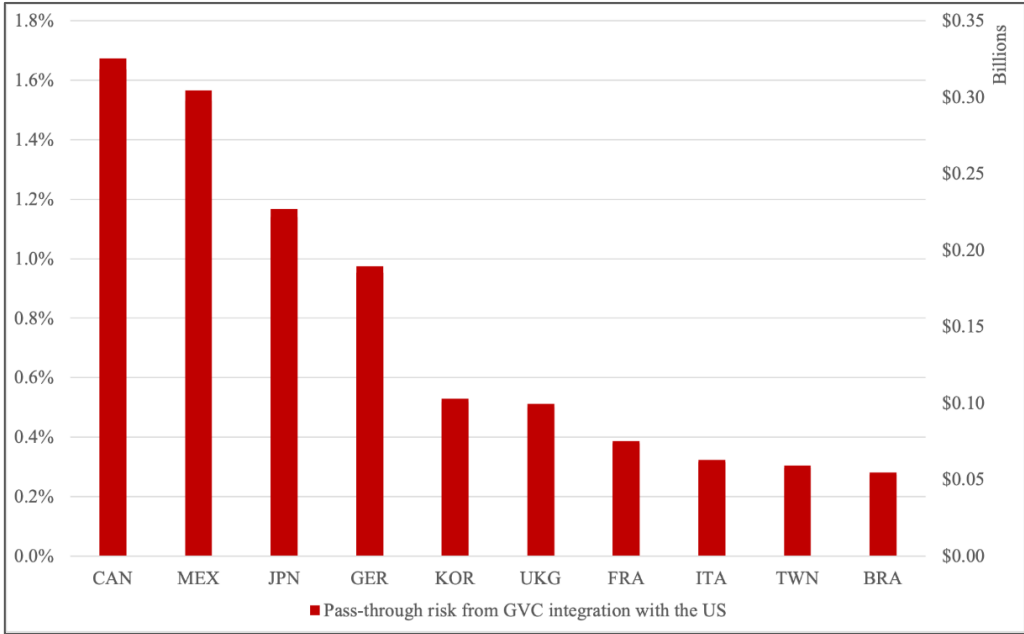

Source: Authors calculations based on data obtained from ADB MRIO (accessed April 2020)

Note: Top 10 countries with the highest pass-through risk were selected.

In particular, a quarter of Canada's pass-through risk to China can be found in the mining, quarrying, and other metal production industries (0.4%), while the transport equipment industry in Mexico (0.4%), Japan (0.3%), and Germany

(0.2%) and the electronic equipment industry in Republic of Korea (0.1%) represent the biggest liabilities for each of these nations.

Putting these potential losses into perspective, it is possible to identify that as a share of total exports to the world (DVA) and GDP, Canada and Mexico remain the most affected nations by far: both are estimated to lose around 6.5 basis points of their total DVA to the World and 1.5 basis points of GDP. Moreover, Ireland, Taiwan Province of China, and the Republic of Korea were also identified to be exposed to China’s retaliatory tariffs with losses estimated between 0.4 and 0.7 basis points of GDP (Figure 9).

Figure 9. GVC pass-through risk from integration with the US as a % of DVA to the World and GDP – selected economies

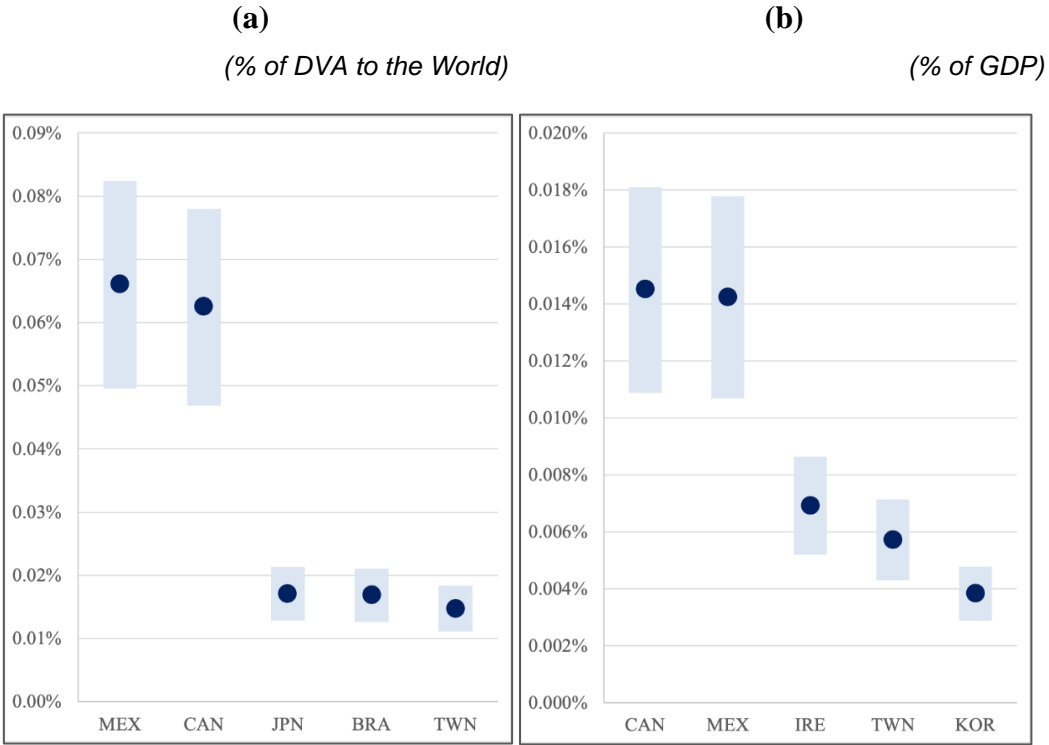

Source: Author’s calculations based on data obtained from ADB MRIO (accessed April 2020)

Note: Top 5 countries with the highest DVA risk (a) and GDP risk (b) were selected. Dark blue dot represents the estimated figure. The light blue area represents ±25% from the estimated level.

5.1.1.2 Direct risk from demand drop in the US

Trade wars produce hindering economic effects on all players, but take the highest toll on tariff-hit countries. Consequentially, if final demand in the US drops as a result of the hindering economic effects of the trade war, direct and indirect exporters reliant on the country's absorption of goods and services are expected to be hit proportionally. Thus, this indicator looks at country *i*'s added value consumed in the US – both via direct and indirect exports – against both DVA and GDP as a measure of direct reliance on the US' domestic consumption.

Once again, Mexico and Canada are at the top of both GDP and DVA reliance on US' domestic consumption. The US, directly and indirectly, absorbs more than 50% of these countries' total exports to the world and over 10% of their total GDP (Figure 10). Particularly, about 5.9% of Mexico's total GDP alone is consumed in the US in the transport, and electrical and optical equipment industry, while 4.1% of Canada's GDP is consumed in the US in the mining and quarrying industry. Even a small variation in the US' economic performance could be damaging for these economies and greatly hinder these specific industries in Mexico and Canada.

Moreover, large Asia-Pacific economies such as Japan and Republic of Korea, as well as smaller ones like Cambodia, Philippines, Sri Lanka, and Viet Nam, are also very dependent on the US as their major export market. Over 15% of total exports in these countries and 2% (Japan) to 7% (Viet Nam) of their GDP is ultimately consumed in the US. On the one hand, 7.3% of Japan's total exports to the world (corresponding to 1.0% of its GDP) and 4.1% of Republic of Korea's (1.2% of its GDP) are consumed in the US, coming from the Transport equipment and Electronic and optical equipment industries, respectively. On the other hand, textiles, footwear and leather products consumed in the US account for 3.3% of Viet Nam's and 3.0% of Cambodia's GDP. These particular industries are all dependent on the US' economic performance, which might be hurt by the current protectionist environment.

Figure 10. Direct risk from a demand drop in the US as a % of DVA and GDP – selected economies

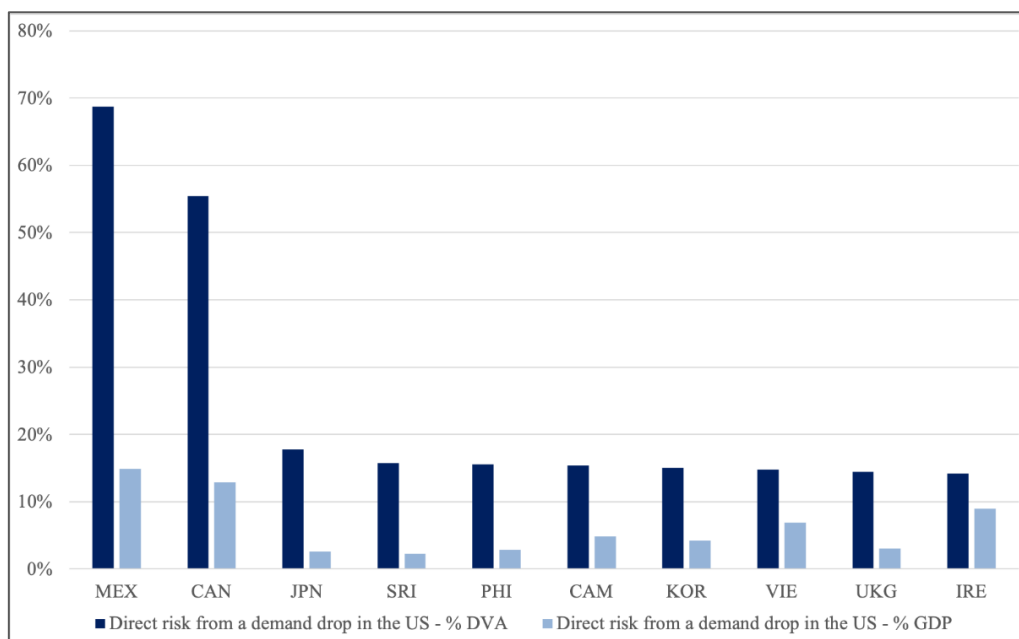

Source: Authors' calculations based on data obtained from ADB MRIO (accessed April 2020).

Note: Top 10 countries with the highest *Direct risk from demand drop in the US as a % of DVA* were selected; organized from highest to lowest in the same metric.

5.1.2 Opportunities

5.1.2.1 Import substitution opportunity in China

As the direct result of import substitution in China, countries involved in the production of similar or substitute products are going to absorb some of the foregone trade activity. Indeed, as foreign products become relatively cheaper than US exports, both exporting countries – directly capturing new purchases – and source countries – involved in supplying intermediate products to enhanced GVCs – are going to benefit from it. Moreover, as China increased its tariffs on US exports, it decreased its MFN tariff towards other countries from 8% to 6.7%, further strengthening substitution away from US exports (Bown, Jung & Zhang, 2019).

For that reason, herein we measure a country's percentage gain of lost US exports to China by looking at its participation share in both direct (opportunity as a direct exporter) and indirect exports (opportunity as a source of intermediates to a direct exporter) to China.

First, looking at the total export substitution opportunity for third-party countries, it is possible to identify that developed and emerging economies that are well-connected to China and other suppliers stand to gain the most from the current situation. Indeed, Germany, Japan, Republic of Korea, Australia, Brazil, and Taiwan Province of China

(in descending order) are in the best position to substitute the US in its export capacity to China. Each of these economies is estimated to capture about 2.0% to 6.0% of all diverted trade from the US (Figure 11). Putting this into perspective, this could translate into a maximum US\$ 1.0 billion windfall in diverted trade for Germany and Japan and from US\$ 0.4 to US\$ 0.8 billion for the remaining countries.

Moreover, looking at the opportunity as an indirect (source country) and as a direct exporter separately, it is possible to identify that the latter dominates total opportunity: only 20.5% of value-added arriving in China comes indirectly through other countries. Nevertheless, economies like Russia, France, the United Kingdom, Italy, the Netherlands, and Switzerland will seize over 30% of their total opportunity from supplying GVCs passing-through other countries before finally arriving in China.

Figure 11. Overall opportunity from China’s tariffs – selected economies

(% of foregone US exports to China / Billions of US\$)

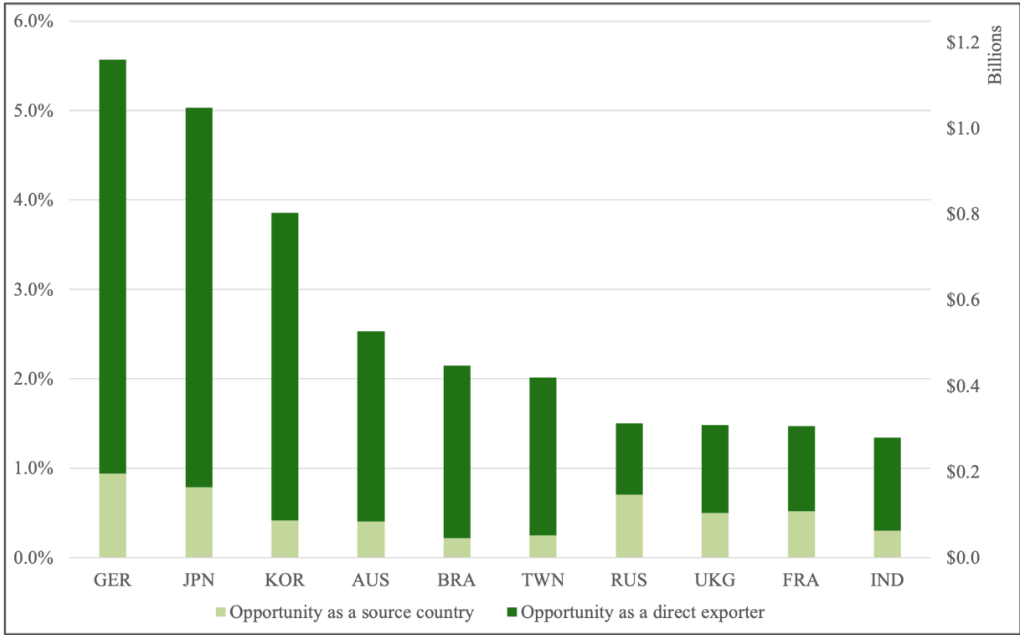

Source: Authors’ calculations based on data obtained from ADB MRIO (accessed April 2020)

Note: Top 10 countries with the highest Overall opportunity were selected.

Of particular relevance, Transport equipment and Machinery in Germany (3.3% of overall opportunity) and Japan (2.0%), Electronic equipment in Republic of Korea (1.3%), Taiwan Province of China (1.01%), and Japan (0.8%), as well as Agriculture and Mining in Australia (1.7%), Brazil (1.4%) and Russia (0.7%) were identified as the sectors with largest opportunities for third-party countries in capturing diverted trade from the US.

Mongolia, Brazil, Australia, Taiwan Province of China, and Republic of Korea are the economies registering the largest exports boost with gains reaching 0.4% of DVA to the world for Mongolia, and roughly 0.2% for the remaining economies (Figure 12a). Moreover, in terms of GDP, Mongolia, Taiwan Province of China, Republic of Korea, Viet Nam and Thailand (in that order) emerge as the main winners, with estimated gains amounting to 0.2% for Mongolia and roughly 0.05% for the remaining economies (Figure 12b). Naturally, these Asia-Pacific economies – as well as Brazil, through its large Agricultural and Mining industries – are closely linked to China and can thus expect to receive a significant part of diverted trade.

Figure 12. Total opportunity from China’s tariffs as a % of DVA and GDP – selected economies

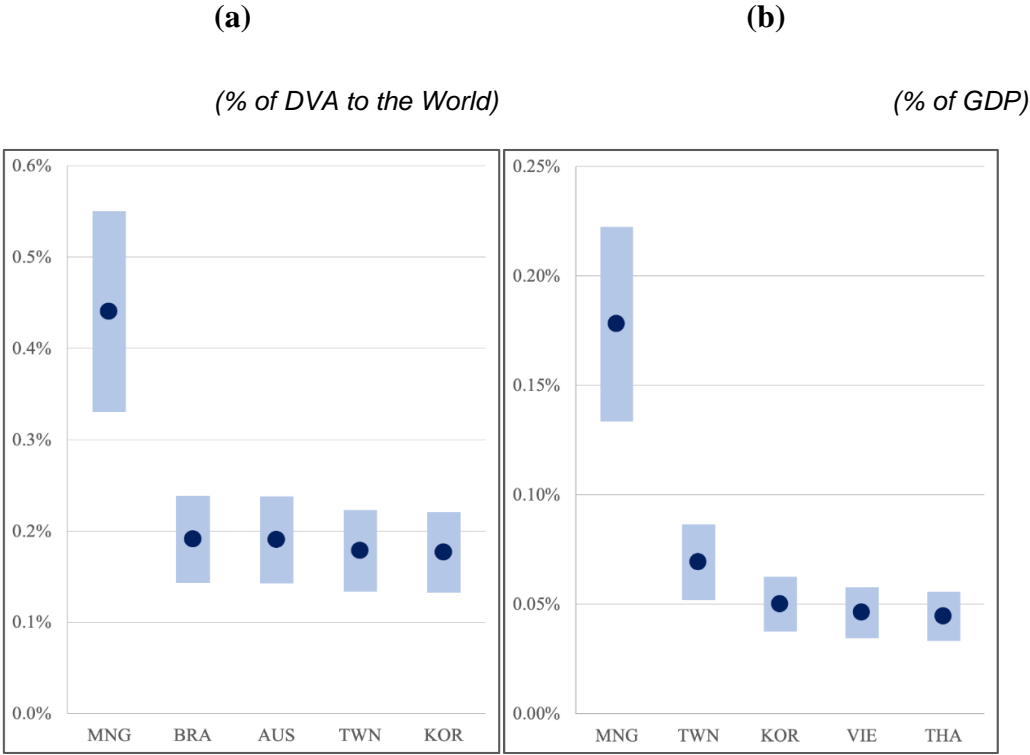

Source: Authors’ calculations based on data obtained from ADB MRIO (accessed April 2020)

Note: Top 5 countries with the highest overall opportunity as % of DVA (a) and GDP (b) were selected. Dark blue dot represents the estimated figure. The light blue area represents ±25% from the estimated level.

5.1.3 Risks v Opportunities

Comparing risks and opportunities at the economy level allows us to gain an overall understanding of how tariffs might impact each economy’s economic situation. However, due to the nature of our analysis, it is necessary to take into account that

only the *pass-through risk from GVC integration with the US* can be compared with the *import substitution opportunity in China* as both draw from foregone US exports to China. As a result, countries' net situation as presented below is biased upwards as the *Direct risk from demand drop in the US* (5.1.1.2) is not reflected. Accordingly, the situation described herein can be interpreted as a "best-case scenario" – one where direct exports to the US are not adversely impacted.

China's tariffs are set to negatively affect only Mexico and Canada (figure 13). This reflects these economies' reliance on the US as a hub for absorbing intermediate exports from other nations. These economies are expected to lose around 1.8% of all foregone US exports to China or US\$ 0.3 billion. In terms of DVA to the world and GDP, these figures represent roughly 6 and 1 basis points for Canada, respectively, as well as 1.2 and 2 basis points for Mexico, respectively.

On the one hand, Germany, Japan, and Republic of Korea are set to be the biggest winners from China's retaliatory tariffs in terms of absolute value of gains – reaping 4.6% (US\$ 0.9 billion), 3.9% (US\$ 0.8 billion) and 3.3% (US\$ 0.7 billion) of foregone US exports to China, respectively. On the other hand, Taiwan Province of China, Republic of Korea, and Australia are expected to capture the largest windfall relative to GDP: these economies' estimated profits are equivalent to 5.9, 4.3, and 3.6 basis points of their total GDP. Ultimately, despite pending losses (risks) from being well-connected with the US via intermediate goods that would then be re-exported to China — now tariffed —, the opportunity to seize diverted trade from China more than outweighs these risks, contributing to an overall gain in net exports from China's imposition of tariffs on US goods.

Figure 13. Opportunity-risk analysis – selected economies (ordered by highest to lowest difference as a % of GDP – not displayed)

(% of foregone US exports to China / Billions of US\$)

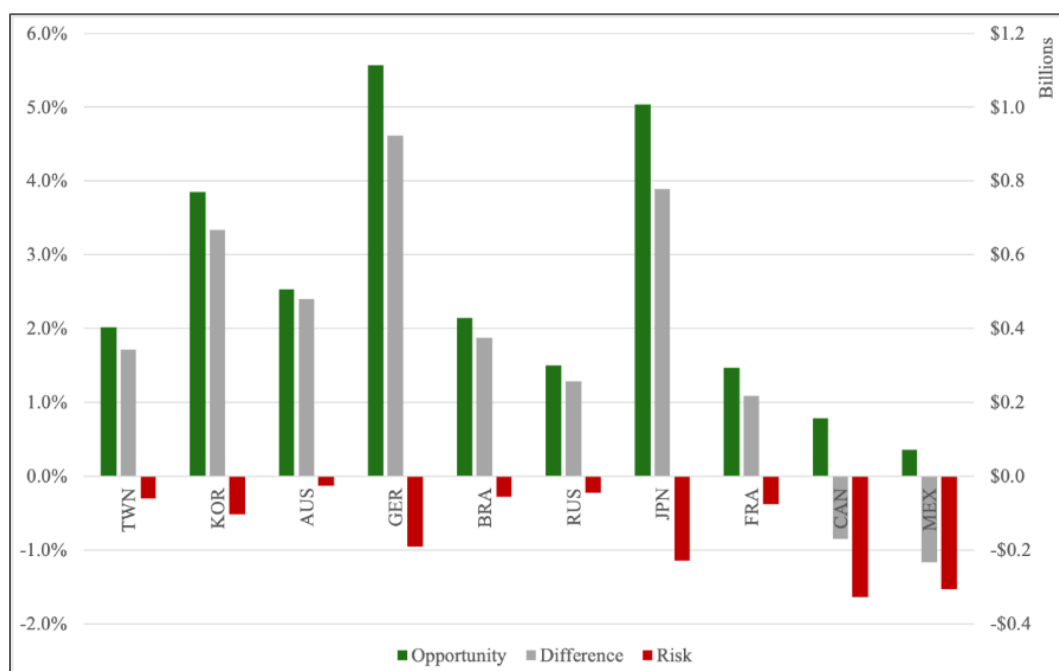

Source: Authors' calculations based on data obtained from ADB MRIO (accessed April 2020)

Note: The only two countries with the net risk and the top 8 countries with the largest net opportunity were selected. Selected economies are organized by difference as a % of GDP.

5.2 US tariffs

5.2.1 Risks

5.2.1.1 Pass-through risk from GVC integration with China

As China's exports are hit by US tariffs, upstream countries involved in the production of affected goods indirectly absorb some of this burden. Indeed, out of the US\$ 325.5 billion worth of China's exports tariffed in the US, over US\$ 44.3 billion (13.6%) come indirectly from other countries in the form of FVA (Figure 15) and are at risk of suffering a downturn. Herein, the same logic as in the case of pass-through risk from GVC integration with US (see section 5.1.1.1) applies and so does the coefficient's interpretations.

Figure 14. DVA and FVA as a share of total China exports to the US

(% of China's exports to the US)

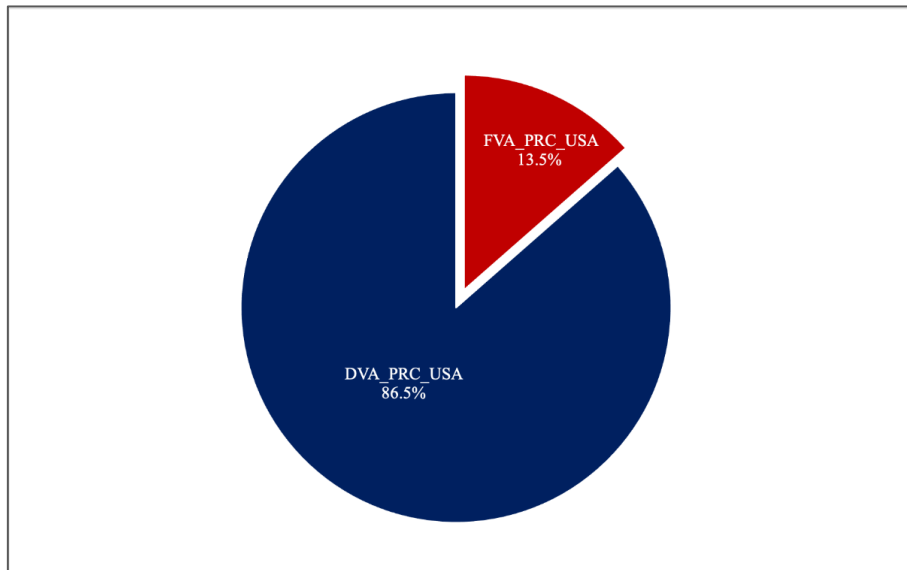

Source: Authors

The results indicate that advanced economies that are highly integrated with China are at the largest risk of being harmed. Republic of Korea, Japan, Taiwan Province of China, Australia, and Germany are among the top suppliers of intermediate goods reaching the US through China. Indeed, we estimate that these top three economies stand to lose between 1.0% and 1.4% of all foregone US-China exports. Considering the forecasted 19.5% drop in China's exports to the US (US\$ 85.4 billion at 2017 prices and exchange rates), this translates to losses ranging from US\$ 800 million to US\$ 1.2 billion for each of these economies in what could become a significant downside risk (Figure 15).

Figure 15. Pass-through risk from GVC integration with China – selected economies

(% of foregone China's exports to the US / Billions of US\$)

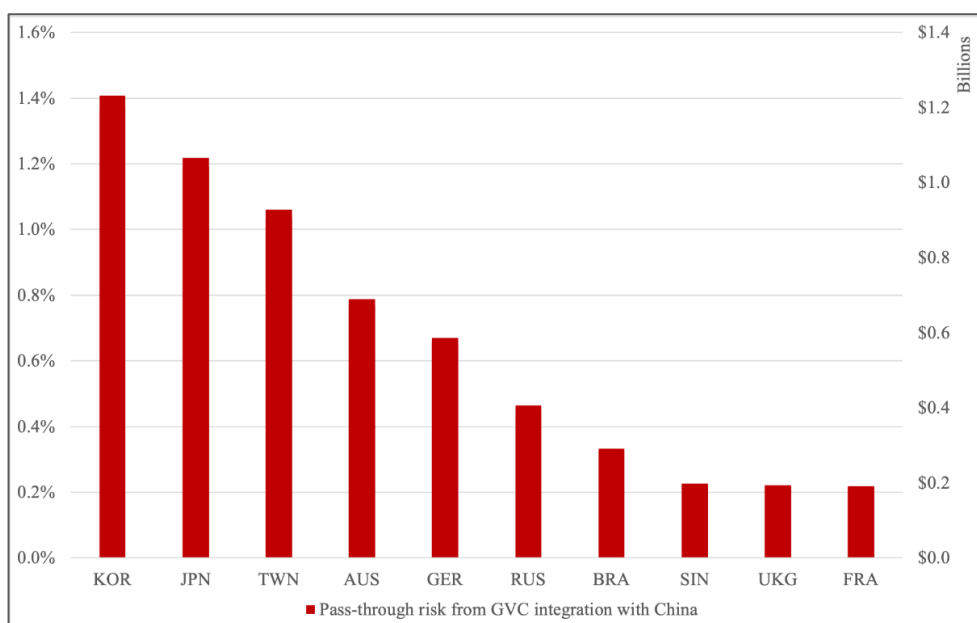

Source: Authors' calculations based on data obtained from ADB MRIO (accessed April 2020)

Note: Top 10 countries with the highest pass-through risk were selected.

Looking at the sector level, it is possible to identify that most risks for third-party countries lie in the Electric and Optical Equipment and Mining and quarrying sectors: each is roughly responsible for 20% of total pass-through risks, or around 2.5% in pass-through losses as a percentage of foregone exports to the US. For economies like Taiwan Province of China, Republic of Korea, and Japan, the former represents 64%, 39%, and 24% of their total pass-through risk, respectively, while the latter is especially relevant to economies like Australia and Russia who see half of their export losses in the sector.

Putting these losses into perspective, it is possible to identify that as a share of total exports to the world (DVA) and GDP, Mongolia, Taiwan Province of China, and Republic of Korea are the countries most exposed to this type of risk (Figure 16). Particularly, Mongolia is estimated to lose around 0.8% of its total exports to the world and 0.3% of its total GDP. These shares are estimated to be 0.4% and 0.16% for Taiwan Province of China, and 0.28% and 0.08% for Republic of Korea, respectively. Viet Nam's and Singapore's reliance on this particular channel is also notable, with estimates putting these nations' economic losses at 0.05% of GDP.

Figure 16. GVC pass-through losses from GVC integration with China as a % of DVA to the world and GDP – selected economies

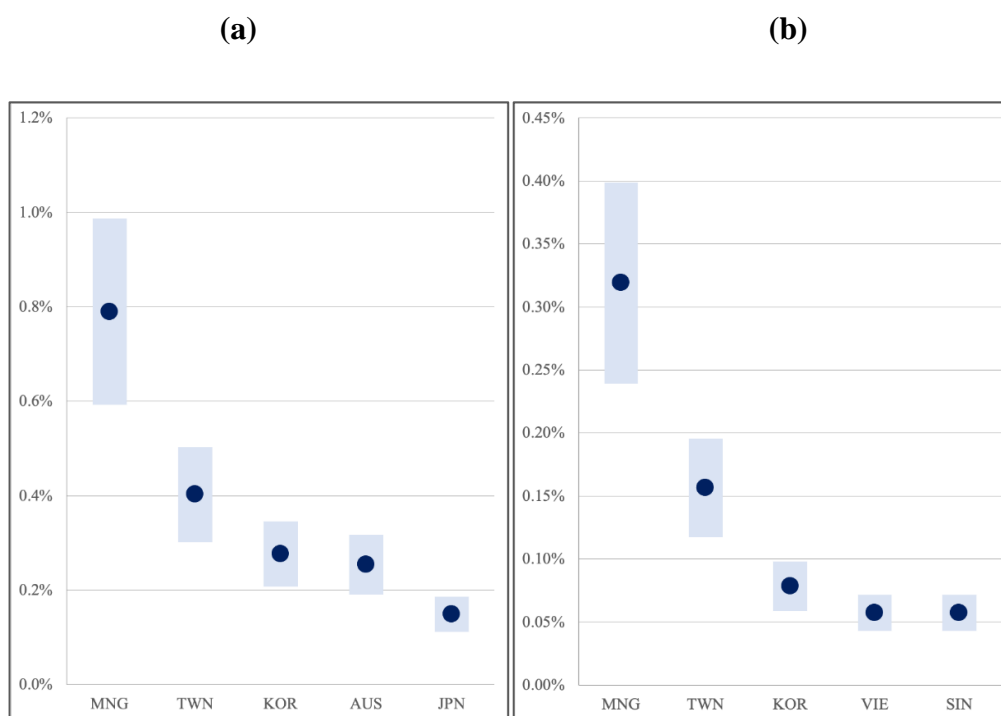

Source: Authors' calculations based on data obtained from ADB MRIO (accessed April 2020)

Note: Top 5 countries with the highest overall opportunity as a % of DVA (a) and GDP (b) were selected. Dark blue dot represents the estimated figure. The light blue area represents $\pm 25\%$ from the estimated level.

5.2.1.2 Direct risk from demand drop in China

Trade wars produce hindering economic effects on all players, but take the highest toll on tariff-hit countries. Consequentially, if final demand in China drops as a result of the hindering economic effects of the trade war, direct and indirect exporters reliant on the economy's absorption of goods and services are expected to be hit proportionally. Thus, this indicator looks at country *i*'s added value consumed in China – both via direct and indirect exports – against both DVA and GDP as a measure of direct reliance on China's domestic consumption.

As in the previous section, in terms of GDP and exports absorption, Mongolia, Taiwan Province of China, and Republic of Korea are the most dependent economies on China for their value-added exports. For Mongolia in particular, this dependence amounts to 60% of its DVA to the world and 24% of its GDP. These shares are 26% and 10% for Taiwan Province of China, and 23% and 7% for Republic of Korea, respectively (Figure 17). Moreover, Australia and Japan are also shown to be heavily intertwined with China- in their exports production: 25% and 15% of these economies' DVA to the world are absorbed in China, respectively.

Looking at reliance by sector, it is possible to identify that majority of risk is concentrated in two key sectors: The mining and quarrying and the electric and optical equipment industries. Strikingly, 22.0% of Mongolia’s, 3.3% of Australia’s, 1.7% of Brunei Darussalam’s, and 1% of Kazakhstan’s and Russia’s GDP is consumed in China in the mining and quarrying industry alone. Furthermore, China’s consumption of electrical and optical equipment amounts to 6.0% and 3.2% of GDP for Taiwan Province of China and Republic of Korea, respectively. These shares amount to 1% for Singapore, Malaysia, and Viet Nam. This level of reliance in specific sectors indicates that these economies will be significantly suffering if China experiences a considerable economic deceleration.

Figure 17. Direct risk from demand drop in China as a % of DVA and GDP – selected economies

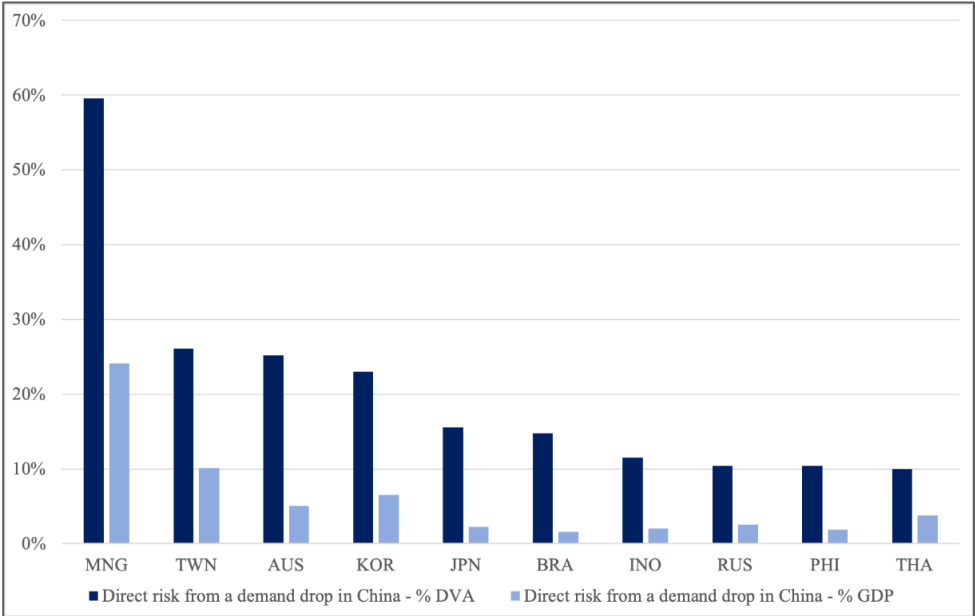

Source: Authors’ calculations based on data obtained from ADB MRIO (accessed April 2020)

Note: Top 10 countries with the highest *Direct risk from demand drop in China as a % of DVA* risk were selected; organized from highest to lowest in the same metric.

5.2.2 Opportunities

5.2.2.1 Import substitution opportunity in China

As the direct result of import substitution in the US, countries involved in the production of similar or substitute products are going to absorb some of the foregone trade activity. Indeed, as foreign products become relatively cheaper than China’s exports, both exporting countries – directly capturing new purchases – and source countries – involved in supplying intermediate products to enhanced GVCs – can be expected to benefit.

First, looking at the total export substitution opportunity for third-party countries, it is possible to identify that developed economies that are well-connected with the US and to other suppliers stand to gain the most from the current situation. Indeed, Canada, Mexico, Germany, and Japan (in descending order) were found to be in the best position to substitute China in its export capacity to the US. Each of these economies is estimated to be capturing from 4.0% to 7.0% of all bilateral exports lost (Figure 18). Putting this into perspective, this could translate into up to a US\$ 6.2 billion windfall in diverted trade for Canada and Mexico and approximately US\$ 3.5 billion for Germany and Japan.

Moreover, looking at the opportunity as an indirect (source country) and as a direct exporter separately, it is possible to identify that the latter dominates total opportunity: only 23.1% of value-added arriving in the US comes indirectly from other countries. Nevertheless, while Canada and Mexico are almost solely involved in directly supplying goods to the US, all other economies earn at least 20% of their overall opportunity in supplying GVCs passing-through other countries before finally arriving in the US. The most notable among these are Russia, Netherlands, Spain, and Australia, who gain over 40% of their overall opportunity in supplying enhanced GVCs ultimately arriving in the US.

Figure 18. Overall opportunity from US tariffs – selected economies

(% of foregone China’s exports to US / Billions of US\$)

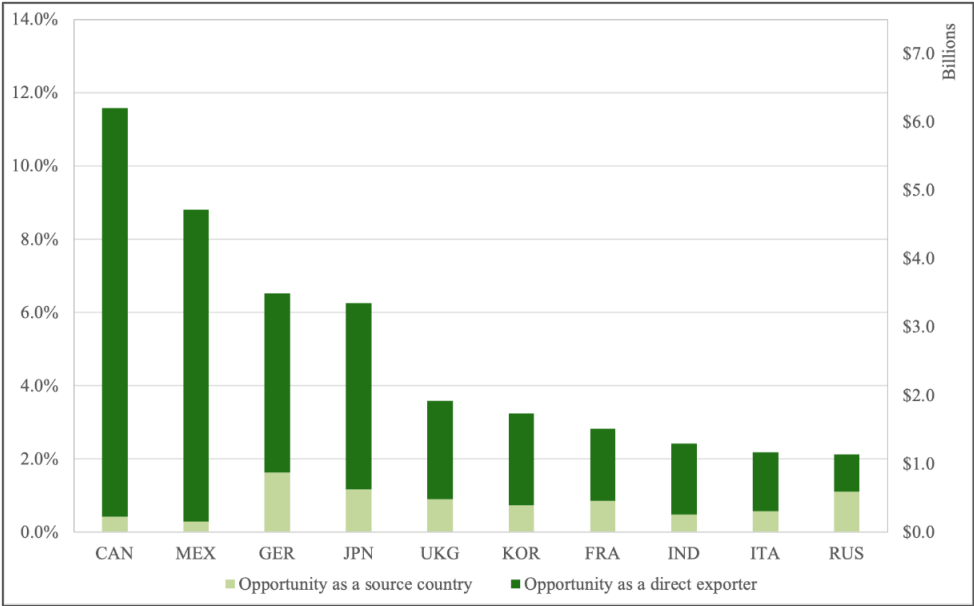

Source: Authors’ calculations based on data obtained from ADB MRIO (accessed April 2020)

Note: Top 10 countries with the highest Overall opportunity were selected.

Looking at the sector-wise distribution of opportunities, it is possible to identify that, apart from other business activities,²⁴ the transport equipment industry carries the most opportunities. Indeed, the sector alone represents 10% of all redirected trade from abroad and it is the most important one for Mexico (24% of total opportunity), Japan (35%), and Germany (25%). Primary industries such as Mining and quarrying, coke, refined petroleum and nuclear fuel, as well as metals, are also vital in supplying the US and substituting China in its export capacity: together these sectors account for 25% of overall opportunity. For Canada and Mexico, these industries represent roughly 50% and 25% of these economies' total opportunity, respectively.

Both in terms of total exports to the world (DVA) and GDP, Canada and Mexico emerge as the clear winners in capturing diverted trade from China. Indeed, these two economies are estimated to see gains equivalent to 1.9% and 1.6% of their total DVA to the world, or 0.41% and 0.38% in terms of GDP, respectively (Figure 19a and Figure 19b). Next, the Philippines, Japan, and Brazil will see a 0.5% boost in their DVA to the world. Gains in economies such as Ireland, Viet Nam, and the Netherlands will translate into a boost of 0.20%, 0.15%, and 0.13% of GDP, respectively.

Figure 19. Overall opportunity from US tariffs as % of DVA to the world and GDP – selected economies

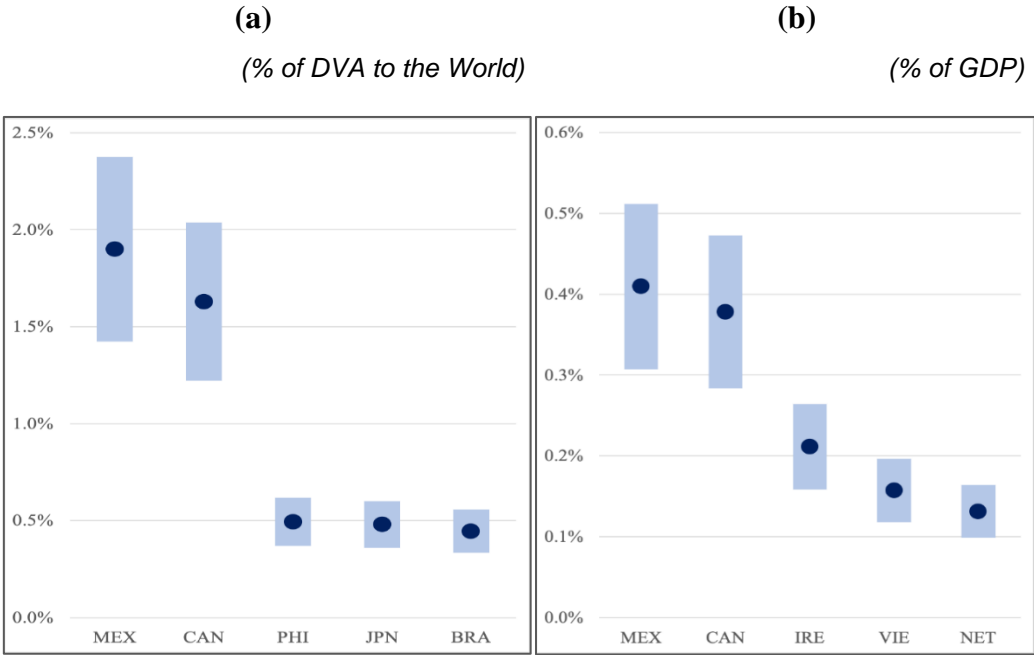

Source: Authors' calculations based on data obtained from ADB MRIO (accessed April 2020)

²⁴ Other business activities is an umbrella sector that encompasses all the services not elsewhere considered. It is, thus, usually significantly large.

Note: Top 5 countries with the highest overall opportunity as % of DVA (a) and GDP (b) were selected. Dark blue dot represents the estimated figure. The light blue area represents $\pm 25\%$ from the estimated level.

5.2.3 Risks vs Opportunities

As in section 5.1.3, it is important to highlight that due to the nature of our analysis the *Direct risk from demand drop in China* (5.2.1.2) is not reflected. Accordingly, the situation described herein can be interpreted as a “best-case scenario”.

As in the case of China’s tariffs, the US’ imposition of tariffs is set to negatively hit only a few economies. Indeed, Taiwan Province of China (losing 0.3% of all foregone China’s exports to the US or US\$ 0.23 billion), Australia (0.2% or US\$ 0.20 billion), Hong Kong China (0.1% or US\$ 0.06 billion), and Mongolia (0.04% or US\$ 0.03 billion) are the only four economies estimated to experience a net loss in exports once risks and opportunities are compared with each other. Putting these into perspective, it is possible to identify that while the three economies experiencing the largest absolute burden from tariffs – Taiwan Province of China, Australia, and Hong Kong China – are looking at losses amounting to 2 to 4 basis points of GDP, estimates point to Mongolia seeing the equivalent of 30 basis points of its GDP being wiped away due to the trade war.

On the other hand, Canada, Mexico, Germany, and Japan emerge as the largest beneficiaries from the current situation. Indeed, these nations are each estimated to be receiving net gains, in the form of foregone China’s exports to the US, amounting to 7.13% (US\$ 6.0 billion), 5.49% (US\$ 4.7 billion), 3.43% (US\$ 2.9 billion) and 2.2% (US\$ 2.3 billion) (figure 20). In terms of GDP, these amount to a boost of roughly 40 basis points for the first two economies and around 5 for the remaining.

Figure 20. Opportunity vs Risk analysis – selected economies

(% of foregone China's exports to the US / Billions of US\$)

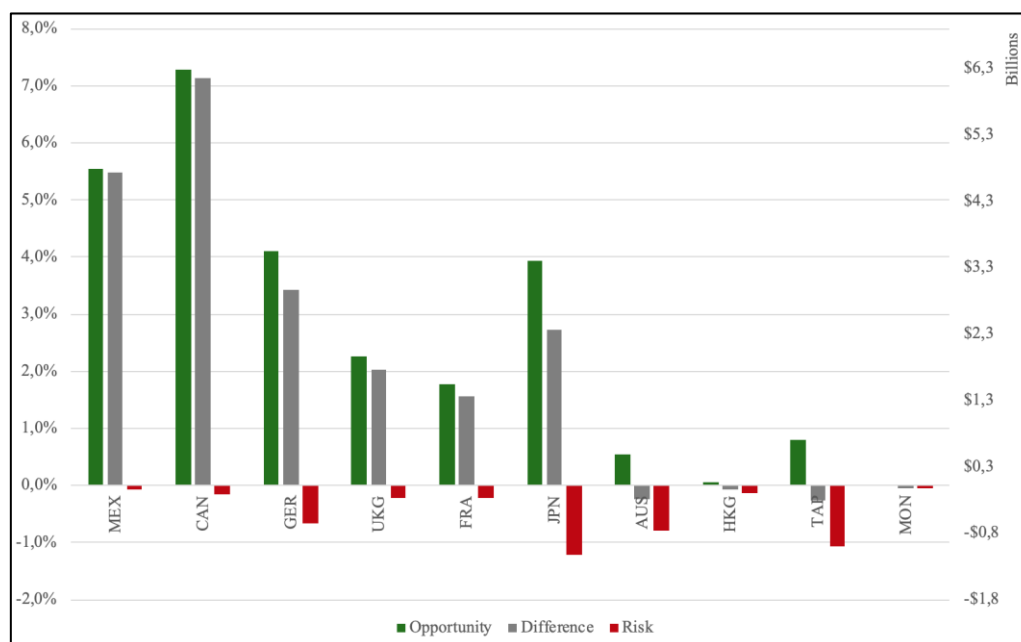

Source: Authors' calculations based on data obtained from ADB MRIO (accessed April 2020).

Note: Only 4 economies with a negative difference and the top 6 economies with the largest positive difference were selected. Selected economies are ordered by highest to lowest difference as a % of GDP.

6. Discussion

Pre-trade war, in 2017, the US-China commercial relationship was worth about US\$ 563.9 billion: US\$ 439.9 billion (or 78% of total bilateral trade) in China's exports to the US and US\$ 124.0 billion (22% of total bilateral trade) in US exports to China. Then, the average tariff rate on Chinese products arriving in the US was 3.1% and, in the opposite direction, 8.3%.

By contrast, after the imposition of new trade war-related tariffs, trade between the two nations is estimated to have fallen by 18.7% (or US\$ 105.3 billion) to around US\$ 458.6 billion at 2017 prices (pre-trade war tariffs). Naturally, as the trade flows' magnitude are considerably asymmetric, so is the recorded drop in bilateral trade: US\$ 85.4 billion drop in China's exports to the US and US\$ 19.9 billion the other way around. This comes as a result of the tariffs raised on 74% of total bilateral trade that pushed the average tariff rate on Chinese and US exports to 19.0% and 21.1%, respectively.

Looking more closely at the US\$ 105.3 billion worth of foregone bilateral exports, it is possible to identify that only 37% of it (or US\$ 39.0 billion) was permanently lost in

terms of trade, having either been absorbed domestically or lost due to higher prices and market frictions. Since only 13.3% of all added value traded between the US and China comes from foreign economies, third-party economies are looking at a US\$ 5.2 billion loss on total exports previously passing-through these nations.²⁵ However, this figure is relatively small in comparison with the US\$ 66.3 billion (or 63% of foregone US-China exports) in new exports that are estimated to have been absorbed by other nations as a result of the shifting trade patterns induced by the trade war (figure 21).

Figure 21. US and China bilateral relationship – trade-war impact

(Billions of US\$ at 2017 prices)

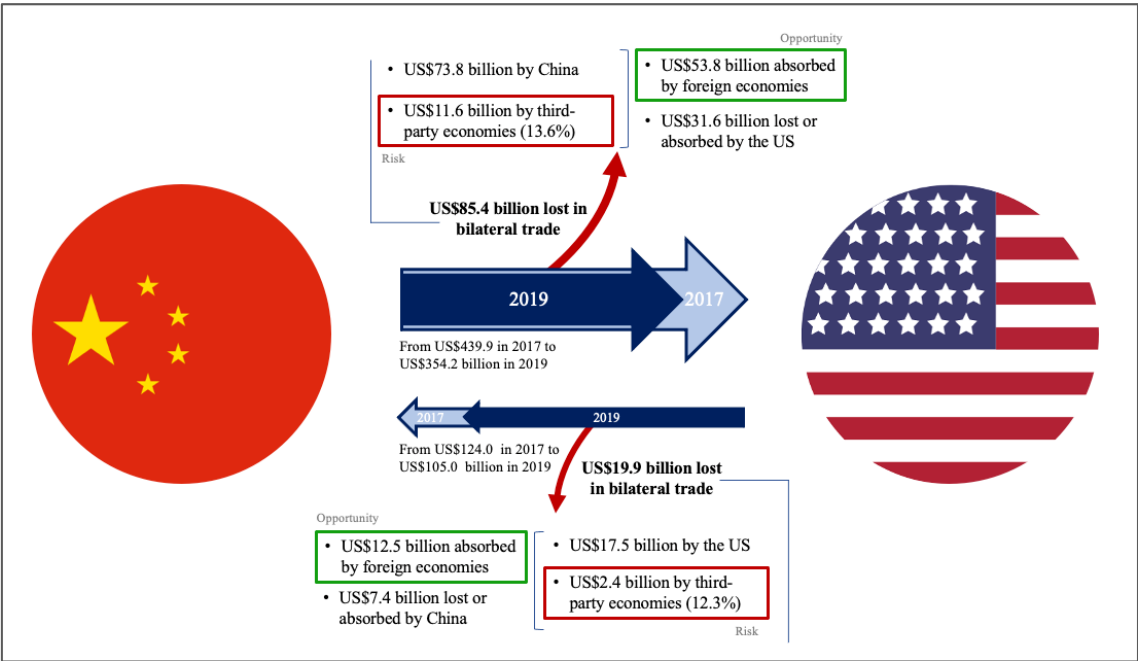

Source: Authors

Notes: In brackets inside the red boxes, each economy’s FVA export share.

Given the large discrepancies in the flows of trade between the US and China, it is possible to identify that the US’ imposition of tariffs has produced the most significant effects in reshaping international GVCs: the former has shifted at least US\$ 49.5 billion in net exports away from China to other economies, compared with only US\$ 11.6 billion going from the US to third-party economies.²⁶ For that reason, nations that are well connected to the US are in the best position to take advantage of the current

²⁵ The US\$ 5.2 billion loss in exports refers to the share of foregone US exports that come for foreign countries.
²⁶ The words “at least” are important in this sentence since herein we are assuming that the participation of foreign economies on the 37% of bilateral trade that was absorbed domestically or actually lost is reduced to zero. This is due to the fact that we could not compute how much of the 37% was actually lost and how much was absorbed domestically. In reality, it is more likely that from trade that was absorbed domestically but not lost some still comes from foreign countries, producing a slightly higher figure for the net exports earned by third-party economies.

setting, while economies reliant on China are more likely to suffer from the GVC reorganization.

Moreover, interestingly, this shift away from the US-China link will also mean that upstream economies will see more business coming their way than they usually did. Indeed, since on average only 13.3% of all value-added traded between the US and China comes from foreign economies – compared with 19.0% for all other GVCs supplying the US and China – this shift will contribute to a more integrated supply-chain network in substituting for the foregone US-China exports.

Accordingly, while individual countries and industries might be overexposed to specific key nodes in affected links, from an international trade perspective, third-party countries are overwhelmingly benefiting from the current protectionist measures that have shifted US\$ 61.1 billion in net trade away from the US and China and towards other economies.

As figure 22 shows, apart from Mongolia and Hong Kong China – who are expected to lose a modest US\$ 14 million (12 basis points of GDP) and US\$ 40 million (1 basis point), respectively, due to their high degree of integration with China – all other economies are set to receive a net gain in exports previously coming from or passing through, the US and China. However, it is also worth noting that in absolute terms, Japan and Republic of Korea face the largest risk – the majority of which comes from GVC integration with China in exports to the US. These estimated results are supported by observed trade data, which show the largest negative trade diversion effect of Chinese imports for these two economies (Bekkers and Shroeter, 2020). The authors clarify that this negative trade diversion effect for these economies is due to the structure of bilateral trade between the US and China – exports from China to the US are much larger than the converse. As a result, the diversion of China's imports away from the US and towards other economies is less significant than the reduced demand for intermediates inputs used in producing exports for the US market.

Large industrialized economies like Mexico, Canada, Germany, Republic of Korea, Japan, and the United Kingdom are the top winners with gains estimated anywhere between US\$ 2.0 billion and US\$ 6.0 billion. This is particularly important for Republic of Korea, Japan, and Germany, who negated their high risk of GVC disruption through larger gains in redirected exports from enhanced value chains. In terms of opportunity as a percentage of GDP, this translates into a considerable 35 basis point boost for Mexico's and Canada's economies and a more modest but still important 5 basis points increase for Germany, Republic of Korea, the United Kingdom, Japan, France, and India. These results for estimated opportunity closely follow observed data on trade diversion in US imports – which constitute the major share of overall opportunity – away from China towards other economies (see Nicita, 2019).

Figure 22. Total opportunity vs total risk in billions of US\$ and as a % of GDP – selected economies

(Billions of US\$ / % of GDP)

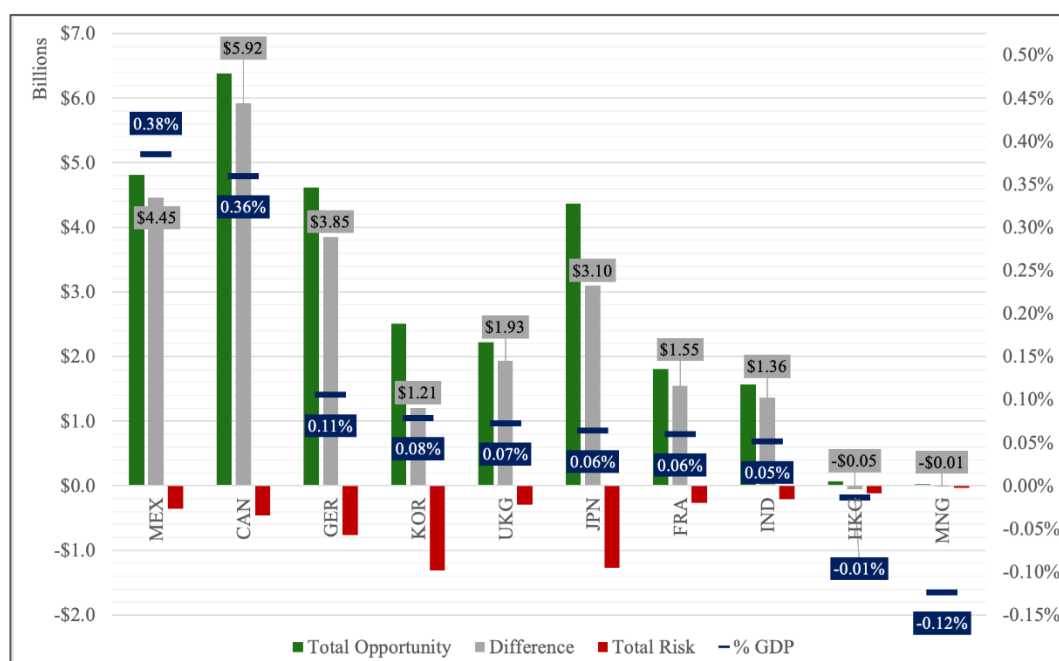

Source: Authors' calculations based on data obtained from ADB MRIO (accessed April 2020).

Note: The only 2 economies with a negative difference and the top 6 economies with the largest positive differences were selected.

However, it is important to note that the analysis above does not directly account for the negative impact of a US and China lower export demand due to the tariffs' harmful economic burden. Including these additional pressures would reflect that, often times, the most prominent economies in attracting redirected trade are also the ones who are most reliant on the US and China as their ultimate export consumer. This is because our methodology assumes that redirected business will flow towards economies that are already highly integrated with the affected GVCs. Naturally, many times this also means high GDP and DVA dependency ratios.

The particular cases of Mexico and Canada are highly illustrative of this reality. Indeed, the opportunity of fetching around US\$ 5.0 billion each in redirected trade will have to be measured against the decrease in the demand for previously existing exports, which represent over 50% of both countries' total DVA to the world and 10% of their GDP. Hence, ultimately determining if a country will benefit or lose from the current trade war will be a question of whether the trade in goods and supportive services that are being shifted away from the US and China towards other economies can balance out the negative impact of tariffs on the US' and China's existing demand for exports.

In this regard, we looked at foreign direct investment (FDI) data to examine whether firms' investment patterns from 2010 to 2019 reflect our overall predictions for locations

that are likely to serve as new GVC production hubs. As a result, we found that bilateral US-China FDI flows were closely aligned with the results presented herein, and also supported our methodological approach to shifting trade flows (see Box 2).

Box 2: FDI flows and the trade-war – decoupling from a different perspective

While over the past decade rising wages and structural re-adjustments in the Chinese economy were already enticing firms to diversify their export production away from China – particularly in low technology, labour intensive sectors –, the US-China trade war has significantly reshaped businesses' incentives towards shortening and regionalizing existing GVCs. More recently, the onset of the COVID-19 pandemic has added a further impetus to this trend, as GVC disruptions and movement restrictions reinforced companies' and governments' concerns about foreign supply over-reliance and supply-chain resilience.

Looking at trends in US and Chinese outward FDI flows over the last decade (2010 to 2019), it is possible to identify that as a share of total investment, bilateral FDI between these two economies has been decreasing. Indeed, as Figure 23 highlights, both China and the US have registered the lowest 10-year trend with regards to the share of total US (figure 23a) and China's outward FDI (figure 23b), respectively. This means that over the past decade both countries have on average dedicated to each other a smaller share of their investments, instead channelling it towards other players. More specifically, Viet Nam, France, the Netherlands, Germany, Mexico and the United Kingdom have become increasingly important US outward FDI destinations. The equivalent destinations for China's outward FDI include Kazakhstan, the Russian Federation, Germany, the Philippines, Singapore and Japan.

Figure 23 a. Annual average change in the share of total US outward FDI and total US outward FDI, per country – 2010-19 (selected economies)

(percentage points / US\$ billions of outward FDI)

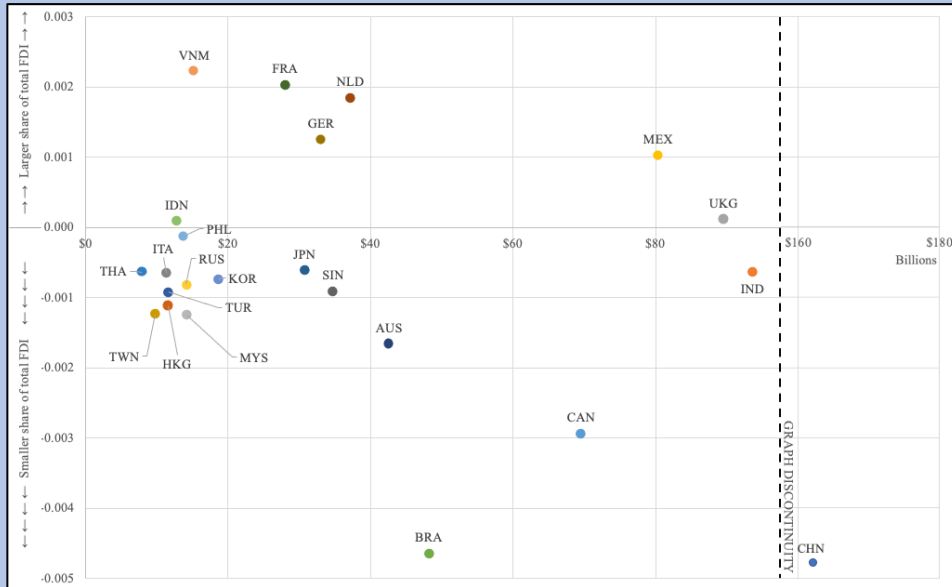

Figure 23 b. Annual average change in the share of China's total outward FDI and China's total outward FDI, per country – 2010-19 (selected economies)

(percentage points / US\$ billions of outward FDI)



Source: Authors based on FDI Markets database (accessed December 2020).

Note: Total outward FDI refers to the cumulative US (figure 23a) or China's (figure 23b) FDI from 2010-2019 per country.

While the interaction between trade and FDI flows can be complex to interpret,* it is worthwhile noting that, over the last 10 years, China's and the US' outward FDI patterns have broadly followed the ones identified in this paper. For instance, France, Germany, Japan, Mexico, the Netherlands, the Russian Federation, and the United Kingdom have all been highlighted as potential alternative production nodes to the US and China. Furthermore, the prominence of Japan, Mexico, the Philippines, the United Kingdom and Viet Nam – among others – in both the US' and China's FDI landscape can also be linked with these countries' high reliance on domestic demand coming from these two economies. Naturally, while our paper's results are solely focused on pin-pointing trade war-induced movements, the FDI data presented herein strongly supports our understanding that the US-China decoupling process is a long-term trend fuelled by shifting structural economic incentives. Nevertheless, since the beginning of the trade war in 2017, these longer-term trends seem to have significantly intensified.

On one hand, China's outbound investments to the US have virtually collapsed: despite a ten-fold increase since 2010 – to US\$ 46 billion in 2016 (particularly in the ICT sector) – China's outward FDI to the US has declined 90% to US\$ 4.8 billion in 2019 – its lowest level since 2009 (Hanemann et al., 2020). Moreover, since 2017, the US has seen a considerable flow of relocation operations with capital moving to other prominent destinations: during 2018 and 2019, the US registered US\$ 0.5 billion in direct FDI leaving the country to China, an additional US\$ 0.7 billion to Mexico and US\$ 0.6 billion to Viet Nam. Other important destinations were France (US\$ 150 million), Thailand (US\$ 70 million), Brazil (US\$ 70 million), the Netherlands (US\$ 60 million), Germany (US\$ 50 million) and Taiwan Province of China (US\$ 50 million) (based on FDI relocations data from fDi Markets). In 2020, Huawei's mega R&D centre moved from Seattle to Canada.

* Depending on whether an investment is aimed at serving international or domestic markets, the impact on a country's trade from a specific investment can vary from none to a lot. Moreover, as our paper looks at existing trade flows from all over the world supplying the US and China, FDI coming from the US and China represent only a small – albeit relevant – share of all investments affected by the trade war.

On the other hand, FDI flows from the US to China have remained more stable over the past 4 years. Indeed, between 2016 and 2018, outward US FDI to China fell by 16.1%. In 2019, these figures recovered to pre-trade war levels, albeit largely supported by Tesla's US\$ 5 billion Gigafactory investment in Shanghai, which opened in the last quarter of the year (Hanemann et al., 2020). Despite the positive momentum for US FDI in China in 2019, it is important to highlight that Tesla's investment is mostly aimed at supplying China's and, more broadly, Asia's growing demand for electric cars (Hull and Zhang, 2019). This marks a stark turn from the conventional US export-oriented investments made in China, strongly supporting the GVCs shortening and regionalization trends discussed above. On the matter of relocations, despite its substantially larger outstanding FDI stock in the country, the US has trailed behind China with firms repatriating only roughly US\$ 0.1 billion in investments back to the US between 2018 and 2019. Moreover, during the same period, Viet Nam, Canada and Mexico have received US\$ 0.4 billion, US\$ 0.2 billion and US\$ 0.1 billion, respectively, in relocations projects from the US (based on FDI relocations data from fDi Markets).

Once again, while the trade movements portrayed in our paper are more comprehensive than the FDI flows presented above – relocations and bilateral FDI represent only a small part of investments being affected by the trade war – developments in US-China bilateral FDI relationship since 2017 clearly highlight the trade war's strengthening and accelerating impact on the US-China decoupling process. Furthermore, as Tesla's Gigafactory in Shanghai (among other examples) highlights, US investments in China are considerably changing in nature, being increasingly aimed at serving regional markets, instead of the US'. Lastly, while the relocations data presented herein can be only interpreted as representative (whether an investment embodies a 'relocation' is a self-reported consideration that many firms choose not to disclose), the reported patterns strongly assert the increasing role of alternative production hubs as stated in this paper. Prominent alternatives emerging from FDI data are Mexico, Canada, European Union (EU)

Caveats and limitations

Ultimately, while we explored countries' DVA and GDP dependency dynamics with US' and China's domestic demands in sections 4.1.1.2 (for China's tariffs) and 5.1.1.2 (for US' tariffs), we distanced ourselves from estimating the impacts of the trade war on the US' and China's economic performance.²⁷ Instead, we decided to focus on this paper's main goal and take advantage of our comprehensive data set and methodology to study major GVCs and international trade patterns shifts accurately. We leave a potential merger of our sections 4.1.1.2 and 5.1.1.2 with the impacts presented in this section to future research.

It is also important to note that the analysis herein is based on partial equilibrium (PE) model. The PE model allows us to clearly isolate and track the impacts of policy measures (tariffs) applied at a product-specific level. However, the model has its trade-offs. For instance, it does not capture interactions between other parts of the larger economy. Hence, it does not reveal any indirect impacts of the policy shocks on non-targeted sectors.

Another limitation of our model, is that we further assume that all sectors, as well as both countries (the US and China), share the same trade diversion index. This impacts the distribution of opportunities across countries, but not cumulatively. As different industries display different levels of specialization and technology requirements, it is natural that the extent to which an exported good can be either absorbed domestically or by a foreign nation will differ. Moreover, as neither China nor the US shares the same capital, labour, and technological capacities it is also natural that some products would be more prone to be absorbed domestically in one country and some in another. While some of these nuances are already reflected in import price-elasticity used in our analyses, a more detailed picture could be obtained if industry and tariffed country-specific trade diversion indexes were utilised. We will also leave this to future research.

Lastly, the trade data underpinning the analysis in this paper does not yet capture the profound impacts of the COVID-19 pandemic on GVCs and international trade. Since we use static trade flow information from 2019, the COVID-19 pandemic will likely impact economies worldwide heterogeneously and thus change the trading patterns used herein. Moreover, the COVID-19 pandemic may accelerate the GVC restructuring efforts to address technological and structural changes surrounding GVCs and to diversify risks facing multinational corporations (MNCs) highly reliant on China as a major supply-node (Box 3).

²⁷ While there are some estimates of the impact of the trade war on both China's and the US' economic performance, there are none that meet our methodology's level of disaggregation (product and industry level data). Accordingly, we decided not to include any existing aggregate (country-level) measures of economic harm caused by the trade war in order to avoid impoverishing or watering down our methodology's precise identification of affected industries and countries.

Box 3: COVID-19 implications for GVCs in Asia-Pacific

While being the greatest global health crisis in almost a century, COVID-19 is also leading the global economy into the worst recession since the 'Great Depression' (IMF, 2020a). Estimates put overall GDP contracting at 4.9% for 2020 (IMF, 2020b) and global trade value at 14.5% (ESCAP, 2020). Hence, GVCs – at the heart of global trade – are expected to be affected concomitantly. In fact, the onset of the COVID-19 pandemic is most likely to compound on the above-explored US-China trade war GVC restructuring.

The interlinked nature of GVCs exposes them to a plethora of new risks: with more potential points for failure, there is less margin for absorbing disruptions and a high degree of exposure to supply-chain contagion. Moreover, due to China's role as the largest GVC node, critical disruptions to its economy can have severe impacts on downstream suppliers.

These vulnerabilities were especially laid bare during the beginning of the COVID-19 pandemic, when China's lockdown measures halted the country's manufactured goods production and resulted in a 13.4% year-on-year exported goods value decline over the first quarter of 2020 (ESCAP, 2020). As a result, downstream producers, reliant on Chinese intermediate exports started experiencing disruptions themselves. In the automobile industry, for instance, where 80% of global car production involves at least some component manufactured in China, Hyundai factories in the Republic of Korea and Nissan's in Japan were forced to a halt due to missing components from China shortly after this nation imposed a country-wide lockdown (Lee and Jin, 2021, Shepherd, 2020).

While due to the trade war, most multinational firms were already reconsidering the geographical diversification of their value chains – an early example of this trend being the relocation of supply chains in the textile sector away from China and towards other Asian economies (EIU, 2020) – the COVID-19 pandemic has cemented this impetus.

This is evidenced by the fact that many governments around the world have started taking proactive measures to hedge against trade reliance on a single nation. For instance, Japan – which depends on China for about 37% of its imports of automotive parts and 21% of its imports of intermediate goods – has recently passed a US\$ 2.2 billion stimulus bill to support Japanese manufacturers to shift production outside of China (Olson, 2021c).

Moreover, Taiwan Province of China is also encouraging a similar ASEAN focused expansion of its domestic firms through its New Southbound policy.

Hence, as economies worldwide look to diversify their supply chains away from China, other well-connected regional economies might stand to benefit from this shift. More specifically, ASEAN economies, which are deeply integrated with multiple nodes of global supply chains, are among the biggest potential beneficiaries from GVC relocation away from China. This is evidenced by a number of major manufacturers such as Google and Microsoft shifting production of electronic equipment from China to ASEAN, with Thailand and Viet Nam expected to be key beneficiaries.

Ultimately, going forward, firms are expected to continue enduring a lot of pressure to diversify their sources of supply and near-shore existing GVCs. However, a complete decoupling away from China remains highly unlikely as associated costs remain elevated and the country's position as the world's top producer and – in the coming years – consumer of goods is expected to be reinforced.

7. Conclusion

Overall, the US-China trade war has been a defining moment for international trade and GVCs. For the better part of the last three years, both nations have raised tariffs on each other in an unprecedented way, transforming a fairly open trading environment into a rather protectionist one. More recently, COVID-19 induced global supply-chain disruptions have called into question the popular stance on economic efficiency from extreme specialisation and just-in-time inventories, while highlighting the global economy's supply overreliance on China. All in all, these shocks have significantly changed how companies and governments see the international multilateral trading environment. Indeed, shifting incentives on trade and investments have considerably accelerated the decoupling process between the US and China.

In this paper, we looked at the US-China trade war's impacts on international trade flows to identify potential opportunities and risks for third-party nations. More specifically, we started by looking at available product-level data on US-China bilateral trade. Then, by adopting a new UN-ESCAP WWZ decomposition technique of the ADB MRIO database, we were able to build a simplified modelling framework of 3-country production network²⁸ to track these impacts through international trade linkages and identify the best suited GVCs to substitute foregone US-China bilateral exports. In other words, we were able to thoroughly map out – at the country and industry level –

²⁸ E.g. exports initially sourced from Thailand, passing-through China and arriving at the US.

the intricate connections between exporting and importing economies to understand the true extent of tariffs' impacts on GVCs.

The methodology used in this paper represents a significant development in the way GVCs and international trade are tracked and modelled, since all added value departing from a country can be traced at the country and exporting industry level up to two supply-chain links away from the source. In today's increasingly connected world, this type of supply-chain specialization, involving multiple players from different countries, is no longer a particularity but an embedded feature of the whole system. In fact, it is estimated that intermediate exports used for re-exporting already represent upwards of 15% of all international trade. For that reason, we expect to be engaging with this methodology further in the future.

Our main findings are as follows:

First, from an international trade perspective, when it comes to the direct impact of the trade war on both China and the US, the data shows that both economies – albeit in different magnitudes – are set to lose with the increase in bilateral tariffs. Indeed, solely looking at import-export flows, the US is anticipated to lose US\$ 17.5 billion in exports to China, while China is expected to be hit with US\$ 73.8 billion in foregone exports to the US. While some of the foregone exports will be absorbed domestically, our estimates show that these gains will hardly compensate for the hindering impacts of export reduction. Moreover, taking into account the estimated total US\$ 75.5 billion in tariff value on China's exports and the US\$ 21.4 billion in tariff value on US exports – which research shows that is mostly being paid by importing businesses – the costs of hiking up tariffs significantly outweigh the benefits for both sides.²⁹

Second, the current trade war is expected to redirect large amounts of bilateral trade towards the third-party economies. While the trade war's long-term consequences on GVCs and international trade are still hard to compute, we estimate that since the beginning of it US\$ 61.1 billion in net exports³⁰ have been shifted away towards other economies. Large industrialized economies that are very well-connected with the US and ready to substitute China in its productive capacity like Mexico, Canada, Germany, Republic of Korea, and the United Kingdom are the top beneficiaries from this shift, with their earnings estimated to vary between US\$ 2.0 billion (United Kingdom) and US\$ 6.0 billion (Mexico). On the contrary, China-dependent nations who are very invested in its GVCs like Mongolia and Hong Kong China are expected to have suffered the most with modest damages being inflicted: US\$ 14 million and US\$ 40 million, respectively.

Nevertheless, as the separate analysis of both countries' tariffs' as well as the industry-wise investigation of risks and opportunities show the welcoming of redirected exports

²⁹ On the argument of jobs and economic activity repatriation via the implementation of the tariffs: in line with the outstanding literature, we found no evidence that the trade war has been bringing back jobs and economic activity back to either the US or China..

³⁰ Earned redirected exports deducted from lost intermediate exports going through China or the US.

from the US-China link will not come without transitioning costs. As described in section 5, despite being net profiteers of the trade war, economies like Mexico and Canada – with regards to China’s tariffs – and Australia and Taiwan Province of China – with regards to the US’ – will be dealing with notable export losses in specific sectors. It is thus very important to highlight that while macroeconomic figures point towards a general improvement of most economies’ performance, appropriate redistributive policies are key in compensating local producers suffering from the current GVC restructuring. Governments should be prepared to absorb some of these damages in order to fully benefit from the potential increase in welfare.

Lastly, and contrary to what would be expected, this paper finds that the rise in bilateral protectionism between the world’s two largest economies could actually be fostering international integration and GVCs in two major ways. On one hand, we found that when compared with GVCs passing-through the US or China, other supply-chain networks involve a much higher participation rate of foreign (upstream) added value. This means that by moving away from the US-China link, new GVCs will be more geographically spread-out than before, as other countries tend to have fewer domestic suppliers in different stages of production than China and the US do. On the other hand, as businesses look for alternative routes to avoid paying hindering import tariffs, incentives to diversify investment to economies outside trade-war zones will be reinforced vehemently.

As a result, international trade is moving towards a more diversified supply-chain solution, where multiple countries become involved in substituting a two-economy link. This trend of decoupling between the US and China started as a result of the trade war but is now set to be reinforced in-light of the COVID-19 pandemic and strategic competition.

List of references

- Amiti, M., Redding, S. J., and Weinstein, D. E. (2019). *The impact of the 2018 tariffs on prices and welfare*. *Journal of Economic Perspectives*, 33(4), 187-210.
- Anukoonwattaka, Witada and Lobo, Richard Sean (2019). *Trade Wars: Risks and opportunities for Asia-Pacific economies from US tariffs*. ESCAP TIID Working Paper. Bangkok. Available at <https://www.unescap.org/publications/trade-wars-risks-and-opportunities-asia-pacific-economies-us-tariffs>.
- Asian Development Bank (ADB). 2010—2017 *Multi-Regional Input-Output Tables*. Manila.
- Bekkers, E., & Schroeter, S. (2020). *An economic analysis of the US-China trade conflict* (No. ERSD-2020-04). WTO Staff Working Paper.
- Bown, Chad . P. and Melina Kolb (2018). *Trump's Trade War Timeline: An Up-To-Date Guide*, Washington: Peterson Institute for International Economics (PIIE). Available at: <https://www.piie.com/blogs/trade-investment-policy-watch/trump-trade-war-china-date-guide>
- Bown, C., Zhang, E. and Jung, E., (2021). *US-China Trade War: The Guns of August*. Washington: Peterson Institute for International Economics (PIIE). Available at: <https://www.piie.com/blogs/trade-and-investment-policy-watch/us-china-trade-war-guns-august>.
- Bandyopadhyay, Subhayu, Asha Bharadwaj and Suryadipta Roy (2018). *Taking a closer look at US exports to China*. *St. Louis: Federal Reserve Bank*.
- Bradsher, Keith (2019). *With Higher Tariffs, China Retaliates Against the US*. *The New York Times*, 13 May. Available at <https://www.nytimes.com/2019/05/13/business/trump-trade-china.html>.
- ESCAP (2020). *Trade in Goods Outlook in Asia and the Pacific 2020/2021*. Available at: <https://www.unescap.org/resource-series/asia-pacific-trade-and-investment-trends>.
- Hanemann, Thilo, Daniel H. Rosen, Cassie Gao and Lysenko Adam (2020). *Two-Way Street: 2020 Update US-China Investment Trends*. US-China Investment Project, 8 May. Available at: https://publications-research.s3-us-west-2.amazonaws.com/TWS+2020_Report_8May2020_Final.pdf.
- Hull, Dana and Zhang Chunying (2019). *Elon Musk Set Up His Shanghai Gigafactory in Record Time*. *Bloomberg*, 23 October. Available at: <https://www.bloomberg.com/news/articles/2019-10-23/elon-musk-opened-tesla-s-shanghai-gigafactory-in-just-168-days>.

- Hummels, David, Jun Ishii and Kei-Mu Yi (2001). *The nature and growth of vertical specialization in world trade*. Journal of International Economics, vol. 54, pp. 75–96.
- IMF (2020a). *The Great Lockdown: Worst Economic Downturn Since the Great Depression*. April 14. Retrieved September 2020, from IMF Blog - Insights & Analysis on Economics & Finance: <https://blogs.imf.org/2020/04/14/the-great-lockdown-worst-economic-downturn-since-the-great-depression/>.
- _____(2020b). *World economic outlook update, June 2020: a crisis like no other, an uncertain recovery*. Washington, DC: International Monetary Fund.
- Kee, Hiau Looi, Alessandro Nicita and Marcelo Olarreaga (2008). *Import Demand Elasticities and Trade Distortions*, Review of Economics and Statistics, 2008, vol. 90, no. 4, p. 666—682.
- Lee, J. and Jin, H., (2021). Hyundai to halt South Korea output as China virus disrupts parts supply. U.S. Available at: <https://www.reuters.com/article/us-hyundai-motor-virus-china-idUSKBN1ZY0GG>.
- Li, Minghao (2018). CARD Trade War Tariffs Database. Available at: <https://www.card.iastate.edu/china/trade-war-data/>.
- McCurry, Justin (2019). *Trade wars, tweets and western liberalism: G20 summit wraps up in Osaka*. The Guardian, 29 June. Available at <https://www.theguardian.com/world/2019/jun/29/g20-summit-osaka-japan-trade-wars-liberalism>.
- Moore, Brent (2019). *The impacts of US-China trade dispute on Australian food exports*. Australian Food News. Available at: <https://www.ausfoodnews.com.au/2019/06/18/brent-moore-shares-his-views-about-the-impact-of-the-us-china-trade-dispute-on-australian-food-exports.html>.
- Nicita, A., (2019). *Trade and trade diversion effects of United States tariffs on China*. UNCTAD Research Paper, No. 37(UNCTAD/SER.RP/2019/9). Available at: https://unctad.org/system/files/official-document/ser-rp-2019d9_en.pdf.
- OECD (2017). *International trade, foreign direct investment and global value chains: United States trade and investment statistical note*, Paris: OECD.
- Olson, S., (2020). *Phase One deal doesn't resolve real issues*. Hinrich Foundation. Available at: <https://www.hinrichfoundation.com/research/article/us-china/phase-one-deal/>.
- _____(2021a) *COVID-19 complicates US-China relations*. Hinrich Foundation. Available at: <https://www.hinrichfoundation.com/research/article/us-china/covid-19-complicates-us-china-relations/>.

- _____. (2021b) *Post COVID-19 World: More regional trade and shorter supply chains?* Hinrich Foundation. Available at: <https://www.hinrichfoundation.com/research/article/protectionism/post-covid-19-trade/>.
- Rappeport, Alan and Ana Swanson (2019). *Trump Says China Tariffs Will Increase as Trade Deal Hangs in the Balance*. The New York Times. Available at: <https://www.nytimes.com/2019/05/09/us/politics/china-trade-tariffs.html>.
- Shepherd, C. (2020). *Coronavirus: Chinese carmakers struggle with disruption*. Retrieved from Financial Times: <https://www.ft.com/content/b5392370-53b6-11ea-8841-482eed0038b1>.
- Shastry, Vasuki (2019). *Splintering Global Supply Chains; Asia's Worst Nightmare?* Hong Kong: Asia Global Institute. Available at: <https://www.asiaglobalonline.hku.hk/splintering-global-supply-chains-asias-worst-nightmare/>.
- United Nations Conference on Trade and Development (UNCTAD) (2005). *Developing Countries In International Trade 2005 Trade And Development Index*, New York: UNCTAD.
- United Nations Economic and Social Commission for Asia and the Pacific (ESCAP) (2018). *Asia-Pacific Trade And Investment Report 2018 Recent Trends And Developments*, Sales No. E.19.II.F.3.
- Wang, Zhi, Shang-Jin Wei and Kufu Zhu (2018). *Quantifying International Production Sharing At The Bilateral And Sector Levels*, Cambridge: National Bureau Of Economic Research.
- Wearden, Graeme (2019). *Trump escalates trade war with China with plan to raise tariffs*. The Guardian, 6 May. Available at: <https://www.theguardian.com/business/2019/may/05/trump-escalates-trade-war-with-china-with-plan-to-raise-tariffs>.
- World Bank (2012). *Overall Trade Restrictiveness Indices And Import Demand Elasticities*. Available at <https://datacatalog.worldbank.org/dataset/overall-trade-restrictiveness-indices-and-import-demand-elasticities>.

Annex A.

Figure A.1 and A.2 illustrate the sectoral distribution of US' and China's tariffs, respectively, in the event of a further escalation (as per section 2. Background). Escalation is understood as the implementation of previously suspended and rolled back tariffs, as explained below:

- US – implementation of the second round of Phase 4 tariffs; 7.5pp increase in the first round of Phase 4 tariffs (currently rolled back).
- China – implementation of the second round of Phase 4 tariffs.

Figure A. 1 US' tariffs on China's exports per industry – escalation

(Millions of US\$ / %)

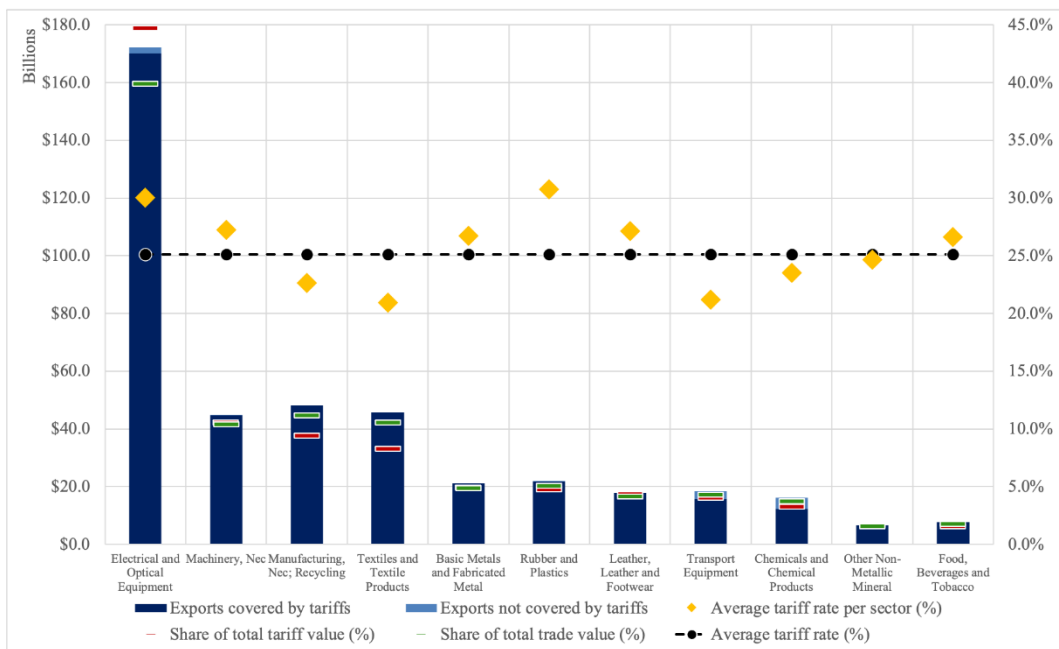

Source: Authors, based on CARD Trade War Tariffs Database and on 2017 product-level international bilateral trade data obtained from WITS Database (accessed April 2020).

Notes: Herein all tariffs implemented during the period 2018-2020 are represented (PHI deal inclusive). The *Average tariff rate* is calculated as explained in section 2. Background but aggregated at the sector level. *Share of total tariff value* corresponds to the share of tariff value in a specific sector, where the tariff value is calculated as the product of a sector's export value in 2017 with the corresponding average tariff rate. Sectors are ordered by descending *Share of tariff value*. For brevity, all sectors with negligible tariff coverage (<2%) were excluded from the figure. Sectoral classifications follow ADB MRIO database nomenclature.

Figure A. 2 China's retaliatory tariffs on US exports per industry – escalation

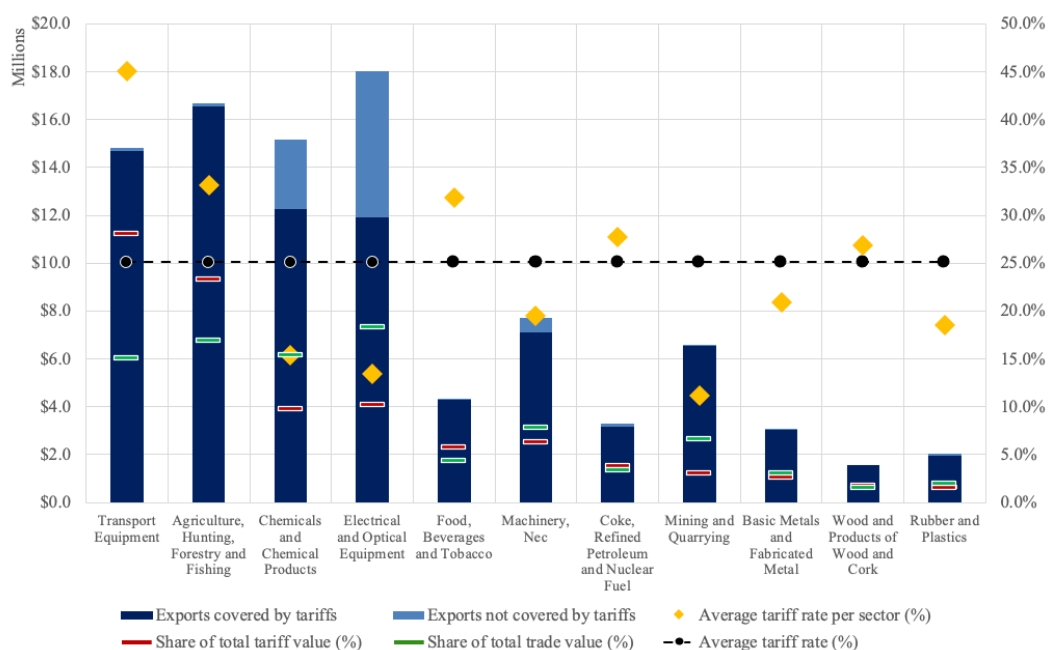

Source: Authors, based on CARD Trade War Tariffs Database and on 2017 product-level international bilateral trade data obtained from WITS Database (accessed April 2020).

Notes: Herein all tariffs implemented during the period 2018-2020 are represented (PHI deal inclusive). The *Average tariff rate* is calculated as explained in section 2. Background but aggregated at the sector level. *Share of total tariff value* corresponds to the share of tariff value in a specific sector, where the tariff value is calculated as the product of a sector's export value in 2017 with the corresponding average tariff rate. Sectors are ordered by descending *Share of tariff value*. For brevity, all sectors with negligible tariff coverage (<1%) were excluded from the figure. Sectoral classifications follow ADB MRIO database nomenclature.

Figure A.3 compares the reported US-China bilateral exports from 2017 to 2019 – adjusted to reflect 2017 prices³¹ – with this paper’s estimation of the tariff’s impact.

Figure A. 3 Actual and estimated effect of tariffs on bilateral trade between the US and China – 2017 prices

(Billions of US\$ at 2017 prices)

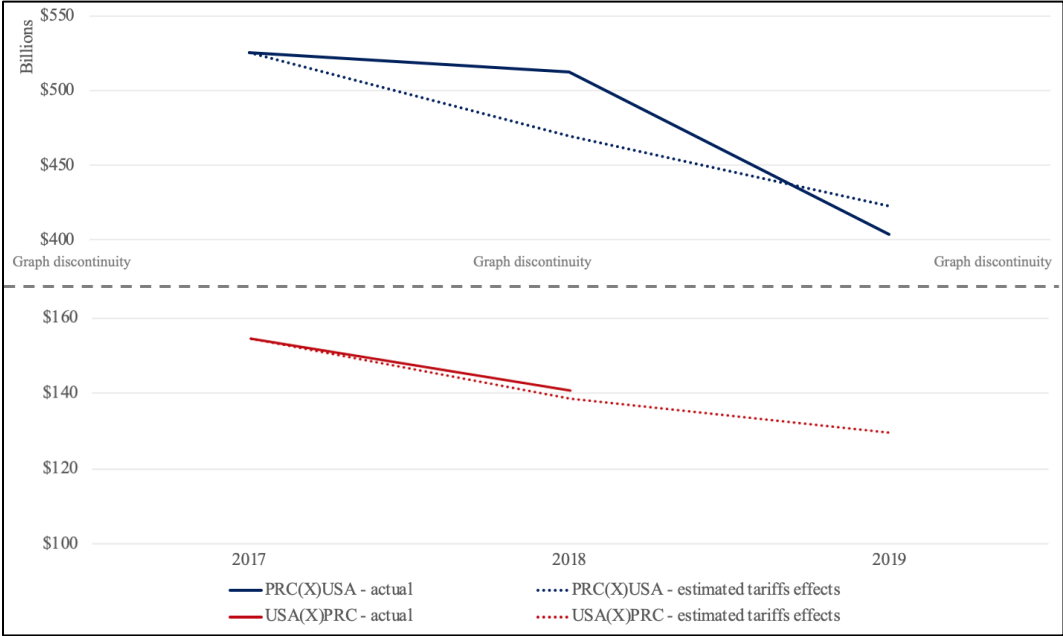

Source: Authors, based on CARD Trade War Tariffs Database and on 2017 product-level international bilateral trade data obtained from WITS Database (accessed April 2020).

Notes: PRC(X)USA stands for China’s exports to the US; USA(X)PRC stands for US exports to China. Herein bilateral trade between the US and China totals roughly US\$690 billion, whereas in the main text the number US\$563.9 billion is mentioned. This difference is given by the neglect of double-counted terms in the main text. This has no impact on our analysis.

Annex B.

Figure B.1 illustrates the relevant GVCs and international trade channels through which the US’ tariffs might propagate risks and opportunities to third-countries. First, it lays out all of a general country *i*’s direct commercial relationships with the US (X_USA), China (X_PRC), and the Rest of the World (RoW)(X_RoW). Second, it identifies relevant subsets of X_PRC and X_RoW, such as FVA_PRC_USA and FVA_RoW_USA – intermediates used in the production of exports to the US through China and RoW, respectively –, or 3. – exports to China consumed domestically. Last,

³¹ To retrieve 2017 price levels, we divided import values reported in each year by the tariff increases that occurred up to that year. This method assumes a full pass on of the tariffs to buyer and a negligible inflation for the considered period. This is consistent with this paper’s methodology and the outstanding literature on the issue.

7. and 8. symbolize tariff-induced supply-side changes, where the former denotes businesses moving from China to country *i* and the latter denotes businesses moving from China to other countries. Drawing from the figure below, two main risks and one main opportunity were identified for country *i*.

Figure A. 4 US’s tariffs: Direct and indirect links with China, US and Rest of the World – country *i*

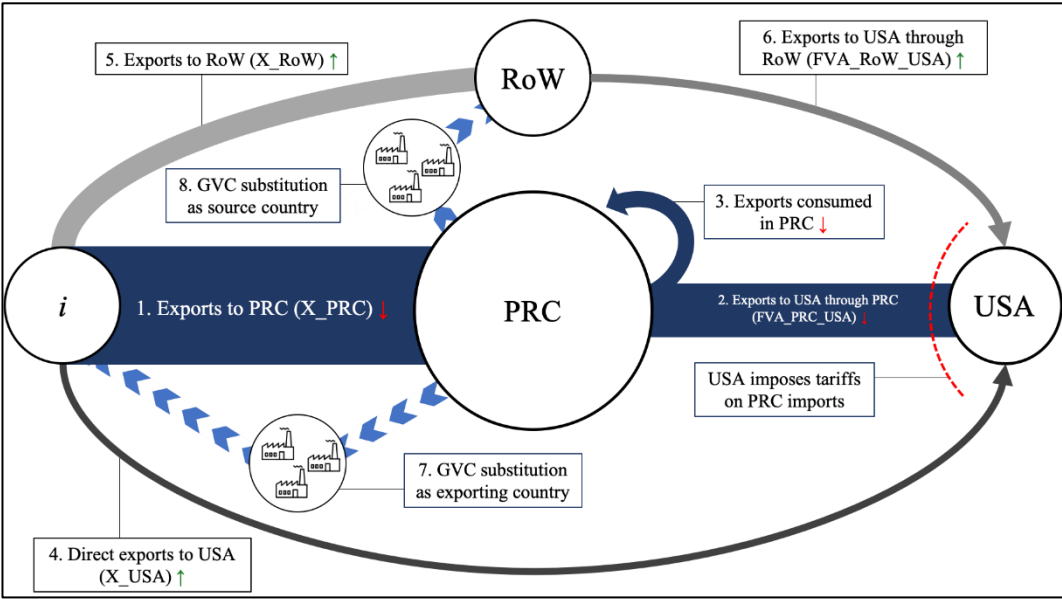

Source: Authors.

Notes: PRC stands for People’s Republic of China, USA for United States of America and RoW for Rest of the World, as per the MRIO nomenclature used in this paper.



The Asia-Pacific Research and Training Network on Trade - ARTNeT - is an open network of research and academic institutions and think-tanks in the Asia-Pacific region. Since its inception, ARTNeT aims to increase the amount of high quality, topical and applied research in the region by harnessing existent research capacity and developing new capacities. ARTNeT also focuses on communicating these research outputs for policymaking in the region including through the ARTNeT Working Paper Series which provide new and policy-relevant research on topics related to trade, investment and development. The views expressed in this publication are those of the authors and do not necessarily reflect the views of the United Nations and ARTNeT secretariat or ARTNeT members.

Readers are encouraged to quote or reproduce material from ARTNeT Working Papers for their own publications, but as the copyright holder, ARTNeT requests due acknowledgement and a copy of the publication.

This and other ARTNeT publications are available from artnet.unescap.org

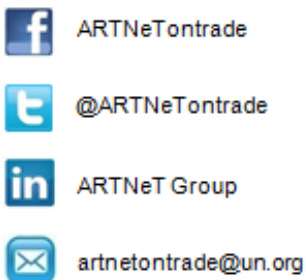

ARTNeT Secretariat, United Nations ESCAP

Rajadamnern Nok Avenue

Bangkok 10200, Thailand

Tel: +66(0) 22881410

Fax: +66(0) 22881027