

Gius, Grace et al.

Article

Hot diodes! Dirt cheap cooking and electricity for the global poor?

Development Engineering

Provided in Cooperation with:

Elsevier

Suggested Citation: Gius, Grace et al. (2019) : Hot diodes! Dirt cheap cooking and electricity for the global poor?, Development Engineering, ISSN 2352-7285, Elsevier, Amsterdam, Vol. 4, pp. 1-9,
<https://doi.org/10.1016/j.deveng.2019.100044>

This Version is available at:

<https://hdl.handle.net/10419/242302>

Standard-Nutzungsbedingungen:

Die Dokumente auf EconStor dürfen zu eigenen wissenschaftlichen Zwecken und zum Privatgebrauch gespeichert und kopiert werden.

Sie dürfen die Dokumente nicht für öffentliche oder kommerzielle Zwecke vervielfältigen, öffentlich ausstellen, öffentlich zugänglich machen, vertreiben oder anderweitig nutzen.

Sofern die Verfasser die Dokumente unter Open-Content-Lizenzen (insbesondere CC-Lizenzen) zur Verfügung gestellt haben sollten, gelten abweichend von diesen Nutzungsbedingungen die in der dort genannten Lizenz gewährten Nutzungsrechte.

Terms of use:

Documents in EconStor may be saved and copied for your personal and scholarly purposes.

You are not to copy documents for public or commercial purposes, to exhibit the documents publicly, to make them publicly available on the internet, or to distribute or otherwise use the documents in public.

If the documents have been made available under an Open Content Licence (especially Creative Commons Licences), you may exercise further usage rights as specified in the indicated licence.



<https://creativecommons.org/licenses/by-nc-nd/4.0/>



Hot diodes!: Dirt cheap cooking and electricity for the global poor?

Grace Gius^a, Matthew Walker^b, Andre Li^c, Nicholas J. Adams^c, Robert Van Buskirk^d, Pete Schwartz^{c,*}

^a Industrial Engineering, California Polytechnic State University, San Luis Obispo, CA 93407, USA

^b General Engineering, California Polytechnic State University, San Luis Obispo, CA 93407, USA

^c Physics, California Polytechnic State University, San Luis Obispo, CA 93407, USA

^d Kiyere! Berkeley, CA, 94705, USA

ARTICLE INFO

Keywords:

Direct DC Solar Cooking

DDS

ISEC

Insulated Solar Electric Cooking

ABSTRACT

Direct DC Solar (DDS) electricity can inexpensively cook food and charge appliances. Insulating the cooking chamber allows the food to cook with a lower-power (less expensive) solar panel over a longer cooking time. We explain how using a chain of diodes instead of a resistive heater extracts more energy from a solar panel over a variety of solar intensities and also acts as a rough, inexpensive voltage regulator to charge batteries and power appliances. We show how a diode heater produces more heat from a solar panel than either a DDS resistive heater or a PWM/battery-connected resistive heater, averaged over a wide variety of solar intensities. The resulting cost of electricity is already cost competitive with biomass cooking in many areas. Benefits include inexpensive access to electricity as well as reductions in indoor air pollution, deforestation, and cost/burden of providing cooking fuel. With continued decrease in the price of solar panels, DDS will become ever more effective for bringing electricity and electrical cooking to the global poor.

1. Introduction: the challenge of cooking and electricity access

The World Health Organization estimates that three billion people cook with biomass and coal, which causes 4 million deaths per year from breathing the associated emissions (WHO, 2018). Besides the dangers of indoor air pollution (Lim et al., 2012; Subramanian, 2014), cooking over open fires also results in deforestation, and greenhouse gas emissions of CO₂ and soot (MacCarty et al., 2008; Bailis and Kammen, 2005). Independent of cooking, universal access to reliable, inexpensive, renewable electricity is a major global concern, especially access for the billion people without electricity access (Rao and Shonali, 2017). Solar Electric Cooking (SEC) is a solution to these two important challenges for the global poor: improved cooking and affordable electricity access.

With strongly declining cost trends for solar panels and batteries (Kavlak et al., 2018; Barbose, 2016; Swanson, 2006), there has been a renewed interest in the contribution that solar-electric cooking can make in advancing the clean and modern energy cooking transition in developing countries (Batchelor, 2015; Simon et al., 2011; Lombardi et al., 2019).

In traditional solar home electricity systems, voltage control is

obtained by using a battery with a maximum peak power tracking (MPPT) charge controller (Tefahunegn et al., 2011). This type of system is likely cost prohibitive to the lowest income households (Grimm and Peters, 2016). The continued decrease in solar panel price means that the predominant cost in a home solar electric system will soon be (or already is) the processing and storage of electrical energy. It is the reduction of this cost that is necessary to bring electrical services to the poorest of the poor. Our diode-based DDS technology can drastically reduce these costs, if not eliminate them altogether.

2. Background: direct DC solar and insulated solar electric cookers

In 2016, we introduced ISEC, Insulated Solar Electric Cooking, whereby solar electricity directly heats food in a well-insulated chamber (Watkins et al., 2017). The insulation greatly reduces heat loss, allowing the food to cook with much lower power. A lower power solar panel (we use ~ 100 W) greatly reduces the cost of the ISEC, but requires a long time to cook the food. For reference, 100 W will bring about 5 kg of food to a boil over the course of the day.

* Corresponding author.

E-mail address: pschwartz@calpoly.edu (P. Schwartz).

The innovation discussed herein is to use a diode chain rather than a resistive heater¹ to heat the food. By switching from resistance to diode-based heating, we inexpensively and optimally convert PV electricity to thermal energy for cooking, while sharing electricity with USB ports, 12 V batteries, and other uses.

3. Methods: heating with diodes

Our previous ISEC cooker design used a resistive heating element, specifically Nickel Chromium (NiCr) wire. The wire's constant resistance draws power at the maximum power point voltage (V_{mp}) only at a single solar intensity. Because voltage across a resistor is proportional to current, other solar intensities provide current at a different voltage, resulting in reduced power draw.

Because the voltage drop across a diode is nearly independent of current, a chain of diodes connected to a solar panel can draw a range of currents corresponding to a wide range of solar intensities while maintaining a constant voltage close to V_{mp} . This allows a diode chain to draw close to maximum possible power from a solar panel over a wide range of solar intensities.

Various 12 V insulated cookers are readily available in international markets.² Such cookers use resistive heaters and typically require regulated power to maintain proper electrical operating conditions, including a fixed voltage. The diode-based heaters do not require regulated DC power, but operate well when connected directly to a solar panel.

In addition, because the voltage drop across a diode remains nearly constant under a wide range of currents (solar intensities), the correct number of diodes can roughly define any voltage necessary to charge batteries or power a USB port or a DC appliance. For more precise voltage outputs, an inexpensive voltage control chip can be used.

Fig. 1 illustrates the difference between a standard battery-based solar PV cooking system and a diode-based solar PV cooking system. We replace the voltage controls in the conventional system with the diode chain heater itself. For two systems producing the same amount of power, the diode system is cheaper and simpler, but does not have the ability to store electrical energy.

3.1. Diode heating elements: design

Diode chains can be either glued to the exterior of the cooking chamber (Fig. 2) or secured inside aluminum tubing as immersion heaters. We report herein only about externally-glued diode heater chains. A thermostatic switch is included in the circuit to protect the system from getting too hot. The pot assembly is surrounded by insulation (see experiment). By attaching access wires between some diodes, we were able to change the number of diodes between experiments. For data reported herein, the diode chain includes 20 diodes in the circuit.

In order to keep the diodes from overheating, they are thermally connected to the cookpot. A thermostatic switch, also connected to the cookpot interrupts the circuit above a predetermined temperature. Thus, it is important to anchor the diodes with an adhesive that is high temperature, thermally conductive, and electrically insulating. See experiment for details.

3.2. Experiment: comparing three heating technologies

In an effort to quantify the output of the diode heater under varying solar intensities and compare it to that of other heating technologies, we collected data on three different cooking technologies connected to identical 100 W solar panels (Fig. 3):

- 1) Direct connection to a 3 Ohm resistive immersion heater.
- 2) Direct connection to a heater consisting of a chain of diodes.
- 3) Connection to a PWM (pulse width modulator) charge controller, which charged a 10 Ah SLA battery and powered a 12 V, 150 W immersion heater.

The experiment was run for roughly 100 days from December 2018 to March 2019. Each solar panel was connected to a 4-quart cookpot (Fig. 4), that contained 3 L of water and used one of the three heating technologies described above. Each cookpot was insulated by standard pink fiberglass insulation below and around the perimeter up to the pot's rim. The tops of the pots were not insulated in order to prevent excessive boiling. Data loggers recorded the voltage and current from each solar panel, the temperature of the water in each cookpot, and the temperature of the hottest external part of the diode, which we found to be where the metal lead wire enters the diode body. Because the hottest part of the resistive heaters was immersed in the water, while the hot diode chain is external to the pot, the diode heater lost more heat to the outside than either of the resistive immersion heaters. Additionally, random differences in the insulation prevent us from making precise comparisons in heater efficiency. We provide water temperature data to illustrate general behavior and trends.

4. Results: measuring power and temperature

We found that under strong sunlight, both the diode chain and direct-connect resistor heated the water considerably better than the PWM/Battery resistor (Fig. 5). However, under decreasing solar intensity, the power supplied by the direct-connect resistor decreased more than did the diode heater, to the point that (Fig. 5 far right) under very low sunlight, there was essentially no temperature rise in the direct-connect resistor pot. The difference between the temperature of the diode heater and the water in the diode cook pot should be proportional to the amount of power delivered from the diode chain to the water. Under full sunlight, when the diode heater is dissipating nearly 100 W, the difference in temperature between the water and the diode chain is about 70 °C.

4.1. Solar panel calibration

We generated solar panel output curves for one solar panel under three different solar intensities (Fig. 6): at 1:00 p.m. (roughly local solar noon), 9:30 a.m. (3 ½ hours before solar noon), and 5:00 p.m. (4 h after solar noon). Near solar noon, maximum output is close to 100 W at a maximum power point voltage, $V_{MP} \sim 17$ V, and maximum power point current, $I_{MP} \sim 5.7$ A. Decreased solar intensity results in a decrease in current, while voltage remains relatively constant. Solar panel output voltage decreases slightly with increased solar panel temperature. Note that the lowest temperature in the morning corresponds to a shift to higher voltage, while solar noon's highest temperatures shift the curves to lower voltage.

4.2. Theoretical power output

The electrical properties of the load determine the power output of the solar panel by defining the operating point on the solar panel output curve (Fig. 6). Because power is the product of current and voltage, the power output to a load is the area of the rectangle defined by the operating point on the current-voltage graph of the solar panel output curve. Fig. 7 illustrates how different simplified electrical heating strategies extract power from the solar panel under these three solar intensities.

An idealized diode and an idealized PWM/battery-resistor extract power from the solar panel at 17 V and 12 V, respectively. Because voltage *remains constant* under all solar intensities for these two heating scenarios, power decreases *proportionally* with a decrease in solar panel

¹ Patent Pending.

² E.g. https://www.ebay.com/sch/i.html?_nkw=12V+DC+cooker or <https://www.alibaba.com/trade/search?SearchText=12V+DC+cooker>.

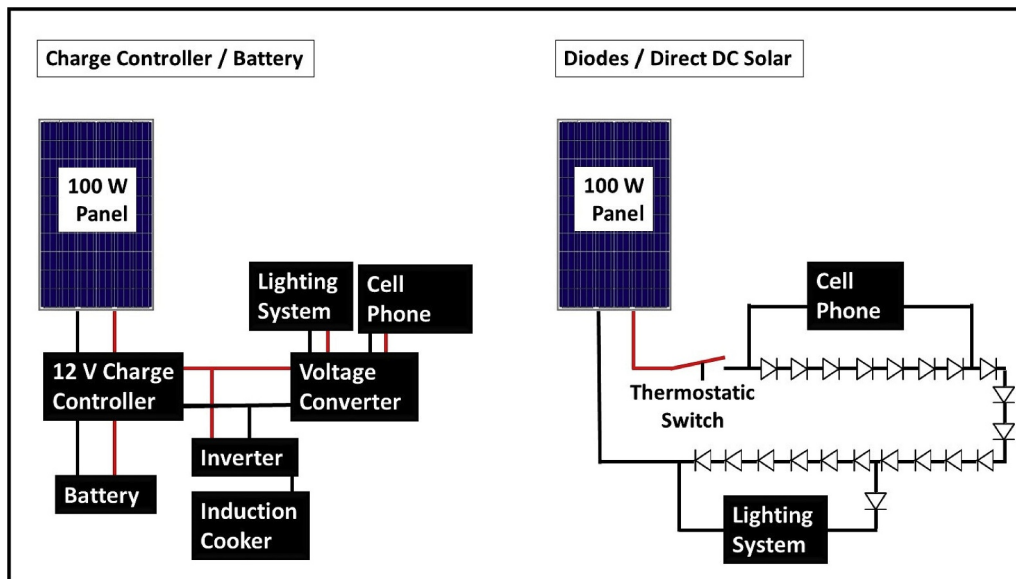

Fig. 1. Conventional solar electric systems (left) cost well over \$150 with considerable maintenance costs, but can provide some stored electricity on demand. A diode chain (right) costs well under \$10, but requires adaptation to make optimal use of solar electricity during the day.

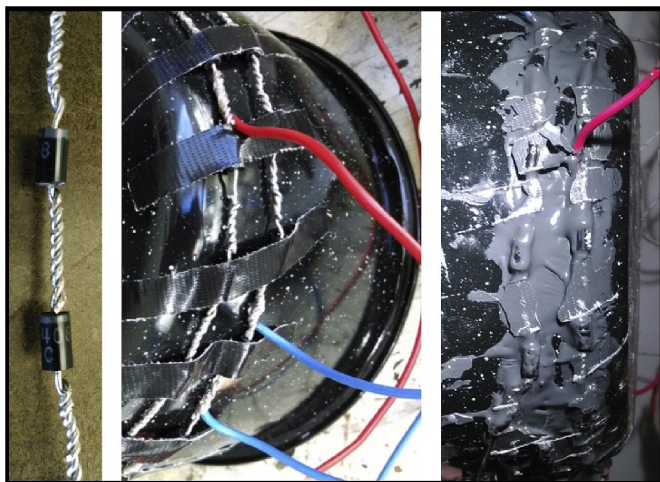

Fig. 2. A diode chain is made by twisting diodes together (left), securing the chain to the bottom perimeter of a pot (middle), and gluing with a high-temperature glue (right).

current output (proportional to the solar intensity). The diode heater may then extract more power from the solar panel than does the PWM charge controller by a factor of nearly 17/12, producing about 40% more heat than the PWM/battery/resistive heater assembly. In contrast, the direct-connect resistive heating element establishes a *linear* relationship between current and voltage ($V = IR$): as the current drops through the resistive element (red line in Fig. 7 left), the voltage drops proportionally. Thus, the power extracted from the solar panel by the direct-connect resistive heater drops like the *square* of the current (or solar intensity).

Fig. 7 (at right) illustrates that the direct-connect resistive heater performs as well as the diode heater at optimal solar intensities, but greatly decreases in power with lower solar intensities. A resistive element with greater resistance would have a smaller slope in the solar panel I-V curve (Fig. 7 left) resulting in higher operating voltages (and power) for lower solar intensities, but reduced current (and power) under strong solar intensities. Our resistive element somewhat compromises strong and weak sunlight scenarios, having a resistance



Fig. 3. Three 12 V, 100 W solar panels facing approximate solar noon (1:00 p.m. local time), receive sunlight from 9:00 a.m. to 5:00 p.m.

slightly greater than that necessary to optimize maximum sunlight.

4.3. Daily variations in power

Fig. 8 shows the following data for the direct-connect diode heater on a cloudless day: solar panel voltage and current output (bottom graph), and the temperatures of the water and of the diode chain (top graph). In the 8 h of direct sunlight between 9 a.m. and 5 p.m., the diode current traces the cosine distribution expected from the change in solar angle while the voltage across the diode chain remains relatively constant. The small, steady drop in voltage during this time is the result of increased diode temperature.

Fig. 9 depicts the evolution of the voltage and current from the solar panels connected to the PWM charge controller (top graph) and the direct-connected resistive heater (bottom graph). The PWM voltage is bimodal because the charge controller connects the solar panel to the battery and cycles the 1 Ohm resistive load on and off. Connecting the load reduces the battery/solar panel output voltage. The charge controller cycles at a period that is considerably shorter than the 10 s data collection time. This drop in battery voltage is larger in morning



Fig. 4. Each solar panel powered a different heating technology in three insulated cook pots made of 4-quart steel pots insulated with pink fiberglass insulation around the perimeter and below (but not above), containing 3 L of water. (For interpretation of the references to colour in this figure legend, the reader is referred to the Web version of this article.)

and evening when the current supplied by the solar panel is reduced. This difference in voltage represents a loss of about 20% of energy stored in the battery, but would be less for a larger, more expensive battery.

The current and voltage for the direct-connect resistor are proportional: both curves are flattened at the top compared to the cosine

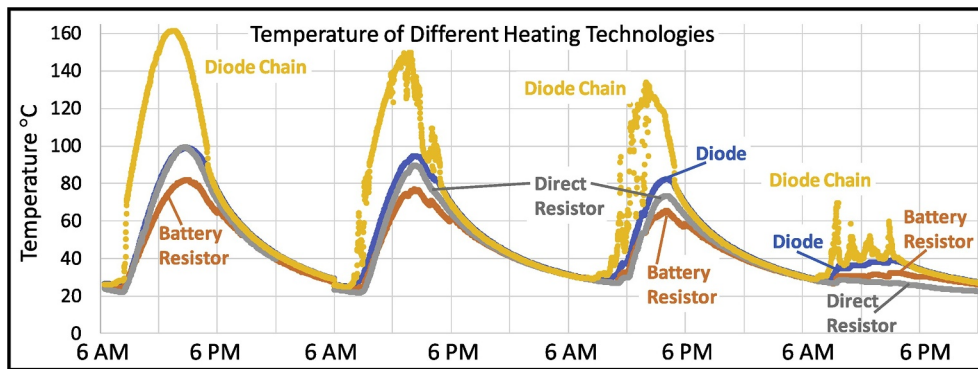

Fig. 5. Each solar panel powered a different heating technology in three insulated cook pots (Fig. 4) containing 3 L of water. The graph shows the temperature of the water in each cookpot as well as the temperature of the diode chain (yellow) on the diode-heated pot. The first day of near perfect sunlight is discontinuous (cut at 6AM) from the following three consecutive days of diminishing sunlight intensity. (For interpretation of the references to colour in this figure legend, the reader is referred to the Web version of this article.)

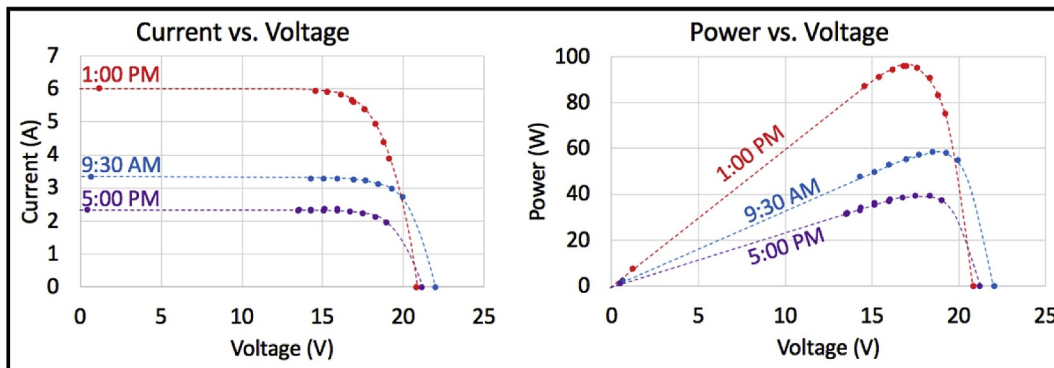

Fig. 6. Calibration of (nominally) 12 V, 100 W solar panels under three different solar intensities. Reduction of solar intensity reduces the current, but not the voltage. The maximum power voltage stays relatively constant under all intensities at about 17 V. The dotted trend lines are provided as a guide to the eye.

intensity evolution of the diode and PWM curves because the resistance of the immersion heater was chosen to balance high and low sunlight as described above.

Fig. 10 illustrates the real behavior of the diode chain heater and resistive elements that were simplified in Fig. 7. PWM/battery data are not included. While the behavior of the resistive element is close to the theoretical behavior depicted in Fig. 7, the diode exhibits both an exponential rise in current with increased voltage as well as a hysteresis caused by the increase in diode temperature during the course of the day. That is, the diodes are hotter in evening (because the water that the diodes are thermally connected to are hotter) reducing the diode voltage drop.

4.4. Diode thermal robustness

We make diode chains from rectifier diodes 1N5402, available for about \$0.04 per diode with purchases of 1000 or more. The diodes are rated at 3 A and a maximum temperature of 150 °C, although our use of the diodes greatly exceeds both of these specifications. We have found that the diodes are destroyed in stagnant air when the temperature of the base of the wire lead (the hottest external part of the diode) exceeds 280 °C, with currents of about 11 A. It is the temperature, not the current, that destroys the diodes: Diodes immersed in 30 °C water are undamaged while passing up to 40 A while maintaining a diode surface temperature below 90 °C Thus, adequately heat sinking the diodes to the cooker allows the diode to sustain higher current and provide more power. The diode heater in the present publication has been used well over 100 times over the past 9 months: the first four months for data collection heating water and subsequently for domestic cooking.

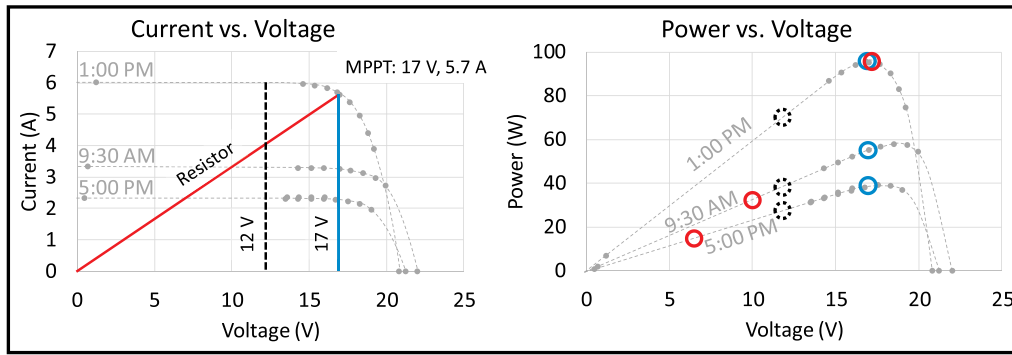

Fig. 7. Left: A resistor connected to a solar panel (red) receives increased voltage for higher solar intensities. In contrast, at all solar intensities an idealized charge controller (black dotted line) extracts power from the solar panel at 12 V, and an idealized diode chain (blue) can extract power near MP, the maximum power point. Right: The diode heater and resistive heater both draw the maximum power under full sunlight, but the power drawn by the resistive heater drops off more with reduced solar intensity than that of the diode and charge controller because the voltage also drops with decreased current. (For interpretation of the references to colour in this figure legend, the reader is referred to the Web version of this article.)

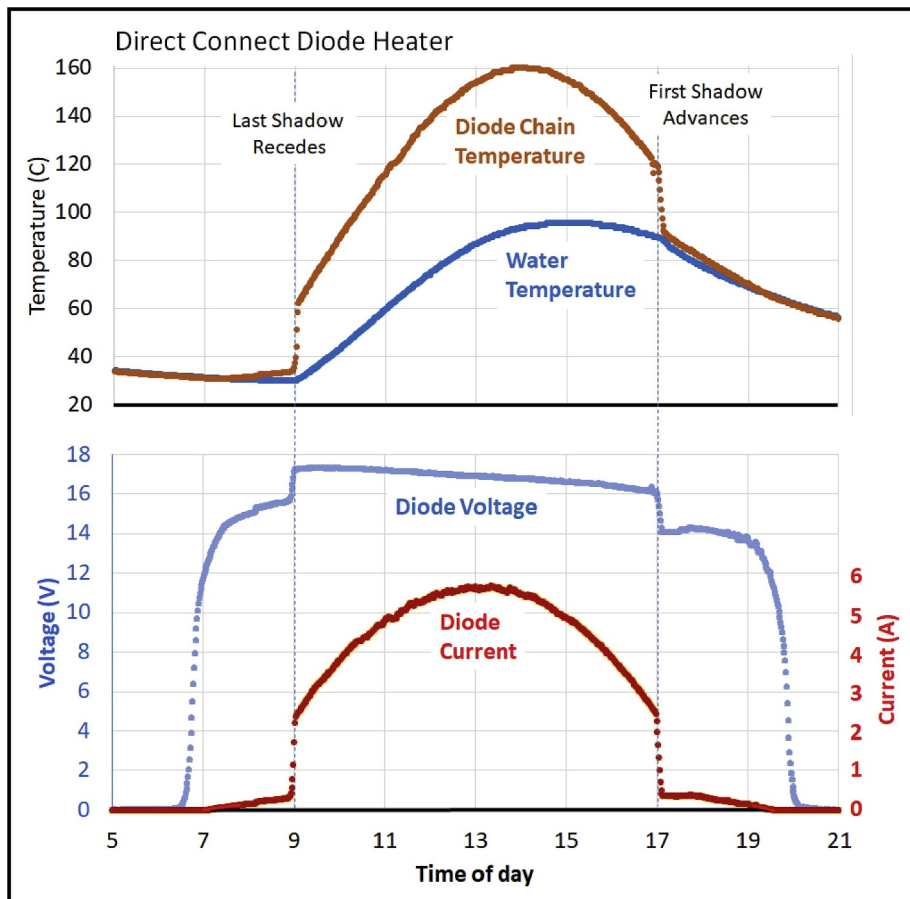

Fig. 8. Below, the voltage (blue) and current (red, axis at right) from the solar panel connected to the diode-heated cookpot. The graph above shows the evolution of cookpot water temperature as well as the temperature of the diode chain itself. (For interpretation of the references to colour in this figure legend, the reader is referred to the Web version of this article.)

5. Results: cost of electricity and comparison with other technologies

Most of the grid-connected world pays between \$0.05 and \$0.30 per kWh of electricity (approximately the amount of electrical energy stored in an average car battery and enough energy to power an electric stove

top for an hour). For much of the global poor, electricity for lights is provided by disposable batteries. A \$0.30, 1.5 V “C” cell with a capacity of 6 Amp-hours provides 9 Wh, or 0.009 kWh, yielding a cost of electricity of \$33/kWh, or more than 100 times the cost of grid electricity paid by the wealthy.

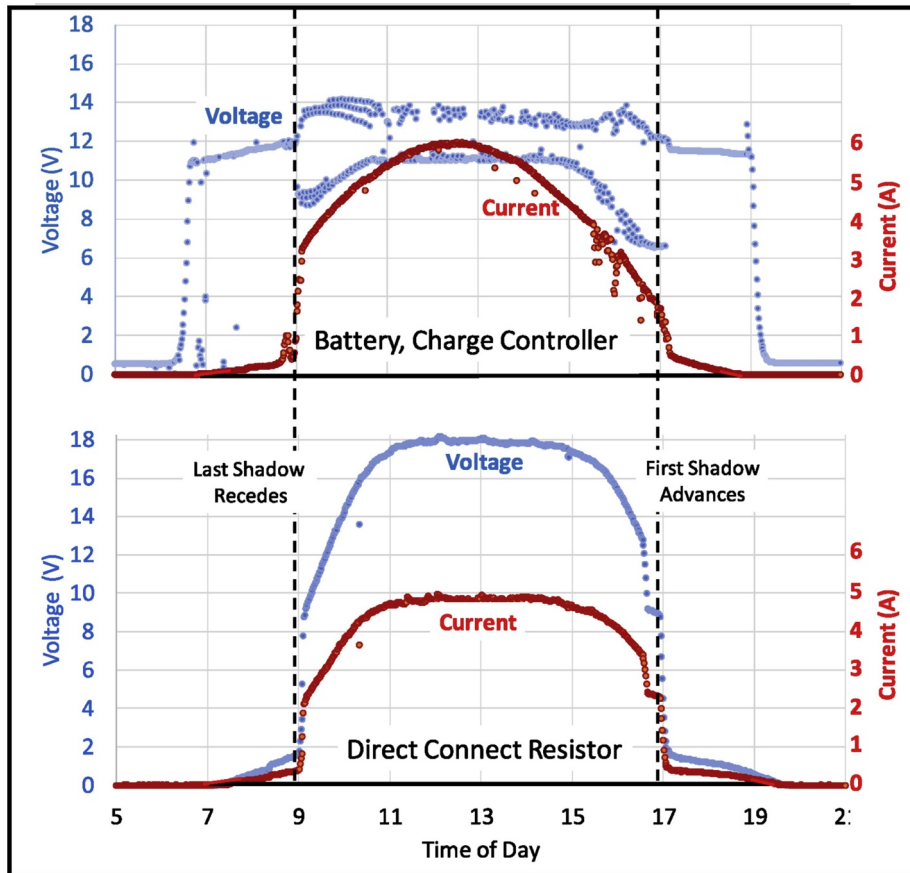

Fig. 9. Voltage and current (axis at right) evolution during a cloudless day for the solar panels connected to the direct-connect resistive heater (below) and the PWM controller storing energy in a battery (above).

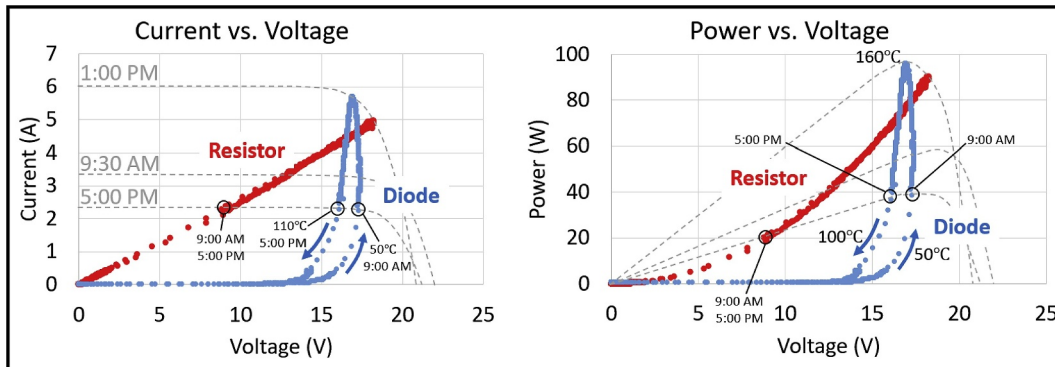

Fig. 10. The real behavior of the direct-connect resistive heater (red) and the diode heater (blue) depicted in Fig. 7. (For interpretation of the references to colour in this figure legend, the reader is referred to the Web version of this article.)

$$\text{cost of electricity, "C" cell battery} = \frac{\$0.30}{0.009 \text{ kWh}} = \$33 / \text{kWh}$$

A recent publication (Batchelor et al., 2018) compares the economic viability of conventional combustion cooking with a solar electric cooking technology that stores the electrical energy in a battery. They find that solar electric cooking will be cost competitive if the cost of electricity falls between \$0.10/kWh and \$0.30/kWh. However, this study did not consider ISEC's much lower cost whereby the thermal energy is stored throughout the day in the food itself. Below, we calculate the cost of electricity from a 100 W ISEC three different ways:

- a) The purchase cost is paid over a single year. This may be relevant because very poor subsistence farmers often do not plan beyond the next harvest.
- b) The purchase cost is paid over 10 years. This may be relevant because the systems will likely be used for 10 years or more.
- c) The Levelized Cost Of Energy (LCOE) where the system is paid for with a loan at the local interest rate. We chose a 10-year loan, although the systems should last much longer.

While the parts for a 100 W ISEC system including solar panel and charging capability cost well under \$50, we estimate the cost to be \$100 with all construction, management, and distribution costs. We can set a

reasonable upper limit of annual energy produced (AEP) by assuming our system puts out 100 W for 6 h every day:

$$AEP = 0.100 \text{ kW} * 365 \text{ day} * 6 \frac{\text{h}}{\text{day}} = 219 \text{ kWh}$$

Interest rates for African countries vary between $i = 10\%$ and $i = 20\%$, thus the capital recovery factor (CRF) for an $n = 10$ -year loan at a 10% interest rate would be:

$$CRF = \frac{i(1+i)^n}{(1+i)^n - 1} = \frac{0.1(1+0.1)^{10}}{(1+0.1)^{10} - 1} = 0.163 = 16.3\%$$

Similarly $CRF = 23.9\%$ for a 10-year, 20% interest rate. Thus, the three electricity costs would be:

$$a) \text{ cost for 1 year} = \frac{\$100}{219 \text{ kWh}} = \$0.46 / \text{kWh}$$

$$b) \text{ cost for 10 years} = \frac{\$100}{2190 \text{ kWh}} = \$0.046 / \text{kWh}$$

$$c) LCOE \left(10 \text{ year, } 10\% \text{ interest rate} \right) = \frac{CRF(\$100)}{219 \text{ kWh}} = \$0.074 / \text{kWh}$$

$$LCOE(10 \text{ year, } 20\% \text{ interest rate}) = \frac{CRF(\$100)}{219 \text{ kWh}} = \$0.109 / \text{kWh}$$

It may be reasonable for the reader to double all of these costs, allowing it to be sunny only half the time. At the same time, the cost of producing solar panels has been decreasing by 50% every 2 ½ years for the last decade (Kavлак et al., 2018), and production and distribution costs should also come down with increased experience. Additionally, our costs include the cooker itself, which Batchelor's calculations do not. Thus, ISEC with DDS electricity may already be cost competitive with biomass cooking in most of Africa, *if a large portion of the thermal energy is consumed and valued by the user.*

It is thermal energy rather than electrical energy (calculated above) that is of value in cooking. The insulation in an ISEC enables a higher heating efficiency than does electrical cooking without insulation. Thus, calculations comparing $\$/\text{kWh}_{\text{thermal}}$ rather than $\$/\text{kWh}_{\text{electric}}$ further lower the cost of ISEC use relative to both grid electricity as well as biomass fuel, because the calculations from Batchelor et al. (2018) compared biomass to electrical energy of a standard electrical cook top.

5.1. Design considerations

In order to maximally extract power from a solar panel, the diode chain must have the correct number of diodes to match the voltage output of the solar panel, as that shown in Fig. 10. To this end, consider:

- If the number of diodes is less than optimal, the voltage across the diode chain is lower, resulting in a slight reduction in power. However, too many diodes will shift the diode curve to right resulting in a large decrease in power because the solar panel voltages may not be sufficient to open the diodes.
- The voltage across the diode chain decreases with increased diode temperature.
- The solar panel output voltage drops with increased panel temperature. While the V_{OC} only drops $= -0.32\%/^{\circ}\text{C}$ of panel temperature over 25°C , the panel's maximum power drops $= -0.45\%/^{\circ}\text{C}$, while I_{SC} increases at $+0.04\%/^{\circ}\text{C}$, indicating a shift in V_{MP} of about $= -0.49\%/^{\circ}\text{C}$. Close inspection of Fig. 7 at right reveals that between 9 a.m. and 1 p.m., V_{OC} shifted by about -1.2 V , while V_{MP} shifted by about -2.0 V , both corresponding to a temperature increase of about 20°C . In hot areas, one should expect panel temperature increases of 40°C , corresponding to a drop of 4 V on a nominally 18 V solar panel.

A voltage drop across long, thin wires between the solar panel and the ISEC will result in an additional voltage demand on the solar panel, reducing power output. As an example, consider Fig. 11. If the wires from the solar panel to the cooker totaled 1 Ohm (red trace, corresponding to 20 gauge wire at a distance of 15 m each way), the operating current (and the resulting power to the diode chain) would be roughly cut in half.

5.1.1. Design recommendations

- It is better to err on the side of using too few diodes than too many.
- Rather than attempting to save money by purchasing thin (high gauge) wires to connect the panel and cooker, wires should be as short and thick (low gauge) as possible.
- In addition to the lead wires connected to each end of a diode chain, connecting extra wires between the diodes allows the user to easily change the number of diodes in the chain.
- The cooker should be tested under operating conditions.
- The diodes should be thermally anchored as well as possible to the food being cooked.

Caution: Diodes provide no resistance to current. Thus, connecting the diode chain to a voltage source with high current capacity (such as a car battery or grid electricity) will allow extremely high currents, immediately destroying the diodes and risking fire. Thus, a diode chain should only be connected to a power source with limited current output, such as a solar panel.

6. Outlook: development and dissemination strategies

While ISEC provides a solution, changes in cooking present a challenge toward adoption of any improved cookstove. A recent study (Wilson et al., 2018) found that the use of biomass cook stoves greatly increased with the inclusion of a USB charging port powered by a Thermoelectric Generator (TEG). TEG/biomass stoves are expensive (Gao et al., 2016) and require biomass fuel. Lastly, Wilson also found that 11% of the time, the biomass cook stove was used only to provide electricity without cooking.

While many solutions should be considered to the cooking/electrification challenge, the continuing decrease in the cost of solar panels will increasingly favor solar electric cooking. Ultimately, our goal is to foster large environmental, social, and economic benefits (through local production) by making solar electric cooking affordable to very low-income communities much sooner.

We are co-developing the technologies with several enterprises in

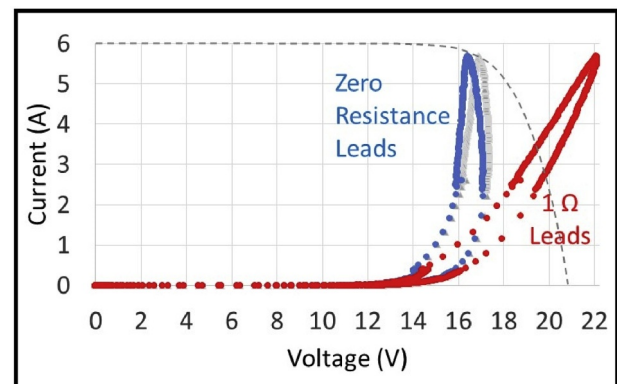

Fig. 11. The grey shadow is the diode curve from Fig. 9 with total resistance of 0.08 Ohms due to leads and a shunt resistor. The blue curve is the voltage if the leads to the diode had no resistance, and the red curve is if the leads had a resistance of 1 Ohm. (For interpretation of the references to colour in this figure legend, the reader is referred to the Web version of this article.)

Africa including *Kuyere*³ in Malawi, *SolarElectricCook*⁴ in Ghana, and *AidAfrica*⁵ in Uganda. By working directly with local African businesses, we ensure that the design is responsive to local preferences, and that manufacturing can be done locally, stimulating the local economy. Additionally, in the past two years, about 100 Cal Poly students have researched, designed, built and tested a large number of design variations of ISECs with diode-heaters: dedicated research students, engineering students engaged in year-long senior projects,⁶ and students enrolled in service-learning courses directed by Schwartz.⁷ Testing many different ideas facilitates the innovation of cooker design, production, and dissemination methods.

7. Conclusion

A chain of the correct number of diodes can optimally convert the electrical energy from a solar panel to thermal energy in cooked food. Additionally, the diodes provide an external power supply at a near constant voltage proportional to the number of included diodes. Thus, if the thermal energy is valued by the user, a diode chain radically decreases the cost of a solar electric system, making electric cooking and solar electricity more available to the world's poor.

7.1. Experimental details

- The solar panels we use are Model # GS-Star-100 W, 100 W Polycrystalline Solar Panels for 12 V Systems with an efficiency of 14.6%, $V_{MP} = 18.0\text{ V}$, $I_{MP} = 5.56\text{ A}$, $V_{OC} = 21.9\text{ V}$, $I_{SC} = 6.13\text{ A}$. Normally Operating Cell Temperature, $NOCT = 45 \pm 2^\circ\text{C}$. Temp. Coeff. of $V_{OC} = -0.32\%/^\circ\text{C}$, Temp. Coeff. of $I_{SC} = +0.04\%/^\circ\text{C}$. Temp. Coeff. of $P_{max} = -0.45\%/^\circ\text{C}$. See manufacturers specifications: sharedcurriculum.peteschwartz.net/wp-content/uploads/sites/3/2019/05/GS-STAR-100W.pdf
- Diodes: 1N5402 rectifier diodes, $I_{max} = 3\text{ A}$, Peak Forward Surge Current $I_{FSM} = 200\text{ A}$, $T_{max} = 150^\circ\text{C}$, See manufacturers specifications: sharedcurriculum.peteschwartz.net/wp-content/uploads/sites/3/2019/05/1n5400_ser.pdf
- Thermostatic switches: KSD9700 Normally Close Thermostat, Bimetal, 160 Celsius, \$57 for 100 switches. We have recently learned that these switches are easily damaged by the DC current we use, and we are exploring higher-current thermostatic switches.
- The voltage and current data loggers drifted in value by as much as 3%. We adjusted readings in order to make data self-consistent. Times were adjusted by as much as 10 min to make graphs easier to read.

Acknowledgements

The authors gratefully acknowledge funding from the following: The Bill Frost Student Research Grants and College Based Fee Support

through Cal Poly's College of Science and Math.

References

- Barbose, G., 2016. Naim Darghouth Tracking the Sun IX, the Installed Price of Residential and Non-residential Photovoltaic Systems in the United States. Lawrence Berkeley National Laboratory. <https://doi.org/10.2172/1345194>.
- Batchelor, S., 2015. Solar Electric Cooking in Africa in 2020: A Synthesis of the Possibilities. Evidence on Demand/DFID, London. https://doi.org/10.12774/eod_cr_december2015.batchelors.
- Batchelor, S., Brown, E., Leary, J., Scott, N., Alsop, A., Leach, M., 2018. Solar electric cooking in Africa: where will the transition happen first? Energy Res. Soc. Sci. 40, 257–272. <https://doi.org/10.1016/j.erss.2018.01.019>.
- Bailis, R., Ezzati, M., Kammen, D.M., 2005. Mortality and greenhouse gas impacts of biomass and petroleum energy futures in Africa. Science 308, 98–103. <https://doi.org/10.1126/science.1106881>.
- Gao, H.B., Huang, G.H., Li, H.J., Qu, Z.G., Zhang, Y.J., 2016. Development of stove-powered thermoelectric generators: a review. Appl. Therm. Eng. 96, 297–310. <https://doi.org/10.1016/j.applthermaleng.2015.11.032>.
- Grimm, M., Peters, J., 2016. Solar off-grid markets in Africa - recent dynamics and the role of branded products field actions science reports. Special Issue 15, 160–163. <https://doi.org/10.4419/86788721>.
- Kavlak, G., McNerney, J., Trancik, J.E., 2018. Evaluating the causes of cost reduction in photovoltaic modules. Energy Policy 123, 700–710. <https://doi.org/10.1016/j.enpol.2018.08.015>.
- Lombardi, F., Riva, F., Sacchi, M., Colombo, E., 2019. Enabling combined access to electricity and clean cooking with PV-microgrids: new evidences from a high-resolution model of cooking loads. Energy Sustain. Dev. 49, 78–88. <https://doi.org/10.1016/j.esd.2019.01.005>.
- Lim, S.S., et al., 2012. A comparative risk assessment of burden of disease and injury attributable to 67 risk factors and risk factor clusters in 21 regions, 1990–2010: a systematic analysis for the Global Burden of Disease Study 2010. The Lancet 380, 2224–2260. [https://doi.org/10.1016/S0140-6736\(12\)61766-8](https://doi.org/10.1016/S0140-6736(12)61766-8).
- MacCarty, N., Ogle, D., Still, D., Bond, T., Roden, C., 2008. A laboratory comparison of the global warming impact of five major types of biomass cooking stoves. Energy Sustain. Dev. 12, 5665. [https://doi.org/10.1016/S0973-0826\(08\)60429-9](https://doi.org/10.1016/S0973-0826(08)60429-9).
- Rao, N.D., Shonali, P., 2017. Energy access and living standards: some observations on recent trends. Environ. Res. Lett. 12. <https://iopscience.iop.org/article/10.1088/1748-9326/aa5b0d>.
- Simon, G.L., Bumpus, A.G., Mann, P., 2011. Win-win scenarios at the climate-development interface: challenges and opportunities for stove replacement programs through carbon finance. Glob. Environ. Chang. 22, 275–287. <https://doi.org/10.1016/j.gloenvcha.2011.08.007>.
- Subramanian, M., 2014. Global health: deadly dinners. Nature 509, 548–551. <https://doi.org/10.1038/509548a>.
- Swanson, R.M., 2006. A vision for crystalline silicon photovoltaics. Wiley 14, 443–453. <https://doi.org/10.1002/pip.709>.
- Tesfahunegn, S.G., Ulleberg, O., Undeland, T.M., Vie, P.J.S., 2011. A Simplified Battery Charge Controller for Safety and Increased Utilization in Standalone PV Applications International Conference on Clean Electrical Power. ICCEP, pp. 137–144. <https://doi.org/10.1109/ICCEP.2011.6036367>.
- Watkins, T., Arroyo, P., Perry, R., Wang, R., Arriaga, O., Fleming, M., O'Day, C., Stone, I., Sekerak, J., Mast*, D., Hayes, N., Keller, P., Schwartz, P., 2017. Insulated solar electric cooking – tomorrow's healthy affordable stoves? Dev. Eng. 2, 47–52. <https://doi.org/10.1016/j.deveng.2017.01.001> See associated video. <https://www.youtube.com/watch?v=XTQhdjVd0Fk>.
- WHO, 2018. Household Air Pollution and Health World Health Organization. <https://www.who.int/news-room/fact-sheets/detail/household-air-pollution-and-health>.
- Wilson, D.L., Monga, M., Saksena, A., Kumar, A., Gadgil, A., 2018. Effects of USB port access on advanced cookstove adoption. Dev. Eng. 3, 209–217. <https://doi.org/10.1016/j.deveng.2018.08.001>.

³ diysolar4africa.com.

⁴ SolarElectricCook.com.

⁵ AidAfrica.net.

⁶ See for example: sharedcurriculum.peteschwartz.net/solar-electric-cooking.

⁷ See for example: appropriatetechnology.peteschwartz.net/design-spring-2019, sharedcurriculum.peteschwartz.net/phys-310-spring-2019, and appropriatetechnology.peteschwartz.net/appropriate-technology-development-fall-2019.