

Kochnev, Artem

Working Paper

Marching to good laws: The impact of war, politics, and international credit on reforms in Ukraine

wiiw Working Paper, No. 192

Provided in Cooperation with:

The Vienna Institute for International Economic Studies (wiiw) - Wiener Institut für
Internationale Wirtschaftsvergleiche (wiiw)

Suggested Citation: Kochnev, Artem (2021) : Marching to good laws: The impact of war, politics,
and international credit on reforms in Ukraine, wiiw Working Paper, No. 192, The Vienna
Institute for International Economic Studies (wiiw), Vienna

This Version is available at:

<https://hdl.handle.net/10419/240635>

Standard-Nutzungsbedingungen:

Die Dokumente auf EconStor dürfen zu eigenen wissenschaftlichen
Zwecken und zum Privatgebrauch gespeichert und kopiert werden.

Sie dürfen die Dokumente nicht für öffentliche oder kommerzielle
Zwecke vervielfältigen, öffentlich ausstellen, öffentlich zugänglich
machen, vertreiben oder anderweitig nutzen.

Sofern die Verfasser die Dokumente unter Open-Content-Lizenzen
(insbesondere CC-Lizenzen) zur Verfügung gestellt haben sollten,
gelten abweichend von diesen Nutzungsbedingungen die in der dort
genannten Lizenz gewährten Nutzungsrechte.

Terms of use:

*Documents in EconStor may be saved and copied for your
personal and scholarly purposes.*

*You are not to copy documents for public or commercial
purposes, to exhibit the documents publicly, to make them
publicly available on the internet, or to distribute or otherwise
use the documents in public.*

*If the documents have been made available under an Open
Content Licence (especially Creative Commons Licences), you
may exercise further usage rights as specified in the indicated
licence.*

Marching to Good Laws:

The Impact of War, Politics, and International Credit on Reforms in Ukraine

Artem Kochnev



Marching to Good Laws:

The Impact of War, Politics, and International Credit on Reforms in Ukraine

ARTEM KOCHNEV

Artem Kochnev holds a PhD in economics from the Johannes Kepler University, Linz.

The author thanks Alexei Kochnev for fruitful discussions, Tetyana Tyshchuk for thorough comments on the methodology of the iMoRe index, Maria Klochikhina for a careful assistance in classifying the avalanche of Reuters' news, and Kateryna Krynytska for kindly agreeing to postpone the job start so the author could spend the last two weeks of his student life doing a contribution to social sciences.

Abstract

The paper investigates determinants of investments in state capacity and institutional change in contemporary Ukraine. After formulating a simple sequential two-stage model of investments in state capacity, the paper estimates autoregressive distributed lag and vector autoregressive models to verify its predictions. The paper finds little evidence for the impact of conflict intensity and access to international credit on the pace of reform progress. It finds a statistically significant effect for the intensity of political competition and changes of real wages, albeit these results are sensitive to robustness checks.

Keywords: cost of war, political cycles, transition economics, Ukraine crisis, political economy, state capacity

JEL classification: D74, E01, E20, F51

CONTENTS

1.	Introduction	9
2.	Theory and previous contributions	11
2.1.	Previous contributions.....	11
2.2.	A stylized model.....	16
3.	Context	23
4.	Data	25
4.1.	iMoRe.....	26
4.2.	UAF casualties.....	28
4.3.	IMF tone.....	29
4.4.	Popularity measures	29
4.5.	Real wages	31
4.6.	Stationarity	31
5.	Estimations	32
5.1.	Models and methods.....	32
5.2.	Results	37
5.3.	Robustness checks.....	39
5.4.	Discussion.....	46
6.	Conclusion	47
	References	49
A	Mathematical Appendix	57
A.1	Proof of Proposition 1	57
B	Datasets	64
B.1	Tone of the IMF communication	64
B.2	Final classification.....	73
B.3	Measures of electoral competition	75
C	Tables	78

TABLES AND FIGURES

Table 1: Summary statistics: Variables in levels	26
Table 2: Pipeline of the score assignment to the normative acts for the iMoRe index.....	27
Table 3: Dickey-Fuller Test: Variables in levels	33
Table 4: Dickey-Fuller Test: First differences.....	34
Table 5: Procedure of adopting a bill in the Ukrainian parliament.....	36
Table 6: ARDL Estimations of Impact of Fatalities on Reform Progress in Ukraine. Variables in Levels.....	40
Table 7: ARDL Estimations of Impact of Fatalities on Reform Progress in Ukraine. Variables in First Differences	41
Table 8: ARDL Estimations of Impact of Fatalities on Reform Progress in Ukraine. Variables in Levels. No outliers.....	42
Table 9: Distribution of assigned tones to Reuters.com articles	69
Table 10: Distribution of poll results done by survey-organizations	76
Table 11: Summary statistics: Deseasoned variables in levels	78
Figure 1: Graph of the game	19
Figure 2: Fatalities of the Ukrainian Armed Forces: 2014 – 2019.....	24
Figure 3: VAR: orthogonal impulse-response functions	38
Figure 4: VAR: orthogonal impulse-response functions. Adjusted sample	43
Figure 5: VAR: orthogonal impulse-response functions. Variables in firstdifferences.....	44
Figure 6: Correlation between the popularity of the ruling party and the iMoRe index. First differences.	46
Figure 7: Accuracy of the classification algorithms: count-vectorized sample	71
Figure 8: Accuracy of the classification algorithms: TFIDF-sample	71
Figure 9: Accuracy of Naïve Bayes classifier: count-vectorized sample.....	73
Figure 10: Accuracy of Naïve Bayes classifier: TFIDF-sample.....	74
Figure 11: Estimated tone of the IMF communication.....	74
Figure 12: Measures of electoral competition	77

1 Introduction

“The chief foundations of all states”, wrote Machiavelli, “...are good laws and good arms” (Machiavelli, 2008).¹ Hardly any social scientist would object that both ‘goods’ belong to the recipe of a prosperous state, but the order of the ingredients causes debate. Disagreements become even wider once one allows for a co-influence of ‘good arms’ and ‘good laws’. The purpose of this paper is to advance the discussion by demonstrating the impact of armed warfare on institutional change in the context of contemporary Ukraine.

In the spirit of Machiavelli, political scientists put more emphasis on the coercive side of the state: the strength of military forces, law enforcement and taxation (Bates, 2008; Hintze and Gilbert, 1975; Tilly, 2017).² Economists, on the other side, have been long discussing the “nurturing” role of states: institutions, laws, and development policies (Acemoglu and Robinson, 2005; Robinson and Acemoglu, 2012; North, 1990; Rodrik, 2006). Until recently, however, both discussions proceeded largely in isolation. The new strand of literature in political economy initiated by Besley and Persson (2011) addresses this gap by providing a new theoretical framework that links the effect of armed warfare on economic development of nations and the evolution of institutions. Yet the key theoretical predictions of the model are contested.³

According to this class of models, an external war – or a threat of its realization – provides a strong incentive to invest in state capacity. The argument is that the threat of a military loss to an outside faction leads to consolidation of political

¹The author thanks Tetyana Tyshchuk for thorough comments on the methodology of the iMoRe index, Maria Klochikhina for careful assistance in classifying the avalanche of Reuters’ news, and Katheryna Krynytska for kindly agreeing to postpone the job start so the author could dedicate the last two weeks of his student life contributing to social sciences.

²Machiavelli (2008) argues for the primacy of coercive capacity in several parts of ‘the Prince’: “As there cannot be good laws where the state is not well armed, it follows that where they are well armed they have good law”, and “[O]ne ought to be both feared and loved, but as it is difficult for the two to go together, it is much safer to be feared than loved, if one of the two has to be wanting.” According to ‘the Prince’ a despotic ruler is exposed to fewer risks than a popular one as “for love is held by a chain of obligation which, men being selfish, is broken whenever it serves their purpose; but fear is maintained by a dread of punishment which never fails.”

³Strictly speaking, Acemoglu (2005) is likely the first well-known formal contribution to the topic among economists. Yet, it was Besley and Persson who expanded the topic to the scale of a research program.

elites with its opposition and motivates both to invest in efficient bureaucracy and taxation to finance protection from a common enemy. Thus, states that had more wars in the past should have a better state capacity now.

Empirical results, however, are not universally in favor of the argument. Whereas Arias (2013); Besley and Persson (2011); Dincecco and Prado (2012); Dincecco et al. (2019) find support for the proposed view, findings of Chowdhury and Murshed (2016); Gennaioli and Voth (2015); Queralt (2016) cast a shadow on the arguments elaborated in Besley and Persson (2011).

The literature that emphasizes positive effects of armed conflicts on state capacity seems to be more prevalent, but its empirical validity is questionable because of survivorship bias. That is, the datasets that most studies employ do not feature states that disappeared from the world map due to armed conflicts. Polities that might have witnessed an adverse effect from wars are simply not in the databases as they ceased to exist. Another limit of the current discussion lies in its concentration on historical investigations. Although studies based on databases that track historical wars are useful for the discussion, one should not forget that the context of international relations has experienced strong changes over time. Prior to World War II, it was common to absorb other states after a successful military campaign. Yet a full state absorption is rare now. It implies that the risk of losses – the major mechanism, emphasized by Besley and Mueller (2012) – could be relevant for the states of the past, but is not at work for the present ones as found by Chowdhury and Murshed (2016) for developing countries of Latin America, Asia, and Africa. If this is true, then one should probably devote more attention to investigating the impact of other mechanisms – electoral competition or foreign aid – to understand present-day institutional change.

This paper highlights these ideas by presenting a simple model of public goods provision in the spirit of Besley and Persson (2011). Although it departs in the formulation to avoid corner solutions, it preserves the core results using a two-stage model of investment in state capacity with a reduced-form representation of politics, foreign aid, and public goods provision. The model derives conclusions

regarding the dependence of investments of state capacity on political turnout, conditionality of international aid, and the value of public goods.⁴

After defining predictions of the model in the equilibrium, the paper provides quantitative evidence by estimating time series models on novel data. Using the ARDL and VAR models, this paper estimates the effect of armed conflict, political competition, international credit, and income on reform progress in Ukraine. The results show that in most of the estimations, only political competition and average income have an impact on reform progress, although the result does not hold when subjected to all robustness checks.

This paper contributes to four strands of literature. First, it analyzes the evolution of state capacity of a single country in a contemporary context. This lies in contrast to the most well-known empirical studies, which primarily focus on panel databases that capture long-term effects based on historical records. The case of Ukraine is suitable for these purposes as it features high variation in both warfare and reform progress throughout the observed period. Second, the empirical methodology of the paper allows for co-evolution of the variables over time, which is what studies based on micro-econometric tools usually do not account for. Third, the paper contributes to the discussion on the effectiveness of foreign aid provision for economic development. Finally, the paper contributes to the literature on the long-term costs of conflict by investigating whether or not the war in Ukraine has slowed down reform progress in the country.

2 Theory and previous contributions

2.1 Previous contributions

It is a common point in the new literature on state capacity to emphasize that the topic was not part of the mainstream discussion in economics (Acemoglu,

⁴Besley and Persson (2011) also devote part of their work to the effects of political turnover. Yet the linearity assumptions in their models lead to a sharp partition of all states into inclusive/redistributive/weak states depending on the parameter values. The model presented in this paper features a non-linear utility function, which produces 'smooth' results in the equilibrium. In the optimum, each state has non-zero spending on each type of good: both private and public ones.

2005; Besley and Persson, 2011). Although this perception is formally true, it is a slight oversimplification. Debates surrounding the role of a state in promoting long-term economic growth have a long tradition in development economics, the economics of growth, and economics of transition (Acemoglu et al., 2019; Barro, 1996; Chang, 2002; Rodrik, 2006; Olson, 1982). It was, in fact, the more nuanced view of economic development, which motivated the "new" political economy literature. The sustained economic growth of the Asian economies rooted in state-guided policies and a sluggish one in the economies of the former USSR, Africa, and Latin America posed a challenge for mainstream economics, which emphasized market-based policies and the role of credit constraints (Rodrik, 2006).

The immediate response of mainstream economics was to claim that countries adopting free-market policies lacked necessary institutions, which are required for proper functioning markets in the first place (North, 1994; Stiglitz, 1999).⁵ Acknowledging the role of institutions in policy advice was a step forward, but in fact, the answer offered little guidance. Once one recognizes that *markets are institutions*, the argument becomes recursive: countries could not introduce institutions, because they lacked institutions. Thus, the real question is: which institutions are essential?⁶

The modern literature in institutional economics, which emphasizes the contradiction between "inclusive" and "extractive" institutions (Acemoglu, 2005; Robinson and Acemoglu, 2012; North et al., 2009), has a similar issue. According to it, long-term growth requires such an organization of the state that *effectively* promotes collective decision-making over the distribution of public goods. A set of empirical studies – largely in economic history – found support for this line of thought (Acemoglu et al., 2001, 2002, 2019; Dell, 2010). These findings

⁵Reformers of the Soviet economy were well aware of the importance of institutions. Their reliance on market-based solutions was largely grounded in humanitarian considerations and political context. Reformers favored market-based approaches to avoid the collapse of markets and overcome political opposition of an industrial lobby, which was deeply entrenched in the parliament (Gaidar, 2012).

⁶The field of transition economics did not offer much guidance either. The most valuable contributions to the field were positive theories of the reform process that sought to rationalize the observed decision-making of the governments. The predictions of the models are largely driven by the costs of the transition process and (re-)distributional effects, which are treated as parameters in game-theoretic models (see Róland (2000) for an overview). Yet the question discussed in the text is about the *nature of the parameters*.

were, however, at odds with the fact that the most obvious measures of democracy were weakly correlated with economic growth in the post-WWII period in general and were sensitive to model specifications (Barro, 1996; Barro and Sala-i Martin, 2004). A traditional response to this critique is that one should not confuse institutions with *the* institutions. As emphasized by North, the constitutions of post-colonial Latin American countries were well-written and more progressive in their spirit compared with those adopted in the European countries of that time (North, 1990). The problem was that the countries of Latin America could not *enforce* "inclusive" institutions. Yet in this case, the discussion boils down to state capacity – the ability of states to enforce compliance with rules.⁷

This observation motivated the new strand of research that emphasized the role of state capacity. That is the ability of the state to raise taxes, provide security, and distribute public services (Besley and Persson, 2011).⁸ In their elaboration, Besley and Persson follow the tradition of political scientists (Tilly, 2017), and model political competition and investment decisions of rent-seeking. The class of analyzed models produces a conclusion which reiterates across the class of models they explore: external conflicts create an incentive for elites to invest in state capacity. The result is primarily driven by a chance for elites to lose rents in case of external conflict. Being afraid of defeat in war, it is beneficial for elites to give up part of their rents and invest them in state capacity to finance military expenditures. The implication of the theory is straightforward: the more frequently a state participated in external conflicts in the past, the greater is the likelihood of the nation having greater state capacity today.

The first empirical investigations were indeed in line with this line of reasoning. (Arias, 2013; Besley and Persson, 2011; Dincecco and Prado, 2012; Dincecco et al., 2019). Many of these findings, however, suffer from common problems highlighted by subsequent research. First, raising taxes through improved state

⁷Although it might not be evident at first, state capacity and inclusive institutions – the way they are typically framed in the literature – are distinct concepts. The ability to raise taxes represents the coercive side of the state, whereas inclusive institutions emphasize collective decision-making.

⁸Although the offered theories are positive in substance, they provide a useful insight into the evolution of current states. This discussion, in turn, might hint at better policies of reform implementation.

capacity is not the only available option to raise finance in wartime. International credit is a viable alternative, which was frequently used by ruling elites of the past and reduced the link between state capacity and war finance. Habsburg Spain, which heavily relied on international credit in the 16th century – the time of its most rapid territorial expansion –, is one of many examples present in the European History (Gaidar, 2010; Queralt, 2016). Yet, even if access to international credit is absent, the state has a potentially unlimited tax capacity through seigniorage.⁹

Second, the regression findings of the discussed papers typically suffer from endogeneity, which, in turn, leads to survivorship bias. Engaging in a military conflict is always *a decision* and one would expect the elites to engage in war only if it assessed its chances of winning greater than losing, which, on average, one would expect to happen with a greater army. Yet within the framework of Besley and Persson, a bigger army – natural resources being absent – implies a more efficient state. This effect alone is a potential concern, but the problem is more severe. Since most of the studies use historical data dating back to at least the 18th century, states, which had low state capacity do not enter the sample. Since regressions are typically run using the present-day country boundaries, they do not feature polities of the past that disappeared from the world map.¹⁰ Therefore, the observed state capacity could be driven by a comparative advantage in taxation in the first place as argued by Gennaioli and Voth (2015).¹¹

Third, most of the supporting evidence comes from historical, not recent, experience of the countries and raises concerns about the import of the framework today. Contemporary multilateral institutions have established rules for declaring war and reduced occurrence of international armed conflicts. Furthermore, the principle of territorial integrity of existing states as a basis of international

⁹Naturally at cost of high inflation expectations.

¹⁰The example of Germany is a perfect illustration of that. The German Confederation, which consisted of 42 independent polities since 1826, reduced to only three independent states by the beginning of the WWI: The German Empire, the Austro-Hungarian Empire, and the Grand Duchy of Luxembourg.

¹¹Gennaioli and Voth (2015) address the issue and test it using the context of the 16th century Holy Roman Empire. Their findings confirm the raised concerns. Namely, states with greater costs of fiscal centralization reduced investments in state capacity, when the military revolution increased the role of finance in achieving a military victory.

relations reduced tolerance of the international community to the seizure of territories, let alone absorption of the existing states.¹² As a consequence, the threat of armed conflict and the size of potential losses for elites, caused by a military defeat, could have declined to levels such that it lost its relevance in the present-day context.¹³ If this is the case, one should pay more attention to other drivers like political competition, which is emphasized by a large body of literature in political economy (Bourguignon and Verdier, 2012; Fergusson et al., 2018; Fergusson, 2019; Easaw et al., 2019; Herrera and Martinelli, 2013).¹⁴

Fourth, wars are costly and harm the aggregate economy. As repeatedly found by conflict researchers (Blattman and Miguel, 2010; Gardeazabal, 2010; Mueller, 2013; Ray and Esteban, 2017; Brauer and Dunne, 2012), countries at war experience decline in economic activity. This implies that countries at war possess fewer resources to finance investments and the more intensive the conflict, the more detrimental the impact of conflict on state capacity will be.

Finally, countries affected by wars nowadays receive foreign aid or subsidized credit from international donors. International donors, however, frequently impose conditions on the aid disbursement to promote more efficient policies (Quibria, 2014). In theory, a credible commitment of the donor to the conditionality can reduce opportunistic behavior and help to achieve policy targets even if the recipient governments are reluctant to do so (Dreher, 2009). Although the empirical evidence for the efficiency of the conditionality is mixed, it remains a working channel, which is influencing policy decisions in war-afflicted countries (Barro and Lee, 2005; Collier and Hoeffler, 2002; Findley, 2018; Papi et al., 2015; Quibria, 2014).

In short, the current literature lacks present-day evidence that compares the

¹²To illustrate the point, consider the case of 18th century Poland with the ongoing confrontation of Ukraine with Russia. Whereas the partitions of Poland were tolerated by the European States of the 18th century, the intervention of Russia in Crimea was considered to be a step beyond the red lines in modern politics.

¹³This problem is reflected by Chowdhury and Murshed (2016) who finds that international conflicts are negatively correlated with state capacity of the post-WWII developing countries.

¹⁴The empirical findings of the literature show that the effect of political competition could be surprising. Fergusson et al. (2018) argue that intense political competition led to strategic depletion of state capacity in Mexico to reduce the incentives of the contender-party to win the elections. This effect resembles price damping established by a monopoly to prevent market entrance of competitors.

conflict effects with other competing mechanisms. To address the problem, this paper first presents a stylized model of investments in state capacity. The model demonstrates how the increased value of public goods and the contraction of the aggregate economy can change the equilibrium level of state capacity. It also highlights the effect of electoral competition and international aid. These hypotheses form a basis for empirical exercises investigated later in the context of the war in Ukraine.

2.2 A stylized model

2.2.1 Design of the model

The model presented below attempts to mimic behavior of the elites facing a threat of external conflict. The section does so by constructing an extensive-form 2-period game with perfect information. After characterizing the game setup, the section shows the optimal choice of the control variables in a subgame-perfect Nash equilibrium. The presented game provides a reduced-form representation of politics. Although the author believes one could explicitly provide a mechanism, which would aggregate the preferences of the group-members – e.g. by using the median voter theorem –, this paper does not provide these microfoundations. The reason is that it would not be particularly enlightening for the present application, because the purpose of the model is to illustrate a basic trade-off for political elites on a group-level. That is, the elites either decide to consume more rents today at cost of less taxable income, and therefore rents, in the future or invest in state capacity today, but expect a greater tax base and rents tomorrow. For the same reason, the model does not involve intertemporal discounting or economic growth, as neither of them would serve the purpose to highlight the above mentioned trade-offs of the model.

2.2.2 Setup

Consider a polity, where the total population is divided into two groups: the one in power, and the one in opposition. The model assumes that the objective of

both groups is to maximize utility, which takes a log-transformed version of the Cobb-Douglas utility function. The specification of the utility function depends on whether the group controls government in time i .

$$U := \begin{cases} \mu_P \ln M_i + \rho \ln R_i + \omega_P \ln (1 - t_i) w_i^P L_i^P, & \text{if the group is in power.} \\ \mu_O \ln M_i + \omega_O \ln (1 - t_i) w_i^O L_i^O, & \text{if the group is in opposition.} \end{cases} \quad (1)$$

Where subscript i stands for the period of the game such that $i \in \{1, 2\}$; $M_i \in \mathbb{R}_+$ reflects the amount of public good spending; $R_i \in \mathbb{R}_+$ shows return from rents of the group in power; $t_i \in [0, 1]$ is the tax rate; $w_i^P, w_i^O \in \mathbb{R}_+$ is the average wage rate of the group in power and opposition in time i ; $L_i^P, L_i^O \in \mathbb{R}_+$ reflect the size (population) of the group in power and opposition respectively.

The parameters $\mu_P, \mu_O \in (0, 1)$ represent utility elasticities of public goods, $\rho \in (0, 1)$ reflects the utility elasticity for rents, and $\omega_P, \omega_O \in (0, 1)$ stand for utility elasticity for wages. This paper imposes the following additional constraints on the elasticities:

1. Non-increasing returns to scale: $\mu_P + \rho + \omega_P \leq 1$ and $\mu_O + \omega_O \leq 1$
2. Augmented rent dominance over public goods: $\rho + \mu_P > \mu_O$.

The first set of constraints rules out the increasing returns to consumption and is common for economic modelling. The second set of constraints implies that everything else being equal, the cumulative return from public goods and rents while being in power is greater than receiving public goods alone as an opposition. Although this is not a constraint, which is stated explicitly in the literature, it is implicitly fulfilled in a class of symmetrical Cobb-Douglas utility functions.

The optimisation program of the agents depends on the period in time and whether or not the group is the party in power. If the group holds power, then its objective is to maximise utility subject to the budget constraint, which is defined

by the condition $b_i(\cdot) = 0$, where $b_i(\cdot)$ in turn, depends on the period of the game:

$$b_i = \begin{cases} \tau_1 t_1 W_1 - (R_1 + M_1 + F), & \text{if } i = 1 \\ A(F) + \tau_2(F) t_2 W_2 - (R_2 + M_2), & \text{if } i = 2 \end{cases} \quad (2)$$

Where $F \in \mathbb{R}$ stands for investments in fiscal capacity; $W_1, W_2 \in \mathbb{R}$ show the size of the economy at time 1 and 2 respectively such that $W_i = w_i^P L_i^P + w_i^O L_i^O$; A is the volume of foreign aid; τ_i is fiscal capacity in time i .

The interaction between state capacity $\tau_2(F)$, tax rate t_2 , and income W_2 defines the key trade-off for the party in power in time 1. Although investing F in time 1 does not generate immediate returns, it expands the budget in the next period by the volume of foreign aid $A(F)$ and more efficient taxation $\tau_2(F)$. This in turn allows for extracting greater rents in time 2. The interplay between the current spending on state capacity and future rent gains presents the key trade-off in the model.

For simplicity, this paper assumes that $A(F)$ and $\tau_2(F)$ are linear functions: $A(F) = \phi F$ and $\tau_2(F) = \kappa F$, where $\phi \in \mathbb{R}$ shows the conditionality of foreign aid with respect to investment in state capacity and $\kappa \in \mathbb{R}$ shows the efficiency of investments in state capacity.

If the party is not in power, then its income is set exogenously by the post-tax labour income $(1 - t_i)w_i^O L_i^O$ and the amount of public goods M_i^P determined by the group in power. The game proceeds as follows:

1. Period 1

- (a) The group in power P chooses the tax rate t_1 , the volume of rents R_1 , public goods expenditures M_1 , and the investments in fiscal capacity F .
- (b) ‘Goods’ are allocated and utility levels in stage 1 are determined.
- (c) With a probability of π – a parameter which could be interpreted as political turnout or intensity of electoral competition –, nature decides whether the incumbent stays in power or not.

Figure 1: Graph of the game

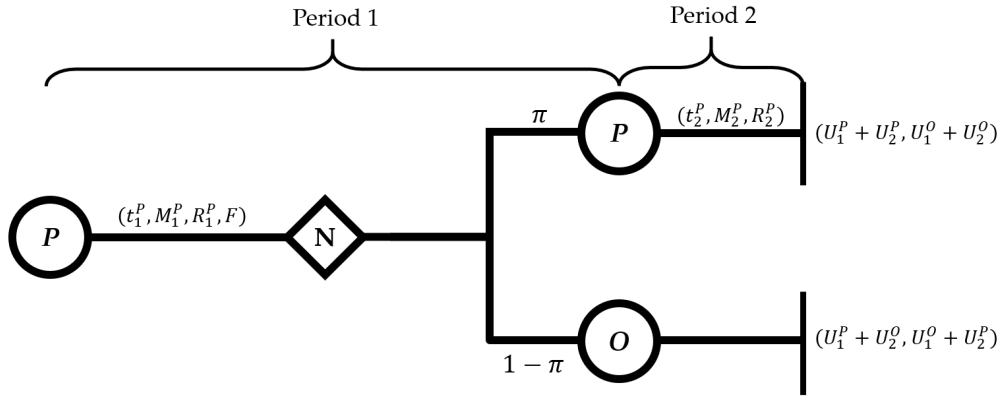

2. Period 2

- (a) The level of state capacity $\tau_2(F)$, and the volume of fiscal aid $A(F)$ are determined depending on the level of F determined in the first period.
- (b) The group in power chooses the tax rate t_2 , the volume of rents R_2 , and public goods spending M_2 .
- (c) 'Goods' are allocated and the game ends.

Although this proposition is framed around the role of public goods in general, it has direct implication for the interrelation between wars, political turnout, and state capacity. Since security and state defense are both a public good, a threat of war is likely to shift both μ_P, μ_O upwards and motivate greater investment in state capacity. Greater political turnout will be reflected in lower π and motivate immediate rent-extraction.

Apart from that, the author would like to underline two results. First, international aid does not have an effect on investment in state capacity. This result is driven by the fact that the foreign aid supply is modelled linearly and does not affect decisions at the margin.¹⁵

Second, the function F^* highlights that the level of state-capacity depends

¹⁵Relaxing this to allow for a non-linear case impact is not straightforward, as it does not allow for a closed form solution. The author encourages other researchers to provide more work that would allow for both lifting the linearity assumption while keeping the model tractable.

on the size of the aggregate economy. This is not surprising but is important for discussion on the short-term and long-term effects of war on state capacity. Typically, the literature frames the discussion around the interplay between war and state capacity irrespective of the impact of war on the aggregate economy. That is, it assumes that $\tau_2(F|\text{War}) > \tau_2(F|\text{No war})$ by implicitly assuming that $W_i(\text{War}) = W_i(\text{No war})$. This appears to be an appropriate assumption if the production capacities of the country at war are out of reach of enemy forces. One could think of the European colonial wars of the late modern period, the modern US military presence in Afghanistan and Iraq or military confrontation over relatively minor territories like the Falklands war. Yet, the major human conflicts – both World Wars, the Thirty Years’ war in Europe, and the Three Kingdoms War in Asia – featured territorial disputes between proximate states with severe adverse effect on the aggregate economy of the countries at war. That is, in many cases one should expect that a war should simultaneously increase μ_P, μ_O and decrease W_1 . Although in this case the level of investment in state capacity depends on the exact values of the parameters, one result follows immediately: war leads to greater state capacity $\tau_2(F)$ only if the *factor*, by which the elasticity of public goods in the utility function rises, is greater than the *factor*, by which the aggregate economy shrinks due to war. Proposition 1 states it formally.

Proposition 1. *Assume that the military conflict increases the output elasticity of public goods for the party in power and opposition by a factor a and decreases the economy by a factor b such that $a, b \in (1, \infty)$. Then it is necessary that $a > b$ to make state capacity $\tau_2(F)$ rise compared with the pre-war level.*

Proof. Scale both μ_P and μ_O by a and W by factor $1/b$ respectively. Then the investments in state capacity can be greater than the previous level if and only if $F(a\mu_P, a\mu_O, W/b) > F(\mu_P, \mu_O, W_1)$. This yields:

$$\frac{(\pi(a\mu_P + \rho) + (1 - \pi)a\mu_O)\tau_1 W_1}{b[(1 + \pi)(\mu_P + \rho) + (1 - \pi)\mu_O + \omega_P]} > \frac{(\pi(\mu_P + \rho) + (1 - \pi)\mu_O)\tau_1 W_1}{[(1 + \pi)(\mu_P + \rho) + (1 - \pi)\mu_O + \omega_P]} \quad (3)$$

Since $(\pi(a\mu_P + \rho) + (1 - \pi)a\mu_O) < a(\pi(\mu_P + \rho) + (1 - \pi)\mu_O)$ for all $a > 1$, this

condition can be satisfied only if $a > b$. □

Proposition 1 shows that in case of a destructive conflict, state capacity can increase only in the case elites "overreact" to the economic damage caused by war. That is if the output elasticity of military expenditures increases by a factor which is greater than the scale of destruction caused by war.

This "destruction effect" provides a different view on the frequently found differences in the impact of internal and international wars on economic performance. Previous explanations typically emphasized strategic behavior of elites. According to this view, elites may strategically deplete fiscal capacity to reduce the incentive of the contender to initiate an insurgency, since the lower are future rents, the smaller is the incentive of the opposition to fight for power.

According to the present interpretation, the effect of civil wars is also detrimental but the mechanics is different. War might reduce investments simply through tighter budget constraint as the economy shrinks due to military actions. From this perspective, the seemingly opposing effects between internal and international wars are caused by the amount of economic damage, not strategic interaction. Apart from that, internal conflicts are frequently localized and might not represent an immediate danger to the ruling elites. In this case, one is likely to expect that the size of a for elites is negligible. At the same time, the very fact of a civil war might trigger negative sentiments of business and reduce investments, which in turn leads to an economic downturn, implying $b > 1$. Thus, the impact of war on state capacity is ambiguous but is more likely to be negative when the conflict is localized and does not present an immediate threat to elites. This experience might resemble the setting of Colombia in the 1970s, the post-2007 confrontation of the Russian federal military forces with the Islamic/separatist movement in Chechnya or the contemporary Maoist-Naxalite insurgency in India, all of which are localized in areas characterized by a mountainous terrain.

2.2.3 A note of caution

The model imposes specific functional forms and exogeneity of parameters to allow for a tractable solution and concentrates on the most important trade-offs. By doing so it rules out interactions which might be of practical relevance for decision-makers. In particular, the increase in state capacity is likely to have a growth-enhancing effect leading to a positive impact on the size of the economy in time 2. In this case, the model underestimates the incentives for state capacity as it does not internalize the effect of future gains generated by greater state efficiency.

Similarly, the model does not incorporate an interplay between the probability of new tenure π and the investment in public spending. As highlighted by the literature on economic transition (Gaidar, 2012; Róland, 2000; Rodrik, 2006), efficiency-enhancing reforms are typically politically costly. By setting π exogenously, the model does not take into account the trade-off between the probability of a new tenure and efficiency gains in the future. Although these effects are important, their inclusion in the model would shift the focus of attention from the trade-off between wars and state capacity, which is central to the present paper, and would complicate the analysis to the level when closed-form solutions would no longer be possible. The author thus follows the approach of Rodrik (2015), who favors a variety of stylized models with straightforward conclusions over attempts to build a universal model.

2.2.4 Taking stock

Summarizing the results of the previous discussion and predictions of the model, this paper formulates the following hypotheses:

Hypothesis 1: The effect of a conflict depends on its impact on the aggregate economy and the threat it poses to elites. Small-scale conflicts are likely to have a detrimental effect on the economy, whereas large-scale wars are going to have an ambiguous effect.

Hypothesis 2: Greater political competition, in the case of electoral democ-

racies, or uncertainty of the autocratic leadership, in the case of non-democratic regimes, lead to lower investment in state capacity.

Hypothesis 3: International aid with exclusively linear conditionality does not affect investment in state capacity.

To explore the explanatory power of the hypotheses, this paper confronts the predictions with data on the war in Ukraine.

3 Context

There are a number of factors that make the war in Ukraine a particularly relevant case for the discussion. First, the war in Ukraine occurred at the same time the political leaders had been actively using a reform agenda in its political program. The war in Ukraine unfolded shortly after the Revolution of 2014, which narrative was tightly linked to greater integration with the EU and modernization of the country. The refusal of the then President Yanukovich to sign a free trade agreement with the European Union coupled with the aspiration to bring change to Ukraine were the second- and third-most important reasons to participate in the protests at the early stage of the civil unrest (Bekeshina and Khmelko, 2013).¹⁶ As a consequence, greater integration with the European Union and modernization became the primary agenda of the post-revolutionary government. The unexpected takeover of Crimea and an armed insurgency in the Donetsk and Luhansk regions made the elites change the priorities to security issues. Whereas the takeover of Crimea did not cause mass casualties¹⁷, the armed insurgency in the Donetsk and Luhansk regions resulted in a protracted confrontation between the Ukrainian Armed Forces and the separatists, which continues today.

Second, the impact of war on the Ukrainian economy was sizable. Over 6 years, the conflict took the lives of 13,000 people and triggered the displacement of 1.4

¹⁶The most mentioned reason for participation was police violence against the early protesters. The pro-European sentiments and demands to enter the free trade area with the European Union became the reason why the mass protests became known as '*Euromaidan*'.

¹⁷The database of dead Ukrainian military servicemen '*Memorial Book*' has two entries in March 2014.

million people – around 25% of the local pre-war population (UNOCHA, 2018). The economies of the Donetsk and Luhansk regions, which accounted for 15% and 25% of the pre-war country GDP and export, contracted in a range between 50% and 70% from the pre-war level (Bluszcz and Valente, 2019; Havlik et al., 2020).

Third, the conflict was localized and did not directly affect the rest of the country. After the violence quickly escalated in 2014, the Ukrainian and separatist leaders signed two agreements which fixed the de-facto territorial control by the parties and outlined a plan for conflict resolution. Although none of the parties implemented the points of the plan in full, the post-truce period was characterized by a more moderate conflict intensity. Figure 2 shows that monthly fatalities dropped tenfold from about 700 people in August 2014 to 70 in March 2015.

Figure 2: Fatalities of the Ukrainian Armed Forces: 2014 – 2019

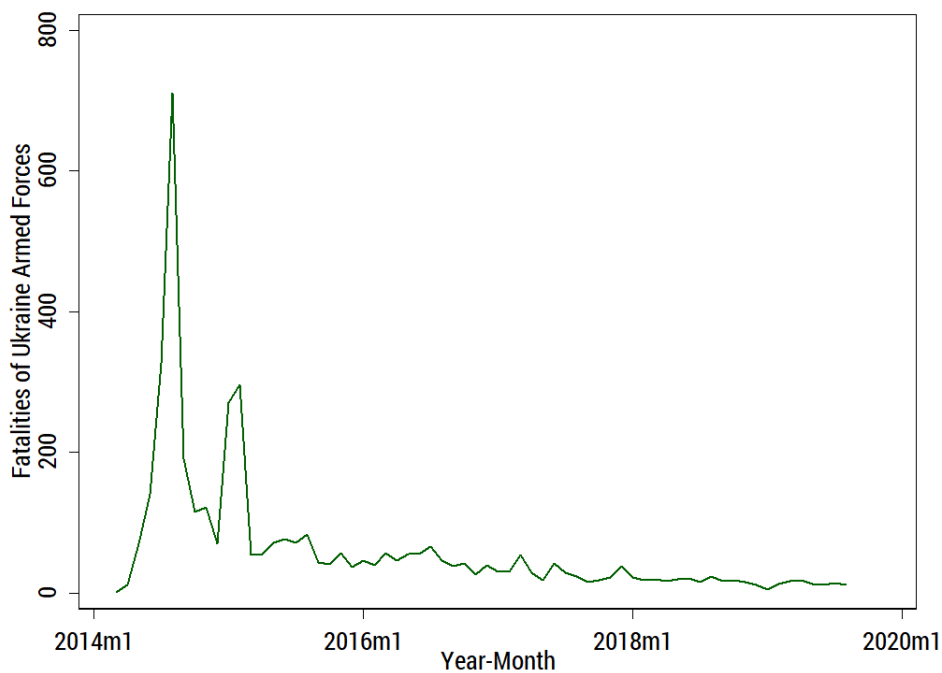

Source: Memorybook.org.ua (2020).

Fourth, both elites and the public perceive the war in Ukraine as an external conflict with Russia (RBC.ru, 2020). Although the armed insurgency was contained within the internationally recognized borders of Ukraine, the Ukrainian public frames the conflict as a Russian incursion in Ukraine (Vedernikova et al., 2019). This view is also reflected in Ukrainian laws, which refer to the separatist-

controlled areas as ‘temporarily occupied territories’ (Verkhovna Rada, 2018).

Fifth, Ukraine used external finance during the wartime, which was tightly linked to the reform progress. Finance provided by the IMF and the EU helped the Ukrainian government to escape immediate default on obligations. This aid, however, came at the cost of tight reform supervision by the IMF and introduction of reform-minded ministers into government (Himshiashvili, 2014). As a result, the IMF became an actor in Ukrainian politics, with an impact on the final form of the adopted parliamentary bills and policy decisions in the country.

Taken together, the context of the war in Ukraine fits the basic prescription of the model presented in the section above. That is, post-2014 Ukraine is a country with a heavy reform agenda and a moderate-scale conflict, which has caused sizable economic damage and is largely viewed as a confrontation against an external enemy.

The additional advantage of the present case is that the high civic engagement resulted in initiatives that aimed at data collection and public dissemination on the discussed topics, which serve as a basis for the empirical assessments presented below.

4 Data

To perform the empirical analysis, this paper uses four time series: the "Index for Monitoring Reforms" (iMoRe), number of casualties of the Ukrainian Armed Forces (UAF), the tone of the IMF’s statements about Ukraine, the popularity of the ruling party, the popularity gap to the strongest opposition party, and the real average wage in Ukraine. The database consists of 49 monthly observations spanning from April 2015 to April 2019 (including the boundary observations). Table 1 provides summary statistics for non-deseasoned data.

As it becomes clear from the description, the selected variables do not directly represent the key concepts used in the theoretical discussion. This is driven by limits on collecting necessary time series on a monthly basis. Since most of the data are novel for the literature, this paper describes each of the sources below

Table 1: Summary statistics: Variables in levels.

	Mean	St. deviation	N
Reform Index: Total	21.81	16.77	50
Reform Index: Public Finance	3.94	3.70	50
UAF Fatalities	35.74	19.23	50
Log(Real wage)	8.26	0.17	50
Popularity: Gap	4.02	4.39	50
Popularity: PPB	0.42	2.78	50
IMF tone	-0.00	0.19	50

Sources: "All reforms" uses a sum of evaluations for all laws passed in the Ukrainian parliament; "Public finance" uses a sum of evaluations for all laws contributing to the 'public finance' dimension only. Reform index composed by VoxUkraine (2020); fatalities as reported by Memory-book.org.ua (2020); IMF tone classified by author; real wage as reported by Ukrstat (2019); 'Popularity: PPB' is a share of surveyed supporting the ruling party 'Petro Poroshenko Bloc' and 'Popularity: Gap' is the difference between 'Popularity: PPB' and share of surveyed supporting most popular alternative party – both popularity measures calculated as in Annex B based on Ukraine-elections (2019).

and highlights caveats that arise from the data-generating process which might affect the estimation results.

4.1 iMoRe

The iMoRe is a bi-monthly composed index, which assesses the pace of reforms in Ukraine. The index is supported by the team of VoxUkraine – a non-commercial organization, which was created as an "analytical platform" for discussing the economic and near-economic issues of Ukraine.¹⁸ iMoRe is a subjective index, based on an expert evaluation of normative acts that come into force in Ukraine during the observed period.

The index evaluates only the normative acts, that according to the Index Manager 'change the behavior of economic agents and results in more (less) efficient use of resources' (VoxUkraine, 2020). Normative acts that come into consideration include normative changes introduced on the country level by the parliament

¹⁸Loosely speaking, the organization acts as a media, research group and educational organization.

of Ukraine ('Verkhovna Rada'), Cabinet of Ministers, the President of Ukraine, the National Bank of Ukraine, international agreements that were signed by the government and/or ratified by the parliament and possibly other country-level government bodies. It does not, however, evaluate legal changes with an application period less than 1 year, experiments or projects with a limited number of participants, and anti-crisis policies (e.g. decisions regarding currency exchange and capital movement).¹⁹

iMoRe is a composite index, which evaluates each normative act by five dimensions: governance, public finance, monetary system, business environment, and energy sector. The evaluation scale of each dimension is in range from -5 to +5, where the negative number implies that a legal act creates incentives for a less productive resource use and a positive number implies a more efficient one. The extremes of the range $\{-5, +5\}$ designate a 'radical change' in the incentive structure. Table 2 shows the evaluation pipeline, which should be completed within 2 weeks:

Table 2: Pipeline of the score assignment to the normative acts for the iMoRe index.

Stage	Description
1	The Index manager selects legislative acts that entered into force
2	The manager classifies the act by reform directions
3	The manager compiles a questionnaire containing a brief description of the acts and links to official texts and distributes it among the experts
4	Experts assess normative acts and the general reform progress for a dimension in a range from -5 to 5
5	The manager receives the assessments and evaluates the median scores

Source: VoxUkraine (2020)

The index has two potential weaknesses. First, it does not assess the enforcement of the acts. Thus, by using it as a measure of reforms, we rely on the "least" effort of the policymaker to improve the state capacity. Second, the background of the expert community is skewed towards industry professionals

¹⁹The index assesses the normative acts in the form they come into force. That is, drafts, public statements, and rumors are not evaluated.

and academics from European/American universities/thinktanks, who might favor market-oriented policies over regulatory ones.

This paper makes a single departure in computing the index compared with its official methodology. Apart from evaluating single legal acts, experts also assess the perceived *overall progress* of the reform components during the evaluation period. The overall progress of the components forms the final score of the index. The present paper uses, however, the sum of scores received by each *individual legal act* for a given month. The author does so to properly align the temporal variation in reform change of the index with the other time series. Since some index releases cover legal acts that came into force in both months (e.g. iMoRe No. 82 covers the period between March 25th to April 8th 2018), it makes a temporal alignment impossible. The major drawback of the adopted approach is that this paper cannot use the *overall* assessment score of the iMoRe *releases*, which takes into account the experts' view of whether the quantity and quality of the legal change was at a satisfactory pace. As a result, the index assessments used in this paper are more optimistic than in the standard iMoRe index as minor legal acts might still contribute to the score, whereas experts could possibly discount their impact as negligible.

The model counterpart of the index is $\tau_2(F)$ – the state capacity. This paper uses the reform index as a proxy for state capacity as the index reflects the commitment of the government to improve institutional quality in the country and effectiveness of state regulation and administration.

4.2 UAF casualties

Since there is no open-access database on fatalities and casualties of the Ukrainian army, this paper uses data from alternative sources. This paper employs a database of Memorial Map – an open collaborative project, which lists all dead Ukrainian armed men, who died during the war –, which the author scraped from the website of the resource. The advantage of the database is that it includes fatalities that covers people who were subordinated to different governmental structures (e.g.

armed and police forces) and paramilitary troops, which played a significant role in the early stage of the conflict. Therefore, the project shows a fairly comprehensive picture of losses taken by the Ukrainian armed forces over the observed period of time.

The model counterpart of the UAF fatalities are values μ_P, μ_O . The change in UAF fatalities should reflect the severity of the threat posed by separatist movements in Ukraine and reflect the value of military spending in the utility function.

4.3 IMF tone

The time series of the IMF/Ukraine relations was collected specifically for this paper. The author used a Naive Bayes classifier – trained on manually-labeled news (42% of the sample) – to assess the tone of the Reuters news that featured the words ‘IMF’ and ‘Ukraine’ in the same text. The tone of the news could take one of three values $\{-1, 0, 1\}$, where -1 stands for a negative tone, 0 stands for a neutral one, and 1 stands for a positive tone. Using the classified sample, the author calculated the total sum of the news texts’ tone scores for each month to compute the monthly ‘tone’ index (see Annex B for the detailed methodology of composing the index).

The model counterpart for the IMF tone is kF – the disbursement of aid to the country. Strictly speaking, the IMF loan disbursements to Ukraine would be a more precise measure. Unfortunately, they are rare and do not provide enough variation for credible statistical inference. The IMF officials, however, have an established system of public relations, which the institution uses to indicate its satisfaction with the program progress for each country. Therefore, the author assumes that the tone of the IMF communication should serve as a good proxy to reflect chances of next loan disbursement.

4.4 Popularity measures

To proxy for probability of elites staying in power, this paper uses two measures: the share of people, who would vote for the ruling party in a particular month,

and the difference of the same measure for the ruling party versus the other most popular party. Both time series are survey-based measures. Unfortunately, there is no single entity in Ukraine which consistently measures electoral preferences of the population on a monthly basis. Therefore, this paper used an aggregated measure of popularity from multiple surveying organizations, which was calculated based on data collected by Ukraine-elections (2019) – an aggregator website that discloses poll data related to Ukrainian politics (see Annex B for the methodology of the data aggregation).

The author uses popularity of the parliamentary parties, not of the executive bodies, because the measurements had higher frequency of observations throughout the period. The author does not believe, however, that this should lead to a measurement error for two reasons.

First, the political system of Ukraine is characterized by a presidential-premier system.²⁰ This structure gives the parliament power to allocate positions in the Cabinet of Ministers and influence policy decisions. Thus, a president cannot effectively promote her agenda without support in the parliament. Second, a large chunk of the most important reform packages require parliamentary approval and the Ukrainian parliament was naturally accountable for reform progress. Third, the Ukrainian political arena was characterized by an intense party-competition from 2014 to 2019 and was one of the primary fields that designated political rivalry. In October 2014, when the parliamentary elections for the 2014-2019 tenure took place, the votes of the major ruling parties – Petro Poroshenko Bloc and People’s Front – were not enough to form a coalition. As a result, the first ruling coalition consisted of five parties and gave leverage for the opposition to affect the work of the parliament and form the government.²¹ The power of the leverage became clear in February 2016, when several parties used the resignation of the Minister of Economic Development as a trigger to leave a coalition and

²⁰That is, the president proposes a candidate for premier-minister but requires an approval from the parliament. The parliament, in turn, proposes and approves all ministers except for the Minister of Defense and the Minister of Foreign affairs, who are proposed by the President of Ukraine. Additionally, only the parliament has power to dismiss the cabinet of ministers or any of its individual members.

²¹Four of the parties were formally "new" yet most of their leaders were active on the Ukrainian political scene long before that.

put political pressure on the major ruling parties.²²

The model counterpart of the variable is the political turnout π . Here this paper is following empirical political cycle literature, which uses the difference in popularity of opposing parties as a measure of intensity of political competition (Dubois, 2016).

4.5 Real wages

To construct the series for real wages, the author adjusts the average nominal wage in Ukraine by the chained index of consumer prices. The model counterpart for the series is the size of the economy W_i . Traditionally, macroeconomic studies use gross domestic product as a measure of the aggregate income in the economy. Yet, since GDP is reported quarterly, this study uses real wages, which are reported monthly. This proxy is routinely applied in economic history studies whenever series measuring aggregate income are not readily available (O'Rourke and Williamson, 1999; Clark, 2008).

4.6 Stationarity

After collecting the dataset, data were "deseasoned" by calculating the residuals of each time series after regressing them on monthly dummies (see C for summary statistics of the 'deseasoned' data). That is, the transformed series were calculated according to the following formula:

$$\tilde{y}_t = y_t - (\hat{\alpha} + \sum_{m=2}^{12} \hat{\beta}_m \times d_{m,t}) \quad (4)$$

Where y_t is any time series of a variable in the dataset, m is a month index and $d_{m,i}$ is a dummy variable indicating a month m for an observation t and $\hat{\alpha}, \hat{\beta}_m$ are the parameters estimated by the OLS.

Tables 3 and 4 demonstrate results of the Dickey-Fuller test for the variables of interest. As Table 3 shows, all variables except for wages are stationary at the 5%

²²The parties were able to overcome the political deadlock two months after that.

confidence interval. This circumstance poses an unpleasant choice in the modelling strategy for the regression estimations. One can estimate regressions a) leaving all variables "as-is" and mitigate non-stationarity with lags, b) take first differences of wages, c) take first differences for all variables. This paper goes leaves variables "as-is" and treats results with these data as a baseline estimation because the theory implies that investments in state capacity depend on the *level* of income. This paper shows, however, results with first-differenced variables in the section on robustness checks although interpretation of the results becomes less meaningful in economic terms.

5 Estimations

This paper estimates two types of model to verify the validity of the hypotheses. The first approach assumes that all control variables are perfectly exogenous and estimates an autoregressive distributed lag model. The second approach relaxes this assumption and estimates a vector-autoregression model, which allows for a co-evolution of the variables.

Since the dataset is limited, with 49 observations, this paper tests the ARDL models that allow for no more than 1 lag for the independent variables.

5.1 Models and methods

5.1.1 ARDL

The ARDL model used to estimate the effect of the control variables on reform progress includes all control variables at once and is described by Equation 5.

$$\Delta Reforms_t = \alpha + \beta' \cdot \mathbf{x}_t + \gamma_R \Delta Reforms_{t-1} + \gamma' \cdot \mathbf{x}_{t-1} + \theta' \cdot \mathbf{x}_{t-2} + \varepsilon_t \quad (5)$$

Where \mathbf{x}_t stands for a column-vector of independent variables; β' is a row-vector of parameter values reflecting contemporaneous effects of the indepen-

Table 3: Dickey-Fuller Test: Variables in levels.

Variable	DF_statistic	p_value
Reform Index: Total	-3.530	0.0350
Reform Index: Public Finance	-4.157	0.00400
UAF Fatalities	-5.052	<0.001
IMF tone	-4.047	0.00800
Popularity: PPB	-2.835	0.184
Popularity: Gap	-4.873	<0.001
Log(Real wage)	-2.727	0.224

Sources: "All reforms" uses a sum of evaluations for all laws passed in the Ukrainian parliament; "Public finance" uses a sum of evaluations for all laws contributing to the 'public finance' dimension only. Reform index composed by VoxUkraine (2020); fatalities as reported by Memorybook.org.ua (2020); IMF tone classified by author; real wage as reported by Ukrstat (2019); ; 'Popularity: PPB' is a share of surveyed supporting the ruling party 'Petro Poroshenko Bloc' and 'Popularity: Gap' is the difference between 'Popularity: PPB' and share of surveyed supporting most popular alternative party – both popularity measures calculated as in Annex B based on Ukraine-elections (2019).

dent variables, and γ' , θ' are row-vectors that reflect the parameter values of the lagged effects of the independent variables:

$$\mathbf{x}_t = \begin{bmatrix} \Delta Fatalities_t \\ \Delta(IMF\ tone)_t \\ \Delta(Rating\ measure)_t \\ \Delta(Real\ wage)_t \end{bmatrix}$$

Where "Rating measure" is either the share of population ready to give their vote to the ruling party in the next election or the difference between the share of population supporting the ruling party and the share of population supporting the strongest opposition party.

Table 4: Dickey-Fuller Test: First differences.

Variable	DF_statistic	p_value
D1.Reform Index: Total	-7.355	<0.001
D1.Reform Index: Public Finance	-6.750	<0.001
D1.UAF Fatalities	-5.461	<0.001
D1.IMF tone	-7.387	<0.001
D1.Popularity: PPB	-6.472	<0.001
D1.Popularity: Gap	-6.440	<0.001
D1.Log(Real wage)	-4.480	0.00200

Sources: "All reforms" uses a sum of evaluations for all laws passed in the Ukrainian parliament; "Public finance" uses a sum of evaluations for all laws contributing to the 'public finance' dimension only. Reform index composed by VoxUkraine (2020); fatalities as reported by Memory-book.org.ua (2020); IMF tone classified by author; real wage as reported by Ukrstat (2019); ; 'Popularity: PPB' is a share of surveyed supporting the ruling party 'Petro Poroshenko Bloc' and 'Popularity: Gap' is the difference between 'Popularity: PPB' and share of surveyed supporting most popular alternative party – both popularity measures calculated as in Annex B based on Ukraine-elections (2019).

5.1.2 VAR

To allow for mutual influence between the dependent and independent variables, the paper estimates a VAR model that takes the following representation in the structural form:

$$\mathbf{A}_0 \mathbf{y}_t = \sum_{l=0}^n \mathbf{A}_l \mathbf{y}_{t-l} + \mathbf{B}_0 \mathbf{x}_t + \varepsilon_t \quad (6)$$

Where \mathbf{A}_0 is the matrix of coefficients mapping the effects of the vector of endogenous variables \mathbf{y}_t on itself, \mathbf{B}_0 is the matrix of coefficients mapping the effects of the vector of exogenous variables \mathbf{x}_t on \mathbf{y}_t , and ε_t is a vector of exogenous shocks.

Left-multiplying both sides with \mathbf{A}_0 yields the reduced-form equation:

$$\begin{aligned} \mathbf{y}_t &= \mathbf{A}_0^{-1} \sum_{l=0}^L \mathbf{A}_l \mathbf{y}_{t-l} + \mathbf{A}_0^{-1} \mathbf{B}_0 \mathbf{x}_t + \mathbf{A}_0^{-1} \varepsilon_t \\ &= \sum_{l=0}^L \tilde{\mathbf{A}}_l \mathbf{y}_{t-l} + \tilde{\mathbf{B}}_0 \mathbf{x}_t + \Lambda \varepsilon_t \end{aligned} \quad (7)$$

Where L is the maximum number of lags included, $\tilde{\mathbf{A}}_l \equiv \mathbf{A}_0^{-1} \cdot \mathbf{A}_l$ for all $l \in [0, 1, \dots, n]$, $\tilde{\mathbf{B}}_0 \equiv \mathbf{A}_0^{-1} \cdot \mathbf{B}_0$, and $\mathbf{\Lambda} \equiv \mathbf{A}_0^{-1}$ are defined for a succinct representation.

The presented specification allows only for a contemporaneous impact of strictly exogenous variables. This is done for technical reasons. Each additional lag increase the number of estimated parameters by $4 \times 2 = 8$. Therefore, including two lags similar to the ARDL model would introduce 24 additional parameters, which is arguably too much for a dataset with 49 observations.

Using the maximum likelihood method, one can estimate the vector of coefficients that determine the evolution of y_t : $[\tilde{\mathbf{A}}_0, \tilde{\mathbf{A}}_1, \dots, \tilde{\mathbf{A}}_n, \tilde{\mathbf{B}}_0]$. In a structural VAR model, inference of the moments relies on the order of transmission of shocks reflected in $\mathbf{\Lambda}$. In the present case, this paper imposes restrictions using the fact that formulating and adopting a normative act is typically a tedious procedure.

Consider the case of passing a bill in the Ukrainian parliament. If the bill follows a standard procedure, it takes several months until the parliament adopts the final version and the bill enters into force. Table 5 shows the stages of how bills are passed in the Ukrainian parliament.

Table 2 shows that if all deadlines are fully utilized, the length of passing a bill starting from its registration to its effective application is equal to 104 days (3.5 months). The real time needed to adopt a legal act evaluated by the reform index can, of course, significantly differ from this benchmark value. Bills in the parliament typically take longer to pass for three reasons. First, the parliament – or the committee – can reject the project of the legal act prior to the second reading if the quality of the project is poor. Second, the revision of the law draft can take a long time if members of parliament propose a large number of amendments. Finally, the president can reject the bill and initiate another round of parliamentary reading.

On the other hand, ministerial and presidential decrees follow a simpler procedure and do not require explicit consent of the parliamentary opposition.²⁵ Al-

²⁵This does not imply, however, that the opposition cannot influence adoption of certain decrees. For instance, if adoption of a decree requires the consent of ministries controlled by the other party members, the ‘opposition’ ministry can opportunistically use bureaucratic procedures to significantly slow down adoption of the decree.

Table 5: Procedure of adopting a bill in the Ukrainian parliament.

Stage	Description	Deadline*
1	Registration of a bill's draft	–
2	Preliminary conclusions of the bill by parliamentary committees	5
3	Parliament decides to include the bill to the 'reading' session (a parliamentary discussion)	30
4	First 'reading': discussion of basic principles and structure of a bill	30
5	Second 'reading': discussion of specific articles	14
6	Third 'reading': discussion of the proposed amendments to the bill	5
7	The bill is signed by responsible parliamentary authorities and forwarded to the President of Ukraine for a signature	10
8	The law comes into full forces in 10 days after it is signed by the President of Ukraine unless specified by the bill otherwise	10

* Number of days after the previous stage allowed until a body submits a decision.

Source: Liga Zakon (2020)

though, even in this case, the project of the decree requires a formal approval within the internal ministerial hierarchy. For these reasons, the author expects that the pace of reforms *reacts* to changes in the political or economic environment in the first place.

This motivates the author to adopt the following structure of shocks:

$$\Lambda \varepsilon_t = \begin{bmatrix} a_{11} & 0 \\ a_{12} & a_{22} \end{bmatrix} \cdot \begin{bmatrix} \varepsilon_{\Delta i} \\ \varepsilon_{\Delta j} \end{bmatrix} \quad (8)$$

Where

$$i \in X = \{Fatalities, IMF\ tone, Rating, Real\ wage\},$$

$$j \in Y = \{iMoRe, iMoRe: Public\ Finance\},$$

$$Rating \in \{Rating: Absolute, Rating: Gap\}$$

Since the number of VAR parameters grows quickly with the number of variables in the model and the sample consists of 49 observations only, this paper follows a very parsimonious approach. This paper estimates 10 baseline VAR models with

two endogenous variables that include two lags ($L = 2$), three exogenous variables, and a time trend. Specifically, the vector $\mathbf{y}' = [y^1, y^2]$ is always constructed in such a way that $y^1 \in X$, $y^2 \in Y$ and \mathbf{x}_t is a vector that includes all elements of $X \setminus \{y^{11}\}$. In other words, the vector of endogenous variables always includes a variable that includes a measure of reform progress and an ‘explanatory’ variable – in a sense of being exogenous to an orthogonal shock to reforms in the first period – and the strictly exogenous vector of all other variables, which belong to set X . This paper restricts the number of lags to two periods, because it mimics the time necessary to pass a bill without revisions under a full utilization of the time limits.

5.2 Results

5.2.1 Baseline results

Table 6 shows the baseline estimation results for the ARDL model. Three patterns stand out. First, the statistically significant findings are more pronounced for the aggregate reform index, not for the "Public Finance" components. Second, real wage and popularity of the ruling party appear to have the strongest "impact" across the estimated models. Third, most of the statistically significant effects come with a lag of one or two periods.

The number of UAF fatalities – the variable of major interest for this paper – is insignificant at the 5% significance level in all specifications and in all models, except for model 3 at the 10% level. This contrasts with results for real wages and partly with the measures of political competition. The second lag of the real wages is statistically significant at the 1% level in model 1 and at the 5% level in model 3 with a big magnitude. Taking the coefficients of model 3 at face value, a 1% increase of the real wage increases the reform index by 1.49 iMoRe points in two periods. This implies that doubling the real wage increases reform progress by 149 points – an equivalent of average reform progress for five months.

Measures of electoral competition appear to be a statistically significant variable at the 10% significance level. Yet, one can barely consider the effect to be

Figure 3: VAR: orthogonal impulse-response functions.

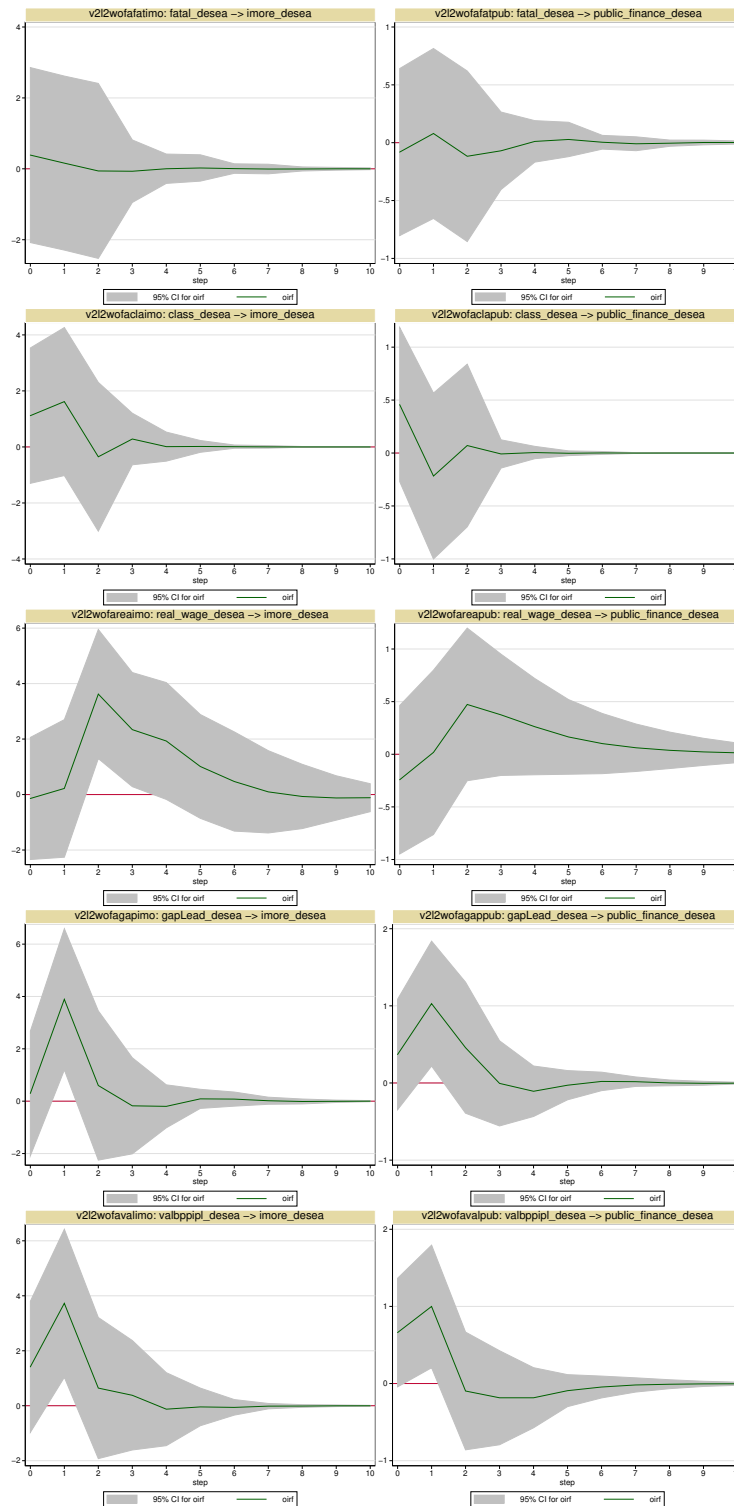

Sources: index of economic reforms and sub-index of reforms in public sector by VoxUkraine (2020); monthly fatalities by Memorybook.org.ua (2020); tone of the IMF communication as described in Annex B.1, real wages by Ukrstat (2019); measures of electoral competition as described in Annex B.3.

economically significant as the magnitudes of the coefficients are small. According to model 4, a 1 p.p. increase in popularity gap between the ruling party and

the most popular opposition party corresponds to an increase of reforms of 0.3 'reform points'. This implies that increasing the gap by 10 p.p. – a value 2.5 times greater than the monthly average – corresponds to an increase in public finance reform index of only 3 points (75% of the monthly average).

The baseline VAR results largely support the findings of the ARDL estimations. Figure 3 shows that real wages and measures of electoral competition are strongly correlated with the pace of reforms. Real wages has a significant positive "impact" only on the aggregate reform index with a lag of two periods, whereas the measures of electoral popularity have a statistically significant positive "effect" in the next period after the shock has occurred.

This is in contrast with the impulse-response functions of the UAF fatalities and the tone of the IMF communication. Neither of the impulses are significant according to the VAR estimations.

5.3 Robustness checks

5.3.1 First differences

As discussed in Section 4, time series for wages are non-stationary. This might result in a spurious correlation. To account for this, this paper provides additional estimations where all variables enter in first-differences.

Estimating results in first differences alters evidence of the baseline ARDL estimation in two respects. First, the coefficients of the lagged real wage in the second period become insignificant in the models, which use the popularity gap as a measure of political competition. Second, the coefficients for the measures of political competition become statistically significant at the 5% level in all specifications.

The VAR estimations (Figure 5) partly support these findings – as the "impact" of real wages becomes statistically insignificant according to the impulse-response functions – yet are also more conservative regarding the "impact" of the popularity indices.

Table 6: ARDL Estimations of Impact of Fatalities on Reform Progress in Ukraine. Variables in Levels.

	(1) All Reforms	(2) Public Finance	(3) All Reforms	(4) Public Finance
UAF Fatalities	0.063 (0.037)	0.009 (0.012)	0.072* (0.040)	0.009 (0.014)
L.UAF Fatalities	0.031 (0.033)	0.006 (0.011)	-0.004 (0.036)	0.001 (0.012)
L2.UAF Fatalities	0.041 (0.034)	0.001 (0.011)	0.022 (0.036)	-0.005 (0.012)
IMF tone	6.300 (6.692)	1.678 (2.308)	10.553 (6.851)	3.625 (2.417)
L.IMF tone	3.217 (6.677)	-3.166 (2.269)	11.208 (6.899)	-0.570 (2.453)
L2.IMF tone	-2.098 (6.564)	-0.156 (2.178)	-1.215 (6.879)	0.152 (2.342)
Log(Real wage)	-20.029 (52.650)	-11.787 (17.095)	-70.611 (55.746)	-25.498 (18.849)
L.Log(Real wage)	-3.910 (63.356)	6.386 (20.900)	-22.122 (67.001)	-0.544 (22.945)
L2.Log(Real wage)	197.724*** (60.470)	27.141 (19.936)	149.252** (59.790)	19.549 (20.564)
Popularity: PPB	1.530* (0.763)	0.458* (0.251)		
L.Popularity: PPB	1.735* (0.922)	0.404 (0.306)		
L2.Popularity: PPB	-0.635 (0.788)	-0.558** (0.261)		
Popularity: Gap			0.272 (0.417)	0.172 (0.142)
L.Popularity: Gap			1.486*** (0.429)	0.294* (0.149)
L2.Popularity: Gap			-0.129 (0.487)	0.027 (0.162)

Notes: standard errors in parenthesis, * $p < 0.1$ ** $p < 0.05$ *** $p < 0.01$. All variables are 'deseasoned' by calculating residuals of an OLS regression with monthly fixed effects. All regressions control for a linear time trend.

Sources: "All reforms" uses a sum of evaluations for all laws passed in the Ukrainian parliament; "Public finance" uses a sum of evaluations for all laws contributing to public finance dimension only. Reform index composed by VoxUkraine (2020); fatalities as reported by Memorybook.org.ua (2020); IMF tone classified by author; real wage as reported by Ukrstat (2019); 'Popularity: PPB' is a share of surveyed supporting the ruling party 'Petro Poroshenko Bloc' and 'Popularity: Gap' is the difference between 'Popularity: PPB' and share of surveyed supporting most popular alternative party – both popularity measures calculated as in Annex B based on Ukraine-elections (2019).

Table 7: ARDL Estimations of Impact of Fatalities on Reform Progress in Ukraine. Variables in First Differences.

	(1) All Reforms	(2) Public Finance	(3) All Reforms	(4) Public Finance
UAF Fatalities	0.061 (0.037)	0.005 (0.012)	0.069* (0.036)	0.005 (0.013)
L.UAF Fatalities	0.042 (0.031)	0.007 (0.010)	0.022 (0.032)	0.002 (0.011)
L2.UAF Fatalities	0.042 (0.032)	0.004 (0.010)	0.031 (0.033)	-0.000 (0.012)
IMF tone	5.280 (6.835)	1.664 (2.364)	6.424 (6.638)	2.382 (2.458)
L.IMF tone	4.403 (7.862)	-1.532 (2.738)	7.951 (8.049)	-0.321 (2.946)
L2.IMF tone	2.225 (6.552)	-0.576 (2.203)	1.364 (6.659)	-0.804 (2.367)
Log(Real wage)	19.819 (57.723)	-14.735 (18.933)	-9.935 (58.568)	-22.713 (20.589)
L.Log(Real wage)	-21.605 (57.264)	-10.725 (19.364)	-49.073 (60.756)	-19.010 (22.046)
L2.Log(Real wage)	145.006** (69.065)	5.230 (23.284)	109.575 (66.934)	-8.013 (24.038)
Popularity: PPB	1.122 (0.968)	0.477 (0.284)		
L.Popularity: PPB	2.207*** (0.774)	0.702** (0.266)		
L2.Popularity: PPB	0.696 (0.852)	0.067 (0.308)		
Popularity: Gap			0.225 (0.428)	0.110 (0.149)
L.Popularity: Gap			1.283*** (0.398)	0.335** (0.139)
L2.Popularity: Gap			0.388 (0.476)	0.123 (0.164)

Notes: standard errors in parenthesis, * $p < 0.1$ ** $p < 0.05$ *** $p < 0.01$. All variables are 'deseasoned' by calculating residuals of an OLS regression with monthly fixed effects. All regressions control for a linear time trend.

Sources: "All reforms" uses a sum of evaluations for all laws passed in the Ukrainian parliament; "Public finance" uses a sum of evaluations for all laws contributing to public finance dimension only. Reform index composed by VoxUkraine (2020); fatalities as reported by Memorybook.org.ua (2020); IMF tone classified by author; real wage as reported by Ukrstat (2019); 'Popularity: PPB' is a share of surveyed supporting the ruling party 'Petro Poroshenko Bloc' and 'Popularity: Gap' is the difference between 'Popularity: PPB' and share of surveyed supporting most popular alternative party – both popularity measures calculated as in Annex B based on Ukraine-elections (2019).

Table 8: ARDL Estimations of Impact of Fatalities on Reform Progress in Ukraine. Variables in Levels. No outliers

	(1) All Reforms	(2) Public Finance	(3) All Reforms	(4) Public Finance
UAF Fatalities	0.065* (0.034)	0.009 (0.011)	0.079** (0.038)	0.011 (0.012)
L.UAF Fatalities	0.019 (0.031)	0.002 (0.010)	-0.011 (0.034)	-0.002 (0.011)
L2.UAF Fatalities	0.037 (0.031)	-0.001 (0.010)	0.026 (0.034)	-0.004 (0.011)
IMF tone	8.223 (6.190)	2.286 (2.153)	7.907 (6.445)	2.644 (2.240)
L.IMF tone	3.408 (6.133)	-3.110 (2.102)	10.252 (6.412)	-0.996 (2.247)
L2.IMF tone	2.955 (6.335)	1.580 (2.137)	0.838 (6.436)	1.167 (2.174)
Log(Real wage)	-23.131 (48.371)	-12.111 (15.838)	-58.873 (51.931)	-21.517 (17.291)
L.Log(Real wage)	-44.387 (60.240)	-5.062 (19.910)	-37.581 (62.468)	-5.121 (21.040)
L2.Log(Real wage)	215.563*** (55.962)	30.286 (18.514)	164.567*** (55.811)	24.467 (18.884)
Popularity: PPB	0.268 (0.853)	0.055 (0.284)		
L.Popularity: PPB	2.327** (0.877)	0.573* (0.292)		
L2.Popularity: PPB	-0.381 (0.730)	-0.474* (0.244)		
Popularity: Gap			-0.078 (0.413)	0.046 (0.138)
L.Popularity: Gap			1.340*** (0.402)	0.230 (0.138)
L2.Popularity: Gap			-0.201 (0.453)	0.003 (0.148)

Notes: standard errors in parenthesis, * $p < 0.1$ ** $p < 0.05$ *** $p < 0.01$. All variables are 'deseasoned' by calculating residuals of an OLS regression with monthly fixed effects. All regressions control for a linear time trend.

Sources: "All reforms" uses a sum of evaluations for all laws passed in the Ukrainian parliament; "Public finance" uses a sum of evaluations for all laws contributing to public finance dimension only. Reform index composed by VoxUkraine (2020); fatalities as reported by Memorybook.org.ua (2020); IMF tone classified by author; real wage as reported by Ukrstat (2019); 'Popularity: PPB' is a share of surveyed supporting the ruling party 'Petro Poroshenko Bloc' and 'Popularity: Gap' is the difference between 'Popularity: PPB' and share of surveyed supporting most popular alternative party – both popularity measures calculated as in Annex B based on Ukraine-elections (2019).

Figure 4: VAR: orthogonal impulse-response functions. Adjusted sample

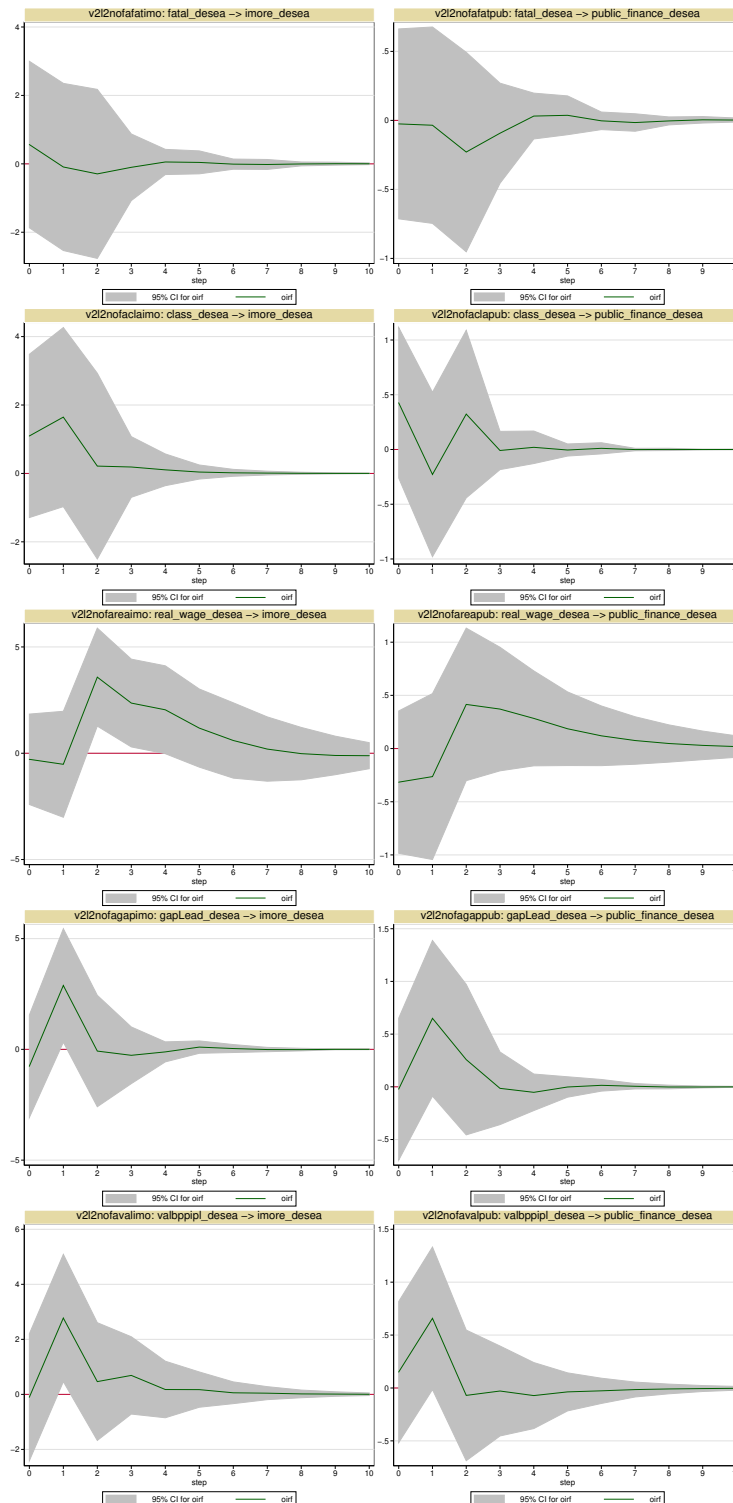

Sources: index of economic reforms and sub-index of reforms in public sector by VoxUkraine (2020); monthly fatalities by Memorybook.org.ua (2020); tone of the IMF communication as described in Annex B.1, real wages by Ukrstat (2019); measures of electoral competition as described in Annex B.3.

Figure 5: VAR: orthogonal impulse-response functions. Variables in first-differences.

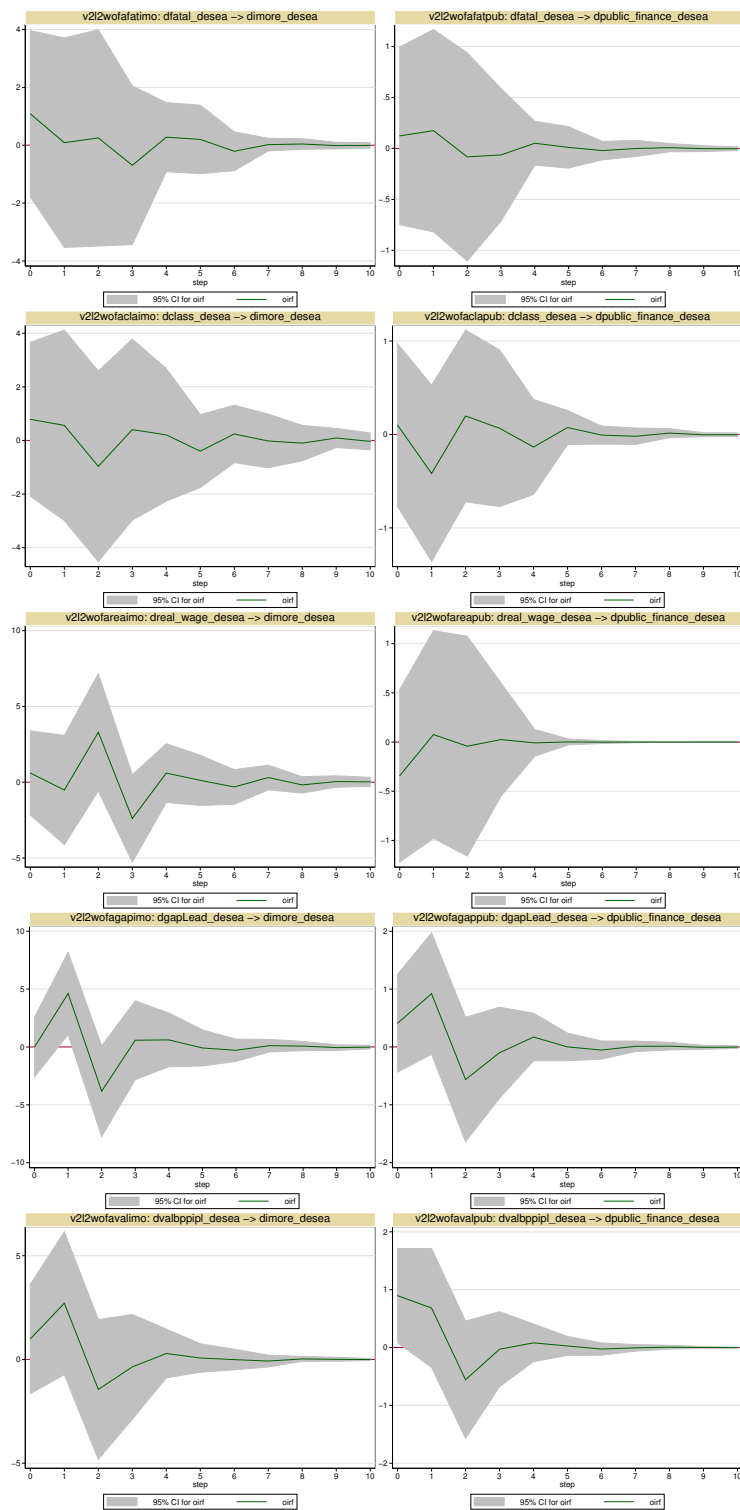

Sources: index of economic reforms and sub-index of reforms in public sector by VoxUkraine (2020); monthly fatalities by Memorybook.org.ua (2020); tone of the IMF communication as described in Annex B.1, real wages by Ukrstat (2019); measures of electoral competition as described in Annex B.3.

Specifically, changes in the popularity gap appear to have no statistically sig-

nificant effect on the score of public finance reforms, whereas the changes in absolute popularity have no statistically significant "effect" on the total reform score.

At the same time, the results for the UAF fatalities and the tone of the IMF communication do not change. Neither the updated ARDL, nor the VAR estimations reveal that variables become statistically significant in any other specifications other than indicated for the baseline estimation results.

5.3.2 No outliers

The statistically significant effect of the political measures can be partly attributed to an observation with high leverage. A careful look at time series measuring political competition reveals an outlier, which is characterized by high deviation from the means of both the reform index and the absolute popularity of the ruling party (see Figure 6).

Since the popularity measures used in this paper are aggregates of the indices reported by Ukrainian survey companies, this outlier could be a result of a sampling error among one of them. For this reason, this paper replicates all results after dropping the suspicious observation.

The baseline regressions with the adjusted sample do not alter the initial results for the popularity measures. On the one hand, the "impact" of the popularity gap becomes insignificant for the public finance score at the 10% significance level. On the other hand, the effect of the absolute popularity on the overall reform index becomes statistically significant at the 5% level. Similar changes are also reflected in the VAR estimations: the impulse of the popularity measures on the total reform index remains statistically significant at the 5% level one period after the shock, but is insignificant for the public finance reform score.

Somewhat surprisingly, dropping the outlier leads to an increase in magnitude and smaller standard errors of the parameter measuring the effect of the UAF fatalities. The effect of the UAF deaths on the total reform score becomes statistically significant at the 10% level in the model controlling for absolute popularity

Figure 6: Correlation between the popularity of the ruling party and the iMoRe index. First differences.

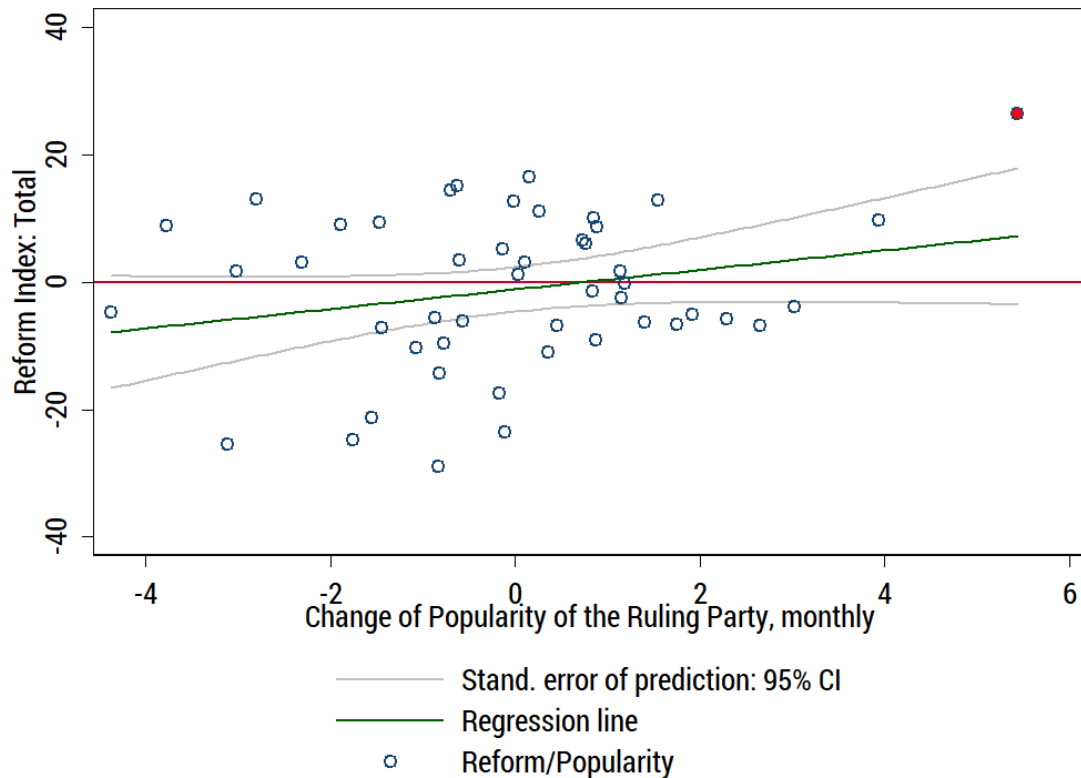

Note: Outlier marked with red. **Sources:** index of economic reforms by VoxUkraine (2020); popularity of the ruling party as described in Annex B.3.

and at the 5% level in the model controlling for the popularity gap. Yet the VAR estimations do not speak in favor of the same hypothesis. Figure 4 shows that the magnitude of the estimated shock on either of the reform indices remains small and the confidence bounds stay too wide to conclude that the change in the UAF fatalities had any impact on reform progress.

5.4 Discussion

The collected evidence conveys two messages relevant to the theoretical discussion. First, it seems that despite its simplicity, the presented model captures important features of the data-generating process in the context of the war in Ukraine. Directions of the statistically significant effects are consistent with the theoretical predictions despite a limited sample size and a comparatively large number of estimated parameters.

Second, conflict intensity does not seem to be the major mechanism that drives the reform progress in Ukraine. Among the considered factors, it is political competition and resource capacity of the state which are more strongly associated with reform progress.

Before drawing the bottom line, the author finds it necessary to mention some caveats of the empirical evaluation provided above. One obvious problem is the limited sample size coupled with the large parameter vector. As indicated above, the observed results appear to be sensitive to data transformation and inclusion/exclusion of single observations. This problem is, however, difficult to avoid as institutional change is typically considered to be a long-term process, which carries a lot of inertia and implies that one should account for lagged variables.

Finally, it is necessary to stress that the regression results find more statistically significant results for the overall reform progress, not for the public finance dimension alone. Although one can argue that the data-generation process of the public finance score is more noisy than of the overall reform index – the coefficient of variation for the public finance score is 0.94 and for the overall index is 0.77 – one cannot rule out that the selected control variables are better at explaining the overall institutional change rather than state capacity.

6 Conclusion

The ongoing discussion on state capacity is largely concentrated around effects generated by conflicts and political competition. Although both effects are simultaneously present in theoretical models, this is rarely the case for empirical studies.

This paper confronts both effects together with the impact of war on the aggregate economy and international aid in the context of the ongoing war in Ukraine. The empirical results largely reject the hypothesis that the war or credit conditionality imposed by the IMF have promoted greater state capacity in Ukraine. It supports, however, the view that electoral politics and income changes had a greater importance in reform progress in Ukraine.

These findings suggest that the ongoing discussion on the evolution of state capacity focuses too much on the mechanisms, which were more relevant for states of the past rather than for present-day countries with rich electoral politics. Given this circumstance, it is natural to suggest that the weight of political competition becomes more important in advancing the state capacity of a country. The case of Ukraine suggests that elites are more concerned with their chances of staying in power rather than with consequences of fighting a protracted war with a stable front line.

The results of this paper suggest paying attention to two aspects in subsequent research. First, if the hypothesis of declining elite losses in case of defeat in war is true, then one would expect a structural break in the parameter values measuring the impact of war on state capacity after the establishment of modern multilateral governance institutions or any system of international relations backed up by major states. Second, the paper highlights that accounting for a resource diversion effect is necessary in considering the capacity-enhancing effect of wars. Armed conflicts might provide "right" incentives for the country elites but incentives do not matter if resources are not in place, which is likely to be the case if the country lies in ruins. From this perspective, an external long-distance war – say colonial conquests of the Early Modern time – should have a greater net positive impact on state capacity than traditional territorial conflicts between neighboring countries.

The present paper also highlights challenges and pathways in linking theoretical implications to empirical estimations with time series models. Combining web-scraping of news and collaboratively-composed internet sources with classification techniques allows for systematically collecting proxy measures of the variables of interest, which would not be available otherwise. Nonetheless, the collected dataset still suffered from a comparatively small number of observations and imperfect measurement. Future researchers could address these issues by developing automated web-scraping systems – which would systematically collect high-frequency data on conflicts, donor-recipient relations, and popular-

ity of political leaders – or applying Bayesian estimation techniques.

These advances will help to complement long-term studies with present-day evidence. In particular, they might reveal differences in essential trade-offs that the governments of war-affected countries face today. Judging by the results of this paper, this is a valid concern. Unlike the states of the distant past, Ukraine is not marching to goods laws. Instead Ukrainians seem to pay for them, with coins or votes.

References

- Acemoglu, D. (2005). Politics and economics in weak and strong states. *Journal of Monetary Economics* 52(7), 1199–1226.
- Acemoglu, D., S. Johnson, and J. A. Robinson (2001). The colonial origins of comparative development: An empirical investigation. *American Economic Review* 91(5), 1369–1401.
- Acemoglu, D., S. Johnson, and J. A. Robinson (2002). Reversal of fortune: Geography and institutions in the making of the modern world income distribution. *Quarterly Journal of Economics* 117(4), 1231–1294.
- Acemoglu, D., S. Naidu, P. Restrepo, and J. A. Robinson (2019). Democracy does cause growth. *Journal of Political Economy* 127(1), 47–100.
- Acemoglu, D. and J. A. Robinson (2005). *Economic origins of dictatorship and democracy*. New York, NY: Cambridge University Press.
- Arias, L. M. (2013). Building fiscal capacity in colonial Mexico: from fragmentation to centralization. *Journal of Economic History* 73(3), 662–693.
- Barro, R. and X. Sala-i Martin (2004). *Economic growth* (2 ed.). Cambridge, MA: MIT Press.
- Barro, R. J. (1996). Democracy and growth. *Journal of Economic Growth* 1(1), 1–27.

- Barro, R. J. and J.-W. Lee (2005). IMF programs: Who is chosen and what are the effects? *Journal of Monetary Economics* 52(7), 1245–1269.
- Bates, R. H. (2008). *When things fell apart*. New York, NY: Cambridge University Press.
- Bekeshina, I. and O. Khmelko (2013). Majdan-2013: kto stoit, pochemu i za chto? <http://archive.is/eCe0x>, kiis.com.ua, [Online; accessed 25-February-2020].
- Besley, T. and H. Mueller (2012). Estimating the peace dividend: The impact of violence on house prices in Northern Ireland. *American Economic Review* 102(2), 810–33.
- Besley, T. and T. Persson (2011). *Pillars of prosperity: The political economics of development clusters*. Princeton, NJ: Princeton University Press.
- Bird, S., E. Klein, and E. Loper (2009). *Natural language processing with Python: Analyzing text with the natural language toolkit*. Sebastopol, CA: O'Reilly Media.
- Blattman, C. and E. Miguel (2010). Civil war. *Journal of Economic Literature* 48(1), 3–57.
- Bluszcz, J. and M. Valente (2019). The war in Europe: Economic costs of the Ukrainian conflict. *Working paper*.
- Bourguignon, F. and T. Verdier (2012). The simple analysis of elite behavior under limited state capacity. In *The role of elites in economic development*, pp. 251–280. Oxford: Oxford University Press.
- Brauer, J. and P. Dunne (2012). *Peace economics: A macroeconomic primer for violence-afflicted states*. Washington, DC: United States Institute of Peace Academy guides.
- Chang, H.-J. (2002). *Kicking away the ladder: development strategy in historical perspective*. London: Anthem Press.

- Chowdhury, A. R. and S. M. Murshed (2016). Conflict and fiscal capacity. *Defence and Peace Economics* 27(5), 583–608.
- Clark, G. (2008). *A farewell to alms: A brief economic history of the world*, Volume 25. Princeton, NJ: Princeton University Press.
- Collier, P. and A. Hoeffler (2002). Aid, policy and peace: Reducing the risks of civil conflict. *Defence and Peace Economics* 13(6), 435–450.
- Dell, M. (2010). The persistent effects of Peru’s mining mita. *Econometrica* 78(6), 1863–1903.
- Dincecco, M., J. Fenske, and M. G. Onorato (2019). Is Africa different? Historical conflict and state development. *Economic History of Developing Regions* 34(2), 209–250.
- Dincecco, M. and M. Prado (2012). Warfare, fiscal capacity, and performance. *Journal of Economic Growth* 17(3), 171–203.
- Dreher, A. (2009). IMF conditionality: theory and evidence. *Public choice* 141(1-2), 233–267.
- Dubois, E. (2016). Political business cycles 40 years after nordhaus. *Public Choice* 166(1-2), 235–259.
- Easaw, J., S. Leppälä, et al. (2019). Democracy, state capacity and public finance. *Working paper*.
- Fergusson, L. (2019). Who wants violence? The political economy of conflict and state building in Colombia. *Cuadernos de Economía* 38(spe78), 671–700.
- Fergusson, L., H. Larreguy, J. F. Riano, et al. (2018). Political competition and state capacity: Evidence from a land allocation program in Mexico. *Working paper*.
- Findley, M. G. (2018). Does foreign aid build peace? *Annual Review of Political Science* 21, 359–384.

- Gaidar, Y. (2010). *Collapse of an empire: Lessons for modern Russia*. Washington, DC: Brookings Institution Press.
- Gaidar, Y. (2012). *Russia: A Long View*. Cambridge, MA: MIT Press.
- Gardeazabal, J. (2010). Methods for measuring aggregate costs of conflict. In *The Oxford Handbook of the Economics of Peace and Conflict*. New York, NY: Oxford University Press.
- Gennaioli, N. and H.-J. Voth (2015). State capacity and military conflict. *Review of Economic Studies* 82(4), 1409–1448.
- Havlik, P., A. Kochnev, and O. Pindyuk (2020). Economic challenges and costs of reintegrating the Donbas region in Ukraine. Technical report, The Vienna Institute for International Economic Studies (wiiw).
- Herrera, H. and C. Martinelli (2013). Oligarchy, democracy, and state capacity. *Economic Theory* 52(1), 165–186.
- Himshiashvili, P. (2014). Pravitel'stvo s zapadnym akcentom: Kak Jacenjuk i Poroshenko podelili kabmin. <http://archive.is/mXbye>, kiis.com.ua, [Online; accessed 25-February-2020].
- Hintze, O. and F. Gilbert (1975). Military organization and the organization of the state. In *The Historical Essays of Otto Hintze*, pp. 181. New York, NY: Oxford University Press.
- Jurafsky, D. and J. H. Martin (2000). *Speech & language processing* (1 ed.). Upper Saddle River, NJ: Prentice Hall.
- Liga Zakon (2020). Zakonodatel'naja procedura v Ukraine. <http://archive.is/o1tjU>, ligazakon.ua, [Online; accessed 01-March-2020].
- Machiavelli, N. (2008). *The Prince*. Oxford: Oxford University Press.
- Memorybook.org.ua (2020). Book of memory of the dead. <https://memorybook.org.ua/>, memorybook.org.ua, [Online; accessed 01-January-2020].

- Mueller, H. (2013). The economic cost of conflict. *Working paper*.
- North, D. C. (1990). *Institutions, institutional change and economic performance*. Cambridge: Cambridge University Press.
- North, D. C. (1994). Economic performance through time. *American Economic Review* 84(3), 359–368.
- North, D. C., J. J. Wallis, and B. R. Weingast (2009). *Violence and social orders: A conceptual framework for interpreting recorded human history*. Cambridge: Cambridge University Press.
- Olson, M. (1982). *The rise and decline of nations: Economic growth, stagflation, and social rigidities*. New Haven, CT: Yale University Press.
- O'Rourke, K. H. and J. G. Williamson (1999). *Globalization and history: The evolution of a nineteenth-century Atlantic economy*. Cambridge, MA: MIT press.
- Papi, L., A. F. Presbitero, and A. Zazzaro (2015). IMF lending and banking crises. *IMF Economic Review* 63(3), 644–691.
- Pedregosa, F., G. Varoquaux, A. Gramfort, V. Michel, B. Thirion, O. Grisel, M. Blondel, P. Prettenhofer, R. Weiss, V. Dubourg, J. Vanderplas, A. Passos, D. Cournapeau, M. Brucher, M. Perrot, and E. Duchesnay (2011). Scikit-learn: Machine learning in Python. *Journal of Machine Learning Research* 12, 2825–2830.
- Prentice, A. (2018). Ukraine anti-corruption court law needs amending: IMF chief. <http://archive.is/XX2yD>, Reuters.com, [Online; accessed 29-February-2019].
- Queralt, D. (2016). The legacy of war on fiscal capacity. *Working paper*.
- Quibria, M. (2014). Aid effectiveness: research, policy and unresolved issues. *Development Studies Research. An Open Access Journal* 1(1), 75–87.
- Ray, D. and J. Esteban (2017). Conflict and development. *Annual Review of Economics* 9, 263–293.

- RBC.ru (2020). Nebenzja zajavil o sabotazhe Minskih soglashenij ukrainoj. <http://archive.is/eBvM9>, rbc.ru, [Online; accessed 01-March-2020].
- Reuters.com (2020). Business & financial news, U.S. & international breaking news. <https://www.reuters.com/>, reuters.com, [Online; accessed 13-April-2020].
- Robinson, J. A. and D. Acemoglu (2012). *Why nations fail: The origins of power, prosperity and poverty*. New York, NY: Crown Business.
- Rodrik, D. (2006). Goodbye Washington consensus, hello Washington confusion? A review of the World Bank's economic growth in the 1990s: Learning from a decade of reform. *Journal of Economic literature* 44(4), 973–987.
- Rodrik, D. (2015). *Economics rules: The rights and wrongs of the dismal science*. New York, NY: WW Norton & Company.
- Róland, G. (2000). *Transition and economics: Politics, markets, and firms*. Cambridge, MA: MIT press.
- Scikit-learn.org (2019). Scikit-learn user guide: Release 0.21.3. Technical report, Scikit-learn developers. https://scikit-learn.org/0.21/_downloads/scikit-learn-docs.pdf, scikit-learn.org, [Online; accessed 29-February-2019].
- Stiglitz, J. (1999). Whither reform. In *Keynote address for the Annual Bank Conference on Development Economics*, Washington, DC. World Bank.
- Tilly, C. (2017). Coercion, capital, and European states, AD 990–1990. In *Collective Violence, Contentious Politics, and Social Change*, pp. 140–154. Routledge.
- Ukraine-elections (2019). Ukraine elections. <https://ukraine-elections.com.ua/>, ukraine-elections.com.ua, [Online; accessed 09-September-2019].
- Ukrstat (2019). Average monthly salary in Ukraine. <http://ukrstat.gov.ua>, ukrstat.gov.ua, [Online; accessed 01-September-2019].

UNOCHA (2018). Humanitarian needs overview: 2019: Ukraine. Technical report, United Nations Office for the Coordination of Humanitarian Affairs. <https://www.humanitarianresponse.info/en/operations/ukraine/document/ukraine-2019-humanitarian-needs-overview-summary>, humanitarianresponse.info, [Online; accessed 01-March-2020].

Vedernikova, I., V. Kravchenko, J. Mostovaja, and T. Silina (2019). Test na sovmestimost'. <http://archive.is/FmDjb>, zn.ua, [Online; accessed 01-March-2020].

Verkhovna Rada (2018). Opublikovan zakon ukrainy «Ob osobennostjah gosudarstvennoj politiki po obespečeniju gosudarstvennogo suvereniteta Ukrainy nad vremenno okkupirovannymi territorijami v Doneckoj i Duganskoj oblastjah». <http://archive.is/GWJfw>, rada.gov.ua, [Online; accessed 01-March-2020].

VoxUkraine (2020). Index for monitoring reforms. <http://imorevox.org>, imorevox.org, [Online; accessed 01-September-2019].

Annex

Description: Contains supplementary figures, tables, and description of datasets.

A Mathematical Appendix

A.1 Proof of Proposition 1

Proof. The model is solved using backward induction. Start by calculating the Stage 2 Utilities for the party in power:

$$U_2^P = \mu_P \ln M_2 + \rho \ln R_2 + \omega_P \ln (1 - t_2) w_2^P L_2^P \quad (9)$$

The period 2 budget constraint for a party in power is defined as follows:

$$\phi F + \tau_2 t W_2 = R_2 + M_2 \quad (10)$$

Note that in period 2 agents treat τ_2 as an exogenous variable because it is determined in stage 1. Solve the optimization problem for the party in power:

$$\mathcal{L} = \mu_P \ln M_2 + \rho \ln R_2 + \omega_P \ln (1 - t_2) w_2^P L_2^P - \lambda (R_2 + M_2 - t_2 \tau_2 W_2 - \phi F) \quad (11)$$

The first-order conditions are as follows:

$$\frac{\partial \mathcal{L}}{\partial M_2} : \frac{\mu_P}{M_2} = \lambda \quad (12)$$

$$\frac{\partial \mathcal{L}}{\partial R_2} : \frac{\rho}{R_2} = \lambda \quad (13)$$

$$\frac{\partial \mathcal{L}}{\partial t_2} : \frac{\omega_P}{(1 - t_2) w_2^P L_2^P} \times (-w_2^P L_2^P) = -\lambda \tau_2 W_2 \implies \frac{\omega_P}{(1 - t_2) \tau_2 W_2} = \lambda \quad (14)$$

Rearrange the first-order conditions and insert them to the budget constraint to obtain the solution:

$$\frac{\mu_P}{M_2} = \frac{\rho}{R_2} \implies R_2 = \frac{\rho}{\mu_P} \times M_2 \quad (15)$$

$$\frac{\mu_P}{M_2} = \frac{\omega_P}{(1 - t) \tau_2 W_2} \implies (1 - t_2) = \frac{\omega_P M_2}{\mu_P \tau_2 W_2} \implies t_2 = \left(1 - \frac{\omega_P M_2}{\mu_P \tau_2 W_2} \right) \quad (16)$$

$$M_2 + \frac{\rho}{\mu_P} M_2 = \tau_2 W_2 \left(1 - \frac{\omega_P M_2}{\mu_P \tau_2 W_2} \right) + \phi F \implies M_2 \left(1 + \frac{\rho}{\mu_P} + \frac{\omega}{\mu_P} \right) = \tau_2 W_2 + \phi F \quad (17)$$

The solution of the problem for the party in power is defined as follows:

$$M_2^* = \frac{\mu(\tau_2 W_2 + \phi F)}{\mu_P + \rho + \omega_P} \quad (18)$$

$$R_2^* = \frac{\rho(\tau_2 W_2 + \phi F)}{\mu_P + \rho + \omega_P} \quad (19)$$

$$t_2^* = 1 - \frac{\omega_P}{\mu_P + \rho + \omega_P} \quad (20)$$

The indirect utility of the party in power in optimum of the stage 2 takes the following form:

$$V_2^P = \mu_P \ln \frac{\mu_P(\tau_2 W_2 + \phi F)}{\mu_P + \rho + \omega_P} + \rho \ln \frac{\rho(\tau_2 W_2 + \phi F)}{\mu_P + \rho + \omega_P} + \omega_P \ln \left(\frac{\omega_P}{\mu_P + \rho + \omega_P} w_2^P L_2^P \right) \quad (21)$$

Since the opposition party do not have any control variables in the model, they act as public goods- and tax-takers. That is:

$$V_2^O = \mu_O \ln \frac{\mu_P(\tau_2 W_2 + \phi F)}{\mu_P + \rho + \omega_P} + \omega_O \ln \left(\frac{\omega_P}{\mu_P + \rho + \omega_P} w_2^O L_2^O \right) \quad (22)$$

Since at the beginning of the first period the party in power do not know, whether they stay in power or not, the utility of the second period takes takes an expected value, weighted by exogenous probability weighs $(\pi, 1 - \pi)$.

$$\begin{aligned} \mathbb{E}(V_2) &= \pi \times \\ &\times \left\{ \mu_P \ln \frac{\mu_P(\tau_2 W_2 + \phi F)}{\mu_P + \rho + \omega_P} + \rho \ln \frac{\rho(\tau_2 W_2 + \phi F)}{\mu_P + \rho + \omega_P} + \omega_P \ln \left(\frac{\omega_P}{\mu_P + \rho + \omega_P} w_2^P L_2^P \right) \right\} + \\ &+ (1 - \pi) \left\{ \mu_O \ln \frac{\mu_P(\tau_2 W_2 + \phi F)}{\mu_P + \rho + \omega_P} + \omega_O \ln \left(\frac{\omega_P}{\mu_P + \rho + \omega_P} w_2^O L_2^O \right) \right\} \end{aligned}$$

After simplification, this expression reduces to the following equation:

$$\begin{aligned}
\mathbb{E}(V_2) &= (\pi\mu_P + (1 - \pi)\mu_O) \ln \frac{\mu_P(\tau_2 W_2 + \phi F)}{\mu_2 + \rho + \omega_2} + \\
&+ (\pi\omega_P + (1 - \pi)\omega_O) \ln \left(\frac{\omega_P}{\mu_P + \rho + \omega_P} \right) + \\
&+ \pi \times \left\{ \rho \ln \frac{\rho(\tau_2 W_2 + \phi F)}{\mu_P + \rho + \omega_P} + \omega_P \ln (w_2^P L_2^P) \right\} + \\
&+ (1 - \pi)\omega_O \ln (w_2^O L_2^O)
\end{aligned} \tag{23}$$

Now one can solve the optimization problem of the party in power in period 1 using the optimal solution for stage 2. Note that now τ_2 is a determined endogenously through F as it is stage 1.

$$\begin{aligned}
\mathbb{E}(U_1) &= \mu_P \ln M_1 + \rho \ln R_1 + \omega_P \ln (1 - t_1) w_1^P L_1^P + \\
&+ (\pi\mu_P + (1 - \pi)\mu_O) \ln \frac{\mu_P(\tau_2(F) W_2 + \phi F)}{\mu_2 + \rho + \omega_2} + \\
&+ (\pi\omega_P + (1 - \pi)\omega_O) \ln \left(\frac{\omega_P}{\mu_P + \rho + \omega_P} \right) + \\
&+ \pi \left\{ \rho \ln \frac{\rho(\tau_2(F) W_2 + \phi F)}{\mu_P + \rho + \omega_P} + \omega_P \ln (w_2^P L_2^P) \right\} + \\
&+ (1 - \pi)\omega_O \ln (w_2^O L_2^O)
\end{aligned} \tag{24}$$

Subject to a period 1 constraint, which features investments in state capacity F :

$$\tau_1 t_1 W_1 = R_1 + M_1 + F \tag{25}$$

Formulate the Lagrangian and solve the optimization problem of the party in power:

$$\begin{aligned}
\mathcal{L} &= \mu_P \ln M_1 + \rho \ln R_1 + \omega_P \ln (1 - t_1) w_1^P L_1^P + \\
&+ (\pi\mu_P + (1 - \pi)\mu_O) \ln \frac{\mu_P(\tau_2(F) W_2 + \phi F)}{\mu_2 + \rho + \omega_2} + \\
&+ (\pi\omega_P + (1 - \pi)\omega_O) \ln \left(\frac{\omega_P}{\mu_P + \rho + \omega_P} \right) + \\
&+ \pi \left\{ \rho \ln \frac{\rho(\tau_2(F) W_2 + \phi F)}{\mu_P + \rho + \omega_P} + \omega_P \ln (w_2^P L_2^P) \right\} + \\
&+ (1 - \pi)\omega_O \ln (w_2^O L_2^O) - \lambda(R_1 + M_1 + F - \tau_1 t_1 W_1)
\end{aligned} \tag{26}$$

The first-order conditions are defined as follows:

$$\frac{\partial \mathcal{L}}{\partial M_1} : \frac{\mu_P}{M_1} = \lambda \quad (27)$$

$$\frac{\partial \mathcal{L}}{\partial R_1} : \frac{\rho_P}{R_1} = \lambda \quad (28)$$

$$\frac{\partial \mathcal{L}}{\partial t_1} : \frac{\omega_P}{(1-t_1)w_1^P L_1^P} \times (-w_1^P L_1^P) = -\lambda \tau_1 W_1 \implies \frac{\omega}{(1-t_1)\tau_1 W_1} = \lambda \quad (29)$$

$$\begin{aligned} \frac{\partial \mathcal{L}}{\partial F} : & (\pi\mu_P + (1-\pi)\mu_O) \frac{\mu_P + \rho + \omega_P}{\mu_P(\tau_2(F)W_2 + \phi F)} \frac{\mu_P}{\mu_P + \rho + \omega_P} (\tau_2'(F)W_2 + \phi) + \\ & + \pi\rho \frac{\mu_P + \rho + \omega_P}{\rho(\tau_2(F)W_2 + \phi F)} \frac{\rho}{\mu_P + \rho + \omega_P} (\tau_2'(F)W_2 + \phi) = \lambda \end{aligned} \quad (30)$$

$$\begin{aligned} \frac{\partial L}{\partial F} : & (\pi\mu_P + (1-\pi)\mu_O) \frac{(\tau_2'(F)W_2 + \phi)}{(\tau_2(F)W_2 + \phi F)} + \pi\rho \frac{(\tau_2'(F)W_2 + \phi)}{(\tau_2(F)W_2 + \phi F)} = \lambda \\ \implies & \frac{(\tau_2'(F)W_2 + \phi)}{(\tau_2(F)W_2 + \phi F)} (\pi(\mu_P + \rho) + (1-\pi)\mu_O) = \lambda \end{aligned} \quad (31)$$

Assume that $\tau_2(F) = \kappa F \implies \tau_2'(F) = \kappa$. Then:

$$\frac{\tau_2'(F)W_2 + \phi}{\tau_2(F)W_2 + \phi F} = \frac{\kappa W_2 + \phi}{F(\kappa W_2 + \phi)} = \frac{1}{F} \quad (32)$$

$$\frac{\partial L}{\partial F} : \frac{1}{F} (\pi(\mu_P + \rho) + (1-\pi)\mu_O) = \lambda \quad (33)$$

Find the optimum by using the first-order conditions and the budget constraint:

$$R_1 = \frac{\rho}{\mu_P} M_1 \quad (34)$$

$$t_1 = 1 - \frac{\omega_P M_1}{\mu_P W_1 \tau_1} \quad (35)$$

$$F = \frac{\pi(\mu_P + \rho) + (1-\pi)\mu_O}{\mu_P} M_1 \quad (36)$$

Substituting the values in the budget constraint yields:

$$M_1 + \frac{\rho}{\mu_P} M_1 + \frac{\pi(\mu_P + \rho) + (1 - \pi)\mu_O}{\mu_P} M_1 = \tau_1 \left(1 - \frac{\omega_P M_1}{\mu_P W_1 \tau_1} \right) W_1 \implies$$

$$M_1 \left(1 + \frac{\rho}{\mu_P} + \frac{\pi(\mu_P + \rho) + (1 - \pi)\mu_O}{\mu_P} + \frac{\omega_P}{\mu_P} \right) = \tau_1 W_1 \quad (37)$$

Solving the equation for M_1^* and substituting the solution into Equation 34, 35, 36, the optimal distribution of budget is defined as follows:

$$M_1^* = \frac{\mu_P \tau_1 W_1}{(1 + \pi)(\mu_P + \rho) + (1 - \pi)\mu_O + \omega_P} \quad (38)$$

$$R_1^* = \frac{\rho \tau_1 W_1}{(1 + \pi)(\mu_P + \rho) + (1 - \pi)\mu_O + \omega_P} \quad (39)$$

$$t_1^* = \frac{\omega_P}{(1 + \pi)(\mu_P + \rho) + (1 - \pi)\mu_O + \omega_P} \quad (40)$$

$$F^* = \frac{(\pi(\mu_P + \rho) + (1 - \pi)\mu_O)\tau_1 W_1}{(1 + \pi)(\mu_P + \rho) + (1 - \pi)\mu_O + \omega_P} \quad (41)$$

The effect of the probability of the next tenure on the investment in state-capacity can be evaluated by differentiating F^* over π . Since denominator of the derivative is positive, it suffices to show that the numerator is positive as well.

$$\text{sign} \left\{ \frac{\partial F^*}{\partial \pi} \right\} = \text{sign} \{ (\mu_P + \rho - \mu_O)\tau_1 W_1 [(1 + \pi)(\mu_P + \rho) + (1 - \pi)\mu_O + \omega_P -$$

$$- \pi(\mu_P + \rho) - (1 - \pi)\mu_O] \} > 0, \text{ since } (\mu_P + \rho - \mu_O) > 0 \quad (42)$$

The derivation for μ_O, μ_P is more involved, because it depends whether or not the constraint defining the economies of scale becomes binding when one perturbs the parameter value. Consequently we prove for two cases:

- Case 1. Non-increasing returns to scale are non-binding: $\mu_P + \rho + \omega_P < 1$ and $\mu_O + \omega_O < 1$. In this case an increase in one parameter does not imply a decrease in another parameter or the combination of both.
- Case 2: Non-increasing returns to scale are binding: $\mu_P + \rho + \omega_P = 1$ and

$\mu_O + \omega_O = 1$. In this case an increase in one parameter implies a decrease in another parameter or the combination of both.

Case 1. Assume that both constraints are non-binding: i) $\mu_P + \epsilon_{\mu_P} + \rho + \omega_P < 1$; ii) $\mu_O + \epsilon_{\mu_O} + \omega_O < 1$, where $\epsilon_{\mu_P}, \epsilon_{\mu_O}$ stand for perturbation of μ_P and μ_O respectively.

Then, differentiating the optimal value of F^* shows that the optimal investments in state capacity grow with respect to probability of staying in power π and elasticities of public goods μ_P, μ_O . Since a denominator of power 1 in a derivative of a ratio is always positive, it suffices to show that the derivative of the numerator is greater than zero.

$$\text{sign} \left\{ \frac{\partial F^*}{\partial \mu_P} \right\} = \text{sign} \{ \pi \tau_1 W_1 [(1 + \pi)(\mu_P + \rho) + (1 - \pi)\mu_O + \omega_P - \pi(\mu_P + \rho) - (1 - \pi)\mu_O] \} > 0 \quad (43)$$

$$\text{sign} \left\{ \frac{\partial F^*}{\partial \mu_O} \right\} = \text{sign} \{ (1 - \pi) \tau_1 W_1 [(1 + \pi)(\mu_P + \rho) + (1 - \pi)\mu_O + \omega_P - \pi(\mu_P + \rho) - (1 - \pi)\mu_O] \} > 0 \quad (44)$$

Case 2. Assume that both constraints are binding: i) $\mu_P + \rho + \omega_P = 1$; ii) $\mu_O + \omega_O = 1$. In this case, any perturbation of μ_P should be balanced by the opposite perturbation of ρ or ω_P or the combination of both. The same applies for μ_O and ω_O , yet observe that F^* is not a function of ω_O , therefore this constraint has no impact on the equilibrium investment in state capacity. Hence only the case for $\mu_P + \rho + \omega_P = 1$ should be investigated.

Define ϵ_{μ_P} as a perturbation of μ_P , ϵ_ρ as a perturbation of ρ , and ϵ_{ω_P} as a perturbation of ω_P such that $\epsilon_{\mu_P} = \epsilon_\rho + \epsilon_{\omega_P}$. Define $\tilde{\mu}_P, \tilde{\rho}, \tilde{\omega}$ as the “perturbated” parameter values such that $\tilde{\mu}_P = \mu_P + \epsilon_{\mu_P}, \tilde{\rho} = \rho + \epsilon_\rho, \tilde{\omega}_P = \omega_P + \epsilon_{\omega_P}$ such that $\epsilon_{\mu_P} \in (0, 1 - \mu_P], \epsilon_\rho \in (-\rho, 0], \epsilon_{\omega_P} \in (-\omega_P, 0]$.

The restriction imposed on the domains of “perturbations” excludes cases when the changes in parameter values are complementary. That is, one excludes

the cases when an increase of μ_P results in an increase of ρ or ω_P (one can call this). Since the sum of the “perturbated” values must be equal to 1, the following condition must hold: $\epsilon_{\mu_P} + \epsilon_\rho + \epsilon_{\omega_P} = 0$.

Define $F^*(\tilde{\mu}_P, \tilde{\rho}, \tilde{\omega}_P)$ as \tilde{F}^* . Then:

$$\begin{aligned}
\tilde{F}^* &= \frac{(\pi(\mu_P + \epsilon_{\mu_P} + \rho + \epsilon_\rho) + (1 - \pi)\mu_O)\tau_1 W_1}{(1 + \pi)(\mu_P + \epsilon_{\mu_P} + \rho + \epsilon_\rho) + (1 - \pi)\mu_O + \omega_P + \epsilon_{\omega_P}} \\
&= \frac{(\pi(\mu_P + \rho - \epsilon_{\omega_P}) + (1 - \pi)\mu_O)\tau_1 W_1}{(1 + \pi)(\mu_P + \rho - \epsilon_{\omega_P}) + (1 - \pi)\mu_O + \omega_P + \epsilon_{\omega_P}} \\
&= \frac{(\pi(\mu_P + \rho) + (1 - \pi)\mu_O)\tau_1 W_1 - \epsilon_{\omega_P}\pi\tau_1 W_1}{(1 + \pi)(\mu_P + \rho) + (1 - \pi)\mu_O + \omega_P - \epsilon_{\omega_P}\pi}
\end{aligned} \tag{45}$$

Assign expressions of numerator and denominator as follows for simpler algebra: $a := \pi(\mu_P + \epsilon_{\mu_P} + \rho + \epsilon_\rho) + (1 - \pi)\mu_O$ and $b := (1 + \pi)(\mu_P + \rho) + (1 - \pi)\mu_O + \omega_P$. Then $\partial F^*/\partial \mu_P \iff \tilde{F}^* - F^* > 0$.

$$\begin{aligned}
\tilde{F}^* - F^* &= \frac{a - \epsilon_{\omega_P}\pi\tau_1 W_1}{b - \epsilon_{\omega_P}\pi} - \frac{a}{b} \\
&= \frac{ab - b\epsilon_{\omega_P}\pi\tau_1 W_1 - ab - a\epsilon_{\omega_P}\pi}{b(b - \epsilon_{\omega_P}\pi)} \\
&= \frac{-\epsilon_{\omega_P}\pi(a + b\tau_1 W_1)}{b(b - \epsilon_{\omega_P}\pi)}
\end{aligned} \tag{46}$$

Note that $a, b > 0$ by definition of the variable domains. Then $\tilde{F}^* - F^* > 0$ if $\epsilon_{\omega_P} < 0$, which is fulfilled by definition of ϵ_{ω_P} .

□

B Datasets

B.1 Tone of the IMF communication

The assessment of the tone of the IMF communication proceeded in the following steps:

- Scraping the news
- Pre-processing of the news
- Manually labeling the training and the test sets
- Compiling and pre-processing of the text corpus
- Algorithm selection
- Parametrization
- Final classification

B.1.1 Scraping the news

The sample of news regarding the IMF/Ukraine communication was collected from the website of Reuters.com. The paper decided to use the news provider instead of the official IMF website as the IMF website does not provide all statements spoken by the IMF officials in the public or comments on the progress of negotiations between the government and the IMF. Reuters.com was selected as the only source of news. Using a web-scraping tool, the author collected all news reported by the search engine of Reuters.com from January 5th, 2015 to July 21st, 2019, which featured words ‘Ukraine’ and ‘IMF’ in the text, heading, or description. The collected sample contained 1160 articles.

B.1.2 Pre-processing of the news

Prior to classification, the composition of articles was adjusted. The author dropped articles with missing texts, opinion columns, articles published with the same

time-date (minute precision) or title, and news of a ‘Diary’ section, which report *schedules* of future – as of reporting date – public announcements of the government/NGO officials. The ‘clean’ version of the text corpus reduced to 798 articles.

B.1.3 Manually labelling the training and the test sets

The tone of 331 articles was assessed manually using the following scheme: –1 for a ‘negative’ tone, 0 for a ‘neutral’ tone, and 1 for a ‘positive’ one.²⁴

The guiding principle of the classification was to assess whether or not a certain event increases/decreases the chance of the next IMF tranche to the government of Ukraine. For the purposes of the study, the methodology considered an ‘event’ to be a public statement of the IMF officials on Ukraine, news regarding governmental decisions/negotiations, progress in passing parliamentary bills tied to the IMF loan program, and decisions of the National Bank of Ukraine based on its expectations of the IMF reform evaluation.

Since the tone of the IMF statements was often too diplomatic to assess the real opinion of the organization, the tone assignment also considered, whether the context of the event implied negative or positive consequences for the IMF loan disbursement given the IMF stance on reform agenda.

Manual classification was guided by the following principles:

1. The direct comments of the IMF *with respect to an event reported in the news* receive the top priority and are evaluated first. The IMF comments, which are supplied to the news to provide general context do not count at this stage.
2. If no explicit statement is available, one should evaluate whether the IMF – given its declared position and vision of Ukrainian reforms – would take a negative, positive or neutral stance with respect to an event. For instance, a news stating the Prime-Minister of Ukraine announces to set an upper bound on the retail gas prices is in direct contradiction with the IMF requirements to use market pricing on the retail gas market. Even if the news

²⁴The author thanks Maria Klochikhina for a careful research assistance.

might not mention a direct dissatisfaction of the IMF, the context strongly suggests to classify it with as a negative event.

3. The evaluating person should pay attention to the so-called 'empty' statements: the IMF comments that reiterates only the continuation of the program or communication with the government officials without giving explicit critique or praise to the government efforts. Empty comments should be disregarded in tone assessments.

In case the direct statements contradicted with the context-implied reaction of the IMF, the evaluating person made a discretionary choice based on his/her understanding of the context. The example below demonstrates the application of the principles in practice.

Example News

Title: Ukraine anti-corruption court law needs amending: IMF chief

Published: June 19, 2018 / 8:26 PM

KIEV (Reuters) - The head of the International Monetary Fund welcomed on Tuesday the adoption by Ukraine's parliament of a law to create an anti-corruption court, but said lawmakers needed to amend it to guarantee the court's effectiveness.

Creating an independent and trustworthy court dedicated to handling corruption cases is one of the key conditions for Ukraine to receive further funding under its \$17.5 billion aid-for-reforms program from the IMF.

Earlier in June, parliament passed the law after months of delay, but the draft contained an amendment that activists said would undermine the reform by allowing appeals on existing cases to be handled by the current courts system.

News continued

In the Fund's first direct comments on the law, Lagarde said she had spoken with President Petro Poroshenko and said she was encouraged by the adoption of the legislation.

"We agreed that it is now important for parliament to quickly approve... the necessary amendments to restore the requirement that the HACC (anti-corruption court) will adjudicate all cases under its jurisdiction," she said in a statement.

The law is meant to ring-fence court decisions from political pressure or bribery in Ukraine, where entrenched corruption remains a deterrent to foreign investors and knocks two percentage points off Ukraine's economic growth each year, according to the IMF.

Establishing the court, adjusting gas prices and honoring budget commitments are key conditions to unlock the next loan tranche under the IMF program, which expires next year.

Lagarde said she and Poroshenko had "also agreed to work closely together, including with the government, toward the timely implementation of this and other actions, notably related to gas prices and the budget."

Source: Prentice (2018)

Below one finds an example of how the author classifies this news into "positive", "negative", and "empty" statements. The bold emphasis shows which parts of the statements serve as a basis for a particular assessment.

Empty statements

§8: "**Lagarde said she and Poroshenko** had "also **agreed to work closely together**, including with the government, toward the timely implementation of this and other actions, notably related to gas prices and the budget."

Comment: The statement means that the loan program continues and both sides are going to stay in contact with each other on a regular basis. This is a mere

“let’s stay in touch” statement.

Positive statements

§1: "The **head of the International Monetary Fund welcomed** on Tuesday **the adoption** by Ukraine’s parliament **of a law** to create an anti-corruption court..."

§4: "In the Fund’s first direct comments on the law, **Lagarde said** she had spoken with President Petro Poroshenko and said **she was encouraged by the adoption** of the legislation."

Comment: Direct approval of actions by the Fund.

Negative statements

§1: "**The head of the International Monetary Fund** welcomed on Tuesday the adoption by Ukraine’s parliament of a law to create an anti-corruption court, but **said lawmakers needed to amend it to guarantee the court’s effectiveness.**"

§4: "“We agreed that **it is now important** for parliament **to quickly approve ... the necessary amendments** to restore the requirement that the HACC (anti-corruption court) will adjudicate all cases under its jurisdiction,” **she said in a statement.**"

§3: "Earlier in June, parliament passed the law after months of delay, but **the draft contained an amendment that activists said would undermine the reform** by allowing appeals on existing cases to be handled by the current courts system."

Comment: The IMF is dissatisfied with the current version of the law and fears that holes in its formulation would allow parties with vested interests reducing its effective application.

Conclusion

The IMF statements are ambiguous. They support the law in general, but believe that amendments are crucial for its effectiveness. Thus, the generally posi-

tive message is balanced by a number of qualifications leading to a neutral sentiment.

Tone: 0, ‘neutral’.

Despite using context-related information to resolve the ambiguity of the IMF statements, the majority of the news were still evaluated as ‘neutral’. As Table 9 shows, 60% of the sample got a neutral score.

Table 9: Distribution of assigned tones to Reuters.com articles.

Negative	Neutral	Positive
58	198	75

Own calculation.

B.1.4 Pre-processing of the text corpus

Before training and testing the classification algorithms, the text corpus is modified with techniques, which are commonly used in natural language processing to improve accuracy of machine-based classification (Bird et al., 2009). The author removed punctuation, deleted stop words²⁵ using the NLTK corpus, lemmatized remaining words²⁶ and assigned part of speech tags to each word using the NLTK part of speech ‘tagger’.²⁷ Additionally the author applied the N-gram transformation up to 4 words.²⁸

²⁵Stop words are words that typically do not help to define the content of the text and carry purely grammatical functions like articles and modal verbs.

²⁶Lemmatization is a process of bringing the inflectional words – words, which are modified to express grammatical categories like gender, tense, or case – to the same base. The base may be the root of the word but this is not always the case if the degree of inflection is high. For instance, lemmatization of the word ‘marching’ yield ‘march’, whereas lemmatizing the word ‘better’ yields ‘good’, since the ‘better’ is a comparative form of the adjective ‘good’.

²⁷NLTK stands for Natural Language Toolkit: a Python library that provides tools for natural language processing. See Bird et al. (2009) for a practical introduction.

²⁸That is, the algorithm transforms each news into a vector, where each element consists of N words contiguous to each other in the original text. For instance, applying N-gram transformation of degree 1 on the title of the paper: ‘Marching to good laws’ yields a vector (*Marching, to, good, laws*). The 2-gram transformation yields the following vector (*Marching to, to good, good laws*). The 3-gram transformation yields (*Marching to good, to good laws*) and the 4-gram transformation produces the title itself.

B.1.5 Algorithm selection

The author did not have any prior regarding the efficiency of algorithms for the objective at hand. Initially, the author considered 6 classification algorithms: support vector machines, multinomial Naïve Bayes, k-nearest neighbors, regression decision tree, random forest, and AdaBoost. To assess their comparative performance, the author has compared accuracy – the ratio of correctly classified text to all texts – produced by each algorithm for 1000 different rounds.

In each round the algorithms were first calibrated on a training set – a subset of the manually classified set. After that, the algorithm was run to predict tone of the news in the test sample. The ratio of correct classification to the total number of news – accuracy – was stored and a new round with a different test-train random split was run. The procedure was reiterated 1000 using random training-test sample splits times to approximate the whole distribution of the classification performance of the algorithms.

For the majority of the algorithms, the author applied ‘default’ parameters of the `scikit-learn` Python library v.0.21.3 (Pedregosa et al., 2011). Exceptions were Naïve Bayes with manually set ‘alpha-parameter’ equal to 0.1, the k-nearest neighbors with the number of neighbors equal 50, and the support vector machines run with a ‘linear’ kernel and automatically defined ‘gamma’ value. See [Scikit-learn.org](https://scikit-learn.org) (2019) for the set of libraries’ default parameters.

Each simulation was run twice. First, using a simple count vectorized sample and with a TFIDF vectorized sample thereafter.²⁹

Figures 7 and 8 show results of 1000 different training-test splits. Two results stand out. First, the median classification of the TFIDF-weighted features is generally more accurate than for the simple count-vectorized features. Second, the median accuracy for the TFIDF-features does not differ significantly across the most of the algorithms, which is close to 0.6 for 4 algorithms out of 6.

The author decided to proceed with the Naïve Bayes classification method for

²⁹Count vectorization calculates occurrence of each single feature – a word or an N-gram – in a text. TFIDF stands for ‘term frequency – inverse distance frequency’: a metric that adjust occurrence of each single feature in the text by the inverse of how frequently the feature appears in other texts of the corpus.

Figure 7: Accuracy of the classification algorithms: count-vectorized sample.

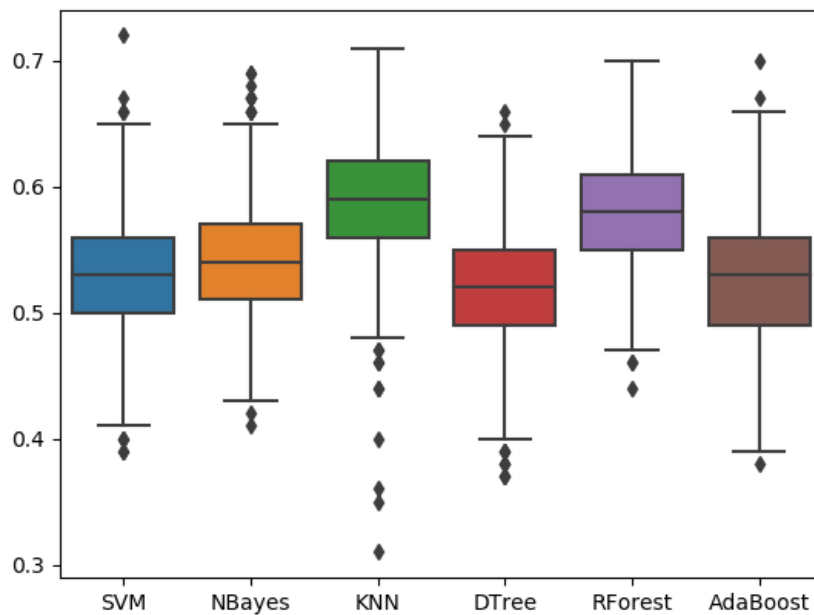

Sources: Based on news by Reuters.com (2020).

Figure 8: Accuracy of the classification algorithms: TFIDF-sample.

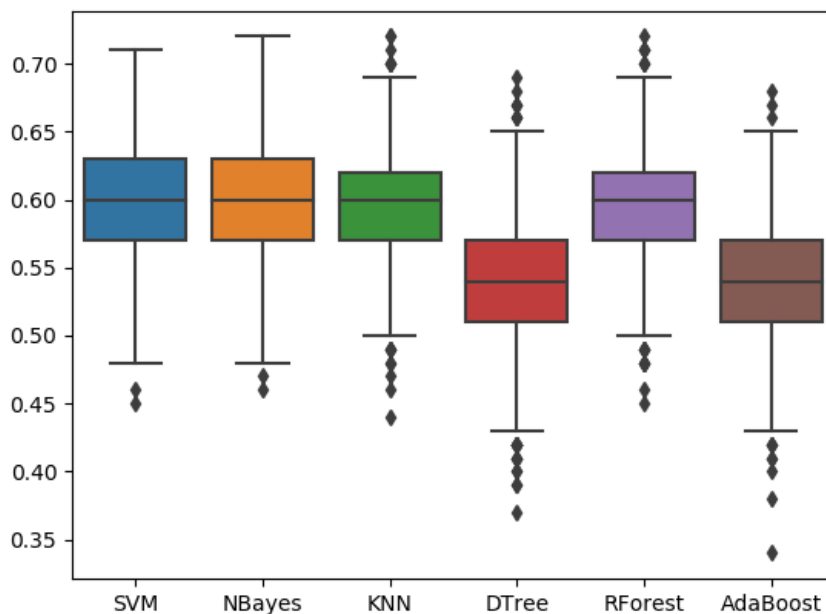

Sources: Based on news by Reuters.com (2020).

further parametrization. This method is widely used in classification problems and is known for its robust performance in both small- and large datasets (Juraf-

sky and Martin, 2000).

The method is based on numerator of the Bayes Formula, which is a multiple of the prior conditional probability of a feature x_i – typically a word or an N-gram – given a category c and a likelihood of a class $P(c)$.

The program of the Naïve Bayes algorithm is defined as follows:

$$\arg \max_{c \in C} P(x_1, x_2, \dots, x_n | c) P(c) \quad (47)$$

Without independence assumption, estimating $P(x_1, x_2, \dots, x_n | c)$ precisely would require a large amount of data. For this reason, one often assumes independence of features between conditional on a class.⁵⁰

$$P(x_1, x_2, \dots, x_n | c) = P(x_1 | c) \cdot P(x_2 | c) \cdot \dots \cdot P(x_n | c)$$

The conditional probability $P(x_i | c)$ is defined as a Laplace-smoothed ratio of $n_{i,k}$ – TFIDF-weighted frequencies of a feature x_i in a text k – over n_k – the sum of TFIDF-weighted features of all x_i in k .

$$P(x_i | c) = \frac{n_{i,k} + \alpha}{n_k + \alpha N} \quad (48)$$

Where N is the total number of unique words across all texts. The parameter $\alpha \in (0, 1]$ is the term introduced by the Laplace smoothing. It allows estimating the conditional probability of a feature x_i even if the feature was not present in a text k such that $n_{i,k} = 0$. The particular value of α has to be decided by the modeller.

B.1.6 Parametrization

Since the author had no prior on α , he tested the accuracy of the the Naïve Bayes algorithm for each $\alpha \in \{0, 0.1, 0.2, \dots, 0.9, 1.0\}$ and selected the one, which pro-

⁵⁰This assumption is the reason of why the method is called ‘naïve’: this assumption is unlikely to hold in reality.

vides the best accuracy.⁵¹ Figures 9 and 10 show the results of 1000 random test-

Figure 9: Accuracy of Naïve Bayes classifier: count-vectorized sample.

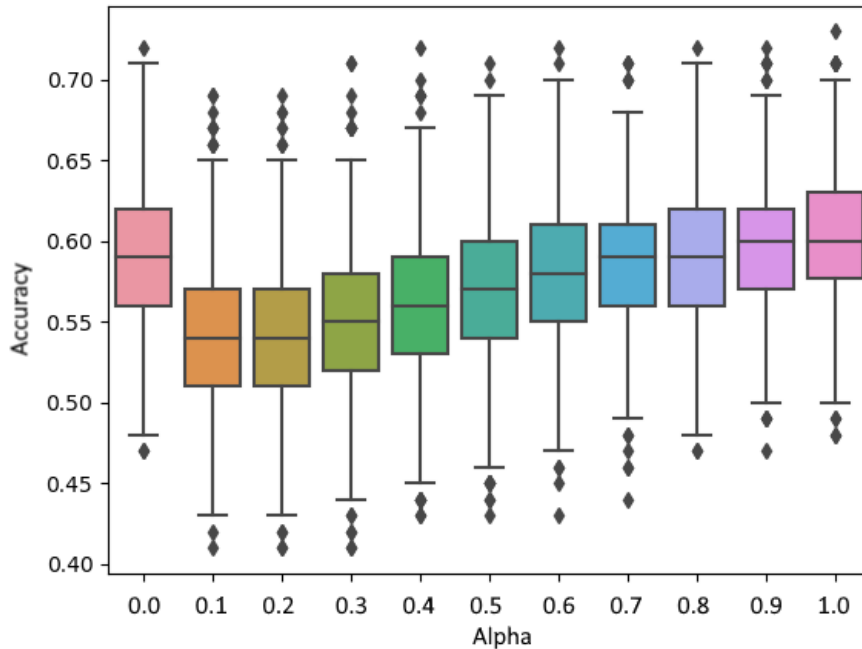

Sources: Based on news by Reuters.com (2020).

train sample splits for each of the α values for the count-vectorized and TFIDF-weighted features. Based on these results, the author decided to go for the TFIDF-weighted features with $\alpha = 0.1$.

B.2 Final classification

The manually selected seed test-train sample split provided accuracy of 0.71. After that the author calculated the average tone of the articles by each month. If no news appeared in certain month, the author assumed neutral tone with a score 0. Figure 11 shows the final time series used in the dataset.

The first year of the IMF program confirms mildly positive relations between the government and the IMF that followed the first loan tranche and successful negotiations with private bondholders on bond coupon cuts in 2015. The subsequent communication was, however, largely mixed due to mediocre progress in

⁵¹The first element of the set is closest number to zero allowed by scikit learn library for the multinomial Naïve Bayes.

Figure 10: Accuracy of Naïve Bayes classifier: TFIDF-sample.

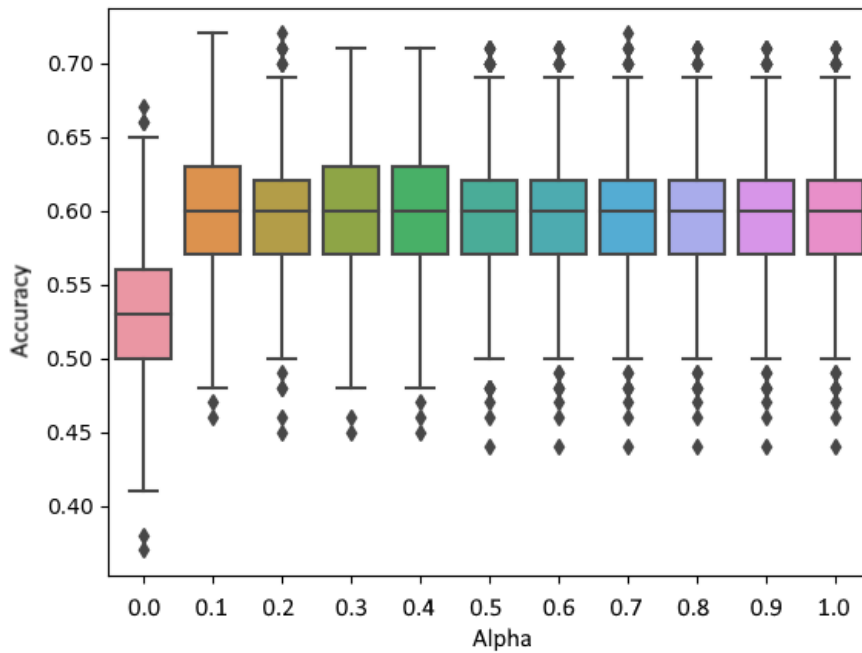

Sources: Based on news by Reuters.com (2020).

Figure 11: Estimated tone of the IMF communication

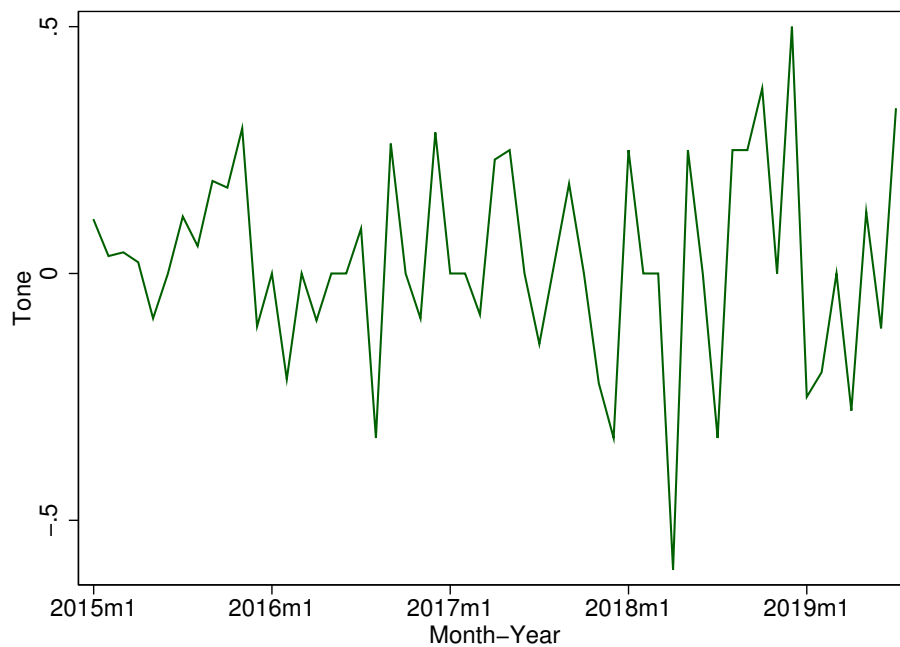

Sources: Based on news by Reuters.com (2020).

adopting the anti-corruption laws in 2016-2018, government backsliding on the gas price policy, and political uncertainty of 2019.

B.3 Measures of electoral competition

To proxy the strength of political competition, the author used results of public polls on electoral popularity of the Ukrainian political parties aggregated by Ukraine-elections (2019). Ukraine-elections.com is a web-aggregator that collects data of the publicly-published survey results on political topics in Ukraine. Apart from the results, the website provides information on the survey-organization, number of participants in the survey, time-period when the survey was conducted, and the source link.

The author collected all results that measured electoral ratings of political parties from 2015 to July 2019. Typically, the political preferences were revealed by an answer to the following question: "If there would be parliamentary elections next week, which party would you vote for?" [‘Якби вибори до Верховної Ради України відбулися найближчої неділі, за яку політичну партію Ви б проголосували?’].

The market of conducting political polls in Ukraine is diverse and features both established sociological institutions and marketing agencies. Yet none of the organizations consistently provides monthly surveys based on identical methodology and a sample size. Some organizations are long-term players on the market with a greater focus on ‘sociology of Ukraine’, whereas the others present marketing agencies, which work ad-hoc close to elections. In certain cases, polls are conducted by survey-organizations together. Therefore, aggregating results of all survey results runs into risk of producing estimates based on incomparable results.

The author addressed the issue in two ways. First, he deleted all polls conducted by those organizations, which provided less than 9 survey results from March 2015 to April 2019 – assuming on average at least 1 survey each 6 months.³² This reduced the list of organizations from 40 to 10.

Second, to account for differences in survey-methodologies and sampling strategies across the organizations the author estimated a dummy-variable regression,

³²Based on the sampling period, not the publication date of the survey.

Table 10: Distribution of poll results done by survey-organizations

Organization	Number of polls
'Sociological Group 'Rating''	43
Kyiv International Institute of Sociology	25
'Social Monitoring Center'	25
Centre for Social Studies 'SOFIA'	22
Ukrainian Institute for Social Studies	20
Razumkov Centre	19
Institute for Analysis and Forecasting	18
'Center for Social Forecast and Marketing'	11
'SOCIS'	10
The Belgium-Ukraine Research Institute	9

Source: Calculated by the author based on Ukraine-elections (2019).

where the popularity of each party depends on a set of dummy variables representing a survey organization.

$$p_{i,j,t,d} = \alpha + \sum_{d=2}^{N_d} \beta_d \times d_i + \varepsilon_{i,t,d} \quad (49)$$

Where $d_i \in D$: D is an ordered set of all survey-companies; N_d is the number of elements in D , $p_{i,j}$ is the share of people willing to vote for a party j according to a survey i ; α, β_d are the parameter values, and $\varepsilon_{i,t,d,p}$ is an identically independently distributed error-term.

After estimating the regression, the author removed all variation explained by the individual characteristics of the survey-organizations by calculating the residuals of the popularity of each party.

$$\tilde{p}_{i,j,t,d} = p_{i,j,t,d} - \hat{p}_{i,j,t,d} \quad (50)$$

Where $p_{i,\hat{j},t,d}$ is the predicted value of the OLS model estimated by Equation 49. After removing the variation attributable to a particular survey company, the paper calculates the final popularity score:

$$P_{j,t} = \text{median}(\tilde{\mathbf{p}}_{j,t}) \quad (51)$$

Where $\mathbf{p}_{j,t}$ is an ordered set $(\tilde{p}_{1,j,t}, \tilde{p}_{2,j,t}, \dots, \tilde{p}_{n,j,t})$ of popularity scores reported by each single survey-organization in a month t for a party j .

Based on that, the author calculated the ‘absolute popularity’ $P_{a,t}$ and the ‘popularity gap’ $P_{g,t}$. $P_{a,t}$ is defined as the popularity score of the major ruling party ‘Petro Poroshenko Bloc’ ($P_{PPB,t}$).³⁵ The popularity gap is the difference between the absolute popularity of the ‘Petro Poroshenko Bloc’ and the highest popular alternative party P^a . That is, $P_{g,t} = P_{a,t} - \max \{P_{1,t}^a, P_{2,t}^a, \dots, P_{n,t}^a\}$ Figure

Figure 12: Measures of electoral competition

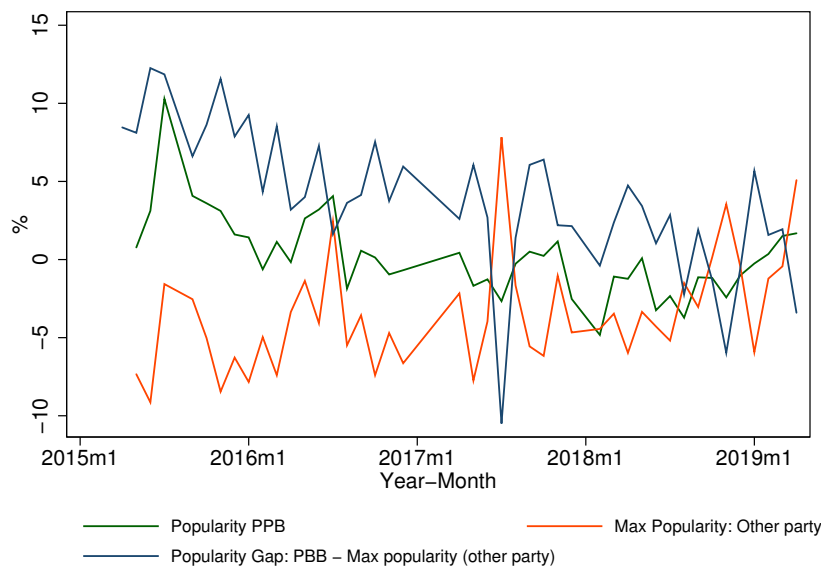

Sources: Based on Ukraine-elections (2019).

12 shows the final time series of the popularity measures used in the dataset. It reveals a general pattern of declining support of the major ruling party – ‘Petro Poroshenko Bloc’ – over time, which became especially strong in 2019, after Volodymyr Zelensky announced his participation in the presidential elections.

³⁵The dominant parties in the coalition were ‘Petro Poroshenko Bloc’ and ‘People’s Front’. Yet despite of initially strong results during the parliamentary elections, the popularity of the ‘People’s Front’ reduced to around 4% by January 2015 according to the polls. After the resignation of its leader – Arseniy Yatsenyuk – from the position of a Prime-Minister, the party – became a non-significant player in the Ukraine-wide electoral politics. The author, therefore, accounts for the rating only of the major ruling party – Petro Poroshenko Bloc –, which was able to pass the 5% barrier in the 2019 Parliamentary elections as well.

C Tables

Table 11: Summary statistics: Deseasoned variables in levels.

	Mean	St. deviation	N
Reform Index: Total	0.14	15.73	50
Reform Index: Public Finance	-0.03	3.32	50
UAF Fatalities	-27.22	41.58	50
Log(Real wage)	-0.00	0.16	50
Popularity: Gap	1.22	4.73	50
Popularity: PPB	0.06	2.62	50
IMF tone	-0.00	0.19	50

Sources: "All reforms" uses a sum of evaluations for all laws passed in the Ukrainian parliament; "Public finance" uses a sum of evaluations for all laws contributing to the 'public finance' dimension only. Reform index composed by VoxUkraine (2020); fatalities as reported by Memory-book.org.ua (2020); IMF tone classified by author; real wage as reported by Ukrstat (2019); 'Popularity: PPB' is a share of surveyed supporting the ruling party 'Petro Poroshenko Bloc' and 'Popularity: Gap' is the difference between 'Popularity: PPB' and share of surveyed supporting most popular alternative party – both popularity measures calculated as in Annex B based on Ukraine-elections (2019).

IMPRESSUM

Herausgeber, Verleger, Eigentümer und Hersteller:

Verein „Wiener Institut für Internationale Wirtschaftsvergleiche“ (wiiw),
Wien 6, Rahlgasse 3

ZVR-Zahl: 329995655

Postanschrift: A 1060 Wien, Rahlgasse 3, Tel: [+431] 533 66 10, Telefax: [+431] 533 66 10 50
Internet Homepage: www.wiiw.ac.at

Nachdruck nur auszugsweise und mit genauer Quellenangabe gestattet.

Offenlegung nach § 25 Mediengesetz: Medieninhaber (Verleger): Verein "Wiener Institut für Internationale Wirtschaftsvergleiche", A 1060 Wien, Rahlgasse 3. Vereinszweck: Analyse der wirtschaftlichen Entwicklung der zentral- und osteuropäischen Länder sowie anderer Transformationswirtschaften sowohl mittels empirischer als auch theoretischer Studien und ihre Veröffentlichung; Erbringung von Beratungsleistungen für Regierungs- und Verwaltungsstellen, Firmen und Institutionen.

