

Böhringer, Christoph; Lange, Andreas

Working Paper

Efficiency, Compensation, and Discrimination: What is at Stake When Implementing the EU Emissions Trading Scheme?

ZEW Discussion Papers, No. 03-73

Provided in Cooperation with:

ZEW - Leibniz Centre for European Economic Research

Suggested Citation: Böhringer, Christoph; Lange, Andreas (2003) : Efficiency, Compensation, and Discrimination: What is at Stake When Implementing the EU Emissions Trading Scheme?, ZEW Discussion Papers, No. 03-73, Zentrum für Europäische Wirtschaftsforschung (ZEW), Mannheim

This Version is available at:

<https://hdl.handle.net/10419/24023>

Standard-Nutzungsbedingungen:

Die Dokumente auf EconStor dürfen zu eigenen wissenschaftlichen Zwecken und zum Privatgebrauch gespeichert und kopiert werden.

Sie dürfen die Dokumente nicht für öffentliche oder kommerzielle Zwecke vervielfältigen, öffentlich ausstellen, öffentlich zugänglich machen, vertreiben oder anderweitig nutzen.

Sofern die Verfasser die Dokumente unter Open-Content-Lizenzen (insbesondere CC-Lizenzen) zur Verfügung gestellt haben sollten, gelten abweichend von diesen Nutzungsbedingungen die in der dort genannten Lizenz gewährten Nutzungsrechte.

Terms of use:

Documents in EconStor may be saved and copied for your personal and scholarly purposes.

You are not to copy documents for public or commercial purposes, to exhibit the documents publicly, to make them publicly available on the internet, or to distribute or otherwise use the documents in public.

If the documents have been made available under an Open Content Licence (especially Creative Commons Licences), you may exercise further usage rights as specified in the indicated licence.

Discussion Paper No. 03-73

**Efficiency, Compensation,
and Discrimination:
What is at Stake When Implementing
the EU Emissions Trading Scheme?**

Christoph Böhringer and Andreas Lange

ZEW

Zentrum für Europäische
Wirtschaftsforschung GmbH

Centre for European
Economic Research

Discussion Paper No. 03-73

**Efficiency, Compensation,
and Discrimination:
What is at Stake When Implementing
the EU Emissions Trading Scheme?**

Christoph Böhringer and Andreas Lange

Download this ZEW Discussion Paper from our ftp server:

<ftp://ftp.zew.de/pub/zew-docs/dp/dp0373.pdf>

Die Discussion Papers dienen einer möglichst schnellen Verbreitung von neueren Forschungsarbeiten des ZEW. Die Beiträge liegen in alleiniger Verantwortung der Autoren und stellen nicht notwendigerweise die Meinung des ZEW dar.

Discussion Papers are intended to make results of ZEW research promptly available to other economists in order to encourage discussion and suggestions for revisions. The authors are solely responsible for the contents which do not necessarily represent the opinion of the ZEW.

Nontechnical Summary

In 2005, an EU-wide emissions trading scheme covering major CO₂ producing sites shall come into power. The key objective of the trading scheme is to promote cost-efficiency of carbon reduction under the EU burden sharing agreement that includes country-specific commitments for emission abatement.

Prior to enactment, each EU member state must develop a National Allocation Plan that defines the overall cap on carbon emissions for installations included in the trading scheme and prescribes the specific allocation rule of free allowances. Since there is no supranational law for strict harmonization, major concerns persist that the implicit transfers to firms via individual National Allocation Plans could lead to state aid and distort competition across energy-intensive firms that are covered by the trading scheme.

In this paper, we identify policy-relevant tradeoffs between overall efficiency, compensation and competitive neutrality which arise in the concrete implementation of the EU emissions trading scheme through National Allocation Plans.

Using a simple partial equilibrium framework, we show that - under the burden sharing agreement - emission allocation factors to identical firms will generally differ across countries when EU member states adopt the same rules for determining and distributing the emissions allocation budget. In order to harmonize allocation factors and preserve competitive neutrality, country-specific adjustments of the (initial) emissions allocation budgets for trading energy-intensive firms are necessary.

Based on numerical general equilibrium analysis for the EU, we substantiate the qualitative insights of the stylized partial equilibrium assessment with policy-relevant quantitative information. In our simulations, we find that the (output-based) allocation of free allowances to identical firms can vary by a factor of 5, when Member States have determined emissions caps for the emissions trading sectors under overall efficiency considerations in first place. Adjustments of the emissions caps to preserve uniform allocation factors induces substantial welfare implications at the single country-level: Depending on the magnitude and direction of the adjustment in emission allowances, a country may significantly lose or gain from harmonization of the allocation factor.

Efficiency, compensation, and discrimination:

What is at stake when implementing the EU emissions trading scheme?

Christoph Böhringer and Andreas Lange

boehring@zew.de, lange@zew.de

Centre for European Economic Research (ZEW), Mannheim

P.O. Box 10 34 43

D-68034 Mannheim, Germany

Abstract: In 2005, an EU-wide emissions trading scheme covering major CO₂ producing sites shall come into power. The key objective of the trading scheme is to promote cost-efficiency of carbon reduction within the EU. We identify policy-relevant tradeoffs between overall efficiency, compensation and competitive neutrality which arise in the concrete implementation of the EU emissions trading scheme through National Allocation Plans.

JEL classification: D58, H21, H23

Keywords: emissions trading, allowance allocation, competition, National Allocation Plans, computable general equilibrium

1. Introduction

In May 2002, the European Union (EU) ratified the Kyoto Protocol under which the EU as a whole is committed to reducing its greenhouse gas emissions by 8 % vis-à-vis 1990 emission levels during 2008-2012 (UNFCCC 1997). The aggregate EU reduction requirement has been redistributed among individual Member States according to an EU-internal burden sharing agreement (EU 1999).

Prior to the ratification, the European Commission launched a Directive for a pan-European carbon trading system (EU 2001). The key objective of the Directive is to meet the EU reduction commitments under the Kyoto Protocol more cost-effectively than by purely domestic action of individual Member States. The Directive for an EU emissions trading scheme was approved by the European Parliament in July 2003 and is scheduled to become legally binding by January 2005 (EU 2003). The envisaged trading scheme consists of several temporal stages: a first phase from 2005 until 2007, a second one from 2008 until 2012, coinciding with the Kyoto commitment period, and subsequent five-year-periods covering potential Post-Kyoto commitment periods. With respect to participation and coverage, the trading system applies to energy-intensive (downstream) sectors that include all major CO₂ producing sites such as power, heat and steam generation, oil refineries, coke ovens in iron and steel production, mineral industries (e.g. glass, cement) or pulp and paper plants.

According to Article 9 of the Directive, all individual Member States must develop a National Allocation Plan (NAP) until March 2004 that (i) fixes an overall cap on carbon emissions for installations included in the trading scheme, and (ii) prescribes the specific allocation rule of free allowances.¹ Since there is no supranational law for strict harmonization, major concerns persist that the implicit transfers to firms via individual National Allocation Plans could lead to state aid and distort competition across firms that are covered by the Directive.²

In this paper, we investigate potential tradeoffs between efficiency, compensation and discrimination (of firms) that are at stake in implementing the EU Directive. Based on simulations with a large-scale computable general equilibrium model for the EU (see Böhringer 2001 for a precursor model version), we find that:

- EU emissions trading between energy-intensive industries can reduce total costs of meeting the Kyoto target by roughly a third compared to purely domestic action. Yet, because of terms-of-trade effects, emissions trading need not be beneficial for all EU Member States.

¹ Member States must allocate 95% of emission allowances for free until 2007 and can auction at most 10 percent of the allowances in the period 2008-2012 (Article 10, EU 2003). Note that the implementation of the EU emissions trading Directive is not conditioned on entering into force of the Kyoto Protocol (which – to date – still requires ratification by Russia).

² Prevention of competitive distortions is one of the “common criteria” listed in Annex 3 of the Directive for the approval of a national allocation plan. The National Allocation Plans will be scrutinized by the Commission and can be rejected, if common criteria are violated.

- The potential efficiency gains from emissions trading will only materialize if allowances are allocated in a non-distortionary (lump-sum) way to energy-intensive installations covered by the Directive. For dynamic allocation rules where the assignment of emission allowances depends on endogenous output decisions of firms, the implied distortions will nearly offset all efficiency gains. On the other hand, such compensating transfers strongly attenuate the adverse production and employment impacts of carbon emission constraints on politically influential energy-intensive industries.
- In the design of National Allocation Plans, the burden sharing agreement implies differences in allocation schemes across countries. Whenever countries adopt the same rules for determining and distributing the emissions budget to Directive sectors, the allocation factor of allowances to firms with identical characteristics will differ across regions. In our quantitative simulations, the output-based assignment of free allowances to identical firms can vary by a factor of 5, when Member States have determined emission caps under overall efficiency considerations in first place.
- Harmonization of allocation factors requires country-specific adjustments in the partitioning of a country's Kyoto emissions budget between Directive sectors and Non-Directive sectors (away from initial least-cost allocation). While these adjustments are negligible with respect to aggregate EU economic impacts, the implications at the single country level can be substantial. Depending on the magnitude and direction of the shift in emission rights between Directive and Non-Directive sectors, a country may lose or gain from harmonization of the allocation factor.

The potential economic impacts of EU-type emissions trading schemes have been studied more recently in several papers using stylized analytical approaches (see e.g. Böhringer and Lange 2003a) or large-scale numerical models (see e.g. Capros and Mantzos 2000, Böhringer 2002, Böhringer and Lange 2003b). Key findings such as the magnitude of efficiency gains from emissions trading and the potential distortions of dynamic allocation rules coincide with some of our results. However, none of the previous studies, has investigated the pending tradeoffs between efficiency, compensation and discrimination associated with the concrete design of National Allocation Plans to implement the EU Directive in practice. To our knowledge, the present analysis is the first that substantiates the controversial policy debate on the obligatory development of National Allocation Plans with concrete quantitative insights.

The remainder of this paper is organized as follows. In section 2, we use a stylized partial equilibrium analysis to illustrate the tradeoffs between efficiency, compensation and discrimination in the design of National Allocation Plans. In section 3, we present a brief non-technical summary of the numerical general equilibrium framework in use for the quantification of the potential economic impacts associated with the implementation of the EU Directive. In section 4, we specify alternative policy scenarios and interpret simulation results. In Section 5, we provide some final remarks.

2. Stylized Partial Equilibrium Analysis

In this section, we set up a simple partial model to capture central aspects of the design of National Allocation Plans. We illustrate the economic implications of decision rules concerning (i) the partitioning of a region's overall emission budget between the emissions trading sector and the non-trading sector, and (ii) the allocation of free allowances to the trading sector.

Each region r is represented by a two-sector economy, comprising the non-trading sector and the sector captured by the trading scheme.³ A region r can partition its emissions budget $\overline{CO2}^r$ under the burden sharing agreement between the trading and the non-trading sector. Across all sectors and regions emissions are limited by the total of $\sum_r \overline{CO2}^r$.

In each region r , the non-trading sector N is represented by an abatement cost function $c^{Nr}(e^{Nr})$ (differentiable, decreasing, convex). The representative firm in the trading sector T of region r is described by the cost function $c^{Tr}(q^{Tr}, e^{Tr})$ (differentiable, increasing in q , decreasing in e , convex), where q^{Tr} denotes the output and e^{Tr} the emissions level; the representative firm sells output at an exogenously given price p . In the exposition below, c_q and c_e denote the partial derivatives of the cost function with respect to q ($\partial c / \partial q$) and e ($\partial c / \partial e$).

2.1. Social Optimum

The optimal output and emissions levels within our stylized framework imply (i) equalization of marginal abatement costs across sectors (as well as regions for the case of international emissions trading), and (ii) equalization of marginal production costs and the output price. The optimal levels are given by:

$$\begin{aligned} p &= c_q^{Tr}(q^{Tr}, e^{Tr}) \\ -c_e^{Nr}(e^{Nr}) &= -c_e^{Tr}(q^{Tr}, e^{Tr}) \end{aligned} \tag{1}$$

Without international emissions trading, i.e. $e^{Nr} + e^{Tr} = \overline{CO2}^r$, marginal abatement costs generally differ across regions. Emissions trading provides efficiency gains through the equalization of marginal abatement costs across regions. The uniform emissions price σ is then endogenously determined by (1) and the overall emissions constraint $\sum_r [e^{Nr} + e^{Tr}] = \sum_r \overline{CO2}^r$. In the following, we denote the resulting optimal output and emissions levels by $(q^{Tr*}, e^{Tr*}, e^{Nr*})_r$.

³ Generalization to more than 2 sectors is straightforward but does not yield any additional insights.

2.2. Decentralization through National Allocation Plans

At the decentralized level of National Allocation Plan, each country has to specify the targeted emissions $\overline{CO2}^{Nr}$ in the non-trading sector and the allocation rule for the remaining emission allowances ($\overline{CO2}^{Tr} = \overline{CO2}^r - \overline{CO2}^{Nr}$) to installations in the trading sector. Reflecting overall efficiency objectives, we assume that each country chooses its emissions in the non-trading sectors at the optimal level, i.e. $\overline{CO2}^{Nr} = e^{Nr*}$. The remaining emissions budget $\overline{CO2}^{Tr}$ can then be allocated as emissions allowances to the trading sector. For concreteness, we consider the policy-relevant allocation rule which assigns allowances proportional to output, multiplied by an emissions-performance standard (benchmark) γ :⁴ The firm in region r receives $\lambda^r \gamma q^{Tr}$ allowances where λ^r denotes the region-specific allocation factor.⁵ The allocation rule provides implicit subsidies on output with firm's decisions on output and emissions levels based upon the following equilibrium conditions (the superscript “ D ” denotes the decentralized case):

$$\begin{aligned}
 p + \lambda^r \gamma \sigma^D &= c_q^{Tr}(q^{Tr,D}, e^{Tr,D}) \\
 \sigma^D &= -c_e^{Tr}(q^{Tr,D}, e^{Tr,D}) \\
 \overline{CO2}^{Tr} &= \lambda^r \gamma q^{Tr,D} \\
 \sum_r \overline{CO2}^{Tr} &= \sum_r e^{Tr,D}
 \end{aligned} \tag{2}$$

Note that the allocation factor λ^r is endogenously determined to satisfy the region's allocation constraint $\overline{CO2}^{Tr}$.

Simple comparative-static analysis shows that the implicit output subsidy (or likewise an *effective* increase in the output price) increases production and emission levels for any given positive emissions price σ .⁶ Keeping the allocation constraint $\overline{CO2}^{Tr} = \overline{CO2}^r - e^{Nr*}$ as of (1), the emissions price for the Directive sector under (2) therefore will be higher than optimal whereas the specific emissions (i.e. the emissions per unit of output) must be lower than optimal. Both effects lead to losses in aggregate efficiency.

⁴ Alternatively, allowances could be allocated based on emissions. For a generic comparison of emissions- and output-based rules see Böhringer and Lange (2003b) who highlight the superiority of the output-based rule as a compensating redistributive instrument.

⁵ Note that we investigate the allocation rule in a static setting where the assignment of allowances is proportional to *actual* output levels. This can be interpreted as a condensed representation of a dynamic allocation scheme, where the historical basis of allocation is continuously updated from period to period (e.g. as proposed by AGE 2003).

⁶ Differentiation of the equilibrium conditions lead to $\frac{\partial q^{Tr}}{\partial p} = \frac{c_{ee}^{Tr}}{c_{qq}^{Tr} c_{ee}^{Tr} - c_{qe}^{Tr} c_{qe}^{Tr}} > 0$ and $\frac{\partial e^{Tr}}{\partial p} = -\frac{c_{qe}^{Tr}}{c_{qq}^{Tr} c_{ee}^{Tr} - c_{qe}^{Tr} c_{qe}^{Tr}} > 0$.

For each region r , the allocation factor λ^r is endogenously determined by $\overline{CO2}^{Tr} = \lambda^r \gamma q^{Tr,D}$. Therefore, the allocation rate per unit of output, $\lambda^r \gamma$, will generally differ across regions and, thus, violate competitive neutrality of National Allocation Plans. In order to prevent competitive distortions, a harmonization of allocation factors is required.

2.3. Harmonization of allocation factors

With respect to the harmonization of allocation factors ($\lambda = \lambda^r$), we maintain the aggregate allocation of emissions to the trading sector across all regions at the “optimal” level $\sum_r \overline{CO2}^{Tr} = \sum_r \overline{CO2}^r - e^{Nr,*}$ (see (1)). This leads to the following equilibrium conditions (the superscript “H” denotes the harmonization case):

$$\begin{aligned}
 p + \lambda \gamma \sigma^H &= c_q^{Tr} (q^{Tr,H}, e^{Tr,H}) \\
 \sigma^H &= -c_e^{Tr} (q^{Tr,H}, e^{Tr,H}) \\
 \sum_r \overline{CO2}^{Tr} &= \lambda \gamma \sum_r q^{Tr,H} \\
 \sum_r \overline{CO2}^{Tr} &= \sum_r e^{Tr,H}
 \end{aligned} \tag{3}$$

The impact of assignment factor harmonization on the output and emissions decisions and, therefore, on welfare will vary across regions. *Ceteris paribus*, an increase of λ leads to larger output distortions. This implies a positive (negative) effect on welfare of regions which must decrease (increase) their specific allocation factor λ_r under the harmonization.

The allowance allocation to trading sectors in region r under harmonization, $\lambda \gamma q^{Tr,H}$, will generally differ from the initial allocation $\overline{CO2}^{Tr} = \lambda^r \gamma q^{Tr,D}$. In order to satisfy the burden sharing agreement, i.e. the emissions endowment $\overline{CO2}^r$, each region must adjust the abatement efforts in the non-trading sector to satisfy: $e^{Nr,H} = \overline{CO2}^r - \lambda \gamma q^{Tr,H}$. Compared to the social optimum (1) as well as the decentralized case with non-uniform allocation factors (2), the adjustment of abatement burdens leads to higher or lower abatement costs in the non-trading sector (depending on whether $e^{Nr,H}$ is smaller or larger than $e^{Nr,*}$), hereby inducing efficiency losses. In our simple partial model, the total welfare effect of harmonization for a country is only unambiguous (negative) if the region must increase its specific allocation factor.

2.4. Illustration of the 2-country-case

We illustrate the effects of allocation rules for the case of two regions A and B that differ only with respect to their emissions budget $\overline{CO2}^A > \overline{CO2}^B$ under some burden sharing agreement. Since the cost functions for both countries are identical by assumption, optimal emission and output levels ($e^{N^*} = e^{Nr^*}$, $e^{T^*} = e^{Tr^*}$, and $q^{T^*} = q^{Tr^*}$) must be identical.

In Figure 1, $q(e, \lambda)$ denotes the solution to the equilibrium condition $p - \lambda \gamma c_e^T(q(e, \lambda), e) = c_q^{Tr}(q(e, \lambda), e)$. For $\lambda = 0$, this renders the optimal output choice as a function of the emissions level. Note that $q(e, \lambda)$ is increasing in λ . Therefore, $q(e, \lambda^A) > q(e, \lambda^B) > q(e, 0)$ if $\lambda^A > \lambda^B$.

Under the output-based rule, marginal (social) abatement costs are higher, resulting in an increased emissions price σ^D . Due to the different emission budgets ($\overline{CO2}^A > \overline{CO2}^B$) we obtain $\lambda^A > \lambda^B$ and, as a consequence, a higher emissions and output level in region A than in B ($e^{TA,D} > e^{TB,D}$, $q^{TA,D} > q^{TB,D}$). The output-based rule leads to efficiency losses which correspond to the shaded area.

Figure 1: Allocation schemes for countries differing only in their emissions

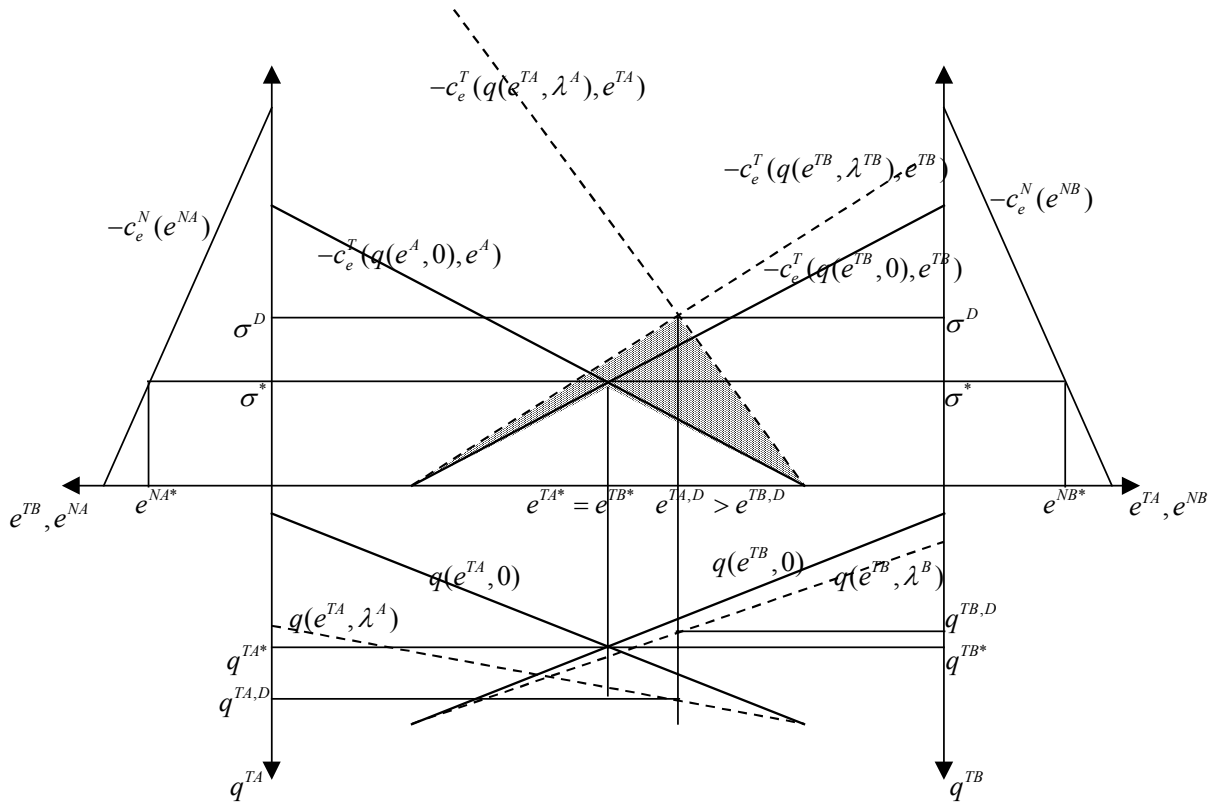

If the allocation factor is harmonized, emissions and output levels in the two regions would obviously be identical again ($e^{TA,H} = e^{TB,H}$, $q^{TA,H} = q^{TB,H}$).⁷ Due to the implicit output subsidy, however, the output level exceeds the optimal level q^{T^*} . In order to satisfy the burden sharing agreement for a harmonized allocation factor, the emissions in the non-trading sector must be adjusted. Since the emissions budget of region A is larger, emissions in region A, $e^{NA,H}$, would be greater than those in region B, $e^{NB,H}$.

3. Computable General Equilibrium Framework

The partial equilibrium analysis conveys important *qualitative* insights into the linkages between efficiency, compensation and discrimination associated with the implementation of the EU Directive through National Allocation Plans. However, for the sake of analytical tractability, it is highly stylized and neglects potentially important general equilibrium effects. In contrast, a numerical approach facilitates the analysis of complex nonlinear economic interactions and the impact assessment of structural policy changes. In order to provide policy-relevant *quantitative* information, we make use of a static 15-region, 9-sector computable general equilibrium (CGE) model for the EU economy calibrated to empirical data. Due to the micro-consistent comprehensive representation of complex market interactions, such CGE models have become the standard tool for economy-wide impact analysis of policy interference on resource allocation (i.e. structural change) and the associated implications for incomes of economic agents (see e.g. Conrad 2001).

At the sectoral level, our model incorporates sufficient details on differences in factor intensities, degrees of factor substitutability and price elasticities of output demand in order to trace back the structural change induced by environmental regulation. With respect to the analysis of carbon abatement policies, the sectors in the model have been carefully selected to keep the most carbon-intensive sectors in the available data as separate as possible. The energy goods identified in the model include primary carriers (coal, natural gas, crude oil) and secondary energy carriers (refined oil products and electricity). Furthermore, the model features three additional energy-intensive non-energy sectors (iron and steel; paper, pulp and printing; non-ferrous metals) whose installations – in addition to the secondary energy branches (refined oil products and electricity) – are subject to the EU emissions trading Directive. The remaining manufacturers and services are aggregated to a composite industry that produces a non-energy-intensive macro good. Table 1 summarizes the regions and sectors represented in the model.

The functional forms and key model assumptions are standard within the CGE approach to carbon abatement policy analysis (see e.g. Rutherford and Paltsev 2002). A brief non-technical summary of the generic model structure and its parameterization is provided below. A detailed algebraic exposition is available from <ftp://ftp.zew.de/pub/zew-docs/div/nap.pdf>.

⁷ For reasons of transparency, we have not inserted this case explicitly in Figure 1.

Table 1: Overview of model regions and sectors (commodities)

EU member countries		Production sectors	
AUT	Austria	<i>Primary energy carriers</i>	
BEL	Belgium	COL	Coal
DEU	Germany	CRU	Crude oil
DNK	Denmark	GAS	Natural gas
ESP	Spain	<i>Energy-intensive sectors (EIS)</i>	
FIN	Finland	OIL	Refined oil products
FRA	France	ELE	Electricity
GBR	United Kingdom	ORE	Iron and steel
GRC	Greece	PPP	Paper, pulp, and printing
IRE	Ireland	NFM	Non-ferrous metals
ITA	Italy	<i>Remaining manufacturers and services</i>	
LUX	Luxembourg	ROI	Rest of Industry
NLD	Netherlands		
PRT	Portugal		
SWE	Sweden		

3.1. Model Structure

Figure 2 provides a diagrammatic overview of the model structure. Primary factors of each EU region r include labor \bar{L}_r , capital \bar{K}_r , and fossil-fuel resources $\bar{Q}_{ff,r}$. Labor and capital are assumed to be mobile across sectors within each region. In fossil fuel production, part of capital is treated as a sector-specific resource, resulting in upward sloping supply schedules consistent with exogenous own-price elasticities of supply. Factor markets are assumed to be perfectly competitive such that flexible prices of factors ensure market clearance.⁸

Production Y_{ir} of commodities i in region r , other than primary fossil fuels, is captured by aggregate production functions which characterize technology through substitution possibilities between various inputs.

⁸ Given persistent high unemployment rates in many EU countries, the assumption of competitive labor markets is strong. However, the disputed causes for involuntary unemployment are country-specific and call for a sophisticated treatment of institutional constraints at the single-country level which goes beyond the scope and focus of our current analysis.

Figure 2: Diagrammatic CGE model structure

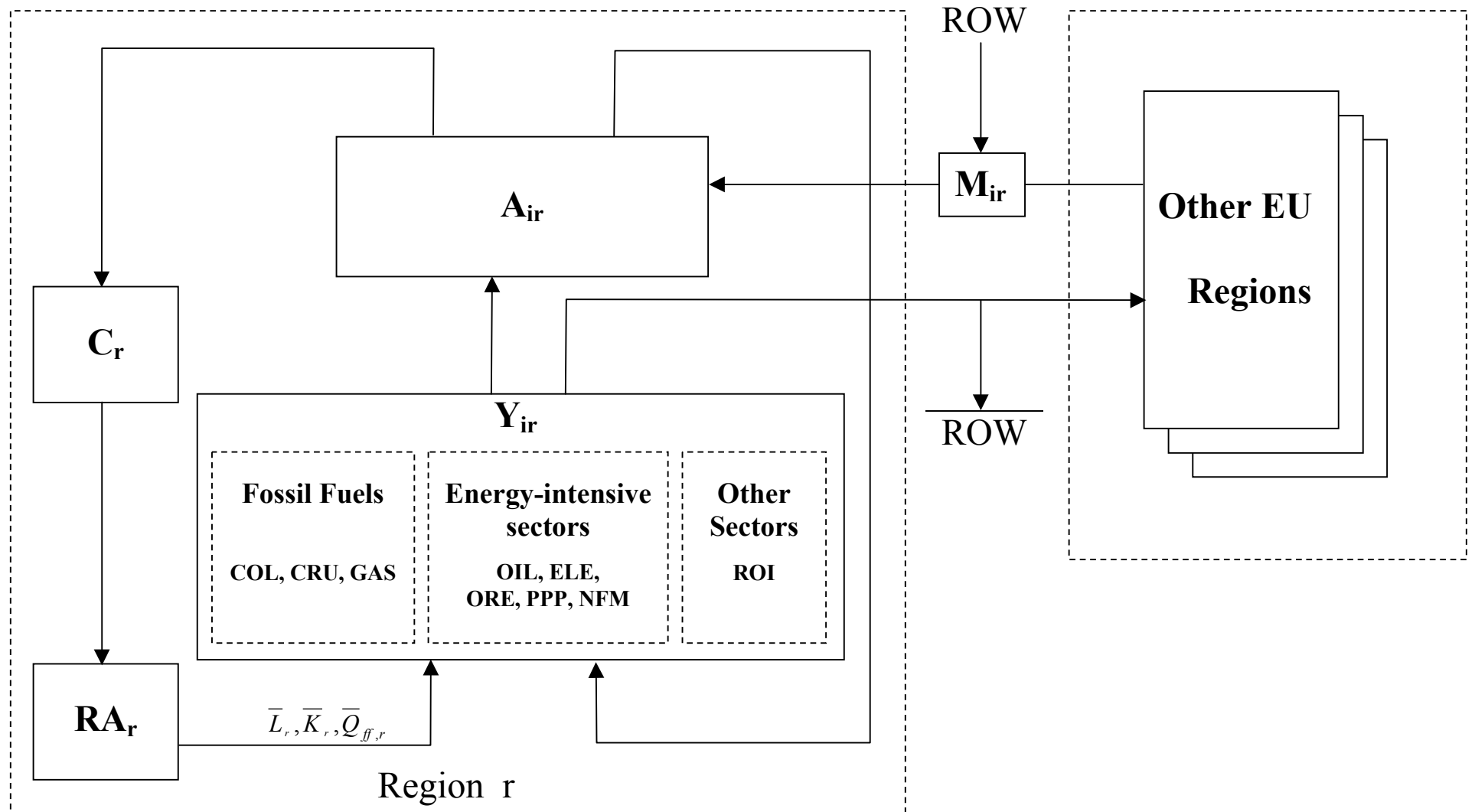

Nested, separable constant elasticity of substitution (CES) cost functions with three levels are employed to specify the substitution possibilities in domestic production between capital, labor, energy and non-energy intermediate inputs, i.e. material.

At the top level, material inputs are employed in fixed proportions with an aggregate of energy, capital and labor. At the second level, a CES function describes the substitution possibilities between the energy aggregate and the aggregate of labor and capital. The value-added composite is a CES function of labor and capital. The energy aggregate is produced with a CES function of a non-electric energy composite and electricity. The non-electric energy composite is then a CES function of coal, crude oil, refined oil, and natural gas. In the production of fossil fuels, all inputs, except for the sector-specific fossil fuel resource, are aggregated in fixed proportions at the lower nest. At the top level, this aggregate trades off with the sector-specific fossil fuel resource at a constant elasticity of substitution. The latter is calibrated in consistency with exogenous price elasticities of fossil fuel supply.

Final consumption demand C_r in each region is determined by a representative agent RA_r , who maximizes consumption subject to a budget constraint with fixed investment. Aggregate consumption of the representative agent is given as a CES composite which combines composite energy consumption with a non-energy consumption bundle. Substitution patterns within the non-energy consumption bundle are reflected via Cobb-Douglas functions. The energy aggregate in final demand consists of the various energy goods trading off at a constant elasticity of substitution. Government demand within each region is fixed at exogenous real levels. Public goods and services are produced with a CES aggregation of commodity inputs. The expenditure for public good provision is handled through the budget constraint of the representative agent.

Trade between regions is specified using the Armington approach to product heterogeneity, so domestic and foreign goods of the same variety are distinguished by origin. The Armington composite A_{ir} for a traded good is a CES function of an imported composite M_{ir} and domestic production for that sector. The import composite is then a CES function of an EU import composite and imports from the rest of the world (ROW). The EU import composite of a specific EU region in turn is a CES function of production from all other EU countries. EU countries are assumed to be price-takers with respect to world market prices, i.e. ROW import-supply functions and ROW export-demand functions are perfectly elastic. There is an imposed balance of payment constraint to ensure trade balance between the EU and ROW through a flexible exchange rate. That is, the value of imports from the ROW to the EU must equal the value of exports from the EU to the ROW after accounting for the benchmark trade deficit or surplus of EU regions.

3.2. Data and Calibration

The effects of policy changes are measured with respect to a reference situation – labeled as Business-as-Usual (*BaU*). In comparative-static analysis, the reference situation is captured by economic transactions in a particular benchmark year (1997 in our case). As is customary in applied general equilibrium analysis, benchmark quantities and prices – together with exogenous elasticities (see Table A.6 in the download) – determine the parameters of functional forms. For this model calibration, we employ the GTAP-5E database (McDougall et al. 1999) which provides most recent consistent accounts of regional production and consumption, bilateral trade and energy flows for up to 66 countries and 23 commodities.

4. Policy Scenarios and Quantitative Results

Table 2 provides a summary of historic and projected CO₂ emissions together with the respective percentage emission reduction requirements. The columns “CO₂ emissions - 1990” and “Reduction requirements (in %) - 1990” report absolute CO₂ emissions and the percentage reduction commitments across EU Member States under the burden sharing agreement with respect to the Kyoto benchmark year 1990

Table 2: CO₂ emissions and CO₂ reduction requirements (EiE 1999)

		CO ₂ emissions (in mill. tons)		Reduction requirements (in %)	
		1990	2010	1990	2010
AUT	Austria	55.0	54.8	13.0	12.7
BEL	Belgium	104.8	124.0	7.5	21.8
DEU	Germany	951.6	827.5	21.0	9.2
DNK	Denmark	52.7	54.9	21.0	24.2
ESP	Spain	201.9	274.1	-15.0	15.3
FIN	Finland	51.3	73.6	0.0	30.3
FRA	France	352.4	389.7	0.0	9.6
GBR	United Kingdom	566.9	572.3	12.5	13.3
GRC	Greece	70.9	109.4	-25.0	19.0
IRE	Ireland	30.1	42.8	-13.0	20.5
ITA	Italy	388.0	429.9	6.5	15.6
LUX	Luxembourg	10.6	8.9	28.0	14.2
NLD	Netherlands	153.0	205.6	6.0	30.0
PRT	Portugal	39.1	66.5	-27.0	25.3
SWE	Sweden	50.5	64.0	-4.0	17.9

Since the commitments do not apply prior to the Kyoto budget period 2008-2012, the *effective* cutback requirements will depend on the future evolution of emissions under Business-as-Usual. The column labeled “CO₂ emissions – 2010” reports official EU projections of baseline emissions for the central year 2010 of the Kyoto budget period (EiE 1999). Accounting for the cross-country differences in projected carbon emissions, the targets with respect to 1990 translate into quite different *effective* targets with respect to 2010 (column “CO₂ emissions - 2010”): Spain, for example, receives carbon emission rights under the burden sharing agreement that are 15 % higher than its 1990 emissions, but – as of 2010 – it must cut back emissions by roughly 15 % vis-à-vis its projected baseline. Contrary, Germany faces a reduction commitment of 21 % from 1990 levels but this boils down to an *effective* reduction requirement of 9.2 % since German baseline emissions are projected to fall considerably below 1990 emission levels (mostly due to “wallfall-profits” from reunification) .

In our policy simulations, we abstain from a forward calibration of the European economy to projected 2010 statistics. The reasons for this are the uncertainties and potentially large inconsistencies associated with projections which are based on partial analytical studies.⁹ Instead, we use the projected *effective* percentage reduction requirements for EU member countries under the Kyoto Protocol and impose these emission constraints on our EU benchmark data for 1997 which is based on empirical observations.

4.1. Scenarios

We consider four scenarios that cover key dimensions of the policy debate on the implementation of the EU emissions trading Directive. The first scenario captures the extreme point of purely domestic action:

- Scenario *NoTRADE* reflects a situation in which all EU Member States meet their burden sharing commitments through domestic action only. The domestic governments set emission taxes sufficiently high to comply with the national reduction targets.¹⁰ Carbon tax revenues accrue lump-sum to the representative agent. The *NoTRADE* simulation delivers a reference point for the magnitude and distribution of efficiency gains that emerge from cross-country emissions trading within the EU.

The next two scenarios address the implementation of the EU Directive through National Allocation Plans which requires the concrete specification of two fundamental design rules.

⁹ See Böhringer et al. (2000) for the problems involved in baseline calibration of CGE models to exogenous bottom-up projections.

¹⁰ Likewise, the government could auction emission permits within domestic borders, aligning the total amount of auctioned permits with its emission budget.

First, the total number of tradable allowances for energy-intensive sectors (installations) subject to the Directive must be determined. Second, the rule of how allowances get allocated to these sectors must be chosen. Regarding the choice of the emission cap, we adopt the principle of cost-effectiveness as put forward by Article 1 of the Directive (EU 2003). The cost-effective partitioning of a country's emission budget between Directive sectors and Non-Directive sectors (including the household sector) is based on full "where-flexibility" of emission abatement within the EU leading to equalized marginal abatement costs across all EU carbon sources. The emission limit that applies to the Non-Directive sectors then equals the aggregate emissions of these branches under full "where-flexibility"; the emission cap for the Directive sectors is the remaining residual of the country-specific emissions budget.¹¹ Regarding the allocation rule for emission allowances to Directive sectors, we distinguish between auctioning, where energy-intensive sectors must buy emission rights at the level of their actual emissions, and grandfathering, where emission allowances are shared out in proportion to sectoral output level times some historical emission intensity (AGE 2003):

- Scenario *AUCTION* reflects National Allocation Plans where allowance allocation to Directive sectors is based on auctioning. Revenues from auctioning accrue lump-sum to the representative agent.
- Scenario *OUTPUT* reflects National Allocation Plans where emission allowances are allocated to Directive sectors proportional to output times some historical emission intensity (in our case: 1997 emission intensities).

As discussed in Section 2, uniform combination of the least-cost approach and free allocation under the EU burden sharing agreement implies that installations (sectors) with identical characteristics will typically face different allocation factors across Member States. Our final scenario *OUTPUT** warrants competitive neutrality by harmonizing the allocation factor:

- Scenario *OUTPUT** employs an output-based allocation rule with a uniform allocation factor which is derived under scenario *OUTPUT* if one replaces the burden sharing constraints for each EU member state by the aggregate EU emission commitment under the Kyoto Protocol. In order to comply with the country-specific EU burden sharing agreement, we must endogenously adjust the least-cost partitioning between Directive sectors and Non-Directive sectors.

¹¹ The least-cost approach could be implemented with a hybrid tax-and-permit system. Domestic governments would have to set taxes for the Non-Directive sectors sufficiently high to meet their respective emission limits whereas the Directive sectors would be involved in EU-wide emissions trading subject to the respective emission caps.

Table 3 summarizes the main features of our four policy scenarios.

Table 3: Overview of key scenarios

Scenario	Regulation Scheme		International Emissions Trading
	Directive sectors	Non-Directive Sectors	
<i>NoTRADE</i>	Carbon tax	Carbon tax	No
<i>AUCTION</i>	Permit trade (auctioned)	Carbon tax	Yes
<i>OUTPUT</i>	Permit trade (output-based allocation with endogenous non-uniform allocation factors)	Carbon tax	Yes
<i>OUTPUT*</i>	Permit trade (output-based allocation with exogenous uniform allocation factor)	Carbon tax	Yes

4.2. Results

Table 4 summarizes the impacts on consumption, production and employment at the aggregate EU level (measured as percentage changes from *BaU* values).¹²

Table 4: Aggregate EU impacts (in % change from BaU)

	<i>NoTRADE</i>	<i>AUCTION</i>	<i>OUTPUT</i>	<i>OUTPUT*</i>
Consumption				
	-0.12	-0.08	-0.11	-0.12
Output				
Total	-0.23	-0.17	-0.25	-0.26
Directive sectors	-4.33	-3.36	-1.40	-1.20
Non-Directive sectors	-0.23	-0.16	-0.25	-0.26
Employment				
Directive sectors	-1.96	-1.90	0.96	0.94
Non-Directive sectors	0.08	0.08	-0.04	-0.04

Flexibility to abate emissions within the EU where it is least costly provides substantial efficiency gains: Compared to purely domestic action under *NoTRADE*, aggregate EU compliance costs to the Kyoto Protocol are more than 30 % lower under *AUCTION*. However, the potential cost savings are eaten up when emission allowances are not auctioned but freely allocated to Directive sectors proportional to output. Here, the implied output

¹² Note that we only account for the gross economic impacts of carbon emission constraints without accounting for potential environmental benefits.

subsidies create efficiency losses that outweigh the efficiency gains from equalized marginal abatement costs across Directive sectors (scenarios: *OUTPUT*, *OUTPUT**). At the same time, the subsidies preserve production and employment in Directive sectors. The decline in energy-intensive production under *OUTPUT* and *OUTPUT** amounts only to a fraction of the value under AUCTION.

The subsidy-induced price distortions may even increase employment in energy-intensive sectors above *BaU* levels due to factor substitution effects. While such compensation to influential energy-intensive industries may be comprehensible under specific political economy considerations (see e.g. Stavins 1998), it clearly does not only work at the expense of overall efficiency but is also detrimental for the performance of Non-Directive sectors.

Table 5 provides details on cross-country differences in allocation factors λ_r for scenario *OUTPUT*. The endogenous factors range from 0.17 (NLD - Netherlands) up to 0.83 (DEU - Germany) meaning that an identical installation in Germany receives five times the emission allowance per unit of output than in the Netherlands. Obviously, the wide range in allocation factors which emerges from our simulations justifies serious policy concerns on the competitive neutrality of the EU Directive implementation.

Table 5: Allocation factors and emission allocation to Directive sectors

AUT	BEL	DEU	DNK	ESP	FIN	FRA	GBR	GRC	IRL	ITA	LUX	NLD	PRT	SWE
Specific allocation factors λ_r (scenario: <i>OUTPUT</i>)														
0.71	0.38	0.83	0.71	0.68	0.53	0.78	0.79	0.68	0.66	0.71	0.53	0.17	0.41	0.24
Uniform allocation factor λ^* (scenario: <i>OUTPUT*</i>)														
0.72	0.72	0.72	0.72	0.72	0.72	0.72	0.72	0.72	0.72	0.72	0.72	0.72	0.72	0.72
"Efficient" emission allocation to Directive sectors in % of overall emission budget (scenario: <i>OUTPUT</i>)														
25	11	40	41	26	36	13	31	34	33	27	7	5	16	5
Adjusted emission allocation to Directive sectors in % of overall emission budget (scenario: <i>OUTPUT*</i>)														
26	23	33	43	27	52	12	28	37	37	28	11	28	30	16

Key: AUT- Austria, BEL - Belgium, DEU - Germany, DNK- Denmark, ESP - Spain, FIN - Finland, FRA - France, GBR - United Kingdom, GRC - Greece, IRE - Ireland, ITA - Italy, LUX - Luxembourg, NLD - Netherlands, PRT - Portugal , SWE – Sweden.

Harmonization towards a uniform allocation factor λ^* through shifts in the partitioning of country-specific Kyoto emission budgets, induce rather small changes in aggregate EU economic indicators (see column "*OUTPUT**" in Table 4), but – as laid out below – the implications at the single-country level can be substantial.

How can we derive a meaningful uniform allocation factor λ^* ? In principle, one could impose any factor that Member States might agree upon (e.g. a weighted average of the

endogenous factors λ_r listed in Table 5) and, subsequently, adjust the partitioning of the emission budget between the Directive and Non-Directive sectors to comply with the burden sharing agreement. Yet, we are not aware of any concrete allocation factor that is put forward in the policy debate. Thus, we perform an endogenous calculation of the uniform allocation factor where we preserve the least-cost partitioning of emissions between the Directive and the Non-Directive sectors at the *aggregate* EU level while imposing only an EU-wide emission cap for Directive sectors. We then impose the resulting allocation factor (central case value: 0.72) exogenously and adjust the country-specific partitioning of emissions between Directive and Non-Directive sectors to comply with the burden sharing agreement (scenario: *OUTPUT**).

Whenever the uniform allocation factor λ^* is above a country's λ_r , it must shift further emission rights from the Non-Directive sectors to the Directive sectors and vice versa. Table 5 reports the partitioning of a country's emissions budget between Directive and Non-Directive sectors for scenarios *OUTPUT* (least-cost partitioning with non-uniform allocation factors) and *OUTPUT** (adjustments under allocation factor harmonization).

Table 6 reports the impacts on real consumption for individual Member States. The first insight is that individual Member States are not necessarily better off from emissions trading (comparison between *NoTRADE* and *AUCTION*). The reason for this are changes in the terms of trade which can enforce or weaken a country's unambiguous cost savings on the emissions market through permit trade.¹³ Adverse terms-of-trade effects more than offset the direct efficiency gains from emissions trading for the countries Austria, Greece, and Italy. Most EU countries, however, are distinctly better off under auctioned permit trade across energy-intensive industries compared to purely domestic action.

Revenue-rebating to energy-intensive sectors through output-based allocation of emission allowances induces a decline in real consumption for any single EU Member State as compared to an auctioned permit system. Due to the production subsidies under *OUTPUT*, the output level of EU energy-intensive production is higher than in the efficient *AUCTION* solution, while the overall emission rate must be smaller than in the efficient case to meet the given EU-wide emission cap.

Application of a uniform allocation factor for identical firms across different regions requires adjustment of the emission cap assignments between industries covered by the Directive and the remaining segments of the economy.

¹³ See Böhringer and Rutherford (2002) for a detailed discussion and decomposition of terms-of-trade effects.

Table 6: Consumption changes by member state (in % change from *BaU*)

		<i>NoTRADE</i>	<i>AUCTION</i>	<i>OUTPUT</i>	<i>OUTPUT*</i>
AUT	Austria	-0.06	-0.07	-0.09	-0.09
BEL	Belgium	-0.26	-0.21	-0.32	-0.38
DEU	Germany	-0.02	0.03	0.01	0.03
DNK	Denmark	-0.13	-0.06	-0.14	-0.13
ESP	Spain	-0.48	-0.33	-0.57	-0.64
FIN	Finland	-0.02	-0.02	-0.03	-0.03
FRA	France	-0.11	-0.10	-0.11	-0.11
GBR	United Kingdom	-0.17	-0.17	-0.26	-0.26
GRC	Greece	-0.09	-0.10	-0.16	-0.17
IRE	Ireland	-0.10	-0.10	-0.12	-0.12
ITA	Italy	-0.07	-0.10	-0.11	-0.17
LUX	Luxembourg	-0.86	-0.55	-0.65	-0.76
NLD	Netherlands	-0.41	-0.32	-0.39	-0.42
PRT	Portugal	-0.11	-0.10	-0.12	-0.11
SWE	Sweden	-0.14	-0.12	-0.15	-0.19
EU	Europe-15	-0.12	-0.08	-0.11	-0.12

As illustrated by our stylized partial equilibrium analysis of Section 2, the aggregate *direct* efficiency effect may be ambiguous. While the shift away from the initial least-cost emission partitioning causes additional efficiency losses, a decreased allocation of (free) emission allowances to Directive sectors of a Member State reduces the associated output distortions. Only when the harmonization of the allocation factor leads to an increased allocation of (free) emissions, the direct efficiency implications are unambiguously negative. The basic partial equilibrium reasoning holds also for our general equilibrium analysis in most cases: All regions that must substantially upgrade their emission allowance to Directive sectors face non-negligible additional consumption losses *via-à-vis* the *OUTPUT* scenario.¹⁴

Table 7 reports the marginal abatement costs across the key policy scenarios that might differ between the Directive sectors and the Non-Directive segments of the economy. Under *NoTRADE* the marginal abatement costs are equivalent to the domestic carbon tax, which EU Member States must levy to achieve their exogenous emissions reduction targets. A key determinant for the magnitude of marginal abatement costs is the effective cutback

¹⁴ If the upgrading is not sufficiently pronounced, additional indirect general equilibrium effects (such as changes in the terms of trade) may override the partial equilibrium result as is the case for Spain and Denmark.

requirement. *Ceteris paribus*, the more a country has to reduce emissions, the more costly it is at the margin to substitute away from carbon in production and consumption. The substantial marginal abatement costs for Belgium, Denmark, Finland, Netherlands, and Portugal reflect large reduction requirements vis-à-vis countries such as Germany or France that have low marginal costs along with low abatement targets. However, there are other important determinants of marginal abatement costs, such as initial *BaU* energy prices or differences in the carbon intensities of sectors that explain why a country (e.g. Austria) may need higher carbon taxes than another one (e.g. United Kingdom) although its percentage reduction target is smaller. Likewise the level of *marginal* abatement costs is only a crude indicator for the magnitude of *inframarginal* adjustment costs to emission constraints as several potentially important general equilibrium effects are not accounted for (terms-of-trade effects, tax interaction effects, etc.).

Table 7: Marginal abatement costs in €₂₀₀₂ per ton of CO₂

	<i>NoTRADE</i>	<i>AUCTION</i>	<i>OUTPUT</i>		<i>OUTPUT*</i>	
			Directive Sectors	Non-Directive Sectors	Directive Sectors	Non-Directive Sectors
AUT	31	23	40	24	39	27
BEL	57	23	40	23	39	95
DEU	12	23	40	24	39	0
DNK	13	23	40	23	39	40
FIN	65	23	40	23	39	175
FRA	24	23	40	23	39	20
GBR	22	23	40	23	39	13
GRC	22	23	40	24	39	38
IRE	32	23	40	25	39	46
ITA	28	23	40	24	39	27
LUX	31	23	40	23	39	43
NET	78	23	40	23	39	143
PRT	61	23	40	24	39	114
SWE	25	23	40	24	39	32

Key: AUT- Austria, BEL - Belgium, DEU - Germany, DNK- Denmark, ESP - Spain, FIN - Finland, FRA - France, GBR - United Kingdom, GRC - Greece, IRE - Ireland, ITA - Italy, LUX - Luxembourg, NLD - Netherlands, PRT - Portugal , SWE – Sweden.

An efficient implementation of the EU Directive, that combines least-cost partitioning of the Kyoto budget with an auctioned permit system for energy-intensive industries, implies a tradable permit price of 23 €₂₀₀₂ per ton of CO₂. When revenues are rebated to Directive sectors via output-based allocation, the marginal abatement costs for the Directive sectors and

the Non-Directive sectors fall apart. Due to the output subsidies, emission reduction efforts in the Directive sectors are shifted towards more costly emission *rate* reductions and away from less costly *output* reduction. This is reflected in substantially higher marginal abatement costs for energy-intensive industries in Europe (40 €₂₀₀₂ per ton of CO₂ for *OUTPUT* and 39 €₂₀₀₂ per ton of CO₂ for *OUTPUT** respectively). Regarding the Non-Directive sectors, there are only slight deviations under scenario *OUTPUT* from the uniform marginal abatement costs under *AUCTION* (due to general equilibrium spillovers). Under scenario *OUTPUT**, however, there are drastic changes whose magnitude and direction mirror the adjustments of emission allocations as reported in Table 5. For countries, where the harmonization of the allocation factor leads to an increased allocation of emissions to Non-Directive sectors (Germany, France, and the United Kingdom), the marginal abatement costs fall below the *OUTPUT* reference price of 23 €₂₀₀₂ per ton of CO₂; the opposite applies to countries with decreased allocation of emissions to Non-Directive sectors. The associated shifts range from zero marginal abatement costs in the case of Germany (i.e. the Non-Directive sectors receives an emission budget which is in excess of its equilibrium emission) to more than 175 €₂₀₀₂ per ton of CO₂ for Non-Directive sectors in Finland.

In our core simulations, we have not incorporated the possibility of project-based emissions trading with non EU countries via joint implementation (JI) or the clean development mechanism (CDM) (as foreseen under the Kyoto Protocol and – in principle – being considered within the EU emissions trading Directive). Second, the possibility of purchasing “hot air” from Russia (in case of Russian ratification of the Kyoto Protocol) is not considered. Third, the forthcoming EU accession of Eastern European countries and their integration into the provisions of the EU emissions trading Directive has been omitted. All three subjects - JI/CDM, trade in hot air, and EU Eastern Enlargement increase the low-cost potential for emission abatement within the EU. Sensitivity analysis shows that – while the volume and price of extra-EU supply in emission rights alter the concrete numbers of the core simulation – all of our qualitative results remain robust.

5. Conclusions

In 2005, an EU-wide emissions trading scheme among energy-intensive installations is scheduled to start. Prior to enactment, each EU member state must develop a National Allocation Plan that defines the quantity of allowances it intends to allocate and the specific rules for the allocation of emission allowances to energy-intensive installations.

Starting from an efficient aggregate emissions cap for the energy-intensive sectors which participate in emissions trading under the EU Directive, we studied the impacts of output-based allocation schemes. Under the burden sharing agreement, allocation factors will

generally differ across countries such that concerns on competitive distortions might be justified. In order to harmonize allocation factors and preserve competitive neutrality, an adjustment of the emissions caps for Directive (trading) sectors and Non-Directive (non-trading) sectors abatement policies in non-trading sectors is necessary, which can have substantial efficiency effects at the single-country level..

Using a CGE model to quantify the effects, our analysis provides policy-relevant information into the potential tradeoffs between efficiency, compensation, and competitive neutrality associated with the implementation of an EU emissions trading system. It will be interesting to see how policy is going to address these tradeoffs in the near future.

References

- AGE (2003), Arbeitsgruppe "Emissionshandel zur Bekämpfung des Treibhauseffektes", Berlin.
- Böhringer, C., Jensen, J. and T.F. Rutherford (2000) Energy Market Projections and Differentiated Carbon Abatement in the European Union, in *Efficiency and Equity of Climate Change Policy* (Ed.) C. Carraro, Kluwer, 199-220.
- Böhringer (2001), Industry-level Emission Trading between Power Producers in the EU, *Applied Economics* 34 (4), 523-533, 2001
- Böhringer, C. and T.F. Rutherford (2002), Carbon Abatement and International Spillovers, *Environmental and Resource Economics* 22(3), 391-417.
- Böhringer, C. and A. Lange (2003a), On the Design of Optimal Grandfathering Schemes for Emission Allowances, Discussion Paper 03-08, ZEW (Centre for European Economic Research), Mannheim.
- Böhringer, C. and A. Lange (2003b), Economic Implications of Alternative Allocation Schemes for Emission Allowances, Discussion Paper 03-22, ZEW (Centre for European Economic Research), Mannheim.
- Capros, P. and L. Mantzos (2000) The Economic Effects of EU-Wide Industry-Level Emission Trading to Reduce Greenhouse Gases, ICCS, National Technical University of Athens.
- Conrad, K. (2001), Computable General Equilibrium Models in Environmental and Resource Economics, in: T. Tietenberg and H. Folmer (eds.): The International Yearbook of Environmental and Resource Economics 2002/2003, 66-114.
- EiE (1999) European Union Energy Outlook to 2020, Energy in Europe, European Commission, Brussels.
- EU (1999), EU Council of Ministers, Commission Communication, *Preparing for Implementation of the Kyoto Protocol*, COM (1999), Annex 1, available at: http://europa.eu.int/comm/environment/docum/99230_en.pdf.
- EU (2001): Proposal for a Framework Directive for Greenhouse Gas Emissions Trading within the European Community, COM (2001)581, European Commission, Brussels. (http://europa.eu.int/eur-lex/fr/com/pdf/2001/fr_501PC0581.pdf)
- EU (2003), Directive establishing a scheme for greenhouse gas emission allowance trading within the Community and amending Council directive 96/61/EC, European Commission, Brussels, provisional text, available at: <http://europa.eu.int/comm/environment/climat/030723provisionaltext.pdf>.

- McDougall, R.A. (1999), ed., *Global Trade, Assistance and Protection: The GTAP 5 Data Base*, Center for Global Trade Analysis, Purdue University, West Lafayette.
- Rutherford, T. and S. Paltsev (2002), GTAPinGAMS and GTAP-EG: Global Datasets for Economic Research and Illustrative Models
- Stavins, R.N. (1998), What Can We Learn from the Grand Policy Experiment? Lessons from SO₂ Allowance Trading, *Journal of Economic Perspectives*, 12(3), 69-88.
- UNFCCC (1997) Kyoto Protocol to the United Nations Framework Convention on Climate Change, United Nations Convention on Climate Change, FCCC/CP/L.7/Add1, Kyoto.

**Efficiency, compensation, and discrimination:
What is at stake when implementing the EU emissions trading
scheme?**

Christoph Böhringer and Andreas Lange

boehringer@zew.de, lange@zew.de

Centre for European Economic Research (ZEW), Mannheim

P.O. Box 10 34 43

D-68034 Mannheim, Germany

Downloadable Appendix

(<ftp://ftp.zew.de/pub/zew-docs/div/nab.pdf>)

We provide an algebraic summary of the equilibrium conditions for our comparative-static model designed to investigate the economic implications of alternative policies to implement carbon emission constraints. For the generic model the following assumptions apply:

- Nested separable constant elasticity of substitution (CES) functions characterize the use of inputs in production. All production exhibits non-increasing returns to scale. Goods are produced with capital, labor, energy and material (KLEM).
- A representative agent (RA) in each region is endowed with three primary factors: natural resources (used for fossil fuel production), labor and capital. The RA maximizes utility from consumption of a CES composite subject to a budget constraint with fixed investment demand (i.e. fixed demand for the savings good). The aggregate consumption bundle combines demands for fossil fuels, electricity and non-energy commodities. Total income of the RA consists of factor income and taxes (including revenues from carbon taxes or auctioned carbon permits).
- Supplies of labor, capital and fossil-fuel resources are exogenous. Labor and capital are mobile within domestic borders but cannot move between regions; natural resources are sector specific.
- All goods are differentiated by region of origin. Constant elasticity of transformation functions (CET) characterize the differentiation of production between production for the domestic markets and the export markets. Regarding imports, nested CES functions characterize the choice between imported and domestic varieties of the same good (Armington).
- Goods from regions which are not explicitly represented (rest of the world - ROW) are differentiated, and a set of horizontal export demand and import supply functions determine the trade between ROW and the regions whose production and consumption patterns are described in detail. In other words, the representation of ROW is reduced to import and export flows with the explicit regions of the model where the latter are assumed to be price-takers with respect to ROW import and export prices.

The model is formulated as a system of nonlinear inequalities. These inequalities correspond to two classes of equilibrium conditions: zero profit and market clearance. The fundamental unknowns of the system are two vectors: activity levels and prices. In equilibrium, each of these variables is linked to one inequality condition: an activity level to a zero-profit condition and a commodity (factor) price to a market-clearance condition.

In the algebraic exposition below, the notation Π_{ir}^z is used to denote the (zero-)profit function of sector j in region r where z is the name assigned to the associated production activity. Differentiating the profit function with respect to input and output prices provides compensated demand and supply coefficients (Hotellings's lemma), which appear

subsequently in the market clearance conditions. We use i (aliased with j) as an index for commodities (sectors) and r (aliased with s) as an index for regions. The label EG represents the set of energy goods and the label FF denotes the subset of fossil fuels. Tables A.1 - A.6 explain the notations for variables and parameters employed within our algebraic exposition. Figures A.1 - A.5 provide a graphical exposition of the production and final consumption structure.

Zero Profit Conditions

1. Production of goods except fossil fuels:

$$\prod_{ir}^Y = \left(\theta_{ir}^{XROW} p^{W^{1-\eta}} + (1-\theta_{ir}^X) p_{ir}^{1-\eta} \right)^{\frac{1}{1-\eta}} - \sum_{j \in EG} \theta_{jir} p_{jr}^A$$

$$- \theta_{ir}^{KLE} \left[\theta_{ir}^E p_{ir}^E I^{-\sigma_{KLE}} + (1-\theta_{ir}^E) \left(w_r^{\alpha_{jr}^L} v_r^{\alpha_{jr}^K} \right)^{1-\sigma_{KLE}} \right]^{\frac{1}{1-\sigma_{KLE}}} \leq 0 \quad i \notin FF$$

where Y_{ir} ($i \notin ff$) is the associated activity variable.

2. Production of fossil fuels:

$$\prod_{ir}^Y = \left(\theta_{ir}^{XROW} p^{W^{1-\eta}} + (1-\theta_{ir}^X) p_{ir}^{1-\eta} \right)^{\frac{1}{1-\eta}}$$

$$- \left[\theta_{ir}^Q q_{ir}^{1-\sigma_{Qj}} + (1-\theta_{ir}^Q) \left(\theta_{Lir}^{FF} w_r + \theta_{Kir}^{FF} v_r + \sum_j \theta_{jir}^{FF} p_{jr}^A \right)^{1-\sigma_{Qj}} \right]^{\frac{1}{1-\sigma_{Qj}}} \leq 0 \quad i \in FF$$

where Y_{ir} ($i \in ff$) is the associated activity variable.

3. Sector-specific energy aggregate:

$$\prod_{ir}^E = p_{ir}^E - \left\{ \theta_{ir}^{ELE} p_{\{ELE,r\}}^{A^{1-\sigma_{ELE}}} + (1-\theta_{ir}^{ELE}) \left[\theta_{ir}^{COA} p_{\{COA,r\}}^{A^{1-\sigma_{COA}}} + (1-\theta_{ir}^{COA}) \left(\prod_{j \in LQ} p_{jr}^{A^{\beta_{jir}}} \right)^{1-\sigma_{COA}} \right]^{\frac{1-\sigma_{ELE}}{1-\sigma_{COA}}} \right\}^{\frac{1}{1-\sigma_{ELE}}} \leq 0$$

where E_{ir} is the associated activity variable.

4. Armington aggregate:

$$\prod_{ir}^A = p_{ir}^A - \left[\left(\theta_{ir}^A p_{ir}^{1-\sigma_A} + (1-\theta_{ir}^A) p_{ir}^{M^{1-\sigma_A}} \right)^{\frac{1}{1-\sigma_A}} + p_r^{CO2} a_i^{CO2} \right] \leq 0$$

where A_{ir} is the associated activity variable.

5. Aggregate imports across import regions:

$$\Pi_{ir}^M = p_{ir}^M - \left(\sum_s \theta_{isr}^M p_{is}^X l^{-\sigma_M} + \theta_{ir}^{MROW} p^W l^{-\sigma_M} \right)^{\frac{1}{1-\sigma_M}} \leq 0$$

where M_{ir} is the associated activity variable.

6. Household consumption aggregate:

$$\Pi_r^C = p_r^C - \left(\theta_{Cr}^E p_{Cr}^E l^{-\sigma_{EC}} + (1 - \theta_{Cr}^E) \left[\prod_{i \notin FF} p_{ir}^{A^{ir}} \right]^{l^{-\sigma_{EC}}} \right)^{\frac{1}{1-\sigma_{EC}}} \leq 0$$

where C_r is the associated activity variable.

7. Household energy aggregate:

$$\Pi_{Cr}^E = p_{Cr}^E - \left[\sum_{i \in FF} \theta_{iCr}^E p_{ir}^A l^{-\sigma_{FF,C}} \right]^{\frac{1}{1-\sigma_{FF,C}}} \leq 0$$

where E_{Cr} is the associated activity variable.

8. Investment:

$$\Pi_r^I = p_r^I - \sum_i \theta_{ir}^I p_{ir}^A \leq 0$$

where I_r is the associated activity variable.

Market Clearance Conditions

9. Labor:

$$\bar{L}_r \geq \sum_i Y_{ir} \frac{\partial \Pi_{ir}^Y}{\partial w_r}$$

where w_r is the associated price variable.

10. Capital:

$$\bar{K}_r \geq \sum_i Y_{ir} \frac{\partial \Pi_{ir}^Y}{\partial v_r}$$

where v_r is the associated price variable.

11. Natural resources:

$$\bar{Q}_{ir} = Y_{ir} \frac{\partial \Pi_{ir}^Y}{\partial q_{ir}} \quad i \in FF$$

where q_{ir} is the associated price variable.

12. Output for internal markets:

$$Y_{ir} \frac{\partial \Pi_{ir}^Y}{\partial p_{ir}} \geq A_{ir} \frac{\partial \Pi_{ir}^A}{\partial p_{ir}} + \sum_{s \neq r} M_{is} \frac{\partial \Pi_{is}^M}{\partial p_{ir}}$$

where p_{ir} is the associated price variable.

13. Sector-specific energy aggregate:

$$E_{ir} \geq Y_{ir} \frac{\partial \Pi_{ir}^Y}{\partial p_{ir}^E}$$

where p_{ir}^E is the associated price variable.

14. Import aggregate:

$$M_{ir} \geq A_{ir} \frac{\partial \Pi_{ir}^A}{\partial p_{ir}^M}$$

where p_{ir}^M is the associated price variable.

15. Armington aggregate:

$$A_{ir} \geq \sum_j Y_{jr} \frac{\partial \Pi_{jr}^Y}{\partial p_{ir}^A} + C_r \frac{\partial \Pi_r^C}{\partial p_{ir}^A} + I_r \frac{\partial \Pi_r^I}{\partial p_{ir}^A}$$

where p_{ir}^A is the associated price variable.

16. Investment aggregate:

$$\bar{I}_r \geq I_r$$

where p_r^I is the associated price variable.

17. Household consumption:

$$C_r p_r^C = w_r \bar{L}_r + v_r \bar{K}_r + \sum_{j \in FF} q_{jr} \bar{Q}_{jr} + p_r^{CO2} \bar{CO2}_r + p_r^I \bar{I}_r + \bar{B}_r$$

where p_r^C is the associated price variable.

18. Aggregate household energy consumption:

$$E_{Cr} = C_r \frac{\partial \Pi_r^C}{\partial p_{Cr}^E}$$

where p_{Cr}^E is the associated price variable.

19. Carbon emissions:

$$\overline{CO2}_r = \sum_i A_{ir} a_i^{CO2}$$

where p_r^{CO2} is the associated price variable.

20. Balance of payments:

$$\sum_{i,r} Y_{ir} \frac{\partial \Pi_{ir}^Y}{\partial p^W} + \sum_r \bar{B}_r = \sum_{i,r} M_{ir} \frac{\partial \Pi_{ir}^M}{\partial p^W}$$

where p^W is the associated price variable.

Table A.1: Sets

i	Sectors and goods
j	Aliased with i
r	Regions
s	Aliased with r
EG	All energy goods: Coal, crude oil, refined oil, gas and electricity
FF	Primary fossil fuels: Coal, crude oil and gas
LQ	Liquid fuels: Crude oil and gas

Table A.2: Activity variables

Y_{ir}	Production in sector i and region r
E_{ir}	Aggregate energy input in sector i and region r
M_{ir}	Aggregate imports of good i and region r
A_{ir}	Armington aggregate of good i in region r
C_r	Aggregate household consumption in region r
E_{Cr}	Aggregate household energy consumption in region r
I_r	Aggregate investment in region r

Table A.3: Price variables

p_{ir}	Output price of good i produced in region r for domestic market
p^W	Real exchange rate with the rest of the world (ROW)
p_{ir}^E	Price of aggregate energy in sector i and region r
p_{ir}^M	Import price aggregate for good i imported to region r
p_{ir}^A	Price of Armington good i in region r
p_r^C	Price of aggregate household consumption in region r
p_{Cr}^E	Price of aggregate household energy consumption in region r
p_r^I	Price of aggregate investment good in region r
w_r	Wage rate in region r
v_r	Price of capital services in region r
q_{ir}	Rent to natural resources in region r ($i \in \text{FF}$)
$p_r^{\text{CO}_2}$	Shadow price of CO_2 unit in region r

Table A.4: Cost shares

$\theta_{ir}^{\text{XROW}}$	Share of ROW exports in sector i and region r
θ_{jir}	Share of intermediate good j in sector i and region r ($i \notin \text{FF}$)
θ_{ir}^{KLE}	Share of KLE aggregate in sector i and region r ($i \notin \text{FF}$)
θ_{ir}^E	Share of energy in the KLE aggregate of sector i and region r ($i \notin \text{FF}$)
α_{ir}^T	Share of labor ($T=L$) or capital ($T=K$) in sector i and region r ($i \notin \text{FF}$)
θ_{ir}^Q	Share of natural resources in sector i of region r ($i \in \text{FF}$)
θ_{Tir}^{FF}	Share of good i ($T=i$) or labor ($T=L$) or capital ($T=K$) in sector i and region r ($i \in \text{FF}$)
θ_{ir}^{COA}	Share of coal in fossil fuel demand by sector i in region r ($i \notin \text{FF}$)
θ_{ir}^{ELE}	Share of electricity in energy demand by sector i in region r
β_{jir}	Share of liquid fossil fuel j in energy demand by sector i in region r ($i \notin \text{FF}, j \in \text{LQ}$)
θ_{isr}^M	Share of imports of good i from region s to region r
$\theta_{ir}^{\text{MROW}}$	Share of ROW imports of good i in region r
θ_{ir}^A	Share of domestic variety in Armington good i of region r

θ_{Cr}^E	Share of fossil fuel composite in aggregate household consumption in region r
θ_{ir}^I	Share of good i in investment composite in region r
γ_{ir}	Share of non-energy good i in non-energy household consumption demand in region r
θ_{iCr}^E	Share of fossil fuel i in household energy consumption in region r

Table A.5: Endowments and emissions coefficients

\bar{L}_r	Aggregate labor endowment for region r
\bar{K}_r	Aggregate capital endowment for region r
\bar{Q}_{ir}	Endowment of natural resource i for region r ($i \in FF$)
\bar{B}_r	Balance of payment deficit or surplus in region r (note: $\sum_r \bar{B}_r = 0$)
$\overline{CO_{2r}}$	Endowment of carbon emission rights in region r
$a_i^{CO_2}$	Carbon emissions coefficient for fossil fuel i ($i \in FF$)

Table A.6: Elasticities

η	Transformation between production for the domestic market and production for the export	2
σ_{KLE}	Substitution between energy and value-added in production (except fossil fuels)	0.8
$\sigma_{Q,i}$	Substitution between natural resources and other inputs in fossil fuel production calibrated consistently to exogenous supply elasticities μ_{FF} .	$\mu_{COA}=0.5$ $\mu_{CRU}=1.0$ $\mu_{GAS}=1.0$
σ_{ELE}	Substitution between electricity and the fossil fuel aggregate in production	0.3
σ_{COA}	Substitution between coal and the liquid fossil fuel composite in production	0.5
σ_A	Substitution between the import aggregate and the domestic input	4
σ_M	Substitution between imports from different regions	8
σ_{EC}	Substitution between the fossil fuel composite and the non-fossil fuel consumption aggregate in household consumption	0.8
$\sigma_{FF,C}$	Substitution between fossil fuels in household fossil energy consumption	0.3

Figure A.1: Nesting in non-fossil fuel production

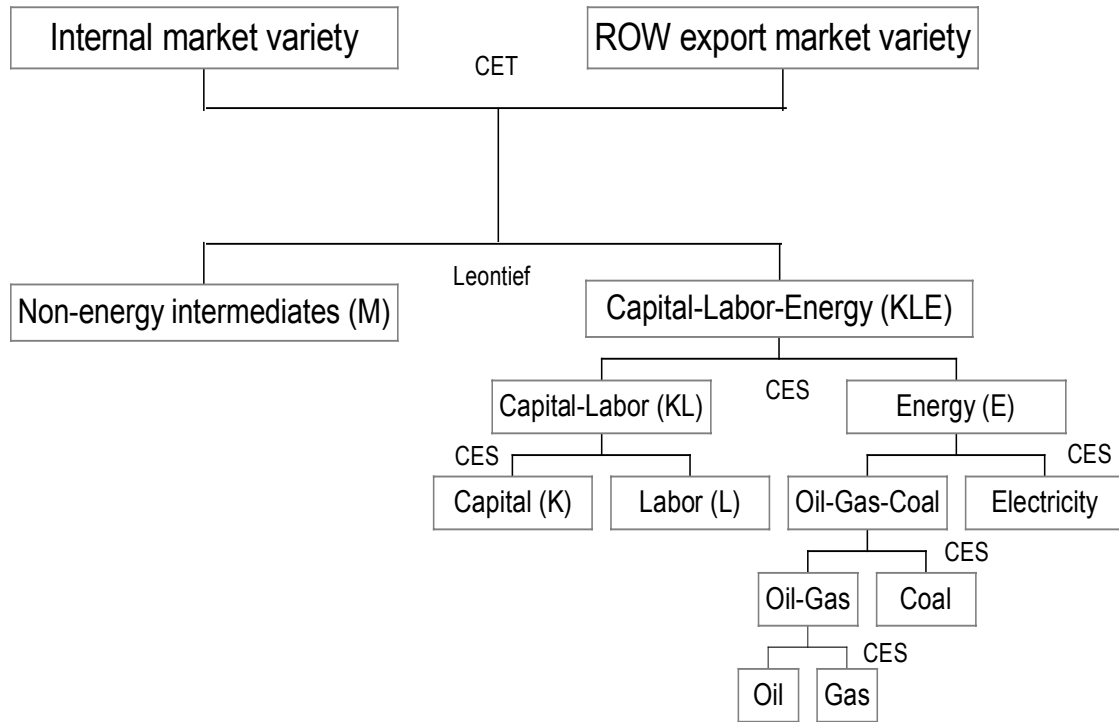

Figure A.2: Nesting in fossil fuel production

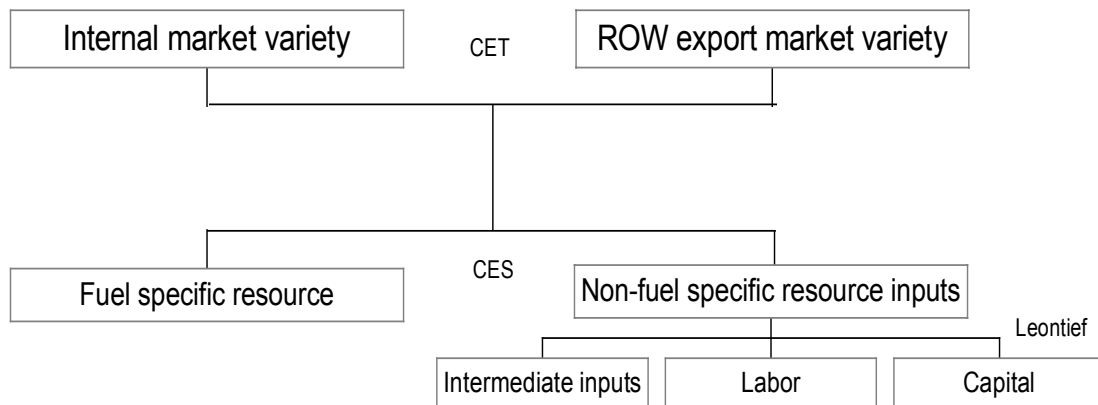

Figure A.3: Nesting in household consumption

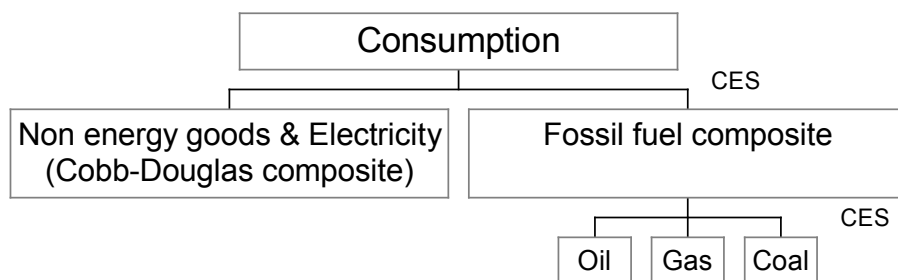

Figure A.4: Nesting in Armington production

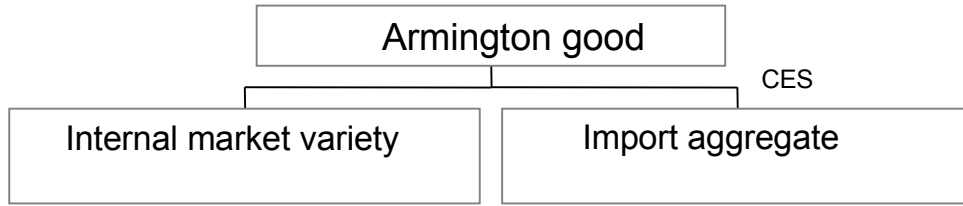
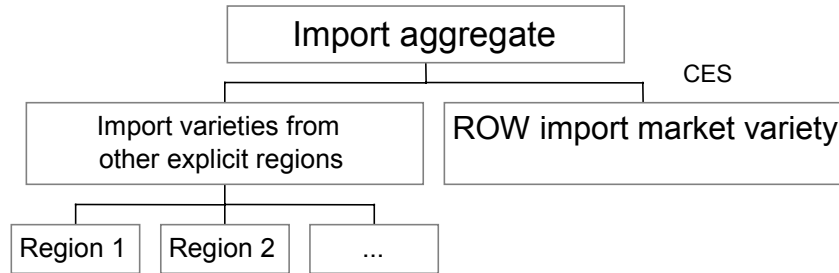

Figure A.5: Nesting in import aggregate



Implementation of Emission Abatement Scenarios

We can distinguish our policy scenarios on the implementation of the EU emissions trading Directive along two key dimensions: (i) whether emissions can be traded internationally, and (ii) whether emission allowances are allocated for free to specific sectors (according to an output-based rule). In order to distinguish scenario-specific carbon prices by sector, we must explicitly account for carbon demands within the zero-profit conditions characterizing the sector-specific energy aggregate and the household energy aggregate (instead of the Armington aggregate). Carbon demands by segment z (i for production sector or C for the household sector) then read as:

$$CO2_{ir} = E_{ir} \sum_{j \in ff} \frac{\partial \Pi_{ir}^E}{\partial (p_{jr} + a_j^{CO2} p_{jr}^{CO2})} \quad \text{and} \quad CO2_{Cr} = E_{Cr} \sum_{j \in ff} \frac{\partial \Pi_r^C}{\partial (p_{jr} + a_j^{CO2} p_{jr}^{CO2})} .$$

For the *NoTRADE* scenario, where domestic governments must set emission taxes sufficiently high to comply with the national reduction targets $\overline{CO2}_r$, the market clearance condition determining the carbon price (carbon tax) can be written as:

$$\overline{CO2}_r \geq \sum_z CO2_{zr} .$$

In the remaining scenarios, that allow for international emissions trading of Directive sectors (denoted T), there are two market clearance conditions – one for Directive sectors ($z \in T$) and the other one for Non-Directive sectors ($z \notin T$):

$$\sum_r \overline{CO2}_r^T \geq \sum_r \sum_{z \in T} CO2_{zr} \quad \text{and} \quad \overline{CO2}_r - \overline{CO2}_r^T \geq \sum_{z \notin T} CO2_{zr} ,$$

where $\overline{CO2}_r^T$ ($0 < \overline{CO2}_r^T < \overline{CO2}_r$) denotes the amount of emission allowances set aside for the segments forming part of the trading system (T).

As to the allocation of emission allowances, our exposition of generic equilibrium conditions in sections A.2 and A.3 cover the case of carbon taxation or auctioning. Under output-based assignment, the value of freely allocated emission rights constitutes a subsidy that enters the zero-profit condition of sectoral production. Allowances per-unit of output are allocated to Directive sectors in proportion to the benchmark emission intensity $\frac{\overline{E}_{ir}}{Y_{ir}}$. The implicit ad-valorem output subsidy s_{ir} can be written as:

$$s_{ir} \geq \lambda_r^y \left(\frac{\overline{E}_{ir}}{Y_{ir}} p_{ir}^{CO2} \right) / p_{ir} ,$$

where λ_r^y denotes the endogenous emission allocation factor per unit of output. This factor is determined by the associated “emission budget” constraint for the Directive sectors:

$$\overline{CO2}_r^T \geq \lambda_r^y \sum_{i \in T} \frac{\overline{E}_{ir}}{Y_{ir}} Y_{ir} .$$