

Pires, Luiza Nassif

Working Paper

Notes on intersectional political economy: The long period method, technical change, and gender

Working Paper, No. 957

Provided in Cooperation with:

Levy Economics Institute of Bard College

Suggested Citation: Pires, Luiza Nassif (2020) : Notes on intersectional political economy: The long period method, technical change, and gender, Working Paper, No. 957, Levy Economics Institute of Bard College, Annandale-on-Hudson, NY

This Version is available at:

<https://hdl.handle.net/10419/238647>

Standard-Nutzungsbedingungen:

Die Dokumente auf EconStor dürfen zu eigenen wissenschaftlichen Zwecken und zum Privatgebrauch gespeichert und kopiert werden.

Sie dürfen die Dokumente nicht für öffentliche oder kommerzielle Zwecke vervielfältigen, öffentlich ausstellen, öffentlich zugänglich machen, vertreiben oder anderweitig nutzen.

Sofern die Verfasser die Dokumente unter Open-Content-Lizenzen (insbesondere CC-Lizenzen) zur Verfügung gestellt haben sollten, gelten abweichend von diesen Nutzungsbedingungen die in der dort genannten Lizenz gewährten Nutzungsrechte.

Terms of use:

Documents in EconStor may be saved and copied for your personal and scholarly purposes.

You are not to copy documents for public or commercial purposes, to exhibit the documents publicly, to make them publicly available on the internet, or to distribute or otherwise use the documents in public.

If the documents have been made available under an Open Content Licence (especially Creative Commons Licences), you may exercise further usage rights as specified in the indicated licence.



Working Paper No. 957

Notes on Intersectional Political Economy: The Long Period Method, Technical Change, and Gender

by

Luiza Nassif Pires
Levy Economics Institute of Bard College

June 2020

The Levy Economics Institute Working Paper Collection presents research in progress by Levy Institute scholars and conference participants. The purpose of the series is to disseminate ideas to and elicit comments from academics and professionals.

Levy Economics Institute of Bard College, founded in 1986, is a nonprofit, nonpartisan, independently funded research organization devoted to public service. Through scholarship and economic research it generates viable, effective public policy responses to important economic problems that profoundly affect the quality of life in the United States and abroad.

Levy Economics Institute
P.O. Box 5000
Annandale-on-Hudson, NY 12504-5000
<http://www.levyinstitute.org>

Copyright © Levy Economics Institute 2020 All rights reserved

ISSN 1547-366X

ABSTRACT

This paper presents a critique of Karl Marx's labor theory of value and his theory of falling profit rates from an intersectional political economy perspective. Specifically, I rely on social reproduction theory to propose that Marx-biased technical change disrupts the social order and leads to competition between workers. The bargaining power of workers cannot be dissociated from class struggle within the working class. I argue that technical change increases social conflict, which can counterbalance the long-run tendency of the profit rate to fall. The conclusion is that class struggle is multilayered and endogenous to the process of accumulation.

KEYWORDS: Political Economy; Social Reproduction Theory; Gender and Racial Economics; Labor Unions; Technical Change

JEL CLASSIFICATIONS: B54; B51; J51; O33

1. INTRODUCTION

In this paper, I propose that the existence of identity categories needs to be taken into account to fully understand the laws that govern the accumulation of capital. I also propose that identities can be fabricated as a consequence of technical change. The economic and the social spheres are intertwined and there are multiple endogenous processes that can be initiated in either of them. In this paper, I identify one such endogenous process and propose that social ruptures can be endogenous to the process of accumulation. The existence of classes and the dynamics between and within classes are analyzed here in terms of social disruptions that occur as a consequence of capital accumulation.

Classical political economic theory has an advantage compared to neoclassical economics—it allows for an evaluation of class interaction’s effect on macroeconomic results. Political economy therefore provides a better foundation for studying the existence of discrimination, exploitation, and growing inequality in advanced capitalist economies. Nonetheless, little attempt has been made to discuss the theoretical implications of the existence of heterogeneity within the working class from an economic perspective.

In the *Communist Manifesto*, Karl Marx and Friedrich Engels (2016) state that: “In the earlier epochs of history, we find almost everywhere a complicated arrangement of society into various orders, a manifold gradation of social rank. [...] Our epoch, the epoch of the bourgeoisie, possesses, however, this distinctive feature: it has simplified the class antagonisms. Society as a whole is more and more split into two great hostile camps, into two great classes directly facing each other: bourgeoisie and proletariat” (Marx and Engels 2016, 6–7). In one of the few passages where they point to the existence of competition between workers, Marx and Engels affirm that even after being upset by such competition, the proletarians “ever rise up again, stronger, firmer, mightier.”

These two suppositions by Marx and Engels—that the class antagonisms in capitalism are binary and that competition among workers makes them stronger—are necessary to conclude that class antagonism between the bourgeoisie and the proletariat is the main driver of class dynamics.

I dispute this characterization and propose a move toward an intersectional political economy theory where identity discrimination adds a layer of complexity to the Marxian scheme, and therefore can impact the aggregate results of the capitalist system. Concretely, I follow the long-period method and rely on Marx's description of the basic laws that govern the tendency of the rate of profit to fall in the long run and its consequences to the functional income distribution. As will be argued, the result depends on how the wage rate responds to changes in productivity. I will proceed by reviewing Marx's theory of the value of labor power and the determinants of wages. This theory is then revised, taking into account gender aspects that are highlighted by social reproduction theory. I proceed to discuss how identity discrimination can impact the value of labor power and bargaining power, and analyze how the addition of this complexity leads to a discerning understanding of the dynamics of capital accumulation.

To accomplish this, I start with a discussion of the determinants of the long-run profit rate and profit share in the absence of complexities. This is followed by a section presenting Marx's theory of surplus value. Next, I follow Fraser (2014) to discuss how identity discrimination adds complexity to the system. Finally, I discuss how this revision allows for a reconciliation between political economy and social reproduction theory.

2. THE LONG-RUN TENDENCY OF THE PROFIT RATE TO FALL AND THE LONG-PERIOD METHOD

The classical economists, most notably Adam Smith, David Ricardo, and Marx, were interested in deriving the laws of motion underlying the capitalist system. To do so they used the long-period method, a method of abstraction where complexity was abstracted and then added in layers.

This approach introduced basic concepts such as natural price and natural wages, which were derived from the labor theory of value that served as a center of gravity for market prices and real wages in such cases. Natural values for variables can be understood as the center of gravity associated with their long-run tendency. Since fluctuations are expected to occur around those values, the observed average generally corresponds to the center of gravity. Nonetheless, this center can move over time.

To understand the dynamics of a specific variable in this framework, I start by describing the laws that govern the most basic layer. When analyzing each layer, it is useful to separate the short-run fluctuations from the long-run tendency. It is also useful to characterize the forces that guarantee that the center of gravitation is an attractor. In this section I will follow the long-period method of abstraction to discuss the determinants of the short- and long-run equilibrium rate of profit.

2.1 The First Layer: What Governs the Profit Rate in the Absence of Complexities

Under the assumption of capital mobility, capitalists always seek opportunities to achieve higher profits. Profit is the main motive for capitalism, its driving force. Across industries, capitalists seek to invest in the industry with the highest regulating capital.¹ This mobility of capital from less profitable industries to more profitable ones governs the gravitation of profits around the average profit, which serves as a statistical center.

This movement is seen as never-ending and there is no rest at equilibrium. Profit rates will always oscillate around the average and differences keep the movement going without ever stabilizing.

The average profit rate, i.e., the center of gravitation for the profit rate, can itself be moving throughout time. In fact, the classical economists acknowledge the fall in this long-run tendency of the profit rate as a stylized fact to be explained within the theory.

Smith recognizes the falling rate of profit as a stylized fact but fails to deliver an unambiguous explanation. Ricardo, however, builds a chain of causalities within his theory of rent, and Marx builds his explanation on a critique of Ricardo.

The rent theory in Ricardo (1891) has its roots in Thomas Malthus's (1986) population law but fails to consider the effects of technical progress over land productivity. Ricardo expects that with population growth, the higher demand for food would force the use of more and more land.

¹ This concept is present in Shaikh (2016) and refers to the most profitable technique within one industry.

Production would first take place on the most productive pieces of land. The growing demand would force expansion onto less and less productive land. Prices would be regulated by the less productive land and the landlords of the most productive land would be able to extract an income in the form of rent.

Accumulation is at the center of this process, since it allows for a higher amount of capital advanced as income, increasing the demand for labor, and therefore the market prices of wages. Population would respond to higher wages and its growth would pressure the demand for food. The higher demand for food would then force the expansion of production and increase the demand for land. Less productive land would be required for the production of food, and since this regulates the value of the goods produced, it would take more labor hours to produce one unit of food (or as Ricardo frequently uses, units of corn). According to the labor theory of value, the extra hours spent on one unit of corn corresponds to a rise in its value. This puts an upward pressure on the natural value of wages, which in his theory is the labor time necessary to reproduce subsistence level. Ricardo makes no distinction between variable and constant capital. He only considers the wages advanced in production as the variable capital.

In Ricardo, the profit rate (r) corresponds to:

$$r = \frac{s}{K} = \frac{TVP - V}{K} \quad (1)$$

where s is the surplus value, K is capital, TVP is the total value of production, and V is the variable capital. Therefore, accumulation would drive the value of wages up for a given amount of production, forcing the profit rate down.

There are two important aspects that are central in Ricardo's rent theory. First, there is no room for technical progress, i.e., the expansion of production would always come at the cost of using less productive lands, leading to decreasing marginal productivity. Second, throughout the accumulation process, less and less surplus is produced, which, in his scheme, means less profits.

Marx derives his theory from Ricardo, despite shortcomings in the latter's approach. Ricardo (1891: ch. 31) considers the impact of machinery on labor and profits, arguing that the introduction of machinery has a short-run impact on an individual capitalist's profits but in the long run the only benefit that capitalists would collect is from the reduced price of goods. He also proposes that machinery would displace labor and therefore impact employment. Marx, on the other hand, fully incorporates technical progress into his theory and suggests a radically different justification for the falling rate of profit.

Marx's theory of the falling rate of profit is compatible with the growing surplus value rate. According to Marx, the rate of profit is formalized by the following equation (Foley 1986, 92):

$$r = \frac{s}{K} = \frac{s}{v} \frac{s}{v+c} \frac{v+c}{K} = e \cdot k \cdot n \quad (2)$$

where s is the surplus value, v is wages, c is the constant capital, $e=s/v$ is the rate of surplus value or the rate of exploitation, $k = s/v+c$ is the composition of capital, and $n = v+c/K$ is the turnover time of capital. Equation 2 shows the conditions where a higher rate of surplus value (e) is compatible with a smaller rate of profit (r).

2.2 Technical Change

The profit rate, according to Marx, is the driving force of capitalism. Technical change in production is not an accident but an intrinsic consequence of accumulation (Foley 1986, 127). In the short run, capitalists compete against each other and seek higher profit rates. It is this competition in the short run that undermines the profit rate in the long run. This contradiction is explained by the individual interest of capitalists, which does not necessarily translate to an advantage for the capitalist class as a whole.

Marx proposes that while seeking greater profits, capitalists would introduce new techniques in production. These techniques would improve labor productivity and allow for the innovating capitalist to temporarily extract a "super profit" from his production. However, it would not take long until others shift their production to the more profitable sector, thus increasing the supply and driving prices down, reequalizing profit rates across sectors.

Finally, this lower price would account for a higher real wage and smaller profits. The incorporation of the new technique leads to a higher constant capital but does not affect the variable capital. This accounts for a lower composition of capital outlay, $v/v+c$. Therefore, the profit rate can fall even if the rate of surplus value is increasing, as long as the effect of the change in the composition is more than proportional to that of the rate of the surplus value. It is from this catastrophic expected collapse of capitalism that Okishio (1977) departs. He argues that technical progress is an important mechanism in overcoming slumps and reversing the trade cycle. He makes an important qualification to Marx's argument by stating that capitalists look solely for techniques that would increase their rate of profit in the short run. These are considered viable techniques. If the real wages are kept constant, the adoption of viable techniques would always raise the rate of profit.

The literature on how technical change impacts variables in a Marxian framework frequently uses the term "Marx-biased technical change" to refer to a technical change consistent with Marx's basic explanation of the falling rate of profit. This refers to a capital-using and labor-saving change that results in an increase in the productivity of labor accompanied by a fall in the productivity of capital (Foley and Michl 1999, 117).

Figure 1 provides an illustration of how Marx-biased technical change works. Capitalists will accept a technical change as viable if it provides an increase in the short-run profit rate for a given wage rate. This would lead an individual capitalist to move from A to B in figure 1. The capitalists implement the change with the expectation that the wage rate will remain the same and so they are able to collect a higher profit rate in the short run. Nonetheless, other capitalists will also adapt their techniques and the advantage would eventually disappear.

According to Michl (1999), "only when all the firms have adopted a new technique will the social or institutional mechanisms compel each of them to grant real pay raises." Furthermore, given the fall in prices that would follow the full incorporation of the new technique and the consequent increase in productivity, nominal wages would need to fall in order for real wages to be kept constant.

Figure 1: Marx-biased Technical Change

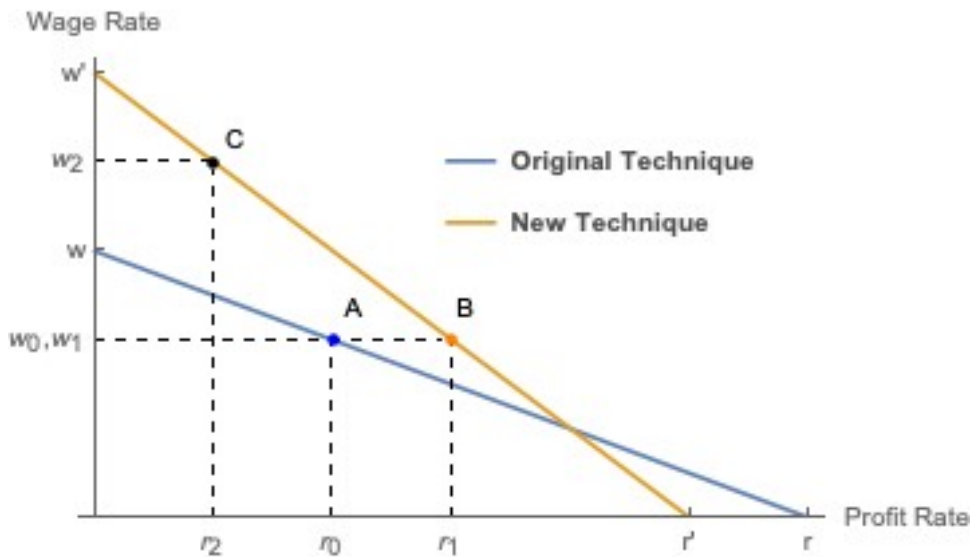

For a study of the wage share, it is necessary to couple changes in the real wage rate with productivity changes. Michl (1999) centers this discussion on a wage setting equation, replicated in equation 3.

$$w = \alpha x^\varphi \tag{3}$$

where w is the real wage rate, α is a constant, x is labor productivity, and $\varphi \geq 0$ is the real wage elasticity to labor productivity. It is the value of φ that determines how the functional distribution of income responds to a technical change that increases labor productivity.

The case where $\varphi = 0$ is consistent with Okishio's theorem of viability. In this case, when a viable technique is implemented, the wage rate would not respond to an increase in productivity and therefore the profit rate and profit share would increase. When $\varphi > 1$, both the profit rate and profit share fall steadily. The wage rate adapts to the change to more than compensate for the fact that the new technique is more capital intense. When $\varphi = 1$, a falling profit rate returns, but the profit share would be constant since the wage rate adapts to the increase in productivity with a constant proportional return. Finally, when $\varphi < 1$, the wage rate increases but less than proportionally to productivity, therefore leading to a fall in the wage share. These results are summarized in table 1.

Table 1: Impacts of a Marx-biased Technical Change for Given Values of φ

	Wage Rate	Profit Rate	Wage Share	Impact on Functional Income Distribution
$\varphi = 0$	Same	Increases	Decreases	Bigger share for capitalists
$0 < \varphi < 1$	Increases until switch point	Increases until switch point	Decreases until switch point	Depends on capital composition
$\varphi = 1$	Increases	Decreases	Same	Remains the same
$\varphi > 1$	Increases	Decreases	Increases	Bigger share for workers

The cases where $\varphi = 0$ and $\varphi > 1$ are depicted in figure 2. The slope of each curve indicates the capital–labor ratio. Steeper curves correspond to the new techniques that are more capital intense. On the left, the wage rate does not respond to changes in productivity. Consecutive technical changes shift the economy from point A to point B to point C with the same wage rate but increasing profit rate, $r_0 < r_1 < r_2$. This case is consistent with a subsistent wage regime. No further labor-saving technical changes will take place since it would contradict the viability condition.

In the right-hand graph in figure 2, the wage rate responds more than proportionally to productivity. The movement from point A to point B does not contradict the viability condition for individual capitalists as long as they do not anticipate that the wage rate will increase. This movement is similar to the one represented in figure 1 from point A to point C. Further technical changes always appear as viable and the economy would keep moving toward a very low profit rate and profit share given that labor power continues to be replaced by capital. Between the two cases represented in figure 2 (we would have the two other cases depicted in table 1), if $0 < \varphi < 1$ then technical change would bring some increase in the wage rate and decrease in the profit rate but would be limited since the viability constraint would eventually be reached.

Figure 2: Wage Response to a Labor-Saving Technical Change

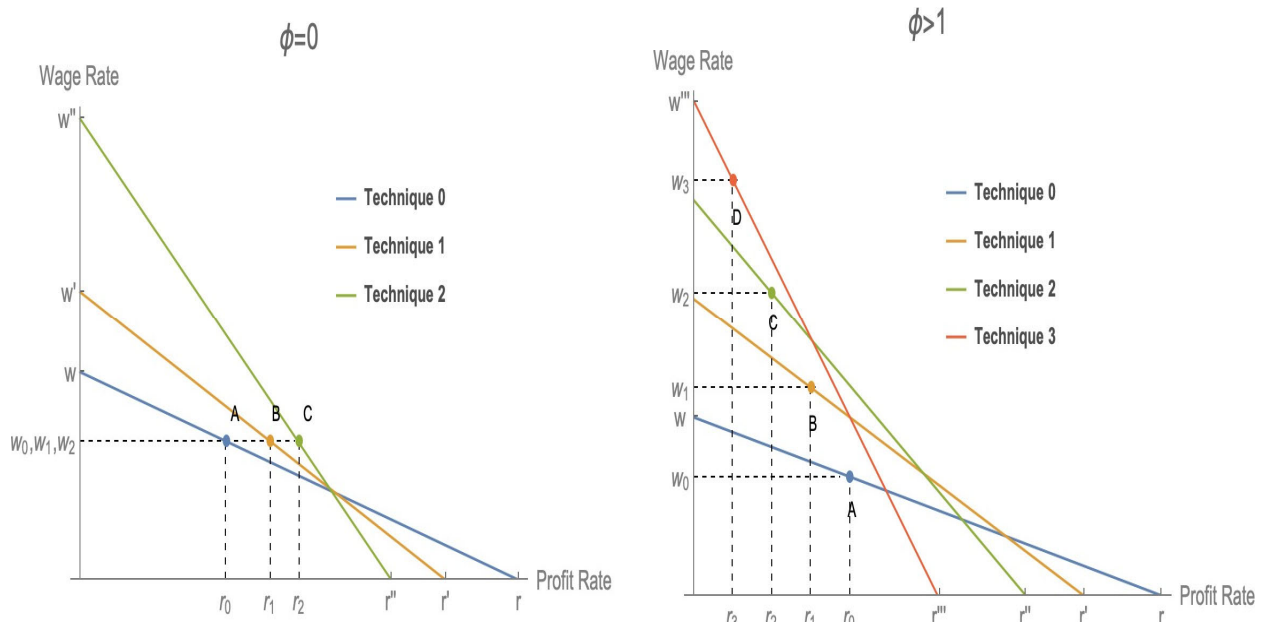

Like all other thought experiments within the long-period method, there are other layers that can be added into the reasoning. According to Foley (1986), the long-run tendency of the profit rate to fall would happen in a lower layer and other tendencies that could counteract this effect exist in a higher layer. Foley (1986) cites four countertendencies pointed out by Marx that can affect the general tendency of the profit rate to fall in a closed economy. All of those can be reinterpreted in terms of how they affect the real wage and make possible a wage rate that is decreasing, stagnating, or growing slower than productivity.

The choice of the term “countertendencies” to refer to these mechanisms is directly related to the belief that they pertain to a more concrete layer of abstraction. In terms of a model, this would impose a hierarchy for the equations, where the determination of the growth rate of the long-run profit rate depends on the behavior of wages with respect to changes in productivity, but not the contrary, i.e., the rate at which wages respond to productivity does not depend on the growth rate of the long-run profit rate. In section 4, I will propose, contrary to that, it is not possible to treat disruptions to the wage-setting functional form as exogenous shocks. The growth rate of wages is not autonomous from the growth rate of the profit rate; those variables should be determined simultaneously. Or, as will be argued later,

matters regarding the social sphere cannot be dissociated and do not supersede matters regarding the production sphere.

It is, nonetheless, essential to precede that with Marx's theories of the value of labor power, the reserve army of labor, and bargaining power. I present these concepts in the next section.

3. WAGES IN MARX: THE VALUE OF LABOR POWER, THE RESERVE ARMY OF LABOR, AND BARGAINING POWER

Marx assumes the labor theory of value in developing a theory of exploitation. The labor theory of value, present in Smith and Ricardo as well, states that all value comes from labor expended in production. Differently from Ricardo, Marx places his theory at the aggregate level and proposes that the value-producing labor is abstract, simple, social, and necessary (Foley 1986, 15). The value of a commodity is regulated by the abstract, socially necessary labor required to produce it.

Capitalists purchase labor power as a commodity in the market for a value, which monetarily takes the form of a wage. The wage gravitates around the value of labor power. Capitalists purchase the potential of workers to perform labor and not labor itself, which is the actual expenditure of energy in the production of commodities. The possibility that capitalists face for extracting surplus value comes from the fact that labor can create more value than what capitalists pay for.

It is useful to once again determine the laws that govern the variable of interest's center of gravitation at the most abstract level. Regarding wages, I will argue that Marx defines the center of gravitation as the value of labor power, which is the socially and historically determined average quantity of means of subsistence necessary for the workers. As will be extensively argued later, this does not mean that the center of gravity is fixed. The fact that this center is historically and socially defined makes class struggle the main subject of the analysis.

Marx conceptualizes the value of labor power and the money form that it takes (wages) in both chapter six and in part six of the first volume of *Capital*. The fact that labor power can be exchanged as a commodity is a consequence of the fact that workers are free in a double sense. First, workers own their

labor power and are free to dispose of it. This is not the case in other systems such as feudalism or under slavery. The second condition refers to the fact that workers are free of the means of production and rely on a wage contract to reproduce themselves. This second condition is the result of the process of primitive accumulation. Historically, this refers to the displacement of populations, land enclosure, and other processes that restrict peasants' access to common lands.

The fact that capitalists have command over the means of production while workers only dispose of their capacity to perform labor creates a symbiotic relationship with a power imbalance. Wage is defined here as a contract between the two parties that have opposing interests. Smith (1976, 74) points to this power imbalance:

What are the common wages of labour, depends everywhere upon the contract usually made between those two parties, whose interests are by no means the same. The workmen desire to get as much, the masters to give as little as possible. The former are disposed to combine in order to raise, the latter in order to lower the wages of labour. It is not, however, difficult to foresee which of the two parties must, upon all ordinary occasions, have the advantage in the dispute, and force the other into a compliance with their terms. [...] In the long run the workman may be as necessary to his master as his master is to him; but the necessity is not so immediate.

Smith identifies the source of the power imbalance and highlights the role that capitalists play in defining the terms of the contract. He also points to a contradiction faced by the capitalists, who, in the short run, can squeeze wages below the survival level; however, in the long run, capitalists need the workforce to reproduce themselves. This contradiction has major impacts on the gendered division of care work, as I will discuss later in this paper.

Figure 3: The Division of Social Labor Time between Necessary Labor and Surplus Labor

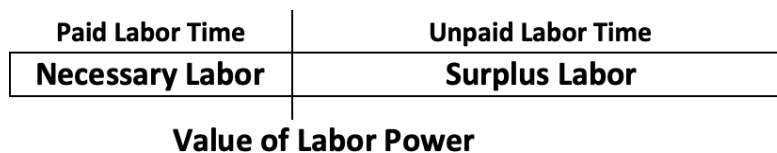

The distinction between labor and labor power is central to Marx's argument of exploitation. The fact that labor is able to produce more value than the value of labor power—the commodity sold by workers—is by no means a contradiction. Labor refers to a concrete activity performed in production that produces value, whereas labor power refers to a potential to produce value, which is the commodity sold by the worker to the capitalist. What governs the value of labor is quite different from what governs the value of labor power. The former is determined by the value of abstract socially necessary labor required to produce the commodity that objectifies the labor performed by the worker. The latter is determined by the value of abstract socially necessary labor required to produce the commodities that, on average, a worker needs to survive in a certain social and historical environment.

The fact that labor produces more value than the value of labor power has two direct consequences. First, there is surplus in production. Second, when workers enter a wage contract, they agree to take part in an unequal exchange. This is depicted in figure 3, where the total length of a working day is divided between the necessary labor, which regulates the value of labor power, and the surplus labor, which is appropriated by the capitalists.

Marx's theory of exploitation depends on accepting as fact that only labor produces value and that the value produced by the labor performed in a single day is not fully returned to the worker. The exploitation rate, also known as the rate of surplus value, is measured as the ratio between surplus value and wages. As can be seen in equation 2 in section 2.1 of this paper, changes in the rate of exploitation are important for explaining the direction of the changes in the profit rate, but they are not enough. Depending on the changes in the capital outlay and in the composition of capital, an increase in the rate of exploitation might not be enough to counterbalance the tendency of the profit rate to fall. In the long run, the changes in the composition of capital with respect to the rate at which wages respond to productivity will determine if an increase in the rate of exploitation is enough to counterbalance the long-run tendency of profit to fall.

The rate of exploitation alone cannot explain the final effect on the long-run profit rate, but, at the individual level, capitalists have an incentive to increase exploitation and extract a higher surplus value. There are a few mechanisms to do so. Relative surplus value relates to an increase in the intensity of work without a proportional increase in the necessary labor. Absolute surplus value relates to an increase

in the length of the working day without an increase in compensation. Therefore, it is not sufficient for the wage rate to not adjust to productivity for an increase in the exploitation rate to counteract the long-run falling rate of profit, but it is necessary.

It is then crucial to discuss how the value of labor power can change through time and how wages can oscillate around it. Marx conception of tendency and oscillation as statistical equilibrium processes is very explicit in the following passage of his address to the General Council of the First International² in June 1865 (Marx 1910, 67):

What then is the relation between value and market prices, or between natural prices and market prices? You all know that the market price is the same for all commodities of the same kind, however the conditions of production may differ for the individual producers. The market price expresses only the average amount of social labour necessary, under the average conditions of production, to supply the market with a certain mass of a certain article. It is calculated upon the whole lot of a commodity of a certain description. So far the market price of a commodity coincides with its value. On the other hand, the oscillations of market prices, rising now over, sinking now under the value or natural price, depend upon the fluctuations of supply and demand. The deviations of market prices from values are continual.

According to Baumol (1983), Marx's wage deviations from the value of labor power can be explained through the laws of labor market supply and demand, while the value of labor power would be socially and historically constituted through class struggle. Nonetheless, this leads to the conclusion that class struggle is explanatory of both the value of labor power as well as of the wage deviations from this. The term "class struggle," broadly used by Marx and Engels and adopted in Marxist literature, refers to this competition between the working class and the capitalist class for a share of income.

The existence of an element of dependency between the two classes is essential to explain how the class struggle plays out. More specifically, without understanding the nature of the dependency of one class on another, one cannot understand how much bargaining power each class has. Moreover, characterizing

² The First International, also known as The International Working Men's Association, was founded in September 1864 in London and its first congress was held in 1866 in Geneva. It was an international organization that united multiple left-wing groups and trade unions around the working class agenda. Marx and Engels were key figures in the association. For more on the history of the First International, see the Marxist Archives (2020).

bargaining power is necessary in order to study the dynamics of the competition and to determine the rate of exploitation.

Given that they are not producing value, the capitalist class depends on the workers to survive. As highlighted by the Smith quote presented above, the dependency of the capitalist class on the working class is not as urgent as the reverse. Since capitalists have accumulated capital, they can forgo production for a period without undermining their capacity to survive. The workers depend on capitalists to anticipate the means for their survival. They have been alienated from the tools and inputs that go into production. Therefore, the power of the capitalists lies in the fact that they own accumulated capital. The power of workers lies in the fact that they create value. The urgency is where the advantage in the bargaining power of the capitalist class lies.

To better understand where the bargaining power of workers comes from, it is useful to explore Marx's types of surplus population and his definition of a reserve army of labor presented in volume 1, chapter 25 of *Capital* (Marx 1996). Marx proposes that the surplus population that is not currently participating in the production sphere composes a reserve army of labor, which entails a floating reserve army, a latent reserve army, and a stagnant reserve army.

The floating reserve army is the population that is usually employed and depends on wage work but has been displaced. The size of the floating reserve army of labor depends, on the one hand, on capital accumulation that leads to a growing demand for labor for a given technique and, on the other hand, on the effects that a labor-saving technical change has on employment. When the composition of capital remains the same, accumulation leads to a decrease in the floating reserve army. When a more capital-intensive technique that increases labor productivity is implemented, the floating reserve army increases.

The latent reserve army refers to a population that has not been employed but can be pulled into the labor force. This usually refers to a population that is in a traditional agricultural sector or on a less developed region that is not fully integrated with the economy. Technical change again plays a role in the process of absorbing this population into the pool of workers. Marx points to the fact that the advancement of mechanized production allows for the employment of a broader range of the population. Women,

children, older people, or ethnic groups that have a low labor force participation rate are also part of the latent reserve army.

Finally, the stagnant reserve army refers to a population that exists at the margins of production and whose skills are not developed or obsolete (Foley 1986, 65).

The existence of a surplus population, together with the consequent competition between a latent and a floating reserve army, is important for explaining the fact that wages deviate from the socially determined standard of living only to a limited degree. A larger reserve army of labor would account for a lower bargaining power of workers, since there would be a higher supply of labor that can replace a worker. A fall in the wage below the value of labor power can happen in such a case. Contrarily, a smaller reserve army of labor strengthens workers' bargaining power.

3.1 Goodwin Model

These bargaining power dynamics are interestingly explained by Goodwin (1967) in his model of “predator and prey,” based on the Lotka-Volterra equation. In the model, progress leads to the accumulation of profits, which leads to an expansion of production. Through this expansion of production, the employment level increases, destroying the reserve army of labor and driving the bargaining power of workers up, which consequently decreases profits. In the short run, it is “the tendency of capital, though not capitalists, to breed excessively” that leads to fluctuations in the distribution of income (Goodwin 1967, 58). Specifically, Goodwin defines the wage dynamics, $\frac{\dot{w}}{w}$, and the employment dynamics as:

$$\frac{\dot{w}}{w} = -\gamma + \rho v$$

$$\frac{\dot{v}}{v} = \frac{l - u}{\theta} - (\alpha + \beta)$$

Where we can interpret γ and ρ as the bargaining power parameters, l is employment, $\frac{1}{\theta}$ is capital productivity, α is the growth rate of productivity, and β is the growth rate of the labor supply. Finally, u and v are the state variables wage share and employment rate, respectively.

Although Goodwin model's main interesting aspect is the formalization of Marx's description of capitalism as a contradictory system with booms and slumps as a result of the symbiotic relationship between workers and capitalists, for my purpose, it is interesting to reflect on his long-run equilibrium results.

Figure 4: Goodwin Cycle

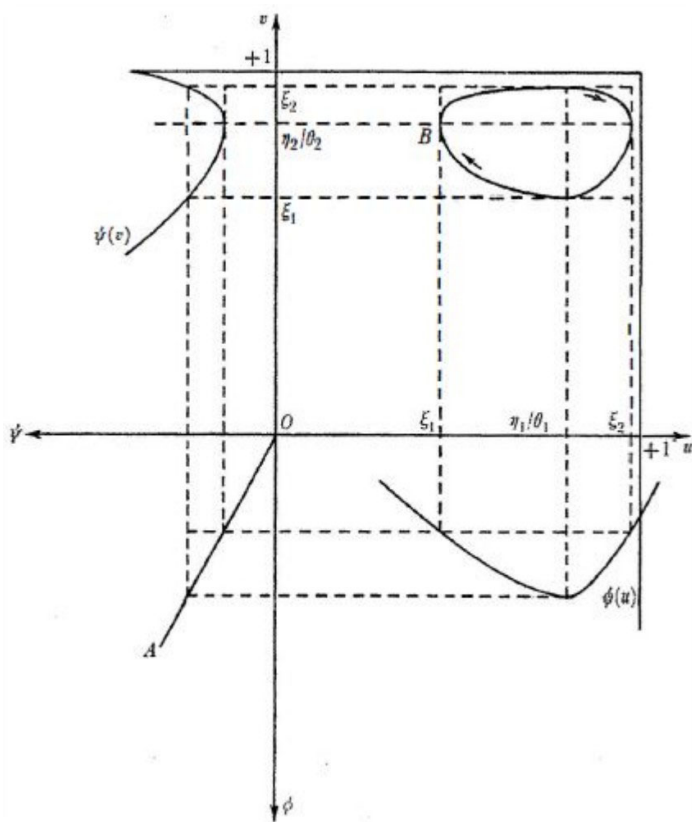

Source: Goodwin (1967, 57)

The long-run average distribution of income and the degree of unemployment are constant in Goodwin's formalization. Figure 4 replicates the original graphical representation of the model where u , represented on the x-axis, is the worker's share of product and v , represented on the y-axis, is the employment rate. The coordinate of the center of the cycle indicates the long-run equilibrium of those variables, which is also the average value. It is important to note that the long-run equilibrium of income distribution is not affected by shocks or the initial values of the state variables; they depend only on the parameters.

Specifically, in the long run, the wage share is equal to $1 - \frac{\alpha+\beta}{1/\theta}$ and the employment level is equal to $\frac{\gamma+\alpha}{\rho}$, where the bargaining power parameters affect the short-run distribution but in the long run can only affect the employment level. Shifts in the long-run distribution of income toward a higher wage share would only happen in the case of a fall in the growth rate of labor productivity or in the growth rate of labor supply, or if there is an increase in capital productivity. The short-run versus long-run implications of Goodwin's model are a result of the fact that the bargaining power parameters are fixed, therefore disruptions to the social order are exogenous shocks in the model.

The capitalists' long-run share of income is the residue of the wage share and therefore equal to $\frac{\alpha+\beta}{1/\theta}$, where the profit rate can be calculated by multiplying their share by capital productivity, and is equal to $\alpha + \beta$. Within the cycle, Goodwin also proposes a qualification regarding Marx's results, mentioned earlier in this paper, and points to the fact that profitability can be restored even if real wages are not falling, but if instead they do not rise with productivity.

So far, I have argued how changes in the reserve army of labor can lead to limited fluctuations in wages around the value of labor power. The next section will address the gendered aspects of the separation between production and reproduction. This investigation will allow me to determine to which layer of abstraction—a more or less concrete one—identity discrimination belongs and through which mechanisms it can offset the falling rate of profit.

4. MARX'S HIDDEN LAYER

Fraser (2014) investigates the defining features of capitalism according to Marx, arguing that it is behind the sphere of exchange, in the hidden sphere of production, that Marx finds the laws that govern the capitalist system. In Fraser's understanding, the sphere of production according to Marx can be defined through four distinctive characteristics. The first is the existence of private property, which, as I already mentioned, is a necessary condition for labor to be free of means of production, which is the second condition mentioned. From these conditions comes the fact that labor power is a commodity and that workers are exploited. The third feature is capital's drive for accumulation that, as I proposed earlier,

works through the dynamics of technical change. It is in the seeking of more profits that technical change takes place and, in the most abstract layer, leads to the ultimate contradictory result of a falling profit rate. Finally, the fourth feature is the role that markets play in allocating inputs and distributing outputs in the capitalist system.

Fraser goes on to argue against the predominantly held view that markets function to commoditize all aspects of life. This is necessary for her core argument that the coexistence of marketized and nonmarketized aspects of society is not coincident, but instead is a necessary condition for the functioning of capitalism.

When looking behind Marx's "hidden abode," Fraser finds a backstory of capitalism that she claims was taken as given by Marx, but far from being a given, it is necessary for the story he is telling as well as an ongoing process. Fraser shifts from the concept of exploitation and identifies a continuous process of expropriation.³

Different from the concept of exploitation that emerges from an unequal exchange, expropriation emerges from the appropriation by capital with no counterpart. This is not only part of the initial constitution of the system (i.e., not a primitive procedure) but also a recurring practice that is as important as exploitation for the process of accumulation. In this view, capital dynamics work through the exchange of unequal parts and through the appropriation of means that are relegated to the noneconomic sphere. The separation between the economic and noneconomic spheres is consequently necessary and endogenous to the accumulation process. Fraser identifies three major structural divisions in this hidden layer of the capitalist system: the first is the separation between commodity production and social reproduction; the second is the separation between a natural realm and an economic realm; and the third is a separation between political power and economic power.

Accepting the argument that such separations are constitutive features of capitalism naturally leads me to agree with Fraser's claim that in order to fully understand the functioning of the capitalist system it is necessary to take into account this hidden layer and to incorporate a Marxist framework with the feminist, ecological, and political-theoretical perspectives.

³ As she mentions, this point has been stressed by Harvey (2005).

This paper is my attempt to incorporate the Marxist framework with the feminist perspective in order to understand how the noneconomic sphere produces the conditions for the functioning of the economic sphere. Finally, since it is argued that expropriation is a necessary condition for the continuation of the accumulation process, it is also necessary to take into account the possibility that the recreation of such conditions are endogenous to the process of accumulation.

Concretely, instead of taking identity discrimination as a precondition that creates an opportunity for capital accumulation, I want to follow the idea that the structure of capitalism functions to recreate this condition. This is done by dividing “populations in ways that correlate with, and fabricate, race” (Fraser 2016). This allows capitalism to create identity categories that are subject to expropriation. Next, I will focus on the case of gender to investigate how it effects the accumulation process.

4.1 Expropriation and Gender

Having established that identity categories are fabricated, I start with a definition of gender consistent with this. Butler (1988) states that gender is “an identity instituted through a stylized repetition of act.” The female gender, as a historical social category, is associated with a specific view of femininity. According to Federici (2004, 103), there has been a change in the perception of femininity that began at the “end of the 17th century, after women had been subject for more than two centuries to state terrorism.” The new model of femininity that emerged was of “the ideal woman and wife—passive, obedient, thrifty, of few words, always busy at work, and chaste.” In this conception, the 17th century witch hunts can be understood as primitive accumulation, and the expropriation of women “is written in the annals of mankind in letters of blood and fire” (Marx 1996: ch. 26)

Figure 5: The Value of Labor Power with Unpaid Labor

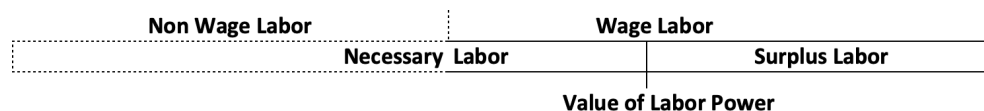

Much like the claim that workers are exploited depends on the acceptance that there is an unequal exchange between capitalists and workers, the claim that women are expropriated depends on establishing that capital appropriates what belongs to women. Or, as Delphy (2012) puts it, to talk about

women’s oppression, one cannot accept the notion of a feminine condition. Instead, one needs to take the perspective of the oppressed. From the perspective of women, the appropriation of domestic work by capitalism without a counterpart is expropriation. Furthermore, the separation of the reproduction sphere from the economic sphere, which relegates social reproduction to women and warrants capital the right to appropriate it, is a process of primitive accumulation.

A revised version of the scheme depicted in figure 3 would look like figure 5, which extends the length of the necessary labor to encompass social reproduction work. Part of the necessary labor is compensated for through an unequal exchange in the market, and another part is relegated to the nonmarket sphere. This scheme leads to the conclusion that the rate of exploitation does not fully grasp the degree to which the exchange between labor power and the product of labor is unequal.

Nonetheless, it is only by taking it one step further that I can argue that it is not the size of the rate of exploitation that needs revision, but rather the fitting of it to describe the process. Figure 6 proposes that the gendered aspect of the division between nonwage and wage necessary labor needs to be taken into account. This sharp separation of the two parts of necessary labor can be taken as representative of an idealized version of the breadwinner-family regime, whose constitution is discussed in the next section.

Figure 6: Gendered Division of Wage and Nonwage Necessary Labor

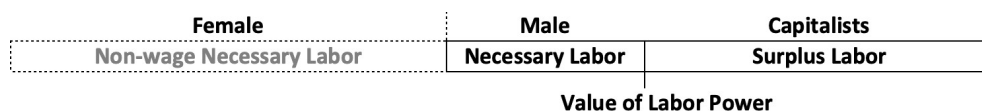

4.2 Gendered Aspects of Workers’ Necessary Wants

Marx’s economic analysis is focused on the market that emerged from the Industrial Revolution. The drastic difference between females and males in terms of access and treatment in the post-Industrial Revolution market cannot be ignored in such analysis. Nonetheless, Marx leaves this matter in the background. It is during Marx’s analysis of the surplus population and the dynamics between the active workforce and the latent reserve army, as well as during his discussion about displacement by machinery, that the matter of women and children in the labor force emerges. His understanding of the

main determinants of wages in the period are centered on a social and historical conception of a minimum necessary for the worker to reproduce himself. In volume 1, chapter 6 of *Capital*, regarding the determinants of the value of labor power, he says:

His means of subsistence must therefore be sufficient to maintain him in his normal state as a labouring individual. His natural wants, such as food, clothing, fuel, and housing, vary according to the climatic and other physical conditions of his country. On the other hand, the number and extent of his so-called necessary wants, as also the modes of satisfying them, are themselves the product of historical development, and depend therefore to a great extent on the degree of civilization of a country, more particularly on the conditions under which, and consequently on the habits and degree of comfort in which, the class of free labourers has been formed. In contradiction therefore to the case of other commodities, there enters into the determination of the value of labour-power a historical and moral element.

Marx clearly recognizes the importance of historical and social aspects in the determination of the level of workers' necessary labor. He is also clear in stating that much like with the rate of profit, wages do not fluctuate around a fixed average and there is also change in the average's tendency. This point is stressed in his address to the General Council of the First International (Marx 1910, 118–19): “By comparing the standard wages or values of labour in different countries, and by comparing them in different historical epochs of the same country, you will find that the value of labour itself is not a fixed but a variable magnitude, even supposing the values of all other commodities to remain constant. A similar comparison would prove that not only the market rates of profit change, but its average rates.”

A reading of these two passages is consistent with Fraser's understanding that the separation between the economic and noneconomic aspects of production is intrinsic to the functioning of capitalism. Thus, I propose bringing forward the story behind such social and historical aspects. Concretely, I will focus on how the separation between the spheres of production and social reproduction is constitutive of the specific value that labor power takes socially and historically.

4.2.1 The Value of Labor Power under the “Breadwinner” Norm

Secombe (1986) criticizes Hobsbawn (1964) for ignoring women and children in his investigation of wage changes in the 19th century. Secombe's point is not that the determinants of the level of wages would be obliterated, but rather that the process of change itself depends on a different side of the story. He claims that there is an important transformation of wage relations in the mid-19th century, shifting

the norms within the family from a joint income to what became known as the “breadwinner norm.” What is most striking about Seccombe’s study is the important role attributed to a conservative labor movement in the consolidation of the male breadwinner norm during this time.

The norm at that time, inherited from a Victorian model, emphasized women’s “qualities of personal nurturance and their civilizing influence on husbands and children” (Folbre 1991). Folbre also points out to the role of male trade unionists in reinforcing this model of femininity and the challenge that a disruption of the model would create. If not women, who would take the responsibilities for the domestic work?

This model created an obstacle for proletarian women, who did not have the choice to conform to this ideal of femininity. Instead, they entered the labor market and suffered wage discrimination. Babbage (1835) reported those wage differentials in the first half of the 19th century through the share by sex and age: “It is usual for a man, his wife, and a child, to join in performing these processes; and they are paid at the rate of five farthings per pound. They can point from thirty-four to thirty-six and a half pounds per day, and gain from 6s. 6d. to 7s., which may be apportioned thus; 5s. 6d. the man. 1s. the woman, 6d. to the boy or girl.”

The social norm imposed that the necessary wants of a women worker was that of a complement of a male wage. This meant that women’s social value of labor power was smaller than that of men. Marx is not blind to this and in *Capital*, volume 1, chapter 15 he claims:

The value of labour-power was determined, not only by the labour-time necessary to maintain the individual adult labourer, but also by that necessary to maintain his family. Machinery, by throwing every member of that family on to the labour-market, spreads the value of the man’s labour-power over his whole family. It thus depreciates his labour-power. To purchase the labour-power of a family of four workers may, perhaps, cost more than it formerly did to purchase the labour-power of the head of the family, but, in return, four days’ labour takes the place of one, and their price falls in proportion to the excess of the surplus-labour of four over the surplus-labour of one. In order that the family may live, four people must now, not only labour, but expend surplus-labour for the capitalist. Thus we see, that machinery, while augmenting the human material that forms the principal object of capital’s exploiting power, at the same time raises the degree of exploitation.

Figure 7: Differences in the Value of Labor Power

	Female Value of Labor Power		
Female	Non-wage Necessary Labor	Necessary Labor	Surplus Labor
Male	Non-wage Necessary Labor	Necessary Labor	Surplus Labor
	Male Value of Labor Power		

4.2.2 Equalization Process

A few different aspects are interesting about the above passage. First, the wage differential in this case is not the result of a deviation from the value of labor power, but it arises from a difference in the socially necessary labor. This has different implications. For unmarried and widowed women it meant an obstacle in attaining a subsistence level through wage work. For men established in the workforce it meant a threat on their own wage. For capitalists it meant a source for increasing surplus value.

Second, Marx states that the employment of women and children exerts pressure on male labor power, assuming there is a process of equalization. The third interesting claim, which cannot be dissociated from the second, is that the introduction of machinery is a catalyst for this process, implying that the equalization of the value of labor power is a consequence of technical change, and that the determination of the value of labor power is endogenous to the process of accumulation.

Finally, I want to propose that this process of equalization of the value of labor power ties together the productive and reproductive spheres. Class struggle, which is the mechanism through which this equalization happens, is motivated not only by a dispute over the share of income but also by a dispute regarding the division of time devoted to the production of the nonwage necessary labor. Marx is not blind to the impacts of the employment of women in providing domestic work and states that what happens in the reproductive sphere also plays a role in the determination of the value of labor power. In a footnote in *Capital*, volume 1, chapter 15 he claims:

The numerical increase of labourers has been great, through the growing substitution of female for male, and above all, of childish for adult labour. Three girls of 13, at wages of from 6 shillings to 8 shillings a week, have replaced the one man of mature age, of wages varying from 18 shillings to 45 shillings.? (De Quincey, 1844, Note to p. 147). Since certain family functions, such as nursing and suckling children, cannot be entirely suppressed, the mothers confiscated by capital, must try substitutes of some sort. Domestic work, such as sewing and mending, must be replaced by the purchase of ready-made articles. Hence, the diminished expenditure of labour in the house is accompanied by an increased expenditure of money. The cost of keeping the family increases, and balances the greater income. In addition to this, economy and judgment in the consumption and preparation of the means of subsistence becomes impossible.

5. RECONCILING INTERSECTIONAL POLITICAL ECONOMY AND SOCIAL REPRODUCTION THEORY

Social reproduction theory is the most prominent critique of Marxist theory within the economics discipline. It is a result of an attempt to look into the capitalist system of production of commodities from a woman's perspective. One of the main consequences of this point of departure is that nonwage and wage necessary labor cannot be dissociated from each other.⁴

The difficulty of separating the production and reproduction spheres leads to a problem with any attempt to review the value of a labor power scheme, such as in figure 8. It is impossible to have a discussion of an equalization process of the value of labor power by solely focusing on the marketized production sphere.

When individual profit-seeking capitalists implement technical change, the population flows from the latent reserve army into the active workforce. In the case of gender, the maintenance of the social equilibrium through a division of wage and nonwage labor is disrupted by technical change. This is not simply a process of osmosis where the latent surplus population is absorbed into a growing system. It is a dialectical process, through the interactions of a market and nonmarket sphere, of a capitalist class and a

⁴ A good reader on social reproduction theory is Bhattacharya (2017)

working class, and of an active work force and a latent reserve army. Those three dialectical processes are themselves intertwine, and feed into each other.

Figure 8: The Equalization of the Value of Labor Power

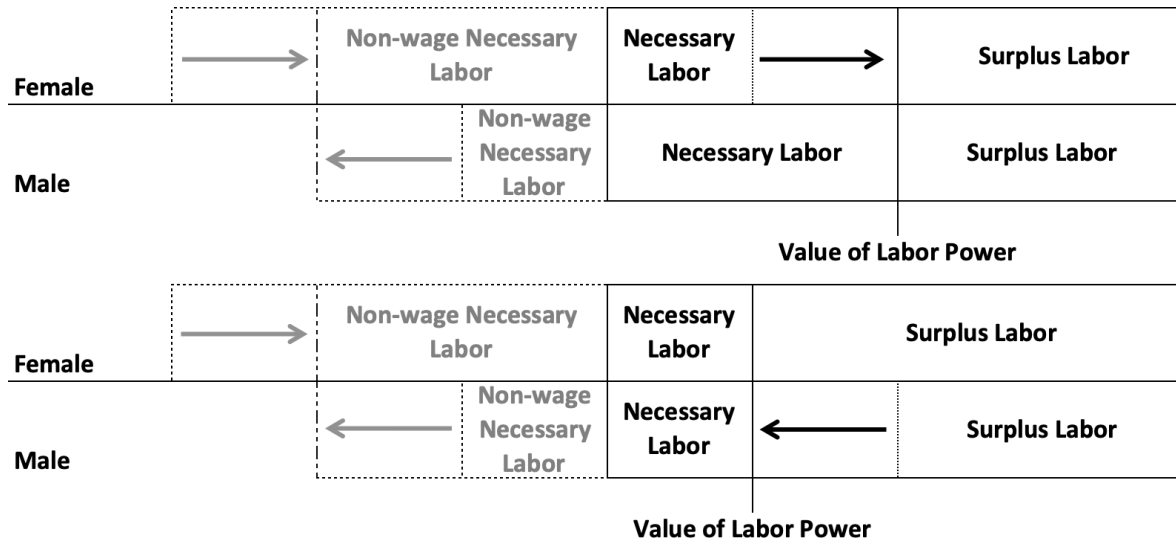

This works as follows. The latent surplus population is always potentially part of the marketized economy but relegated to a nonmarketized sphere. The apparent separation between the marketized and nonmarketized spheres is a necessary condition for expropriation of that population, as long as they don't enter the active workforce. But, given the impossibility of actual separation between the two spheres, capital encounters a contradiction—by using the latent reserve army to lower the average value of labor power, it constrains the possibility of expropriation. This contradiction is also felt by the active working class, who suffers from a pressure that pushes the value of their labor power to fall, as well as a crisis in the provision of their nonwage necessary labor. This accentuates the struggle between the latent reserve army and the active workforce and decreases the overall bargaining power of the working class, creating a disadvantage for all in a struggle against the capitalist class.

Concretely, regarding gender, the entrance of women into the labor force creates a downward pressure on the operating average value of labor power, but also introduces a crisis in the reproductive sphere. Individual capitalists are able to obtain super profits in the short run through this strategy but the effect of this would be that the ultimate average value of labor power needs to be higher than the average between male and female labor, unless the new social order is such that a family's standard of living is

lower. Hence, individual income of the newcomers to the labor market will increase, the individual income of the established labor force will decrease, and the effect's final result on their average income will depend on the dynamics of class struggle. The division within the working class shifts the focus of struggle toward internal disputes and gives an advantage to the capitalist class in the final establishment of the new social value of labor power.

As mentioned before, the motivation of male workers is not only a matter of the productive sphere. The interactions within the private sphere are extremely important, with the division of the domestic work being one part of this story. Nonetheless, as Veblen (1899) points out, men have motivations for maintaining the social structure. Regarding the patriarchal structure of society, he says: "According to this view, the patriarchal household, or, in other words, the household with a male head, is an outgrowth of emulation between the members of a warlike community. It is, therefore, in point of derivation, a predatory institution. The ownership and control of women is a gratifying evidence of prowess and high standing."

As a result of the process of accumulation, a crisis emerges, increasing the tension between the production and reproduction spheres and creating a disturbance in a power relations within households. Regarding this crisis, Fraser (2017, 25) states:

This is the general social-crisis tendency of capitalism as such. However, capitalist society does not exist "as such," but only in historically specific forms or regimes of accumulation. In fact, the capitalist organization of social reproduction has undergone major historical shifts—often as a result of political contestation. Especially in periods of crisis, social actors struggle over the boundaries delimiting economy from society, production from reproduction, and work from family—and sometimes succeed in redrawing them. Such boundary struggles, as I have called them, are as central to capitalist societies as the class struggles analyzed by Marx.

As suggested before, class struggle happens in two strata: a classic workers versus capitalists struggle and a within working class struggle. Fraser (2017) proposes that the first of these struggles is the one analyzed by Marx in *Capital*, volume 1, chapter 6 and calls the second one "boundary struggles." Fraser presents this concept as a critique to a blind spot in Marx; nonetheless boundary struggles are present in Marx's analysis in multiple instances. The problem is not that Marx is blind to the existence of this dispute; the competition between the active workforce and the latent reserve army is central to Marx's determination of bargaining power. Nonetheless, he seems to implicitly suggest that boundary struggles

play a secondary role in the accumulation process, as is particularly clear in the passage from Marx and Engels (2016, 23) replicated in section 1 of this paper.

I deem it necessary to make this distinction between two types of class struggle more subtle and instead consider them as two aspects of class struggle—one related to a between-classes element and another to a within-class element. Furthermore, I propose that a reconciliation of Marxist theory and social reproduction theory is impossible without conceptualizing together these two aspects of class struggle. This would make it possible to interpret the historical evidence that male trade unionists played a crucial role in the shift toward the breadwinner norm as an example of class struggle consistent with Marx’s theory.

As an example, the following letter from the Printer’s Union in 1854 highlights how the social view of gender, as well as the potential impact of women’s entrance in the labor market in the regulating wage, influenced their position regarding the employment of women:

TO THE EDITOR OF THE PHILADELPHIA DAILY NEWS FROM PRINTERS’ UNION, 1854: The printers of the United States have uniformly opposed the introduction of women into printing offices for the following natural reasons: That females can be employed at rates much lower than we demand and are properly entitled to, and as a consequence employers would use them for the subversion of our national organization. (Baxandall et al. 1995)

What is striking about the letter is the understanding that the lower social value of labor power of women derives from natural reasons. Labor union views can be taken as historic substantiation of class struggles. The incorporation of a view of a certain historical order that is convenient for the interests of capitalists into the labor unions’ claims shows this feedback effect of the two aspects of class struggle. This incorporation of a social order is not a matter of blindness or lack of consciousness of the workforce; it is rather the expression of the threat that the disruption of a social order meant to the working class. On the one hand, it imposes an income loss; on the other, it creates a crisis in the reproduction sphere. Thus, regarding the gender division between nonwage necessary labor and wage necessary labor, “capitalists are beneficiaries, but they are not the only ones. Men also benefit from women’s specialization in care provision.” (Folbre, n.d.)

Only in light of these two fronts of threat that women's employment imposes can one fully understand why labor unions took a normative conservative stance. This is even more striking in the following statement from Edward O'Donnell, secretary of the Boston Labor Union in 1897:

The growing demand for female labor is an insidious assault upon the home; it is the knife of the assassin, aimed at the family circle—the divine injunction. It debars the man through financial embarrassment from family responsibility, and physically, mentally and socially excludes the woman equally from nature's dearest impulse. [...] The wholesale employment of women is demoralizing them, or stripping them of that modest demeanor that lends a charm to their kind.”
(Baxandall et al., 1995)

Hence, labor unions effectively work as a conservative force against the interest of individual capitalists while counterbalancing the falling rate of profit, delaying the possibility for individual capitalists to collect super profits and softening the final effect that the social order disruption will have on the average rate of profit.

The strategies that labor unions use at moments of disruption are decisive in determining the final effect that a technical change will have on the rate of profit. If the expectation is that the composition of capital will be uniform across the economy, the final result of a conservative stance from unions will be a temporary gain for workers coupled with a loss in the long run. Unable to maintain the social order nor to maintain a wage differential, and without a cohesive front against capitalists, the final average of labor power will adjust toward that of the newcomers.

Allowing for unequal composition of capital across the economy leads to an even more interesting conclusion. In that case, the new social order that is established maintains gender segregation, but it is now spread out through occupations, with women specializing in low paying jobs and men in high paying jobs. Botwinick (2018) presents a consistent theory of persistent wage inequalities based on a Marxist framework and on the understanding of capitalism as a system regulated by real competition, as opposed to the neoclassical perfect competition and the heterodox imperfect competition frameworks. As a consequence of relying on this framework, he arrives at the conclusion that wage inequalities are neither a result of individual skills differentials nor a result of imperfect competition, but a systematic result of the laws of competition and accumulation.⁵

⁵ This result is also consistent with evidence that wage and income inequality does not reflect differences in skill (e.g., Darity

Finally, a move from the analysis restricted to gender to an intersectional perspective would impose one more complication on the resolution of class struggles to the advantage of workers. In order to succeed in the long run as a class, the working class would need to be able to reach a class consciousness that extrapolates the boundaries of the active working class itself, otherwise any group within the working class that holds a privilege would act as a conservative force and newcomers would only be able to succeed at the cost of another group temporarily and to the advantage of capitalism in the long run. One expression of this is Fraser's conclusion that liberal feminism "may dissolve the solidary ethical basis of social protection and can thereby foster marketization" (Fraser 2013, 16).

6. CONCLUDING REMARKS

In this paper I proposed a reconciliation between feminist social reproduction theory and the theory of the falling rate of profits in Marx. The investigation led me to the conclusion that two dimensions of class struggle play crucial roles in delimiting the historically and socially determined value of labor power. Therefore, the competition between a latent reserve army and an active workforce and not only the classic class struggle between the working class and capitalist class need to be taken into account to understand the process of capital accumulation. Assuming that the fabrication of identity categories pertains to a social sphere that exogenously affects the production sphere leads to either a contradiction within the Marxist theory of capital accumulation or a problem of reconciliation between theory and historical evidence. The only way of consistently joining a Marxist framework with a feminist framework is, therefore, by understanding the fabrication of gender as a process endogenous to capital accumulation.

Furthermore, this investigation refuted the assumption that the most abstract layer of the capitalist system lies within the economic sphere. The social normative system needs to be fully incorporated in the analysis, leading to the conclusion that the noneconomic and economic aspects of capitalism symbiotically compose its backstory. In this respect, exploitation would not be a countertendency to the laws that govern accumulation, but part of the most abstract laws, intrinsic to the reproduction of the system.

and Mason [1998] and dos Santos and Wiener [2020]).

This leads to the conclusion that the main contradiction of capitalism might not be found in the economic sphere but in the noneconomic one. Therefore, accumulation would not lead to the self-implosion of the system through an economic crisis, but through a social, ecological, and political crisis. The evidence around us makes it very hard to refute this conclusion.

On a positive note, the rupture of the social order carries an opportunity for action. The final result depends on the capacity of workers to overcome individual interests and act collectively to achieve a new social order that could finally tilt the scale in favor of all strata of the working class.

REFERENCES

- Babbage C. 1835. *On the Economy of Machinery and Manufactures*. London: Charles Knight.
- Baumol, W. J. 1983. "Marx and the iron law of wages." *The American Economic Review* 73(2): 303–8.
- Baxandall, R., R. F. Baxandall, L. Gordon, and S. Reverby. 1995. *America's working women: A documentary history, 1600 to the present*. New York: WW Norton and Company.
- Bhattacharya, T. 2017. *Social reproduction theory: Remapping class, recentering oppression*. London: Pluto Press.
- Botwinick, H. 2018. *Persistent inequalities: wage disparity under capitalist competition*. Boston: Brill.
- Butler, J. 1988. "Performative acts and gender constitution: An essay in phenomenology and feminist theory." *Theatre Journal* 40(4): 519–31.
- Darity, W. A., and P. L. Mason. 1998. "Evidence on discrimination in employment: Codes of color, codes of gender." *Journal of Economic Perspectives* 12(2): 63–90.
- Delphy, C. 2012. "For a materialist feminism." In R. Hennessy (ed.), *Materialist feminism and the politics of discourse*. Abingdon, UK: Routledge.
- De Quincey, T. 1844. *The logic of political economy*. Edinburgh: William Blackwood and Sons.
- dos Santos, P. L., and N. Wiener. 2020. "By the content of their character? discrimination, social identity, and observed distributions of income." *The Journal of Mathematical Sociology* 44(1): 14–41.
- Federici, S. 2004. *Caliban and the witch*. New York: Autonomedia.
- Folbre, N. (n.d.). personal communication.
- . 1991. "The unproductive housewife: Her evolution in nineteenth-century economic thought." *Signs: Journal of Women in Culture and Society* 16(3): 463–84.
- Foley, D. K. 1986. *Understanding capital: Marx's economic theory*. Cambridge, MA: Harvard University Press.
- Foley, D. K., and T. R. Michl. 1999. *Growth and distribution*. Cambridge, MA: Harvard University Press.
- Fraser, N. 2013. *Fortunes of feminism: From state-managed capitalism to neoliberal crisis*. London: Verso Books.

- . 2014. “Behind Marx’s hidden abode for an expanded conception of capitalism.” *New Left Review* 86: 55–72.
- . 2016. “Expropriation and exploitation in racialized capitalism: a reply to Michael Dawson.” *Critical Historical Studies* 3(1): 163–78.
- . 2017. “Crisis of care? On the social-reproductive contradictions of contemporary capitalism.” In T. Bhattacharya (ed.), *Social Reproduction Theory: Remapping Class, Recentering Oppression*. London: Pluto Press.
- Goodwin, R. M. 1967. “A growth cycle.” In C. H. Feinstein (ed.), *Socialism, capitalism and economic growth*. Cambridge, UK: Cambridge University Press.
- Harvey, D. 2005. *The new imperialism*. Oxford: Oxford University Press.
- Hobsbawn, E. 1964. *Labouring men: Studies in the History of Labour*. London: Weidenfeld and Nicolson.
- Malthus, T. R. 1986. “An essay on the principle of population. 1798.” *The Works of Thomas Robert Malthus*. London: Pickering and Chatto Publishers.
- Marx, K. 1910. *Value, price, and profit*. Chicago: CH Kerr and Company.
- . 1996. “Capital, volume 1.” *Marx–Engels collected works*, vol. 35. New York: International Publishers.
- Marx, K., and F. Engels. 2016. *The communist manifesto*. London: Verso Books.
- Marxist Archives. 2020. “History of the International Workingmen’s Association.” Available at: <https://www.marxists.org/history/international/iwma/index.htm>. Accessed June 4, 2020.
- Michl, T. R. 1999. “Biased technical change and the aggregate production function.” *International Review of Applied Economics* 13(2): 193–206.
- Okishio, N. 1977. “Notes on technical progress and capitalist society.” *Cambridge Journal of Economics* 1(1): 93–100.
- Ricardo, D. 1891. “On the Principles of Political Economy and Taxation” London: Bell & Sons.
- Secombe, W. 1986. “Patriarchy stabilized: the construction of the male breadwinner wage norm in nineteenth-century Britain.” *Social History* 11(1): 53–76.
- Shaikh, A. 2016. *Capitalism: Competition, conflict, crises*. Oxford: Oxford University Press.
- Smith, A. 1976. *An Inquiry into the Nature and Causes of the Wealth of Nations*. Chicago: University of Chicago Press.

Veblen, T. 1899. "The barbarian status of women." *American Journal of Sociology* 4(4): 503–14.