

Bellenbaum, Julia; Höckner, Jonas; Weber, Christoph

Working Paper

Designing flexibility procurement markets for congestion management: Investigating two stage procurement auctions

HEMF Working Paper, No. 10/2019

Provided in Cooperation with:

University of Duisburg-Essen, Chair for Management Science and Energy Economics

Suggested Citation: Bellenbaum, Julia; Höckner, Jonas; Weber, Christoph (2019) : Designing flexibility procurement markets for congestion management: Investigating two stage procurement auctions, HEMF Working Paper, No. 10/2019, University of Duisburg-Essen, House of Energy Markets & Finance (HEMF), Essen, <https://doi.org/10.2139/ssrn.3502769>

This Version is available at:

<https://hdl.handle.net/10419/234064>

Standard-Nutzungsbedingungen:

Die Dokumente auf EconStor dürfen zu eigenen wissenschaftlichen Zwecken und zum Privatgebrauch gespeichert und kopiert werden.

Sie dürfen die Dokumente nicht für öffentliche oder kommerzielle Zwecke vervielfältigen, öffentlich ausstellen, öffentlich zugänglich machen, vertreiben oder anderweitig nutzen.

Sofern die Verfasser die Dokumente unter Open-Content-Lizenzen (insbesondere CC-Lizenzen) zur Verfügung gestellt haben sollten, gelten abweichend von diesen Nutzungsbedingungen die in der dort genannten Lizenz gewährten Nutzungsrechte.

Terms of use:

Documents in EconStor may be saved and copied for your personal and scholarly purposes.

You are not to copy documents for public or commercial purposes, to exhibit the documents publicly, to make them publicly available on the internet, or to distribute or otherwise use the documents in public.

If the documents have been made available under an Open Content Licence (especially Creative Commons Licences), you may exercise further usage rights as specified in the indicated licence.



House of
Energy Markets
& Finance

Designing flexibility procurement markets for congestion management – Investigating two stage procurement auctions

HEMF Working Paper No. 10/2019

by

Julia Bellenbaum,

Jonas Höckner

and

Christoph Weber

November 2019

UNIVERSITÄT
DUISBURG
ESSEN

Open-Minded

Designing flexibility procurement markets for congestion management – Investigating two stage procurement auctions by Julia Bellenbaum, Jonas Höckner and Christoph Weber

Abstract

Increasing infeed from renewable energy sources poses considerable challenges to system operators who are in charge of power system reliability. Accordingly, the frequency of network congestion and the corresponding congestion management costs have increased dramatically over the last years and give reason to extensively discuss alternative approaches. Among these, flexibility markets bear the potential to complement existing congestion management practices by incentivizing decentralized resources with large potentials of flexibility to participate in relieving congestion. For this reason, multiple demonstration projects across Europe are currently testing different flexibility market designs.

We contribute to this on-going discussion by investigating the auction design of such a flexibility market. We analytically derive the optimal procurement strategy of a SO within a flexibility market platform, recurring to the well-established methodology of the classical Newsvendor problem and extending it in a stochastic programming framework with two stages. We apply our model to a case study of a transformer that is frequently congested due to high infeed from wind farms. Based on an analysis of relevant sources of flexibility, differentiated concerning lead time and cost structure, we explore the effects of demand uncertainty and information updates between auctions. The results of the case study, including a comprehensive sensitivity analysis, reveals insights that are used to provide policy advice on how to design flexibility procurement markets under specific conditions.

Julia Bellenbaum
(CORRESPONDING AUTHOR)
House of Energy Markets and Finance
University of Duisburg-Essen, Germany
Universitätsstr. 12, 45117 Essen
+49-(0)201 / 183-7383
Julia.Bellenbaum@uni-due.de
www.hemf.net

Jonas Höckner
House of Energy Markets and Finance
University of Duisburg-Essen, Germany
Jonas.Hoeckner@uni-due.de

Christoph Weber
House of Energy Markets and Finance
University of Duisburg-Essen, Germany
Christoph.Weber@uni-due.de

The authors are solely responsible for the contents which do not necessarily represent the opinion of the House of Energy Markets and Finance.

Contents

Abstract	I
1 Introduction	2
2 Literature	3
3 Model	5
3.1 Model set-up	6
3.2 Two-stage optimal procurement strategy	7
4 Application	10
4.1 Description of the reference case (case A)	11
4.1.1 Parametrization of flexibility demand in the reference case	11
4.1.2 Parametrization of flexibility supply in the reference case	13
4.2 Description of further cases	15
4.3 Results of different cases	17
4.3.1 Optimal procurement strategies	17
4.3.2 Resulting Costs	19
4.4 Sensitivity analysis of different parameters on model results	20
4.4.1 Costs parameters	21
4.4.2 Information update and level of initial uncertainty	23
5 Conclusion	24
6 Acknowledgements	26
7 Literaturverzeichnis	III
Appendix	VI

1 Introduction

In the zonal market design, typically implemented in European countries, congestion management is applied in order to relieve internal congestion. Increasing infeed from renewable energy sources (RES) poses considerable challenges to system operators (SOs) who are in charge of power system reliability. E.g. in Germany, the transmission grid is currently not capable to transport high volumes of wind power generated in the North to the load centres in the South due to delayed network expansions. Moreover, high shares of RES are connected to the distribution grid and cause critical backflows from the distribution grid to the transmission grid in periods of high RES infeed. Consequently, the frequency of network congestion and the corresponding congestion management costs have increased dramatically over the last years¹ and give reason to extensively discuss alternative approaches. Among these, flexibility markets bear the potential to complement existing congestion management practices by incentivising decentralized resources with large potentials of flexibility to participate in congestion management.

Such market-based approaches require an efficient market design to mobilise sufficient flexibility sources on the supply side and to deal with uncertain flexibility demand. For this reason, multiple demonstration projects across Europe are currently testing different flexibility market designs.² So far, various market design issues are still in discussion (Radecke et al. 2019). We contribute to this on-going discussion by examining the impact of the auction design choice based on the optimal procuring strategy of a SO who relies on forecasts of the flexibility need. Therefore, following the approach taken in the on-going large-scale Smart Grid demonstration project enera (Höckner et al. 2019b), we subsequently assume a regional flexibility market platform in the context of a European power market design, on which the SO – as a monopsonist – procures regional flexibility to alleviate network congestion. Here, technical and economic restrictions of the flexibility options are relevant to organise an appropriate time schedule. Hence, the flexibility market is to take place within a time interval before the expected congestion that is limited by applicable forecasts on potential congestion in the system on the one hand and a lead time that allows suppliers to balance the deviation from their scheduled positions or that is required due to technical restrictions on the other hand.

Similar to conventional electricity markets, flexibility markets can be designed to trade flexibility either auction-based or continuously, where the latter option may be represented by a series of consecutive auctions (cf. e.g. Kyle 1985; Deutsche Börse 2017). According to Neuhoff et al. (2016), auctions have the advantage of aggregating liquidity as all participants are required to

¹ The congestion management costs in Germany increased from approx. 58 million Euros in 2010 to 1550 million Euro in 2017 (bdew 2018).

² A summary of different demonstration projects can be found in Radecke et al. 2019.

place their bids simultaneously. However, a diversity of suppliers in terms of required lead time implicates that two or more auctions broaden the range of flexibility supply and help suppliers to place their bids at the individually optimal stage. This is a precondition for the SO to efficiently exploit the existing flexibility options.

In this paper, we analytically derive the optimal procurement strategy of a SO within a flexibility market platform, recurring to the well-established methodology of the classical Newsvendor problem and extending it in a stochastic programming framework to two stages. As discussed in more detail in section 2, we build on findings derived in the context of inventory theory and supply chain management that have already been applied to staged electricity procurement by a load serving entity (LSE) subject to demand uncertainty and to offering wind power purchase contracts with variable production. In section 3, we present the analytical model with two sequential auctions in which a procurement strategy for the SO is intertemporally optimised. Thereby, we consistently include the case of zero flexibility demand. Subsequently, the analytical results are transferred to a numerical example, in which a distribution system operator (DSO) purchases flexibility to alleviate a networks congestion at a high voltage/ mid voltage (HV/MV) transformer, which was induced by high renewable infeed (section 4). The investigation of specific interesting situations is complemented with a comprehensive sensitivity analysis of the crucial model parameters. Section 5 concludes.

2 Literature

The concept of flexibility markets with the objective to facilitate the integration of RES into the power system has been discussed extensively as part of new market-based congestion management methods. A prominent proposal emerges from the EU's Clean Energy for All Europeans package, which suggests introducing market-based redispatch (European Parliament 2019). Beyond that, European concepts like the USEF framework as well as academic research focus on the same topic (Heer und van den Reek 2018; USEF foundation 2015). Requirements and regulatory challenges to establish flexibility markets as alternative to congestion management are addressed as well by (Ruester et al. 2014; Huber et al. 2018).

In Germany, the federal regulatory authority (Bundesnetzagentur) introduces the concept of smart markets that give market signals in order to incentivize grid beneficial behaviour of market participants (BNetzA 2011). In response, different configurations of smart markets have been proposed, some of which include different forms of flexibility market platforms (Ecofys und Fraunhofer IWES 2017). Recently, several research projects across Europe investigate the practical implementation of regional flexibility markets (Radecke et al. 2019). Most of the concepts aim to make distributed flexibility options accessible for SOs and incentivize them to participate in con-

gestion management. In many cases, flexible resources can voluntarily offer to adapt their consumption or generation for a remuneration, that is specified by their submitted market bids (Radecke et al. 2019). The SO, as buyer on the flexibility market, can select the cheapest flexibility options to efficiently alleviate grid congestions.

The underlying problem of procuring flexibility under uncertainty is in its general framing similar to the Newsvendor Problem, known from inventory theory (Arrow et al. 1951; Morse und Kimball 1951). An entity is faced with uncertain demand for a perishable good with fixed prices and procurement costs and needs to order a stock of goods in advance. This basic problem is the starting point of a growing field of literature including various extensions to the original model.³ A stream of literature applies the methodology to perishable goods, such as the apparel industry. Fisher et al. (1994) optimize the ordering strategy of a sports vendor by reducing demand forecasting errors. Yan et al. (2003) extend the classical Newsvendor problem to a two-stage ordering problem in which an entity can order raw materials from two suppliers that differ in costs and lead-time. They provide analytical formulations of the optimality conditions in both stages and illustrate the analytical results exemplarily assuming a uniformly distributed stochastic demand for the final product. They furthermore expand the problem to a multi-period problem and provide some numerical insights.

Similarly, Choi et al. (2003) investigate an optimal two-stage ordering policy with Bayesian information updates. They explicitly elaborate on the information update between the two ordering stages and analytically and numerically prove the superiority of their two-stage ordering strategy compared to two alternative single-stage ordering policies. Under the assumption of normally distributed demand they find that the optimal ordering level increases linearly with the location parameter of the demand distribution. Demand uncertainty is composed of an inherent uncertainty that cannot and a further uncertainty component that can be reduced by making use of market information. It is shown that the two-stage policy performs better when the first component is smaller, and the latter component is larger.

Some work is related to electricity markets, more specifically the incremental procurement of electricity by a LSE. Sethi et al. (2005) study the problem of staged purchases of electricity in a time-sequential deregulated electricity market subject to demand uncertainty referring to the example of the Texan ERCOT market. Electricity can thereby be purchased in the day-ahead and hour-ahead market to serve a stochastic demand in the real-time market. In the real-time market, the LSE is forced to balance deviations between purchased electricity and realized demand at

³ Khouja1999 provides a review of extensions to the Newsvendor problem.

respective prices. The authors use stochastic dynamic programming to derive optimality conditions for the sequential purchase amounts and provide two algorithms for computing the optimal staged purchases.

Another stream of literature applies an analogous methodology to stochastic infeed from RES. Similar to the LSE that has to balance deviations from expected demand, wind power producers participating in liberalized electricity markets are subject to penalties related to regulation costs. Hence, the approach of staged purchases is adopted to forward sales. Yet typically only a single-stage sales market plus a real-time balancing mechanism is considered. The methodology then solves for the optimal offer by a wind power producer selling her variable power into a competitive electricity market. Pinson et al. (2007) propose a general methodology for deriving optimal bidding strategies based on probabilistic forecasts for wind generation. They express the optimal forward contract as a probabilistic quantile on prices. Bitar et al. (2012) discuss optimal contract offerings and the role of forecast information in this context. Dent et al. (2011) derive an optimal sloped bid curve rather than a fixed quantity for a wind generator that offers forward contracts and adjusts deviations on the real-time market at unknown and asymmetric prices. Matevosyan und Soder (2006) investigate a methodology to minimise the imbalance cost of trading wind power on the short-term power market.

We contribute to the existing literature by applying a methodology established in the general procurement literature to the novel context of flexibility markets. We show that the single-stage Newsvendor problem resembles the framework of a single-auction flexibility market in which the SO only has a single buying opportunity. We then focus on the two-stage version and its application to a flexibility market. This is particularly relevant when some of the cheaper flexibilities require some lead time to be able to cope with the request by the SO. In contrast to electricity demand met by a LSE that is usually positive, flexibility demand turns zero whenever there is no imminent congestion, which is explicitly considered with a positive probability in our model. Our analytical model formulation reveals basic relations between essential model parameters and the optimal procurement strategy. Furthermore, our case study on a flexibility market at a frequently congested transformer provides insights into that novel application area. Finally, the impact of variations of the parameter relations identified in the analytical model are investigated in a sensitivity analysis.

3 Model

We model a two-stage auction-based flexibility market for trading flexibility with a subsequent realisation stage. The two market stages aim to resolve expected congestion and thus reduce RES curtailment and corresponding costs at the third (non-market based) realisation stage. Infeed from RES is a major reason for congestion in electricity grids. Since infeed from RES is fluctuating and

associated with uncertainties, the SO has to procure flexibility to meet a yet uncertain need. Therefore, she relies on forecasts about the extent of the imminent congestion, which match the actual need more precisely the closer to the congestion the forecast is made. The two-stage approach is particularly appropriate to describe the trade-off between early procurement at low cost (assets with limited flexibility and substantial lead time) and later procurement at higher cost but with improved knowledge about the actual flexibility demand.

3.1 Model set-up

We consider a SO who is in charge of congestion management in a specific grid region. She thereby may make use of two sequential, single-sided auctions to procure flexibility (cf. Figure 1). Alternatively, she may curtail excess generation at the third stage paying some penalty. The SO acts as monopsonist (exclusive buyer) on the procurement platform with the objective to minimize the sum of flexibility procurement costs and penalty payments.

The flexibility demand X is assumed to be ex-ante stochastic and forecasted at each stage $i \in \{1, 2\}$ of the market before being revealed in stage 3 (Figure 1). It is modelled as a random variable with probability density function (pdf) $f_{X|I_i}(x)$ and cumulative distribution function (cdf) $F_{X|I_i}(x)$, where I_i is the information set available at that respective stage. The pdf of the flexibility demand is characterised by a locational parameter μ , that corresponds to the expected value of the demand and an uncertainty parameter σ . We formulate the set-up with an information update between the stages 1 and 2 in which the locational parameter μ is updated and the forecast is improved by a smaller forecast uncertainty σ :

$$\sigma_1 = \xi \sigma_2 \quad \text{with} \quad 0 < \xi \leq 1 \quad (1)$$

Parameter ξ represents the extent of the forecast improvement, i.e. the reduction of uncertainty between both market stages. The timing of the auctions and the resulting uncertainty of the flexibility demand are discussed and quantified in the application (section 4).

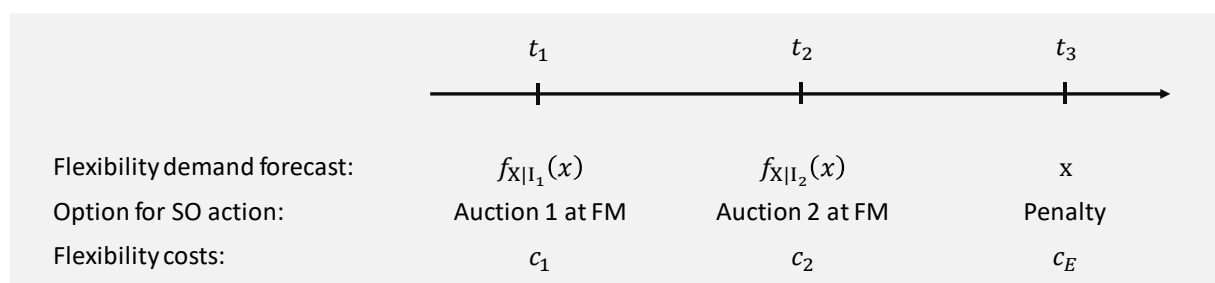

Figure 1: Timeline of options for actions of the SO to alleviate a grid congestion.

The supply side is characterised by (groups of) suppliers differing in terms of lead time and costs. There are flexible suppliers that can offer their flexibility at any lead time at costs c_2 and less flexible suppliers that require a certain preparation time but provide flexibility at lower costs c_1 ,

i.e. $c_2 > c_1$. Flexibility can be provided by distributed energy resources like prosumers, storages and local level generation capacities (Olivella-Rosell et al. 2018). Concrete sources of flexibility with their corresponding costs and lead times are discussed in the numerical application (cf. section 4). As it is assumed that the pool of potential suppliers at each stage is large enough as to meet any flexibility need, the SO would not contract any flexibilities at cost c_2 in stage 1. Consequently, either group of flexibility suppliers bids into one of the two auctions only. We assume that suppliers do not bid strategically to exclude market power issues. We furthermore assume that physical delivery of contracted flexibilities is compulsory, so that there is no secondary trade. If the actual flexibility need exceeds the previously contracted quantities, RES still have to be partially curtailed as ultima ratio to avoid congestion. As RES infeed is prioritised in many jurisdictions, curtailment has to be compensated, which is modelled as a penalty c_E to be paid by the SO. Hence, this penalty caps the price on the flexibility market. On the other hand, when the actual flexibility need remains below the contracted quantity the SO has still to pay the entire contract volume.

In this setting, the SO has to decide on a strategy to procure flexibility⁴ to meet an uncertain need at minimal costs. The trade-off between decreasing uncertainty and increasing procurement costs is modelled in a two-stage optimisation problem which is solved recursively. Thereby, optimal ordering quantities are derived.

3.2 Two-stage optimal procurement strategy

To analytically derive the optimal procurement strategy, a recursive approach is applied starting with solving stage 2.

Stage 2

It is assumed that the SO cannot sell flexibility on the market. To incorporate this restriction consistently into the two-stage newsvendor problem we define the actually procured quantities of flexibility \hat{q}_i as positive variables, whereas the (possibly negative) outcomes of the analytical decision rules are labelled q_i . Hence, $\hat{q}_i = \max(q_i, 0)$ holds for both stages. The actual flexibility demand is described by the stochastic variable X which may also take negative values – corresponding to situations when the available grid capacities exceed the transport requirements, so that none of the procured flexibility needs to be activated. The cost function in stage 2 can then be written as the sum of procurement costs and penalty costs that arise if the flexibility procured in both stages cannot cover the flexibility demand X :

⁴ Flexibility is assumed to be a perfectly divisible good allowing the SO to size the purchase at her exact need. Technical restrictions are hence assumed to dissolve in an aggregator's pool of small-scale flexibility options.

$$C_2(X, q_1, q_2) = c_2 \cdot \hat{q}_2 + c_E \cdot \max[(X - \hat{q}_1 - \hat{q}_2), 0] \quad (2)$$

Taking expectations over the randomly distributed flexibility demand yields the expected cost function E_2 (where the index is a short-hand notation for the expectation being evaluated with the information set I_2):

$$\begin{aligned} E_2[C_2(X, q_1, q_2)] &= \int_{-\infty}^{\infty} C_2(X, q_1, q_2) f_{X|I_2}(x) dx \\ &= c_2 \cdot \hat{q}_2 + \int_{\hat{q}_1 + \hat{q}_2}^{\infty} [c_E \cdot (x - \hat{q}_1 - \hat{q}_2)] f_{X|I_2}(x) dx \end{aligned} \quad (3)$$

In line with (Yan et al. 2003), we assume that equation (3) is convex in q_2 and formulate the first-order condition for an interior solution:

$$\frac{\partial E_2[C_2(X, q_1, q_2)]}{\partial q_2} = 0 \quad (4)$$

Solving for q_2 gives the optimal ordering quantity q_2^* at stage 2. Thereby the possibility of a boundary solution is explicitly acknowledged:

$$\left[c_2 - c_E \left(1 - F_{X|I_2}(\hat{q}_1 + q_2^*) \right) = 0 \wedge q_2^* \geq 0 \right] \vee q_2^* = 0 \quad (5)$$

$$q_2^* = \begin{cases} \rho(\mu_2) - \hat{q}_1 & \text{iff } \rho(\mu_2) \geq 0 \wedge \rho(\mu_2) \geq \hat{q}_1 \\ 0 & \text{otherwise} \end{cases} \quad (6)$$

We thereby define $\rho(\mu_2) = F_{X|I_2}^{-1}\left(\frac{c_E - c_2}{c_E}\right)$, where μ_2 is the location parameter of the flexibility demand distribution function at stage 2 which is part of the information set I_2 . At stage 1, this is a stochastic variable – hence the information set I_2 differs from I_1 by the removal of the uncertainty on μ_2 . $\rho(\mu_2)$ corresponds to the solution of the classical single-stage Newsvendor Problem and is called critical fractile. Here, it explicitly refers to the information status of the second stage. Hence, the optimal ordering quantity q_2^* at stage 2 is a function of the critical fractile given updated information and the ordering quantity at stage 1 (cf. eq.(6)). If and only if the critical fractile is positive and the ordering quantity at stage 1 is lower than the critical fractile with updated information, the optimal ordering quantity q_2^* at stage 2 is positive, i.e. the SO procures additional flexibility at that stage. In all other cases the SO will not be active on the market in stage 2.

Stage 1

The two-part solution of stage 2 is reflected in the cost function at stage 1 that is derived as follows:

$$\begin{aligned}
C_1(\mu_2, q_1) &= c_1 q_1 + E_2[C_2(X, q_1, q_2^*)|\mu_2] \\
&= \begin{cases} (c_1 - c_E)\hat{q}_1 + c_E E[X|\mu_2] + c_E \int_{-\infty}^{\hat{q}_1} [\hat{q}_1 - x] f_{X|I_2}(x) dx & \hat{q}_1 > \rho(\mu_2) \vee \rho(\mu_2) < 0 \\ (c_1 - c_2)\hat{q}_1 + (c_2 - c_E)\rho(\mu_2) + c_E E[X|\mu_2] + c_E \int_{-\infty}^{\rho(\mu_2)} [\rho(\mu_2) - x] f_{X|I_2}(x) dx & 0 \leq \hat{q}_1 \leq \rho(\mu_2) \end{cases} \quad (7)
\end{aligned}$$

In line with Yan et al. 2003, we assume that the optimal procurement level $\rho(\mu_2)$ is a linear function of the location parameter μ_2 of the (flexibility) demand pdf, which constrains the class of distributions that are eligible for the stochastic flexibility need. One of the possible choices is to assume that the stochastic flexibility demand X is normally distributed.⁵ This is an appropriate choice also in view of the case study – as long as we include the possibility that the actually needed flexibility may become negative, as discussed before. Clearly such an assumption would not be meaningful in the case of a newsvendor problem, yet it is interpretable in the present context as highlighted above.

Hence we proceed by presenting the analytical solution in terms of the normal distribution with $\rho(\mu_2) = \mu_2 + z\sigma_2 \geq \hat{q}_1$ with $z = \Phi^{-1}\left(\frac{c_E - c_2}{c_E}\right)$. Consequently, the expected costs can be written as:

$$\begin{aligned}
&E_1[c_1 \hat{q}_1 + E_2[C_2(I_2, q_1, q_2^*)]] \\
&= \int_{-\infty}^{\hat{q}_1 - z\sigma_2} \left\{ c_E E[X|\mu_2] - (c_E - c_1)\hat{q}_1 + c_E \int_{-\infty}^{\hat{q}_1} (\hat{q}_1 - x) f_{X|I_2}(x) dx \right\} f_{M_2|I_1}(\mu_2) d\mu_2 \\
&+ \int_{\hat{q}_1 - z\sigma_2}^{\infty} \left\{ c_E E[X|\mu_2] - (c_2 - c_1)\hat{q}_1 - (c_E - c_2)\rho(\mu_2) + c_E \int_{-\infty}^{\rho(\mu_2)} (\rho(\mu_2) - x) f_{X|I_2}(x) dx \right\} f_{M_2|I_1}(\mu_2) d\mu_2
\end{aligned} \quad (8)$$

The first integral represents cases in which μ_2 turns out sufficiently small so that the SO has already bought enough flexibility in stage 1 and there is no need to procure additional flexibility in stage 2. The expected costs in this case are determined as costs of curtailment valued with penalty c_E reduced by the cost saving through procuring flexibility in stage 1 $((c_E - c_1)\hat{q}_1)$. However, excess flexibility procured in stage 1, that is not required to cover demand, leads to additional costs which is considered in the last term of the first integral.

The second integral on the other hand represents cases with large μ_2 and the resulting flexibility need exceeds the flexibility procured in stage 1. Consequently, the SO procures additional flexibility in stage 2. The expected costs in this case are calculated as in the first case but comprise costs savings from both procuring flexibility at costs of c_1 and c_2 .

⁵ Another eligible distribution is the uniform distribution (cf. Yan et al. 2003).

Analogously to stage 2, the necessary condition for an optimal non-zero ordering quantity is given by the derivative of the expected costs:

$$\frac{\partial E_1[C_1(X, q_1)]}{\partial q_1} = 0 \quad (9)$$

The derivative is computed with the help of Leibniz's Rule as:

$$\frac{\partial E_1[C_1(X, q_1)]}{\partial q_1} = c_1 - c_2 + (c_2 - c_E)F_{M_2|I_1}(\hat{q}_1 - z\sigma_2) + c_E \int_{-\infty}^{\hat{q}_1 - z\sigma_2} F_{X|I_2}(q_1)f_{M_2|I_1}(\mu_2)d\mu_2 \quad (10)$$

The second-order derivative is always positive so that the expected cost function is convex in q_1 . Hence, there exists an optimal order quantity q_1^* (and q_2^* , cf. above) that minimises the expected cost function.

The improvement achievable through this two-stage procurement approach is evaluated against the benchmark of single auctions either at stage 1 or 2. The respective optimal quantity of a single-auction market is given by the critical fractile based on the available information set. Consequently, the flexibility procured and the associated costs of the two-stage auction design can be compared to results of the single-stage alternative. The model results are visualised by the help of a numerical application in the next section.

4 Application

As already discussed in the preceding section, a key driver of congestion management in electricity grids is the fluctuating infeed of renewable energy. This especially applies to DSOs as they are in charge of those networks where most of renewables are connected to.

On this account, the numerical analysis is tailored to an illustrative example of congestion in the distribution grid. In particular, a large wind park (55 MW) is connected to a HV/MV transformer (110kV/20kV), which causes grid congestions in periods of high wind power infeed and low load. In this case, the DSO can utilize all flexibility options that are located in the topological area of the congested transformer (grey area in Figure 2) if they participate in the flexibility market.⁶

⁶ It is hereby assumed that the medium voltage grids are not meshed between different HV/MV transformers or alternatively that they are operated with open interconnections. Hence all flexibility options inside the transformer area fully impact the congestion. In contrast, all other flexibility options outside this area have no impact on the electricity flow via the transformer and cannot be utilized to resolve the congestion.

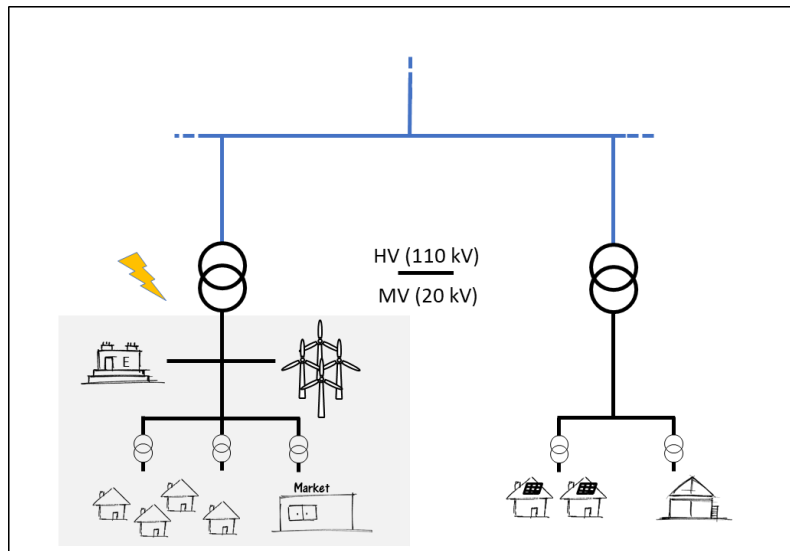

Figure 2: Illustration of a congested HV/MV transformer and the transformer region (grey).

The timing of the auctions considers the trade-off between adequate lead times required by the flexibility suppliers and decreasing uncertainty revealing the flexibility need more precisely. In the numerical illustration, the auctions are scheduled corresponding to the flexibility resources available in the exemplary market area. These include gas compressors that require some hours of lead time and relatively fast cross-sectional technologies (s. section 4.1.2). Accordingly, the first auction is scheduled three hours before delivery to acquire flexibility options with longer lead times. The second auction is conducted one hour before delivery, so that DSOs have the chance to purchase additional flexibility based on an improved demand forecast.

Subsequently we first describe the parametrization of our reference case A (section 4.1) and then introduce further exemplary cases B-D (section 4.2). After reporting the results for these exemplary settings (section 4.3), we conduct a more systematic analysis of the impact of key model parameters on the results (section 4.4).

4.1 Description of the reference case (case A)

To conduct the numerical analysis, all model parameters from section 3 are calibrated based on empirical data. Sections 4.1.1 and 4.1.2 give a brief summary while the determination of the parameters is explained in more detail in appendices A and B.

4.1.1 Parametrization of flexibility demand in the reference case

On the demand side, the locational and uncertainty parameters μ_i and σ_i of the distribution functions of the flexibility define the information set at the two stages. The actual flexibility demand

is the result of high (back-)flows at the transformer $Q_{flow}^{transformer}$ that exceed its maximum capacity $K_{max}^{transformer}$.⁷ Therefore, the general rule for actual flexibility demand \hat{X}_0 is given by

$$\hat{X}_0 = \max(Q_{flow}^{transformer} - K_{max}^{transformer}, 0) \quad (11)$$

The load flow $Q_{flow}^{transformer}$ is the difference of the infeed of the (wind) power plants Q_{gen} and the aggregated electricity demand Q_{dem} of all consumers

$$Q_{flow}^{transformer} = Q_{gen} - Q_{dem} \quad (12)$$

If $\hat{X}_0 > 0$, flexibility in form of an increase in consumption or a decrease in generation is demanded. Negative flexibility demand could be defined analogously, yet we subsequently focus on situations with $E[\hat{X}_0] > 0$, i.e. situations with expected excess infeed. If both forecast errors for (wind) infeed and demand are normally distributed, the uncensored flexibility demand variable X is then also normally distributed, cf. e.g. (Chen et al. 2019):

$$X = Q_{flow}^{transformer} - K_{max}^{transformer} = Q_{gen} - Q_{dem} - K_{max}^{transformer} \quad (13)$$

The illustrative example includes a maximum transformer capacity $K_{max}^{transformer}$ of 40 MW. Empirical data on vertical load flows of a HV/MV transformer show that if a congestion is expected, the flexibility demand is on average $6.95 \text{ MW} \approx 7 \text{ MW}$ (cf. Appendix A). Based on this value a typical situation can be designed that is characterized by low consumption Q_{dem} of 3 MW and high wind power infeed Q_{gen} of 50 MW, in which flexibility would be procured. In this example, the predicted flexibility demand in t_1 is calculated as:

$$E[X_1] = \text{sign}(50 \text{ MW} - 3 \text{ MW}) \cdot \max(|50 \text{ MW} - 3 \text{ MW}| - 40 \text{ MW}, 0) = 7 \text{ MW} \quad (14)$$

The flexibility demand forecast is subject to uncertainty stemming from wind power infeed and uncertain load. The parameters are also derived from empirical data by analysing the distribution of forecast errors with lead times of one and three hours (Appendix A). Based on these data, the standard deviation of the flexibility forecast at stage 1 σ_1 is estimated at 4.65 MW. After the information update in t_1 , the SO is faced with an improved flexibility forecast with an updated expected demand μ_2 and reduced uncertainty σ_2 of 3.45 MW in stage 2. The resulting reduction factor of uncertainty is $\xi = 0.74$. μ_2 is a random draw from the pdf of the flexibility with the information set I_1 . In our scenario analysis, reference case A represents a situation with significantly increasing flexibility demand after the information update in order to show the optimal

⁷ The consideration of the n-1 criterion is not necessary because the SO only needs to assure grid stability with focus on demand side and not on supply side loads.

reaction of the SO in case of being short in flexibility ($\mu_2 > \mu_1$, here we use $\mu_2 \approx \mu_1 + \sigma_1$). In summary, the following demand side parameter values are used:

Table 1: Demand-side parameters of case A.

t_1	t_2
$\mu_1 = 7 \text{ MW}$	$\mu_2 = 11.65 \text{ MW}$
$\sigma_1 = 4.65 \text{ MW}$	$\sigma_2 = \xi \sigma_1 = 3.45 \text{ MW}$

4.1.2 Parametrization of flexibility supply in the reference case

On the supply side, the relevant parameters of the model are the variable cost of the flexibilities c_1 and c_2 as well as the penalty c_E . The cost c_1 and c_2 of the SO for flexibility procurement correspond to the prices that the flexibility marketers would bid into the flexibility market to provide flexibility. In the absence of strategic behaviour on behalf of the flexibility providers, these prices are driven by the (opportunity) cost faced by the flexibility provider.

Alternatively, the SO can also fall back on curtailment as ultimate measure in case of insufficient flexibility procurement in both auctions. In the event of curtailment, German regulation stipulates that the grid operator being responsible for the curtailment is obliged to compensate the owner of the wind power plant for lost revenues. Lost revenues comprise the remuneration tariffs of wind power plants that are specified by the German Renewable Energy Act. In 2018, the average remuneration for onshore wind power plants was approximately 85 € per MWh. This therefore taken as our base estimate for cost c_E .

One flexibility option for the SO are electric gas compressors, which are part of the natural gas transmission system. Natural gas, while being transported through gas pipelines, needs to be constantly pressurized by compressors. Usually, these compressors are powered by gas turbines that withdraw natural gas directly from the gas grid. Currently, some gas grid operators expand these compressor stations with electric motors to switch from gas fired to electrically driven technologies in times of low power prices. This innovative concept could be more economically viable, if additional revenues are generated by selling this flexibility at the flexibility market. Electric gas compressors can provide significant amounts of flexibility because their installed capacity usually exceeds 10 MW. However, as the main function of a compressor is to secure the scheduled volumes of gas transportation, the actual amount of flexibility is limited by the demand of transportation capacities. The number of limiting conditions the operator of the compressor has to consider results in a lead time of several hours. Consequently, this flexibility option is only accessible to the SO in the first auction.

The costs c_1^{gc} are determined by the cost spread between operating the compressor by gas turbine and by electric motor. If the cost of electricity minus the additional revenues from the flexibility market is lower than the cost of gas, it would be economically beneficial to perform a fuel switch and provide flexibility in times of congestions. Besides the intraday wholesale prices for gas p_{gas}^{ID} and electricity p_{el}^{ID} , the efficiency of the gas turbine η_{gas} and the electric motor η_{el} , taxes and levies p_j^{levies} and the CO₂ price p_{CO_2} in case of the gas fired turbine need to be considered:

$$\frac{p_{el}^{ID}}{\eta_{el}} + p_{el}^{levies} - c_1^{gc} \leq \frac{p_{gas}^{ID}}{\eta_{gas}} + p_{gas}^{levies} + p_{CO_2} \quad (15)$$

The minimum revenues that the marketer of the electric compressor expects from the flexibility market is therefore:

$$c_1^{gc} \geq \left(\frac{p_{el}^{wholesale}}{\eta_{el}} + p_{el}^{levies} \right) - \left(\frac{p_{gas}^{wholesale}}{\eta_{gas}} + p_{gas}^{levies} + p_{CO_2} \right) \quad (16)$$

Thus, c_1^{gc} highly depends on actual intraday prices. Especially in hours with low or negative wholesale prices, the electric compressor may be a profitable option for congestion management. However, driven by high taxes and levies for electricity, the electric compressor is very frequently more expensive than curtailment in Germany. Thus, for the reference case, we assume that large switchable loads, which participate effectively in congestion management, are exempted from fees and taxes. This is a valid assumption because there are already several regulations in Germany that exempt consumers from taxes and levies in case of electricity consumption that supports grid stability.⁸ Otherwise the gas compressor could not compete with other flexibility options, which is discussed in section 4.2. Consequently, the reduction of taxes and levies decreases the costs of the gas compressor's flexibility significantly which leads to flexibility costs of the gas compressor of c_1^{gc} of 10 € per MWh (cf. Appendix B for a detailed consideration).

Flexibility potentials of business facilities are mainly provided by cross-sectional technologies like air conditioning and ventilation systems. The load shifting potential of single facilities is usually limited to a maximum of a few hundred kilowatts. By pooling and marketing an aggregated portfolio of potentials however, a significant amount of flexibility may be offered to the SO. A prerequisite to participate on the flexibility market is the implementation of an energy management system. These systems are usually applied to optimize the electrical demand to minimize energy procurement costs. However, if additional revenues on a flexibility market incite load shifting, these plants can shift their electrical withdrawal from periods with low energy prices $p_{planned}^{ID}$ to periods of excess wind power infeed. To provide an incentive, the revenues of the

⁸ §19 StromNEV, for example, allows the grid operator to offer reduced network fees to a consumer on condition that the electricity withdrawal supports grid stability.

flexibility market have to exceed the additional costs that arise by withdrawing electricity during periods with higher electricity prices p_{flex}^{ID} . Thus, the cost for such flexibilities $c_{1,2}^{CS}$ are given by:

$$c_{1,2}^{CS} = p_{flex}^{ID} - p_{planned}^{ID} \quad (17)$$

The flexibility from cross-sectional technologies is limited by its primary purposes, so that the related electricity demand cannot be shifted or pooled arbitrarily over several hours. Also resulting backlog demand has to be caught up within a restricted time period. Given that the scheduled electricity consumption exploits lowest energy prices and with a maximum shifting time of six hours, a spread of additional costs for load shifting for every quarter of an hour can be computed (cf. Appendix B). The average of these spreads is taken as estimate for the cost of flexibility provided by cross-sectional technologies in our reference case. Based on intraday prices in 2018, it equals $c_{1,2}^{CS} = 20$ € per MWh. Due to a high degree of automatization lead times are expected to be short so that these technologies are not restricted to a specific auction. A detailed explanation how the costs are determined and how they vary depending on the maximum shifting time is included in Appendix B.

Given that gas compressors suffice to meet flexibility demand in the first auction, it will drive the more expensive cross-sectional technologies out of the market. These in turn are assumed to be the only flexibility option in the market in the second auction. Thus, in stage 1 the costs for flexibility is determined by the gas compressor at $c_1 = c^{gc} = 10$ € per MWh and in stage 2 by cross sectional technologies at $c_2 = c^{CS} = 20$ € per MWh.

4.2 Description of further cases

The setting and the parametrization of our reference case as described in the previous section is summarized in Figure 3. To examine the impact of different parameter scenarios on the results of the two-stage flexibility procurement, several alternative cases are considered.

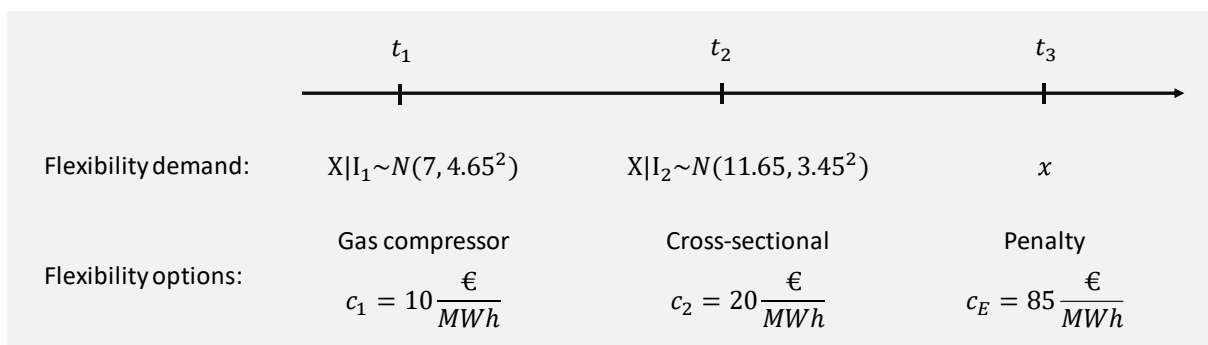

Figure 3: Parameterization of reference case A.

Case B - Decrease of predicted flexibility after information update $\mu_2 < \mu_1$

The reference case describes an exemplary realization where the information update of the wind power forecast results in a significantly increasing flexibility demand. Case B in turn represents a

situation with a decrease in flexibility demand after the information update. The reference case calls for a reaction by the SO to buy additional flexibility, whereas in case B, the SO faces a situation where her upfront procurement is likely to be oversized. To illustrate this situation, the same initial flexibility demand forecast with mean μ_1 of 7 MW and an updated flexibility demand with mean μ_2 of 2.35 MW is assumed ($\mu_2 \approx \mu_1 - \sigma_1$). The forecast uncertainty and its improvement remain at the same level as in the reference case.

Case C - Levies and taxes of the electric gas compressor

As stated before, levies and taxes have a strong impact on the economic viability of the compressor station's participation in the flexibility market. In our reference case, these cost components are omitted so that the gas compressor is able to compete against the cross-sectional flexibility options in stage 1. In case C, it is assumed that large switchable loads, which participate effectively in congestion management, are still obliged to pay grid fees and taxes. The burden of taxes and levies increases the costs of the gas compressor's flexibility by more than 70 € per MWh to 80 € per MWh (cf. appendix B). Consequently, the compressor is more expensive than the cross-sectional technologies which now provide the cheapest flexibility option in both auctions with $c_1 = c_2 = 20$ € per MWh.

Case D – Decreasing penalty costs

Within the recently adopted law NABEG 2.0⁹, provisions are made to integrate the current fallback option of curtailment into the redispatch process. Consequently, in our model renewable curtailment can be interpreted as another flexibility option on the flexibility market. Due to installed control units, that allow wind power plant operators to react in real time, flexibility of wind power plants is available without any lead time in t_3 . According to Höckner et al. (2019a) considering subsidies in the calculation of opportunity costs of renewables in a flexibility market can cause market distortions and lead to an inefficient selection of flexibility options to solve grid congestions. This has also an impact on the calculated penalty costs c_E . Höckner et al. (2019a) propose the implementation of side payments, that are equal to the market premium (MP), to achieve an efficient market outcome. Consequently, renewable power plants would not demand the full tariff granted by the support scheme on the flexibility market, but only the difference between the granted tariff and the market premium. In the German system, this difference is called monthly market value (MMV). In 2018, the average MP equals 60 € per MWh, which leads to costs of renewable regulation on the market of

⁹ The intent of the Grid Expansion Acceleration Act (NABEG) 2.0 is to amend existing regulation with the target to expand grid infrastructure and encourage renewable energy supply.

$$c_E = \text{tariff} - MP = MMV = 85 \frac{\text{€}}{\text{MWh}} - 60 \frac{\text{€}}{\text{MWh}} = 25 \frac{\text{€}}{\text{MWh}} \quad (18)$$

This case also corresponds to renewable power plants that run out of the remuneration guaranteed by the support scheme. Since 2000, the German support scheme guarantees wind power plant owners a specified feed-in remuneration for a maximum period of 20 years. Thus, for the first wind power plants, the remuneration period will end in 2021. Consequently, wind power plant operators could still sell their electricity in the market, but they do no longer receive the market premium which was paid by the SO as part of the support scheme. This would lead to the same opportunity costs c_E of 25 € per MWh as described above.

4.3 Results of different cases

Analyzing the results of the different cases, we focus on the optimal procurement strategies and the resulting costs for the SO.

4.3.1 Optimal procurement strategies

In case A and B, the mean flexibility demand is predicted as 7 MW with the same uncertainty of 4.65 MW and the SO can buy flexibility of the gas compressor at costs c_1 of 10 € per MWh. The corresponding optimal quantities are given in Table 2. Based on the available information at t_1 , the optimal procurement quantity in t_1 is $q_1^* = 11.43$ MW in both cases, which is much higher than the expected value of 7 MW. The SO buys this additional flexibility in order to avoid falling back on more expensive flexibility options in the following stages. Thus, this procurement quantity is dimensioned considering the demand uncertainty and the anticipated increased flexibility costs for later procurement. The information update in case A indicates a significantly higher flexibility demand and the SO's optimal strategy is to buy additional flexibility in t_2 . In contrast, in case B, the predicted flexibility demand decreases substantially. The critical fractile ρ_2 specifies the optimal amount of flexibility that the SO should buy given the information set I_2 . Therefore, in case A, the SO procures some additional 2.71 MW to attain the optimal amount of 14.14 MW. In case B, the SO has already procured 6.59 MW more flexibility in stage 1 than indicated by the critical fractile after the information update. Thus, it would be optimal to sell the excess flexibility, but since no flexibility sales by the SOs are allowed, the optimal strategy is to be inactive in stage 2.

Table 2: Optimal procurement quantities in different cases in MW.

	q_1^*	q_2^*	total	ρ_2
Case A	11.43	2.71	14.14	14.14
Case B	11.43	0	11.43	4.84
Case C	0	14.14	14.14	14.14

In case C, the costs of flexibility are identical in both stages, because the gas compressor is driven out of the market by higher cost compared to flexibility from cross-sectional technologies. As a result, the SO does not benefit from procuring flexibility at stage 1 under higher uncertainty than in stage 2. Consequently, all flexibility is procured in stage 2 after the information update has realised. In stage 2, the optimal ordering quantity of 14.14 MW equals the one in case A because all parameters are identical except the cost of flexibility in t_1 . As the SO does not buy any flexibility at stage 1, she needs to buy all 14.14 MW in stage 2.

In case D, we assume significantly lower costs of the fall-back option curtailment. Accordingly, the overall level of procured flexibility is much lower because the incentive to buy large amounts of flexibility in excess of expected needs in order to avoid expensive penalty costs is much decreased. The reduction of c_E from 85 €/MWh to 25 €/MWh leads to a reduction by nearly 40% in the optimal procurement level ρ_2 to 8.75 MW compared to 14.14 MW in the other cases.

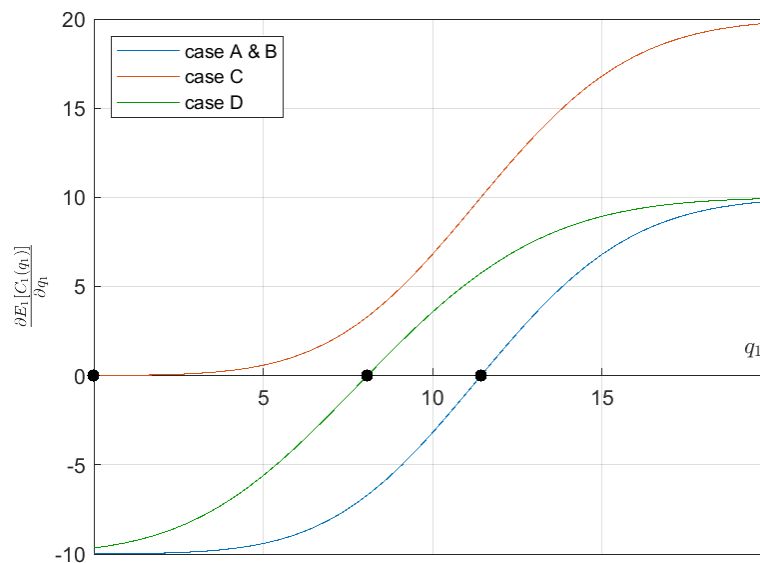

Figure 4: Marginal change in expected costs at t_1 as a function of procurement quantity q_1 .

In addition to the previous results, Figure 4 illustrates the computation of the optimal procurement quantities in stage 1 for the four cases considered. It shows the implementation of equation (9) to determine q_1^* as the root of the derivative of the expected cost function in stage 1. The actual amount of flexibility that the SO requires in t_3 is not considered explicitly because it has no impact on the preceding procurement strategy on the flexibility market.

4.3.2 Resulting Costs

Analysing the resulting costs for the different cases indicates that changing single parameters can have a great impact on the procurement costs of the SO. Table 3 gives an overview of the costs arising in stage 1 and 2 following the optimal procurement strategies of section 4.3.1. It also includes the expected costs in stage 2 considering all possible scenarios of the actual demand in stage 3 and resulting additional costs by utilizing the fall-back option. It should be emphasized that a different development of the flexibility demand is assumed in case B so that the costs of this case are not comparable to the other cases.

Table 3: Costs and expected costs of flexibility procurement in Euro.

	C_1	C_2	C_{ges}	EC_2
Case A	114.34	54.11	168.45	208.84
Case B	114.34	0.00	114.34	114.72
Case C	0.00	282.79	282.79	323.18
Case D	80.76	13.41	94.17	176.39

In case A, the SO pays 114.34 € for 11.43 MW of flexibility provided by the gas compressor and 54.11 € for 2.71 MW of flexibility provided by the cross-sectional technologies which results in total costs of 168.45 €. The expected costs at stage 2 is 208.84 € which means that expected additional costs for all scenarios in which actual demand exceeds the procured flexibility is approximately 40 €. In case C, all flexibility is procured at stage 2 which results in strongly increasing costs compared to case A (55 %). The same result would be obtained if no first stage auction would be implemented in case A. Thus, the cost increase illustrates also the economic benefits of having more than one auction if this enables the SO to procure cheaper flexibility. In case D, the costs of flexibility procured in stage 1 and 2 decrease significantly by 44%, because low penalty costs in stage 3 induce a small-sized procurement strategy. However, due to this strategy the probability of requiring additional flexibility in stage 3 increases significantly, which is reflected by the increased difference between the expected costs in stage 2 and the total costs of advance procurement of almost 80 €.

Case B represents a case of decreasing flexibility demand after the information update in stage 2. Due to an oversized flexibility procurement strategy in stage 1 it is unlikely that the actual flexibility demand in stage 3 surpasses the already procured amount of flexibility. Consequently, the total costs of advance procurement and the expected costs at stage two only differ by 0.38 €.

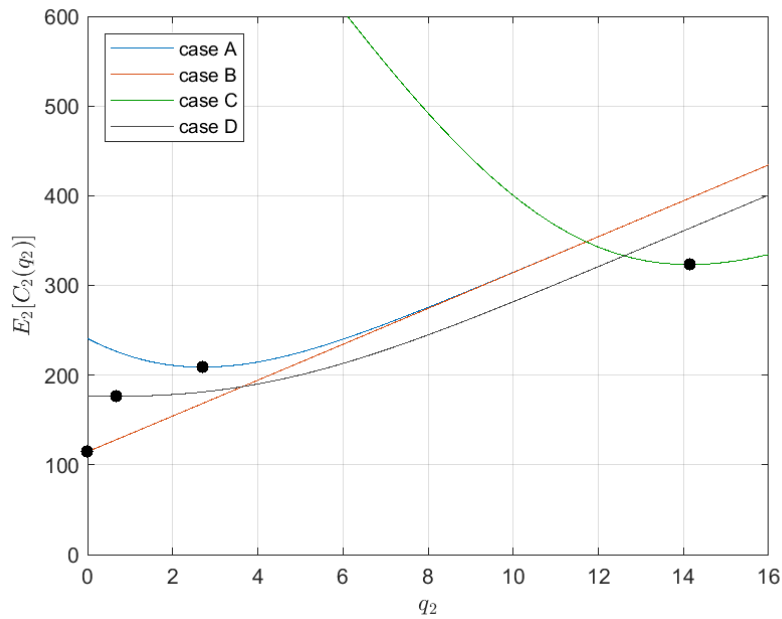

Figure 5: Expected cost at stage 2 as a function of procurement quantity q_2 .

Figure 5 illustrates the expected cost curves at stage 2 and points out the optimal quantities q_2^* that are calculated by equation (6). Black markers thereby highlight the expected costs at stage 2 when the optimal flexibility is procured at stage 2, which correspond to the cost EC_2 reported in Table 3.

4.4 Sensitivity analysis of different parameters on model results

Exemplary situations with specific parameter constellations as discussed in sections 4.2 and 4.3 provide good illustrations of the basic functioning and the trade-offs captured in the model. Yet the analysis of these situations may be complemented by systematically investigating the effect of varying parameters using sensitivity analyses. All sensitivities build upon the parameterisation of the reference case (case A) and compare the optimal procurement strategy in terms of quantities and expected costs to this reference situation. In contrast to the cases in the previous section with a single realisation of μ_2 , the sensitivity analyses are evaluated based upon expected values to consider the full range of possible realisations of the random variables.

A crucial issue in designing flexibility markets is the number and the timing of auctions. The efficiency of the timing depends on the flexibility options that bid into the scheduled auctions. To assess the benefit of having two auctions as implemented in our model, the results of a market with a single auction, either in stage 1 or 2, are furthermore displayed as a reference.

Section 4.4.1 focuses on the impact of ratios of the cost parameters and in section 4.4.2 the impacts of the information update parameter ξ and the level of initial uncertainty are discussed. The sensitivity analysis is conducted examining the effect of parameter changes on the optimal

ordering quantities q_1^* and $E_1[q_2^*]$ as well as the expected overall costs for congestion management $C = E_1[C_1]$ and its split over procurement stages.

4.4.1 Costs parameters

In the first sensitivity analysis, the cost of the flexibility option in stage 1 is varied in order to analyse the impact on the procurement strategy of the SO. The interval for the ratio of c_1 and c_2 is chosen as $\frac{c_1}{c_2} \in [0.25; 1]$, i.e. ranging from a large cost difference between the flexibility options at both stages to equal costs.

Figure 6 (upper left) displays the optimal quantities the SO would procure at both stages – normalised to the aggregate flexibility procurement of the reference case q_{ref}^* ¹⁰ (marker) – depending on the cost ratio of the flexibility options at stage 1 and 2. A low cost ratio results in a strategy where flexibility procurement is limited to the first stage (dashed blue line). This result indicates that the procurement resulting from a situation as the one presented in case B – i.e. exclusive procurement in stage 1 – is more probable than the one resulting from case A.¹¹ As the cost ratio increases, i.e. cost levels converge, the level of flexibility procured at stage 1 decreases. The parallel increase of procurement in stage 2 (dashed orange line) yet does not compensate the reduced early procurement as costs for flexibility increase in relation to the penalty for curtailment. Interestingly, a sharp reduction of early procurement is observed for low cost differentials only.

Comparing the optimal procurement strategies in the case of two auctions with the procurement in single auctions reveals that the aggregate procurement volume (grey line) is between the amounts of flexibility purchased in single-auction markets (blue and orange lines). This is intuitive as the SO can combine benefits from lower costs in stage 1 and a more precise forecast in stage 2. Reasonably, in the extreme case of equal cost levels in both auctions (i.e. cost ratio 1), the SO postpones full procurement until stage 2 to exploit the reduced uncertainty as already demonstrated in case C.

¹⁰ with $q_{ref}^* = q_1^* + E_1[q_2^*]$.

¹¹ The probability of the two exemplary cases is equal.

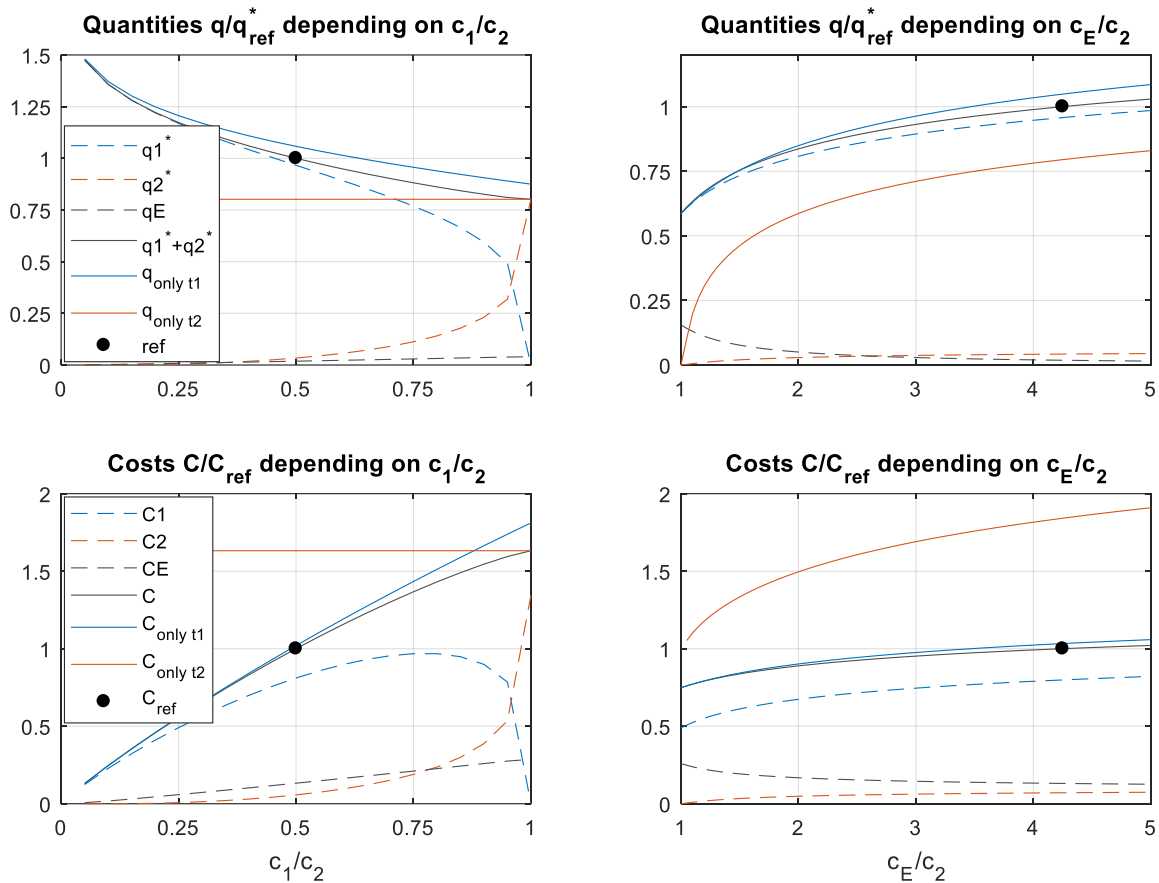

Figure 6: Quantities and costs for the sensitivities of flexibility costs (left) and penalty cost (right) relative to the reference case.

The efficiency of two auctions compared to single auctions can be evaluated from the expected costs in Figure 6 (lower left). Expected costs are normalised with costs of the reference case C_{ref} (marker). With almost exclusive procurement in stage 1 in situations with high cost differentials, the cost advantage compared to a single early auction (blue line) is negligible whereas the cost reduction compared to a single auction at a later stage (orange line) is high. The higher the amount of flexibility that is shifted from the early stage to the later stage in accordance with the increasing cost ratio, the lower this cost reduction is.

Case D shows that a reduction of the penalty for curtailment leads to a reduction of overall flexibility procurement. This result is confirmed by the sensitivity regarding the ratio $\frac{c_E}{c_2}$ of the penalty cost relative to the cost of the flexibility available in the second auction. This ratio is investigated for the range $\frac{c_E}{c_2} \in [1; 5]$ (Figure 6 right)). In case there is no difference between the cost of flexibility that bids into the second auction and the penalty, flexibility is only procured in the first auction (dashed blue line). In this extreme case, the amount is reduced to 60 % of the amount

that is procured in the reference case. The increase in early procurement as well as in procurement at stage 2, however, flattens out with the increase of the ratio of the penalty and flexibility cost in the second auction.

The procurement strategies are mirrored in the costs. The cost advantage of a two-auction market over a single-auction setting is lowest with a low penalty. The extent of the cost advantage is by far higher compared to a single auction in stage 2 (orange line) as the major share (> 60 %) is procured in stage 1 at lower costs.

4.4.2 Information update and level of initial uncertainty

Besides the cost relations of flexibility options and curtailment, the extent of uncertainty reduction through the information update is relevant for the benefit of conducting two auctions compared to a single auction. This effect is investigated by varying the parameter $\xi = \sigma_2/\sigma_1$ which describes the information improvement through the update respectively the relative reduction of uncertainty at stage 2.

Figure 7 (upper left) shows that a considerable information improvement, i.e. reduction of uncertainty is necessary for the SO to reduce her flexibility procurement. Compared to the reference situation, in which the standard deviation of the updated flexibility demand is about three quarters of the initial standard deviation, total procurement is only ten percent higher in a situation without any forecast improvement. The aggregate procurement (grey line) varies linearly between 75 % and 107 % of the reference quantity on the interval of the varied ratio of the uncertainty levels associated with the two information sets between 0.1 and 0.9. The limited effect of the information update is owed to the fact that the relative high cost differential between the flexibility options results in a generous procurement in the first stage (dashed blue line). This result is in line with the findings derived in Choi et al. (2003) where the performance of the two-stage procurement compared to early procurement only is better the lower the share of the inherent demand uncertainty and the higher the reduction of uncertainty through the information update is. Accordingly, the cost advantage of two auctions (grey line) compared to a single late auction (orange line) is considerably higher than compared to a single early auction (blue line). For the design of flexibility markets this result indicates that in such a setting the timing of the auctions can be largely chosen irrespective of the extent of the information update.

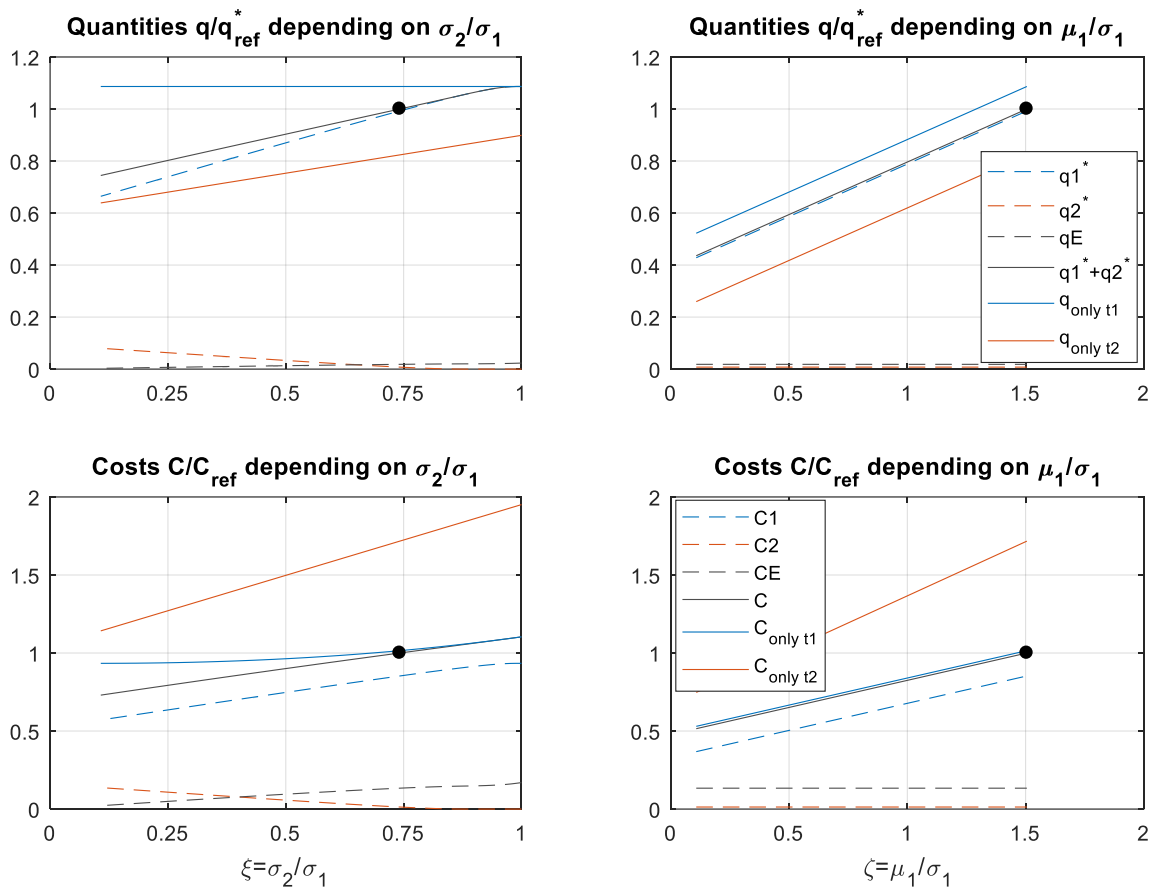

Figure 7 Quantities and costs for the sensitivities of the information update (left) and the initial uncertainty level (right) relative to the reference case.

The final sensitivity analysis explores the impact of the expected value of flexibility demand in relation to the initial uncertainty level, i.e. the ratio μ_1/σ_1 of location and uncertainty parameter at stage 1. The composition of the flexibility procurement for a variation of the mean predicted flexibility need in stage 1 is depicted in Figure 7 (upper right). The graph reveals a linear relation of the quantities procured in the first auction (dashed blue line) and the initial uncertainty level whereas the procurement in the second auction (dashed orange line) is on a constantly low level. Hence, an increase in the initial mean flexibility demand forecast directly induces additional quantities procured in the early stage. Similar to the previous sensitivity, the cost advantage of two auctions mainly stems from the early procurement opportunity.

5 Conclusion

Our model shows that the two-stage Newsvendor Problem is applicable to the context of auction-based flexibility markets. The analytical model provides a tool to compare the design of flexibility auctions in relation to parameters constellations. These include the costs of different flexibility

sources, which in turn depend on characteristics such as lead times and penalty costs for curtailment. Furthermore, the distribution of the ex-ante uncertain flexibility demand is decisive. Our findings are based on the assumption of an underlying normal distribution.

The numerical analysis shows that in all situations a major share of the flexibility is procured in the first auction. Still, case A shows that an increase of the flexibility demand after the first auction leads to procurement in the second auction. However, under the investigated normal distribution of the flexibility demand, situations of significantly increasing demand have a low probability of occurrence. According to the sensitivity analysis, considerable flexibility volumes are only procured in the second auction either in case of a very low-cost differential between the flexibility sources or with a high reduction in uncertainty. In these cases, the cost reduction compared to a single auction in the first stage is noteworthy whereas in all other cases the aggregate costs with two auctions are almost as high as the costs of a single early auction but considerably lower than the costs of a single late auction. Consequently, these results indicate that if the market design is limited to a single auction, in most cases it is efficient to be scheduled rather early because the surplus to procure cheaper flexibility options exceeds advantages of lower forecast uncertainty.

Furthermore, the sensitivity analysis visualises that given a high differential between the unit costs of the flexibility options and a low uncertainty reduction through the information update, the effect of the information update compared to a single early auction is rather limited. This provides a basis for harmonised auction time schedules across different regional flexibility markets. Such a harmonised design can be beneficial for the development of business concepts e.g. by aggregators who might manage a portfolio of flexibilities and would therefore act in several flexibility markets.

We assume that the costs of different flexibility sources are common knowledge or at least known to the SO. This assumption can be justified by the repeated nature of the occurrence of congestion and a limited range of flexibility sources depending on the market size. The implication of uncertain cost of flexibility available in the second auction, however, can be directly transferred from the discussion by Choi et al. (2003). They find that only if the first-stage ordering cost is lower than the expected unit ordering cost at the second stage the optimal order quantity at the first stage shall be positive.

An issue that can be highly relevant for the design of flexibility markets is market power. The smaller a flexibility market, the higher the influence of the individual bid to relieve a congestion. However, a small market with limited sources of flexibility is prone to market power as flexibility auctions will be repeated and are therefore suitable to facilitate collusion among few market participants. In an extension to the two-stage version of the Newsvendor problem, Zheng et al. (2015) raise the issue of limited supply in the emergency ordering, i.e. second stage, that results

from capacity constraints. In contrast to the assumption of sufficient flexibility supply in the model of the present work, the impact of market power could be analysed by the help of this model extension where the capacity constraint is intentionally created by withholding flexibility. An approach to limit the market power in the flexibility markets is to introduce price caps that reflect the actual opportunity costs at system level (cf. Höckner et al. (2019a)). This at least ensures that even in the presence of strategic behavior, the market outcomes are an improvement compared to a situation without any auction.

6 Acknowledgements

We drafted this paper within the scope of the research project “enera” (project code 03SIN330) as part of the SINTEG funding program of Federal Ministry for Economic Affairs and Energy of Germany.

Supported by:



Federal Ministry
for Economic Affairs
and Energy

on the basis of a decision
by the German Bundestag



SINTEG

SCHAUFENSTER INTELLIGENTE ENERGIE

7 Literaturverzeichnis

Arrow, Kenneth J.; Harris, Theodore; Marschak, Jacob (1951): Optimal Inventory Policy. In: *Econometrica* 19 (3), S. 250. DOI: 10.2307/1906813.

bdew (2018): Redispatch in Deutschland. Auswertung der Transparenzdaten. bdew. Berlin. Online verfügbar unter https://www.bdew.de/media/documents/Awh_20180212_Bericht_Redispatch_Stand_Februar-2018.pdf, zuletzt geprüft am 16.11.2018.

Bitar, Eilyan Y.; Rajagopal, Ram; Khargonekar, Pramod P.; Poolla, Kameshwar; Varaiya, Pravin (2012): Bringing Wind Energy to Market. In: *IEEE Transactions on Power Systems* 27 (3), S. 1225–1235. DOI: 10.1109/TPWRS.2012.2183395.

BNetzA (2011): "Smart Grid" und "Smart Market". Eckpunktepapier der Bundesnetzagentur zu den Aspekten des sich verändernden Energieversorgungssystems. Bonn. Online verfügbar unter https://www.bundesnetzagentur.de/SharedDocs/Downloads/DE/Sachgebiete/Energie/Unternehmen_Institutionen/NetzzugangUndMesswesen/SmartGridEckpunktepapier/SmartGridPapierpdf.pdf?__blob=publicationFile, zuletzt geprüft am 15.11.2018.

Chen, Yahong; Deng, Changhong; Yao, Weiwei; Liang, Ning; Xia, Pei; Cao, Peng et al. (2019): Impacts of stochastic forecast errors of renewable energy generation and load demands on microgrid operation. In: *Renewable Energy* 133, S. 442–461. DOI: 10.1016/j.renene.2018.09.110.

Choi, T-M; Li, D.; Yan, H. (2003): Optimal two-stage ordering policy with Bayesian information updating. In: *Journal of the Operational Research Society* 54 (8), S. 846–859. DOI: 10.1057/palgrave.jors.2601584.

Dent, Chris J.; Bialek, Janusz W.; Hobbs, Benjamin F. (2011): Opportunity Cost Bidding by Wind Generators in Forward Markets: Analytical Results. In: *IEEE Transactions on Power Systems* 26 (3), S. 1600–1608. DOI: 10.1109/TPWRS.2010.2100412.

Deutsche Börse (2017): Market Model Continuous Auction (Xetra Release, 17.0).

Ecofys; Fraunhofer IWES (2017): Smart-Market-Design in deutschen Verteilnetzen. Entwicklung und Bewertung von Smart Markets und Ableitung einer Regulatory Roadmap. Studie im Auftrag von Agora Energiewende. Hg. v. Agora Energiewende. Online verfügbar unter https://www.agora-energiewende.de/fileadmin/Projekte/2016/Smart_Markets/Agora_Smart-Market-Design_WEB.pdf, zuletzt geprüft am 21.03.2017.

European Parliament (2019): European Parliament legislative resolution of 26 March 2019 on the proposal for a regulation of the European Parliament and of the Council on the internal market for electricity (recast). 2016/0379(COD). Online verfügbar unter http://www.europarl.europa.eu/doceo/document/TA-8-2019-0227_EN.html.

Fisher, Marshall L.; Hammond, Janice H.; Obermeyer, Walter R.; Raman, Ananth (1994): Making Supply Meet Demand in an Uncertain World. In: *Harvard Business Review*, S. 83–93, zuletzt geprüft am 04.09.2018.

Heer, Hans de; van den Reek, Willem (2018): Flexibility Platforms. White Paper. Hg. v. USEF foundation. USEF foundation.

Höckner, Jonas; Voswinkel, Simon; Weber, Christoph (2019a): Market distortions in flexibility markets caused by renewable subsidies – The case for side payments. In: *HEMF Working Paper* (05/2019). DOI: 10.2139/ssrn.3379900.

Höckner, Jonas; Voswinkel, Simon; Weber, Christoph; Kramer, Nikolaus; Rinck, Maximilian; Hofer, Steffen et al. (2019b): Der enera-Flexibilitätsmarkt als Zukunftsmodell für das Netzengpassmanagement. In: *Energiewirtschaftliche Tagesfragen (et)* (69), S. 14–18.

Huber, Julian; Köppl, Simon; Klempp, Nikolai; Schutz, Melanie; Heilmann, Erik (2018): Engineering Smart Market Platforms for Market Based Congestion Management. In: Unknown (Hg.): e-Energy'18. Proceedings of the 9th ACM International Conference on Future Energy Systems : June 12-15, 2018, Karlsruhe, Germany. the Ninth International Conference. Karlsruhe, Germany, 6/12/2018 - 6/15/2018. New York, New York: The Association for Computing Machinery, S. 544–549.

Khouja, Moutaz (1999): The single-period (news-vendor) problem: literature review and suggestions for future research. In: *Omega* 27 (5), S. 537–553. DOI: 10.1016/S0305-0483(99)00017-1.

Kyle, Albert S. (1985): Continuous Auctions and Insider Trading. In: *Econometrica* 53 (6), S. 1315. DOI: 10.2307/1913210.

Matevosyan, J.; Soder, L. (2006): Minimization of Imbalance Cost Trading Wind Power on the Short-Term Power Market. In: *IEEE Transactions on Power Systems* 21 (3), S. 1396–1404. DOI: 10.1109/TPWRS.2006.879276.

Morse, Philip M.; Kimball, George E. (1951): Methods of operations research. 1st ed. revised. Cambridge: M.I.T. Press.

Neuhoff, Karsten; Ritter, Nolan; Salah-Abou-El-Enien, Aymen; Vassilopoulos, Philippe (2016): Intraday Markets for Power - Discretizing the Continuous Trading? In: *DIW Discussion Papers* (1544).

Olivella-Rosell, Pol; Bullich-Massagué, Eduard; Aragüés-Peñalba, Mònica; Sumper, Andreas; Ottesen, Stig Ødegaard; Vidal-Clos, Josep-Andreu; Villafáfila-Robles, Roberto (2018): Optimization problem for meeting distribution system operator requests in local flexibility markets with

distributed energy resources. In: *Applied Energy* 210, S. 881–895. DOI: 10.1016/j.apenergy.2017.08.136.

Pinson, Pierre; Chevallier, Christophe; Kariniotakis, George N. (2007): Trading Wind Generation From Short-Term Probabilistic Forecasts of Wind Power. In: *IEEE Transactions on Power Systems* 22 (3), S. 1148–1156. DOI: 10.1109/TPWRS.2007.901117.

Radecke, Julia; Hefele, Joseph; Hirth, Lion (2019): Markets for Local Flexibility in Distribution Networks. ZBW – Leibniz Information Centre for Economics. Kiel. Online verfügbar unter <http://hdl.handle.net/10419/204559>, zuletzt geprüft am 14.11.2019.

Ruester, Sophia; Schwenen, Sebastian; Batlle, Carlos; Pérez-Arriaga, Ignacio (2014): From distribution networks to smart distribution systems: Rethinking the regulation of European electricity DSOs. In: *Utilities Policy* 31, S. 229–237. DOI: 10.1016/j.jup.2014.03.007.

Sethi, Suresh; Yan, Houmin; Yan, J. Houzhong; Zhang, Hanqin (2005): An Analysis of Staged Purchases in Deregulated Time-Sequential Electricity Markets. In: *Journal of Industrial and Management Optimization* 1 (4), S. 443–463. DOI: 10.2139/ssrn.1087589.

USEF foundation (2015): USEF: The Framework Explained. Hg. v. USEF foundation. Online verfügbar unter https://www.usef.energy/app/uploads/2016/12/USEF_TheFrameworkExplained-18nov15.pdf#popup__overlay1, zuletzt geprüft am 03.12.2018.

Yan, Houmin; Liu, Kw; Hsu, Arthur (2003): Optimal ordering in a dual-supplier system with demand forecast updates. In: *Production and Operations Management* 12 (1), S. 30–45, zuletzt geprüft am 04.09.2018.

Zheng, Meimei; Shu, Yan; Wu, Kan (2015): On optimal emergency orders with updated demand forecast and limited supply. In: *International Journal of Production Research* 53 (12), S. 3692–3719. DOI: 10.1080/00207543.2014.987882.

Appendix

Appendix A – Parameterization of the flexibility demand

We assume that the flexibility demand forecasts – when a congestion is expected – follows a normal distribution with locational parameter μ and uncertainty σ . To define the expected flexibility demand μ , the times series of empirical vertical load flow data¹² of a HV/MV transformer is evaluated (compare Figure 8, left) with positive values denoting flows from the MV to the HV grid level and vice versa. The red line represents the assumed maximum transformer capacity of 40 MW, so that the boxed area shows a period in which the load flow exceeds the transformer capacity. Consequently, this flow leads to a congestion that can be resolved on a flexibility market. Assessing the empirical data, the expected value of all quarters with an imminent congestion is on average 7 MW.

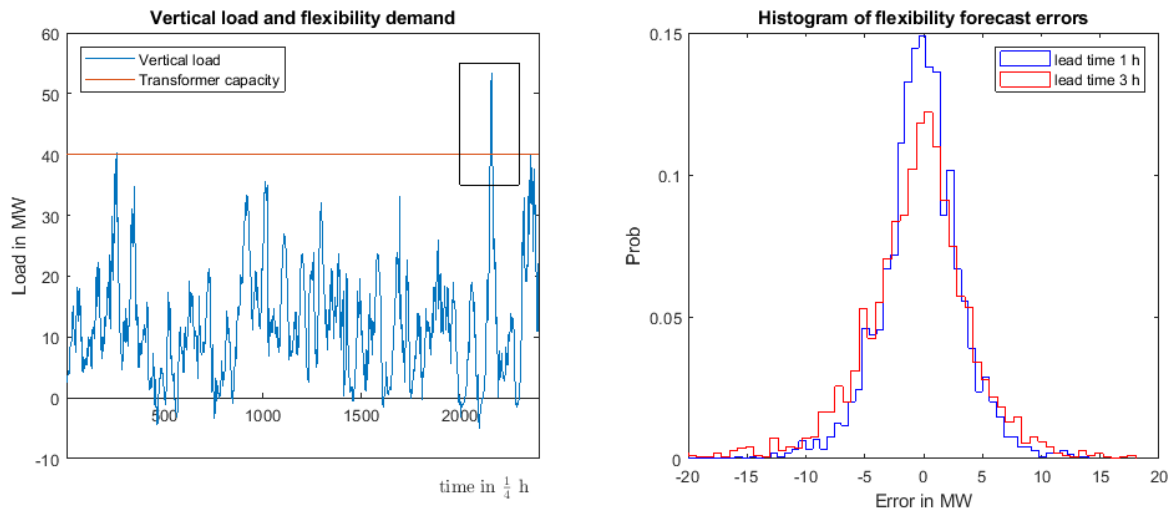

Figure 8: Empirical data of vertical load flow at a MV/MV transformer (left) and the histogram with the distribution of forecast errors ϵ with one and three hours lead time (right).

The uncertainty of the flexibility forecasts with lead time of one and three hours are deduced from empirical forecast data that include an expected value of the forecasted flexibility demand at t_1 and t_2 and the actual demand for every quarter of an hour. The forecast errors are determined by calculating the difference between forecasted and actual values of vertical load flows at the transformer. Histograms of these forecast errors ϵ are presented in Figure 8 (right). Analysing the forecast errors indicates that the forecasts underestimate the actual flexibility demand¹³ (cf. Table 4). Table 4 shows also the uncertainty of the forecasts as measured through the standard deviation of the forecast errors.

¹² Data was collected within the enera project (Source: enera)

¹³ According to the Jarque-Bera test, the assumption of normal distribution of the forecast errors cannot be confirmed. However, a t-test proves the underestimation of the actual flexibility demand of the forecasts as stochastically significant.

Table 4: Analysis of the empirical forecast errors.

	t_1	t_2
$E[\epsilon_i]$	-0.54 MW	-0.21 MW
$STD[\epsilon_i]$	4.65 MW	3.45 MW

Based on the standard deviation of the forecasts at different stages, the parameter $\xi = \frac{\sigma_2}{\sigma_1} = 0.74$ can be calculated, which describes the improvement of the forecast by the information update between stages 1 and 2. This value implies that the uncertainty of the flexibility forecast decreases to a level of 74% at stage 2 relative to the uncertainty at stage 1. In our model, we focus on the two stages of the flexibility market with lead times of one and three hours. Based on our empirical data which comprises quarterly updated forecasts for every quarter of an hour, yet also the uncertainty for different lead times can be computed (Table 5).

Table 5: Uncertainty of flexibility forecasts with different lead times.

Lead time	0.25 h	0.5 h	1 h	2 h	3 h	4 h	6h	12 h
σ_i	1.53	2.42	3.45	4.27	4.65	4.83	5.01	5.31

As described before, the improvement factors of the forecast between all lead times can be derived as well (Table 6).

Table 6: Improvement factors for flexibility forecasts with different lead times.

	to 12 h	6 h	4 h	3 h	2 h	1 h	0.5 h	0.25 h
from 12h	1	0,94	0,91	0,88	0,80	0,65	0,46	0,29
6h	-	1	0,96	0,93	0,85	0,69	0,48	0,30
4h	-	-	1	0,96	0,88	0,71	0,50	0,32
3h	-	-	-	1	0,92	0,74	0,52	0,33
2h	-	-	-	-	1	0,81	0,57	0,36
1h	-	-	-	-	-	1	0,70	0,44
0.5 h	-	-	-	-	-	-	1	0,63
0.25 h	-	-	-	-	-	-	-	1

One may note that the empirical forecast data used for this analysis is based so far on a time series of 25 days for a real HV/MV transformer because the documentation of forecast values has

just been implemented before. With an expanding data basis, the quality of the estimates for the forecast error are likely to improve yet not to change in substance.

Appendix B – Parameterization of flexibility supply

Gas compressor

The costs c_1^{gc} that the operator of the gas compressor is expected to bid into the flexibility market are determined by the cost spread between operating the compressor by gas turbine and by electric motor (cf. equation (16) in section 4.1.2). Besides the intraday wholesale prices for gas and electricity, the efficiency of the gas turbine and the electric motor, taxes and levies and the CO₂ price in case of the gas fired turbine need to be considered. In the example, the efficiency of the electric motor is assumed as $\eta_{el} = 90\%$ and the efficiency of the gas turbine is $\eta_{gas} = 30\%$. The CO₂-factor for the gas fuel is given by $\vartheta_{gas} = 0.2 \frac{tCO_2}{MWh_{th}}$.

All levies and taxes that arise when withdrawing power or gas from public grids are charted in Figure 9. In the reference case, a reduction of 80% of the EEG levy and network charges are assumed, whereas in case C, the gas compressor is not granted any exemptions. This results in a large difference in costs and has a significant impact on the competitiveness of the gas compressor on the flexibility market.

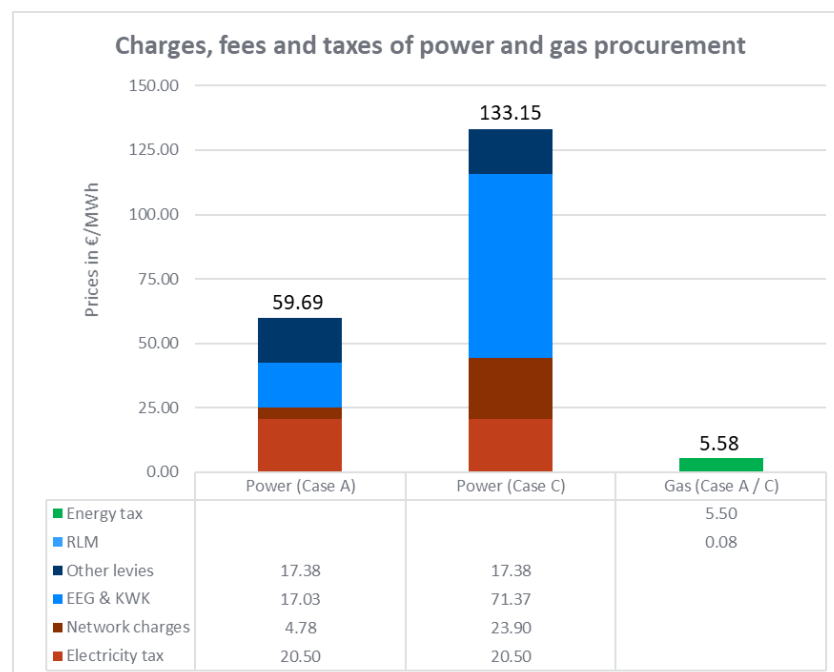

Figure 9: Electricity and gas taxes and levies 2018.

Using empirical wholesale prices of 2018 for power, gas and CO₂-certificates, a spread for every quarter of an hour can be calculated, which represents the minimum revenues that the gas compressor needs to earn on the flexibility market to provide her flexibility.

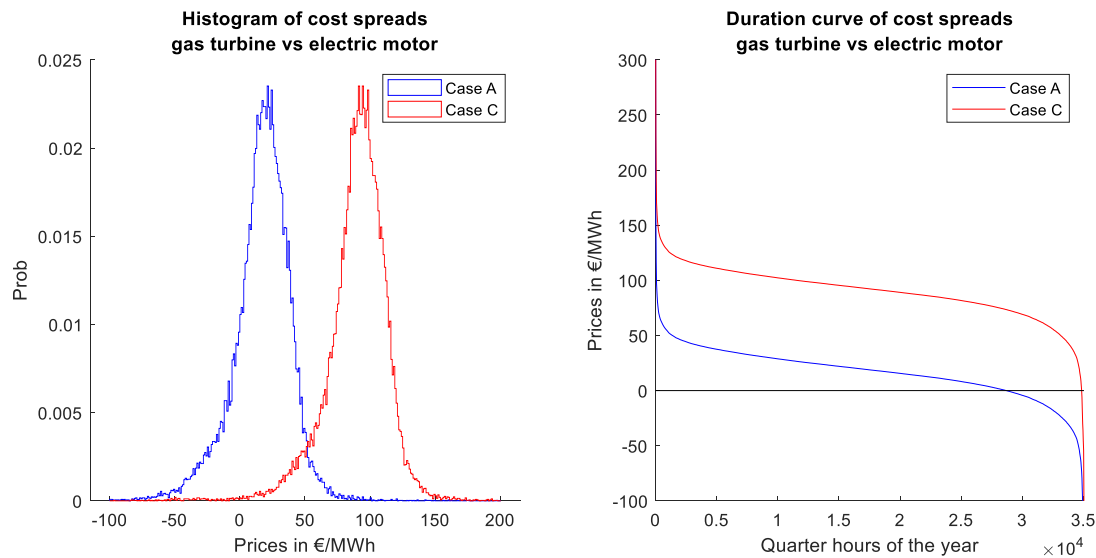

Figure 10: Distribution of costs spreads presented as histograms (left) and duration curves (right).

For the reference case, an average cost spread of $10 \frac{\text{€}}{\text{MWh}}$ is assumed which is based on a time period with rather low wholesale prices. This is a valid assumption because the flexibility demand is mostly driven by high wind power infeed, which in turn is correlated with low electricity prices in the wholesale market.

Cross-sectional technologies

It is assumed that cross-sectional technologies that will participate on the flexibility market are connected to an energy management system with a flexible operation mode. Hence, cross-sectional technologies are assumed to optimize their electricity demand in order to exploit the cheapest intraday prices. However, if the flexibility market incites load shifting, these plants can postpone their electrical withdrawal from periods with low energy prices $p_{planned}^{ID}$ to periods in which flexibility is needed. The additional costs that arise by withdrawing electricity during periods with higher electricity prices p_{flex}^{ID} define the minimum price at which cross-sectional technologies would provide flexibility (cf. equation (17)). This spread highly depends on the time interval in which the flexible load can be shifted. This time interval is restricted by backlog demand that arises when a specific plant shifts its load. Calculating the spreads between ID3 prices of every quarter hour and the minimum ID3 price in the specific load shifting interval results in a spread price at which the flexibility option would provide flexibility on the market.

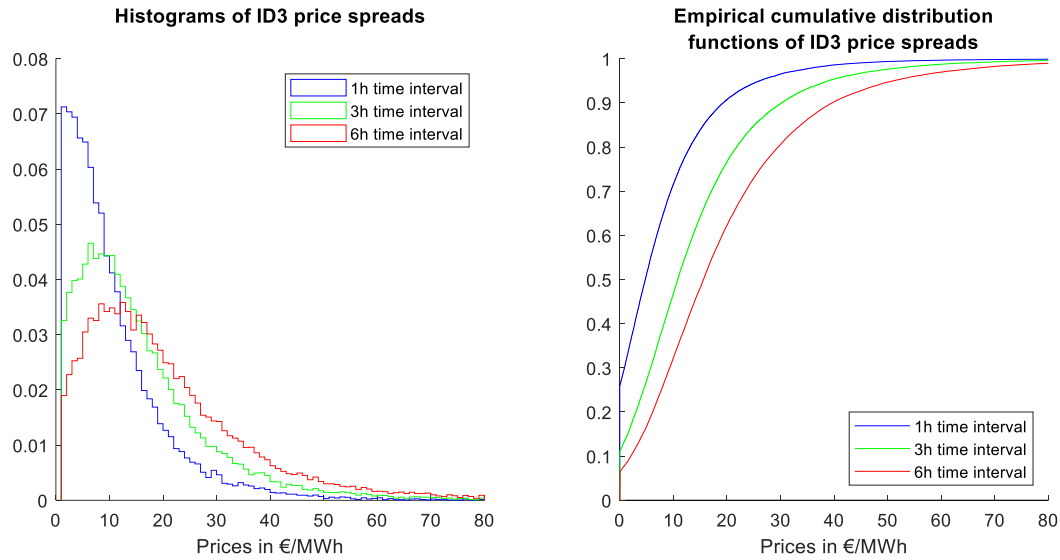

Figure 11: ID3 price spreads to the ID3 price minimum in a certain time interval.

In Figure 11, the distributions of price spreads are depicted as histograms and empirical cumulative distribution functions. It becomes evident that the price spreads highly depend on the considered time interval. The average spreads of the ID3 prices for shifting intervals of one, three and six hours, respectively, are $\bar{c}_{ID3}^{1h} = 7.71 \frac{\text{€}}{\text{MWh}}$, $\bar{c}_{ID3}^{3h} = 13.97 \frac{\text{€}}{\text{MWh}}$ and $\bar{c}_{ID3}^{6h} = 19.41 \frac{\text{€}}{\text{MWh}}$. Based on the value for the shifting interval of six hours, the cost parameter of cross-sectional technologies is set by $c_{1,2} = 20 \frac{\text{€}}{\text{MWh}}$. The other values are not considered in the cases, but a detailed analysis of cost sensitivities is conducted in section 4.4.1.

Appendix C – Nomenclature

η_j	efficiency of technology j
μ	locational parameter of a distribution
ξ	forecast improvement factor
$\rho(\mu_2)$	optimal procurement level of the single (late) stage Newsvendor problem
σ	uncertainty parameter of a distribution
ϑ_{gas}	CO ₂ factor for gas fuel
c_E	penalty for curtailment
$c_i^{(n)}$	unit cost of flexibility provided at stage i (provided by flexibility source n)
C_i	cost function in stage i
E_i	expected cost function evaluated with the information set I_i
$f(x)$	probability density function
$F(x)$	cumulative density function

$i \in \{1,2\}$	set of two stages
I_i	information set available at stage i
$K_{max}^{transformer}$	maximum capacity of the transformer
$n \in \{gc, cst\}$	set of flexibility sources (provided by gas compressors and cross-sectional technologies)
p_j^m	price of good j in market m
q_i	(possibly negative) analytical outcomes for quantities of flexibility procured
q_i^*	optimal ordering quantity
\hat{q}_i	actually procured quantities of flexibility
Q_{dem}	aggregated electricity demand
$Q_{flow}^{transformer}$	(back-)flows at the transformer
Q_{gen}	infeed of the (wind) power plants
t_i	time step
X	flexibility demand
\hat{X}_0	actual flexibility demand
z	multiplier

Correspondence

Julia Bellenbaum

Research assistant, Chair for Management Science and Energy Economics

House of Energy Markets and Finance

University of Duisburg-Essen, Germany

Universitätsstr. 12, 45117

Tel. +49 201 183-7383

Fax +49 201 183-2703

E-Mail julia.bellenbaum@uni-due.de

Jonas Höckner

Research assistant, Chair for Management Science and Energy Economics

House of Energy Markets and Finance

University of Duisburg-Essen, Germany

Universitätsstr. 12, 45117

Tel. +49 201 183-2643

Fax +49 201 183-2703

E-Mail jonas.hoekner@uni-due.de

Web www.hemf.net

Prof. Dr. Christoph Weber

Chair holder, Chair for Management Science and Energy Economics

House of Energy Markets and Finance

University of Duisburg-Essen, Germany

Universitätsstr. 12, 45117

Tel. +49 201 183-2966

Fax +49 201 183-2703

E-Mail christoph.weber@uni-due.de