

Mokherjee, Dilip; Napel, Stefan

**Working Paper**

## Intergenerational Mobility and Macroeconomic History Dependence

Discussion paper, No. 1

**Provided in Cooperation with:**

Aboa Centre for Economics (ACE), Turku

*Suggested Citation:* Mokherjee, Dilip; Napel, Stefan (2006) : Intergenerational Mobility and Macroeconomic History Dependence, Discussion paper, No. 1, Aboa Centre for Economics (ACE), Turku

This Version is available at:

<https://hdl.handle.net/10419/233217>

**Standard-Nutzungsbedingungen:**

Die Dokumente auf EconStor dürfen zu eigenen wissenschaftlichen Zwecken und zum Privatgebrauch gespeichert und kopiert werden.

Sie dürfen die Dokumente nicht für öffentliche oder kommerzielle Zwecke vervielfältigen, öffentlich ausstellen, öffentlich zugänglich machen, vertreiben oder anderweitig nutzen.

Sofern die Verfasser die Dokumente unter Open-Content-Lizenzen (insbesondere CC-Lizenzen) zur Verfügung gestellt haben sollten, gelten abweichend von diesen Nutzungsbedingungen die in der dort genannten Lizenz gewährten Nutzungsrechte.

**Terms of use:**

*Documents in EconStor may be saved and copied for your personal and scholarly purposes.*

*You are not to copy documents for public or commercial purposes, to exhibit the documents publicly, to make them publicly available on the internet, or to distribute or otherwise use the documents in public.*

*If the documents have been made available under an Open Content Licence (especially Creative Commons Licences), you may exercise further usage rights as specified in the indicated licence.*

*Dilip Mookherjee — Stefan Napel*  
**Intergenerational Mobility  
and Macroeconomic  
History Dependence**

**Aboa Centre for Economics**

Discussion Paper No. 1  
Turku 2006



Copyright © Author(s)

ISSN 1796-3133

Turun kauppakorkeakoulun monistamo  
Turku 2006

*Dilip Mookherjee — Stefan Napel*  
**Intergenerational Mobility and  
Macroeconomic History Dependence**

**Aboa Centre for Economics**  
Discussion Paper No. 1  
March 2006

**ABSTRACT**

That historical inequality can affect long run macroeconomic performance has been argued by a large literature on ‘endogenous inequality’ using models of indivisibilities in occupational choice, in the presence of borrowing constraints. These models are characterized by a continuum of steady states, and absence of mobility in any steady state. We augment such a model with heterogeneity in agents’ abilities in order to generate occupational mobility in steady state. Steady states with mobility are shown to be generically locally unique and finite in number. We provide forms of heterogeneity for which steady state is globally unique, and others where they are non-unique. Agent heterogeneity may also cause competitive equilibrium dynamics to fail to converge, but convergence can be restored in the presence of sufficient ‘inertia’ or occupation switching costs.

JEL Classification: D31, D91, E25, I21, J24, O11, O15

Keywords: Intergenerational mobility, occupational choice, human capital, borrowing constraints, inequality, history-dependence

## **Contact information**

Dilip Mookherjee  
Boston University  
Department of Economics  
270 Bay State Road  
Boston MA, 02215  
Fax +1-617-353-4143  
dilipm@bu.edu

Stefan Napel  
University of Hamburg  
Department of Economics  
Von-Melle-Park 5  
D-20146 Hamburg  
Fax +49-40-42838-3957  
napel@econ.uni-hamburg.de

## **Acknowledgements**

Napel gratefully acknowledges financial support from the German Academic Exchange Service (DAAD), and thanks the Department of Economics, Boston University for hosting his visit for a year during which this research project was started. Mookherjee acknowledges support from the MacArthur Foundation Inequality Network, and National Science Foundation grant no. SES-0418434. We thank two anonymous referees for extraordinarily helpful comments. We also acknowledge discussions with Alfred Müller and Jörgen Weibull, and comments of seminar participants at Hamburg, Salerno, Simon Fraser and the June 2004 Stanford SITE workshop on Development Economics, which have helped improve the paper.

# 1 Introduction

The role of history in powerfully shaping the nature of economic development many centuries later has been argued by many recent authors ([1],[6],[12]). These authors describe how historical inequality associated with colonial institutions can help explain differences in economic backwardness even long after these institutions have disappeared. This raises the question: what prevents such countries from catching up with more developed countries, once these colonial institutions have disappeared?

Theoretical explanations of the role of historical inequality in determining long run macroeconomic performance have been based on indivisibilities in occupational choice combined with credit constraints. In [7],[15], and [16], equal and unequal steady states are shown to co-exist, with historical distributions determining which steady state the economy converges to. In much of the literature in this field (e.g., [4-5],[13],[19],[24],[27]) a continuum of steady states are shown to exist, all of which are unequal, and involve zero mobility.<sup>1</sup> A typical steady state without mobility entails strict incentives for skilled parents to invest in the skills of their children, and likewise for unskilled parents not to invest: these strict incentives are preserved with small perturbations in the proportion of skilled households, thus allowing the steady state set to form a continuum. The steady states are ordered by per capita skill, income, consumption, and wage inequality; those with higher per capita income also involve lower inequality (and so are representative of more developed countries). Since there is a continuum of such steady states, small temporary shocks or policies to steady states have permanent macro effects, and can therefore be remarkably effective in affecting long term development.

The feature of zero mobility in income or occupations is clearly at odds with reality: even the most unequal societies are typically characterized by *some* mobility. One would expect that it would be relatively straightforward to explain the presence of occupational mobility by enriching these models to allow heterogeneity of agents' characteristics, in the style of [9],[20] or [22]. For instance, if children's learning abilities are randomly generated, occupational mobility would emerge owing to the tendency for unusually gifted children in poor families to acquire education (and conversely untalented children in rich families would fail to become educated). Alternatively if wage incomes within any occupation are subject to sources of randomness (as in [7] and [26]), it could generate mobility (as some unskilled households earn above-normal wages, or skilled households earn below-normal wages).

---

<sup>1</sup>The continuum of steady states also appears in [15-16]. However, there are some papers in which there are steady states with mobility, such as [7],[9],[20],[22],[26]. A detailed comparison with the existing literature is provided in Section 6.

This paper studies the implications of introducing such forms of heterogeneity (or income risk) in a model of human capital accumulation which generates positive mobility in steady state. The model has two occupations, skilled and unskilled. To enter the skilled occupation an agent needs to acquire an education. Agents are heterogenous with respect to their cost of getting educated, reflecting their innate learning ability; these costs are treated as i.i.d. random variables. We abstract from income risk for the sake of simplicity, though the effects of such risk would be qualitatively similar to the effects of heterogenous learning ability.<sup>2</sup> Parents cannot borrow against their children's future earnings: this is the key capital market imperfection.<sup>3</sup>

We explore existence and multiplicity of steady states as well as non-steady-state dynamics within this model in some generality. We provide three principal sets of theoretical results. First, steady states with mobility are (generically) locally unique and finite in number. This is in contrast to the case of homogeneous agents and riskless incomes which generally has a continuum of steady states.

Second, we explore conditions for global uniqueness, and show how these depend on the ability distribution. We provide sufficient conditions only in terms of the range (i.e., endpoints) of the distribution for both uniqueness and non-uniqueness of steady states. Global uniqueness obtains if the range of schooling costs is shifted down sufficiently, and preferences for schooling do not switch more than twice with respect to a rise in the skill ratio in the economy. In contrast, there is (generically) more than one mobile steady state if the range of schooling cost is shifted up sufficiently.

Third, we explore non-steady-state dynamics. With agent homogeneity and lack of income risk, competitive equilibrium with perfect foresight always converges to a steady state. With the introduction of heterogeneity, competitive equilibrium may fail to converge. However global convergence can be restored with restrictions on the speed of 'adjustment'. Under these conditions, multiplicity or otherwise of steady states translates into corresponding statements of dependence of long run outcomes on initial conditions.

We also numerically compute the set of steady states in an economy with Cobb-Douglas technology, logarithmic utility and a variety of ability distribu-

---

<sup>2</sup>Indeed, in the case of logarithmic utility it is easily verified that the two phenomena (heterogenous abilities and income risk) are isomorphic with respect to investment incentives and therefore the same model and results apply to the context of income risk as well. We are also abstracting from intergenerational transmission of ability, in the interest of simplicity. Incorporating this would require abilities of parents and children to be correlated.

<sup>3</sup>The benchmark case of homogeneous ability corresponds to the models in [13],[19],[24]. The baseline model in this paper differs from [24] only with respect to the bequest motive: instead of a dynastic bequest motive it is assumed that parents care about the incomes earned by their children, apart from their own consumption.

tions. In all examples with a continuous ability distribution (including uniform, exponential and truncated normal distributions) with a wide enough support, and with a low level poverty trap (where at low enough skill ratios, unskilled wages fall below the minimum education cost, so that unskilled parents cannot afford to educate their children), we found only one locally stable steady state with mobility. However, examples of multiple locally stable steady states with mobility can be constructed with discrete (or sufficiently ‘jagged’ continuous) ability distributions, or with standard well-behaved distributions when a low level poverty trap does not exist.

The principal implication of these results is that the extent of history dependence (or the steady state set) shrinks markedly upon applying arbitrarily ‘small’ perturbations of a homogeneous agent economy with perfect income certainty. In general, small temporary shocks do not affect long run outcomes. For suitable ranges of the distribution of ability shocks, as well as in our numerical examples with well-behaved continuous ability distributions and a low level poverty trap, the long run outcome is unique and independent of initial conditions. For others, it is non-unique and there exist ‘large’ temporary shocks or policies with permanent impact.

The main contrast with papers such as [7],[26] is that they provide examples of particular parameter values for which multiple steady states with mobility exist, but do not provide more general results. For instance, they do not address issues of local uniqueness, whether there are parameter zones with a unique steady state, or the general dynamic properties of the system. The contrast with [9] or [20] is that they have a unique steady state with mobility, owing mainly to their assumption of a convex investment technology.

The intuition for our uniqueness results is somewhat akin to the effects of enriching the occupational space to allow diversity of occupations (i.e., removing the indivisibility in investment options). As shown in [24,25] steady states with occupational diversity are characterized by incentive constraints in the form of equality rather than inequality constraints: agents have to be locally indifferent between their own occupation and neighboring occupations. These equality constraints pin down the steady state uniquely. In this paper we retain occupational indivisibilities and instead introduce heterogeneity in education cost. Steady states with mobility are characterized by ability thresholds for educational investments among unskilled and skilled households respectively, where agents at the threshold are indifferent between educating and not educating their children. Hence the steady state is characterized by incentive constraints for the threshold type that take the form of equality constraints. This removes the scope for local multiplicity of mobile steady states: small perturbations to the skill ratio cause the steady state conditions to be violated.

A potential criticism of this paper is that long run ergodic properties may



be of less interest than the short or intermediate run, i.e., where the extent of persistence of income or occupational status is more fundamental. From this perspective the effect of introducing small shocks to income or ability to a standard endogenous inequality model is hardly dramatic. We would reply to such a criticism as follows. First, much of the discussion in the literature on historical origins of underdevelopment spans several centuries, so presumably the long run is of some interest. Second, there is no reason to believe that the importance of ability heterogeneity or residual income risk is small, relative to the effect of parental status. Empirical findings suggest that differences in parental status explains part of the difference between earnings of children, but considerable residual unexplained variation still remains (see, e.g., [10] for a summary of empirical results in the field, where more than 50% of variation in earnings typically remain unexplained). Hence the dynamics induced by such shocks may be just as important as those associated with parental status. Models where such heterogeneity or income risk are substantial would seem to be more focal than ones where they are entirely absent. Moreover, they are needed to explain the fact that almost every society experiences non-negligible mobility. Hence conclusions concerning history dependence are better based on models of this genre. And as we show, such models tend to generate long run history dependence only under special conditions, suggesting the need for empirical research concerning the validity of such conditions as a way of testing the hypothesis of history dependence.<sup>4</sup>

Section 2 introduces the model. Section 3 explains the baseline case of homogeneous ability, where the set of steady states forms a continuum, and competitive equilibrium dynamics are globally convergent and history-dependent. Section 3 provides steady state uniqueness results for the model with heterogeneity, while Section 4 discusses non-steady state dynamics. Section 5 describes how this paper relates to existing literature in some detail. Section 6 concludes with a discussion of future research questions concerning occupational mobility.

## 2 Model

There is a continuum of families indexed by  $j \in [0, 1]$ . At each date  $t = 0, 1, 2, \dots$  family  $j$  is represented by an agent who lives as an adult for one period. This agent is also referred to by  $j$ . Any generation- $t$  agent  $j$  has an occupation  $\sigma_t^j \in \{n, s\}$ , referring to either *unskilled* or *skilled* labor. The fraction of skilled agents in period  $t$  is denoted by  $\lambda_t$ . Each agent supplies one unit of labor inelastically, as long as the wage rate exceeds a positive reservation wage  $\underline{w} > 0$

---

<sup>4</sup>For instance, the conditions involved include non-monotonicity of investment incentives of unskilled households with respect to the skill ratio in the economy, which is empirically testable.

which represents the value of leisure or some backyard self-employment option.

The economy produces a single consumption good under conditions of perfect competition. Output is given by a production function  $H$  which is assumed to be twice continuously differentiable, strictly concave in both types of labor, has constant returns to scale, and satisfies Inada end-point conditions. The marginal products of the unskilled and skilled respectively are given by functions  $h^n(\lambda)$  and  $h^s(\lambda)$  respectively, where  $h^n$  is strictly increasing,  $h^s$  is strictly decreasing,  $h^n(0) = 0 = h^s(1)$ ;  $h^n(1) = h^s(0) = \infty$ .

Skilled workers can choose whether to work as skilled or unskilled employees, implying that the skilled wage can never fall below the unskilled wage. Let  $\bar{\lambda} \in (0, 1)$  be defined by the property that  $h^n(\bar{\lambda}) = h^s(\bar{\lambda})$  ( $= \bar{w}$  say). Then if  $w^n(\lambda)$  and  $w^s(\lambda)$  denote wages of the unskilled and skilled respectively, and  $\underline{\lambda}$  denotes the skill ratio at which  $h^n = \underline{w}$ , it follows that equilibrium wages are given by<sup>5</sup>

$$w^n(\lambda) = \begin{cases} \underline{w} & \text{if } \lambda \leq \underline{\lambda} \\ h^n(\lambda) & \text{if } \lambda \in (\underline{\lambda}, \bar{\lambda}) \\ h^n(\bar{\lambda}) & \text{if } \lambda \geq \bar{\lambda}, \end{cases} \quad (1)$$

and

$$w^s(\lambda) = \begin{cases} h^s(\underline{\lambda}) & \text{if } \lambda \leq \underline{\lambda} \\ h^s(\lambda) & \text{if } \lambda \in (\underline{\lambda}, \bar{\lambda}) \\ h^s(\bar{\lambda}) & \text{if } \lambda \geq \bar{\lambda}. \end{cases} \quad (2)$$

The ability of a child is represented by the cost  $x \geq 0$  (denominated in units of the consumption good) that its parent would have to incur in order for the child to enter the skilled profession. These costs are i.i.d. random variables with a distribution function  $F$  on a range  $[\underline{x}, \bar{x}]$ . The endpoints are characterized by the property that  $\underline{x} = \inf\{x | F(x) > 0\}$  and  $\bar{x} = \sup\{x | F(x) < 1\}$ . Most of our results will be stated in terms of properties of these endpoints, and will not depend on other features of the distribution  $F$ . So as to admit a wide range of possible distributions, we shall allow  $F$  to be generated by a mixture of a continuous density  $f$  and a finite number of mass points over the range  $[\underline{x}, \bar{x}]$ .<sup>6</sup>

Parents have to finance their child's education but cannot borrow against their descendent's income. So education for a generation- $t$  agent  $j$  has to be paid from its parent's income  $w_{j;t-1}$ .<sup>7</sup> There is no way to transfer wealth be-

<sup>5</sup>If the skill ratio in the economy as a whole falls below  $\underline{\lambda}$ , the skill ratio in the production sector will be pegged at  $\underline{\lambda}$ , with surplus unskilled workers withdrawing from the production sector into leisure or self-employment.

<sup>6</sup>The only essential restriction here is that we rule out an infinite set of mass points. This is mainly a technical simplification, one that we do not expect to have any serious consequences.

<sup>7</sup>This condition can be relaxed considerably to allow some borrowing but either subject to a credit limit or with borrowing rates exceeding lending rates. All that matters is that the

tween generations apart from parents' educational investment.<sup>8</sup> The investment needed to work in the unskilled profession is zero.

Let  $I_t^j$  equal 1 if generation- $t$  agent  $j$  decides to invest in his child's education and 0 otherwise (corresponding to  $\sigma_{t+1}^j = s$  and  $\sigma_{t+1}^j = n$ , respectively). The parents' bequest motive takes a form of *paternalistic altruism*, where they care about the wealth of their children, apart from their own consumption: agent  $j$  selects  $I_t^j$  to maximize

$$U(w_{j;t} - xI_t^j) + V(w_{j;t+1}), \quad (3)$$

where  $U$  and  $V$  are both strictly increasing, continuously differentiable functions,  $U$  is strictly concave, and  $w_{j;t+1}$  is determined by  $I_t^j$  and the equilibrium skill ratio in the economy at  $t + 1$ .<sup>9</sup>

Given skill ratio  $\lambda_t$  in generation  $t$ , the income distribution in that generation is determined: fraction  $\lambda_t$  households earn  $w^s(\lambda_t)$  while the remaining earn  $w^n(\lambda_t)$ . Define the benefit to a generation  $t$  parent of investing in his child's education:  $B(\lambda_{t+1}) \equiv V(w^s(\lambda_{t+1})) - V(w^n(\lambda_{t+1}))$ , and the utility sacrifice  $C^o(\lambda_t, x) \equiv U(w^o(\lambda_t) - x) - U(w^o(\lambda_t))$  entailed in this investment if the parent is in occupation  $o$  and the education cost is  $x$ . The consequent net benefit of investing is  $g^o(\lambda_t, \lambda_{t+1}, x) \equiv B(\lambda_{t+1}) - C^o(\lambda_t, x)$ . Clearly  $g$  is strictly decreasing in  $x$ , going to  $-\infty$  as  $x \rightarrow \infty$  and nonnegative for  $x = 0$ . Hence we can define a threshold cost  $x^o(\lambda_t, \lambda_{t+1})$  for occupation  $o$  parents as the solution to  $g^o(\lambda_t, \lambda_{t+1}, x) = 0$ , at which they are indifferent between investing and not.

Let  $F^0(x)$  denote the fraction of children with education cost *strictly* below  $x$ . Then

$$\sigma(\lambda_t, \lambda_{t+1}) \equiv (1 - \lambda_t)F^0(x^n(\lambda_t, \lambda_{t+1})) + \lambda_t F^0(x^s(\lambda_t, \lambda_{t+1})) \quad (4)$$

is the fraction of generation  $t$  households that strictly prefer to invest, while

$$\begin{aligned} i^n(\lambda_t, \lambda_{t+1}) &\equiv (1 - \lambda_t)[F(x^n(\lambda_t, \lambda_{t+1})) - F^0(x^n(\lambda_t, \lambda_{t+1}))] \\ i^s(\lambda_t, \lambda_{t+1}) &\equiv \lambda_t[F(x^s(\lambda_t, \lambda_{t+1})) - F^0(x^s(\lambda_t, \lambda_{t+1}))] \end{aligned}$$

cost of financing investments be higher for poorer parents.

<sup>8</sup>Consequences of allowing supplemental financial bequests are discussed in [23,25]. Inequality is then no longer inevitable, as parents of unskilled agents can make compensating financial bequests to allow equality of income with skilled agents. However this requires a sufficiently strong bequest motive, relative to the span of earning differentials between occupations. For less strong bequest motives, inequality is again inevitable in steady state, and properties of that model concerning steady states and non-steady state dynamics are similar to those in the current model where financial bequests are not allowed.

<sup>9</sup>This represents a bequest motive less far-sighted and sophisticated than a Barro-Becker dynastic motive where parents care about the utility of their child, and thus indirectly about the consumption of all their future descendants. But it is more sensitive to the consequences of bequests for the well-being of their children, compared to a 'warm-glow' bequest motive (where they care only about the size of the bequest apart from their own consumption) traditionally assumed in much of the literature (e.g., [7],[15]).

denote the measure of unskilled and skilled households respectively that are indifferent between investing and not investing.

**DEFINITION 1**  $\lambda_{t+1}$  is a **competitive equilibrium skill ratio** in generation  $t + 1$  given skill ratio  $\lambda_t$  at  $t$  if there exist  $\alpha, \beta$  both in  $[0, 1]$  such that

$$\lambda_{t+1} = \sigma(\lambda_t, \lambda_{t+1}) + \alpha i^n(\lambda_t, \lambda_{t+1}) + \beta i^s(\lambda_t, \lambda_{t+1}). \quad (5)$$

In order to avoid a trivial equilibrium, we assume:

**(A1)**  $F(0) < \bar{\lambda}$ .

If we define a *genius* to be a child who acquires skill at zero cost ( $x = 0$ ) then (A1) stipulates that the fraction of geniuses born is less than the skill ratio  $\bar{\lambda}$  where skilled and unskilled wages are equalized. Clearly all geniuses will acquire skill as long as skilled wages exceed unskilled wages. So if (A1) does not hold, equilibrium will involve  $\lambda_t \geq \bar{\lambda}$  for all  $t$ : there is perfect income equality at all dates and no one with positive education cost will ever invest.

**LEMMA 1** Suppose (A1) holds. Given any skill ratio  $\lambda_t$  in generation  $t$ , a competitive equilibrium skill ratio at  $t + 1$  exists, is unique, and less than  $\bar{\lambda}$ .

The proof of the Lemma as well as of subsequent results is provided in the Appendix. Existence and uniqueness rest on the fact that the measure  $\phi_{\lambda_t}(\lambda_{t+1}^e)$  of households willing to invest at the current skill ratio  $\lambda_t$  is (apart from constituting a convex-valued u.s.c. correspondence) strictly decreasing in the skill ratio  $\lambda_{t+1}^e$  they anticipate for the next generation. This is illustrated in Figure 1. Under (A1), the equilibrium skill ratio must be below  $\bar{\lambda}$ , with wage inequality in every generation.<sup>10</sup> Hereafter we denote the mapping of equilibrium skill ratios across successive generations by  $\lambda_{t+1} = E(\lambda_t)$ .

**DEFINITION 2** A **steady state (SS)** skill ratio  $\lambda^*$  is a stationary competitive equilibrium skill ratio, i.e., a fixed point of  $E$ . If there exists a stationary competitive equilibrium with skill ratio  $\lambda^*$  in which a positive measure of unskilled (respectively skilled) households in any given generation become skilled (resp. unskilled) in the next generation, then  $\lambda^*$  is a **steady state with mobility (SSM)**.

Steady states can be characterized in terms of equality of upward and downward mobility flows. Define these as follows:

$$\begin{aligned} u(\lambda) &\equiv \left\{ \mu \mid \mu = (1 - \lambda)[F^0(x^n(\lambda, \lambda)) + \alpha i^n(\lambda, \lambda)] \text{ for some } \alpha \in [0, 1] \right\} \\ d(\lambda) &\equiv \left\{ \mu \mid \mu = \lambda[1 - F(x^s(\lambda, \lambda))] + \beta i^s(\lambda, \lambda) \text{ for some } \beta \in [0, 1] \right\} \end{aligned}$$

---

<sup>10</sup>Otherwise there are no benefits from investing, and anyone with positive  $x$  will not invest. So the skill ratio at the next generation cannot exceed  $F(0)$ , which owing to (A1) is less than  $\bar{\lambda}$ , contrary to the premise.

Then  $\lambda$  is a SS if and only if  $u(\lambda) \cap d(\lambda) \neq \emptyset$ . It is a SSM if there exists a positive mobility flow  $\mu \in u(\lambda) \cap d(\lambda)$ .

**PROPOSITION 1** *A SS always exists.*

The rest of the paper turns attention to uniqueness and stability of steady states.

### 3 The Case of Homogeneous Agents

We illustrate first the case where the distribution of  $x$  is degenerate, concentrated at a single  $x = x^* > 0$ , so  $\underline{x} = \bar{x} = x^*$ . This is essentially the model considered by previous literature ([13],[19],[24],[27]). For the sake of completeness, we provide a proof of the following proposition, particular versions of which are available in these papers.<sup>11</sup> Figure 2 illustrates the set of steady states and the nature of the dynamics.

**PROPOSITION 2** *With homogeneous agents ( $\underline{x} = \bar{x} = x^* > 0$ ):*

(a) *If  $x^*$  is large enough that*

$$C^s(\underline{\lambda}, x^*) > B(\underline{\lambda}) \tag{6}$$

*there is a unique SS at  $\lambda = 0$ ;*

(b) *Otherwise there is a continuum of SS's. If*

$$C^s(\underline{\lambda}, x^*) < B(\underline{\lambda}) \tag{7}$$

*there exists an interval of steady state skill ratios within which higher  $\lambda$  SS's are associated with higher per capita income and lower skill premium in wages;*

(c) *Every SS entails zero mobility;*

(d) *From any initial skill ratio  $\lambda_0$  at  $t = 0$ , the equilibrium skill ratio converges to a SS, and the dynamics is described as follows. If  $\lambda_0$  is a SS then  $\lambda_t = \lambda_0$  for all  $t$ . If  $\lambda_0$  exceeds the highest SS  $\tilde{\lambda}$  then the skill ratio falls to a SS  $\lambda^* < \tilde{\lambda}$  at  $t = 1$  and stays there for ever after. If neither of these two cases apply then  $\lambda_t$  increases monotonically in  $t$  and converges to the nearest SS  $\hat{\lambda}$  to the right of  $\lambda_0$  where the unskilled are indifferent between investing and not.*

---

<sup>11</sup>The papers cited above confine their analysis to steady states, and use a dynastic bequest motive. So the result here differs in its use of a different bequest motive, and a complete description of the dynamics. Note however that a complete analysis of dynamics of the model with a dynastic bequest motive was provided earlier by [27].

The model exhibits an extreme form of history dependence, both at the household and economy-wide level. In steady state, there cannot be any mobility, so a household's occupation is determined entirely by the occupation of its ancestors. Moreover, there is macroeconomic hysteresis, with a continuum of steady states varying in per capita income and inequality. Starting at any interior steady state a one-time small shock to the skill ratio induced either by demographics, technology, endowments or policy will have a permanent macro effect. The same is not necessarily true out of steady state, however — e.g., if the economy starts at a low (between  $\lambda^p$  and  $\lambda^1$  in Figure 2) non-steady state skill ratio, then a small perturbation in the skill ratio will only have a short term effect, as the equilibrium skill ratio will converge eventually to the same steady state  $\lambda^1$ .

Note also that it is possible for the set of steady states to not be connected, as illustrated in Figure 2. The model can therefore explain the phenomenon of distinct ‘convergence clubs’ at different ranges of per capita income and human capital.<sup>12</sup> This owes to possible non-monotonicity of the educational incentives of unskilled with respect to the skill ratio. As  $\lambda$  increases, the benefit from educating children decreases, lowering educational incentives for all parents. At the same time, the unskilled wage increases, reducing the poverty of unskilled parents, and lowering the sacrifice entailed in educating their children. So the cost and benefit functions for the unskilled can intersect more than once. These non-monotonicities will play an important role in the discussion of uniqueness in the next section.

## 4 Heterogeneous Ability

### 4.1 Examples

To illustrate the impact of introducing heterogenous abilities, consider the following variation on the homogenous agent case, where a small fraction of children are unusual with regard to their learning abilities. Here the distribution over  $x$  is concentrated at three mass points  $\underline{x} = 0 < x^* < \bar{x}$ . A fraction  $\gamma$  of children are *geniuses*, with an educational cost of  $\underline{x} = 0$ , so it will be optimal for them to become educated in all situations. Another fraction  $\iota$  of children are *idiots*, with an educational cost  $\bar{x}$  so large that their parents will never want to try to educate them, even if they were skilled and the skill scarcity is at its greatest (i.e.,  $C^s(\underline{\lambda}, \bar{x}) > B(\underline{\lambda})$ ). The remaining children are *normal* and have a common (fixed) educational cost of  $x^*$ , as in the previous section. Let the highest steady state interval in the homogeneous agent economy be denoted by  $[\lambda^1, \lambda^2]$ . Sup-

---

<sup>12</sup>See [3] for a description of the relevant stylized facts concerning convergence clubs, and an alternative explanation in terms of financial development.

pose also that the proportion of geniuses and idiots in the population is small enough in the sense that  $\gamma < \lambda^2, \iota < 1 - \lambda^1$ .

Consider the case where  $\frac{\gamma}{\iota}$  lies in between  $\frac{\lambda^1}{1-\lambda^1}$  and  $\frac{\lambda^2}{1-\lambda^2}$ . In this case define  $\lambda^*$  by the property that  $\frac{\lambda^*}{1-\lambda^*} = \frac{\gamma}{\iota}$ , which then falls in between the two endpoints  $\lambda^1$  and  $\lambda^2$  of the steady state interval. For any  $\lambda$  in this interval to the left of  $\lambda^*$ , there will be a ‘rightward’ drift in the skill ratio owing to the presence of the unusual children. Those with normal children will behave exactly as in the homogeneous agent economy. But not the unusual children: geniuses from unskilled households will acquire skills, and idiots from skilled households will not. To the left of  $\lambda^*$  the upward flow of geniuses from unskilled households will dominate the downward one of idiots from skilled households, inducing the skill ratio to rise. This destabilizes what would have constituted a steady state in a population constituted entirely of ‘normal’ children, except only at  $\lambda^*$ . The perturbation created by introduction of a few unusual children has the effect of singling out a unique steady state from the continuum of steady states in the homogenous agent economy.

Figures 3(a) and (b) illustrate upward and downward flows  $u(\lambda)$  and  $d(\lambda)$  for special numeric instances of the homogenous baseline case and its genius-idiot variation.<sup>13</sup> Figure 3(c) shows the effect of heterogeneous costs that are uniformly distributed on a narrow interval. The extent of heterogeneity there is insufficient to generate steady state mobility. The support of the cost distribution is widened in (d) to induce mobility in steady state, but then the steady state becomes unique. In example (d), notice that the investment preferences amongst the unskilled exhibit are non-monotone.

Figure 4 shows the effect of different truncations of a normal cost distribution. In (a), the support is again too narrow for any steady state mobility, while costs in (b) have full support on the positive reals. Figures 4(c) and (d) show intermediate cases with a positive lower bound on costs, i.e., ruling out very high ability levels. Very low ability levels are also ruled out in (c), resulting in a unique steady state with mobility in addition to an interval of immobile steady states (the latter require a sufficiently low reservation wage). In (b) and (c) we obtain a unique steady state with mobility. A case of multiple mobile steady states arises in (d), in which there is no lower bound to ability (i.e., education costs have no upper bound). However, only one of the two mobile steady states is locally stable.

## 4.2 The General Case with Heterogenous Ability

Return now to the general case of heterogeneous learning abilities, where  $\underline{x} < \bar{x}$ . As explained above, this is essential in order to explain mobility in steady state.

<sup>13</sup>Figures 3–5 are based on  $H(\lambda, 1 - \lambda) = \sqrt{\lambda(1 - \lambda)}$  and  $U \equiv V \equiv \ln$ .

Indeed, there must be enough variation in ability to allow upward and downward mobility to co-exist, so we hereafter assume that  $\underline{x}$  and  $\bar{x}$  are sufficiently disparate that at some skill ratio some children from unskilled families will invest and some from skilled families will not:

(A2) There exists  $\check{\lambda} \in (0, \bar{\lambda})$  such that

$$B(\check{\lambda}) - C^n(\check{\lambda}, \underline{x}) > 0 > B(\check{\lambda}) - C^s(\check{\lambda}, \bar{x}) \quad (8)$$

This is clearly a necessary condition for existence of a SS with mobility. The following Lemma provides a sufficient condition for *every* SS to involve mobility.

**LEMMA 2** *Given any  $\bar{x} > 0$  there exists a threshold  $\hat{x}(\bar{x}) > 0$  for  $\underline{x}$  below which every SS involves positive mobility.*

We now present the first major result of the paper, concerning local uniqueness and finiteness of the set of SS's in the presence of heterogeneity. For this we parameterize the altruistic component of the parental utility  $V(w_{j;t+1}) = \delta W(w_{j;t+1})$ , where  $\delta > 0$  is a scaling parameter measuring the extent of altruism, and  $W$  is a strictly increasing, continuously differentiable function. Generic statements will refer to the set of values of  $\delta$  for which a given property is true, and will mean that its complement is a set of zero Lebesgue measure.

**PROPOSITION 3** *Suppose (A1) and (A2) hold. Then generically there are a finite number of mobile steady state skill ratios.*

The main idea underlying the result is the following. Mobile steady states are characterized by equality of upward and downward flows, which are  $C^1$  functions (a.e., on the set of continuity points of  $F$ ). A continuum of SS's now requires an interval of values of  $\lambda$  where the upward and downward flow functions are tangent to one another. An increase in the altruism parameter  $\delta$  raises the upward flow function, and lowers the downward flow function. So a small perturbation in  $\delta$  will eliminate any such steady state with tangency of the upward and downward flows.

Note that the result does not apply to *all* steady states, only those that are mobile. A continuum of immobile SS's can occur quite non-pathologically, e.g., there can be an interval  $[0, \lambda^*]$  of immobile SS's where both upward and downward flows are zero. This is the case arising with homogeneous agents, for instance, where each occupation class has a strict incentive to not switch to the other class. This essentially requires the lower endpoint  $\underline{x}$  be large enough to shut off all upward mobility for a range of low values of  $\lambda$ . In contrast when Lemma 2 applies then Proposition 3 ensures generic finiteness of the set of all SS's.



As in general equilibrium theory, generic finiteness is by itself a blunt conclusion. ‘Finite’ can stand for one as well as several million. Indeed, one can construct examples that involve an arbitrary number of mobile SS’s (see the discussion following Proposition 5). However, they involve special type distributions involving either discrete types or continuous approximations to these. Considering a wide range of parameter constellations, our numerical computations with standard ability distributions such as uniform (Figures 3(c) and (d)), truncated normal (Figure 4), or exponential have produced no more than *two* locally stable SSM’s, and no more than one such SSM whenever a poverty trap exists for low values of  $\lambda$  (i.e., where there is a minimum education cost  $\underline{x}$  exceeding  $\underline{w}$ , implying that the unskilled wage is insufficient to pay for education whenever  $\lambda < \underline{\lambda}$ ).<sup>14</sup>

Proposition 3 and Lemma 2 in combination imply that (generically) small temporary shocks to SS cannot have permanent effects (assuming that such a SS is locally stable, an issue we will explore in the next section). This conclusion requires only appropriate endpoint conditions on the ability distribution as stated in Lemma 2. Hence it applies to arbitrarily small ‘amounts’ of heterogeneity: the hysteresis result of the homogeneous agent economy represented in Proposition 2 is not robust.

### 4.3 Global Uniqueness

We now turn to the question when SS is globally unique. If SS is locally but not globally unique then there is still scope for history dependence, and for large temporary shocks to have permanent macro effects.

We first provide a sufficient condition for global uniqueness, in terms of ranges of the endpoints of the ability distribution, allied with a condition on preferences and technology that prevents ‘excessive’ non-monotonicity of investment incentives of the unskilled. Recall that as the skill ratio rises, the benefit of investing falls owing to the shrinking wage premium. On the other hand the unskilled wage rises, reducing the utility sacrifice for unskilled parents in educating their children. This can naturally cause their incentive to be non-monotone with respect to the skill ratio. The following condition — which we call the *double crossing property (DCP)* — limits the extent of such non-monotonicity to at most two reversals of preference as  $\lambda$  increases.

**DCP** For any  $x \in [\underline{x}, \bar{x}]$  the set of steady skill ratios  $\lambda$  at which an unskilled family with education cost  $x$  prefers to invest in education is either empty,

---

<sup>14</sup>Steady state configurations arising from an exponential distribution on  $[c, \infty)$  resemble those arising from a similarly truncated normal distribution. When a poverty trap does not exist, we have found instances of a second stable SSM at some  $\lambda < \underline{\lambda}$ , where a positive mass of talented children of unskilled parents get education despite the latter earning only  $\underline{w}$ .

a singleton or an interval.

Under DCP, there is at most an interval  $[\lambda_1^n(x), \lambda_2^n(x)]$  of steady skill ratios at which an unskilled household with an education cost of  $x$  would prefer to invest. Below  $\lambda_1^n(x)$  or above  $\lambda_2^n(x)$  it would prefer not to invest, so its preference for investing switches at most twice. We show below that DCP is satisfied if agents have logarithmic or constant elasticity utility functions with relative risk aversion at least one, and the technology is of the Cobb-Douglas form.

**LEMMA 3** *Let the economy be defined by a Cobb-Douglas production function*

$$H(\lambda, 1 - \lambda) = \lambda^\alpha (1 - \lambda)^{1-\alpha}$$

for  $\alpha \in (0, 1)$ , utility function

$$U(w_{j;t} - xI_t^j) + \delta U(w_{j;t+1})$$

with  $\delta > 0$  and

$$U(c) = \ln(c) \quad \text{or} \quad U(c) = \frac{c^{1-\rho}}{1-\rho}$$

with  $\rho > 1$ . Then DCP is satisfied.

We now provide a sufficient condition for global uniqueness.

**PROPOSITION 4** *Suppose (A1), (A2) and DCP hold, and that in addition:*

- (a) *the upper endpoint  $\bar{x}$  is not too high (in the sense that there exists a steady skill ratio  $\hat{\lambda}$  where every unskilled household would prefer to invest:  $B(\hat{\lambda}) > C^n(\hat{\lambda}, \bar{x})$ );*
- (b) *the lower endpoint  $\underline{x}$  is smaller than the threshold  $\hat{x}(\bar{x})$  defined in Lemma 2.*

*Then there is a globally unique SS, and it involves positive mobility.*

An instance of this situation is depicted in Figure 3(d). The proof of the Proposition is simple: at skill ratio  $\hat{\lambda}$ , every unskilled family wants to invest, and hence so must every skilled family. Since the downward flow is monotone increasing in  $\lambda$ , it is zero at every  $\lambda$  below  $\hat{\lambda}$ . So there cannot be any steady state with mobility at or below  $\hat{\lambda}$ .

Next, note that at  $\hat{\lambda}$ , the upward flow  $u$  is strictly positive. For all higher skill ratios, DCP implies that the upward flow must be strictly decreasing in  $\lambda$  whenever it is positive.<sup>15</sup> Since the downward flow is increasing in  $\lambda$ , it follows

---

<sup>15</sup>This is because at  $\hat{\lambda}$  all unskilled families want to invest, so  $\hat{\lambda}$  exceeds  $\lambda_1^n(\bar{x})$  where the net investment gain of the highest cost type first turns positive. Further increases in  $\lambda$  above  $\hat{\lambda}$  cannot increase the upward flow rate any further: it must be weakly decreasing thereafter. If the rate is positive then the flow, which equals  $1 - \lambda$  times the flow rate, must be strictly decreasing.

there must be a unique SS above  $\hat{\lambda}$ . Finally, condition (b) in conjunction with Lemma 2 ensures that there cannot exist a SS with zero mobility.

Conditions (a) and (b) on the endpoints of the ability distribution are sufficient but clearly not necessary for uniqueness (see Figures 3(b) and 4(b)). Their role is that they generate enough upward mobility. Condition (b) says the lower endpoint of the schooling cost is low enough to ensure there are smart enough children among unskilled families that will move up to the skilled occupation in any steady state. Condition (a) on the upper endpoint ensures that the highest schooling cost is not too large: at some stationary skill ratio even the least able child from an unskilled family wants to invest. These conditions prevent low level traps: steady states must lie above  $\hat{\lambda}$ . And over this region investment incentives of the unskilled are decreasing monotonically, ensuring uniqueness of steady state.

The next result presents in contrast a range of circumstances in which there are multiple SS's.

**PROPOSITION 5** *Suppose (A1), (A2) hold, and also:*

- (a)  $\underline{x} > \underline{w}$ , with consumption constrained to be nonnegative; and
- (b)  $\bar{x}$  is large enough that there will always be downward mobility:  $C^s(\underline{\lambda}, \bar{x}) > B(\underline{\lambda})$ .

*Then:*

- (i) generically (with respect to  $\delta$ ): mobile SS's if they exist are non-unique; and
- (ii)  $\lambda = 0$  is a SS without mobility.

This shows that mobile SS's are generically non-unique in the presence of a 'poverty trap' (where by (a) education cost is bounded away from zero and earnings of the unskilled are insufficient to cover this minimum cost) along with a sufficiently low floor to ability (defined in condition (b)). If one mobile SS exists, there must be at least another one. Figure 4(d) provides an illustration of this. Note, however, that only one of the two mobile steady states is locally stable (in the sense that the upward flow exceeds the downward flow in a right neighborhood of the steady state skill ratio). In particular, Proposition 5 says nothing about the multiplicity of locally stable steady states with mobility.

One may wonder if DCP (or a generalization allowing for at most  $m \geq 3$  preference reversals) can be used to provide bounds on the number of SSM. Figure 5 indicates why this is generally not the case. Its underlying technology and preferences are as in Figures 1-3, which satisfy DCP. However, the latter condition merely restricts non-monotonicity of investment incentives of

the unskilled, but does not eliminate it: the upward flow composed of unskilled investors can increase over some initial range before it begins to decline with respect to increases in  $\lambda$ . Over this initial range it is possible to create multiple steady states with a sufficiently ‘jagged’ ability distribution. This is illustrated in Figure 5, which uses a discrete cost distribution. Clearly, similar examples can be created with a continuous ability distribution which approximates the discrete distribution. In general if there are  $r$  discrete cost levels, there can exist up to  $2(r - 1)$  SSM’s.

In the event of multiple SS’s, it is interesting to note that mobile steady states are ordered with respect to the extent of mobility:

**PROPOSITION 6** *Suppose there are two steady states with positive mobility. Then the steady state with higher skill ratio has higher mobility, lower wage inequality, and higher per capita income.*

This follows from the fact that the downward flow correspondence is strictly increasing in  $\lambda$  when it is positive. Comparing two economies with exactly the same characteristics but operating at two distinct steady states, equality and mobility will be positively related. Richer countries will tend to be more equal *and* more mobile. However the positive correlation between equality and mobility may not obtain when examining comparative static properties of a given steady state. For instance, if we start at a given steady state and shift the education cost distribution downwards, the upward flow correspondence will rise, and the downward flow will fall, at every  $\lambda$ . The steady state skill ratio will move to the right, but the effect on mobility is ambiguous, depending on which flow moves more. If the downward flow falls locally ‘by more’ than the increase in the upward flow, the net effect will be to lower steady state mobility. Intuitively, the greater incentive of the unskilled families to invest in their children’s future is outweighed by the greater reluctance of skilled families to allow their children to descend to the unskilled occupation. This may be relevant in understanding cross-country differences in mobility. For instance, [11] finds that Italy is characterized by a lower level of mobility than the US, despite a more generous public education program: our model provides a possible explanation of this finding.

## 5 Non-Steady-State Dynamics

Agent heterogeneity complicates competitive equilibrium dynamics considerably. Recall that in the homogenous agent case, the competitive equilibrium is globally convergent. With even a ‘little bit’ of heterogeneity, competitive equilibria can fail to converge, even if there should be a unique steady state.

To illustrate this, return to the genius-idiot example. Let  $\lambda^o(\lambda)$  denote the skill ratio at the generation following one where it is  $\lambda$ , which would make a family with occupation  $o$  today and a ‘normal’ child indifferent between investing and not. Specifically:

$$B(\lambda^o(\lambda)) = C^o(\lambda, x).$$

Since skilled families are richer than unskilled families (given  $\lambda < \bar{\lambda}$ ), we know that the threshold is higher for skilled families:  $\lambda^s(\lambda) > \lambda^n(\lambda)$ . Moreover,  $\lambda^s$  is a decreasing function, while  $\lambda^n$  is an increasing function.

Define the drift function  $D(\lambda) \equiv \lambda + (1 - \lambda)\gamma - \lambda\iota$ , the dynamic of the skill ratio driven by the unusual children alone (with all ‘normal’ children following their parents’ occupations). Then the competitive equilibrium dynamic will be as follows. If the current skill ratio is  $\lambda$ , the ratio  $\lambda'$  at the next generation will be given by  $D(\lambda)$  if this lies in between  $\lambda^n(\lambda)$  and  $\lambda^s(\lambda)$ . Otherwise if  $D(\lambda)$  is less than  $\lambda^n(\lambda)$ ,  $\lambda'$  will equal  $\lambda^n(\lambda)$ . In this case unskilled families with normal children must be indifferent about investing, and a fraction of them will invest. On the other hand if  $D(\lambda)$  is bigger than  $\lambda^s(\lambda)$ , then  $\lambda'$  equals  $\lambda^s(\lambda)$ : in this case a positive fraction of skilled families with normal children will invest, while all unskilled families with normal children will not.

Let  $\lambda^1$  and  $\lambda^2$  denote the endpoints of the rightmost steady state interval in the baseline case where there are no geniuses or idiots. Note that at the stationary skill ratio  $\lambda^1$  (resp.  $\lambda^2$ ), unskilled (resp. skilled) parents are indifferent between investing and not. Hence  $\lambda^n(\lambda^1) = \lambda^1$  and  $\lambda^s(\lambda^2) = \lambda^2$ . See Figures 6 and 7.

If the dynamic of skill ratios follows the  $\lambda^n$  function over the entire range, the skill ratio will converge to  $\lambda^1$ . But if instead it follows the  $\lambda^s$  function, it will converge (to  $\lambda^2$ ) only if the slope of this function in the neighborhood of  $\lambda^2$  is less than one in absolute value. If the slope exceeds one then the steady state  $\lambda^2$  of the  $\lambda^s$  function is locally unstable. Whether the slope of the  $\lambda^s$  function exceeds or falls below one depends on the parameters of the model, e.g., on the strength of the altruism motive. If this motive is sufficiently weak (i.e., the altruism parameter  $\delta$  sufficiently small), then the slope will exceed one for a large neighborhood of  $\lambda^2$ .

However, as we have noted above, the global dynamic will not follow either the  $\lambda^n$  or  $\lambda^s$  function throughout. It will switch between these two functions and the drift function, depending on the relative values of these functions. So in order to characterize the global dynamic, we need to distinguish between different cases, which are represented in Figures 6 and 7 respectively.

In Figure 6 the unique steady state  $\lambda^*$  (defined by the condition  $\frac{\lambda^*}{1-\lambda^*} = \frac{\gamma}{\iota}$ ) lies in the interior of  $(\lambda^1, \lambda^2)$ . Here the competitive equilibrium converges to the steady state from arbitrary initial conditions. In the neighborhood of the steady state the drift function lies in between the  $\lambda^n$  and  $\lambda^s$  functions, so represents the

local dynamic. The equilibrium sequence converges because the drift function has a positive slope less than one (note that  $D$  is linear with a slope of  $1 - \gamma - \iota$ ).

In Figure 7 we represent the case where the proportion of geniuses is much larger, and  $\frac{\gamma}{\iota} > \frac{\lambda^2}{1-\lambda^2}$ . Now the unique steady state skill ratio is at  $\lambda^2$ , because the rightward drift is positive even at  $\lambda^2$ , and a positive fraction of skilled families with normal children must disinvest in order to counterbalance the rightward drift.<sup>16</sup> The competitive equilibrium dynamic in the neighborhood of the steady state must follow the  $\lambda^s$  function (since the drift function lies above it in such a neighborhood). Recall from the above discussion that the  $\lambda^s$  function may well have a slope exceeding one in absolute value, in which case the steady state is unstable. Any slight perturbation of the steady state will lead to a dynamic sequence which will perpetually oscillate around the steady state. It can be checked that the dynamic properties of the genius-idiot example extend locally to any finite number of cost types. So the problem is quite a general one. The failure to converge is reminiscent of failures of various learning algorithms to converge to mixed strategy Nash equilibria or cycling of competitive equilibrium dynamics for sufficiently strong income and intertemporal substitution effects despite perfect foresight (see, e. g., [17]).

We now describe some modifications of the dynamic that would restore convergence. It is easy to verify that the competitive equilibrium dynamic has the general property that if the current skill ratio is less (resp. greater) than a unique steady state, then the skill ratio at the next date will be higher (resp. lower) than the one prevailing today. In other words, the skill ratio moves in the direction of the steady state. The same is true regarding non-repelling steady states in general. The failure to converge stems from a tendency to overshoot just as in similar failures of, e.g., discrete time replicator or other dynamics to converge to a unique (mixed) evolutionary stable state (for example, see [28, sect. 4.1] or [18, sect. 6])). Such a tendency would be mitigated in the presence of inertia. This is essentially what is involved in going to a continuous time dynamic (as in [7]). For instance, suppose that only a positive fraction of families consider switching occupations in any generation, the size of which is a nondecreasing function of the payoff benefit from the switch (with nobody switching if the current occupation of the parent is strictly optimal for the child). One interpretation of this is that there is a special cost advantage in learning one's parent's occupation (e.g., the parent may directly impart education to the child), which differs randomly across families (e.g., owing to differences in effectiveness of parental educations). Alternatively, inertia could arise from a form of bounded rationality. If the fraction of switchers is scaled down enough (for any given

---

<sup>16</sup>There cannot be a steady state to the right of  $\lambda^2$  because there *all* skilled families with normal children will want to disinvest. Then the skill ratio at the following date will be  $\gamma$ , which is less than  $\lambda^2$  by assumption.

payoff benefit) as a result of inertia, one may speculate that overshooting can be moderated so as to ensure convergence.

In our model, however, this is less straightforward than it might seem. Consider for instance the simplest formulation of inertia, where each parent reconsiders its family's earlier investment decision with a small payoff-independent exogenous probability  $p < 1$ .<sup>17</sup> The problem of non-convergence then persists if the type distribution has mass points. Consider again the divergence situation in the genius-idiot example (Figure 7). Scaling down the excess of the mass of geniuses newly investing over the mass of idiots disinvesting by  $p$  turns the drift function  $D$  towards the 45°-line. This leaves a shrunken but still nonempty neighborhood of the unique steady state  $\lambda^2$  in which dynamics are determined by the condition that all normal skilled families are indifferent, i.e., by the function  $\lambda^s$ . But this function is not affected by inertia. Given that dynamics do not converge from any  $\lambda_0$  in a neighborhood of  $\lambda^2$  under the original process ( $p = 1$ ), they do not converge for small  $p$  either.

We now show that a slightly more complex form of inertia, where switching probabilities depend on possible payoffs, does nevertheless restore global convergence.

Recall  $g^o(\lambda_t, \lambda_{t+1}^e; x)$  denotes the net gain from investing for a parent in occupation  $o$  in generation  $t$ , if the child's ability is represented by cost  $x$  of entering the skilled profession (in the absence of any inertia). In the presence of inertia, assume that the fraction of families in this category that will actually switch occupations is given by  $p(\Delta U) \in [0, 1]$  where<sup>18</sup>

$$\Delta U \equiv \begin{cases} g^n(\lambda_t, \lambda_{t+1}^e; x) & \text{if } o = n, \\ -g^s(\lambda_t, \lambda_{t+1}^e; x) & \text{if } o = s \end{cases}$$

and  $p(\cdot)$  satisfies the following properties:  $p(\Delta U) = 0$  for  $\Delta U < 0$ , and there exists  $\varepsilon \geq 0$  such that  $p(\Delta U) \in (0, \bar{p})$  for  $\Delta U \in [0, \varepsilon)$ , and  $p(\Delta U) = \bar{p} \in (0, 1]$  for all  $\Delta U \geq \varepsilon$ . If  $\varepsilon > 0$ , then  $p$  is nondecreasing and differentiable with  $dp/d\Delta U \leq l\bar{p}/\varepsilon$  for some  $l \geq 1$  fixed independently of  $\bar{p}$ . In this case the switching probability is continuous in the utility gain from switching, with a bounded rate of change.

Denote the resulting dynamic process in which agents have perfect foresight by  $\Phi^{\bar{p}, \varepsilon}$ . The process continues to be well-defined because the set of possible  $\lambda_{t+1}$  is for any given  $\lambda_t$  a decreasing correspondence of  $\lambda_{t+1}^e$  satisfying the assumptions of Kakutani's theorem. Perfect-foresight competitive equilibrium dynamics represent the special case where  $\Phi \equiv \Phi^{1,0}$ .

---

<sup>17</sup>[14], for example, motivates continuous replicator dynamics in this way.

<sup>18</sup>Any fraction of *indifferent* skilled (resp. unskilled) families not exceeding  $p(0)$  may switch professions.

PROPOSITION 7 *Given any  $\varepsilon' > 0$ , there generically exist  $\varepsilon > 0$  and  $\bar{p} \in (0, 1]$  such that:*

1. *For any steady state  $\lambda'$  of  $\Phi^{\bar{p}, \varepsilon}$  there exists a steady state  $\lambda$  of  $\Phi$  with  $|\lambda' - \lambda| < \varepsilon'$  and vice versa.*
2.  *$\Phi^{\bar{p}, \varepsilon}$  converges to one of its steady states from any initial state  $\lambda_0$ .*

The proof is provided in the appendix. It also shows convergence of a related dynamic process in which families are myopic out of steady state and have static expectations. The incorporation of inertia and myopia results in a plausible model with *boundedly rational* agents which has (approximately) the same long run predictions as the dynamic process investigated in this paper.

## 6 Relation to Existing Literature

Models analyzing steady state mobility include [2], [7], [22] and [26]. [7] considers a model with four occupations and three income classes, with risky income patterns within each occupation. Mobility is induced by sufficient variability in *ex post* incomes, somewhat analogous to the variability in education costs in our model. Positive income shocks allow the poor to escape poverty and switch occupations. These shocks eliminate steady states with zero mobility. [7] works out the steady state set and dynamics with a discrete two-point distribution for income risk and two specific classes of parameter values: these are shown to yield two distinct locally stable steady states. Our paper considers a simpler model with two occupations, but yields more general results concerning steady state uniqueness and convergence. [2] studies a model with a unique mobile steady state, while [26] share many of the features described above for [7] and so bears the same relation to this paper.<sup>19</sup>

[22] considers a model very similar to ours, but does not address the question of steady state multiplicity, nor the convergence properties of competitive equilibria. Instead the authors focus on the qualitative features of a ‘development process’, characterized by the movement from a low non-steady state skill ratio to a steady state skill ratio. They also analyze the effects and design of redistributive taxes along such a development process.

The relation to [13],[19],[23-25],[27] has already been discussed: steady states in those models are characterized by zero mobility, and a continuum of unequal steady states in the presence of occupational indivisibility. This paper can be interpreted as studying the effect of augmenting such a model with heterogeneity in agents’ education costs. As pointed out in the introduction, the effect of

---

<sup>19</sup>See [8, section 6] for a recent survey of this literature.



introducing heterogeneous abilities is akin to the removal of investment indivisibility in [23]: both can transform the inequality constraints which characterize steady states in the baseline model into equalities.

[15] does not allow any heterogeneity or income risk; consequently the steady states in that paper do not involve any mobility. The first model in [15] is characterized by complete absence of pecuniary externalities, so each family follows an independent dynamic. The income dynamic has two steady states, hence at the macro level there is a continuum of steady states varying with respect to the proportion of families at different steady state income levels. In that context it is evident that adding heterogeneity of income or education costs would typically eliminate this indeterminacy, and give rise to a unique steady state at the macro level. So the conclusions of our paper would (trivially) apply to that context as well. The subsequent model in [15] which incorporates pecuniary externalities describes two classes of steady states (associated respectively with a developed and underdeveloped economy), but does not address the question of local indeterminacy.

[16] consider a simplified version of [7], with three occupations, homogenous agents and absence of income risk. In this model also there is a continuum of steady states, and absence of occupational mobility in steady state. We presume that our results concerning the implications of introducing heterogeneity or income risk on steady state multiplicity will also apply to their model.

Finally, earlier literature (e.g., [9],[20]) was based on a version of the neoclassical growth model with no indivisibilities or nonconvexities in the investment technology. Their models incorporate agent heterogeneity in order to explain the persistence of income inequality. They are characterized by a unique steady state with mobility.

## 7 Conclusion

This paper has argued that when occupational mobility is sought to be explained by heterogeneity of talent (or investment cost, or *ex post* income uncertainty), long run macroeconomic outcomes become less history dependent. This is true despite the presence of borrowing constraints and nonconvexities in investment opportunities. The local indeterminacy of steady states in models with homogeneous agents is generally lost, even with arbitrarily ‘small’ extents of heterogeneity. For certain classes of heterogeneity we showed that steady state is globally unique, for some others we showed they were non-unique. Numerical computations with various examples of well-behaved continuous ability distributions and parameter constellations permitting existence of a low level poverty trap for the unskilled, showed a unique locally stable steady state with mobility. We also discussed problems with possible nonconvergence of competitive equi-

librium dynamics in the presence of heterogeneity, and how convergence could be restored in the presence of inertia or investment ‘adjustment costs’.

Many questions remain to be explored. For one, there is the question of how robust the results are with respect to the bequest motive, or presence of more than two occupations. Robustness with respect to state dependence of ability within families (e.g., if there is intergenerational transmission of genes or social skills) or alternative formulations of agent heterogeneity is also an interesting question.

Second, what is the role of interventionist policies in a world with occupational mobility? The results suggest that temporary policies (of education subsidies for instance) are considerably less effective in affecting long run human capital, per capita income, or inequality. But there may still be a role for permanent policies. Is it possible that steady states involve too little investment in human capital from an efficiency standpoint? Also as discussed in the text, permanent education subsidies may raise steady state levels of human capital and per capita income while reducing cross-sectional inequality, but their effects on mobility are considerably less clear-cut. Issues concerning effects and optimal design of public policies in contexts involving occupational mobility constitute an important research agenda for the future.

## References

- [1] **Acemoglu, D., S. Johnson and J. Robinson** (2001). “The Colonial Origins of Comparative Development: An Empirical Investigation.” *American Economic Review* **91**(5), 1369–1401.
- [2] **Aghion, P. and P. Bolton** (1997). “A Theory of Trickle-Down Growth and Development,” *Review of Economic Studies* **64**(219), 151–172.
- [3] **Aghion, P., P. Howitt and D. Mayer-Foulkes** (2003). “The Effect of Financial Development on Convergence: Theory and Evidence,” mimeo, Department of Economics, Harvard University, December 2003.
- [4] **Bandyopadhyay, D.** (1993), *Distribution of Human Capital, Income Inequality and Rate of Growth*, PhD thesis, University of Minnesota.
- [5] ————— (1997). “Distribution of Human Capital and Economic Growth,” Working Paper no. 173, Department of Economics, Auckland Business School.
- [6] **Banerjee, A., and L. Iyer** (2002). “History, Institutions and Economic Performance: The Legacy of Colonial Land Tenure Systems in India,” mimeo, Department of Economics, MIT, June 2002.

- [7] **Banerjee, A., and A. Newman** (1993). “Occupational Choice and the Process of Development.” *Journal of Political Economy* **101**(2), 274–298.
- [8] **Banerjee, A., and E. Duflo** (2004). “Growth Theory Through the Lens of Development Economics,” mimeo, Department of Economics, MIT, March 2004.
- [9] **Becker, G., and N. Tomes** (1979). “An Equilibrium Theory of the Distribution of Income and Intergenerational Mobility.” *Journal of Political Economy* **87**(6), 1153–1189.
- [10] **Bowles, S., and H. Gintis** (2002). “The Inheritance of Inequality,” *Journal of Economic Perspectives* **16**(3), 3–30.
- [11] **Checchi D., A. Ichino and A. Rustichini** (1999). “More Equal but Less Mobile? Education Financing and Intergenerational Mobility in Italy and in the United States.” *Journal of Public Economics* **74**(3), 351–393.
- [12] **Engerman, S., and K. Sokoloff** (1997). “Factor Endowments, Institutions and Differential Paths of Growth among New World Economies,” in S. H. Haber (Ed.), *How Latin America Fell Behind*, Stanford University Press, Stanford, CA.
- [13] **Freeman, S.** (1996). “Equilibrium Income Inequality among Identical Agents.” *Journal of Political Economy* **104**(5), 1047–1064.
- [14] **Gale, J., K. Binmore, and L. Samuelson** (1995). “Learning to Be Imperfect: The Ultimatum Game.” *Games and Economic Behavior* **8**(1), 56–90.
- [15] **Galor, O., and J. Zeira** (1993). “Income Distribution and Macroeconomics.” *Review of Economic Studies* **60**(1), 35–52.
- [16] **Ghatak, M., and N. Jiang** (2002). “A Simple Model of Inequality and Occupational Choice with Credit Constraints.” *Journal of Development Economics* **69**(1), 205–226.
- [17] **Grandmont, J.-M.** (1985). “On Endogenous Competitive Business Cycles.” *Econometrica* **53**(5), 995–1045.
- [18] **Kandori, M., G. J. Mailath and R. Rob** (1993), “Learning, Mutation, and Long Run Equilibria in Games”, *Econometrica* **61**(1), 29–56.
- [19] **Ljungqvist, L.** (1993). “Economic Underdevelopment: The Case of Missing Market for Human Capital,” *Journal of Development Economics* **40**(2), 219–239.

- [20] **Loury, G.** (1981). “Intergenerational Transfers and the Distribution of Earnings.” *Econometrica* **49**(4), 843–867.
- [21] **Mas-Colell, A.** (1985), *The Theory of General Economic Equilibrium: A Differentiable Approach*, Cambridge Univ. Press, Cambridge.
- [22] **Maoz, Y., and O. Moav** (1999). “Intergenerational Mobility and the Process of Development,” *Economic Journal* **109** (October), 677–697.
- [23] **Mookherjee, D., and D. Ray** (2002). “Is Equality Stable?” *American Economic Review – Papers and Proceedings* **92**(2), 253–259.
- [24] ————— (2003). “Persistent Inequality,” *Review of Economic Studies* **70**(2), 369–393.
- [25] ————— (2004). “Occupational Diversity and Endogenous Inequality,” <http://people.bu.edu/dilipm/wkpap/index.html>.
- [26] **Piketty, T.** (1997), “The Dynamics of the Wealth Distribution and the Interest Rate with Credit Rationing,” *Review of Economic Studies* **64**(219), 173–189.
- [27] **Ray, D.** (1990). *Income Distribution and Macroeconomic Behavior*. Mimeo, Boston University.
- [28] **Weibull, J.W.** (1995). *Evolutionary Game Theory*, MIT Press, Cambridge, MA.

## Appendix

*Proof of Lemma 1:* The proof is illustrated in Figure 1. Define the non-empty, compact and convex-valued correspondence  $\phi_{\lambda_t}: [0, 1] \rightrightarrows [0, 1]$  by

$$\phi_{\lambda_t}(\lambda_{t+1}^e) = \left\{ \lambda \mid \lambda = \sigma(\lambda_t, \lambda_{t+1}^e) + \alpha i^n(\lambda_t, \lambda_{t+1}^e) + \beta i^s(\lambda_t, \lambda_{t+1}^e) \text{ for } \alpha, \beta \in [0, 1] \right\}. \quad (9)$$

For given  $\lambda_t$ ,  $\phi_{\lambda_t}$  maps expected skill ratio  $\lambda_{t+1}^e$  to the set of all actual skill ratios  $\lambda_{t+1}$  that could result from its anticipation. The latter need not be a singleton if the skill distribution has atoms.

Since threshold levels  $x^n(\lambda_t, \lambda_{t+1}^e)$  and  $x^s(\lambda_t, \lambda_{t+1}^e)$  are continuous,  $\sigma(\lambda_t, \lambda_{t+1}^e)$  is continuous in  $\lambda_{t+1}^e$  *except* at points where a positive mass of agents switches from a strict preference for or against investment to indifference. Moreover, *except* at these points,  $\phi_{\lambda_t}(\lambda_{t+1}^e) = \{\sigma(\lambda_t, \lambda_{t+1}^e)\}$  and thus  $\phi_{\lambda_t}$  is continuous, too. If at  $\lambda_{t+1}^e$  a mass of agents becomes indifferent between investing or not, all or none of them may invest. So for arbitrary  $\lambda_{t+1}^e$  and arbitrary sequences  $\{\lambda^{en}\}_{n \geq 0}$  and  $\{\lambda^n\}_{n \geq 0}$  with  $\lambda^{en} \rightarrow \lambda_{t+1}^e$ ,  $\lambda^n \in \phi_{\lambda_t}(\lambda^{en})$ , and  $\lambda^n \rightarrow \lambda'$  it is true that  $\lambda' \in \phi_{\lambda_t}(\lambda_{t+1}^e)$ . In other words,  $\phi_{\lambda_t}$  is upper semi-continuous and, by Kakutani's theorem, must have a fixed point  $\lambda_{t+1} \in \phi_{\lambda_t}(\lambda_{t+1})$ .

Uniqueness follows from the fact that  $\phi_{\lambda_t}$  is a decreasing correspondence over the range  $[0, \bar{\lambda}]$ , i.e., that for all  $\lambda \in \phi_{\lambda_t}(\lambda_{t+1}^e)$  and  $\lambda' \in \phi_{\lambda_t}(\lambda_{t+1}^{\prime e})$ :  $\lambda_{t+1}^e \leq \lambda_{t+1}^{\prime e} \iff \lambda \geq \lambda'$ . This follows from the fact that a higher expected skill ratio decreases the benefits of child education, while the costs are determined by the currently given skill ratio at  $t$ . ■

*Proof of Proposition 1:* Define the correspondence  $\lambda'(\lambda)$  from  $[0, 1]$  to itself as follows:

$$\lambda'(\lambda) \equiv \left\{ \lambda' = \lambda + \mu_1 - \mu_2 \mid \mu_1 \in u(\lambda), \mu_2 \in d(\lambda) \right\}.$$

A SS is a fixed point of this correspondence. Its existence follows from applying the Kakutani theorem, since the correspondence is non-empty, convex-valued and u.s.c. (because  $u$  and  $d$  have these properties by construction). ■

*Proof of Proposition 2:* We first prove (c). Since (A1) holds here, any SS must involve  $\lambda < \bar{\lambda}$ , implying  $w^s(\lambda) > w^n(\lambda)$ . So  $x^n(\lambda, \lambda) < x^s(\lambda, \lambda)$ . If  $\lambda = 0$  then such a SS involves no mobility. So suppose  $\lambda > 0$ . If  $x^* \notin [x^n(\lambda, \lambda), x^s(\lambda, \lambda)]$  then either every household or no household in the economy will invest, contradicting the property that  $\lambda \in (0, \bar{\lambda})$ . Hence

$$x^n(\lambda, \lambda) \leq x^* \leq x^s(\lambda, \lambda). \quad (10)$$

Now if there is upward mobility in the SS, then  $x^* = x^n(\lambda, \lambda)$ . It follows that all skilled households will invest, in which case there will be no downward mobility. Hence (c) is established.

We can therefore restate the steady state condition as

$$C^n(\lambda, x^*) \geq B(\lambda) \geq C^s(\lambda, x^*) \quad (11)$$

if  $\lambda > 0$ , and

$$C^n(\underline{\lambda}, x^*) \geq B(\underline{\lambda}) \quad (12)$$

if  $\lambda = 0$ . Now (a) follows from the fact that  $B$  is strictly decreasing while  $C^s(\lambda, x^*)$  is strictly increasing in  $\lambda$  over  $[\underline{\lambda}, \bar{\lambda}]$ , and both are constant on  $[0, \underline{\lambda})$ . If (6) holds then no SS with  $\lambda > 0$  can exist, as no household will have an incentive to invest, and  $\lambda = 0$  is the unique SS. If (6) does not hold, then there exists  $\tilde{\lambda} \in (0, \bar{\lambda})$  such that  $B(\tilde{\lambda}) = C^s(\tilde{\lambda}, x^*)$ . This is a SS, since  $C^n(\tilde{\lambda}, x^*) > C^s(\tilde{\lambda}, x^*)$ . Moreover every skill ratio in some left neighborhood of  $\tilde{\lambda}$  is also a SS, since  $B$  is decreasing,  $C^s(\lambda, x^*)$  is nondecreasing and  $C^n(\lambda, x^*)$  is continuous in  $\lambda$ . So there is a continuum of SS's. If (7) holds, then  $\tilde{\lambda} > \underline{\lambda}$  and there exists an interval  $(\tilde{\lambda} - \epsilon, \tilde{\lambda})$  with  $\tilde{\lambda} - \epsilon > \underline{\lambda}$  such that every skill ratio in this interval is a steady state, and within this interval per capita income is increasing and the skill premium decreasing as we move across SS's with higher  $\lambda$ . This establishes (b).

Finally we turn to dynamics. If  $\lambda_0$  is a SS then the result follows from the uniqueness of equilibrium (Lemma 1).

So consider the case where  $\lambda_0 > \tilde{\lambda}$ . Then

$$B(\lambda_0) < B(\tilde{\lambda}) = C^s(\tilde{\lambda}, x^*) < C^s(\lambda_0, x^*), \quad (13)$$

so neither skilled nor unskilled households want to invest if  $\lambda_1 = \lambda_0$ .

If  $B(\underline{\lambda}) < C^s(\lambda_0, x^*)$ , then the equilibrium must entail  $\lambda_1 = 0$ , since there is no skill ratio at  $t = 1$  that would induce anyone to invest. In this case every skill ratio from 0 to  $\tilde{\lambda}$  is a SS, because  $B(\lambda) \leq B(0) = B(\underline{\lambda}) < C^s(\lambda_0, x^*) \leq C^s(\tilde{\lambda}, x^*) = C^n(\tilde{\lambda}, x^*) \leq C^n(\lambda, x^*)$  for every  $\lambda \leq \tilde{\lambda}$ , so the unskilled never want to invest at any steady skill ratio below  $\tilde{\lambda}$ . On the other hand  $B(\lambda) \geq C^s(\lambda, x^*)$  for all  $\lambda$  from 0 to  $\tilde{\lambda}$ , so the skilled invest at any such steady skill ratio. Hence  $\lambda_1 = 0$  is a SS, and then by the reasoning above,  $\lambda_t = \lambda_1 = 0$  for all  $t > 1$ .

On the other hand suppose that  $B(\underline{\lambda}) \geq C^s(\lambda_0, x^*)$ . Then there exists  $\lambda \in [\underline{\lambda}, \tilde{\lambda}]$  such that  $B(\lambda) = C^s(\lambda_0, x^*)$ . This is an equilibrium skill ratio (where only  $\lambda$  measure of (skilled) households invest and the rest being indifferent do not invest, while no unskilled household wants to invest), and by uniqueness of equilibrium  $\lambda_1$  must equal this  $\lambda$ . Moreover  $\lambda_1$  is a SS because  $B(\lambda_1) = C^s(\lambda_0, x^*) > C^s(\lambda_1, x^*)$  while  $C^n(\lambda_1, x^*) > C^n(\lambda_0, x^*) > C^s(\lambda_0, x^*) = B(\lambda_1)$ . So  $\lambda_t = \lambda_1$  for all  $t \geq 1$ .

Finally consider the case where  $\lambda_0$  is less than  $\tilde{\lambda}$  and is not a SS. Then all households in the economy want to invest at the steady skill ratio  $\lambda_0$ . In this case  $\lambda_1$  must be characterized by indifference for unskilled households' investment

decision:  $B(\lambda_1) = C^n(\lambda_0, x^*)$ , and a fraction of these unskilled households switch to the skilled occupation, while all skilled households invest. This requires  $\lambda_1 > \lambda_0$ . We claim that  $\lambda_1$  is also less than  $\bar{\lambda}$  and therefore not a SS. This follows from  $B(\lambda_1) = C^n(\lambda_0, x^*) > C^n(\lambda_1, x^*)$  so the unskilled again want to invest at a stationary skill ratio  $\lambda_1$ , contrary to the requirement of a SS. Now the same argument as at  $t = 0$  applies again, hence  $\lambda_2 > \lambda_1$ , etc. Therefore skill ratios rise monotonically. Since they are bounded above by  $\bar{\lambda}$  they must converge. The limiting ratio must involve indifference among the unskilled, and must therefore be a SS. ■

*Proof of Lemma 2:* Define  $\lambda'(\bar{x})$  by the condition that  $B(\lambda') = C^s(\lambda', \bar{x})$  if  $B(\underline{\lambda}) > C^s(\underline{\lambda}, \bar{x})$ , and equal to  $\underline{\lambda}$  otherwise. Then by construction  $\lambda'(\bar{x}) \in [\underline{\lambda}, \bar{\lambda}]$ .

We claim that  $\lambda \in (\lambda'(\bar{x}), \bar{\lambda})$  and  $\mu \in d(\lambda)$  implies  $\mu > 0$ . This is because  $B(\lambda'(\bar{x})) \leq C^s(\lambda'(\bar{x}), \bar{x})$ ; at any  $\lambda > \lambda'(\bar{x})$  it is true that  $B(\lambda) < C^s(\lambda, \bar{x})$  so at any such steady skill ratio  $\lambda$  there must be downward mobility.

Next, define  $\hat{x}(\bar{x}) > 0$  by the condition  $C^n(\underline{\lambda}, \hat{x}) = B(\lambda'(\bar{x}))$ . This is well-defined because  $C^n(\underline{\lambda}, x)$  is increasing from 0 to  $\infty$  as  $x$  goes from 0 to  $\infty$ , and  $B(\lambda'(\bar{x})) > 0$ . Then if  $\underline{x} < \hat{x}(\bar{x})$  we have for any  $\lambda \leq \lambda'(\bar{x})$ :

$$C^n(\lambda, \underline{x}) \equiv U(w^n(\lambda)) - U(w^n(\lambda) - \underline{x}) \leq C^n(\underline{\lambda}, \underline{x}) < C^n(\underline{\lambda}, \hat{x}(\bar{x})) = B(\lambda'(\bar{x})) \leq B(\lambda),$$

implying there must be upward mobility. Combining with the result in the previous paragraph, Lemma 2 is established. ■

*Proof of Proposition 3:* Consider first the case where  $F$  has no mass points, i.e.,  $F \equiv F^0$  and has a continuous density  $f$ . In this case  $u(\lambda)$  and  $d(\lambda)$  are functions, which depend on the parameter  $\delta$ ; accordingly we denote these by  $u(\lambda, \delta)$ ,  $d(\lambda, \delta)$  respectively. For any given  $\delta$ , let  $x^n(\lambda, \delta)$  and  $x^s(\lambda, \delta)$  denote the costs at which unskilled and skilled households are indifferent between investing and not investing at the constant skill ratio  $\lambda$ . Define the net upward flow:

$$\begin{aligned} \mu(\lambda, \delta) &\equiv u(\lambda, \delta) - d(\lambda, \delta) \\ &= (1 - \lambda)F(x^n(\lambda, \delta)) - \lambda(1 - F(x^s(\lambda, \delta))) \\ &= F(x^n(\lambda, \delta)) - \lambda F(x^n(\lambda, \delta)) - \lambda + \lambda F(x^s(\lambda, \delta)) \end{aligned}$$

for  $\lambda \in [0, 1]$  and  $\delta \in [0, \infty)$ .  $x^n$  and  $x^s$  are  $C^1$  and strictly increasing in  $\delta$  for any  $\lambda \in (0, \bar{\lambda})$ . Since  $F$  is  $C^1$ , so is  $\mu$ .

**LEMMA 4** *Suppose  $F$  has no mass points, and let  $\lambda \in (0, \bar{\lambda})$  and  $\delta > 0$  be such that  $u(\lambda, \delta) = d(\lambda, \delta) > 0$ . Then*

$$\frac{\partial \mu(\lambda, \delta)}{\partial \lambda} = 0 \quad \implies \quad \frac{\partial \mu(\lambda, \delta)}{\partial \delta} > 0.$$

*Proof of Lemma 4:* Consider

$$\begin{aligned} \frac{\partial \mu(\lambda, \delta)}{\partial \lambda} &= f(x^n(\lambda, \delta)) \frac{\partial x^n(\lambda, \delta)}{\partial \lambda} - F(x^n(\lambda, \delta)) - \lambda f(x^n(\lambda, \delta)) \frac{\partial x^n(\lambda, \delta)}{\partial \lambda} \\ &\quad - 1 + F(x^s(\lambda, \delta)) + \lambda f(x^s(\lambda, \delta)) \frac{\partial x^s(\lambda, \delta)}{\partial \lambda} = 0. \end{aligned} \quad (14)$$

We claim that  $f(x^n(\lambda, \delta))$  and  $f(x^s(\lambda, \delta))$  cannot simultaneously equal zero. Otherwise (14) reduces to

$$\frac{\partial \mu(\lambda, \delta)}{\partial \lambda} = -F(x^n(\lambda, \delta)) - 1 + F(x^s(\lambda, \delta)) = 0.$$

This would require  $F(x^n(\lambda, \delta)) = 0$  and  $F(x^s(\lambda, \delta)) = 1$ , in contradiction to  $u(\lambda, \delta), d(\lambda, \delta) > 0$ . Therefore,  $f(x^n(\lambda, \delta)) > 0$  or  $f(x^s(\lambda, \delta)) > 0$  whenever  $\frac{\partial \mu(\lambda, \delta)}{\partial \lambda} = 0$ .

We have

$$\begin{aligned} \frac{\partial \mu(\lambda, \delta)}{\partial \delta} &= f(x^n(\lambda, \delta)) \frac{\partial x^n(\lambda, \delta)}{\partial \delta} - \lambda f(x^n(\lambda, \delta)) \frac{\partial x^n(\lambda, \delta)}{\partial \delta} + \lambda f(x^s(\lambda, \delta)) \frac{\partial x^s(\lambda, \delta)}{\partial \delta} \\ &= (1 - \lambda) f(x^n(\lambda, \delta)) \frac{\partial x^n(\lambda, \delta)}{\partial \delta} + \lambda f(x^s(\lambda, \delta)) \frac{\partial x^s(\lambda, \delta)}{\partial \delta}. \end{aligned}$$

Now for  $\lambda \in (0, \bar{\lambda})$  and  $\frac{\partial \mu(\lambda, \delta)}{\partial \lambda} = 0$ , the monotonicity of threshold costs in  $\delta$  (namely,  $\frac{\partial x^n(\lambda, \delta)}{\partial \delta} > 0$  and  $\frac{\partial x^s(\lambda, \delta)}{\partial \delta} > 0$ ) implies  $\frac{\partial \mu(\lambda, \delta)}{\partial \delta} > 0$ .  $\square$

Return now to the proof of Proposition 3 in the case where  $F$  has no mass points. Define the function  $\lambda(\delta): \mathbb{R}_+ \rightarrow [0, \bar{\lambda}]$  as the constant skill ratio at which the lowest ability children of skilled parents with discount factor  $\delta$  are indifferent between investing and not investing. Specifically, if  $\bar{x} < x^s(\underline{\lambda}, \delta)$  it is the unique solution to  $x^s(\lambda, \delta) = \bar{x}$ . If  $\bar{x} = x^s(\underline{\lambda}, \delta)$  set  $\lambda(\delta) = \underline{\lambda}$ , and if  $\bar{x} > x^s(\underline{\lambda}, \delta)$  set  $\lambda(\delta) = 0$ . Since  $F$  has no mass points, a steady state skill ratio  $\lambda$  at  $\delta$  satisfying  $\mu(\lambda, \delta) = 0$  has positive mobility if and only if it has positive downward mobility, i.e., it satisfies the additional condition  $\lambda \in (\lambda(\delta), \bar{\lambda})$ .

Therefore if we define the open manifold

$$\Xi = \{(\lambda, \delta) \in [0, \bar{\lambda}] \times \mathbb{R}_+ \mid \lambda \in (\lambda(\delta), \bar{\lambda})\} \quad (15)$$

$\lambda$  is a mobile steady state skill ratio at  $\delta$  if and only if  $\mu(\lambda, \delta) = 0$  and  $(\lambda, \delta) \in \Xi$ . Hence the set of SSM is exactly

$$\mathcal{E}_M = \{(\lambda, \delta) \in \Xi \mid \mu(\lambda, \delta) = 0\} \quad (16)$$

i.e., if we consider the  $C^1$  map  $\mu: \Xi \rightarrow \mathbb{R}$ , we have  $\mathcal{E}_M \equiv \mu^{-1}(0)$ . By Lemma 4,

$$\left( \begin{array}{cc} \frac{\partial \mu(\lambda, \delta)}{\partial \lambda} & \frac{\partial \mu(\lambda, \delta)}{\partial \delta} \end{array} \right)$$



has rank 1 at every  $(\lambda, \delta) \in \mathcal{E}_M$ . Therefore 0 is a regular value of the map  $\mu$ . The Implicit Function Theorem ([21], H.2.2) then implies that  $\mu^{-1}(0) = \mathcal{E}_M$  is a  $C^1$  manifold of dimension 1.

Define the projection map  $\pi: \mathcal{E}_M \rightarrow \mathbb{R}_+$  by  $\pi(\lambda, \delta) = \delta$ . We now claim that if  $\lambda$  is a critical SSM at  $\delta$ , i.e.,  $(\lambda, \delta) \in \mathcal{E}_M$  satisfying  $\frac{\partial \mu}{\partial \lambda} = 0$ , then  $\delta$  is a critical value of  $\pi$ . By Lemma 4,  $\frac{\partial \mu}{\partial \delta} > 0$  at any such  $(\lambda, \delta)$ -pair. Hence the Implicit Function Theorem yields  $\frac{\partial \pi}{\partial \lambda} = -[\frac{\partial \mu}{\partial \delta}]^{-1} \frac{\partial \mu}{\partial \lambda} = 0$ , implying that  $\delta$  is a critical value of  $\pi$ . Now Sard's Theorem ([21], I.1.1) implies that the set of critical values of the smooth function  $\pi$  has Lebesgue measure zero. Hence the set of discount factors at which there exists a mobile steady state skill ratio  $\lambda$  which is critical, is a set of Lebesgue measure 0.

Now suppose that  $F$  has a finite number of mass points. Then the function  $\mu$  is well-defined on the open set  $O$  resulting from removing all  $(\lambda, \delta)$ -pairs from  $(0, \bar{\lambda}) \times (0, \infty)$  for which  $x^n(\lambda, \delta)$  or  $x^s(\lambda, \delta)$  corresponds to a mass point of  $F$ . On this set,  $\mu$  is  $C^1$  and by the above arguments all its zeros are locally unique generically. It remains to consider possible zeros of  $\mu$  amongst the removed  $(\lambda, \delta)$ -pairs. Now we claim that for a generic set of values of  $\delta$ , only a finite number of  $\lambda$ 's were removed. This follows since for any given mass-point of  $x$ , say  $x^*$ , a  $(\lambda, \delta)$  pair was removed if  $\delta B(\lambda) - U(w^o(\lambda)) + U(w^o(\lambda) - x^*) = 0$  for either  $o = n$  or  $o = s$ . Since  $B(\lambda) > 0$  for every  $\lambda \in (0, \bar{\lambda})$ , and there are a finite number of mass points, application of Sard's Theorem once again implies that for a generic set of values of  $\delta$ , a finite number of  $\lambda$ 's were removed. Hence generically, only finitely many *more* zeros can exist for the steady state condition  $\mu(\lambda, \delta) = 0$ , implying that generic finiteness of the set of mobile steady states continues to hold.  $\blacksquare$

*Proof of Lemma 3:* If  $\rho > 1$ , the net benefit to an unskilled investor with cost  $x$  is

$$g^n \equiv (1-\rho)^{-1} [\delta \alpha^{1-\rho} \eta^{(1-\alpha)(1-\rho)} - (1+\delta)(1-\alpha)^{1-\rho} \eta^{-\alpha(1-\rho)} + \{(1-\alpha)\eta^{-\alpha} - x\}^{1-\rho}] \quad (17)$$

where  $\eta \equiv \frac{1}{\lambda} - 1$ . Hence in this case  $g^n$  is nondecreasing in  $\eta$  if and only if

$$m(\eta) \equiv \{(1-\alpha)\eta^{-\alpha} - x\}^{-\rho} - \delta \alpha^{-\rho} \eta^{1-\rho(1-\alpha)} - (1+\delta)(1-\alpha)^{-\rho} \eta^{\alpha\rho} \geq 0. \quad (18)$$

It can easily be verified that the same is true when the utility function is logarithmic (putting  $\rho = 1$ ).

*Claim:* If  $\rho \geq 1$  and  $m(\eta) \geq 0$ , then  $m'(\eta) > 0$ .

To prove the claim, note that the condition  $m'(\eta) > 0$  is equivalent to

$$\alpha\rho(1-\alpha)\eta^{-1-\alpha}\{(1-\alpha)\eta^{-\alpha} - x\}^{-1-\rho} > \alpha\rho(1+\delta)(1-\alpha)^{-\rho}\eta^{\alpha\rho-1} + \delta(1-\rho+\alpha\rho)\alpha^{-\rho}\eta^{\alpha\rho-\rho} \quad (19)$$

Now  $\rho \geq 1$  implies that  $\alpha\rho \geq \alpha\rho + 1 - \rho$ , so  $m(\eta) \geq 0$  implies that the R.H.S. of (19) cannot exceed  $\alpha\rho\eta^{-1}\{(1-\alpha)\eta^{-\alpha} - x\}^{-\rho}$ , which in turn cannot exceed the L.H.S. of (19). This establishes the claim.

The claim implies that if  $m(\eta^*) \geq 0$  then  $m(\eta) > 0$  for all  $\eta > \eta^*$ . Using (18) this implies that if  $(g^n)' \geq 0$  at  $\lambda^*$ , then  $(g^n)' > 0$  at all  $\lambda < \lambda^*$ . If  $\rho \geq 1$  then we know that  $g^n$  is negative for  $\lambda$  in a right neighborhood of  $\lambda(x)$  defined by  $w^n(\lambda(x)) = x$ , and also in a left neighborhood of  $\bar{\lambda}$ . Hence if there exists some  $\lambda \in (\lambda(x), \bar{\lambda})$  where  $g^n > 0$ , then  $g^n$  must have a unique maximum  $\lambda^*$  over this range, and will be rising from  $\lambda(x)$  to  $\lambda^*$  and decreasing thereafter. Hence  $g^n$  is inverse U-shaped if it is positive somewhere, which implies DCP. ■

*Proof of Proposition 5:* Part (ii) of the result follows from the fact that at  $\lambda = 0$  all households are unskilled, earn a wage of  $\underline{w}$  which is smaller than the lowest education cost (owing to (a)), so the requirement of nonnegativity of consumption prevents any of them from investing.

So we turn to (i). Assumption (b) ensures that the downward flow will be positive at all steady  $\lambda > 0$ , so any SS with a positive skill ratio must involve mobility. Suppose  $\lambda^* > 0$  is a SS. Then Proposition 3 says that generically  $\lambda^*$  is locally unique; moreover  $u(\lambda)$  and  $d(\lambda)$  are  $C^1$  functions in a neighborhood of  $\lambda^*$  with distinct slopes. There exist right and left neighborhoods  $N_r$  and  $N_l$  of  $\lambda^*$  such that either: (A)  $d(\lambda) > u(\lambda)$  for all  $\lambda \in N_r$  and  $d(\lambda) < u(\lambda)$  for all  $\lambda \in N_l$ , or (B)  $d(\lambda) < u(\lambda)$  for all  $\lambda \in N_r$  and  $d(\lambda) > u(\lambda)$  for all  $\lambda \in N_l$ .

Suppose (A) is true. Assumption (a) implies that  $u = 0$  in a neighborhood  $N_u$  of  $\lambda = 0$  where the unskilled wage falls below  $\underline{x}$ . So there is a  $\lambda_1 > 0$  in this neighborhood where  $u = 0 < d$ . On the other hand  $u > d$  in  $N_l$ . Since  $u$  and  $d$  are u.s.c. and convex-valued, there must exist an intermediate skill ratio between neighborhoods  $N_l$  and  $N_u$  which is a SS with mobility.

And if (B) is true, then noting that  $u(\bar{\lambda}) = 0 < d(\bar{\lambda})$ , there must exist a skill ratio between  $N_r$  and  $\bar{\lambda}$  where upward and downward flows match. In either case, there must be a SS distinct from  $\lambda^*$ . ■

*Proof of Proposition 7:* First, note that families' inertia has no effect whatsoever on the location of steady states without mobility. So to prove 1. it suffices to investigate the distance between *mobile* steady states of  $\Phi$  and  $\Phi^{\bar{p},\varepsilon}$ , which are generically locally unique.<sup>20</sup> Second, note that steady state upward and downward flows under  $\Phi^{\bar{p},\varepsilon}$  – denoted by  $u_{\bar{p},\varepsilon}(\lambda)$  and  $d_{\bar{p},\varepsilon}(\lambda)$ , respectively – merely scale down  $u(\lambda)$  and  $d(\lambda)$  by factor  $\bar{p}$  if  $\varepsilon = 0$ . So

$$\mu_{\bar{p},0}(\lambda) \equiv u_{\bar{p},0}(\lambda) - d_{\bar{p},0}(\lambda) = \bar{p} [u(\lambda) - d(\lambda)]$$

---

<sup>20</sup>Local uniqueness implies that it is possible to choose  $\varepsilon$  small enough to ensure that  $\Phi$  and  $\Phi^{\bar{p},\varepsilon}$  have the same number of mobile steady states.

and steady states of processes  $\Phi$  and  $\Phi^{\bar{p},0}$  exactly coincide for any  $\bar{p} \in (0, 1]$ . We will argue that steady states of  $\Phi^{\bar{p},0}$  and  $\Phi^{\bar{p},\varepsilon}$  are close to each other in the sense of 1. for small  $\varepsilon > 0$ .

A smooth transition from zero probability of switching in response to  $\Delta U = 0$  up to probability  $\bar{p}$  in response to  $\Delta U \geq \varepsilon > 0$  implies that flow correspondences  $u_{\bar{p},\varepsilon}(\lambda)$  and  $d_{\bar{p},\varepsilon}(\lambda)$  are singleton-valued even if the cost distribution  $F$  has atoms. Let us confirm that introducing such a smooth transition from 0 to  $\bar{p}$  on interval  $[0, \varepsilon]$  shifts steady states continuously: Define  $x_\varepsilon^o(\lambda, \lambda')$  as the cost type with occupation  $o$  that has net switching benefits of  $\varepsilon$ , i. e.

$$g^o(\lambda, \lambda'; x_\varepsilon^o(\lambda, \lambda')) = \begin{cases} \varepsilon & \text{if } o = n, \\ -\varepsilon & \text{if } o = s. \end{cases}$$

We abbreviate the corresponding steady state or static-expectations thresholds and net gains by  $x_\varepsilon^o(\lambda) \equiv x_\varepsilon^o(\lambda, \lambda)$  and  $g^o(\lambda; x) \equiv g^o(\lambda, \lambda; x)$ ; as before let  $x^o(\lambda) \equiv x_0^o(\lambda)$  denote the cost that for fixed  $\lambda$  makes a parent with occupation  $o$  indifferent. Investment decisions of unskilled families (skilled families) with cost  $x \notin [x_\varepsilon^n(\lambda), x^n(\lambda)]$  ( $x \notin [x^s(\lambda), x_\varepsilon^s(\lambda)]$ , resp.) are the same under  $\Phi^{\bar{p},\varepsilon}$  and  $\Phi^{\bar{p},0}$ . Net upward flows  $\mu_{\bar{p},0}(\lambda)$  and  $\mu_{\bar{p},\varepsilon}(\lambda)$  may differ – and hence also their zeroes may differ – because for any  $\lambda$  there may exist unskilled families with  $x \in [x_\varepsilon^n(\lambda), x^n(\lambda)]$  for whom  $\mu_{\bar{p},0}(\lambda)$  overstates the actual switching probability by  $\bar{p} - p(g^n(\lambda; x))$ , and similarly skilled families whose switching probability is overstated.

If, for given  $\lambda$ ,  $F$  has atoms neither at  $x^n(\lambda)$  nor at  $x^s(\lambda)$ , both  $\mu_{\bar{p},\varepsilon}(\lambda)$  and  $\mu_{\bar{p},0}(\lambda)$  are singleton-valued. Then the distance between  $\mu_{\bar{p},0}(\lambda)$  and  $\mu_{\bar{p},\varepsilon}(\lambda)$  is

$$D(\lambda; \varepsilon) \equiv -(1 - \lambda) \int_{x_\varepsilon^n(\lambda)}^{x^n(\lambda)} [\bar{p} - p(g^n(\lambda; x))] dF(x) + \lambda \int_{x^s(\lambda)}^{x_\varepsilon^s(\lambda)} [\bar{p} - p(-g^s(\lambda; x))] dF(x).$$

$D(\lambda; \varepsilon)$  converges to zero as  $\varepsilon \rightarrow 0$  for any  $\lambda$  because  $x_\varepsilon^o(\lambda) \rightarrow x^o(\lambda)$  for  $o = n, s$ . The distance between steady states of  $\Phi^{\bar{p},0}$  and  $\Phi^{\bar{p},\varepsilon}$  (=zeroes of  $\mu_{\bar{p},0}(\lambda)$  and  $\mu_{\bar{p},\varepsilon}(\lambda)$ ) must hence converge to zero, too. In particular, it can be bounded above by  $\varepsilon'$  through an appropriate choice of  $\varepsilon$ .

When  $F$  has an atom at  $x^n(\lambda)$  or  $x^s(\lambda)$ , the location of steady states is affected by smoothing only if  $\mu_{\bar{p},0}(\lambda) \ni \{0\}$ . While it need not be true that the (vertical) distance between  $\mu_{\bar{p},0}(\lambda)$  and  $\mu_{\bar{p},\varepsilon}(\lambda)$  becomes arbitrarily small for  $\varepsilon \rightarrow 0$ , there must still exist  $\delta > 0$  such that  $\{0\} \in \mu_{\bar{p},\varepsilon}(\lambda')$  for some  $\lambda' \in (\lambda - \delta, \lambda + \delta)$  and  $\delta \rightarrow 0$  as  $\varepsilon \rightarrow 0$ : Suppose first that an atom of skilled families with cost  $x^s(\lambda)$  causes  $\mu_{\bar{p},0}$  to turn from positive to negative at  $\lambda$ . Then none of the skilled  $x^s(\lambda)$ -types disinvests at  $\lambda$  under  $\Phi^{\bar{p},\varepsilon}$ , but the same share  $\bar{p}$  as under  $\Phi^{\bar{p},0}$  does at  $\lambda''$  defined by  $g^s(\lambda'', \lambda''; x^s(\lambda)) = -\varepsilon$ . So  $\mu_{\bar{p},\varepsilon}(\lambda) > 0$ , but  $\mu_{\bar{p},\varepsilon}(\lambda'') < 0$  (for  $\varepsilon$  small enough so that  $u(\cdot)$  has no upward jump between  $\lambda$  and

$\lambda''$ ). Choosing  $\delta \equiv \lambda'' - \lambda$ , the (singleton-valued) continuous correspondence  $\mu_{\bar{p},\varepsilon}(\cdot)$  must assume zero at some  $\lambda' \in (\lambda, \lambda + \delta)$ . Continuity of  $g^s$  implies that  $\delta \rightarrow 0$  as  $\varepsilon \rightarrow 0$ . Analogous reasoning applies if an atom of unskilled families causes a drop of  $\mu_{\bar{p},0}(\cdot)$  to below zero or a jump to above zero. This proves the first part of Proposition 7.

Now turn to the second part of the proposition. Denote the upward and downward flows which would result for given  $\lambda_t$  and anticipated  $\lambda_{t+1}^e$  by  $u_{\bar{p},\varepsilon}(\lambda_t, \lambda_{t+1}^e)$  and  $d_{\bar{p},\varepsilon}(\lambda_t, \lambda_{t+1}^e)$ ; treat them as real numbers (rather than sets containing a single real number) in order to simplify notation in the following. Let  $\lambda^+(\lambda_t)$  denote the (unique) solution to

$$\lambda_t + u_{\bar{p},\varepsilon}(\lambda_t, \lambda^+) - d_{\bar{p},\varepsilon}(\lambda_t, \lambda^+) = \lambda^+.$$

So

$$\nu_{\bar{p},\varepsilon}(\lambda_t) \equiv u_{\bar{p},\varepsilon}(\lambda_t, \lambda^+(\lambda_t)) - d_{\bar{p},\varepsilon}(\lambda_t, \lambda^+(\lambda_t))$$

is the competitive equilibrium net upward flow characterizing  $\Phi^{\bar{p},\varepsilon}$ . In contrast,  $\mu_{\bar{p},\varepsilon}(\lambda_t) \equiv u_{\bar{p},\varepsilon}(\lambda_t, \lambda_t) - d_{\bar{p},\varepsilon}(\lambda_t, \lambda_t)$  is the net flow that would result from agents having static expectations. It corresponds to the steady state flow investigated above and would produce a disequilibrium except if  $\lambda_t$  is indeed a SS. Upward or downward adjustments under perfect foresight are bounded above by the corresponding adjustments under static expectations:

**LEMMA 5**  $|\nu_{\bar{p},\varepsilon}(\lambda_t)| \leq |\mu_{\bar{p},\varepsilon}(\lambda_t)|$ .

*Proof:*

Suppose  $\nu_{\bar{p},\varepsilon}(\lambda_t) \equiv \lambda^+(\lambda_t) - \lambda_t > 0$ , i. e.  $\lambda_{t+1} > \lambda_t$  under perfect foresight. Then

$$\begin{aligned} \nu_{\bar{p},\varepsilon}(\lambda_t) &= u_{\bar{p},\varepsilon}(\lambda_t, \lambda^+(\lambda_t)) - d_{\bar{p},\varepsilon}(\lambda_t, \lambda^+(\lambda_t)) \\ &\leq u_{\bar{p},\varepsilon}(\lambda_t, \lambda_t) - d_{\bar{p},\varepsilon}(\lambda_t, \lambda_t) \\ &= \mu_{\bar{p},\varepsilon}(\lambda_t) \end{aligned}$$

because unskilled families' incentive to invest decreases in  $\lambda_{t+1}$ , and skilled families' incentive to disinvest increases in  $\lambda_{t+1}$ . Similarly, for  $\lambda^+(\lambda_t) < \lambda_t$ , or  $\nu_{\bar{p},\varepsilon}(\lambda_t) < 0$ , we have

$$\begin{aligned} \nu_{\bar{p},\varepsilon}(\lambda_t, \lambda^+(\lambda_t)) &= u_{\bar{p},\varepsilon}(\lambda_t, \lambda^+(\lambda_t)) - d_{\bar{p},\varepsilon}(\lambda_t, \lambda^+(\lambda_t)) \\ &\geq u_{\bar{p},\varepsilon}(\lambda_t, \lambda_t) - d_{\bar{p},\varepsilon}(\lambda_t, \lambda_t) \\ &= \mu_{\bar{p},\varepsilon}(\lambda_t). \end{aligned}$$

□

Define the *static expectations process*  $\tilde{\Phi}^{\bar{p},\varepsilon}$  by

$$\lambda_{t+1} \equiv \lambda_t + \mu_{\bar{p},\varepsilon}(\lambda_t).$$

Note that  $\Phi^{\bar{p},\varepsilon}$  and  $\tilde{\Phi}^{\bar{p},\varepsilon}$  have the same steady states, and adjustments of  $\lambda_t$  are always in the same direction. Thus, if for suitable choice of  $\bar{p}$  and  $\varepsilon$  the possible overshooting in adjustment towards a (non-repelling) steady state  $\lambda^*$  is moderate enough for convergence of  $\tilde{\Phi}^{\bar{p},\varepsilon}$ , then  $\Phi^{\bar{p},\varepsilon}$  must converge, too.

Recall that  $f$  denotes the density of the absolutely continuous part of type distribution  $F$ ; let  $\eta(x_a) \equiv F(x_a) - F^0(x_a)$  denote the measure of  $F$ 's atoms  $x_a$  with  $a \in A \subset \mathbb{N}$ . Then

$$\begin{aligned} \mu_{\bar{p},\varepsilon}(\lambda) &= (1-\lambda) \left[ \int_{\underline{x}}^{x^n(\lambda)} p(g^n(\lambda; x)) f(x) dx + \sum_{\substack{a \in A, \\ x_a \leq x^n(\lambda)}} \eta(x_a) p(g^n(\lambda; x)) \right] \\ &\quad - \lambda \left[ \int_{x^s(\lambda)}^{\bar{x}} p(-g^s(\lambda; x)) f(x) dx + \sum_{\substack{a \in A, \\ x_a \geq x^s(\lambda)}} \eta(x_a) p(-g^s(\lambda; x)) \right] \end{aligned}$$

Differentiating yields

$$\begin{aligned} \frac{d\mu_{\bar{p},\varepsilon}(\lambda)}{d\lambda} &= - \left[ \int_{\underline{x}}^{x^n(\lambda)} p(g^n(\lambda; x)) f(x) dx + \sum_{\substack{a \in A, \\ x_a \leq x^n(\lambda)}} \eta(x_a) p(g^n(\lambda; x)) \right] \\ &\quad + (1-\lambda) \left[ p(g^n(\lambda; x^n(\lambda))) f(x^n(\lambda)) \frac{dx^n(\lambda)}{d\lambda} + \right. \\ &\quad \left. + \int_{\underline{x}}^{x^n(\lambda)} \frac{dp(\cdot)}{d\Delta U} \frac{\partial g^n(\lambda; x)}{\partial \lambda} f(x) dx + \sum_{\substack{a \in A, \\ x_a \leq x^n(\lambda)}} \eta(x_a) \frac{dp(\cdot)}{d\Delta U} \frac{\partial g^n(\lambda; x)}{\partial \lambda} \right] \\ &\quad - \left[ \int_{x^s(\lambda)}^{\bar{x}} p(-g^s(\lambda; x)) f(x) dx + \sum_{\substack{a \in A, \\ x_a \geq x^s(\lambda)}} \eta(x_a) p(-g^s(\lambda; x)) \right] \\ &\quad - \lambda \left[ - p(-g^s(\lambda; x^s(\lambda))) f(x^s(\lambda)) \frac{dx^s(\lambda)}{d\lambda} \right. \\ &\quad \left. - \int_{x^s(\lambda)}^{\bar{x}} \frac{dp(\cdot)}{d\Delta U} \frac{\partial g^s(\lambda; x)}{\partial \lambda} f(x) dx - \sum_{\substack{a \in A, \\ x_a \geq x^s(\lambda)}} \eta(x_a) \frac{dp(\cdot)}{d\Delta U} \frac{\partial g^s(\lambda; x)}{\partial \lambda} \right]. \end{aligned}$$

We can concentrate on adjustment *towards* a steady state  $\lambda^*$ , so that  $d\mu_{\bar{p},\varepsilon}(\lambda)/d\lambda < 0$  holds near  $\lambda^*$ . A sufficient condition for local stability and convergence to  $\lambda^*$  from any  $\lambda_t \in (\lambda^* - \delta, \lambda^* + \delta)$  for some  $\delta > 0$  is then that  $d\mu_{\bar{p},\varepsilon}(\lambda)/d\lambda > -1$ . Using  $p(\cdot) \leq \bar{p}$ ,  $dp/d\Delta U \geq 0$ , and  $dp/d\Delta U \leq l\bar{p}/\varepsilon$ , we obtain

$$\begin{aligned}
\frac{d\mu_{\bar{p},\varepsilon}(\lambda)}{d\lambda} &\geq -[\bar{p} + \bar{p}] \\
&\quad + (1 - \lambda) [\bar{p} \cdot k_1 + l\bar{p}/\varepsilon \cdot k_2] \\
&\quad - [\bar{p} + \bar{p}] \\
&\quad - \lambda [\bar{p} \cdot k_3 + l\bar{p}/\varepsilon \cdot k_4]
\end{aligned}$$

with

$$\begin{aligned}
k_1 &\equiv - \left| \inf_{\lambda \in [0, \bar{\lambda}]} f(x^n(\lambda)) \frac{dx^n(\lambda)}{d\lambda} \right| \\
k_2 &\equiv - \left| \inf_{\lambda \in [0, \bar{\lambda}]} \int_{x_z^n(\lambda)}^{x^n(\lambda)} \frac{\partial g^n(\lambda; x)}{\partial \lambda} f(x) dx \right| - \left| \inf_{\lambda \in [0, \bar{\lambda}]} \frac{\partial g^n(\lambda; x)}{\partial \lambda} \right| \\
k_3 &\equiv - \inf_{\lambda \in [0, \bar{\lambda}]} f(x^s(\lambda)) \frac{dx^s(\lambda)}{d\lambda} \geq 0 \\
k_4 &\equiv - \inf_{\lambda \in [0, \bar{\lambda}]} \int_{x^s(\lambda)}^{\bar{x}} \frac{\partial g^s(\lambda; x)}{\partial \lambda} f(x) dx - \inf_{\lambda \in [0, \bar{\lambda}]} \frac{\partial g^s(\lambda; x)}{\partial \lambda} > 0
\end{aligned}$$

or, in summary,

$$0 > \frac{d\mu_{\bar{p},\varepsilon}(\lambda)}{d\lambda} \geq -\bar{p} \cdot K$$

with

$$K \equiv 4 - (1 - \lambda)(k_1 + k_2 l/\varepsilon) + \lambda(k_3 + k_4 l/\varepsilon) > 0.$$

Hence,  $|d\mu_{\bar{p},\varepsilon}(\lambda^*)/d\lambda| < 1$  for  $\bar{p} > 0$  appropriately close to zero. So for each non-repelling mobile steady state  $\lambda$  there exists a  $\delta_\lambda > 0$  such that  $\tilde{\Phi}^{\bar{p},\varepsilon}$  and  $\Phi^{\bar{p},\varepsilon}$  converge to  $\lambda$  from any  $\lambda_0 \in (\lambda - \delta_\lambda, \lambda + \delta_\lambda)$ .

Denote the minimum of  $\delta_\lambda$  over all (generically finite) steady states by  $\delta^*$ . An upper bound to any one-step upward/downward adjustment of  $\lambda_t$  is given by  $\bar{p}$  because the maximal measure of unskilled/skilled families is one. So choosing  $\bar{p} < 2\delta^*$  ensures that neither  $\tilde{\Phi}^{\bar{p},\varepsilon}$  nor  $\Phi^{\bar{p},\varepsilon}$  jump over the non-empty neighborhood of the nearest (non-repelling) mobile steady state. Since the latter is asymptotically stable, both processes must globally converge. This concludes the proof of Proposition 7.

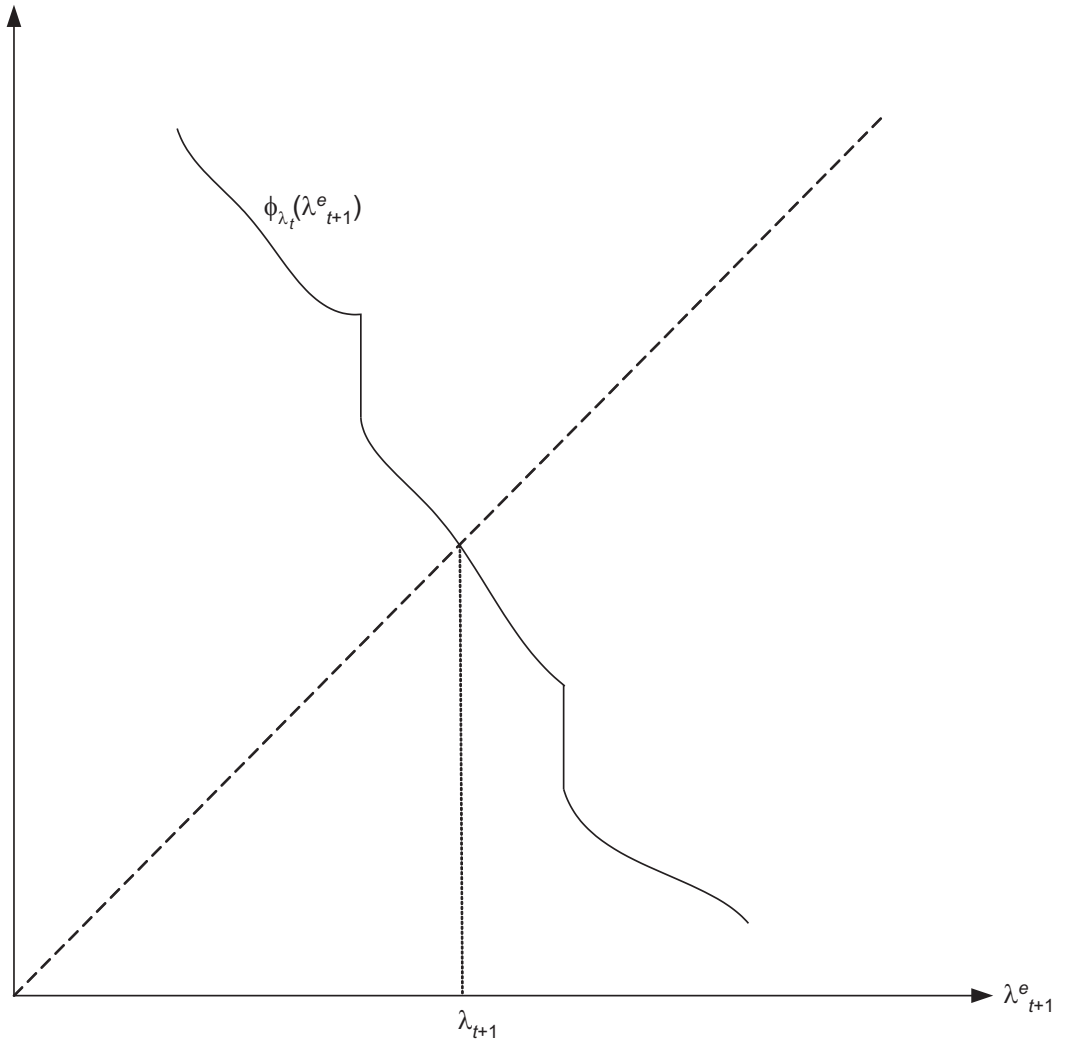

Figure 1: COMPETITIVE EQUILIBRIUM GIVEN ARBITRARY CURRENT SKILL RATIO  $\lambda_t$

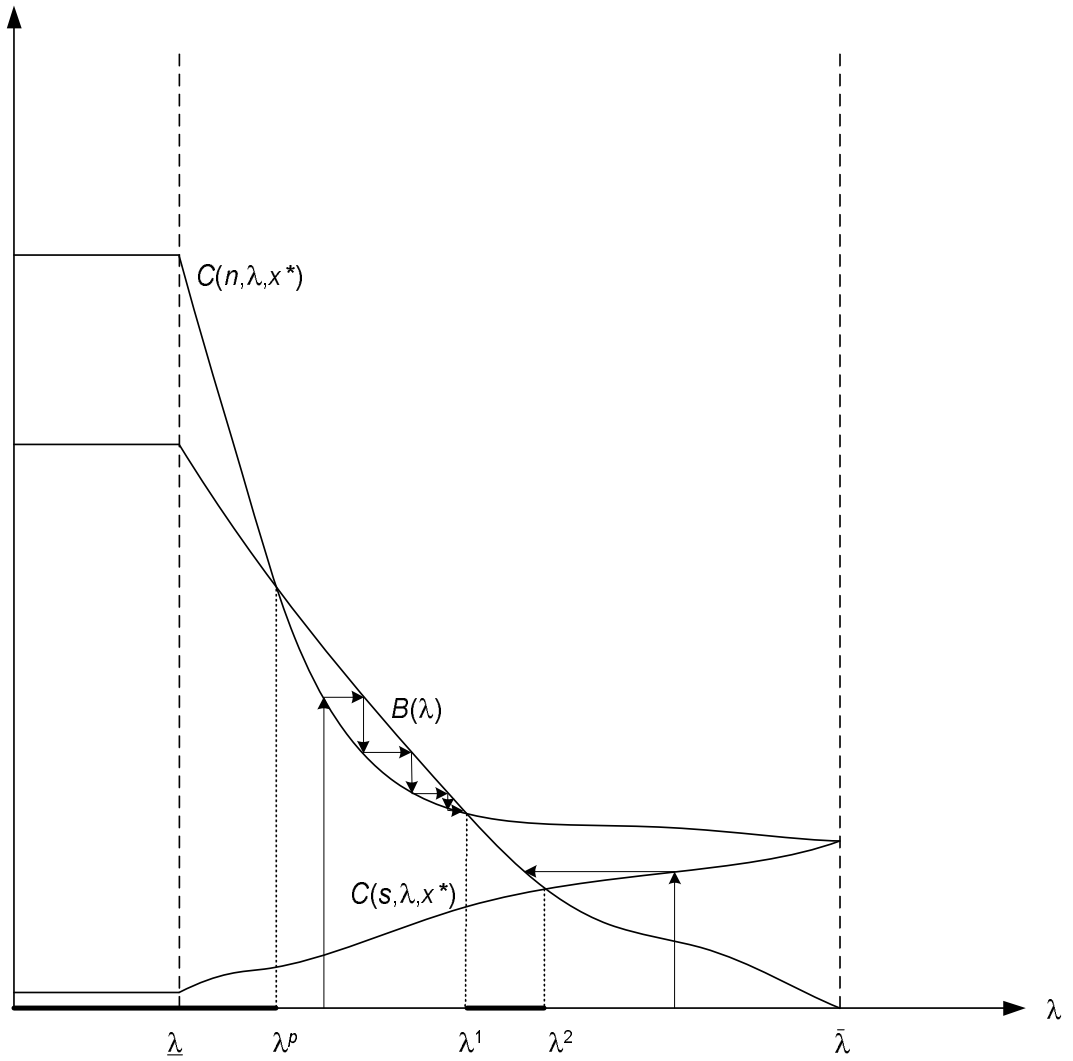

Figure 2: HOMOGENEOUS AGENTS: STEADY STATES AND DYNAMICS



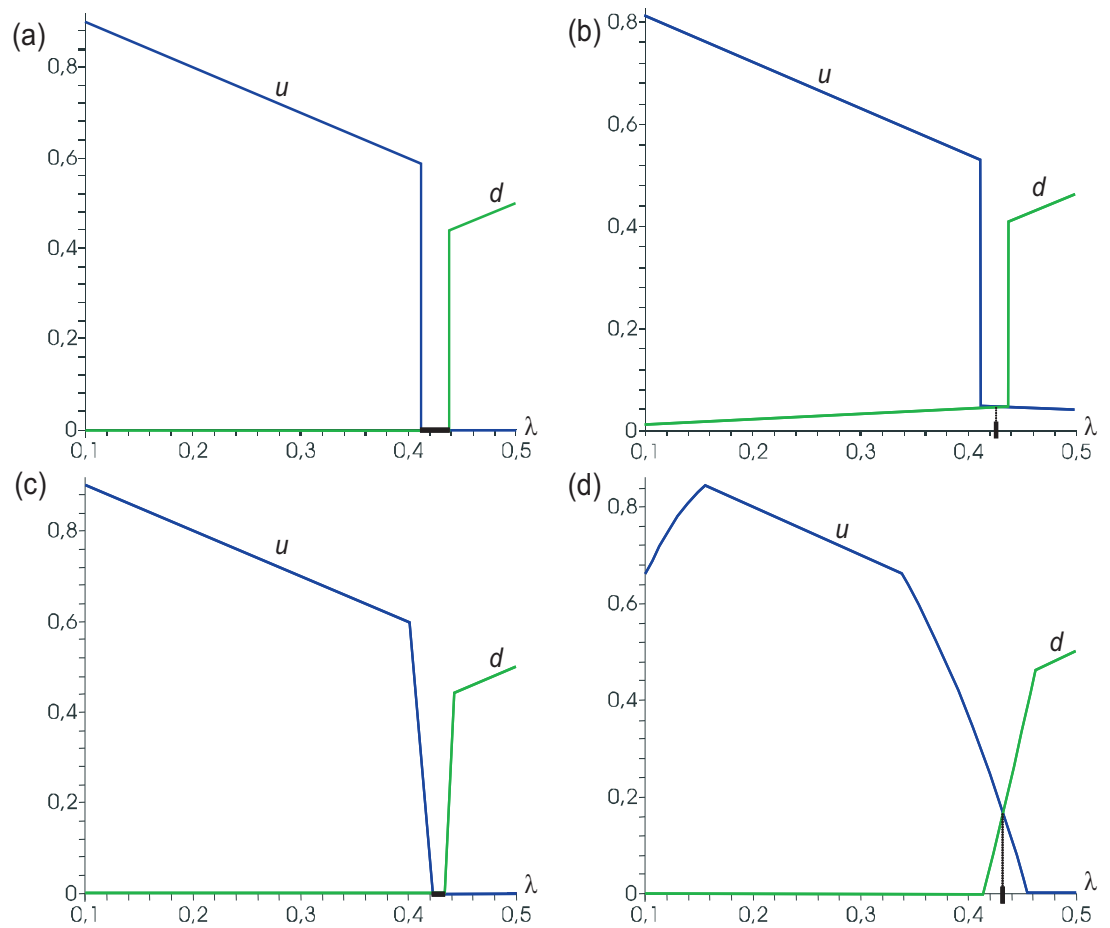

Figure 3: UPWARD AND DOWNWARD FLOWS  $u(\lambda)$  AND  $d(\lambda)$  FOR (A) HOMOGENEOUS COST 0.125; (B) MEASURES  $\gamma = 0.075$  AND  $\iota = 0.1$  OF GENIUSES AND IDIOTS, AND NORMAL AGENTS WITH COST 0.125; (C) COST DISTRIBUTED UNIFORMLY ON  $[0.115, 0.135]$ ; AND (D) UNIFORMLY ON  $[0.075, 0.175]$

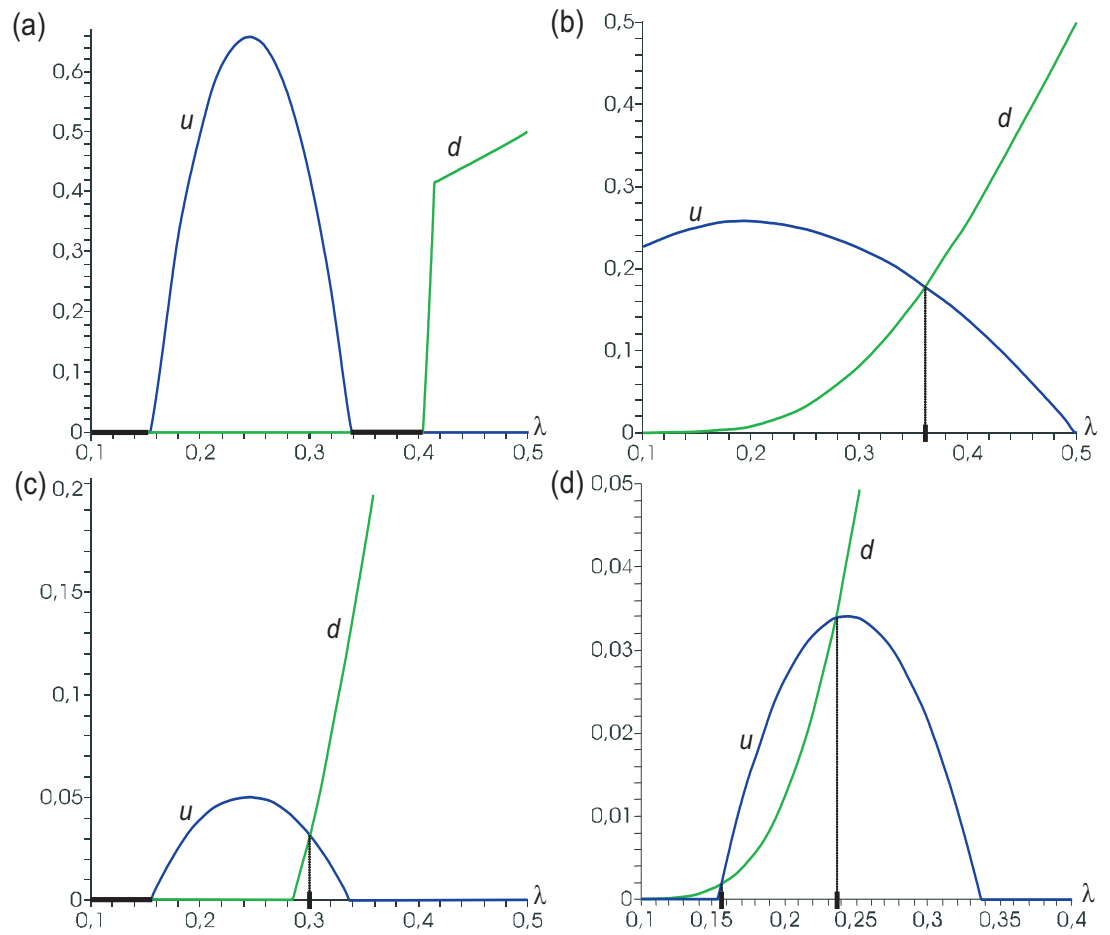

Figure 4: UPWARD AND DOWNWARD FLOWS  $u(\lambda)$  AND  $d(\lambda)$  FOR A  $(0.185, 0.3)$ -NORMAL DISTRIBUTION OF COSTS TRUNCATED ON (A)  $[0.175, 0.195]$ ; (B)  $[0, \infty)$ ; (C)  $[0.175, 0.475]$ ; AND (D)  $[0.175, \infty)$

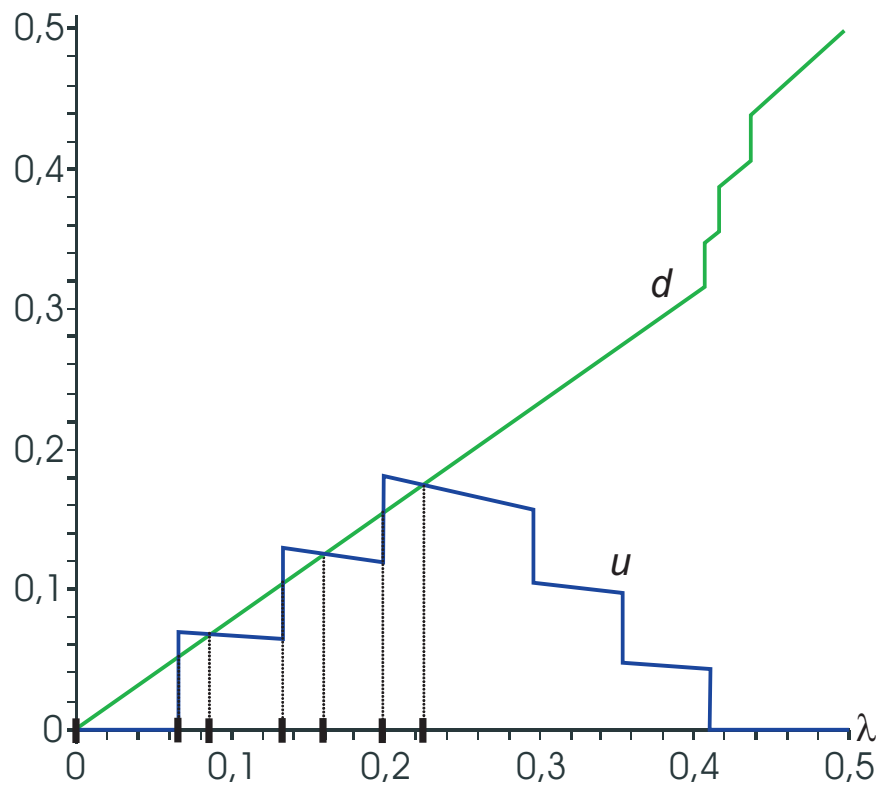

Figure 5: UPWARD AND DOWNWARD FLOWS  $u(\lambda)$  AND  $d(\lambda)$  FOR COST TYPES  $1/8$ ,  $1/6$ ,  $3/16$ , AND  $10$  HAVING MEASURES  $0.075$ ,  $0.075$ ,  $0.075$ , AND  $0.775$ , RESPECTIVELY

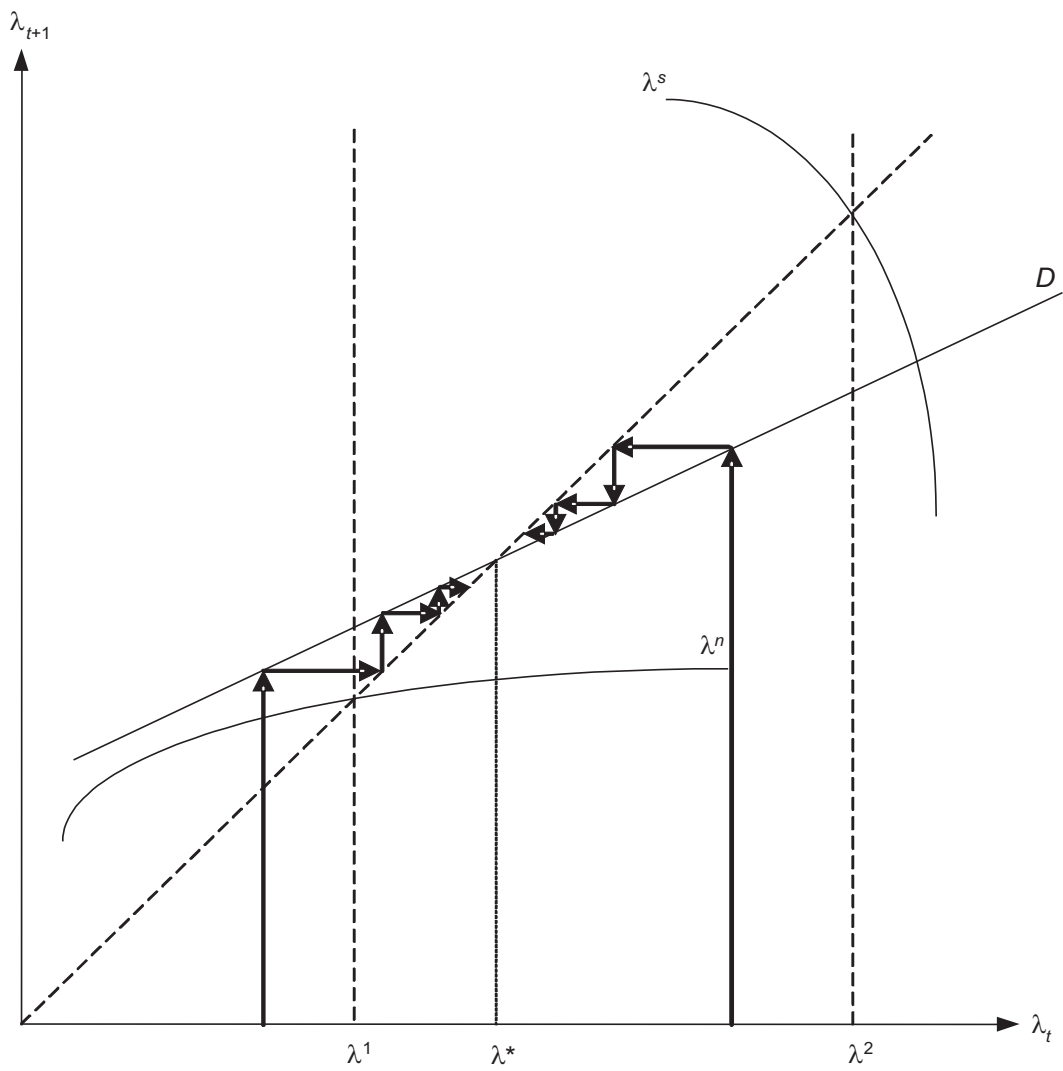

Figure 6: GENIUS-IDIOT EXAMPLE: CONVERGENT DYNAMICS

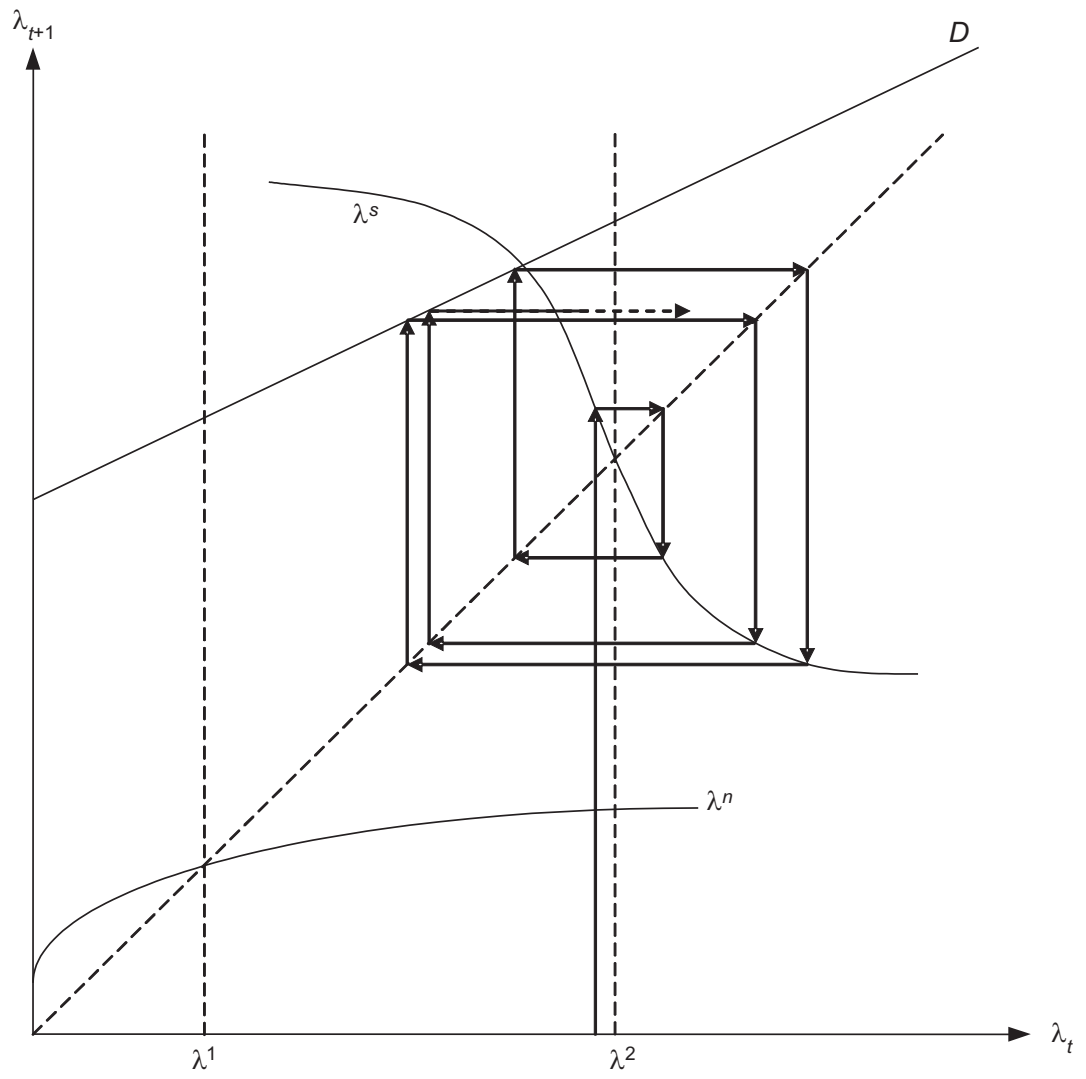

Figure 7: GENIUS-IDIOT EXAMPLE: DIVERGENT DYNAMICS

**Aboa Centre for Economics (ACE)** was founded in 1998 by the departments of economics at the Turku School of Economics and Business Administration, Åbo Akademi University and University of Turku. The aim of the Centre is to coordinate research and education related to economics in the three universities.

Contact information: Aboa Centre for Economics, Turku School of Economics and Business Administration, Rehtorinpellonkatu 3, 20500 Turku, Finland.

**Aboa Centre for Economics (ACE)** on Turun kolmen yliopiston vuonna 1998 perustama yhteistyöelin. Sen osapuolet ovat Turun kauppakorkeakoulun kansantaloustieteen oppiaine, Åbo Akademin national-ekonomi-oppiaine ja Turun yliopiston taloustieteen laitos. ACEn toiminta-ajatuksena on koordinoida kansantaloustieteen tutkimusta ja opetusta Turun kolmessa yliopistossa.

Yhteystiedot: Aboa Centre for Economics, Kansantaloustiede, Turun kauppakorkeakoulu, 20500 Turku.

[www.tukkk.fi/ace](http://www.tukkk.fi/ace)

ISSN 1796-3133