

De Bruin, Kelly C.; Monaghan, Eoin; Yakut, Aykut Mert

Research Report

The economic and distributional impacts of an increased carbon tax with different revenue recycling schemes

Research Series, No. 95

Provided in Cooperation with:

The Economic and Social Research Institute (ESRI), Dublin

Suggested Citation: De Bruin, Kelly C.; Monaghan, Eoin; Yakut, Aykut Mert (2019) : The economic and distributional impacts of an increased carbon tax with different revenue recycling schemes, Research Series, No. 95, ISBN 978-0-7070-0506-5, The Economic and Social Research Institute (ESRI), Dublin, <https://doi.org/10.26504/rs95.pdf>

This Version is available at:

<https://hdl.handle.net/10419/230301>

Standard-Nutzungsbedingungen:

Die Dokumente auf EconStor dürfen zu eigenen wissenschaftlichen Zwecken und zum Privatgebrauch gespeichert und kopiert werden.

Sie dürfen die Dokumente nicht für öffentliche oder kommerzielle Zwecke vervielfältigen, öffentlich ausstellen, öffentlich zugänglich machen, vertreiben oder anderweitig nutzen.

Sofern die Verfasser die Dokumente unter Open-Content-Lizenzen (insbesondere CC-Lizenzen) zur Verfügung gestellt haben sollten, gelten abweichend von diesen Nutzungsbedingungen die in der dort genannten Lizenz gewährten Nutzungsrechte.

Terms of use:

Documents in EconStor may be saved and copied for your personal and scholarly purposes.

You are not to copy documents for public or commercial purposes, to exhibit the documents publicly, to make them publicly available on the internet, or to distribute or otherwise use the documents in public.

If the documents have been made available under an Open Content Licence (especially Creative Commons Licences), you may exercise further usage rights as specified in the indicated licence.



<https://creativecommons.org/licenses/by/4.0/>

RESEARCH
SERIES
NUMBER 95
October 2019

THE ECONOMIC AND DISTRIBUTIONAL IMPACTS OF AN INCREASED CARBON TAX WITH DIFFERENT REVENUE RECYCLING SCHEMES

KELLY DE BRUIN, EOIN MONAGHAN AND AYKUT MERT YAKUT



THE ECONOMIC AND DISTRIBUTIONAL IMPACTS OF AN INCREASED CARBON TAX WITH DIFFERENT REVENUE RECYCLING SCHEMES

Kelly de Bruin

Eoin Monaghan

Aykut Mert Yakut

October 2019

RESEARCH SERIES

NUMBER 95

Available to download from www.esri.ie

© The Economic and Social Research Institute

Whitaker Square, Sir John Rogerson's Quay, Dublin 2

ISBN 978-0-7070-0506-5

DOI <https://doi.org/10.26504/rs95.pdf>



This Open Access work is licensed under a Creative Commons Attribution 4.0 International License (<https://creativecommons.org/licenses/by/4.0/>), which permits unrestricted use, distribution, and reproduction in any medium, provided the original work is properly credited.

ABOUT THE ESRI

The mission of the Economic and Social Research Institute is to advance evidence-based policymaking that supports economic sustainability and social progress in Ireland. ESRI researchers apply the highest standards of academic excellence to challenges facing policymakers, focusing on 12 areas of critical importance to 21st Century Ireland.

The Institute was founded in 1960 by a group of senior civil servants led by Dr T.K. Whitaker, who identified the need for independent and in-depth research analysis to provide a robust evidence base for policymaking in Ireland.

Since then, the Institute has remained committed to independent research and its work is free of any expressed ideology or political position. The Institute publishes all research reaching the appropriate academic standard, irrespective of its findings or who funds the research.

The quality of its research output is guaranteed by a rigorous peer review process. ESRI researchers are experts in their fields and are committed to producing work that meets the highest academic standards and practices.

The work of the Institute is disseminated widely in books, journal articles and reports. ESRI publications are available to download, free of charge, from its website. Additionally, ESRI staff communicate research findings at regular conferences and seminars.

The ESRI is a company limited by guarantee, answerable to its members and governed by a Council, comprising 14 members who represent a cross-section of ESRI members from academia, civil services, state agencies, businesses and civil society. The Institute receives an annual grant-in-aid from the Department of Public Expenditure and Reform to support the scientific and public interest elements of the Institute's activities; the grant accounted for an average of 30 per cent of the Institute's income over the lifetime of the last Research Strategy. The remaining funding comes from research programmes supported by government departments and agencies, public bodies and competitive research programmes.

Further information is available at www.esri.ie

The Economic and Distributional Impacts of an Increased Carbon Tax with Different Revenue Recycling Schemes

Kelly de Bruin*

Eoin Monaghan†

Aykut Mert Yakut‡

Acknowledgements

The research carried out in this report was funded by the Department of Finance under the ESRI Department of Finance Joint Research Programme on Macroeconomy, Taxation and Banking and is part of an ongoing modelling project funded by the Department of Communications, Climate Action and Environment (DCCAE).

This report has been accepted for publication by the Institute, which does not itself take institutional policy positions. All ESRI Research Series reports are peer reviewed prior to publication. The authors are solely responsible for the content and the views expressed.

*Research Officer, Economic and Social Research Institute, Dublin, Ireland. Kelly.deBruin@esri.ie

†Research Assistant, Economic and Social Research Institute, Dublin, Ireland. Eoin.Monaghan@esri.ie

‡Postdoctoral Research Fellow, Economic and Social Research Institute, Dublin, Ireland. Mert.Yakut@esri.ie

Table of Contents

Executive Summary	3
1 Introduction	5
2 Literature review	7
2.1 Distributional Implications	7
2.2 Double Dividend	9
3 The I3E Model	10
4 Results	12
4.1 Scenarios	12
4.2 Impacts on Emissions	14
4.2.1 Total Emissions	14
4.2.2 Non-ETS Emissions	15
4.2.3 Household Emissions	16
4.2.4 Production Emissions	16
4.3 Economic Impacts	18
4.3.1 Macro-level impacts	18
4.3.2 Sector level impacts	20
4.3.3 Price impacts	22
4.3.4 Households impacts	22
5 Conclusion	25
Appendix A Lists of Activities and Commodities	27
Appendix B Nested Structure of Consumption	28
Appendix C Nested Structure of Production	30
6 References	31

Executive Summary

Introduction

The recent all Government Climate Action Plan proposes an increase in the Irish carbon tax along a trajectory which reaches €80 by 2030. In line with this, this study investigates the economic, household level and environmental impacts of increasing the current carbon tax in Ireland from €20 per tonne of CO₂ to €30 in 2020, further increasing it by €5 annually, thus reaching €80 (in nominal terms) by 2030. In our analysis, we examine not only the impacts of the increase in carbon tax alone, but also the impacts of how the carbon tax revenue is used, i.e. recycled. Our analysis shows that increasing the carbon tax will help Ireland reduce its emissions somewhat, but more initiatives are needed to reach the EU targets. Furthermore, an increase in the carbon tax will have limited impacts on GDP. The choice of how to use the revenues from the increased carbon tax will have significant implications for both macroeconomic impacts and household distributional impacts. Depending on the policy goal, the appropriate recycling scheme can reduce GDP impacts, decrease government debt, limit inflation or decrease inequality across households types.

Main Findings

- Total emissions will continue to grow over time, indicating that the suggested increase in carbon tax *on its own* is not sufficient to fully decouple emissions from economic growth.
- The increased carbon tax will result in an economy-wide emission reduction of almost 15% by 2030 compared to no increase in the carbon tax. The choice of revenue recycling scheme, i.e. how the carbon tax revenue is used, has negligible impacts on emissions reductions.
- Rural households emit more GHGs than rural households and richer households emit more than poorer households.
- Real GDP will continue to grow over time; however, a carbon tax increase will dampen real GDP growth to a small degree. The exact impact will depend on how carbon tax revenues are used, where the maximum reduction is 0.6% of GDP compared to no carbon tax increase in 2030.
- Real disposable income impacts across households depend significantly on the chosen recycling scheme, where impacts range from a 0.5% decrease in real income to a 2% increase.
- Using carbon tax revenues to reduce foreign debt results in the highest macroeconomic impacts and reduction in household income.
- Using carbon tax revenues to reduce other distortionary taxes, such as sales, wage or corporate tax, can reduce the macroeconomic impacts of a carbon tax increase and lead to increases in household income, but often results in more regressive impacts across households.

- Recycling carbon tax revenues back to households in the form of transfers can significantly reduce the regressiveness of the impacts of a carbon tax increase, but result in relatively larger macroeconomic impacts and lower average household income.
- Carbon-intensive production sectors, such as transport, mining and electricity production, will be hit the hardest by a carbon tax increase, whereas low carbon intensive sectors can benefit from a carbon tax increase, such as the accommodation sector.
- Energy prices will increase by approximately 10% by 2030 due to the carbon tax increase, whereas other prices will increase by on average 0.3%. The overall consumer price level (CPI) will increase by on average 2%.
- Rural households face higher increases in consumption prices than urban households. Price impacts across households are regressive in rural areas, whereas in urban areas middle income households face the highest price impacts.
- In reaction to increased prices, all households will reduce their consumption, and poorer rural households show the largest decreases.

1 Introduction

Climate change is one of the greatest challenges facing our planet. Human-induced climate change is estimated to have increased atmospheric temperatures by over 0.8°C to date compared to pre-industrial levels (IPCC, 2014). Higher temperatures, increased variability in temperature and precipitation, more frequent extreme weather events and rising sea levels will result in significant impacts on societies and economies across the globe. In the case of Ireland, impacts over the coming decades could include, among others, damage to coastal areas as a result of rising sea levels, more intense storms and rainfall events, increased flooding, summer water shortages, increased risks of new pests and diseases and adverse impacts on water quality (Desmond et al., 2017).

The expected impacts of climate change have led to global recognition of the need to limit climate change. Through the United Nations Framework Convention on Climate Change (UNFCCC), countries have negotiated over the past decades to combine efforts to decrease greenhouse gas (GHG) emissions. In 2015, the Paris Agreement¹ was adopted and to date it has been ratified by 194 states and the European Union, though the US has given notice to withdraw from the agreement.

Members of the agreement submit their national emissions targets through Intended Nationally Determined Contributions (INDCs). The EU has been at the forefront of international efforts to reduce GHG emissions and was the first major economy to submit its INDCs. The main elements of the EU INDCs are summarised in the EU 2030 climate and energy framework², which defines three key targets to be reached by 2030: at least 40% GHG emissions reduction (compared to 1990 levels), at least 27% share of renewable energy, and at least 27% improvement in energy efficiency. The EU has also defined a longer-term perspective on climate and energy policy for 2050, which further decreases emissions by 80–95% of 1990 levels.

The EU has implemented a cap and trade system, namely the EU Emissions Trading System (ETS)³ to achieve these targets. In this system, heavy energy-using installations (power stations and industrial plants) and airlines in the EU have to buy emission allowances, which are auctioned based on the overall EU emissions cap. Each year companies need to surrender allowances to cover their emissions or face heavy fines.⁴ Companies can trade emission permits throughout the EU, ensuring reductions at the least cost. The EU ETS operates in all 28 EU countries as well as in Liechtenstein and Norway, covering 45% of EU GHG emissions. The cap is set to decrease emissions from the ETS sectors by 21% in 2020 (compared to 2005) and by 43% in 2030.

Emissions not covered by the ETS will also need to be reduced. The overall EU goal is to reduce non-ETS emissions by 30% by 2030 (compared to 2005). This overall EU goal is translated into an individual binding target for each Member State based on the Effort Sharing Decision. The non-ETS

¹ https://unfccc.int/sites/default/files/english_paris_agreement.pdf

² https://www.consilium.europa.eu/uedocs/cms_data/docs/pressdata/en/ec/145397.pdf

³ https://ec.europa.eu/clima/sites/clima/files/docs/ets_handbook_en.pdf

⁴ As the European Commission has not specified its policy regarding the mechanism and the level of fine yet, there is no explicit representation of this.

reduction target for Ireland is, along with that of Denmark and Luxembourg, the most challenging target in the EU, namely a 20% reduction compared to 2005 levels by 2020.⁵ Ireland also faces a renewable energy target of 16% of final energy use and 10% of energy use in transport. These targets are legally binding, and Ireland will face fines should it not meet its targets, though the precise level of these fines is uncertain.

As it stands, Ireland is likely to miss its targets. GHG emission projections show increases in most sectors in Ireland given the strong economic growth and the expansion of the agricultural sector (EPA, 2018). These estimates show that, at best, Ireland will achieve a 1% reduction of emissions by 2020 as opposed to its binding target of 20%. Though steps have been made to limit GHG emissions in Ireland through among others a carbon tax, it is evident that there is a strong need to improve climate policy in Ireland to reach its targets in order to avoid facing EU-level fines and to contribute to the transition to a low-carbon global economy.

Carbon pricing in the form of a carbon tax or cap and trade system is considered by economists to be the most cost-effective policy option to reduce carbon emissions. A recent statement issued by the European Association of Environment and Resource Economics (EAERE) signed by thousands of economists states: ‘A price on carbon offers the most cost-effective lever to reduce carbon emissions at the scale and speed that is necessary. By correcting a well-known market failure, a carbon price sends a powerful signal, steering economic actors towards a low-carbon future.’⁶ In this statement, it is also suggested that a carbon price should be steadily increased over time until the relevant emission goals are met.

Currently, the Irish carbon tax stands at €20 per tonne of CO₂. However, to ensure EU targets are met in a cost-effective way, the Irish carbon tax would need to be increased significantly. This report examines the impacts of increasing the carbon tax in Ireland over time. In line with the recently published Irish all Government Climate Action Plan we assume an increase in the carbon tax of €10 in 2020 and subsequent annual increases of €5 reaching a carbon tax of €80 in 2030.⁷ We examine how this increase in the carbon tax will affect projected emissions and economic growth. Furthermore, we examine how impacts are distributed across production sectors and household types, where we distinguish between 32 different production sectors and ten household types based on an urban-rural distinction and income levels.

The impacts of a carbon tax increase will depend not only on the level of the tax but also on how the carbon tax revenues are used, i.e. recycled. In this report, we examine several illustrative carbon tax revenue recycling schemes. Revenue recycling schemes are generally formulated based on the desire to either compensate those most impacted by the tax or increase economic growth.

Concerning compensation-based recycling, it is expected that poorer households carry a larger share of the burden of a carbon tax, relative to their income. Distributing carbon tax revenues to households is

⁵ <https://eur-lex.europa.eu/legal-content/EN/TXT/PDF/?uri=CELEX:32018R0842&from=EN>

⁶ <https://www.eaere.org/statement/>

⁷ <https://www.gov.ie/en/publication/5350ae-climate-action-plan/>

often proposed as an effective way of reducing the regressive aspects of a carbon tax. To investigate this, we examine two different transfer schemes. In the first, carbon tax revenues are given back to households on a per capita basis; in the second scheme, revenues are distributed based on the current welfare transfers. A further distributional concern is the impact of a carbon tax increase on specific production sector: in the case of Ireland this concerns the negative impacts on hauliers. We examine how a reduction in production tax for hauliers could compensate them for the expected losses due to the increase in carbon tax.

It is often suggested in the economic literature that the revenues from an environmental tax can be recycled to create a so-called double dividend, where other distortionary taxes can be reduced, boosting economic growth, while at the same time achieving emissions reductions. We examine whether a double dividend can be achieved in Ireland by using the carbon tax revenues to reduce wage, sales and labour tax, and what the distributional impacts across households of such schemes would be.

This report is structured as follows: in the next section, we present a literature review. In the third section, we outline the methodology which describes the I3E model. The fourth section describes the results of our analysis and the final section draws conclusions.

2 Literature review

There is a limited amount of literature which investigates the distributional and economic impacts of a carbon tax as it is a relatively new phenomenon. In this literature review, the focus is on studies which have taken Ireland as their context, as results can vary considerably across countries based on their specific characteristics. We examine firstly the literature that assesses the distributional implications of a carbon tax, and then secondly the literature that focuses on a potential double dividend.

2.1 Distributional Implications

International literature suggests that carbon/energy taxes generally are regressive in developed countries and progressive in developing countries. In line with this, carbon taxation in Ireland is found to be regressive in the bulk of the literature. Early work on Ireland considers the theory behind carbon taxes and revenue recycling while estimating the distributional effects on households ([Scott \(1992\)](#) in [FitzGerald & McCoy \(1992\)](#)). They find a regressive impact, where lower-income households face higher additional costs. Other earlier findings include [O'Donoghue \(1997\)](#), who, by incorporating the international sector into [Scott \(1992\)](#)'s model, found that a combination of direct and indirect taxes has a less regressive effect on the income distribution than a direct tax on household fuel expenditures.

[Scott et al. \(2008\)](#) assess the extent of fuel poverty in Ireland, finding that the relationship between a fuel tax rate (on all fuels except electricity) and the projected fuel poverty rate is broadly linear over the income distribution modelled when no revenue recycling is applied.

Elsewhere, [Callan et al. \(2009\)](#) use the ESRI's tax and benefit microsimulation (SWITCH) model of direct taxes and welfare payments to estimate the direct impacts of a carbon tax on the income distribution

of households. The analysis includes impacts on the cost of household carbon goods only, so-called direct impacts. They find that a carbon tax of €20 per tonne of carbon would be regressive. However, if the tax revenue is used to increase tax credits and social benefits, then households across the income distribution are made better off, with smaller gains at the first, fourth and tenth deciles. [Verde & Tol \(2009\)](#) use a similar approach to [Callan et al. \(2009\)](#), but include indirect impacts of the carbon tax on the price of other goods and find a lower level of regressivity, suggesting that indirect impacts are less regressive than direct impacts. They concur that households would be made better off by recycling the tax revenue via increasing tax credits and social benefits.

Ireland is also included as part of [Ekins et al. \(2011\)](#)'s multi-country European study, which analyses different tax scenarios using the macroeconomic forecasting E3ME model. It is found that when the tax reform is designed, given a low oil price, to induce a 20% reduction on GHG emissions from 1990, then Irish households will generally be made better off. However, there is a slight loss in household income for the lowest quantile. Ireland also features as part of a wider [Flues & Thomas \(2015\)](#) study into the distributional impacts of environmental taxes. An energy tax micro-simulation model is used to predict the average tax burden on groups split, for example, by household income, age and region. For Irish households, transport fuel taxes and heating fuel taxes are found to be regressive.

More recently [Bercholz & Roantree \(2019\)](#) apply the SWITCH model to investigate an increase in the carbon tax. They focus on direct impacts and find the carbon tax without revenue recycling to have regressive impacts. They examine several potential packages of carbon tax revenue recycling and their impacts. They find that when applying a lump-sum transfer, or when increasing social welfare benefits, the regressiveness of the tax can be reversed. Applying a reduction in income tax through an increase in income tax credit, they find that households will be better off as compared to the non-recycling case, but impacts remain regressive. Due to the detailed representation of households, they are also able to assess impacts on fuel poverty and find a small increase in fuel poverty as measured by households spending more than 10% of their income on fuel.

[Tovar Reaños & Lynch \(2019\)](#) develop a behavioural microsimulation model, which focuses on modelling households' responses to changes in prices. Their model examines a one-time increase in the carbon tax and analyses the direct impacts across households given their consumption responses. They find that households adjust their consumption away from carbon goods when an increase in the carbon tax is imposed, where they find a €30 increase leads to a 4% reduction in households' direct emissions. Without revenue recycling, they find that the carbon tax increase is regressive, and inequality increases. They furthermore investigate the use of revenue recycling to reduce the regressiveness of the carbon tax increase. They examine a 'flat' lump-sum transfer, where carbon tax revenues are shared across households equally. Using revenue recycling redistributes income to poorer households, making the first three quantiles better off and decreasing inequality. Moreover, they examine a 'targeted' transfer where carbon tax revenues are shared among household in inverse proportion to their income, i.e. poorer households receive a higher transfer compared to richer ones. This effect further redistributes the income from richer to poorer households where the first two quantiles are significantly better off with the carbon tax increase.

2.2 Double Dividend

Using an energy submodel as part of the ESRI's HERMES macroeconomic forecasting model, [Bergin et al. \(2004\)](#) estimate the impacts of a €20 carbon tax in Ireland. When carbon tax revenues are used to reduce government debt, or are redistributed to households through lump-sum transfers, GDP and employment decline. However, when recycling carbon tax revenues to reduce VAT, GDP increases with a small decline in employment. Recycling revenues through reduced social-insurance contributions leads to both increased GDP and increased employment.

[Conefrey et al. \(2008\)](#), applying the HERMES model, analyse the effects of a carbon tax on growth and CO₂ emissions over the medium-term in Ireland. Their findings show that a double dividend exists when the revenue from the carbon tax is recycled through reduced income taxes, whereas a double dividend is unlikely if the revenue is recycled via a lump-sum transfer to households. Moreover, they find that a larger incidence of the tax falls on capital, rather than labour. In [Tol et al. \(2008\)](#), again applying the HERMES model, it is found that a recycling scheme via lower income taxes stimulates the economy sufficiently to offset the drag on the economy as a result of higher energy prices induced by a carbon tax. Similar findings are reported when revenue is recycled via a reduction in social insurance contributions.

[Wissema & Dellink \(2007\)](#) construct a static computable general equilibrium (CGE) model with a detailed representation of the Irish tax system to analyse the economic and environmental impacts of different carbon tax scenarios. They find that the 2006 energy-related CO₂ emissions reduction target of 25.8% is met with a carbon tax of €10–15 per tonne of CO₂. There is a consistent but small decrease in welfare across each tax scenario.

The authors use their model again in [Wissema & Dellink \(2010\)](#) to investigate the effects of three different revenue recycling schemes under a given carbon tax scenario. The scenarios considered are a reduction in indirect tax rates (VAT), a reduction in labour tax rates and a reduction in output tax rates. It is found that a weak double dividend exists only under the first scenario, whereby welfare reductions are lower than under a baseline, lump-sum transfer scenario. However, a double dividend for tax rate does not hold under the specification in which Ireland's trading partners implement similar tax policies.

In the context of previous literature on carbon taxation in Ireland, the I3E model provides several methodological advantages. Firstly, compared to previous macroeconomic models, the I3E model includes multiple household types distinguished based on area of residence (urban and rural) and disposable income, which has not been included in a general equilibrium setting for Ireland. Within each area of residence, households are disaggregated into five groups based on their household level disposable incomes. As CGE modelling allows us to work with aggregate representative household groups, the results can be interpreted as *the average impact* for households belonging to these groups. In contrast to the microsimulation modelling (e.g. [Bercholz & Roantree \(2019\)](#), [Tovar Reaños & Lynch \(2019\)](#), and [Callan et al. \(2009\)](#)), which allows researchers to analyse both within and between group distributional impacts, a CGE analysis is amenable only to explore the between-groups distributional impacts. Secondly, in addition to the direct impacts studied in the microsimulation literature, the I3E model can investigate the

indirect impacts of carbon taxation (as in [Tol et al. \(2008\)](#), [Verde & Tol \(2009\)](#)). The direct impact here refers to increased prices of carbon goods, and indirect impacts refer to increases in prices of other goods due to carbon taxation. Thirdly, the I3E model includes not only household consumer behaviour but also producer behaviour, where producers also react to the carbon tax by switching inputs and increasing prices such as in [Wissema & Dellink \(2010\)](#). Fourthly, household income impacts through changes in labour and capital income are included. Fifthly, the ETS sector and price of ETS is directly implemented in the model. Finally, the I3E model is a dynamic multi-annual model, where population and technology growth over time are incorporated, and agents maximise an inter-temporal utility/profit function.

3 The I3E Model

In this section, we provide a short non-technical description of the I3E model. For further details, we refer the reader to the technical document and data document of the model: [de Bruin & Yakut \(2019b\)](#) and [de Bruin & Yakut \(2019a\)](#), respectively.

The I3E model is an intertemporal CGE model, which reproduces the structure of the economy in its entirety, including production sectors, households, and the government, among others. In the model, the nature of all existing economic transactions among diverse economic agents is quantified. According to microeconomic behaviour, producers/consumers maximise their profits/utility given their budget constraints. In other words, a CGE model examines how inputs and outputs flow between production sectors of the economy and result in final goods consumed by households.

The explicit modelling of sectoral inter-linkages makes it possible to investigate the wider economic impacts of a specific shock or policy through the different transmission channels in the economy. Therefore, CGE models have become a standard tool of empirical analysis, and are widely used to analyse the welfare and distributional impacts of policies whose effects may be transmitted through multiple markets. Because of its nature, CGE modelling is significantly useful for policy design and evaluation specifically when policy measures are expected to lead to indirect as well as direct effects, as in the case of energy-related policies. For example, the economic implications of an energy tax in the transport sector can be evaluated for both the transport sector and other sectors through inter-sectoral spillovers.

The I3E model includes energy flows and emissions in addition to the standard monetary flows. Each production sector produces an economic commodity using factors of production (three types of labour and capital), material inputs, and energy inputs. The I3E model explicitly comprises a set of carbon commodities, including peat, coal, natural gas, crude oil, fuel oil, LPG, gasoline, diesel, kerosene, and other petroleum products. Production activities represent the different industries in the Irish economy and produce in the cheapest way possible by using the optimal set of capital, labour, energy and other intermediate inputs based on both relative prices and substitution possibilities. Some of the production activities fall under the EU ETS system, and others do not. In the I3E, we assume that each production sector has a fixed share of non-ETS and ETS emissions. Activities are allotted ETS emissions allowances, and when sectoral emissions exceed these allowances, they will have to purchase additional allowances

at the EU-ETS price, which is an exogenous variable in the I3E model. Unused allowances, on the other hand, can be sold. Production activities directly internalise the cost of ETS in their cost minimisation problems.

When an energy policy is implemented (e.g. an increase in carbon tax) or in case of an external shock (e.g. an increase in international energy prices or ETS price), production sectors will, where possible, substitute energy inputs for other inputs and factors of production and/or decrease the carbon content of their energy inputs by demanding cleaner energy. The I3E model includes 32 distinct production sectors, as shown in Appendix A. Each sector uses a unique mix of energy inputs with differentiated substitution possibilities. The elasticity of substitution values in Table A.1 are chosen to represent heterogeneities across production activities regarding their composition of energy demand, where lower elasticity value means less substitutability. Some sectors are quite flexible in substituting one energy commodity for another, e.g. chemical products and food, beverage and tobacco, whereas some do not have any substitution possibility at all, e.g. petroleum and water transportation. These distinct structures, which are derived from the energy mixes of production activities based on the energy social accounting matrix of Ireland (de Bruin & Yakut, 2019a), allow the I3E model to produce substantially rich and distinguished sectoral results in examining any policy change.

The I3E model includes ten representative household groups (RHGs), five rural and five urban based on income levels. This enables the investigation of the distributional impacts across households based on their income, as well as the differences in impacts for rural and urban households. From the perspective of the household, higher prices of goods with higher carbon content will encourage them to consume less carbon-intensive products, where each RHG has a unique composition of its consumption basket. Furthermore, the I3E model includes three labour types based on skill level (low, medium, high). Each labour type has a market, where the equilibrium wage is determined. This allows for insights into diverse impacts across labour types as well as labour income effects across households, where each RHG has a different composition of labour types. The I3E, however, assumes an exogenous labour supply and does not include unemployment.

The GHG emissions associated with the combustion of each carbon commodity are included in the I3E model as well as the process GHG emissions from the production of cement, ceramics and gypsum (ONM sector). The explicit inclusion of emissions makes it possible to evaluate the emissions reduction associated with a specific policy or to calculate the particular policies needed to reduce emissions to a specified target.

I3E is a dynamic model, which incorporates economic growth over the modelling horizon which runs from 2014 to 2050. Economic growth originates from two sources: the growth of employment driven by population growth and the growth in technology, which is assumed to be labour-augmented. It is assumed that the total population grows at a constant rate and the technology, i.e. the productivity of the labour force, grows at a constant rate. In the current version, the values of population growth and economic growth are retrieved from the medium-run estimates of the macroeconometric forecast model of the ESRI, namely COSMO (COre Structural MOdel for Ireland). The productivity growth of labour is

calculated as residual.

Although the current version of the I3E model includes a detailed representation of household and firm structures and economic interactions across agents, some aspects of the model can be improved upon. Firstly, the sectors covered by the ETS are exempted from the carbon tax. However, the ETS partially covers sectoral emissions of all sectors but the electricity production sector. For instance, if 50% of a sector's total emissions is subject to the ETS, the sector would be affected from increasing carbon tax only by half. This means that the perceived cost of an energy commodity but not its purchaser (retail) price is different across sectors under the ETS. Therefore, the I3E model should distinguish between the purchaser price and the perceived cost of an energy commodity. Secondly, the model comprises neither the renewable energy production sector nor renewable energy commodities. The main reason is the lack of reliable and consistent data regarding the cost and employment structure to disaggregate the electricity production sector into conventional electricity production and renewable sector.

4 Results

In this section, we first give an overview of the various scenarios investigated in this study. The results concerning emissions are then presented in Section 4.2 and the economic impacts on macroeconomic environment, sectors, and households in Section 4.3.

4.1 Scenarios

In this report, 12 scenarios are examined to understand the impact of both a carbon tax increase and a revenue recycling scheme on the Irish economy. The definitions and corresponding abbreviations are provided in Table 1. It is important to note that all scenarios we discuss include only a carbon tax as a climate policy measure. In reality, other climate policies in line with the government's Climate Action Plan commitments such as energy efficiency investments/subsidies are being implemented and/or will be implemented in the future. The first scenario is the business as usual scenario (*BaU*), where it is assumed that carbon tax remains at €20 a tonne and no further policy changes are implemented. The results will be compared in terms of changes compared to business as usual. In all other scenarios, an increase in carbon tax by €10 in 2020 is implemented with subsequent yearly increases of €5, reaching a level of €80 per tonne in 2030. After 2030, it is assumed that the carbon tax remains constant at €80 per tonne in nominal terms. Moreover, the ETS price is kept at €12 a tonne in all scenarios in 2018 and onwards.⁸

In the design of various revenue recycling schemes, the carbon tax revenue received for the current carbon tax level (€20 per tonne) is assumed not to be used in the recycling scheme, but any additional carbon tax revenue is utilised for a specific purpose in each scenario. For instance, in 2030 and onwards, the government will recycle 75% of the total carbon tax collections. Since the government expenditures

⁸ Note that the current ETS price is significantly higher; however, due to the recent volatility of the ETS price, there are no reliable projections, where the EU projected long-term levels are lower than the current level. For this reason we do not implement EU-ETS price changes into the future.

are financed from a pool of revenues, what remains, i.e. 25% of the total carbon tax revenue, can be used either to finance other expenditures or to reduce the public indebtedness. As the expenditure items of the government are endogenously solved within the I3E model, the nature of the experiment determines how the government uses this remaining carbon tax income. For instance, the total value of public demand for commodities is assumed to increase with nominal GDP and transfers to households (both welfare and pension) are indexed to the average wage. If a recycling scheme has higher impacts on the average wage, relative to the other schemes, a larger portion of the government revenue will be used to finance transfers payments to households.

Table 1: Scenarios

Abbreviation	Definition	Carbon Tax in 2030
BaU	Business as usual	€20
NoRcy	No recycling	€80
Lump	Lump sum transfers to households on a per capita basis	€80
Trnf	Transfers to households on social welfare transfer basis	€80
GovCon	Increase in government consumption	€80
CorpTax	Reduction in corporate tax rate	€80
ProdTaxLump	90% of revenue transferred to households on a per capita basis, 10% of revenue used to reduce production tax rate of transportation sector	€80
ProdTaxTrnf	90% of revenue transferred to households on a social welfare basis, 10% of revenue used to reduce production tax rate of transportation sector	€80
SaleTax	Reduction in sales tax rates of selected commodities	€80
WageTax	Reduction in wage tax rate	€80
WageTaxLump	50% of revenue transferred to households on a per capita basis, 50% of revenue used to reduction in wage tax rate	€80
WageTaxTrnf	50% of revenue transferred to households on a social welfare basis, 50% of revenue used to reduction in wage tax rate	€80

In the no recycling (*NoRcy*) scenario, the government uses the additional carbon tax revenue to reduce its foreign debt stock. In the *Lump* scenario, carbon tax revenues are recycled back to households in the form of transfers on a per capita basis, i.e. each person in Ireland will receive the same lump-sum amount. The *Trnf* scenario also examines redistributing carbon tax revenues to households but on a social welfare transfer basis. This means that carbon tax revenues are shared among households based on their existing share in total social welfare receipts. In the government consumption scenario (*GovCon*), the government directs the additional carbon tax revenue to the consumption of commodities. In the corporate tax reduction scenario (*CorpTax*), additional carbon tax revenue is used to reduce corporate tax rate such that the decrease in corporate tax receipts equals the additional, i.e. recycled carbon tax revenue.⁹ The *ProdTaxLump* scenario assumes an indicative 90% of the additional carbon tax revenue is redistributed to households through a per capita lump-sum transfer and 10% is used to reduce the

⁹ Given the already low level of corporate tax in Ireland, this revenue recycling option may not be feasible in reality.

production tax rate of the transportation sector. Similarly, the *ProdTaxTrnf* scenario combines a decrease in transport production tax rate and social welfare based transfers to households. Carbon tax revenue is used to decrease sales tax rates of all commodities except the energy commodities and food, beverage, and tobacco products in the *SaleTax* scenario.¹⁰ Wage tax rates are reduced in the *WageTax* scenario, and the *WageTaxLump* and *WageTaxTrnf* scenarios include a combination of wage tax rates reduction and transfers to households, where 50% of carbon tax revenues are used for each.

4.2 Impacts on Emissions

4.2.1 Total Emissions

Figure 1 presents the total (ETS and non-ETS) economy-wide CO₂ emissions in the business as usual case and including a carbon tax increase with the various revenue recycling schemes.¹¹ As can be seen in the figure, introducing a carbon tax increase will significantly decrease Ireland’s emissions, by approximately 15% in 2030. Furthermore, the recycling scheme will have little impact on the level of emissions. In other words, no matter which of the revenue recycling schemes is applied, similar emissions reduction will be achieved.

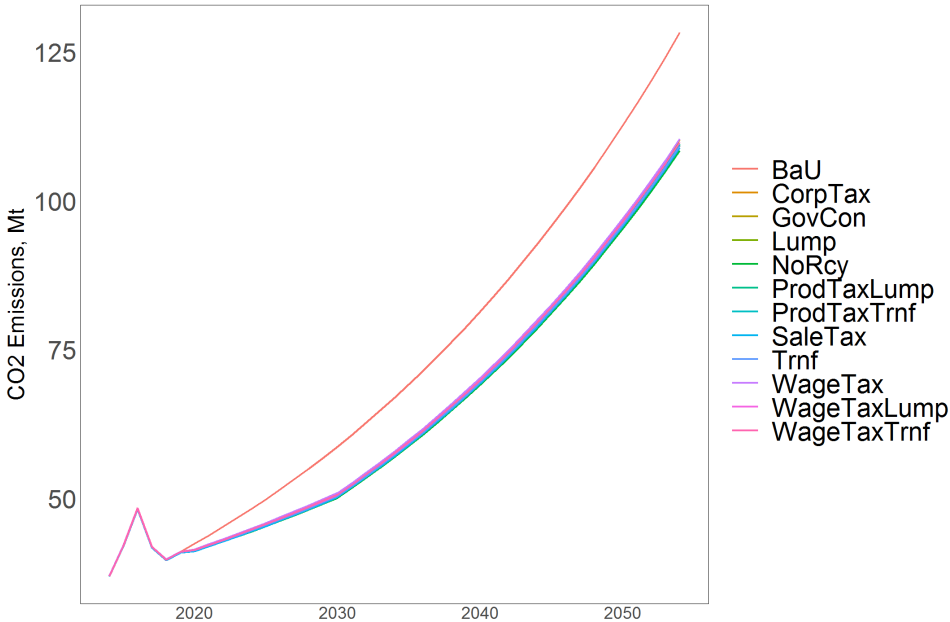

Figure 1: Total Irish fuel combustion emissions with and without a carbon tax increase and various carbon tax revenue recycling schemes

¹⁰ The energy commodities are exempted as the recycling of carbon tax collected from those products to reduce their sales tax rates does not make sense. The food, beverage, and tobacco products are also exempted because the government imposes excise tax on some of these products (alcohol and tobacco) in addition to the sales tax to reduce their demand.

¹¹ Note that this does not include agricultural non-fuel combustion emissions or any other non-fuel combustion emissions with the exception of ETS emissions from the production of cement, ceramics and gypsum (ONM sector).

4.2.2 Non-ETS Emissions

Ireland’s non-ETS emission target for 2020 is a 20% reduction compared to 2005 levels, equivalent to an emission level of 37.7 Mt CO₂. Recent projections suggest that over the period 2013–2020, Ireland’s cumulative emissions will exceed the targets by approximately 17 Mt CO₂ (EPA, 2018). Annual Emissions Allocations and units from the Kyoto Protocol Flexibility Mechanisms carried forward from 2008–2012 can be used to fill this gap partially. Additional permits would need to be purchased to comply with the EU targets. For 2030, the target is a 30% reduction compared to 2005 levels, equivalent to 32.9 Mt CO₂ emissions. Non-ETS emissions consist of non-ETS emissions from combustion as modelled in I3E and agricultural emissions. For illustrative purposes, we display the I3E non-ETS emission results with the EPA projected agricultural emissions in Figure 2. Note that these emissions projections do not include any other climate policy measures such as retrofitting, phasing out of coal and peat in power generation etc., which are included in the EPA projections. As can be seen from the figure, the increase in the carbon tax will bring Ireland closer to its targets, but when *only* a carbon tax increase of this level is applied, Ireland will still fall far short of its targets.

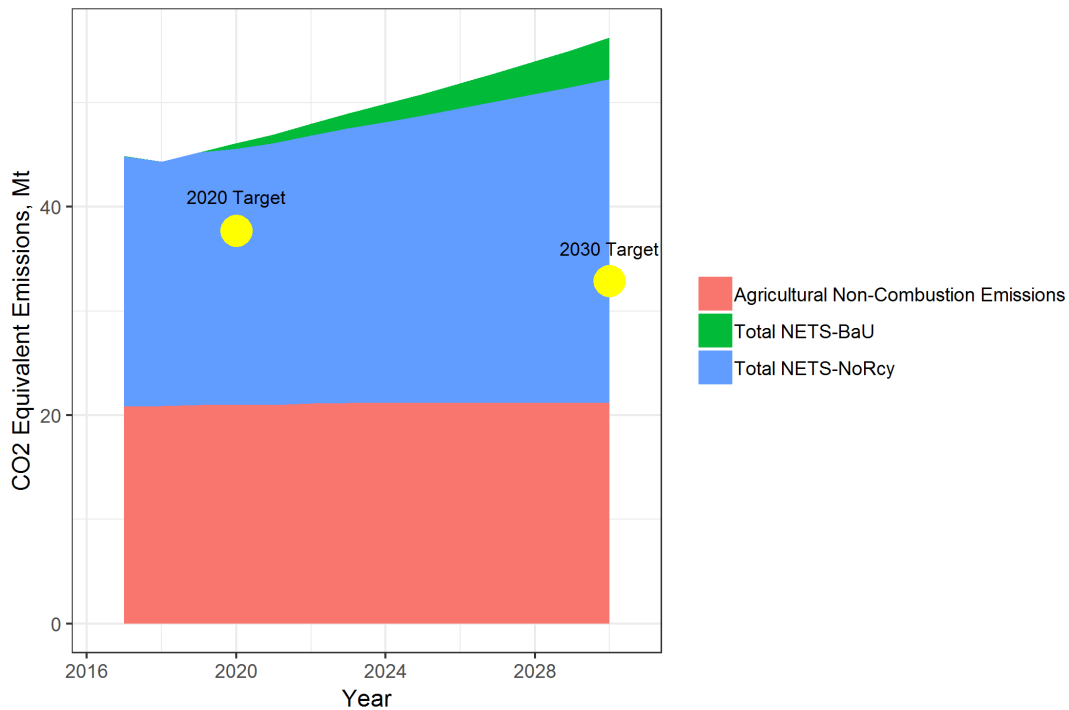

Figure 2: Total Irish non-ETS emissions based on EPA agricultural emissions projections and I3E non-ETS emissions

4.2.3 Household Emissions

Emission levels, measured by the consumption of carbon commodities (i.e. direct emissions), across household types differ. Figure 3a shows the business as usual average annual emissions per household for each household type in 2018. As can be seen from the figure, rural households have significantly higher emissions than urban households. Overall rural households consume more carbon commodities, leading to more emissions per household in rural areas. Rural households consume significantly larger amounts of peat, coal, diesel, LPG, kerosene and other petroleum products for heating than do urban households. Rural households also consume more diesel for transport than do urban households. Urban households consume more gas than do rural households, though differences are moderate.

In both rural and urban areas, richer households consume more carbon commodities and hence create more emissions. A smaller share of household income is spent on most carbon commodities as income rises, with the exception of transport fuels. The second richest rural household (r4) spends the highest share of its income of transport diesel, whereas the poorest spends the lowest share. Middle income urban households (u3) spend the highest share of their income on gasoline and the richest household (u5) group spends the lowest share. The share of household income spent on transport diesel increases with income in urban areas.

Figure 3b presents the emissions reduction per household type in the no recycling scenario in 2030. On average, households reduce emissions by about 10% as compared to *BaU* due to the increase in the carbon tax in 2030. These results are comparable to the estimated 10% emissions reduction for a €100 carbon tax by Tovar Reaños & Lynch (2019). Rural households show higher levels of emissions reductions compared to urban households. It should be noted here that though we consider the differences in consumption patterns between urban and rural households, we assume that they have the same substitution parameters. This means we do not assume that rural households have less ability to switch away from carbon commodities, which in real life could be argued due to, among other factors, the lack of access to public transport and the gas network. Rural households have higher reductions because their consumption patterns result in higher price impacts from the carbon tax increase compared to urban households and hence higher reductions in consumption and associated emissions (see Section 4.3.4). Furthermore, rural households have on average a lower income, making them more sensitive to price changes.

4.2.4 Production Emissions

The I3E model consists of 32 distinct production sectors; however, for the results reporting we aggregate several production sectors. The mining sector (MIN) includes the peat sector (PEA) and other mining (OMN). The Transportation sector (TRP) includes air (ATS), water (WTS) and land transportation (LTS). Manufacturing (MAN) and Services (SER) include the various manufacturing and service sectors, respectively. In the second column of Table 2, the 2018 emissions are presented for each production sector. Manufacturing is responsible for the most emissions, where emissions are almost 11 Mt, concentrated in the other non-metallic minerals (3.2 Mt), Petroleum (1.9 Mt) and Natural Gas Supply (1.8 Mt) sectors.

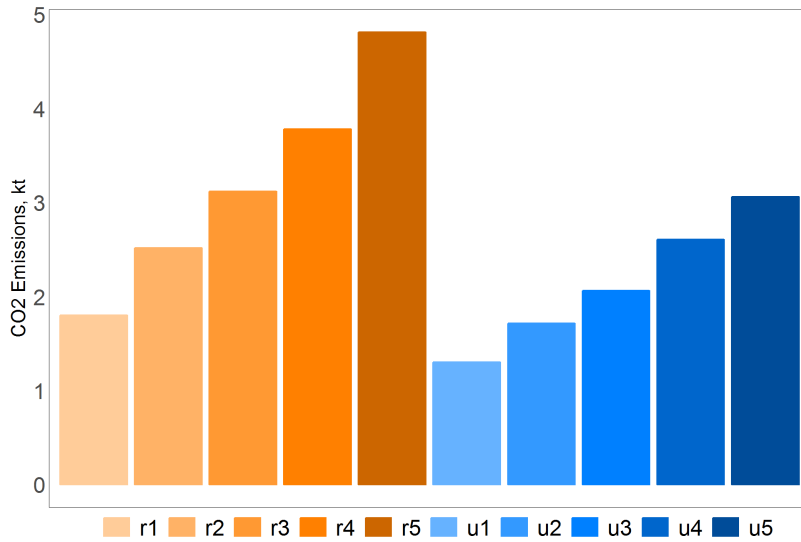

(a) Emissions per household type in 2018

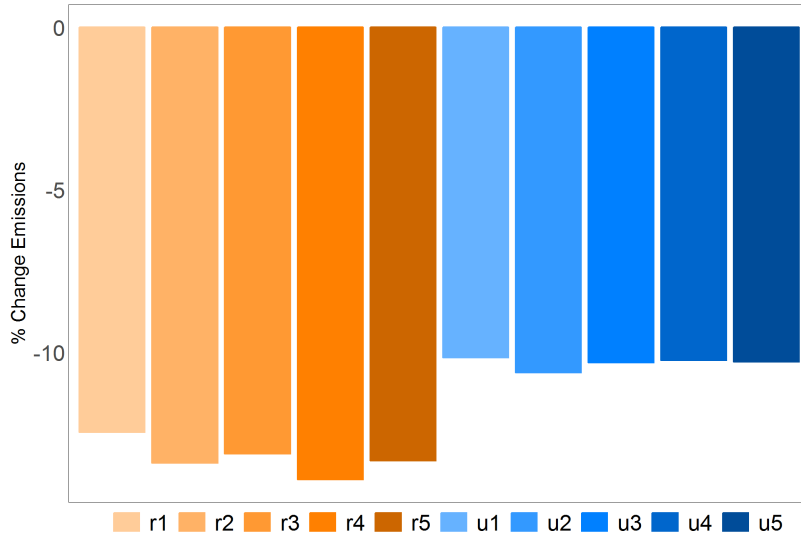

(b) Emissions reduction per household type in 2030

Figure 3: Household Emissions

Transportation has the second highest amount of emissions at almost 10 Mt, where the bulk of emissions result from air transportation. Note, however, that aviation emissions here include all emissions by Irish airlines regardless of where these emissions occur geographically. The electricity sector also produces a large amount of emissions at just over 7 Mt. Emissions divided by value added for each sector are presented in the third column of Table 2. In terms of emissions per unit of value added, the transportation and electricity sectors have particularly high levels. Agriculture, mining and manufacturing have relatively high values, where again the high level in manufacturing is driven by the abovementioned sectors as well as basic metal manufacturing. In the fourth column of Table 2, emissions reductions resulting from

Table 2: Production Emissions

Sector	Total Emissions, in 2018 in Mt	Emissions/Value-Added in 2018, in Mt/billions €	Emissions reduction in 2030*
Accomm. & Hotels	0.26	0.05	18.2
Agriculture	0.87	0.19	22.7
Transportation	9.56	2.03	16.5
Construction	0.33	0.05	19.9
Mining	0.13	0.14	23.1
Electricity	7.32	2.84	14.5
Public Sector	0.38	0.05	18.4
Financial Services	0.2	0.01	13.8
Services	1.38	0.02	16.3
Manufacturing	10.71	0.16	11.2

*: Percentage change in NoRcy compared to BaU.

a carbon tax increase (comparing the business as usual and no recycling scenarios) per sector in 2030 are given. The mining and agriculture sectors show the highest relative levels of emissions reductions at above 20%. This is due to two factors: firstly fuel use in agriculture is dominated by diesel, whose price is impacted the most by a carbon tax increase. Secondly, the relatively high level of substitutability between energy inputs and other inputs in agricultural production makes switching to lower emissions inputs relatively cheap. The mining sector's emission reduction is dominated by the peat sector (with a decrease of 21%). As the carbon tax reduces demand for peat, the peat sector switches to the production of electricity (with renewables). Though the aggregated transport sector shows a 16.5% reduction in emissions on average, examining the subsectors shows very different levels. Land transportation reduces emissions by 26.8% and water transportation by 28.0%, whereas for air transportation, where the bulk of emissions fall under ETS, reductions are lower at 15%.

4.3 Economic Impacts

4.3.1 Macro-level impacts

The macroeconomic effects of a carbon tax depend strongly on how the carbon tax revenue is used, i.e. which revenue recycling scheme is applied. Note again that the first €20 of carbon tax per tonne is not used in the revenue recycling schemes, but only the additional carbon tax above €20. In 2020, for example, the carbon tax is assumed to be €30 per tonne, of which only €10 per tonne is used in the revenue recycling scheme. This reflects the current situation, where the carbon revenues from the current €20 tax have not been designated for a specific purpose. In this section, we discuss the main macroeconomic effects of the various revenue recycling schemes.

Figure 4a shows the changes in real GDP as compared to the *BaU* case for the various recycling schemes and the no recycling case. Regardless of the recycling scheme, a carbon tax will result in a

small decline in real GDP compared to the business as usual scenario. Note, however, that real GDP over time in all scenarios increases significantly, where the presented declines in real GDP should be seen as foregone additional increases in GDP. The choice of recycling scheme can significantly decrease the impacts on real GDP. The no recycling scenario, where revenues are used to decrease government debt, leads to the highest decrease in real GDP with a slightly higher than 0.6% decline in 2030. In this case, due to the increased carbon tax, higher prices reduce both domestic and foreign demand for Irish goods and thus contract the economy. Transferring carbon tax revenues to households (*Trnrf* and *Lump*), increasing government consumption (*GovCon*) or reducing the transportation production tax rate in combination with transfers to households (*ProdTaxLump* and *ProdTaxTrnrf*) also lead to relatively significant decreases in real GDP, relative to the *BaU* scenario, of approximately 0.4% in 2030. Transfers to households result in higher household income, which partially counteracts the decrease in demand of households due to increased prices resulting in lower GDP impacts as compared to the no recycling case. Increased government consumption also partially counteracts the decrease in demand, resulting in lower GDP decreases compared to no recycling.

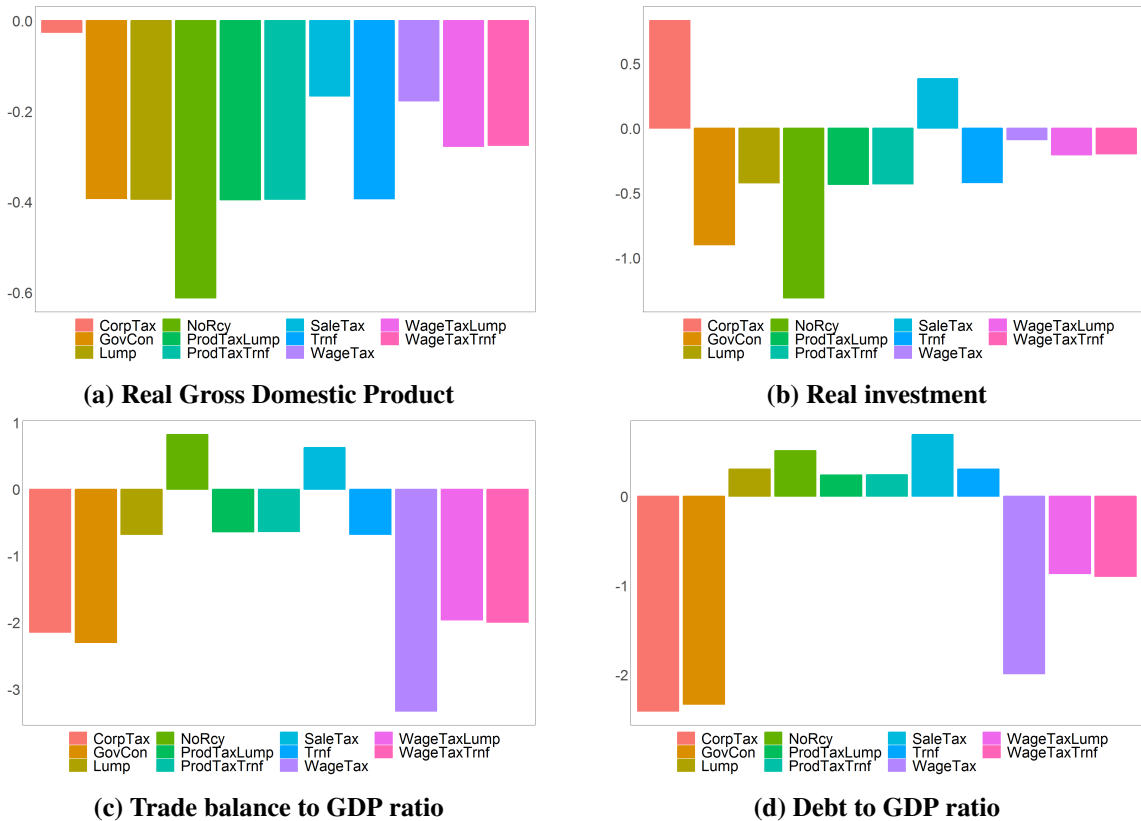

Figure 4: Macroeconomic variables, percentage change compared to BaU in 2030

When carbon tax revenues are used to decrease other distortionary taxes in the economy, a so-called weak double dividend can be achieved, where the carbon tax reduces emissions but at a lower cost to eco-

economic growth than without recycling. Reducing wage tax rates or sale tax rates of selected commodities lessens real GDP impacts to approximately a 0.2% decrease in real GDP in 2030. In the case of a sales tax reduction, prices increases are limited due to the reduced tax on goods, which in turn limits the decrease in demand and hence decrease in economic activity. When wage taxes are reduced, this leads to higher income for households, which in turn boosts demand. Note that given the exogenous supply of labour in the model, wage tax decreases will not lead to increased supply of labour, but do result in decreases in labour costs to production sectors. When a wage tax reduction is combined with transfers to households (*WageTaxLump* and *WageTaxTrnf*), real GDP impacts are smaller than in the case of a transfer alone but larger than when only wage taxes are reduced. Reducing the corporate tax rate (*CorpTax*) leads to the smallest impacts on real GDP with a decrease of less than 0.05%. This is because the level of corporate tax rate plays a crucial role in the investment decision of the majority (27 out of 32) of activities, which determine their level of investment by intertemporally maximising the value of firms. Reduced corporate tax rate leads to increased investment and boosts production. The changes in real investment are shown in Figure 4b. In most recycling scenarios, real investment decreases, where the most substantial decrease is in the no recycling scenario. In the sales tax and corporate tax scenarios, real investments increase as lower sales tax rates reduce the negative impacts on the demand components, and activities increase their demand for factors of production.

The impacts on the trade balance are shown in Figure 4c. An increase in carbon tax increases the price of domestic goods, decreasing domestic demand and invoking demand for foreign goods. The carbon tax, however, is also levied on imported carbon commodities, resulting in significant decreases of carbon imports. The decrease in real GDP further decreases imports. In the no recycling case, decreased imports outweigh decreased domestic consumption and exports, resulting in an increase in the trade balance. In the case of a reduction in sales tax rates, domestic goods become relatively cheap, which boosts domestic demand and also results in an increase in the trade balance. For the other scenarios, the decrease in domestic demand outweighs the decrease in imports as the real GDP reductions are limited, resulting in a decrease in the trade balance. A lower sales tax rate results in small impacts on the trade balance, where the decrease in sales tax rates counteracts the increase in carbon tax.

Figure 4d displays the change in the debt-to-GDP ratio with respect to the business as usual scenario. For the reductions in corporate tax rate and wage tax rates and increasing government consumption scenarios, the debt-to-GDP ratio decreases significantly. In the case of no recycling, decreased economic activity decreases the government tax collections and hence revenues. Therefore, even given that the carbon tax revenues are used to decrease foreign debt stock, the debt-to-GDP ratio increases due to decreased government revenues and GDP.

4.3.2 Sector level impacts

An increase in the carbon tax has varying impacts across production sectors in the economy. Furthermore, the choice of recycling scheme can have significant impacts on sectors. Figure 5 presents the changes

in value-added per sector for each recycling scenario. The most impacted sectors are unsurprisingly transportation, mining, and electricity production sectors, which are negatively affected regardless of the recycling scheme. Increasing the carbon tax lowers the demand for commodities produced by these activities more relative to the other commodities, and the recycling scheme can only reduce the magnitude of the impact. For each of these sectors, different recycling schemes result in better outcomes. For the electricity and mining sectors, for instance, a reduction in corporate tax rate results in the lowest value-added reduction. Wage tax rates reduction, however, results in an only slightly higher reduction in value-added in these sectors as households reap a large share of these benefits through increased wages. The public sector has the most varying impacts. For example, in the government consumption scenario, value-added increases by almost 2%, whereas in the wage tax rates reduction scenario, value-added decreases by over 1%. An increase in government spending naturally increases the demand for commodities produced by the public sector, and its associated value-added. For the transport sector, a reduction in production tax rates significantly decreases the reduction in value-added as would be expected. It is interesting to note that though the reduced production tax rates limit economic impacts for the transportation sector, emissions reductions are not jeopardised as carbon is still taxed. Production sectors that benefit from the carbon tax increase are those sectors that produce goods/services with a low carbon content. These sectors are often labour intensive. The accommodation sector has the highest increase in value-added and shows increased value-added for all scenarios.

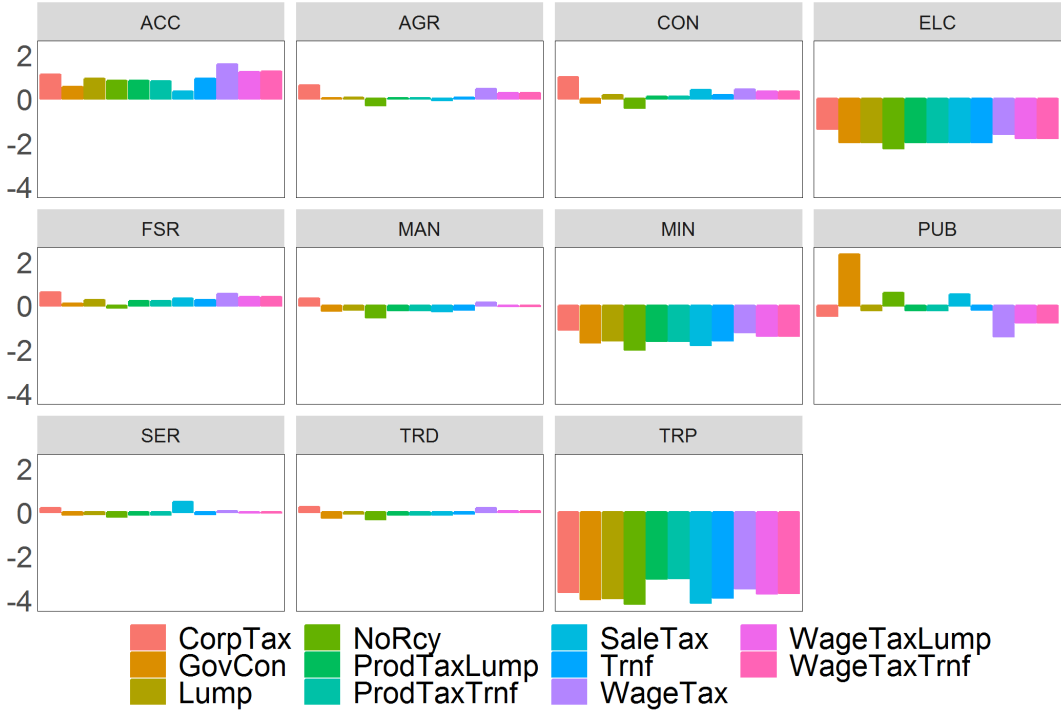

Figure 5: Percentage change in sectoral value added in the NoRcy scenario compared to BaU

4.3.3 Price impacts

An increase in the carbon tax raises the price of carbon commodities, but also increases other prices, as production costs of other goods rise due to the increase in carbon input prices. In Figure 6a, the increase in energy CPI is given for the various scenarios.¹² Compared to business as usual, energy prices increase significantly. The impacts also differ depending on the recycling scheme applied, but these differences are relatively small.

Non-energy CPI, which represents the price impacts of a carbon tax on non-carbon goods, is impacted to a far lesser degree than energy CPI. The choice of recycling scheme influences the price setting in the model, resulting in significant differences amongst recycling schemes in non-energy CPI, as shown in Figure 6b. As prices rise, the demand for goods decreases, putting downward pressure on the price and limiting further price increases. When a recycling scheme stimulates GDP or consumption, the decrease in demand becomes lower, resulting in higher prices. Consequently, no recycling leads to the lowest increase in prices as it has the highest adverse impacts on GDP. Corporate tax rate reduction results in similar price levels, where the economy is stimulated, but production costs are reduced due to the tax cut. Transfers increase prices compared to no recycling as they increase household income, which in turn drives up household consumption and hence prices. Increasing government consumption and reducing wage tax rate scenarios have the highest impacts on prices. For the former, increased government consumption increases demand, further driving up prices. Similarly, for the latter, decreased wage tax rates increase private consumption, which in turn drives up demand and prices. Figure 6c presents overall CPI, where differences across recycling schemes are similar to the non-energy case but more pronounced.

4.3.4 Households impacts

Comparing price impacts across households, Figure 7a presents the change in the price of composite consumption for each household type in the experiment of *NoRcy* compared to *BaU*. Households consist of five rural households (r1 to r5) where r1 is the poorest and r5 is the richest, and five urban households (u1 to u5) where u1 is the poorest and u5 is the richest. The figure shows that rural households face significantly higher price increases than do urban households. Price impacts are regressive in rural households, where the poorest households face the highest price increases as the share of carbon commodities in their total consumption is highest. For urban households, we do not see a regressive trend, but rather that the middle-income urban households are hit the hardest. This is due to the high share of transport fuels in the total consumption of these households. Though the level of household price impacts changes across recycling scenarios, as was shown in Figure 6c, the relative impacts across households do not differ much across scenarios. For this reason we do not display household level price or consumption impacts across all scenarios.

¹² In the calculation of these indices, the weights of commodities within each CPI definition are calculated endogenously; as the price of a commodity increases, its private demand and thus weight in the CPI decrease.

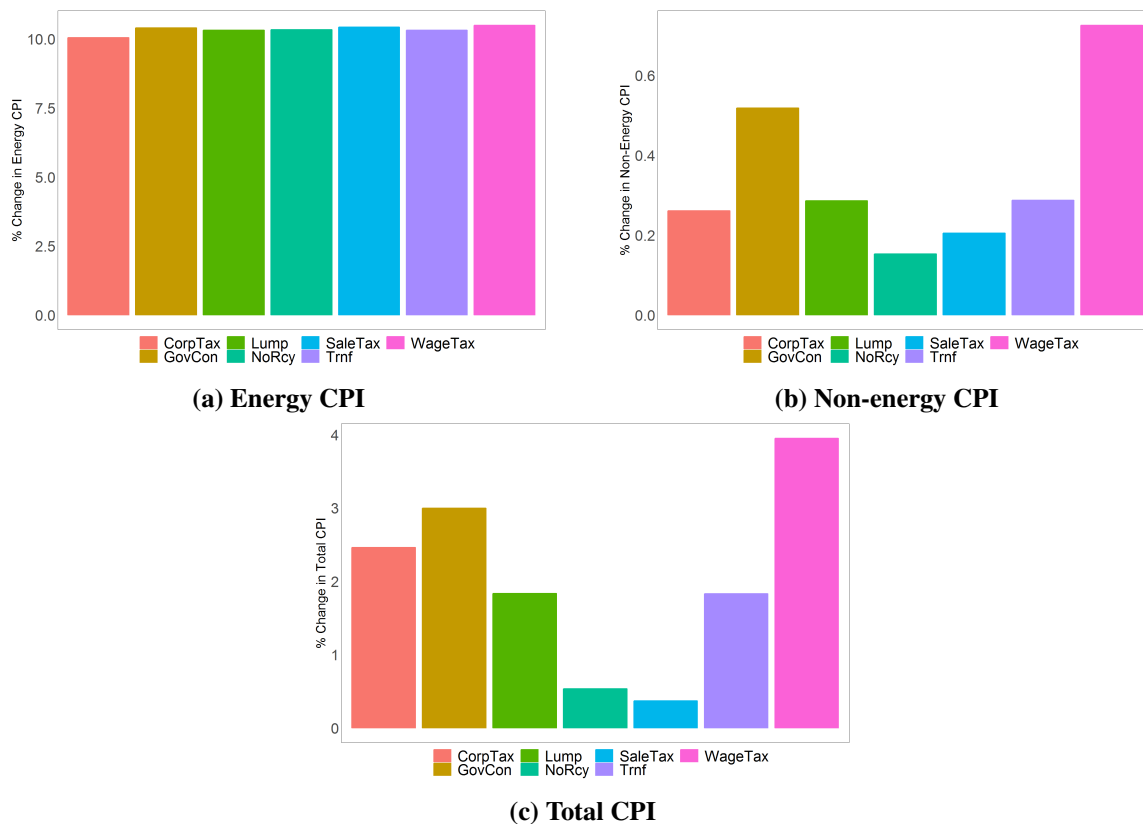
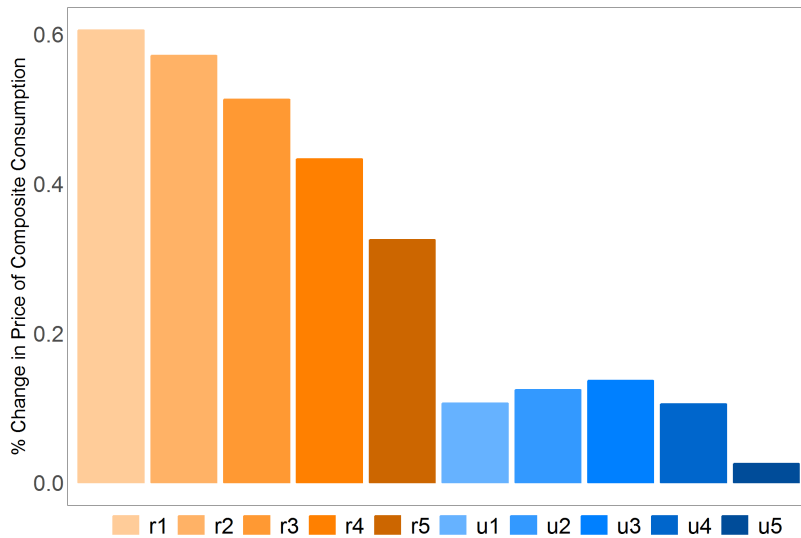

Figure 6: Economy-wide price impacts, percentage change in 2030 compared to BaU

Figure 7b shows the impact on total composite consumption per household type. In response to the price increase, households will reduce their consumption. There is again a regressive trend for the rural household whereby the poorest rural household decreases its consumption the most. Urban households decrease their consumption to a lesser degree and middle-income households display the most substantial decrease.

Though household consumption decreases, this does not necessarily mean that household income decreases. Due to higher prices, households choose to consume less and save more with the same amount of income and even with higher levels of income. In Figure 8, changes in real disposable income across households in 2030 compared to business as usual are depicted. The estimated changes in real income across households differ considerably across recycling schemes. In the no recycling case, all households face a decrease in real disposable income. The richest urban households face the most considerable impacts, but differences between households are relatively small.

Recycling revenues to government consumption has similar impacts to no recycling but the impacts are lower. Using carbon tax revenues to decrease sales tax rates of selected commodities results in increases in real disposable income for all households, though impacts differ significantly across households. Recycling revenues to decrease the corporate tax rate generates higher increases in real disposable



(a) Price of composite consumption by household type

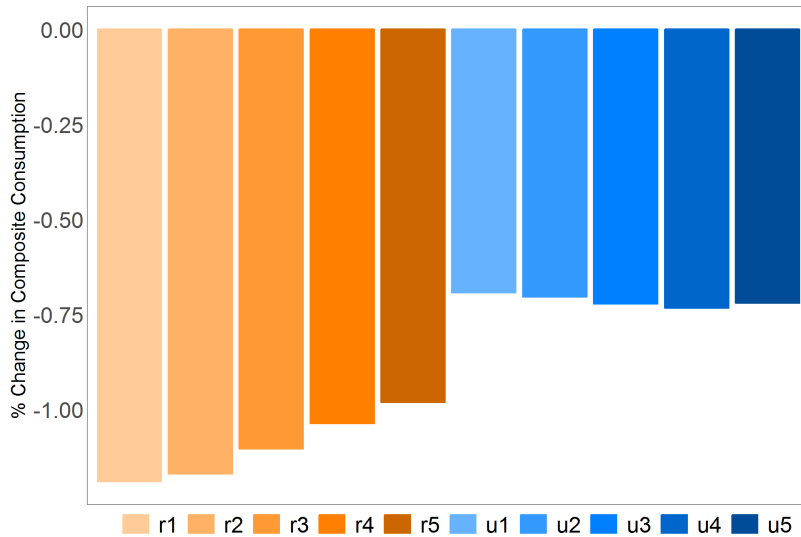

(b) Level of composite consumption by household type

Figure 7: Households impacts, percentage change in 2030 in NoRcy scenario compared to BaU

income across all households. Using carbon tax revenues to reduce wage tax rates has the largest average positive impacts on real disposable income, but displays highly regressive effects whereby richer households benefit significantly more than poorer households. Combining wage tax rate reductions with transfers produces, on average, lower increases in real disposable income across households, and reduces but does not illuminate the regressiveness of the carbon tax as compared to recycling revenues to reduce wage tax rates alone.

Recycling carbon tax revenues back to households in the form of a transfer (social welfare-based or per capita based) results in increases in real disposable income for most households. Furthermore,

comparing impacts across households, a highly progressive trend is observed where poorer households' income increases more than richer; in fact, the richest households face a decrease in real disposable income. Comparing transfers types, it is evident that lump-sum transfers benefit rural households more and social welfare based transfers benefit urban households more.

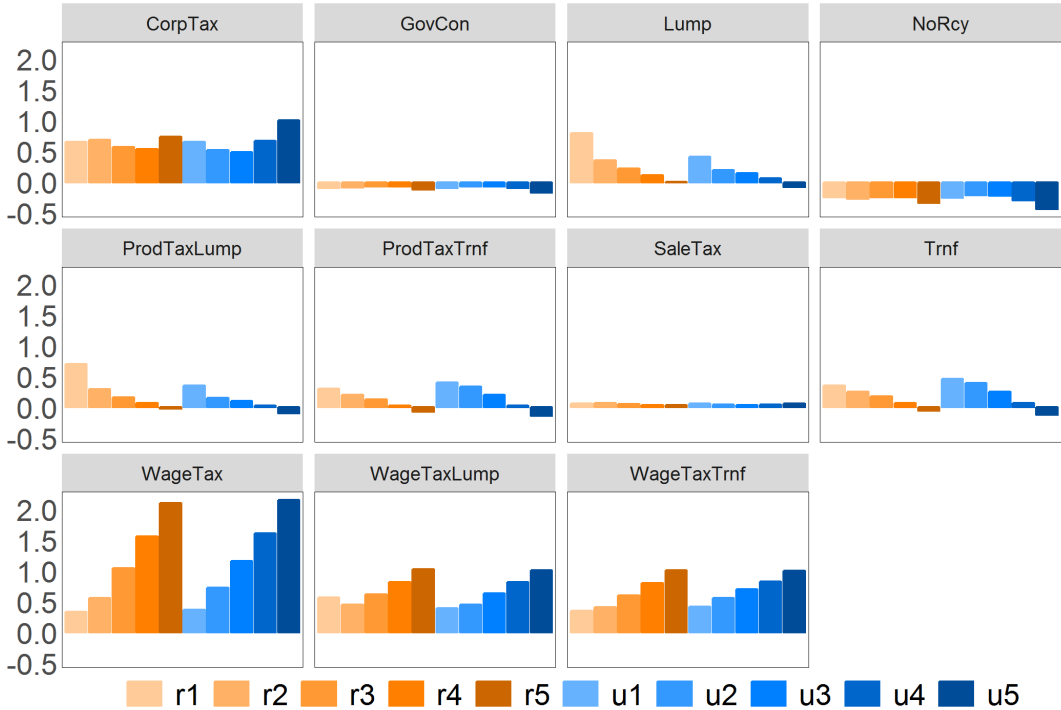

Figure 8: Changes in real disposable income as compared to business as usual per household type in 2030

5 Conclusion

This report examines the environmental and economic impact of increasing the Irish carbon tax along a trajectory reaching €80 by 2030 using various revenue recycling schemes. Concerning emissions reductions, our results show that a carbon tax increase of this magnitude alone will not be sufficient to reduce emissions to the levels needed to reach the EU emissions targets for 2020 and 2030. Although the increase in carbon tax decreases emissions by 15% in 2030 compared to no increase in carbon tax, the impacts of economic growth outweigh this, resulting in significant increases in emissions over time. Concerning emissions reductions at a household level, though rural households emit less than urban households, a carbon tax increase will result in higher emissions reduction by rural households than by urban households.

From an economic perspective, an increase in the carbon tax will have limited impacts on GDP, especially if carbon tax revenues are used to reduce other distortionary taxes. Overall the carbon tax will

result in higher prices of Irish goods, decreasing both domestic and foreign demand for Irish goods. This results in a decrease in the trade balance. However, in some cases the decrease in demand for foreign carbon goods outweighs the decreased domestic demand, resulting in an increase in the trade balance. The sectors hit the hardest by the carbon tax are the transport, mining and electricity sectors. As demand shifts from carbon intensive goods to other goods, several sectors benefit from the carbon tax increase.

Impacts on households vary depending on how carbon tax revenues are used. Rural households face higher price impacts than urban households. Impacts for rural households are regressive, where poorer households face the highest price increases. Middle income urban households face the highest impacts. In reaction to price increases, households decrease consumption where again the poorer rural households are impacted the most. Though consumption decreases, real disposable income of households generally increases when revenues are recycled. Recycling revenues back to households through transfers benefits particularly poorer households, creating a progressive trend. Though recycling revenue through wage tax reduction results in the highest average increase in real income, the impacts are regressive.

In conclusion, we find that an increase in the carbon tax as proposed by the recent all Government Climate Action Plan will on its own reduce emissions, but not ensure that the EU targets are met. Furthermore, the economic impacts of an increased carbon tax are limited. Designing an appropriate carbon tax revenue recycling scheme can help the government reduce the economic impacts of the carbon tax and/or decrease the inequality across households.

Appendix A Lists of Activities and Commodities

Table A.1: Activities

Abbreviation	Name	NACE Codes	σ_{BEN}	σ_{FUE}	σ_{BH}	σ_{OTE}
ACC	Accommodation and Hotel Services	55–56,79	1.5	0	0	
AGR	Agriculture	1–3	1.5	0	0	
ATS	Air Transportation	51	0	1.3	1.3	
BFM	Basic Metal Manufacturing	24–25	1.5	1.3	1.3	
BPP	Basic Pharmaceutical Products	21	1.5	0	0	
CHE	Chemical Products	20	1.5	1.5	1.5	
CON	Construction	41–43	1.5	0	1.5	
EDU	Education Sector	85	1.5	1.3	1.5	
FBT	Food, Beverage and Tobacco	10–12	1.5	1.5	1.5	
FSR	Financial Services	64–66,77	1.5	0	0	
HHS	Health Sector	86–88	1.5	1.3	1.3	
HTP	High-Technology Products	26–28	1.5	1.5	1.5	
LTS	Land Transportation	49	1.3	0	1.3	
NGS	Natural Gas Supply		0	1.3	0	
OIN	Other Industrial Products	17,18,33	1.5	1.5	1.3	
OMN	Other Mining Products		1.5	1.3	1.5	
ONM	Other Non-metallic Products	23	1.5	1.3	1.5	
OTM	Other Manufacturing	31–32	1.3	1.5	0	
PEA	Peat		1.5	1.3	1.5	
PET	Petroleum		0	0	0	
PUB	Public Sector	84	1.5	1.3	1.5	
RES	Real Estate Services	68	1.5	0	0	
RUP	Rubber and Plastic Products	22	1.5	1.5	1.3	
SER	Other Services	remaining*	1.5	0	0	
TEL	Telecommunication Services	61	1.5	0	0	
TEX	Textile	13–15	1.5	1.5	1.3	
TRD	Trade	45–47	1.5	1.5	0	
TRE	Transportation Equipment	29–30	1.5	1.5	0	
WAT	Water and Sewerage	36–39	1.5	1.5	1.3	
WTS	Water Transportation	50	0	0	0	
WWP	Wood and Wood Products	16	1.5	1.3	0	
ELC	Electricity		1.2			1.5

*: It excludes NACE codes 5–9 (Mining, Quarrying and Extraction), 19 (Petroleum Products), and 35 (Electricity and Gas Supply).

Note: The activities without NACE codes are further disaggregated sectors. σ_{BEN} , σ_{FUE} , σ_{BH} , and σ_{OTE} stand for elasticity of substitution for business energy, fuel, business heating, and other energy, respectively. For the commodities included in each bundle, see Figures 10 and 11.

Table A.2: Commodities

AGR	Agriculture	BFM	Basic Metal Manufacturing
PEA	Peat	HTP	High-Tech Products
COA	Coal	TRE	Transportation Equipment
CRO*	Crude Oil	ELC	Electricity
OMN*	Other Mining Products	NGS	Natural Gas Supply
FBT	Food, Beverage and Tobacco	WAT	Water and Sewerage
TEX	Textile	CON	Construction
WWP	Wood and Wood Products	TRD	Trade
OIN	Other Industrial Products	LTS	Land Transportation
GAL	Gasoline	WTS	Water Transportation
KRS	Kerosene	ATS	Air Transportation
FUO	Fuel-oil	ACC	Accommodation and Hotel Services
LPG	Liquid Petroleum Gas	TEL	Telecommunication Services
DIE	Diesel	FSR	Financial Services
OPP	Other Petroleum Products	RES	Real Estate Services
OTM	Other Manufacturing	PUB	Public Sector
CHE	Chemical Products	EDU	Education Sector
BPP	Basic Pharmaceutical Products	HHS	Health Sector
RUP	Rubber and Plastic Products	SER	Other Services
ONM	Other Non-metallic Products		

*: not subject to private consumption

Appendix B Nested Structure of Consumption

Household composite consumption, CC , is assumed to be a CES aggregate of composite commodities of Transportation (TRP), Residential Energy (REN), Nourishment (NTR), Services (SER), and other commodities (OTC). As described above, this reflects that different goods relating to e.g. Services are easier to substitute with each other than for example substituting services with nourishment. The logic here is that consumers are more likely to e.g. substitute food products with agricultural products if prices of food products increase than to increase their consumption of services as food prices increase.

The composite commodity TRP is a Leontief aggregate of land, air, and water transportation commodities where the land transportation (LND) is also a Leontief aggregate of public and private transportation commodities. The choice of a Leontief relationship here is substantial to reflect the low level of substitutability between transport types; a consumer will not substitute their daily car commute with air or water transport due to alterations in petrol prices. It should be noted that the original land transportation commodity (LTS with NACE Code 49) covers the public transportation demand of households. Since

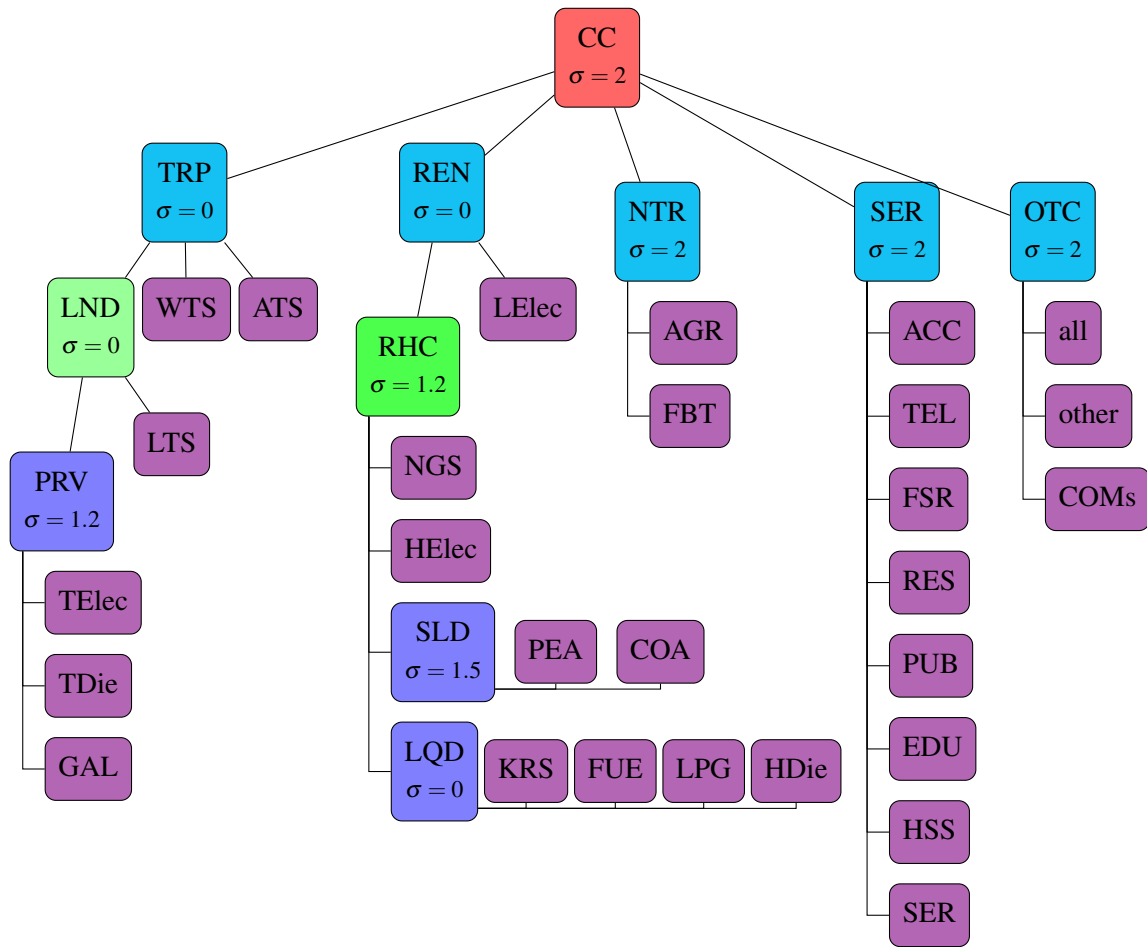

Figure 9: Nested Structure of Consumption

households demand some of the energy commodities including gasoline, diesel, and electricity for private transportation purposes, the composite commodity *LND* is assumed to be a Leontief aggregate of those energy commodities.¹³ The *REN* is disaggregated into lighting electricity and residential heating, which is further disaggregated into natural gas supply, solid fuel, heating electricity, and liquid fuel. Moreover, solid (liquid) fuel is a CES (Leontief) aggregate of peat and coal (kerosene, fuel-oil, liquid petroleum gas, and diesel for heating purposes). The total electricity consumption of households, the commodity *ELC*, is known from the SAM, and it is disaggregated into electricity demand by transportation, lighting, and heating purposes by using the data provided by [SEAI \(2013\)](#). Similarly, total private consumption of diesel is disaggregated into diesel demand for transportation and heating by using the energy balances. The composite commodity *NTR* is a CES aggregate of the commodities agriculture and food, beverage, and tobacco while the composite commodity *SER* is a CES aggregate of several service commodities.

¹³ According to the energy balances, the private consumption of liquid petroleum gas is devoted both to private transportation and to residential heating. Since the former is a quite tiny portion of the total demand, it is assumed to be zero and liquid petroleum gas is assumed to be a part of the residential heating demand.

The composite commodity *OTC* is a CES aggregate of all remaining commodities that are demanded by households.

Appendix C Nested Structure of Production

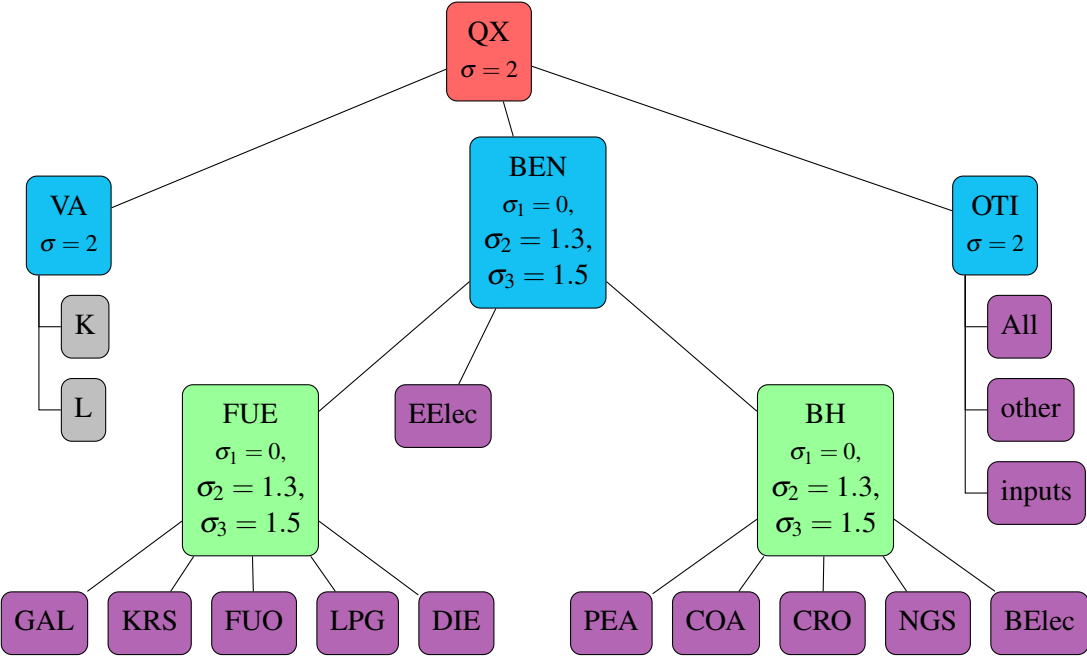

Figure 10: Nested Structure of Production, except Electricity Production

The activities are assumed to produce a composite product *QX* which is an aggregate of value added (*VA*), business energy (*BEN*), and other inputs (*OTI*). The value added is a CES aggregate of factors of production which are capital and labour, and the commodity *OTI* is an aggregate of all intermediate inputs except the energy commodities. For all activities, except the electricity production, the commodity *BEN* is assumed to be an aggregate of energy electricity, fuel (*FUE*) and business heating (*BH*). The composite commodity *BH* is an aggregate of liquid and solid fuels including coal, peat, crude oil, natural gas supply, and business electricity for heating purposes. On the other hand, the composite commodity *FUE* is an aggregate of gasoline, kerosene, fuel oil, liquid petroleum gas, and diesel. The electricity demand of activities, except the electricity production, is disaggregated across demands for energy purposes and heating/combustion purposes.¹⁴ The nested structure of production of all activities except electricity production is depicted by Figure 10.

The electricity production activity solely represents another group of activities concerning its production technology and energy demand composition. The activity’s business energy, *BEN*, is assumed to be

¹⁴ At this stage, the disaggregation is done by arbitrarily assuming that 40% (60%) of the total sectoral electricity is used for heating/combustion (energy) purpose.

a CES aggregate of electricity, natural gas, and other energy (*OTE*) which is also a CES aggregate of all remaining energy commodities (Figure 11). The value of σ is 1.1 for the commodity of *BEN* while it is 1.3 for the *OTE* because the electricity production is more flexible in using the liquid and solid fuels than using natural gas and electricity's itself.

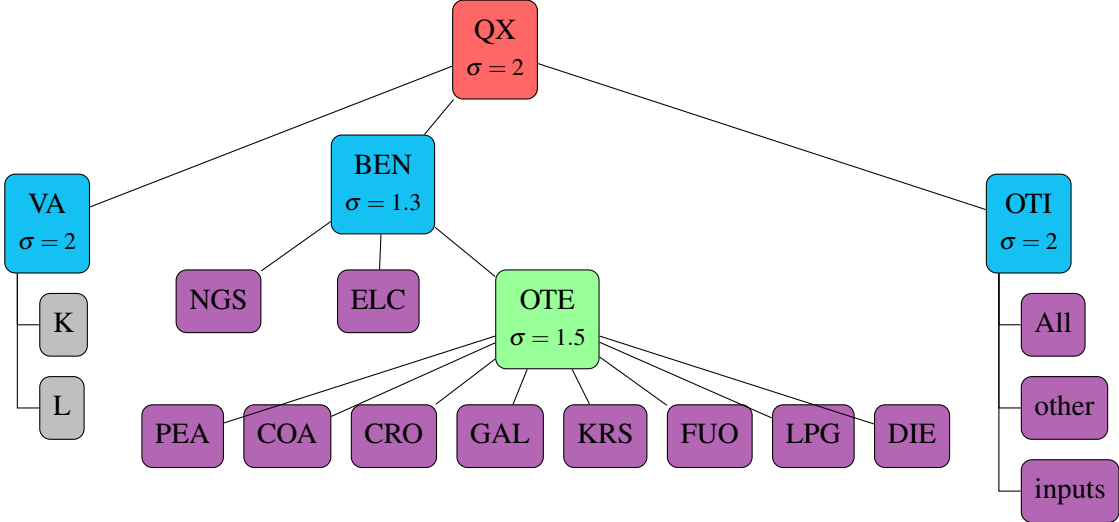

Figure 11: Nested Structure of Electricity Production

6 References

References

Bercholz, M., & Roantree, B. (2019). *Carbon Taxes and Compensation Schemes* (ESRI Budget Perspectives). The Economic and Social Research Institute. <https://www.esri.ie/system/files/publications/BP202001.pdf>. doi: 10.26504/bp202001

Bergin, A., FitzGerald, J., & Kearney, I. (2004). *The Macro-Economic Effects of Using Fiscal Instruments to Reduce Greenhouse Gas Emissions* (Tech. Rep.). The Economic and Social Research Institute (ESRI). <https://www.esri.ie/publications/the-macro-economic-effects-of-using-fiscal-instruments-to-reduce-greenhouse-gas-emissions-2001-eeep-ds8-m1-final-report-prepared-for-the-environmental-protection-agency/>.

Callan, T., Lyons, S., Scott, S., Tol, R. S., & Verde, S. (2009). The Distributional Implications of a Carbon Tax in Ireland. *Energy Policy*, 37, 407-12.

Conefrey, T., FitzGerald, J. D., Valeri, L. M., & Tol, R. S. J. (2008). *The Impact of a Carbon Tax on Economic Growth and Carbon Dioxide Emissions in Ireland* (ESRI Working Paper No. 251). The Economic and Social Research Institute.

- de Bruin, K. C., & Yakut, A. M. (2019a). *Construction of the Energy Social Accounting Matrix for Ireland* (ESRI Survey and Statistical Report Series No. 78). The Economic and Social Research Institute (ESRI). doi: 10.26504/sustat78
- de Bruin, K. C., & Yakut, A. M. (2019b). *Technical Documentation of I3E Model, Version 2* (ESRI Survey and Statistical Report Series No. 77). The Economic and Social Research Institute (ESRI). doi: 10.26504/sustat77
- Desmond, M., O'Brien, P., & McGovern, F. (2017). *A Summary of the State of Knowledge on Climate Change Impacts for Ireland* (Tech. Rep. No. 223). Environmental Protection Agency (EPA). <http://www.epa.ie/pubs/reports/research/climate/EPA%20RR%20223.web.pdf>.
- Ekins, P., Pollitt, H., Barton, J., & Blobel, D. (2011). The Implications for Households of Environmental Tax Reform (ETR) in Europe. *Ecological Economics*, 70, 2472–85.
- EPA. (2018). *Ireland's Greenhouse Gas Emissions Projections 2017-2035* (Tech. Rep.). Environmental Protection Agency (EPA). <http://www.epa.ie/pubs/reports/research/climate/EPA%20RR%20223.web.pdf>.
- FitzGerald, J., & McCoy, D. (1992). *The Economic Effects of Carbon Taxes*. The Economic and Social Research Institute.
- Flues, F., & Thomas, A. (2015). *The Distributional Effects of Energy Taxes* (OECD Taxation Working Papers No. 23). OECD. doi: <https://doi.org/10.1787/5js1qwkqrbv-en>
- IPCC. (2014). *Climate Change 2014: Synthesis Report. Contribution of Working Groups I, II and III to the Fifth Assessment Report of the Intergovernmental Panel on Climate Change* (R. K. Pachauri & L. A. Meyer, Eds.). Intergovernmental Panel on Climate Change, Geneva, Switzerland.
- O'Donoghue, C. (1997). *Carbon Dioxide, Energy Taxes and Household Income* (Working Paper No. 90). The Economic and Social Research Institute (ESRI).
- Scott, S. (1992). Theoretical Considerations and Estimates of the Effects on Households. In J. Fitzgerald & D. McCoy (Eds.), *The Economic Effects of Carbon Taxes*.
- Scott, S., Lyons, S., Keane, C., McCarthy, D., & Tol, R. S. (2008). *Fuel Poverty in Ireland: Extent, Affected Groups and Policy Issues* (Working Paper No. 262). ESRI.
- Sustainable Energy Authority of Ireland. (2013). *Energy in the Residential Sector* (Tech. Rep.). <https://www.seai.ie/resources/publications/Energy-in-the-Residential-Sector-2013.pdf>.
- Tol, R. S. J., Callan, T., Conefrey, T., FitzGerald, J. D., Lyons, S., Valeri, L. M., & Scott, S. (2008). *A Carbon Tax for Ireland* (ESRI Working Paper No. 246). The Economic and Social Research Institute.

- Tovar Reaños, M., & Lynch, M. (2019). *Carbon Taxation in Ireland: Distributional Effects of Revenue Recycling Policies* (ESRI Quarterly Economic Commentary (QEC) Special Article). The Economic and Social Research Institute. https://www.esri.ie/system/files/publications/QEC2019SUM_SA_Lynch.pdf.
- Verde, S. F., & Tol, R. S. J. (2009). The Distributional Impact of a Carbon Tax in Ireland. *The Economic and Social Review*, 40(3), 317-338.
- Wissema, W., & Dellink, R. (2007). AGE Analysis of the Impact of a Carbon Energy Tax on the Irish Economy. *Ecological Economics*, 61(4), 671-683. doi: 10.1016/j.ecolecon.2006.07.034
- Wissema, W., & Dellink, R. (2010). AGE Assessment of Interactions Between Climate Change Policy Instruments and Pre-existing Taxes: The Case of Ireland. *International Journal of Global Environmental Issues*, 10(1-2), 46-62.

Whitaker Square,
Sir John Rogerson's Quay,
Dublin 2
Telephone **+353 1 863 2000**
Email **admin@esri.ie**
Web **www.esri.ie**
Twitter **@ESRIDublin**
ISBN **978-0-7070-0506-5**