

Brändle, Gregor; Schönfisch, Max; Schulte, Simon

Working Paper

Estimating long-term global supply costs for low-carbon hydrogen

EWI Working Paper, No. 20/04

Provided in Cooperation with:

Institute of Energy Economics at the University of Cologne (EWI)

Suggested Citation: Brändle, Gregor; Schönfisch, Max; Schulte, Simon (2020) : Estimating long-term global supply costs for low-carbon hydrogen, EWI Working Paper, No. 20/04, Institute of Energy Economics at the University of Cologne (EWI), Cologne

This Version is available at:

<https://hdl.handle.net/10419/227508>

Standard-Nutzungsbedingungen:

Die Dokumente auf EconStor dürfen zu eigenen wissenschaftlichen Zwecken und zum Privatgebrauch gespeichert und kopiert werden.

Sie dürfen die Dokumente nicht für öffentliche oder kommerzielle Zwecke vervielfältigen, öffentlich ausstellen, öffentlich zugänglich machen, vertreiben oder anderweitig nutzen.

Sofern die Verfasser die Dokumente unter Open-Content-Lizenzen (insbesondere CC-Lizenzen) zur Verfügung gestellt haben sollten, gelten abweichend von diesen Nutzungsbedingungen die in der dort genannten Lizenz gewährten Nutzungsrechte.

Terms of use:

Documents in EconStor may be saved and copied for your personal and scholarly purposes.

You are not to copy documents for public or commercial purposes, to exhibit the documents publicly, to make them publicly available on the internet, or to distribute or otherwise use the documents in public.

If the documents have been made available under an Open Content Licence (especially Creative Commons Licences), you may exercise further usage rights as specified in the indicated licence.

Estimating Long-Term Global Supply Costs for Low-Carbon Hydrogen

AUTHORS

Gregor Brändle

Max Schönfisch

Simon Schulte

EWI Working Paper, No 20/04

November 2020

**Institute of Energy Economics
at the University of Cologne (EWI)**

Alte Wagenfabrik
Vogelsanger Straße 321a
50827 Köln
Germany

Tel.: +49 (0)221 277 29-100
Fax: +49 (0)221 277 29-400
www.ewi.uni-koeln.de

CORRESPONDING AUTHOR

Max Schönfisch

Institute of Energy Economics at the University of Cologne
Tel: +49 (0)221 277 29-208
Fax: +49 (0)221 277 29-400
max.schoenfisch@ewi.uni-koeln.de

ISSN: 1862-3808

The responsibility for working papers lies solely with the authors. Any views expressed are those of the authors and do not necessarily represent those of the EWI.

Estimating Long-Term Global Supply Costs for Low-Carbon Hydrogen

Gregor Brändle, Max Schönfish*, Simon Schulte

*Institute of Energy Economics at the University of Cologne (EWI)
Vogelsanger Str. 321a, 50827 Cologne, Germany*

Abstract

As part of the decarbonisation of the global economy, low-carbon hydrogen is expected to play a central role in future energy systems. This article presents a comprehensive approach for estimating the development of global production and supply costs of low-carbon hydrogen from renewable energy sources (RES) and natural gas until 2050.

For hydrogen from RES, globally distributed wind and solar photovoltaics (PV) potentials are taken as inputs for low or high temperature electrolyzers. A linear optimisation model minimises hydrogen production costs by determining optimal capacity ratios for each RES and electrolyser combination, based on hourly RES electricity generation profiles. For low-carbon hydrogen from natural gas, natural gas reforming with carbon capture and storage (CCS) and pyrolysis are considered. In addition to production costs, this analysis assesses the costs associated with the transportation of hydrogen by ship or pipeline. The combination of production and transportation costs yields a ranking of cost-optimal supply sources for individual countries.

Estimation results suggest that natural gas reforming with CCS will be the most cost-efficient low-carbon hydrogen production pathway in the medium term (2020-2030). Production of hydrogen from RES could become competitive in the long run (2030-2050) if capital costs decrease significantly. Optimal long-term hydrogen supply routes depend on regional characteristics, such as RES conditions and gas prices. Imports are cost-effective where domestic production potential is small and/or cost-intensive. Additionally, good import conditions exist for countries which are connected to prospective low-cost exporters via existing natural gas pipelines that can be retrofitted to transport hydrogen. Due to high costs for seaborne transport, hydrogen trade will most likely be concentrated regionally, and markets with different provision schemes could emerge. The results are highly sensitive to capital cost assumptions and natural gas prices.

Keywords: Low-Carbon Hydrogen, Hydrogen Production, Hydrogen Transportation, Levelised Cost
JEL classification: Q40, Q42, Q49.

*Corresponding author

Email address: max.schoenfish@ewi.uni-koeln.de (Max Schönfish)

1. Introduction

Hydrogen is a versatile energy carrier and presents an attractive option for the substitution of fossil energy sources. Unlike electricity, it can be stored on a large scale over a long time and can be transported via pipeline or ship. Additionally, there are no direct carbon emissions when it is converted into power or heat. Therefore, hydrogen will likely play a central role in achieving greenhouse gas neutrality in energy-consuming sectors such as industry and transportation (IEA, 2019c).

Hydrogen can be produced from various energy resources, including renewable and nuclear energy, natural gas, coal, and oil (IEA, 2020). For the purposes of this analysis, hydrogen is treated as low-carbon when the production process releases minimal or no CO₂ into the atmosphere. Three approaches to produce low-carbon hydrogen currently receive the most attention, both in academia (Parkinson et al., 2017a; Schmidt et al., 2017) as well as in (supra-)national hydrogen strategies (for example, European Commission, 2020; METI Japan, 2020):

1. Hydrogen from the electrolysis of water driven by electricity from renewable energy sources (RES). This kind of hydrogen is also commonly known as *green hydrogen*. The RES considered for electrolysis are solar photovoltaics (PV) and wind power (onshore and offshore).¹
2. Hydrogen from natural gas reforming with carbon capture and storage (CCS), also referred to as *blue hydrogen*. Most of the CO₂ produced in the process is captured, transported away and stored in permanent repositories to prevent it from escaping into the atmosphere.
3. Hydrogen from the pyrolysis of natural gas, which is also known as *turquoise hydrogen*. Natural gas (methane) is cracked into hydrogen and solid carbon in the absence of oxygen and under high temperature. The process itself produces no CO₂.

A detailed description of the hydrogen production processes covered by the paper at hand can be found in Appendix A.1. Most of these technologies have not yet been applied on a large scale and some are still at the research stage, with relatively low technological maturity. Consequently, the cost of production for low-carbon hydrogen cannot compete with current hydrogen market prices (IEA, 2019c, p. 587).

The same applies to a large-scale transportation infrastructure for hydrogen, which has also not yet been developed. The transportation of hydrogen is challenging due to its low volumetric energy density, in particular when using pipelines is not feasible (IEA, 2019c). Therefore, various solutions are being investigated as potential hydrogen energy carriers for the long-distance transportation of hydrogen by sea, the most prominent being ammonia, liquid organic hydrogen carriers (LOHC) and liquid hydrogen (LH₂)

¹Nuclear energy is also a carbon-free electricity source, but highly controversial in some countries. Germany, for example, has already decided to phase out nuclear power. Therefore, this analysis does not consider nuclear energy.

(Wijayanta et al., 2019). A final assessment of which energy carrier will be the most cost-efficient solution for hydrogen transportation in the long-term is not yet possible; this also depends on the final form of use.

Hydrogen supply costs are comprised of production and transportation costs. Both are essential for the structure of a hydrogen market: Production costs provide an overview of least cost-intensive hydrogen production regions; transportation costs determine whether it is worthwhile to import hydrogen from these regions.

First studies on hydrogen energy were conducted in the 1970s (Veziroglu et al., 1976), as a response to the first signs of impending environmental disruption, exhaustion of hydrocarbon fuels (Meadows and Club of Rome, 1972), and a global energy crisis (Goltsov and Veziroglu, 2001). After the oil crisis of 1973 subsided, low fuel prices and high technology costs led to a reduction in interest in the hydrogen topic, and only a few studies were published. The situation began to change in the early 2000s. Since then, the number of economic studies on hydrogen has sharply increased due to a rise in environmental concerns around fossil fuels and the growing maturity of hydrogen technologies (El-Emam and Özcan, 2019).

Techno-economic assessments examine the technological feasibility and costs of different low-carbon hydrogen production routes. The two pathways that receive the most attention are electrolysis and hydrogen production from natural gas.

Different types of electrolyzers exist, with the alkaline electrolyser currently being the most technologically mature (Schmidt et al., 2017). But according to cost projection studies, other types of electrolysis could become more mature and competitive in the future (Mayyas and Mann, 2019). There are also different possibilities regarding the source of electricity:

Mohammadi and Mehrpooya (2018) carry out a comprehensive review of different combinations of electrolyser and low-carbon electricity sources. They find that while hydro power currently yields the lowest hydrogen production costs, wind and solar energy are better suited to support a large-scale increase in hydrogen production, mainly due to their broader geographical availability.

As natural gas reforming is already an established, mature technology, studies primarily propose equipping reformers with CCS systems (Muradov, 2015). Wang and Rodrigues (2005) examine low-carbon hydrogen production via steam methane reforming (SMR); De Castro et al. (2010) as well as Ishaq and Dincer (2019) investigate a combination of auto-thermal reforming (ATR) and CCS. Findings of Cormos et al. (2018) suggest that low-carbon hydrogen production is more cost-effective with SMR than with ATR, but a 100% capture rate is not economically feasible for either technology.

According to several studies (Gautier et al., 2017; Keipi et al., 2016, 2018; Parkinson et al., 2017b; Weger et al., 2017), the cost of producing low-carbon hydrogen from natural gas could be further reduced by the use of pyrolysis as a conversion technology. Positive revenues from the sale of solid carbon - the process by-product - could even make pyrolysis competitive with current high-carbon production pathways, such as SMR

without CCS (Parkinson et al., 2017a). However, the time horizon of marketability is uncertain, as techno-economic assessments of pyrolysis are currently only based on modelling or small lab-scale applications.

A substantial body of literature compares and evaluates the routes mentioned above to determine efficient production for the present time, but above all, in the long-term future (Machhammer et al., 2016; Kalamaras and Efstathiou, 2013; Timmerberg et al., 2020). In an early analysis, Mueller-Langer et al. (2007) assess different hydrogen production processes and suggest that hydrogen production from electrolysis is unlikely to be competitive, mostly due to high electricity prices. Instead, applying carbon capture technologies could enable a low-carbon hydrogen production from fossil fuels.

Many conditions have changed since then. Most notably, the cost of renewable energy has fallen rapidly, a trend that major projections expect to continue (IEA, 2019c; IRENA, 2020a; BNEF, 2019).

Glenk and Reichelstein (2019) assess the economics of operating an electrolysis system with grid electricity and find that renewable hydrogen is already cost-competitive in some niche applications. El-Emam and Özcan (2019) carry out a comprehensive review of studies on the techno-economics of sustainable large-scale low-carbon hydrogen production. Their findings suggest that fossil-based carbon-intensive hydrogen production is currently more cost-effective than low-carbon production. However, according to their assessment, a medium-term transition towards low-carbon hydrogen looks possible as alternative routes, such as nuclear-driven electrolysis represent promising and potentially competitive production pathways. A study of Ram et al. (2019), which focuses on a path towards an energy system based on 100% renewable energy, expects that the cost of RES-derived hydrogen will continue to decline and become cost-competitive with fossil-based hydrogen by 2050. The International Energy Agency (IEA) states that low-carbon hydrogen from electrolysis "could become competitive in the long-term if large-scale deployment brings down costs" (IEA, 2020, p. 144). According to the IEA's projections, demand for low-carbon hydrogen could, therefore, be covered in the long-term by a combination of both production routes whereby electrolysis could become the dominant technology by 2050 (IEA, 2020, p. 110).

A supply chain infrastructure that connects production and consumption is needed to facilitate the large-scale utilisation of hydrogen. This infrastructure must be newly built (Gerwen et al., 2019), or alternatively, based on the conversion of existing assets. Converting existing natural gas pipelines is potentially the most economical way to establish an infrastructure to transport hydrogen across continental distances (Florisson, 2010). Timmerberg and Kaltschmitt (2019) discuss a low-cost opportunity, wherein hydrogen is blended into existing gas pipelines. Wang et al. (2020) describe a potential future European transportation network for hydrogen, whereby parts of the infrastructure have to be newly built, retrofitting former gas pipelines can substantially reduce costs. Gaseous hydrogen has a low volumetric energy density; transportation and storage in a medium with limited space (ships, tanks) is expensive and inefficient. Alternative energy carriers for long-distance (overseas) transportation and storage are discussed, wherein hydrogen is liquefied

or incorporated into other molecules with higher energy density (IEA, 2019b). Kojima (2019) assesses the materials most suitable for mixing with hydrogen to ensure efficient transportation storage and finds ammonia to be an attractive hydrogen carrier. Wijayanta et al. (2019) review different hydrogen carriers and conduct a long-term cost comparison. According to the study, ammonia with direct utilisation has the potential for massive adoption. If pure hydrogen is required as the end use product, liquid hydrogen (LH₂) looks promising as a carrier in the long run. Mizuno et al. (2016) present a cost analysis of different hydrogen energy carriers as part of an international supply chain by shipping for 2030 and 2050. They find only negligible cost differences between ammonia and LH₂ and identify many essential points for research and development that could significantly decrease transportation costs. So-called Liquid Organic Hydrogen Carriers (LOHC) are also examined as transportation options. These are substances that can absorb and release hydrogen by chemical reaction. Abánades et al. (2013) and Aakko-Saksa et al. (2018) review and discuss the suitability of LOHC for transportation and storage. Hydrogen carriers are found to be particularly promising for hydrogen storage. Reuß et al. (2017) develop a supply chain model, including transportation and seasonal storage, to analyse different alternative hydrogen carriers. According to their results, LOHC could be favourable for small-scale storage and supply chains; liquid hydrogen could be cost-efficient for long-distance seaborne transportation. The Economic Research Institute for ASEAN and East Asia (ERIA, 2019) compares different pathways to supply hydrogen and finds long-term cost advantages for Methylcyclohexane, which is a LOHC. However, the optimal carrier depends on the structure of the supply chain and the type of end use. Ammonia and liquid hydrogen are also partly suitable.

Another literature stream deals with potential structures of hydrogen trade and supply. Results from techno-economic assessments of production and transportation often serve as a basis for these analyses. Case studies discuss the development of a hydrogen economy and possible sources of hydrogen imports for selected countries.

Heuser et al. (2020) model a global hydrogen supply scheme. They estimate supply costs for selected countries in 2050 and only consider production and trade of hydrogen from RES. Hydrogen provision is determined by a cost-optimal allocation approach where regions with a strong output of wind and solar energy export to different demand regions. Their results suggest that trading will mostly take place within continental regions.

A range of specific case studies can be found for Japan and Germany, as both countries have set ambitious targets for the hydrogen economy and will likely have to import at least part of their demand (BMW, 2020; METI Japan, 2020). Jensterle et al. (2019) analyse the role of clean hydrogen in Japan and Germany's future energy systems and investigate potential supply chains. In a subsequent study, Jensterle et al. (2020) evaluate international cooperation potentials for Germany to import hydrogen from RES and include soft criteria such as socio-political stability or existing know-how. They identify Iceland, Canada, and Morocco as countries particularly suitable as a medium-term source of imports. Among others, Egypt, Algeria, and

Argentina have the most promising absolute long-term export potential. [Hebling et al. \(2019\)](#) present a hydrogen road map for Germany and evaluate options for action. They emphasise that technology funding and the implementation of an international trading system are essential requirements, while regulatory frameworks play a significant role.

Case studies for Japan often focus on hydrogen imports by ship due to the country’s geographical location as an island. [Watanabe et al. \(2010\)](#) estimate costs for hydrogen from overseas wind energy and find that it will be difficult for hydrogen from RES to compete with current fossil fuel-based hydrogen at current price levels. [Fúnez Guerra et al. \(2020\)](#) discuss the case of providing Japan with renewable Ammonia from Chile. A similar study comes from [Heuser et al. \(2019\)](#) who investigate the elements of a hydrogen supply chain linking Patagonia and Japan.

There are also hydrogen case studies for other countries that analyse the potential of domestic production or imports, for example, for Argentina ([Rodríguez et al., 2010](#)), Hong Kong ([Shu et al., 2015](#)), or South Korea ([Stangarone, 2020](#)).

Compared to the existing literature, this article presents an extensive global analysis of low-carbon hydrogen production and supply costs. To our knowledge, it is the first analysis to comprehensively consider both renewable energy as well as natural gas-based low-carbon hydrogen on a global scale.

Efficient hydrogen supply pathways are examined by estimating cost developments for different production and transportation options. Hydrogen from RES as well as hydrogen from natural gas are considered. For the analysis of hydrogen from RES, data on global PV and wind energy potentials is clustered into multiple resource classes that make a cost distinction possible also within a country. Each resource class can be combined with a low or high temperature electrolyser to produce hydrogen. A linear optimisation model determines optimal ratios of installed RES-to-electrolyser capacity to minimise hydrogen costs individually for each RES and electrolyser combination. Concerning hydrogen from natural gas, this study considers natural gas reforming with CCS; additionally, production via pyrolysis serves as a long-term² alternative production route. Pyrolysis is currently not market-ready, but if feasible, it yields the advantage that the carbon by-product is solid; thus, capturing, transportation and storage of CO₂ can be avoided. The analysis assesses hydrogen transportation by pipelines or by liquid hydrogen tankers. Based on global production costs and cost-minimising transportation routes, potential supply structures at a country level are discussed in exemplary case studies for Germany, Japan and the United States.

The results suggest that in the medium term, hydrogen from natural gas is the most cost-efficient route for a fast ramp-up of the hydrogen economy. Production of hydrogen from RES could become competitive in the long run if capital costs decrease significantly. Optimal long-term hydrogen supply routes depend on

²In general, *long-term* refers to the time after 2040, *medium-term* is used in this paper to describe the period of the next ten years.

regional characteristics, such as RES conditions and gas prices. Where gas pipelines can be retrofitted to transport hydrogen, transportation costs decrease, so that the import of hydrogen from more distant regions becomes more worthwhile. Imports via ship are only cost-effective in regions with high gas prices and poor domestic RES conditions where regional import of low-cost hydrogen from RES via pipeline is not possible. The cost of RES-based hydrogen is highly sensitive to capital cost assumptions, while the cost of natural gas-based hydrogen is highly sensitive to the natural gas price.

The remainder of this paper is structured as follows: section 2 lays out the methodology of the analysis. Data and assumptions are presented in section 3. Key results are presented and discussed in sections 4 and 5. Section 6 concludes the analysis.

2. Methodology

The objective of this analysis is to estimate long-term production and supply costs of different low-carbon hydrogen technologies.³ Production costs are estimated for low-carbon hydrogen derived from the electrolysis of water, using renewable energy sources (solar photovoltaics (PV), onshore and offshore wind) to drive the process, and from natural gas (natural gas reforming (NGR) with CCS and pyrolysis). Estimations are performed individually for each year (2020-2050), country and technology. We derive the levelized cost of hydrogen (LCOH), which is the average net present cost of hydrogen produced by a technology over its whole lifetime.⁴

Since production costs alone have no significance for local supply costs, international transport costs for hydrogen are estimated. We assume that only hydrogen from RES will be transported; hydrogen from natural gas is always produced domestically, so that the local gas price determines local supply costs.⁵

Hydrogen costs from electrolysis, pyrolysis and natural gas reforming are first analysed individually and then compared with each other afterwards. The methodology shown in figure 1 can be described in the following steps:

- Set a framework of general assumptions

First, central assumptions are made. This includes a global electricity production scenario, a carbon price projection, as well as countries, years, available technologies and a uniform weighted average cost of capital (WACC).

³Refer to [Appendix A.1](#) for a detailed description of the technologies covered by this analysis.

⁴The LCOH (in \$/kg) is derived by dividing the discounted total costs by the sum of hydrogen produced over the economic lifetime of asset.

⁵The transportation of natural gas, whether by pipeline or ship, is always cheaper than the transportation of hydrogen. Therefore, importing hydrogen produced elsewhere from natural gas would always be more costly than domestic hydrogen production using imported natural gas. This is likely the case even when the long-term storage of CO₂ is not possible locally and it has to be transported over large distances to suitable storage sites, thereby substantially increasing the cost of CO₂ disposal. As we show in section 5, the LCOH of hydrogen from NGR with CCS exhibits a very low sensitivity to variations in CO₂ disposal costs.

Figure 1: Methodology for long-term supply cost estimation

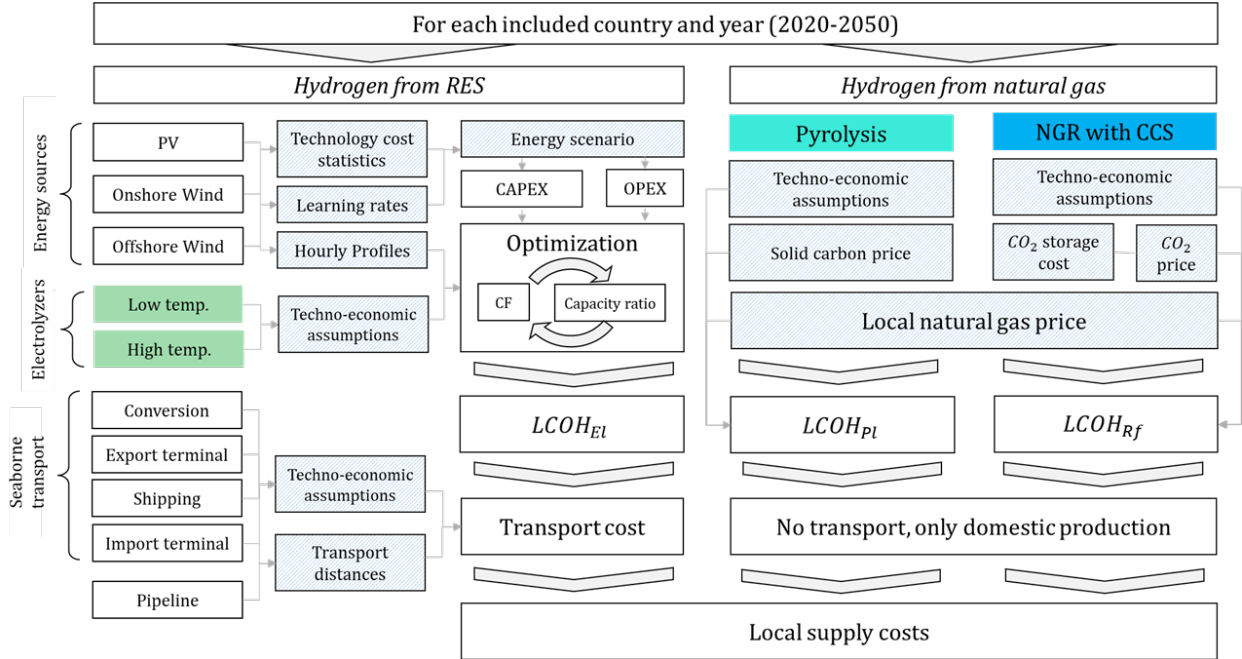

Techno-economic assumptions include lifetime, efficiency, availability, capital expenditures (CAPEX) and operating costs (OPEX). Exogenous inputs are blue-hashed. Weighted average costs of capital (WACC) are assumed to be equal over countries and time and therefore excluded in this figure for simplicity.

- Estimate production costs for hydrogen from RES

Starting with the electricity production scenario, a RES investment cost (CAPEX) projection is constructed based on global one-factor experience curves for each renewable energy technology. The one-factor experience curve is widely used to project future RES costs (Rubin et al., 2015b; Alberth, 2008) and indicates a log-linear relationship between technology cost and cumulative installed capacity (McDonald and Schrattenholzer, 2001). Global RES potentials are clustered into resource classes that differ in the quality of their capacity factors. For each country, resource class, RES, electrolyser and year, cost-minimising ratios for RES-to-electrolyser capacity are determined using a linear optimisation model (see equations B.3 to B.8 in Appendix B.2). Individual production costs for hydrogen from RES are calculated based on the optimum ratios.⁶

- Estimate production costs for hydrogen from natural gas

Techno-economic assumptions are combined with a natural gas price projection to obtain the LCOH from pyrolysis and natural gas reforming. Country-specific CO_2 transportation and storage cost assumptions are considered in the estimation of the LCOH from natural gas reforming with CCS.

⁶We also modelled hybrid systems (combinations of more than one type of intermittent RES with an electrolyser). More details on the potential advantages of hybrid systems can be found in Appendix D.2.

- Estimate transportation costs for hydrogen

Pipelines and seaborne transportation with liquid hydrogen tankers are considered as options. Distance-based transportation costs are determined based on existing natural gas pipeline routes and selected port-to-port distances.

- Compare costs for selected countries, years and technologies

Supply costs at a country level are compared under varying assumptions to obtain robust findings on what the most cost-efficient hydrogen supply structure could look like depending on country characteristics, such as the natural gas price, domestic RES conditions, distance from potential exporters and the potential availability of pipeline connections.

3. Data and Assumptions

We assess 94 countries on six continents (except Antarctica).⁷ The years considered are 2020 to 2050. A uniform WACC of $r = 8\%$ is assumed for all investments.

From the perspective of this analysis, a prerequisite for strong growth in global demand for low-carbon hydrogen is an ambitious decarbonisation of the entire economy, and the power sector in particular. Our analysis is therefore embedded in a scenario framework that reflects such a transition. In line with [IEA \(2019a\)](#), we assume a carbon price is imposed on all uncaptured emissions from the hydrogen production process (see [Appendix C.6](#) for details). In addition to that, we assume an aggressive deployment of renewables in the power sector, as outlined in the IRENA REmap scenario ([IRENA, 2019b](#)). The cumulative, technology-specific RES build-out projected by this scenario is to estimate the development of RES CAPEX and operating costs (OPEX) by applying learning rates (described in more detail below).⁸

3.1. Hydrogen from RES

Techno-economic forecasts for RES and electrolyser CAPEX differ very strongly. In order to consider this in our analysis, we developed two separate cost scenarios:

- A scenario with baseline assumptions close to mean values of cost projections from literature,
- a scenario with optimistic assumptions from the lower end of cost projections,
- an explicit optimisation and consideration of a scenario with pessimistic assumptions is left out for simplicity. If costs decrease less than under baseline assumptions or even remain constant, LCOH from current years of the baseline assumptions scenario can represent this possibility.

⁷A detailed list of countries and regions can be found in [Appendix C](#)

⁸The cumulative, technology-specific RES capacity additions assumed by the IRENA REmap scenario are displayed in table [C.8](#) in [Appendix C](#).

There is a large body of literature on learning rates (LR) for wind and solar PV. The assumptions on learning rates in this analysis are based on a literature review of recent learning rate estimates. A detailed overview of the surveyed literature can be found in [Appendix C.2](#). Only estimates from the last five years are considered since older projections have mostly underestimated RES cost reductions and are, in some cases, already incorrect today ([Krey et al., 2019](#)).

The selected learning rates and other key techno-economic assumptions are presented in [table 1](#). CAPEX and OPEX figures for PV, onshore wind and shallow-water (<25m) offshore wind were obtained from [DNV GL \(2019\)](#) for the year 2018. DNV-GL differentiates costs by region,⁹ so each country we consider is assigned to the corresponding region. For offshore wind turbines sited in deeper waters (25m to 55m), we used projections from [NREL \(2020, TRG 5\)](#) since offshore CAPEX varies considerably with water depth and distance to shore ([Myhr et al., 2014](#)).¹⁰ Cost differences between countries for the deep-water class are assumed to be the same as those of the shallow-water offshore class, as provided by [DNV GL \(2019\)](#).

Table 1: Techno-economic assumptions on RES

	PV	Onshore wind	Offshore wind
Lifetime n (years)	25	25	25
OPEX (% of CAPEX/a)	2	2.5	2.5
LR baseline (%)	30	18	16
LR optimistic (%)	40	23	20
Cum. installed capacity x_y^{res} (reference)	IRENA (2019b)	IRENA (2019b)	IRENA (2019b)
capacity factor (reference)	Pietzcker et al. (2014)	Bosch et al. (2017)	Bosch et al. (2019)

Assumptions for lifetime and OPEX from [IEA \(2019c\)](#). A full overview on calculations of accumulated installed capacities can be found in [Appendix C.8](#).

The capacity factor is a ratio between 0-1 that indicates how much energy a RES produces in relation to its installed capacity (1) over a given period of time, usually a year. Areas with higher solar irradiance or higher mean wind speeds allow for higher capacity factors and thus yield *ceteris paribus* a lower levelised cost of electricity (LCOE) and thus potentially lower LCOH. To assess a country’s RES-based hydrogen production potential, and to take into account in-country variations in the quality of the RES resource, we cluster PV and onshore wind potentials based on capacity factor ranges. As explained above, offshore wind potentials are clustered based on water depth instead, as CAPEX rise significantly when moving into deeper waters.

⁹Statistics compiled by ([IRENA, 2020b](#)) show that RES CAPEX varies between countries. This is due to, among other factors, differences in labour costs and the prevailing exchange rates.

¹⁰CAPEX for PV and onshore wind also vary depending on location and terrain, although to a much lesser extent. For the purpose of simplification, in-country variations in the CAPEX/OPEX of PV and onshore wind are not considered for this analysis.

Each resource class has a theoretical potential, which states how much total capacity (measured in GW_{el}) can be installed within a given resource class in a given country.

We exclude potentials with capacity factors below certain thresholds from the analysis, as hydrogen production would be prohibitively expensive in such areas. Furthermore, resource classes with a potential of less than 1 GW_{el} are also excluded.

Country-level data on PV capacity factors and potentials is taken from [Pietzcker et al. \(2014\)](#). The data is already clustered into resource classes based on capacity factor ranges. PV potentials are clustered into four classes with capacity factors ranging from >0.22 (1), 0.21 to 0.22 (2), 0.21 to 0. (3) and 0.2 to 0.125 (4).¹¹¹²

Capacity factors and potentials for onshore and offshore wind are taken from [Bosch et al. \(2017\)](#) and [Bosch et al. \(2019\)](#). As with PV, the potentials of the analysed countries are clustered into classes based on capacity factors. For onshore wind, capacity factor classes range from >0.4 (1), 0.4 to 0.3 (2) and 0.3 to 0.2 (3). Potential sites with capacity factors below 0.2 are excluded.

As explained above, offshore wind CAPEX are strongly dependent on water depth. Simply categorising offshore wind potentials by capacity factor would bias the results and give a relative advantage to potentials in deep waters. For this reason, we chose to define offshore wind resource classes based on water depth, not capacity factor. Classes 1 and 2 correspond to water depths of $<25\text{m}$ and 25-55m respectively.

For each resource class of PV, onshore, and offshore wind, we construct a synthetic hourly capacity factor profile for a full year. More details on this procedure can be found in [Appendix B.5](#). The estimated hourly profiles are then fed into the optimisation model that computes the optimal RES-to-electrolyser ratio for the given resource class.

The assumptions on CAPEX, OPEX and capacity factors are used to compute the LCOE for each combination of country, technology and resource class. For a comparison of our estimates with those in the literature, refer to table [C.9](#) in [Appendix C](#).

We distinguish between low- and high-temperature electrolysers. Unlike for RES, no country or region-specific cost data is available for electrolysers.¹³ Therefore, a globally uniform cost for electrolysers is

¹¹[Pietzcker et al. \(2014\)](#) subtract another 10% from all results to account for additional losses, e.g. due to the accumulation of dust on modules. The 10% is added again for our analysis; otherwise, the absolute capacity factor decrease would be higher for good potentials, leading to a slight convergence of global PV capacity factors. The author also excludes all areas with a distance of >100 km from the closest settlement since development costs increase with the distance from existing infrastructure. However, there are not many countries with a relevant amount of space more than 100 km away from existing infrastructure. Countries in which this is the case (the United States, some countries in Africa, South America, and China) have such extensive solar potentials ([Pietzcker et al., 2014](#), p. 712), that more distant areas with higher development costs will most likely never need to be developed.

¹²It should be noted that for Spain, potentials with a capacity factor in excess of 0.21 (the maximum value for the Iberian Peninsula according to ([World Bank et al., 2020](#))) were excluded, since they are located on the Canary Islands. For this analysis, only the Spanish mainland is considered, so that it is possible to assume uniform transportation costs. Furthermore, the Canary Islands are remote and lack the area potentials required for large-scale hydrogen production.

¹³There is a cost distinction in [BNEF \(2019\)](#), but only between China and the rest of the world. Furthermore, the study assumes costs in the rest of the world will converge with China by 2030.

assumed, as is common in the literature to date. The techno-economic assumptions chosen for our analysis are based on [IEA \(2019b\)](#) and presented in table 2.

Table 2: Techno-economic assumptions for electrolyzers

	2020	2030	2040	2050
Low temperature				
<i>CAPEX</i> base / optimistic (\$/kW)	950 / 500	625 / 400	537.5 / 300	450 / 200
<i>OPEX</i> (%CAPEX/a)	2	2	2	2
Efficiency η (%)	66.5	68	71.5	75
Operating pressure (bar)	30			
Operating temperature ($^{\circ}$ C)	50-80			
Lifetime (years)	25	25	25	25
High temperature				
<i>CAPEX</i> base / optimistic (\$/kW)	4000 / 2400	1800 / 800	1275 / 650	750 / 500
<i>OPEX</i> (%CAPEX/a)	2	2	2	2
Efficiency η (%)	77.5	80.5	82	83.5
Operating pressure (bar)	30			
Operating temperature ($^{\circ}$ C)	650-1000			
Lifetime (years)	25	25	25	25

3.2. Hydrogen from natural gas

In contrast to hydrogen from RES, system CAPEX are not a dominant factor in LCOH from natural gas-based systems. Therefore, only one set of assumptions is made for the techno-economic parameters.¹⁴

Table 3: Techno-economic assumptions for NGR and pyrolysis plants

	NGR with CCS	Pyrolysis (H_2 -fired)
Lifetime n (years)	25	25
<i>CAPEX</i> 2020 / 2030 / 2050 (\$/kWh ₂)	1627 / 1360 / 1280	- / - / 457
<i>OPEX</i> (% of CAPEX/a)	3%	5%
Efficiency η (%)	69%	52%
CO ₂ capture rate (%)	90%	-
Total Emissions (kgCO ₂ /kgH ₂)	9.7	-
Captured Emissions CE (kgCO ₂ /kgH ₂)	8.7	-
Uncaptured Emissions UE (kgCO ₂ /kgH ₂)	1	-
Carbon yield CB (kgC/kgH ₂)	-	3
Availability CF (%)	95%	95%

We model both NGR with CCS and pyrolysis as options for the production of low-carbon hydrogen from natural gas. Assumptions for NGR with CCS are based on [IEA \(2019b\)](#); expected improvements in carbon capture technology translate into a CAPEX and OPEX decline over time. Table 3 gives an overview of all relevant techno-economic parameters. For the hydrogen from NGR with CCS to be low-CO₂, the CO₂ captured in the carbon capture facility must be transported away and stored permanently to prevent it from

¹⁴A sensitivity analysis for CAPEX is performed in section 5.

escaping into the atmosphere. The long-term storage of CO₂ can take place in geological formations called saline aquifers, or in depleted oil and gas fields. Currently, storing CO₂ underground is restricted by law in many regions, e.g., in Germany. In some countries, there is significant public opposition to underground CO₂ storage. Therefore, based on [Hendriks and Bergen \(2004\)](#), we consider two carbon storage scenarios: In a restricted scenario, CO₂ storage is only allowed offshore; in an unrestricted scenario, CO₂ can also be stored onshore. Costs for CO₂ transportation and storage range from between \$6 and \$18 per tonne of CO₂ in the unrestricted scenario and \$8 to \$40 per tonne when only offshore storage is permitted.

No CO₂ is produced in the methane pyrolysis process. There are cost estimates for large-scale pyrolysis plants in the literature, but no projections of how costs will develop once the technology is deployed at scale. This is mainly due to the low technology readiness level (TRL), which is also why it is uncertain if and when the technology will be ready for the market. A German research group ([Bode, 2019](#)) plans to construct the first commercial plant by 2030; [Ausfelder et al. \(2019\)](#) expect pyrolysis to be ready for use by 2040.¹⁵ For the analysis at hand, it is assumed that commercial-scale pyrolysis for hydrogen production will be available from 2035 onwards. There are multiple sub-categories of pyrolysis plants which differ mainly on the technologies used to provide the heat needed to drive the pyrolysis process. An overview can be found in [Schneider et al. \(2020\)](#) and [Timmerberg et al. \(2020\)](#). For this analysis, we selected the molten metals pyrolysis reactor from [Parkinson et al. \(2017a\)](#) with hydrogen combustion as a heat source. This has some advantages:

- In contrast to a natural gas-fired pyrolysis system, no CO₂ is produced in the heating process, making a hydrogen-fired unit more suitable for the purpose of our analysis - examining low-carbon hydrogen production.
- H₂-fired pyrolysis systems are generally able to produce hydrogen at lower LCOH than systems that use electricity to drive the process (e.g. plasma plants), except when gas prices are high and grid electricity is cheap.¹⁶
- As no additional electricity is required, this simplifies the computational process and obviates the need to make assumptions about the CO₂ intensity of electricity supply from the grid or RES potentials, capacity factors and costs.
- All relevant techno-economic assumptions adopted for our analysis are presented in [Parkinson et al. \(2017a\)](#) and shown in table 3.

¹⁵Monolith Materials ([Monolith, 2019](#)) already have a pyrolysis plant in operation. However, this plant is designed to produce solid carbon; hydrogen is only a by-product.

¹⁶Exemplary calculations show that for a gas price of \$20/MWh, an electricity price of below \$20/MWh would be necessary for a plasma system to yield lower LCOH than a H₂-fired system.

Pyrolysis CAPEX in Parkinson et al. (2017a) are estimated by applying the *Lang factor*, which is widely used in chemical engineering, to calculate total installation costs of plants (Sinnott, 1999). To determine total CAPEX from the total cost of equipment, a multiplier is set based on the maturity level of a technology. Parkinson et al. (2017a) apply a Lang factor of 10, which corresponds to a *first-of-a-kind* plant. To account for the techno-economic progress and decreasing CAPEX with an increasing number of plants, we gradually decrease the Lang factor over the years 2035-2050 to a value of 6 (*nth-of-a-kind*), which is the current maturity level of SMR technology.¹⁷ A critical factor for production costs of hydrogen from pyrolysis is the price of the solid carbon by-product. The exact structure of the carbon produced in the process depends on specific process characteristics. The most prominent carbon by-product of pyrolysis is carbon black, where market prices range between 400 and 2000 \$/t (Keipi et al., 2016). The current market size of carbon black is 16.4 Mt/a (Parkinson et al., 2019), which would correspond to a hydrogen production of 5.5 Mt/a under the assumptions of this analysis (see table 3). This corresponds to 7.5% of the global hydrogen demand in 2018 (IEA, 2019b). Considering a future large-scale production of hydrogen from pyrolysis, the current carbon market sizes would quickly be exceeded, and solid carbon prices would likely fall towards zero. If new applications or markets are found, prices for carbon products could be positive. Alternatively, if there is no use for the material and it has to be disposed of, there would be a cost, which would be equivalent to a negative solid carbon price. A solid carbon price of 0 is assumed for this analysis. The impact of a price change is considered as sensitivity in section 5.

3.3. Hydrogen transportation

We consider both pipelines and oceangoing ships as transportation modes for the long-distance transportation of hydrogen.

Cost estimates for pipeline-bound hydrogen transportation vary substantially from study to study. They can be significantly reduced if - instead of building new hydrogen pipelines from scratch - existing natural gas pipelines are retrofitted to carry hydrogen. For our analysis, both estimates of IEA (2019b) and Wang et al. (2020) are considered as an upper and lower bound in order to reflect the entire cost spectrum as a sensitivity for pipeline transportation costs. Since hydrogen pipelines are an established technology (IEA, 2019b, p. 75), we assume costs to remain flat over time. We also assume hydrogen production facilities to operate in the same pressure range as the pipelines, avoiding the need for an additional compression of the hydrogen prior to its injection into a pipeline.¹⁸ Table 4 gives an overview of the assumptions.

¹⁷If pyrolysis is market-ready and cost-competitive, market shares of hydrogen from pyrolysis could rise rapidly with many pyrolysis plants being built. Therefore, a fast market ramp-up with decreasing CAPEX appears likely in such a scenario.

¹⁸If the output pressure of the production process is lower than the pipeline system's suction pressure, the additional cost of compression increases overall transportation costs. The relationship between compression costs and the width of the pressure gap is positive and nonlinear (Wang et al., 2020). Wang et al. (2020, p. 13) propose a pipeline suction pressure of 30-40 bar. NGR and pyrolysis plants, as well as low- and high-temperature electrolyzers, can all be designed to operate in this pressure range: see Muradov and Veziroglu (2005) for NGR with CCS; Parkinson et al. (2017a) for pyrolysis and Mathiesen et al. (2013) for electrolyzers.

Table 4: Techno-economic assumptions on hydrogen pipelines

	High cost	Low cost	Retrofit
Technical Lifetime (years)	40	40	40
CAPEX (\$/tpa/km)	3.56	1.33	0.73
OPEX & Fuel (% of CAPEX/a)	5	5	5
Utilisation (%)	75	75	75
Cost of pipeline transport (\$/1000km/kg H ₂)	0.64	0.24	0.13

Pipeline costs are assumed to be constant over time. Assumptions for **High cost** pipelines are calculated based on [IEA \(2019c\)](#). Assumptions for **Low cost** and **Retrofit** pipelines are calculated to reflect medium cost estimates from [Wang et al. \(2020\)](#).

Transporting gaseous hydrogen over long distances by ship would be prohibitively expensive due to its low volumetric energy density. For sea transportation, it is more efficient to liquefy the hydrogen or incorporate it into carrier molecules with a higher energy density. However, hydrogen liquefaction or conversion is very energy-intensive and expensive, increasing hydrogen supply costs by 50-150%, depending on transportation technology and distance ([IEA, 2019c](#), p. 608). The three most widely studied technologies are:

- Liquid hydrogen (LH₂) has a higher volumetric density than gaseous hydrogen, making it better suited for seaborne transport. However, the hydrogen has to be cooled down to temperatures below -240°C in order to liquefy, which requires energy. Moreover, the low temperatures required pose a challenge to the materials used, increasing the costs of storage and transportation infrastructure. Boil-off is an issue as well. LH₂ transport is not yet well developed on a large scale as there are currently no LH₂ ships commercially available, only smaller test vessels ([Kawasaki Heavy Industries, 2015](#)).
- Ammonia (NH₃) is a compound of nitrogen and hydrogen and gaseous at standard temperature and pressure. It can be liquefied at temperatures below -33°C and has a volumetric energy density that is 50% higher than liquid hydrogen. Ammonia is used mainly as a chemical feedstock for the production of fertilisers and explosives, or as a refrigerant. Over half of the current worldwide demand for pure hydrogen serves the production of Ammonia ([IEA, 2019b](#), p. 31). Transportation networks and infrastructure for ammonia are well-established; seaborne transportation takes place in commercial liquefied petroleum gas (LPG) tankers. The main cost drivers for ammonia transportation are the conversion and reconversion processes; conversion requires 7-16% ([Bartels, 2008](#)) and reconversion requires about 16% ([T-Raissi, 2002](#)) of the energy contained in the hydrogen.
- LOHCs are molecules that can absorb and release hydrogen through a chemical reaction. Their properties are similar to oil. As a result, they can be transported in the existing infrastructure for liquid fuels, without any need for additional cooling ([Aakko-Saksa et al., 2018](#)). However, as with ammonia, high costs are associated with conversion and reconversion, which would respectively require

35% and 40% of the equivalent energy contained in the hydrogen (Wulf and Zapp, 2018). Furthermore, LOHC molecules currently under consideration are often expensive and need to be shipped back to their place of origin to be reused (IEA, 2019b).

Transporting hydrogen in the form of ammonia is considered to be cheaper than LH₂ transport in the medium term, despite the high costs for conversion and reconversion. According to a detailed analysis by the IEA (2019b, p. 76 ff), ammonia-based seaborne transport is the most cost-efficient solution in 2030 for all shipping distances. However, since the technological maturity of large-scale hydrogen liquefaction and shipping is currently low (IEA, 2019b, p.75), substantial cost reductions can be expected if the technology is used more widely in the future (ERIA, 2019). According to Wijayanta et al. (2019), ammonia transportation would remain the most efficient solution in the long term if the ammonia is used directly, and not reconverted back to hydrogen. However, if pure hydrogen is needed, LH₂ has the potential to become the cheapest shipping method in the long term. Ammonia (re-)conversion is associated with high energy losses, which increase with the purity of the hydrogen required. Fuel cells, for example, require hydrogen of high purity, which makes ammonia reconversion and thus the entire transportation chain more expensive (IEA, 2019b). Since we explicitly estimate the long-term costs of pure hydrogen, in line with other long-term studies (Kamiya et al., 2015; Heuser et al., 2019), LH₂ is chosen as the preferred technology for hydrogen transportation by ship. Table C.12 displays the techno-economic assumptions on the individual components of the liquid hydrogen transport infrastructure. The cost of the electricity required for the operation of the infrastructure (mainly the liquefaction of hydrogen) is taken from DNV GL (2019) projections.

In order to calculate shipping costs, we obtained port-to-port distances between countries from the CERDI sea distance database (Bertoli et al., 2016). Pipeline distances are based on own calculations, using existing natural gas pipeline routes as a baseline.

4. Results

This section presents the key results of this study. The full range of results on production, transportation, and supply costs is provided in a supplementary spreadsheet.¹⁹ It should be noted that RES-to-electrolyser ratios are optimised. Therefore, RES capacity factors do not translate directly to electrolyser capacity factors, as the optimisation model trades RES curtailment for a higher annual utilisation of the electrolyser. Additional information on the effect of the optimisation of the electrolyser-to-RES ratio on the LCOH of the combined system are presented in Appendix D.1.

¹⁹The spreadsheet can be downloaded [here](#).

4.1. Hydrogen from RES

Figure 2 shows cost ranges and mean LCOH for the 20 best RES resource classes globally under baseline and optimistic assumptions.

Figure 2: LCOH range and mean values of the 20 lowest-cost resources classes for each RES-electrolyser combination

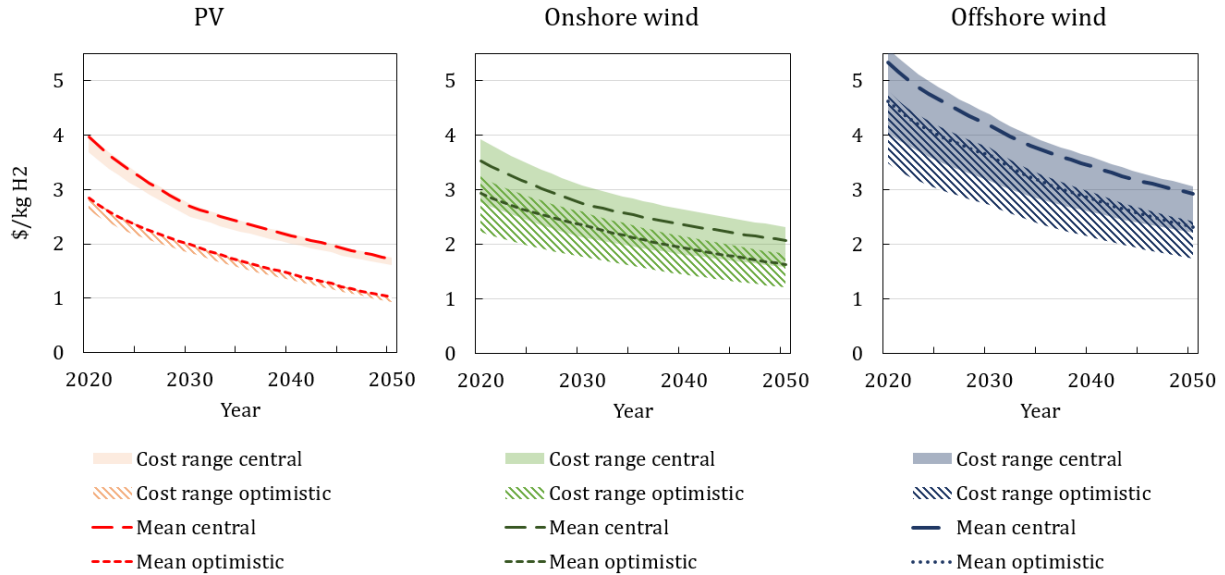

The mean values for the LCOH in figure 2 tend to be located at the upper end of the respective cost ranges, which shows that the lowest cost potentials are generally smaller than those with higher costs. The cost range for PV is relatively narrow, as solar irradiation and thus the LCOH varies less among the best areas. This shows how vast PV potentials are; large areas exist for low-cost PV electricity generation in sunny countries.

A slightly different picture emerges for onshore wind, which has a broader cost range. The variation in wind capacity factors is larger than for PV; often, there are small areas with low costs and more extensive areas with higher costs. For baseline assumptions, onshore wind has the lowest minimum LCOH of \$2.7/kg in 2020 and \$2.1/kg in 2030. The lowest LCOH for PV is \$3.75/kg in 2020 and \$2.5/kg in 2030. Costs for PV decrease faster compared to onshore wind so that PV is catching up in the long run. In 2050 the most favourable potentials of both RES have minimum hydrogen production costs of \$1.6/kg. The mean LCOH under baseline assumptions is \$2.7/kg in 2030, decreasing to \$1.7/kg by 2050 for PV and \$2.6/kg in 2030 decreasing to \$2/kg in 2050 for onshore wind. Offshore wind energy potentials are vast. For offshore wind-based systems, the minimum LCOH is \$4.5/kg in 2020, decreasing to \$2.2/kg in 2050. However, the range between is quite large, as capacity factors vary substantially within the top 20 offshore resource classes considered by this analysis. Across the top 20, the mean LCOH decreases from \$5.05/kg in 2020 to \$2.76/kg in 2050.

Under optimistic assumptions, cost reductions are most substantial for PV, making it the potentially cheapest source for RES-based hydrogen from 2033 on. By 2050, minimum hydrogen production costs could fall below \$1/kg for PV. Onshore wind remains the most competitive source in the short term with a mean LCOH of \$2.2/kg in 2030, decreasing to \$1.5/kg by 2050. Minimum Onshore wind LCOH is \$1.75/kg in 2030 decreasing further to \$1.2/kg by 2050. The minimum LCOH for offshore wind is \$2.7/kg in 2030 and \$1.7/kg in 2050, the mean LCOH declines from \$4.32/kg in 2020 to \$2.04/kg in 2050.

There are particularly well-suited regions for each renewable energy technology, with costs close or equal to the global minima shown in figure 2. Regions with low LCOH for PV-based systems are the Middle East and North Africa, Central America, and the United States. Besides, China, parts of India, Pakistan, and Southeast Asia also have good potentials for PV. There, the LCOH is further depressed by the lower expected CAPEX for PV, when compared to the global average. Low production costs for hydrogen from onshore wind can be found in Central and South America, Northern Europe, the United States, and China (again favoured by comparably low wind turbine CAPEX in China). The lowest costs for hydrogen from offshore wind can be found along the coasts of South America and North-Western Europe. The offshore resource class 1 with <25m water depth generally yields a lower LCOH. This is due to the lower CAPEX associated with building offshore wind turbines in shallower waters, which more than compensates for the on average only slight decrease in capacity factor closer to the coastline.

Regarding hybrid systems, we found that combining a wind turbine, PV array and electrolyser (to decrease the intermittency of the combined system and increase the load factor of the electrolyser) can result in a lower overall LCOH. However, this is only the case when very good wind and solar potentials overlap geographically and even in such cases, the cost advantage is small over a pure PV- or wind-based system. In most cases, however, an optimised system relying on only one type of RES yields a lower LCOH because of its lower capital intensity, in particular in the optimistic case with its substantial decline in RES and electrolyser CAPEX. We therefore chose to exclude hybrid systems from the cost comparison, given that they have (small) cost advantages only in specific geographies and only when very specific conditions are met. The issue is explained in more detail in [Appendix D.2](#).

Apart from the exact costs for individual technologies, some general insights on the cost structure of hydrogen from RES can be derived from the results:

- As RES CAPEX vary between regions, some regions have fundamental cost advantages in hydrogen production. A particular advantage exists for China. With the lowest global CAPEX for PV, onshore, and offshore wind, China has better starting conditions for hydrogen production than countries with higher CAPEX. The results reflect this; hydrogen production costs are close to the global minimum in China for both PV- and onshore wind-based hydrogen production.

- Comparing low and high temperature electrolysis, low temperature is the cheaper electrolysis technology in the short and medium term. In the long run, however, high temperature electrolyzers could become cost-competitive for RES potentials with high capacity factors, allowing for a high annual utilisation of the electrolyser. The advantage of a high temperature electrolyser is its higher efficiency; the disadvantages are higher system costs, which are currently reinforced by a low technological maturity. With maturity increasing over time, CAPEX and LCOH decrease more significantly for hydrogen production based on high temperature electrolysis, making it more cost-competitive. Under baseline assumptions, a high temperature electrolyser becomes the more cost-efficient option in the long-run for utilisation rates >0.7 . Our results suggest that RES capacity factors that make high temperature electrolyzers cost-efficient exist for some offshore potentials, such as Chile, United Kingdom, Germany, and France. Under optimistic assumptions, the combination of PV, onshore wind or offshore wind with low temperature electrolysis is always superior to high temperature electrolysis in the long run. This is largely due to the CAPEX for low temperature electrolyzers decreasing by a larger proportion (-125% in 2050) than the CAPEX for high temperature electrolyzers (-50%) when comparing baseline to optimistic assumptions.
- Offshore wind is not competitive in terms of the global minimum LCOH. Although it yields the best RES capacity factors with values of over 0.6, hydrogen production costs from offshore wind electricity are relatively high. This is due to the high CAPEX, which cannot be offset by the higher capacity factors relative to onshore wind and PV. However, there is an advantage for offshore wind concerning the area potential. Large, high quality PV and onshore wind potentials are concentrated on specific regions around the world (e.g. MENA for PV or the US Midwest for onshore wind). The vast offshore wind potentials could therefore be particularly interesting for regions with limited onshore and unsuitable PV potential (e.g. Northern Europe or East Asia). The case studies in section 4.3 take a closer look at these regions.

Figure 3 displays sensitivities for the LCOH of PV, onshore, and offshore wind in 2050 under baseline assumptions. The sensitivity of the LCOH to RES CAPEX is lowest for PV and highest for offshore wind. CAPEX make up 41% of the total LCOH for PV, 56% for onshore, and 65% for offshore wind. The effects are exactly reversed for sensitivities to electrolyser CAPEX. Since PV has the lowest RES CAPEX, electrolyser CAPEX make up a larger portion of the total cost, and the LCOH is thus more sensitive to it changing. The effect of a WACC change on the LCOH is approximately the same for all RES. The LCOH is quite sensitive to a WACC change; a decrease of WACC from 8 to 4% would reduce the LCOH by 25%. This finding is particularly interesting because the WACC can vary between countries, significantly affecting hydrogen production costs.²⁰

²⁰According to [Vartiainen et al. \(2020\)](#), the WACC can be as low as 2.5%, reported for utility-scale PV in Germany.

Figure 3: Sensitivity analysis for production cost of hydrogen from RES in 2050

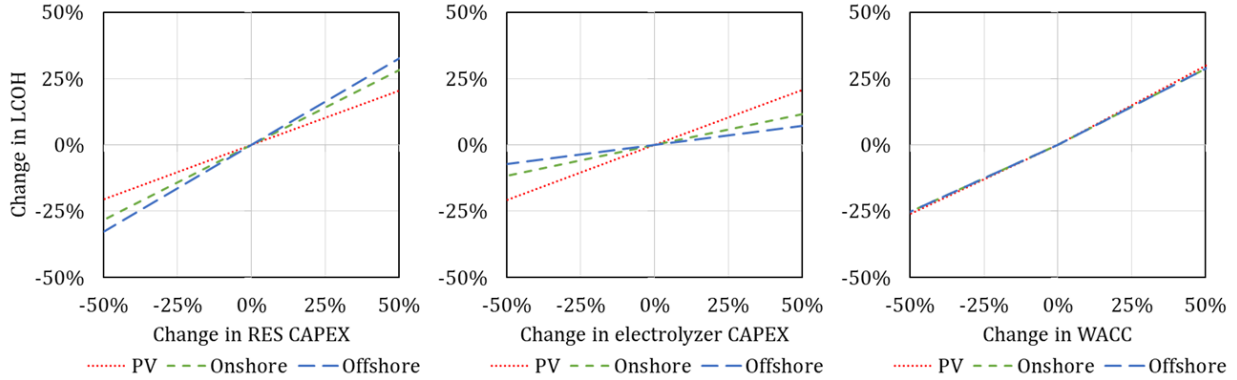

A low temperature electrolyser with CAPEX of 450\$/kW is assumed for the sensitivity analysis. Standard WACC are 8%. The PV sensitivity analysis is conducted for India PV resource class 1, the Onshore sensitivity analysis for China resource class 1 and the Offshore sensitivity analysis for Chile resource class 1. Chosen countries and resource classes represent the respective global minima of production costs for each type of RES. While changing input factors for LCOH changes the optimum S^* for installed RES-to-electrolyser ratios, ratios are held constant to simplify the sensitivity analysis. Re-optimising for changes in RES CAPEX, WACC and electrolyser CAPEX would reduce the magnitude of the effects shown by the sensitivities somewhat; however, the fundamental insights would stay the same.

4.2. Hydrogen from natural gas

Estimates for the production cost of hydrogen from natural gas reforming and pyrolysis are not as heterogeneous as those for RES-based hydrogen. Globally uniform CAPEX and a uniform utilisation of plants are assumed. Thus, cost differences between years arise only from a variation in gas prices and changes in CAPEX and CO_2 prices over time. Consequently, the LCOH does not change much over the years; instead, it varies significantly with natural gas prices. Therefore, figure 4 displays a static cost estimate for hydrogen from natural gas in 2050 as a function of the gas price. The vertical lines indicate gas prices as projected by the IEA (2019a). Accordingly, the hydrogen production costs for pyrolysis in the US would be \$1.1/kg, while costs for NGR with CCS would range between \$1.5-\$1.75/kg of hydrogen. Due to the higher projected gas prices, hydrogen production cost from pyrolysis would be \$2/kg in the EU and \$2.5/kg in Japan. In gas exporting countries, costs could be lower still. Taking the upstream and in-country transportation costs for natural gas given by the IEA (2018, p. 195) for Qatar and Russia – two of the most important natural gas producers – in 2025, gas input prices for hydrogen production could be as low as \$2/MWh in the latter and \$5/MWh in the former. These gas prices would yield hydrogen production costs of \$0.4/kg for pyrolysis and \$0.95/kg for NGR with CCS in Qatar, and \$0.6/kg for pyrolysis and \$1.2/kg NGR with CCS in Russia.

Under standard assumptions (see description of figure 5), plant CAPEX account for 22% of the LCOH for NGR and 9% of the LCOH for pyrolysis. Hydrogen production costs are thus not very sensitive to plant CAPEX, especially when compared to hydrogen from RES. Consequently, a change in the WACC is also not particularly significant; changing the WACC rate by $\pm 50\%$ changes the LCOH by $\pm 7\%$ for NGR and

Figure 4: Hydrogen production cost for NGR with CCS and pyrolysis in relation to the gas price in 2050

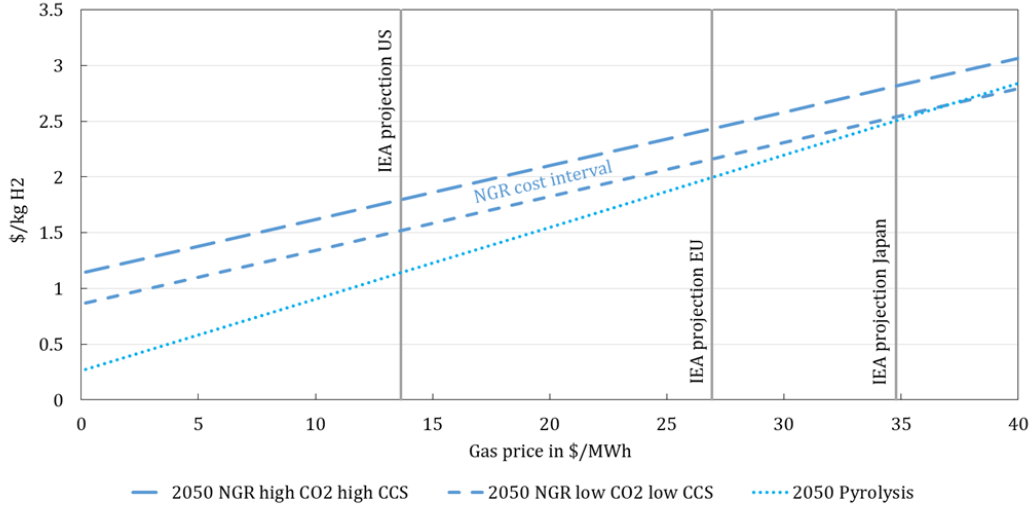

IEA gas price projections refer to [IEA \(2019a\)](#). High CO₂ high CCS refers to a CO₂ price of \$160/t and CCS cost of \$40/t while low CO₂ low CCS refers to a CO₂ price of \$145/t and CCS cost of \$10/t. The two lines mark the upper and lower limits of the possible cost interval for NGR with CCS. A solid carbon price of 0 is assumed for pyrolysis.

$\pm 3\%$ for pyrolysis. Instead, production costs are highly sensitive to the gas price. The feed gas price makes up 60% of LCOH for NGR with CCS. For pyrolysis, the gas price is even more significant, accounting for up to 87% of the LCOH. A high dependence of the LCOH on the gas price is typical for all different pyrolysis plant types.²¹ Nevertheless, the choice of a H₂-fired pyrolysis system for our analysis leads to a particularly high sensitivity to the natural gas price: It uses recovered hydrogen for heating and therefore has a lower energy efficiency than, for example, a plasma (electricity)-based pyrolysis plant.

Sensitivities to CO₂ transportation and storage costs, which are illustrated on the right side in figure 5, only play a role in LCOH of NGR with CCS. It is evident that production costs for hydrogen from NGR are not very sensitive to changes in CO₂ transportation and storage costs. For the high-cost storage scenario (\$40/t CO₂), a cost increase of 50% to \$60/t CO₂ changes the LCOH by +7%.²²

Figure 6 displays hydrogen production costs from pyrolysis as a function of a potentially positive price for the solid carbon by-product for three different gas prices of \$10, \$20 and \$30/MWh. A small change of the solid carbon price has little effect on the LCOH of pyrolysis. However, current market prices for carbon black range between \$400 and \$2000/t ([Keipi et al., 2016](#)), providing an indication why pyrolysis plants that are already in operation today have focused primarily on the production of carbon black ([Monolith, 2019](#)). For example, a carbon black price of \$500/t leads to such high revenues that the hydrogen by-product could essentially be given away for free, assuming a gas price of \$20/MWh. If solid carbon prices remain

²¹A sensitivity comparison of different pyrolysis systems can be found in [Timmerberg et al. \(2020\)](#).

²²A similar observation can be made for the sensitivity to the CO₂ price, which is even lower when the capture rate exceeds 50%.

Figure 5: Sensitivity analysis for hydrogen from natural gas

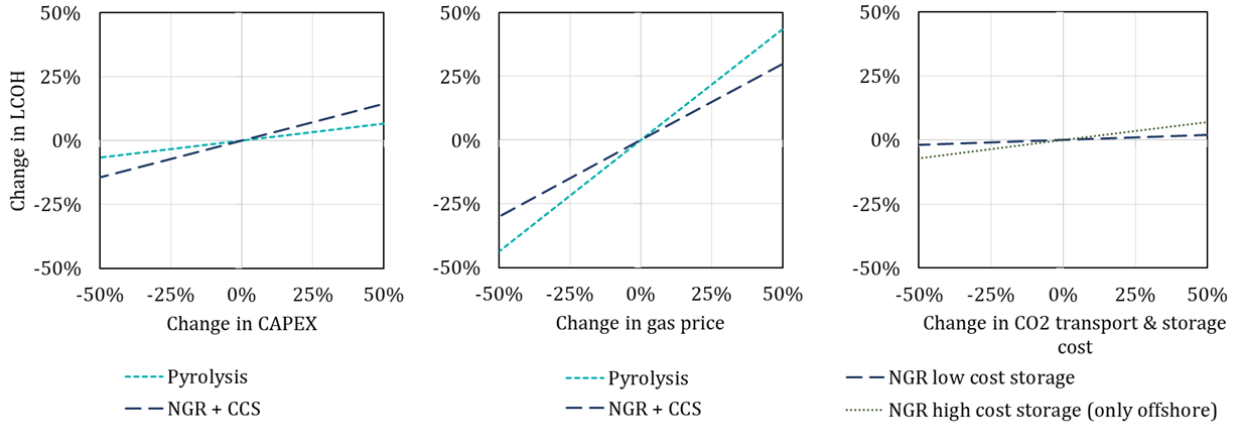

The baseline for sensitivity analysis is a Western European country (e.g. Germany) in the year 2050. Standard assumptions are CAPEX of 1280\$/kW for NGR and 457\$/kW for pyrolysis, a gas price of \$26/MWh taken from IEA (2019b) as projected for European countries, a CO₂ price of \$160/t (advanced economy assumption for 2050), low CO₂ transportation and storage cost of \$10/t, high CO₂ transportation and storage cost of \$40/t, WACC of 8%.

at current levels despite a significant scale-up of pyrolysis for hydrogen production, for instance because new markets are developed (Muradov and Veziroglu, 2005), both products – hydrogen and solid carbon – could potentially be sold at a profit. In that case, pyrolysis would most likely become the most cost-effective method to produce hydrogen in all the countries considered for this analysis. However, the inverse could occur as well: if large amounts of hydrogen are produced using pyrolysis, and new markets for solid carbon do not develop, it could be treated as waste that has to be disposed of at a cost, even though this cost is likely to be small.²³

When considering the sensitivity analysis and the high uncertainty with respect to future solid carbon prices, it can be stated that the natural gas price is the main factor determining the production costs of low-carbon hydrogen from natural gas. Plant CAPEX, as well as the cost of CO₂ transportation and storage, play a less significant role. If, for example, pyrolysis CAPEX is higher than projected by our analysis, or if CO₂ storage is initially more expensive due to small scales or legal restrictions, these cost changes would have a relatively low impact on the LCOH of natural-gas based low carbon hydrogen.

4.3. Long-term supply costs of hydrogen

This section illustrates how the costs associated with the long-distance transportation of hydrogen affect the order of the most cost-efficient hydrogen supply sources for different countries. We define supply costs as the sum of production and transportation costs. Figure 7 provides an overview of hydrogen transportation costs as a function of technology and distance. Assuming high costs for new hydrogen pipelines, transportation by ship would be more cost-effective than pipelines for distances over around

²³Solid carbon is a stable, non-toxic element that can be disposed of in landfills.

Figure 6: Sensitivity analysis for solid carbon price

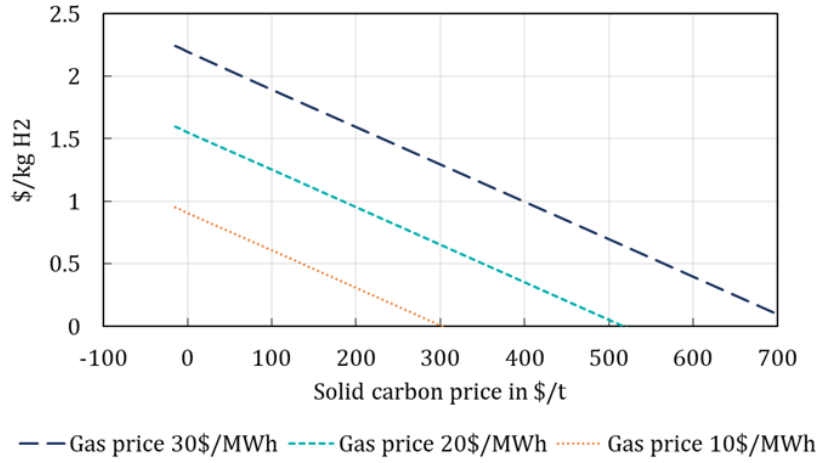

Hydrogen costs are illustrated as a function of solid carbon prices for three different gas prices. Functions are based on CAPEX of 547\$/kW and WACC of 8%.

2000km. However, if hydrogen pipelines can be built and operated at lower costs, liquefaction and LH₂ transportation by ship would be more cost-efficient only for distances of over 7000km. The least costly option for hydrogen transportation would be in converted natural gas pipelines, with costs of around 13ct to transport a kilogram of hydrogen over a distance of 1000km.

Figure 7: Comparison of options for long-distance hydrogen transportation

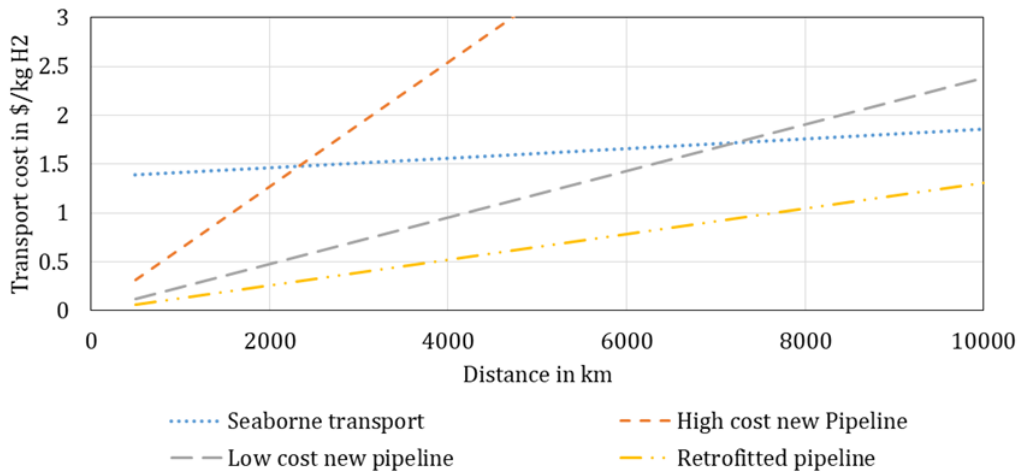

Seaborne transportation costs include the liquefaction OPEX (including electricity), export terminal CAPEX, shipping CAPEX and OPEX and import terminal CAPEX and OPEX. Pipeline transportation costs include CAPEX and OPEX and are assumed to be uniform across countries. Seaborne transportation cost are also dependent on the price of the electricity used to liquefy the cargo. The cost shown here assumes liquefaction in Saudi Arabia.

Low-carbon hydrogen production costs, transportation costs and thus supply costs vary from country to country. The next sections compares different supply cost scenarios using Germany and Japan as case

studies.²⁴ Looking at medium term (2030) costs can provide information on how the development of low-carbon hydrogen supplies might proceed most efficiently. However, a large-scale international trade of hydrogen trade will likely only emerge in the long term, if at all. Therefore, in addition to medium term trends, supply costs for the year 2050 are compared as well.

4.3.1. Germany

With its central location on the continent, Germany is well integrated into the European natural gas pipeline network. It is therefore not necessary to build an entirely new infrastructure for hydrogen transport; instead, parts of the gas network could be repurposed to carry hydrogen, which is a lower-cost option than building new, dedicated hydrogen pipelines (Wang et al., 2020). Nevertheless, despite the potentially relatively low import costs when using converted natural gas pipelines, hydrogen from RES is likely not competitive with hydrogen from natural gas reforming in the medium term (2030). Even under optimistic assumptions, the costs of renewable energy and electrolysis are too high; cost parity with gas-based hydrogen could be reached in 2030 only for gas prices exceeding \$26/MWh.²⁵ These results suggest that for the short- and medium-term development of a hydrogen economy, it is more efficient to use natural gas reforming with CCS under the given assumptions, at least as a transitional technology. In the long term however, while costs for natural gas reforming could roughly stay the same, there is still a considerable cost reduction potential for hydrogen from RES. As a result, conditions could change until 2050, with hydrogen from RES becoming more and more competitive.

Table 5: Top ten lowest-cost sources of supply of hydrogen from RES to Germany in 2050 under baseline assumptions

Country	RES resource class	RES potential (GW)	H ₂ potential (Mt/a)	LCOH (\$/kg)	H ₂ supply cost (\$/kg)	
					retrofitted pipe	new pipe
Spain	PV 2	3.9	0.2	1.7	1.9	2.6
Italy	PV 3	2.9	0.1	1.8	2.0	2.4
Norway	Onshore 1	33.8	2.7	1.8	2.0	2.7
France	Onshore 1	2.7	0.2	1.9	2.0	2.3
Greece	PV 2	16.9	0.7	1.8	2.0	2.8
Netherlands	Onshore 1	7.6	0.6	1.9	2.0	2.3
Spain	PV 3	197.6	7.4	1.8	2.0	2.7
Morocco	PV 2	355.9	14.1	1.8	2.1	3.1
Denmark	Onshore 1	1.5	0.1	2.0	2.1	2.3
Greece	PV 3	169.4	6.2	1.8	2.1	2.9

Table sorted by supply cost using retrofitted natural gas pipelines. Costs for hydrogen supplies via new pipelines are based on the high-cost pipeline assumptions from IEA (2019a).

Table 5 shows the most cost-competitive sources of supply (countries and resource classes) for hydrogen from RES to Germany in the year 2050. Two regions dominate as cost-competitive exporters of hydrogen

²⁴A third case study looking at the United States can be found in Appendix D.3.

²⁵Figure D.17 in Appendix D shows a comparison of hydrogen supply costs in Germany for the year 2030.

from RES to Germany: PV from Southern Europe, and onshore wind from North-Western Europe. The cheapest imported hydrogen supplies start at \$2/kg, including transportation in retrofitted natural gas pipelines. Building new pipelines instead changes the order of the cheapest suppliers and increases minimum costs to \$2.3/kg. With decreasing costs for pipeline transportation, distant suppliers become more competitive: Morocco and Algeria are already connected to Europe by pipeline and have large potentials for cheap PV-based hydrogen. The results also show that imports by ship are not competitive in Germany’s case, as very large RES potentials can be reached more cost-efficiently through both retrofitted natural gas and new dedicated hydrogen pipelines.

Figure 8: Comparison of hydrogen supply costs to Germany in 2050

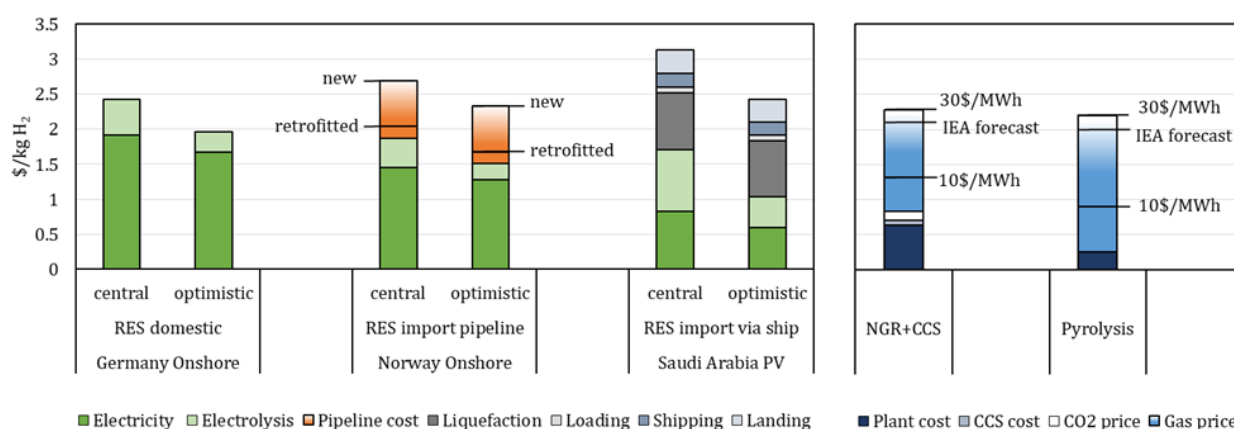

The horizontal black lines for RES imports via pipeline indicate cost levels for different types of pipeline transportation; a retrofitted natural gas pipeline as the lower bound and a high-cost new pipeline as the upper bound. The same applies for hydrogen from natural gas, where black lines indicate costs at different gas price levels. Figure D.17 in Appendix D displays the same comparison for 2030.

Figure 8 compares long-run costs for domestic and imported hydrogen from RES as well as hydrogen from natural gas. Norway is chosen as an example for pipeline imports since it is the cheapest source of pipeline supplies with significant production potential. Saudi Arabia serves as an example for countries with low hydrogen production costs that could become large-scale hydrogen exporters but are not directly connected to Germany, e.g. via pipeline. Costs of hydrogen from natural gas are illustrated as range, with the black lines indicating the LCOH for different gas price levels. When comparing potential sources for hydrogen from RES, imports are cheaper than domestic production, but only if existing natural gas pipelines can be retrofitted to carry hydrogen. Assuming high-cost new pipelines, it would be cost-competitive to produce hydrogen domestically, with onshore wind starting at \$2.3/kg under baseline assumptions. However, suitable areas for onshore wind are limited and likely required for the decarbonisation of the power sector²⁶ and Germany has poor conditions for PV-based hydrogen production. However, there is a high offshore

²⁶RES resource class Onshore 2 has a hydrogen potential of only 0.5 Mt/a.

wind potential at low water depths where large amounts of hydrogen²⁷ could be produced at relatively low cost. Domestically produced hydrogen from offshore wind would be at \$2.72/kg under baseline assumptions and \$2.14/kg for optimistic assumptions in 2050.

An interesting observation can be made when comparing hydrogen costs from Norway and Saudi Arabia: Shares of electricity and electrolyser cost in total production costs differ for PV and wind. For onshore wind in Norway, electricity costs are substantially higher than electrolyser costs, since the LCOE for onshore wind is higher than for PV. However, due to higher wind capacity factors, the electrolyser is utilised more intensively. Capital costs are then spread over a larger quantity of hydrogen, resulting in much lower costs per kilogram of hydrogen. A lower electrolysis cost makes hydrogen from onshore wind more competitive again, although, in this example, production costs for PV from Saudi Arabia are lower in both the baseline and optimistic cost scenarios. However, despite lower production costs, PV hydrogen from Saudi Arabia is not a competitive source of supply of hydrogen to Germany as transportation costs by ship are too high. Liquefaction alone costs more than 80ct/kg; the whole LH₂ transportation chain adds almost \$1.5/kg to the total supply cost.

Comparing the costs of hydrogen from RES and natural gas, it is impossible to determine with certainty which production pathway will be more cost-effective for Germany in the long run. At gas prices below \$10/MWh, NGR with CCS and pyrolysis would remain more cost-efficient than hydrogen from RES in the long-run. However, such low natural gas prices have been rare in Europe in the past. Taking the gas price assumption from the [IEA \(2019a\)](#) hydrogen report for Europe in 2050, which is \$27/MWh, hydrogen from RES could become cost-competitive under baseline assumptions when transported in retrofitted pipelines. Under optimistic assumptions, RES would be a cheaper hydrogen source than natural gas under [IEA \(2019b\)](#) price projections. Production based on domestic wind and electrolysis could also fall below \$2/kg. In conclusion, the following central findings can be recorded for Germany:

- Importing RES-based hydrogen can be a cost-efficient strategy, but only via pipeline and only if existing infrastructure can be partially converted. Possible sources of supply include low-cost onshore wind potentials in North-Western Europe (e.g. Norway) and the large PV potentials in Southern Europe and North Africa.
- Domestic production will be an efficient choice if (pipeline) import costs are high. In terms of potential, Germany could theoretically supply itself with hydrogen from RES since there are sufficiently large technical potentials to produce hydrogen from offshore wind-based electricity.

²⁷RES resource class Offshore 1 alone has a hydrogen potential of 1400 Mt/a.

- In the medium term, low-carbon hydrogen can be produced more cheaply from natural gas than from RES. NGR with CCS is likely the most cost-efficient route for an early establishment of a low-carbon hydrogen economy.
- In the long term, RES-based hydrogen could become the cheapest source of hydrogen in Germany. The most sensitive factors are RES CAPEX and the gas price. For gas prices below \$20/MWh, hydrogen from natural gas will probably remain cost-effective in the long term, especially if pyrolysis establishes itself as a market-ready technology.

4.3.2. Japan

Japan's basic economic structure is similar to that of Germany in many respects: Both are highly industrialised countries that are densely populated, both are heavily dependent on energy imports (IEA, 2019c), and both want to assume a pioneering role in the development of a hydrogen economy (METI Japan, 2020; BMWi, 2020). However, the geographical conditions of Japan differ fundamentally from those of Germany. As an island, Japan is difficult to reach and has no existing transmission lines or pipeline connections to other countries, in contrast to Germany, which is integrated into the European natural gas grid. This limits the options Japan has for sourcing RES-based low-carbon hydrogen: The country itself does not have particularly good wind or PV conditions, but as imported hydrogen has to be transported by ship, costs are so high that imports are often not worthwhile. Natural gas prices are also traditionally high in Japan, as the country relies on LNG for 100% of its supplies (IEA, 2019d). Consequently, this is reflected in a higher LCOH for hydrogen derived from natural gas. However, despite the comparatively high domestic natural gas prices, hydrogen from NGR with CCS is by far the cheapest form of production in the medium term, with a LCOH of approximately \$2.5/kg for the gas price level projected by the IEA (2019a) for 2030.²⁸ By comparison, minimum supply costs of hydrogen from RES under baseline assumptions are \$5.2/kg for domestic production and \$5.1/kg for imports.

In the long run, costs of hydrogen from RES could also decrease significantly in Japan; table 6 displays the lowest-cost sources of supply for hydrogen from RES under baseline assumptions in 2050. Despite Japan's comparably poor RES potentials, domestically produced PV-based hydrogen is almost at the top of the list because transportation by ship roughly doubles the cost of hydrogen supplied from more favourable regions with low production costs. The cheapest sources of supply of imported hydrogen from RES are mainly located in East Asia. Chinese resource classes appear to be the most promising, but the supply costs of hydrogen from China are likely underestimated. The best areas for both wind and PV are located far from the coast in Inner Mongolia. Supplying hydrogen produced in dedicated facilities to Japan would likely require an additional long-distance pipeline across the Chinese mainland to the coast, which is disregarded

²⁸For a visual comparison, see figure D.18 in Appendix D

Table 6: Top ten lowest-cost sources of supply of hydrogen from RES to Japan in 2050 under baseline assumptions

Country	RES resource class	RES potential (GW)	H ₂ potential (Mt/a)	LCOH (\$/kg)	LH ₂ shipping (\$/kg)	H ₂ supply cost (\$/kg)
China	Onshore 1	2.5	0.2	1.6	1.3	2.9
China	PV 3	1458.2	52.2	1.7	1.3	3.1
Indonesia	PV 2	3.1	0.1	1.6	1.5	3.1
Philippines	PV 3	2.4	0.1	1.7	1.4	3.1
Japan	PV 4	225.4	5.7	3.1	-	3.1
India	PV 1	4.6	0.2	1.6	1.5	3.1
Oman	PV 1	44.3	1.8	1.7	1.5	3.1
Qatar	PV 1	1.3	0.1	1.7	1.5	3.2
Saudi Arabia	PV 1	74.2	3.1	1.6	1.5	3.2
Indonesia	PV 3	32.9	1.2	1.7	1.5	3.2

in this analysis. If costs for Chinese hydrogen are higher than shown here, countries in the Middle East and Australia will move up the ranking of the lowest-cost exporters. Therefore, in addition to to China, Australia is shown as a potential hydrogen exporter to Japan in figure 9. Despite very favourable climatic conditions for PV, Australia is not one of the lowest-cost producers of PV-based hydrogen, mainly due to the comparably high domestic CAPEX for PV. Countries along the Persian Gulf, such as Oman, with very good solar potentials but comparably low PV CAPEX as well, have better starting conditions in this respect.

Figure 9: Comparison of hydrogen supply costs in Japan 2050

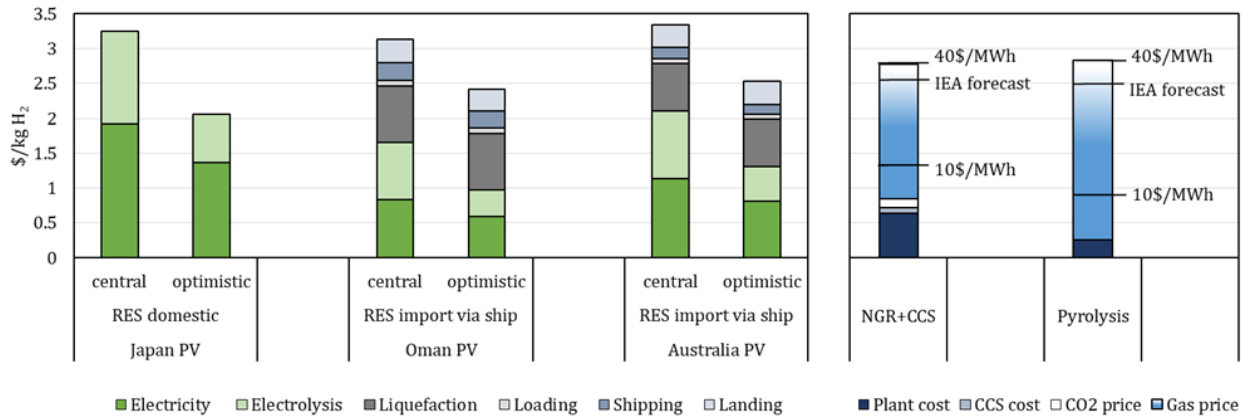

Black lines for hydrogen from natural gas indicate costs at different gas price levels. Figure D.18 in the Appendix shows a cost comparison for 2030.

Cost drivers for transport by ship are incurred mainly at the liquefaction and the landing terminal, where hydrogen is stored before final use. Above all, liquefaction of hydrogen requires a large amount of energy and is therefore very cost-intensive, whereby costs increase with the electricity price. In the Japanese case, due to the high transportation costs and the relatively poor conditions for domestic production, hydrogen from RES will probably only be competitive in the long run under optimistic assumptions. Under baseline assumptions, natural gas remains the cheaper feedstock; the LCOH of hydrogen derived from pyrolysis and

NGR with CCS are at approximately the same level for [IEA \(2019a\)](#) natural gas prices, namely at \$2.5/kg. For gas prices greater than \$35/MWh, due to the processes lower efficiency, pyrolysis-derived hydrogen becomes more expensive than hydrogen produced from NGR with CCS. If future natural gas prices remain high, natural gas reforming would be and probably remain the most cost-competitive path to produce hydrogen from natural gas also in the long run. The results of the supply cost comparison for Japan suggest the following conclusions:

- Japan has poor wind and PV potentials, and natural gas prices are traditionally quite high ([IEA, 2019d](#)). Consequently, the LCOH of domestically produced hydrogen from RES or natural gas is expected to be high by global standards.
- Raw hydrogen can only be imported by ship. Since this is a strong cost driver, importing pure hydrogen is not cost-efficient, despite the high cost of domestic production.
- In the medium term, hydrogen from RES is not competitive even at high gas prices. It also seems likely that hydrogen production from natural gas will remain the cheaper form of low-carbon hydrogen in the long run.
- In general, higher hydrogen costs can be expected in Japan than in other industrialised countries.

4.4. Summary

Results from the two case studies provide an insight into how costs and most efficient supply pathways of hydrogen can differ globally. Factors leading to low hydrogen supply costs are low gas prices, favourable areas for domestic RES production, or connections to low-cost hydrogen exporters via existing pipelines. The comparison of hydrogen from RES and natural gas shows that natural gas reforming is most likely more cost-efficient than electrolysis in the medium term. In the long run, hydrogen from RES has the potential to become cost competitive in regions with favourable wind or solar potentials, specially if capital costs for RES and electrolyzers decrease significantly. However, natural gas-based hydrogen may still retain a cost advantage in regions with poor access to renewable resources, in particular if production costs further decline through the use of pyrolysis. An additional point worth mentioning is that, at least in the medium term, RES electricity may not be available in substantial volumes for electrolysis, as long as additional RES capacities are needed for the decarbonisation of the power sector. In the transition period towards an energy system based largely on renewables, hydrogen and the power sector could compete for electricity from RES ([Dickel, 2020](#)).²⁹ For a rapid and efficient expansion of low-carbon hydrogen production, hydrogen from natural gas reforming with CCS would then be required to serve at least as a transitional technology. Long-term cost advantages for hydrogen from natural gas could remain in some regions, especially if production

²⁹This aspect is discussed in more detail in the next section.

becomes even cheaper through the use of pyrolysis. However, there is a chance that electrolysis will become competitive in the long run for regions with favourable wind or solar conditions, especially if capital costs for RES and electrolyzers decrease significantly.

5. Discussion

Supply cost estimates alone cannot provide a final prognosis of the future hydrogen market structure. Still, some general conclusions can be drawn from our analysis. The country case studies in section 4.3 shed some light on how cost-efficient supply choices differ between countries and what the order of the supply curve in a country's domestic hydrogen market could be. Above all, our results suggest that a mix of production pathways would emerge in the low-carbon hydrogen market, where hydrogen from RES as well as hydrogen from natural gas will each serve significant parts of global demand.³⁰ Shares of hydrogen from natural gas and RES could differ substantially between countries and compared to the global average. A country's local natural gas price will likely determine whether hydrogen from natural gas has a cost advantage in the long run. From a cost perspective, imports of hydrogen from RES will only become competitive where low production costs go hand in hand with low transport costs. The supply cost analysis shows that shipping in particular increases hydrogen costs. Therefore, it seems likely that regional markets will emerge for low-carbon hydrogen trade, with hydrogen pipeline networks as the most essential transportation infrastructure. A similar regional segmentation can be observed in the natural gas market, even though LNG shipping has made the long-distance seaborne transportation of natural gas more economically feasible and in recent years led to a degree of convergence in global gas prices (Schulte, 2019). Like in some natural gas markets, such as Europe, individual exporters with good RES potentials and a location advantage may attain large market shares within these regional hydrogen markets, potentially leading to high market concentration. In addition to that, economies of scale in hydrogen exports could favour market concentration: The transportation costs derived for this analysis are for large scale infrastructure, which must be used at full capacity so that costs are not higher than assumed in the estimates.

While we did not explicitly model a pessimistic cost development trajectory for RES and electrolyzers, there are conclusions that can be drawn with respect to such a scenario. Some analyses show that the energy return on energy invested (EROI) of the global energy system will fall as energy dense fossil fuels are phased out in favour of less energy dense renewables. A fall in the EROI would result in an increase in the materials intensity of the global economy, as more infrastructure is needed to harvest the energy required (Capellán-Pérez et al., 2019). A consequence of such a shift could be a smaller decline in RES CAPEX than currently anticipated, or a tapering off of the ongoing cost decline, followed by a subsequent

³⁰Hydrogen from coal gasification with CCS or nuclear energy could also play a role. However, costs for these technologies are not estimated in the analysis.

increase. Looking at the near-term baseline assumptions, a more pessimistic cost trajectory for RES would preserve the cost advantage which natural-gas based hydrogen production pathways currently enjoy in all of the major economies.

However, there are some important limitations to the analysis presented in this paper, providing an opening for further research.

Firstly, we treat hydrogen production as a closed system, a necessary assumption to simplify cost estimates for the large number of countries considered. In reality however, hydrogen production is integrated into the overall energy market. Gas demand and prices do not only depend on hydrogen production, and renewable energy facilities do not produce electricity solely for electrolysis. On the flip side, large-scale hydrogen production from natural gas will have an impact on the gas price, and a large-scale deployment of RES-based electrolysis will compete with alternative uses for the RES. Therefore, a decision to produce hydrogen depends on the opportunity costs and, thus, on the revenue from alternative uses of gas and electricity. In reality, an investment decision would only be made if the expected profit, including opportunity costs, is greater than zero. Obvious opportunity costs for hydrogen from RES are the profits associated with the alternative of feeding the electricity into the grid. In our analysis, renewable energy systems do not interact with the power sector, whereas in reality, a link between hydrogen production from RES and the power sector will likely exist in many cases³¹. When the RES is also connected to the grid, market prices for electricity and hydrogen would determine the optimal distribution between hydrogen and electricity production. In theory, for given prices, this optimal combination of electricity and hydrogen would be determined by the tangential point of the plant's production possibility frontier,³² and the community indifference curve (Samuelson, 1956) of a country. In practice, this would mean that the plant operator, depending on current market prices for hydrogen and electricity, would decide in a profit-maximising manner which commodity should be produced. The fact that renewable electricity could have to supply both the power sector and hydrogen production also creates a rival-use problem. The RES potentials used for our analysis are theoretical and do not consider competing use. In reality, hydrogen electrolysis directly competes for renewable electricity with alternative decarbonisation options, such as the electrification of the industrial, transport, or heating sectors. Due to the increasing demand for electricity in these sectors, renewable electricity demand could increase despite the efficiency gains in end-use applications. In the transition period towards decarbonisation, renewable electricity could therefore become scarce. For example, Germany has a target of covering 65% of gross electricity demand with renewable sources by 2030, which could be missed as the expansion of renewable generation cannot keep up with the increase in electricity demand (Gierkink and Sprenger, 2020).

³¹Unless the hydrogen production facility is sited in a remote location that makes a connection to the power grid prohibitively expensive.

³²which depends on each plant's electrolyser efficiency

According to [Dickel \(2020\)](#), decarbonisation of the electricity sector should be prioritised over hydrogen production, since electricity use is possible without efficiency losses. Therefore, in the medium term, there is a possibility that in some regions, not enough surplus RES capacity will be available to serve the hydrogen market. If more ambitious targets for renewable power and hydrogen were to be maintained or set regardless, hydrogen from natural gas would remain an obvious medium-term substitution option.

Secondly, an additional limitation of this analysis is that we do not consider in-country transportation costs in all cases. This may be an issue for seaborne exporters, where good RES potentials are located inland, but terminals have to be sited along the coast. As shown in section [4.3.2](#), China is such a case. As a result, the hydrogen supply costs of such exporters are likely underestimated in our analysis. Furthermore, we do not consider costs associated with the distribution of hydrogen to end users in the receiving country. This, however, is an issue for both imports and local production, and should not greatly affect the relative cost differentials between the two.

Lastly, depending on the end-use, it may not always make sense to transport pure hydrogen. Demand for low-carbon hydrogen will also consist of various hydrogen-based energy carriers, such as synthetic gases or fuels. For some of these energy carriers, such as ammonia, there is already a significant demand; for others, demand could rise rapidly in the future ([IEA, 2019b](#)). Areas with the lowest production costs are roughly the same for hydrogen and hydrogen-based energy carriers since the feedstocks remain the same. Nevertheless, transportation costs and end-use locations could change, which would impact investment decisions and affect market structures. For example, in Saudi Arabia, an investment decision for a plant that produces ammonia directly from renewable energy has recently been made ([Di Paola, 2020](#)). If ammonia is used directly, transportation in the form of ammonia is cheaper than in the form of LH₂ ([Wijayanta et al., 2019](#)). An extension of the model would be necessary to estimate the cost-effective provision of all hydrogen-based energy carriers.

Some of these limitations could be addressed through the following extensions to our analysis:

- A more sophisticated geospatial analysis of each of the 96 countries considered in this paper, linking RES potentials to elements of a hydrogen production, transmission and distribution infrastructure in a cost-efficient manner, could result in more detailed and robust cost estimates for RES-based hydrogen.
- Integrating the supply cost curves derived in this analysis into an integrated global model of the natural gas and hydrogen markets, which would allow for the derivation of more robust insights on future hydrogen prices, infrastructure developments, exporters and market structures, as well as shed light on the potential interaction between natural gas-based hydrogen production and the global natural gas market.

- Explicitly modelling demand, production and transportation options for hydrogen derivatives (ammonia, methanol etc.) on top of pure hydrogen would allow for a more comprehensive assessment of cost and supply structures.

6. Conclusion

In the paper at hand, we present a comprehensive approach to estimate long-term production and supply costs of low-carbon hydrogen from renewable energy sources and natural gas. Costs for hydrogen from renewable energy sources are estimated using global data for wind and PV potential combined with low and high temperature electrolyzers. A linear optimisation model determines optimal combinations of RES and electrolyser technologies; the cost-minimising utilisation of the electrolyser is calculated for given investment costs based on hourly RES capacity factor profiles. As an alternative to electrolysis, we also consider the production of hydrogen via natural gas reforming with CCS and pyrolysis. After defining potential transport routes, long-term supply costs of all potential production possibilities are compared in case studies for Germany and Japan to approximate cost-optimal provision schemes. The central findings of this analysis are as follows:

- In terms of production cost, hydrogen from natural gas will most likely have a cost advantage in the medium term, making it the most cost-efficient supply route for the ramp-up of a low-carbon hydrogen market.
- In the long run, the production of hydrogen from RES could become cost-competitive as RES and electrolyser capital costs decrease significantly. Under optimistic assumptions, minimum production costs could fall to below \$1/kg_{H₂} in some regions.
- Country-level supply cost results vary significantly between regions. Optimal long-term hydrogen supply choices depend on regional conditions, such as domestic RES potentials and the availability of pipeline infrastructure that can be converted to hydrogen.
- Where possible, retrofitted pipelines provide a low-cost opportunity for hydrogen transport, increasing the feasibility of hydrogen trade. Due to the high cost of transporting hydrogen by ship, hydrogen trade will most likely be pipeline-based and thus concentrated regionally.
- Results are sensitive to several assumptions. The most sensitive factors for production costs of hydrogen from RES are WACC and investment costs of electrolyzers and RES. The total cost for hydrogen from natural gas mainly consists of costs for the feedstock. For pyrolysis, positive revenues for the solid carbon by-product could further reduce production costs.

Furthermore, it should be noted that the approach chosen for this analysis has some limitations; these could be resolved in an extension of the model: Hydrogen could also be obtained from other sources that are currently not considered, such as nuclear electricity or coal gasification with CCS. Furthermore, supply costs are estimated exclusively for hydrogen; however, other hydrogen-based fuels are projected to make up a major part of future demand (IEA, 2020). Finally, hydrogen production is regarded as a closed system. Yet, within the framework of sectoral coupling, interactions in the entire energy sector will be decisive to determine the efficient allocation of energy resources in the future. Interdependencies between the emerging hydrogen and the established natural gas market would also have to be considered. Extending the presented approach along the angles mentioned above would further improve the results' significance and should be addressed in further research.

Acknowledgements

Financial support for this research by the “Research Programme Hydrogen: The Role of Gas in the Energy Transition”, an initiative of the Society of Benefactors to the EWI (Gesellschaft zur Förderung des EWI e.V) is gratefully acknowledged. We thank Marc Oliver Bettzüge, professor of energy economics and director of the Institute of Energy Economics at the University of Cologne (EWI) for his guidance and support. We also thank David Schlund for his valuable feedback.

References

- P. T. Aakko-Saksa, C. Cook, J. Kiviaho, and T. Repo. Liquid organic hydrogen carriers for transportation and storing of renewable energy – Review and discussion. *Journal of Power Sources*, 396(February):803–823, 2018. ISSN 03787753. doi: 10.1016/j.jpowsour.2018.04.011. URL <https://doi.org/10.1016/j.jpowsour.2018.04.011>.
- A. Abánades, C. Rubbia, and D. Salmieri. Thermal cracking of methane into Hydrogen for a CO₂-free utilization of natural gas. *International journal of hydrogen e nergy*, 38:8491–8496, 2013. doi: 10.1016/j.ijhydene.2012.08.138.
- Agora Verkehrswende, Agora Energiewende, and Frontier Economics. The Future Cost of Electricity-Based Synthetic Fuels. Technical Report 12.02.2018, 2018. URL https://www.agora-energiewende.de/fileadmin/Projekte/2017/SynKost_2050/Agora_SynCost-Studie_WEB.pdf.
- S. Alberth. Forecasting technology costs via the experience curve - Myth or magic? *Technological Forecasting and Social Change*, 75(7):952–983, 2008. ISSN 00401625. doi: 10.1016/j.techfore.2007.09.003.
- F. Ausfelder, A. M. Bazzanella, A. Möller, R. Geres, A. Kohn, and S. Lenz. *Roadmap Chemie 2050: Auf dem Weg zu einer treibhausgasneutralen chemischen Industrie in Deutschland*, volume 61. FutureCamp Climate GmbH, Munich, Frankfurt, 2019. ISBN 9783897462236. doi: 10.1007/s11616-016-0302-8.
- J. R. Bartels. *A feasibility study of implementing an Ammonia Economy. Graduate Theses and Dissertations. 11132*. PhD thesis, Iowa State University, 2008.
- S. Bertoli, M. Goujon, and O. Santoni. The CERDI-seadistance database. Technical report, Études et Documents, n° 7, CERDI, 2016.
- BMWi. Die Nationale Wasserstoffstrategie. Technical report, Bundesministerium für Wirtschaft und Energie (BMWi), 2020. URL <https://www.bmwi.de/Redaktion/DE/Publikationen/Energie/die-nationale-wasserstoffstrategie.html>.
- BNEF. New Energy Outlook 2019. Technical report, Bloomberg New Energy Finance, London, 2019.
- BNEF. Hydrogen Economy Outlook. Technical report, Bloomberg New Energy Finance, 2020.
- A. Bode. New process for clean hydrogen - BASF research press conference 2019. Technical report, 2019.
- J. Bosch, I. Staffell, and A. D. Hawkes. Temporally-explicit and spatially-resolved global onshore wind energy potentials. *Energy*, 131:207–217, 2017. ISSN 03605442. doi: 10.1016/j.energy.2017.05.052. URL <http://dx.doi.org/10.1016/j.energy.2017.05.052>.
- J. Bosch, I. Staffell, and A. D. Hawkes. Global levelised cost of electricity from offshore wind. *Energy*, 189(October), 2019. ISSN 03605442. doi: 10.1016/j.energy.2019.116357.
- C. Breyer. Economics of hybrid photovoltaics power plants. *27th European Photovoltaic Solar Energy Conference and Exhibition*, 49, 2012.
- U. Caldera and C. Breyer. Learning Curve for Seawater Reverse Osmosis Desalination Plants: Capital Cost Trend of the Past, Present, and Future. *Water Resources Research*, 53(12):10523–10538, 2017. ISSN 19447973. doi: 10.1002/2017WR021402.
- U. Caldera, D. Bogdanov, S. Afanasyeva, and C. Breyer. Role of Seawater Desalination in the Management of an Integrated Water and 100 % Renewable Energy Based Power Sector in Saudi Arabia. *Water*, 10(3), 2018. doi: 10.3390/w10010003.
- I. Capellán-Pérez, C. de Castro, and L. J. Miguel González. Dynamic Energy Return on Energy Investment (EROI) and material requirements in scenarios of global transition to renewable energies. *Energy Strategy Reviews*, 26(September 2018): 100399, 2019. ISSN 2211467X. doi: 10.1016/j.esr.2019.100399. URL <https://doi.org/10.1016/j.esr.2019.100399>.
- CE Delft. Feasibility study into blue hydrogen. pages 0–46, 2018.
- Chemie Technik. Evonik will grünen Wasserstoff günstiger machen, 2020. URL <https://www.chemietechnik.de/evonik-will-gruenen-wasserstoff-guenstiger-machen/>.
- L. Collins. Low-cost, clean hydrogen from underground oil fires could kill off green H₂ sector, 2020. URL <https://www.rechargenews.com/transition/low-cost-clean-hydrogen-from-underground-oil-fires-could-kill-off-green-h2-sector/2-1-752473>.
- S. Comello, S. Reichelstein, and A. Sahoo. The road ahead for solar PV power. *Renewable and Sustainable Energy Reviews*, 92(May):744–756, 2018. ISSN 18790690. doi: 10.1016/j.rser.2018.04.098. URL <https://doi.org/10.1016/j.rser.2018.04.098>.
- A. M. Cormos, S. Szima, S. Fogarasi, and C. C. Cormos. Economic assessments of hydrogen production processes based on natural gas reforming with carbon capture. *Chemical Engineering Transactions*, 70:1231–1236, 2018. ISSN 22839216. doi: 10.3303/CET1870206.
- T. Costa. Forecasting the Cost of Electricity Generated by Offshore Wind Turbines. (July), 2019.
- R. A. Dagle, V. Dagle, M. D. Bearden, J. D. Holladay, T. R. Krause, and S. Ahmed. An Overview of Natural Gas Conversion Technologies for Co-Production of Hydrogen and Value-Added Solid Carbon Products. (No. PNNL-26726; ANL-17/11). *Pacific Northwest National Lab.(PNNL), Richland, WA (United States); Argonne National Lab.(ANL), Argonne, IL (United States)*., page p. 65, 2017. doi: 10.2172/1411934. URL <http://www.osti.gov/servlets/purl/1411934/>.
- J. De Castro, R. Rivera-Tinoco, and C. Bouallou. Hydrogen production from natural gas: Auto-Thermal Reforming and CO₂ capture. *Chemical Engineering Transactions*, 21(May 2014):163–168, 2010. ISSN 22839216. doi: 10.3303/CET1021028.
- A. Di Paola. Air Products Plans \$5 Billion Green Fuel Plant in Saudi Arabia, 2020. URL <https://www.bloombergenews.com/news/articles/2020-07-07/air-products-to-build-5-billion-ammonia-plant-in-new-saudi-city>.
- R. Dickel. Blue hydrogen as an enabler of green hydrogen : the case of Germany. 2020.
- DNV GL. Energy Transition Outlook 2019: A global and regional forecast to 2050. Technical report, 2019.
- EERE. Hydrogen Production: Electrolysis (Office of Energy Efficiency and Renewable Energy), 2020. URL <https://www.energy.gov/eere/fuelcells/hydrogen-production-electrolysis>.
- R. S. El-Emam and H. Özcan. Comprehensive review on the techno-economics of sustainable large-scale clean hydrogen production. *Journal of Cleaner Production*, 220:593–609, 2019. ISSN 09596526. doi: 10.1016/j.jclepro.2019.01.309.

- ERIA. The Potential and Costs of Hydrogen Supply. In *Kimura, S. and Y. Li (eds.), Demand and Supply Potential of Hydrogen Energy in East Asia*, number 01, chapter 4, pages 140–183. ERIA Research Project Report FY2018, Jakarta, 2019.
- ETIP-PV. Fact Sheets about photovoltaics. Technical report, European Technology & Innovation Platform, 2019.
- European Commission. Hydropower Factsheet. pages 6–9, 2013. URL https://setis.ec.europa.eu/system/files/Technology_Information_Sheet_Hydropower.pdf.
- European Commission. HORIZON 2020 WORK PROGRAMME 2016–2017 - 20 . General Annexes (European Commission Decision C (2017) 2468 of 24 April 2017). (April 2017), 2017.
- European Commission. A hydrogen strategy for a climate-neutral Europe. Technical report, Brussels, 2020.
- M. Fasihi and C. Breyer. Baseload electricity and hydrogen supply based on hybrid PV-wind power plants. *Journal of Cleaner Production*, 243:118466, 2020. ISSN 09596526. doi: 10.1016/j.jclepro.2019.118466. URL <https://doi.org/10.1016/j.jclepro.2019.118466>.
- M. Fasihi, D. Bogdanov, and C. Breyer. Techno-Economic Assessment of Power-to-Liquids (PtL) Fuels Production and Global Trading Based on Hybrid PV-Wind Power Plants. *Energy Procedia*, 99(March):243–268, 2016. ISSN 18766102. doi: 10.1016/j.egypro.2016.10.115. URL <http://dx.doi.org/10.1016/j.egypro.2016.10.115>.
- O. Florisson. Naturally preparing for the hydrogen economy by using the existing natural gas system as catalyst. *Final publishable activity report, NV Nederlandse Gasunie Google Scholar*, 2010.
- Fraunhofer ISE. Photovoltaics Report. Technical Report June, Freiburg, 2020.
- C. Fúnez Guerra, L. Reyes-Bozo, E. Vyhmeister, M. Jaén Caparrós, J. L. Salazar, and C. Clemente-Jul. Technical-economic analysis for a green ammonia production plant in Chile and its subsequent transport to Japan. *Renewable Energy*, 157: 404–414, 2020. ISSN 18790682. doi: 10.1016/j.renene.2020.05.041.
- M. Gautier, V. Rohani, and L. Fulcheri. Direct decarbonization of methane by thermal plasma for the production of hydrogen and high value-added carbon black. *International Journal of Hydrogen Energy*, 42(47):28140–28156, 2017. ISSN 03603199. doi: 10.1016/j.ijhydene.2017.09.021.
- R. v. Gerwen, M. Eijgelaar, and T. Bosma. Hydrogen in the Electricity Value Chain. *Group Technology and Research, Position Paper 2019*, 2019.
- M. Gierkink and T. Sprenger. Die Auswirkungen des Klimaschutzprogramms 2030 auf den Anteil erneuerbarer Energien an der Stromnachfrage. Technical report, Energiewirtschaftliches Institut an der Universität zu Köln (EWI), Cologne, 2020. URL <https://www.ewi.uni-koeln.de/cms/wp-content/uploads/2020/01/EWI-Analyse-Anteil-Erneuerbare-in-2030-final.pdf>.
- G. Glenk and S. Reichelstein. Economics of converting renewable power to hydrogen. *Nature Energy*, 2019. ISSN 2058-7546. doi: 10.1038/s41560-019-0326-1. URL <http://dx.doi.org/10.1038/s41560-019-0326-1>.
- V. A. Goltsov and T. N. Veziroglu. From hydrogen economy to hydrogen civilization. *International Journal of Hydrogen Energy*, 26(9):909–915, 2001. ISSN 03603199. doi: 10.1016/S0360-3199(01)00045-3.
- M. Götz, J. Lefebvre, F. Mörs, A. McDaniel Koch, F. Graf, S. Bajohr, R. Reimert, and T. Kolb. Renewable Power-to-Gas: A technological and economic review. *Renewable Energy*, 85:1371–1390, 2016. ISSN 18790682. doi: 10.1016/j.renene.2015.07.066.
- C. Hebling, M. Ragwitz, T. Fleiter, U. Groos, D. Härle, A. Held, M. Jahn, and N. Müller. Eine Wasserstoff-Roadmap für Deutschland. 2019. URL <https://www.ise.fraunhofer.de/de/presse-und-medien/presseinformationen/2020/fraunhofer-wasserstoff-roadmap.html>.
- G. Hendriks, Chris; Wina and F. V. Bergen. Global Carbon Dioxide Storage Potential and Costs. *Report*, (May), 2004. URL <http://Users/Gebruiker/Downloads/GlobalCCScurves.PDF>.
- P.-M. Heuser, D. S. Ryberg, T. Grube, M. Robinius, and D. Stolten. Techno-economic analysis of a potential energy trading link between Patagonia and Japan based on CO2 free hydrogen. *International Journal of Hydrogen Energy*, 44(25):12733–12747, 2019. ISSN 03603199. doi: 10.1016/j.ijhydene.2018.12.156. URL <https://doi.org/10.1016/j.ijhydene.2018.12.156>.
- P.-M. Heuser, T. Grube, H. Heinrichs, M. Robinius, and D. Stolten. Worldwide Hydrogen Provision Scheme Based on Renewable Energy. 2020. URL www.preprints.org.
- Hydrogen Council. Hydrogen scaling up : A sustainable pathway for the global energy transition. *Hydrogen scaling up: A sustainable pathway for the global energy transition*, (November):80, 2017.
- IEA. World Energy Outlook 2018. Technical report, Paris, 2018. URL <https://www.iea.org/reports/world-energy-outlook-2018>.
- IEA. Annex to the IEA G20 Hydrogen report: Assumptions. Technical report, Paris, 2019a.
- IEA. The Future of Hydrogen. Technical Report June, Paris, 2019b.
- IEA. World Energy Outlook 2019. Technical report, Paris, 2019c. URL <https://www.iea.org/reports/world-energy-outlook-2019>.
- IEA. Natural Gas Information 2019. Technical report, International Energy Agency, Paris, 2019d.
- IEA. Energy Technology Perspectives 2020. Technical report, Paris, 2020. URL https://www.oecd-ilibrary.org/energy/energy-technology-perspectives-2020_ab43a9a5-en.
- IRENA. Renewable Energy Techlogies: Cost Analysis Series, Hydropower. Technical Report 3/5, Abu Dhabi, 2012. URL https://www.irena.org/documentdownloads/publications/re_technologies_cost_analysis-hydropower.pdf.
- IRENA. Hydrogen From Renewable Power: Technology outlook for the energy transition. Technical Report September, Abu Dhabi, 2018. URL <https://www.irena.org/publications/2018/Sep/Hydrogen-from-renewable-power>.
- IRENA. Hydrogen: A renewable energy perspective. Technical Report September, Abu Dhabi, 2019a.
- IRENA. Global Energy Transformation: A Roadmap to 2050. Technical report, Abu Dhabi, 2019b. URL <https://irena.org/publications/2019/Apr/Global-energy-transformation-A-roadmap-to-2050-2019Edition>.

- IRENA. IRENA Global Renewables Outlook. Technical report, Abu Dhabi, 2020a. URL <https://www.irena.org/publications/2020/Apr/Global-Renewables-Outlook-2020>.
- IRENA. Renewable Power Generation Costs in 2019. Technical report, Abu Dhabi, 2020b. URL <https://www.irena.org/publications/2020/Jun/Renewable-Power-Costs-in-2019>.
- H. Ishaq and I. Dincer. Analysis and optimization for energy, cost and carbon emission of a solar driven steam-autothermal hybrid methane reforming for hydrogen, ammonia and power production. *Journal of Cleaner Production*, 234:242–257, 2019. ISSN 09596526. doi: 10.1016/j.jclepro.2019.06.027. URL <https://doi.org/10.1016/j.jclepro.2019.06.027>.
- ITRPV. International Technology Roadmap for Photovoltaic (ITRPV), 2019 Results. Technical Report April, 2020. URL <https://itrvp.vdma.org/en/ueber-uns>.
- M. Jensterle, J. Narita, R. Piria, S. Samadi, M. Prantner, S. Siegemund, S. Kan, T. Matsumoto, Y. Shibata, and J. Thesen. The role of clean hydrogen in the future energy systems of Japan and Germany. Technical Report September, adelphi, 2019.
- M. Jensterle, J. Narita, R. Piria, J. Schröder, K. Steinbacher, F. Wahabzada, T. Zelle, K. Crone, and S. Löchle. Grüner Wasserstoff : Internationale Kooperations- potenziale für Deutschland. Technical report, adelphi, dena, GIZ, Navigant, Berlin, 2020.
- M. Junginger, E. Hittinger, E. Williams, and R. Wiser. *Onshore wind energy. Technological Learning in the Transition to a Low-Carbon Energy System*, volume 33. Elsevier Inc., 2020a. ISBN 9780128187623. doi: 10.1016/b978-0-12-818762-3.00006-6. URL <http://dx.doi.org/10.1016/B978-0-12-818762-3.00006-6>.
- M. Junginger, A. Louwen, N. G. Tuya, D. D. Jager, E. V. Zuijlen, and M. Taylor. *Offshore wind energy. Technological Learning in the Transition to a Low-Carbon Energy System*. Elsevier Inc., 2020b. ISBN 9780128187623. doi: 10.1016/B978-0-12-818762-3.00007-8. URL <http://dx.doi.org/10.1016/B978-0-12-818762-3.00007-8>.
- C. M. Kalamaras and A. M. Efstathiou. Hydrogen Production Technologies: Current State and Future Developments. *Conference Papers in Energy*, 2013:1–9, 2013. doi: 10.1155/2013/690627.
- S. Kamiya, M. Nishimura, and E. Harada. Study on introduction of CO₂ free energy to Japan with liquid hydrogen. *Physics Procedia*, 67:11–19, 2015. ISSN 18753892. doi: 10.1016/j.phpro.2015.06.004. URL <http://dx.doi.org/10.1016/j.phpro.2015.06.004>.
- Kawasaki Heavy Industries. From LNG Carriers to Liquefied Hydrogen Carriers, 2015. URL <https://global.kawasaki.com/en/stories/articles/vol18/>.
- T. Keipi, K. E. S. Tolvanen, H. Tolvanen, and J. Konttinen. Thermo-catalytic decomposition of methane : The effect of reaction parameters on process design and the utilization possibilities of the produced carbon. *Energy Conversion and Management*, 126:923–934, 2016. ISSN 0196-8904. doi: 10.1016/j.enconman.2016.08.060. URL <http://dx.doi.org/10.1016/j.enconman.2016.08.060>.
- T. Keipi, H. Tolvanen, and J. Konttinen. Economic analysis of hydrogen production by methane thermal decomposition: Comparison to competing technologies. *Energy Conversion and Management*, 159(December 2017):264–273, 2018. ISSN 0196-8904. doi: 10.1016/j.enconman.2017.12.063. URL <https://doi.org/10.1016/j.enconman.2017.12.063>.
- Y. S. Khojasteh, B. A. Saville, and H. L. MacLean. Techno-economic analysis and life cycle assessment of hydrogen production from natural gas using current and emerging technologies. *International Journal of Hydrogen Energy*, 42(30):18894–18909, 2017. ISSN 03603199. doi: 10.1016/j.ijhydene.2017.05.219. URL <http://dx.doi.org/10.1016/j.ijhydene.2017.05.219>.
- Y. Kojima. Hydrogen storage materials for hydrogen and energy carriers. *International Journal of Hydrogen Energy*, 44(33):18179–18192, 2019. ISSN 03603199. doi: 10.1016/j.ijhydene.2019.05.119. URL <https://doi.org/10.1016/j.ijhydene.2019.05.119>.
- V. Krey, F. Guo, P. Kolp, W. Zhou, R. Schaeffer, A. Awasthy, C. Bertram, H. S. de Boer, P. Fragkos, S. Fujimori, C. He, G. Iyer, K. Keramidis, A. C. Köberle, K. Oshiro, L. A. Reis, B. Shoai-Tehrani, S. Vishwanathan, P. Capros, L. Drouet, J. E. Edmonds, A. Garg, D. E. Gernaat, K. Jiang, M. Kannavou, A. Kitous, E. Kriegler, G. Luderer, R. Mathur, M. Muratori, F. Sano, and D. P. van Vuuren. Looking under the hood: A comparison of techno-economic assumptions across national and global integrated assessment models. *Energy*, 172:1254–1267, 2019. ISSN 03605442. doi: 10.1016/j.energy.2018.12.131.
- O. Machhammer, A. Bode, W. Hormuth, and C. Kg. Financial and Ecological Evaluation of Hydrogen Production Processes on Large Scale. (6):1185–1193, 2016. doi: 10.1002/ceat.201600023.
- O. Machhammer, H.-J. Maaß, and A. Bode. Erzeugung von Strom und flüssigen Kraftstoffen mit geringem Carbon Footprint. (1):212–225, 2018. doi: 10.1002/cite.201700137.
- B. V. Mathiesen, I. Ridjan, D. Connolly, M. P. Nielsen, P. Vang Hendriksen, and S. D. E. S. Bjerg Mogensen, Mogens; Højgaard Jensen. Technology data for high temperature solid oxide electrolyser cells , alkali and PEM electrolysers. Technical report, Aalborg University, 2013.
- I. Mauleón. Photovoltaic learning rate estimation: Issues and implications. *Renewable and Sustainable Energy Reviews*, 65:507–524, 2016. ISSN 18790690. doi: 10.1016/j.rser.2016.06.070. URL <http://dx.doi.org/10.1016/j.rser.2016.06.070>.
- I. Mauleón. Assessing PV and wind roadmaps: Learning rates, risk, and social discounting. *Renewable and Sustainable Energy Reviews*, 100:71–89, 2019. ISSN 1364-0321. doi: 10.1016/j.rser.2018.10.012. URL <https://doi.org/10.1016/j.rser.2018.10.012>.
- A. Mayyas and M. Mann. Emerging Manufacturing Technologies for Fuel Cells and Electrolyzers. *Procedia Manufacturing*, 33:508–515, 2019. ISSN 2351-9789. doi: 10.1016/j.promfg.2019.04.063. URL <https://doi.org/10.1016/j.promfg.2019.04.063>.
- A. McDonald and L. Schratzenholzer. Learning rates for energy technologies. *Energy Policy*, 29(4):255–261, 2001. ISSN 03014215. doi: 10.1016/S0301-4215(00)00122-1.
- D. H. Meadows and Club of Rome. *The Limits to growth; a report for the Club of Rome's project on the predicament of mankind*. Universe Books, New York, 1972. URL <https://search.library.wisc.edu/catalog/999473210902121>.
- METI Japan. Basic Hydrogen Strategy (key points). Ministry of Economy, Trade and Industry, 2020. ISSN 00223530. URL https://www.meti.go.jp/english/press/2017/pdf/1226_003a.pdf.

- Y. Mizuno, Y. Ishimoto, S. Sakai, and K. Sakata. Economic analysis on international hydrogen energy carrier supply chains. *Journal of Japan Society of Energy and Resources*, 38(3):11–17, 2016. URL http://www.jsesr.gr.jp/journal/journal_pdf/2017/journal201705_2.pdf.
- A. Mohammadi and M. Mehrpooya. A comprehensive review on coupling different types of electrolyzer to renewable energy sources. *Energy*, 158:632–655, 2018. ISSN 03605442. doi: 10.1016/j.energy.2018.06.073.
- Monolith. Monolith fact sheet: what we do. Technical report, 2019.
- F. Mueller-Langer, E. Tzimas, M. Kaltschmitt, and S. Petevs. Techno-economic assessment of hydrogen production processes for the hydrogen economy for the short and medium term. *International Journal of Hydrogen Energy*, 32(16):3797–3810, 2007. ISSN 03603199. doi: 10.1016/j.ijhydene.2007.05.027.
- N. Muradov. Low-carbon production of hydrogen from fossil fuels. In V. Subramani, A. Basile, and T. N. B. T. C. o. H. E. Veziroglu, editors, *Woodhead Publishing Series in Energy*, pages 489–522. Woodhead Publishing, Oxford, 2015. ISBN 978-1-78242-361-4. doi: <https://doi.org/10.1016/B978-1-78242-361-4.00017-0>. URL <http://www.sciencedirect.com/science/article/pii/B9781782423614000170>.
- N. Z. Muradov and T. N. Veziroglu. From hydrocarbon to hydrogen-carbon to hydrogen economy. *International Journal of Hydrogen Energy*, 30(3):225–237, 2005. ISSN 03603199. doi: 10.1016/j.ijhydene.2004.03.033.
- A. Myhr, C. Bjerkseter, A. Ågotnes, and T. A. Nygaard. Levelised cost of energy for offshore floating wind turbines in a life cycle perspective. *Renewable Energy*, 66:714–728, 2014. ISSN 0960-1481. doi: 10.1016/j.renene.2014.01.017. URL <http://dx.doi.org/10.1016/j.renene.2014.01.017>.
- R. Niepelt and R. Brendel. Erneuerbarer Wasserstoff mit Solar-Wind-Hybridkraftwerken. *gwf Gas + Energie*, 7-8:38–45, 2020. NREL. 2020 Annual Technology Baseline. Technical report, U.S. National Renewable Energy Laboratory, 2020.
- B. Parkinson, J. W. Matthews, T. B. McConaughy, D. C. Upham, and E. W. McFarland. Techno-Economic Analysis of Methane Pyrolysis in Molten Metals: Decarbonizing Natural Gas. *Chemical Engineering and Technology*, 40(6):1022–1030, 2017a. ISSN 15214125. doi: 10.1002/ceat.201600414.
- B. Parkinson, M. Tabatabaei, D. C. Upham, B. Ballinger, C. Greig, S. Smart, and E. McFarland. Hydrogen production using methane : Techno- economics of decarbonizing fuels and chemicals. *International Journal of Hydrogen Energy*, pages 1–16, 2017b. ISSN 0360-3199. doi: 10.1016/j.ijhydene.2017.12.081. URL <https://doi.org/10.1016/j.ijhydene.2017.12.081>.
- B. Parkinson, P. Balcombe, J. F. Speirs, A. D. Hawkes, and K. Hellgardt. Levelized cost of CO2 mitigation from hydrogen production routes. *Energy and Environmental Science*, pages 19–40, 2019. doi: 10.1039/c8ee02079e.
- M. Pfennig, N. Gerhardt, C. Pape, and D. Böttger. Mittel- und langfristige Potentiale von PtL- und H2-Importen aus internationalen EE-Vorzugsregionen - Teilbericht. page 47, 2017. ISSN 01631829. doi: 10.1103/PhysRevB.51.697. URL http://www.energieversorgung-elektromobilitaet.de/includes/reports/Teilbericht_Potentiale_PtL_H2_Importe_FraunhoferIWES.pdf.
- S. Pfenninger and I. Staffell. Long-term patterns of European PV output using 30 years of validated hourly reanalysis and satellite data. *Energy*, 114:1251–1265, 2016. ISSN 03605442. doi: 10.1016/j.energy.2016.08.060. URL <http://dx.doi.org/10.1016/j.energy.2016.08.060>.
- R. C. Pietzcker, D. Stetter, S. Manger, and G. Luderer. Using the sun to decarbonize the power sector: The economic potential of photovoltaics and concentrating solar power. *Applied Energy*, 135:704–720, 2014. ISSN 03062619. doi: 10.1016/j.apenergy.2014.08.011. URL <http://dx.doi.org/10.1016/j.apenergy.2014.08.011>.
- J. Proost. State-of-the art CAPEX data for water electrolyzers, and their impact on renewable hydrogen price settings. *International Journal of Hydrogen Energy*, pages 4406–4413, 2019. ISSN 03603199. doi: 10.1016/j.ijhydene.2018.07.164. URL <https://doi.org/10.1016/j.ijhydene.2018.07.164>.
- M. Ram, D. Bogdanov, A. Aghahosseini, A. Gulagi, A. Oyewo, M. Child, U. Caldera, K. Sadovskaia, J. Farfan, L. Barbosa, M. Fasih, S. Khalili, B. Dalheimer, G. Gruber, T. Traber, F. De Caluwe, H.-J. Fell, and C. Breyer. Global Energy System based on 100% Renewable Energy – Power, Heat, Transport and Desalination Sectors. Study by Lappeenranta University of Technology and Energy Watch Group. Technical Report March, Lappeenranta, Berlin, 2019. URL <http://energywatchgroup.org/new-study-global-energy-system-based-100-renewable-energy>.
- S. Reichelstein and A. Sahoo. Relating Product Prices to Long-Run Marginal Cost: Evidence from Solar Photovoltaic Modules. *Contemporary Accounting Research*, 35(3):1464–1498, 2018. ISSN 19113846. doi: 10.1111/1911-3846.12319.
- M. Reuß, T. Grube, M. Robinus, P. Preuster, P. Wasserscheid, and D. Stolten. Seasonal storage and alternative carriers: A flexible hydrogen supply chain model. *Applied Energy*, 200:290–302, 2017. ISSN 03062619. doi: 10.1016/j.apenergy.2017.05.050.
- C. R. Rodríguez, M. Riso, G. Jiménez Yob, R. Ottogalli, R. Santa Cruz, S. Aisa, G. Jeandrevin, and E. P. Leiva. Analysis of the potential for hydrogen production in the province of Córdoba, Argentina, from wind resources. *International Journal of Hydrogen Energy*, 35(11):5952–5956, 2010. ISSN 03603199. doi: 10.1016/j.ijhydene.2009.12.101.
- E. S. Rubin, I. M. Azevedo, P. Jaramillo, and S. Yeh. A review of learning rates for electricity supply technologies. *Energy Policy*, 86:198–218, 2015a. ISSN 03014215. doi: 10.1016/j.enpol.2015.06.011. URL <http://dx.doi.org/10.1016/j.enpol.2015.06.011>.
- E. S. Rubin, J. E. Davison, and H. J. Herzog. The cost of CO2 capture and storage. *International Journal of Greenhouse Gas Control*, 2015b. ISSN 1750-5836. doi: 10.1016/j.ijggc.2015.05.018. URL <http://dx.doi.org/10.1016/j.ijggc.2015.05.018>.
- P. A. Samuelson. Social Indifference Curves. *The Quarterly Journal of Economics*, 70(1):1–22, 2 1956. ISSN 0033-5533. doi: 10.2307/1884510. URL <https://doi.org/10.2307/1884510>.
- O. Schmidt, A. Gambhir, I. Staffell, A. Hawkes, J. Nelson, and S. Few. Future cost and performance of water electrolysis: An expert elicitation study. *International Journal of Hydrogen Energy*, 42(52):30470–30492, 2017. ISSN 03603199. doi: 10.1016/j.ijhydene.2017.10.045. URL <https://doi.org/10.1016/j.ijhydene.2017.10.045>.

- S. Schneider, S. Bajohr, F. Graf, and T. Kolb. Verfahrensuebersicht zur Erzeugung von Wasserstoff durch Erdgas-Pyrolyse. (8):1–11, 2020. doi: 10.1002/cite.202000021.
- S. Schulte. Essays on Supply Diversification of the European Natural Gas Market, 2019.
- Z. R. Shu, Q. S. Li, and P. W. Chan. Statistical analysis of wind characteristics and wind energy potential in Hong Kong. *Energy Conversion and Management*, 101:644–657, 2015. ISSN 01968904. doi: 10.1016/j.enconman.2015.05.070.
- R. K. Sinnott. *Chemical Engineering Volume 6: Chemical Engineering Design*. Number 3rd ed. Butterworth-Heinemann, Oxford, 1999.
- V. Sivaram and S. Kann. Solar power needs a more ambitious cost target. *Nature Energy*, 1(4):7–9, 2016. ISSN 2058-7546. doi: 10.1038/nenergy.2016.36.
- J. G. Speight. *Gasification processes for syngas and hydrogen production*. Number Chapter 1. Woodhead Publishing, 2015. ISBN 9780857098085. doi: 10.1016/B978-0-85709-802-3.00006-0. URL <http://dx.doi.org/10.1016/B978-0-85709-802-3.00006-0>.
- I. Staffell and S. Pfenninger. Using bias-corrected reanalysis to simulate current and future wind power output. *Energy*, 114:1224–1239, 2016. ISSN 0360-5442. doi: 10.1016/j.energy.2016.08.068. URL <http://dx.doi.org/10.1016/j.energy.2016.08.068>.
- T. Stangarone. South Korean efforts to transition to a hydrogen economy. *Clean Technologies and Environmental Policy*, 2020. ISSN 1618-9558. doi: 10.1007/s10098-020-01936-6. URL <https://doi.org/10.1007/s10098-020-01936-6>.
- H. Steinmüller, G. Reiter, R. Tichler, C. Friedl, M. Furtlehner, and J. Lindorfer. Power to Gas – Eine Systemanalyse. Technical report, 2014.
- A. T-Raissi. Technoeconomic Analysis of Area II Hydrogen Production - Part II: Hydrogen from Ammonia and Ammonia-Borane Complex for Fuel Cell Applications. In *Proceedings of the 2002 U.S. DOE Hydrogen Review*, pages 584–601. 2002.
- S. Teske. *Achieving the Paris Climate Agreement Goals - Global and Regional 100% Renewable Energy Scenarios with Non-energy GHG Pathways for +1.5° C and +2° C*. Springer, 2019. ISBN 9783030058432. doi: 10.1007/978-3-030-05843-2{_}4.
- S. Timmerberg and M. Kaltschmitt. Hydrogen from renewables: Supply from North Africa to Central Europe as blend in existing pipelines – Potentials and costs. *Applied Energy*, 237:795–809, 3 2019. ISSN 0306-2619. doi: 10.1016/J.APENERGY.2019.01.030. URL <https://www.sciencedirect.com/science/article/pii/S0306261919300303>.
- S. Timmerberg, M. Kaltschmitt, and M. Finkbeiner. Hydrogen and hydrogen-derived fuels through methane decomposition of natural gas – GHG emissions and costs. *Energy Conversion and Management*, 7(February):100043, 2020. ISSN 2590-1745. doi: 10.1016/j.ecmx.2020.100043. URL <https://doi.org/10.1016/j.ecmx.2020.100043>.
- E. Vartiainen, G. Masson, C. Breyer, D. Moser, and E. Román Medina. Impact of weighted average cost of capital, capital expenditure, and other parameters on future utility-scale PV levelised cost of electricity. *Progress in Photovoltaics: Research and Applications*, 28(6):439–453, 2020. ISSN 1099159X. doi: 10.1002/pip.3189.
- T. N. Veziroglu, S. Kakaç, [U+FFFF] Başar, and N. Forouzanmehr. Fossil/hydrogen energy mix and population control. *International Journal of Hydrogen Energy*, 1(2):205–217, 1976. ISSN 0360-3199. doi: [https://doi.org/10.1016/0360-3199\(76\)90072-0](https://doi.org/10.1016/0360-3199(76)90072-0). URL <http://www.sciencedirect.com/science/article/pii/0360319976900720>.
- A. Wang, K. van der Leun, D. Peters, and M. Buseman. European Hydrogen Backbone. Technical Report July, Guidehouse, Enagás, Energinet, Fluxys Belgium, Gasunie, GRTgaz, NET4GAS, OGE, ONTRAS, Snam, Swedegas, Teréga, 2020. URL <https://transparency.entsog.eu/>.
- Y. Wang and A. E. Rodrigues. Hydrogen production from steam methane reforming coupled with in situ CO₂ capture : Conceptual parametric study. 84:1778–1789, 2005. doi: 10.1016/j.fuel.2005.04.005.
- T. Watanabe, K. Murata, S. Kamiya, and K. Ota. Cost Estimation of Transported Hydrogen , Produced by Over- seas Wind Power Generations. 2010.
- L. Weger, A. Abánades, and T. Butler. Methane cracking as a bridge technology to the hydrogen economy. *International Journal of Hydrogen Energy*, 42(1):720–731, 2017. ISSN 03603199. doi: 10.1016/j.ijhydene.2016.11.029.
- A. T. Wijayanta, T. Oda, C. W. Purnomo, T. Kashiwagi, and M. Aziz. Liquid hydrogen, methylcyclohexane, and ammonia as potential hydrogen storage: Comparison review. *International Journal of Hydrogen Energy*, 44(29):15026–15044, 2019. ISSN 03603199. doi: 10.1016/j.ijhydene.2019.04.112. URL <https://doi.org/10.1016/j.ijhydene.2019.04.112>.
- E. Williams, E. Hittinger, R. Carvalho, and R. Williams. Wind power costs expected to decrease due to technological progress. *Energy Policy*, 106:427–435, 2017. ISSN 03014215. doi: 10.1016/j.enpol.2017.03.032. URL <http://dx.doi.org/10.1016/j.enpol.2017.03.032>.
- R. Wiser, K. Jenni, J. Seel, E. Baker, M. Hand, E. Lantz, and A. Smith. Expert elicitation survey on future wind energy costs. *Nature Energy*, 1(10), 2016. ISSN 20587546. doi: 10.1038/nenergy.2016.135.
- World Bank, Esmap, and Solargis. Global Solar Atlas, 2020. URL <https://globalsolaratlas.info/>.
- C. Wulf and P. Zapp. Assessment of system variations for hydrogen transport by liquid organic hydrogen carriers. *International Journal of Hydrogen Energy*, 43(26):11884–11895, 2018. ISSN 03603199. doi: 10.1016/j.ijhydene.2018.01.198. URL <https://doi.org/10.1016/j.ijhydene.2018.01.198>.

Appendix A. Technologies

Appendix A.1. Hydrogen production pathways covered by this study

This section outlines hydrogen production pathways that are selected for consideration in the analysis and illustrates the technical characteristics of the selected technologies.

Figure A.10 illustrates the most common ways of producing hydrogen. This study focuses on assessing low-carbon hydrogen, where the production process releases minimal or no CO₂ emissions into the environment. Three hydrogen production methods are considered and compared. Those methods also receive central attention in (supra-)national hydrogen strategies (for example, [European Commission, 2020](#); [METI Japan, 2020](#)):

1. Hydrogen from renewable energy sources, where electricity is converted to hydrogen in the process of electrolysis. This kind of hydrogen is also commonly known as green hydrogen.³³
2. Hydrogen from natural gas reforming with CCS, also referred to as blue hydrogen. CO₂ produced in the process is captured and stored so that it cannot escape into the environment.
3. Hydrogen from the pyrolysis of natural gas, which is also known as turquoise hydrogen. Natural gas is cracked in the absence of oxygen under high temperatures, whereby, in contrast to gas reforming, no CO₂ is produced.

Figure A.10: Ways to produce hydrogen ([IEA, 2019b](#), p. 39)

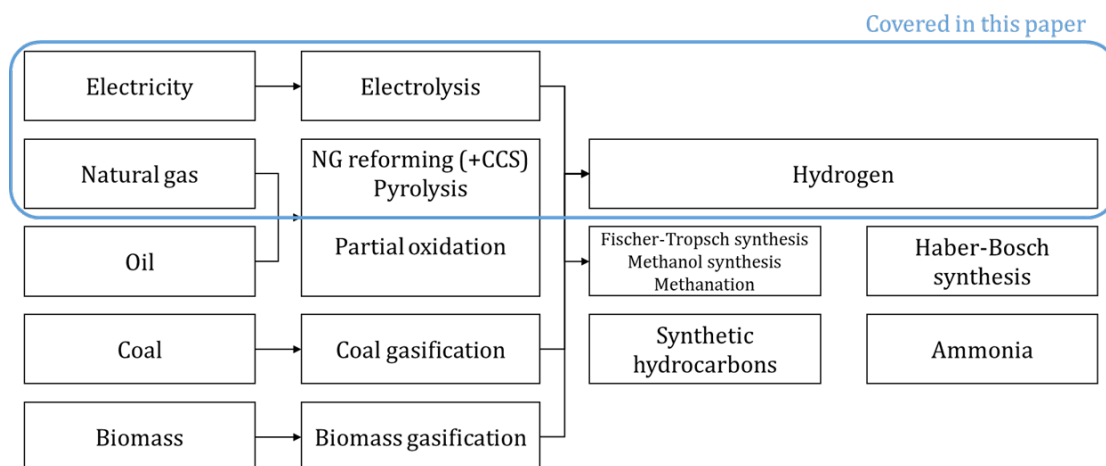

³³For the production of low-carbon hydrogen, it is essential that the electricity, which is used in electrolysis, is carbon neutral. Therefore, electrolysis in this study corresponds to hydrogen from renewable energies: The electricity sources considered for electrolysis are solar energy (PV) and wind power (onshore and offshore). Nuclear energy is also a carbon-free electricity source but highly controversial in some countries. Germany, for example, has already decided to phase out nuclear power. Therefore, this study does not consider nuclear power.

A variety of alternative low-carbon hydrogen production possibilities exists or are currently being researched, for example, clean hydrogen from oil via bed fires (Collins, 2020), chemical looping (Khojasteh et al., 2017), photolysis, or plasma reforming (Kalamaras and Efstathiou, 2013). However, these technologies will most likely not play a major role in the mid-term low-carbon hydrogen market. They have often not yet reached the level of maturity where robust techno-economic projections could enable a cost estimation. Therefore, this analysis is limited to the three aforementioned pathways, since the economic and political debate revolves almost exclusively around them. Technologies under consideration, which figure A.10 shows framed in blue, are explained in more detail in the Appendix.

Electrolysis

The process of splitting water into oxygen and hydrogen through the use of electricity is called electrolysis. Three major types of electrolyzers are being produced commercially today: Alkaline electrolyzers (AEL), polymer electrolyte membrane (PEM) electrolyzers, and solid oxide electrolyser cells (SOEC).³⁴ They vary in their functionality, mainly due to the different types of electrolyte material involved (EERE, 2020). Technical characteristics of the three technologies are shown schematically in figure A.11 and explained in more detail in the following.

Figure A.11: Schematic illustration of electrolysis technologies (Steinmüller et al., 2014)

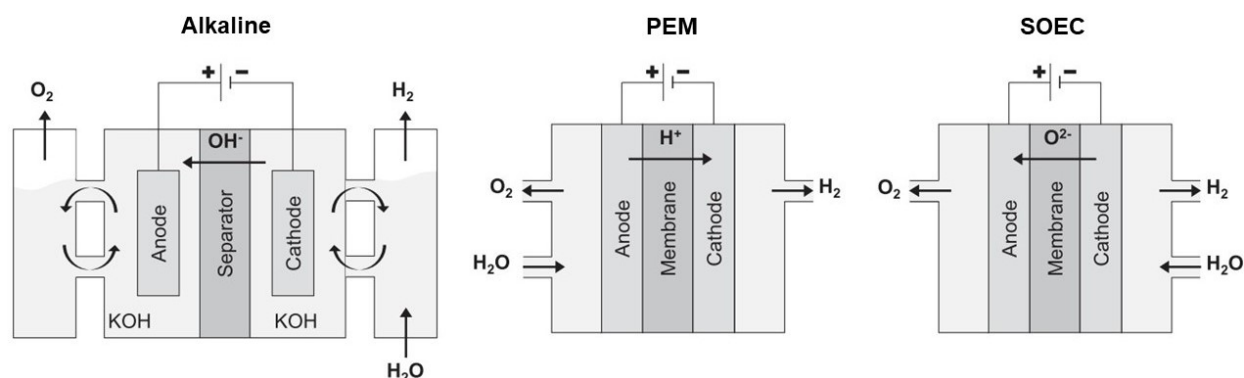

Alkaline electrolyzers operate via transporting hydroxide ions from the cathode to the anode with hydrogen being generated on the cathode side, as shown in equation A.1. Systems using a liquid alkaline solution as electrolyte have been commercially available for many years and are currently the cheapest and most mature electrolysis technology. Capital costs are relatively low compared to other electrolyser technologies, as no precious materials are used (IEA, 2019b). A further development using solid alkaline

³⁴Other emerging electrolysis technologies exist (Chemie Technik, 2020), but there are still some hurdles to overcome before they are market-ready (Mayyas and Mann, 2019). Therefore only the three current technologies are considered here.

exchange membranes as the electrolyte is being tested on a lab-scale (EERE, 2020).

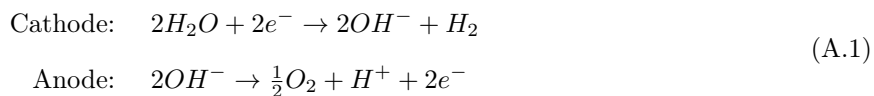

In a **polymer electrolyte membrane (PEM) electrolyser**, the electrolyte consists of solid speciality plastic material. Equation A.2 shows the principles of operation: At the anode, water is split into oxygen and positively charged hydrogen ions. The ions selectively pass the membrane to the cathode, where they combine with electrons to form hydrogen.

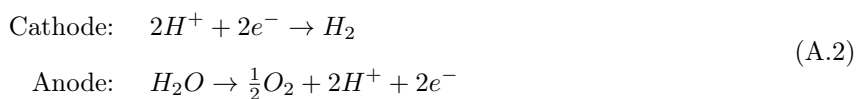

Compared to alkaline electrolysers, PEM systems have clear flexibility advantages (IRENA, 2018). They can react more quickly to the fluctuations in electricity supply, and their operating range can go up to 160% of design capacity³⁵. However, PEM systems are currently more expensive than alkaline electrolysers since more precious materials are needed (e.g., platinum), and the technology is less mature. In terms of future development, studies differ in statements about the superiority of a certain electrolyser. While Schmidt et al. (2017) and Götz et al. (2016) project a future dominance of PEM systems, alkaline electrolysis stays the most favourable system medium-term with regard to CAPEX and efficiency in projections of IEA (2019b) and Proost (2019). It is not yet possible to reliably estimate which innovations for the respective systems will take place in the future. Efficiencies and capital expenditures (CAPEX) are comparatively close, and the specific advantages of either system are not relevant for this cost-economic analysis. Therefore, the question of the superiority of one electrolysis technology over the other is deliberately left open, and both are summarised under the label *low-temperature electrolysis*.

A **solid oxide electrolyser cell (SOEC)** uses a solid ceramic material as the electrolyte to generate hydrogen. As shown in equation A.3, water at the cathode combines with electrons and forms hydrogen gas and negatively charged oxygen ions. The ions move across the solid ceramic membrane and form oxygen gas and generate electrons in a reaction at the anode (EERE, 2020).

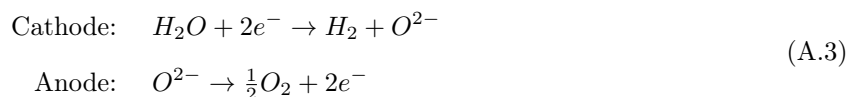

Solid oxide electrolysers need to operate at high temperatures, so the membranes function properly. Therefore, they are often referred to as high-temperature electrolyser. In comparison to low-temperature electrolysers, SOECs are less flexible but yield a higher degree of electrical efficiency, so potentially have a

³⁵The electrolyser can be overloaded relative to its installed capacity.

lower power consumption (Fasihi et al., 2016). They are still under development and employed in only a handful of pilot plants (Agora Verkehrswende et al., 2018, p. 63). Solid oxide electrolyzers are considered in this study due to their potentially increasing future importance; they are referred to as *high-temperature electrolyzers* in the remainder.

Natural gas reforming

The reformation of natural gas in order to produce hydrogen can be executed in different processes. The two most common, steam methane reforming (SMR) and autothermal reforming (ATR), are briefly explained below.

Steam methane reforming (SMR) is currently the dominant process for producing hydrogen and has been employed for several decades (Speight, 2015). It is also likely to remain the dominant technology for the large-scale production of hydrogen in the near term (IEA, 2019b). The chemical process is shown in equation A.4. Methane is reacted with steam in an endothermic process, using a catalyst at high temperatures and a pressure of 5–40 bar, to produce carbon monoxide and hydrogen. By reacting carbon monoxide with steam, additional hydrogen is produced (Parkinson et al., 2019).



A major part of CO₂ produced in the process can be captured with a carbon capture system before it enters the atmosphere. In contrast to the actual SMR, this process is relatively new and entails additional costs. Most operative SMR plants are not equipped with CCS but could be retrofitted.

For **autothermal reforming (ATR)**, oxygen and carbon dioxide or steam react with methane to form synthesis, producing hydrogen (Speight, 2015). As a major difference to SMR, which only uses oxygen via air for combustion as a heat source to create steam, ATR directly combusts oxygen, where the H₂:CO ratio can be varied. Due to oxidation, the process is exothermic. When the ATR uses steam (equation A.5), the H₂/CO ratio produced is 2.5:1, when the ATR uses carbon dioxide instead (equation A.6), the ratio is 1:1. The separation of CO₂ is easier for ATR than for SMR. The SMR process requires higher temperatures; necessary heat is provided by natural gas combustion. The CO₂ must then be separated from the exhaust gas stream of the gas turbine. In the ATR process, however, the CO₂ comes exclusively from the process stream, which makes separation easier.

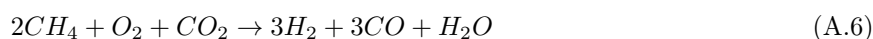

At the moment, ATR seems to bear the most potential for low-carbon hydrogen from natural gas as it has key advantages in combination with CCS, compared to SMR. It enables a higher CO₂ capture percentage

(CE Delft, 2018) and allows capturing CO₂ at lower cost (IEA, 2019b). However, since both technologies, ATR and SMR, are quite similar, they are summarised as one technology in this study (as also in IEA (2019b)). This technology is called *natural gas reforming with carbon capture and storage* (NGR with CCS).

Pyrolysis

Pyrolysis, also called thermal methane cracking, is an alternative method to produce hydrogen from natural gas but is still in an early development stage. As shown in equation A.7, natural gas is decomposed in the absence of oxygen, reacting to hydrogen and carbon in an endothermic process. Thus, one of the key advantages of pyrolysis is that the process produces no CO₂. Instead, the carbon by-product is solid. At the moment, solid carbon can be sold for extra revenue (Dagle et al., 2017).³⁶ However, if pyrolysis becomes a marketable method for large-scale hydrogen production, the amount of solid carbon produced as a by-product would likely far exceed the current market volume. Solid carbon prices would decrease close to zero, as long as no new markets or applications arise (Timmerberg et al., 2020).



With several different pyrolysis technologies being pursued (Machhammer et al., 2018), the pyrolysis technology readiness level (TRL)³⁷ is between 3 (*experimental proof of concept*), and 5 (*technology validated in relevant environment*). To scale up a global low-carbon hydrogen market and achieve early decarbonisation, pyrolysis is therefore likely to play a limited role, at least in the medium term. But since it already has a part in the debate on climate-neutral hydrogen (Weger et al., 2017; Dickel, 2020) and policy strategies plan to incentivise development of the solution (European Commission, 2020), pyrolysis is considered as a technology path in this study.

Appendix B. Methodology

Appendix B.1. Estimation of hydrogen production costs

The LCOH is estimated for countries $n \in N$, years $y \in Y$ and electrolysis technologies $el = \{\text{low temperature, high temperature}\}$ from renewable energy sources $res = \{\text{PV, onshore, offshore}\}$, pyrolysis (pl) and natural gas reforming (rf). A central factor for LCOH of every technology are financing costs. They are expressed via an *amortisation factor* that includes the weighted average cost of capital (WACC) and the financing time and is assumed to be constant over time. The amortisation factor a for a technology is calculated as

³⁶For example, tires are currently produced out of carbon black, a specific type of solid carbon.

³⁷Technology Readiness Level is a scale from that describes the maturity of a technology. The full definition can be found in European Commission (2017, p.29).

$$a = \frac{i * (1 + i/100)^l}{(1 + i/100)^{l-1}}, \quad (\text{B.1})$$

where i is the interest rate or WACC in %, l is economic lifetime and amortisation period of the corresponding technology in years.

Appendix B.2. Cost estimation for hydrogen from RES

A RES cost projection is constructed based on global one-factor experience curves for each renewable energy technology.³⁸ The one-factor experience curve is widely used to project future RES costs (Rubin et al., 2015b; Alberth, 2008) and indicates a log-linear relationship between technology cost and cumulative installed capacity (McDonald and Schratzenholzer, 2001). Technology production costs decline over time where the rate of decline is driven by the total installed capacity of a technology: The learning rate (LR) determines the percent decrease in cost for every doubling in accumulated installed capacity. Capital expenditures $CAPEX$ for renewable energy source res in country n and year y are calculated as

$$CAPEX_{n,y}^{res}(x_y^{res}) = CAPEX_{n,0}^{res}(x_0^{res}) \left(\frac{x_y^{res}}{x_0^{res}} \right)^{-LR^{res}}, \quad (\text{B.2})$$

where x_y^{res} and x_0^{res} are global cumulative installed capacities of renewable energy source res in year y and the baseline year 0, respectively. In line with other major electricity cost assessments (European Commission, 2013; IEA, 2019c; IRENA, 2012), operating expenditures (OPEX) are calculated as % of CAPEX and thus change over time in parallel to CAPEX. In addition to CAPEX and OPEX, the capacity factor of a renewable energy source is a determining factor for electricity and thus hydrogen costs. It is expressed as a unit-less parameter in an interval between zero and one and indicates the proportion of time the installed capacity of the corresponding RES is fully utilised. The higher a capacity factor, the higher the utilisation and lower the electricity costs of a renewable energy source. The capacity factor depends on the natural conditions for sun and wind and therefore varies greatly depending on the location. In order to adequately reflect this variation, which can also occur within a country, all considered renewable energy sources are additionally clustered into resource classes for each country, which combine different intervals of capacity factors. A detailed explanation of the clustering approach can be found in section 3.1.

Renewable electricity sources, such as wind and PV, are generally characterised by intermittency and a low utilisation – usually below a capacity factor of 50% for wind and below 25% for PV – even in the

³⁸Estimating future costs based on global learning rates instead of taking costs directly from existing literature offers the advantage of creating an own simple state-of-the-art scenario with assumptions that can be flexibly changed and updated. Recent major cost projections (DNV GL, 2019; IEA, 2019c, stated policies scenario) make assumptions on the expansion of renewable energies, which are not seen as ambitious enough for this study. Older cost estimates, mainly from integrated assessment models, are already outdated (Krey et al., 2019).

most favourable locations. Hours where a generator produces at close to full capacity are relatively rare. Electrolysers are capital-intensive pieces of equipment and should therefore experience a high utilisation to be as economical as possible. Consequently, combining an electrolyser with a low capacity factor RES such as a wind turbine, a 1:1 pairing of electrolyser to generator capacity is likely not to result in the lowest possible LCOH for the combined system. Instead, it may be more advantageous to install an electrolyser with a capacity lower than that of the paired RES. The electrolyser could then be operated at a higher annual capacity factor, while some of the peak output of the RES would have to be curtailed.³⁹

Figure B.12: Optimization of LCOH as trade-off between levelised cost of electricity (LCOE) and electrolyser CAPEX & OPEX

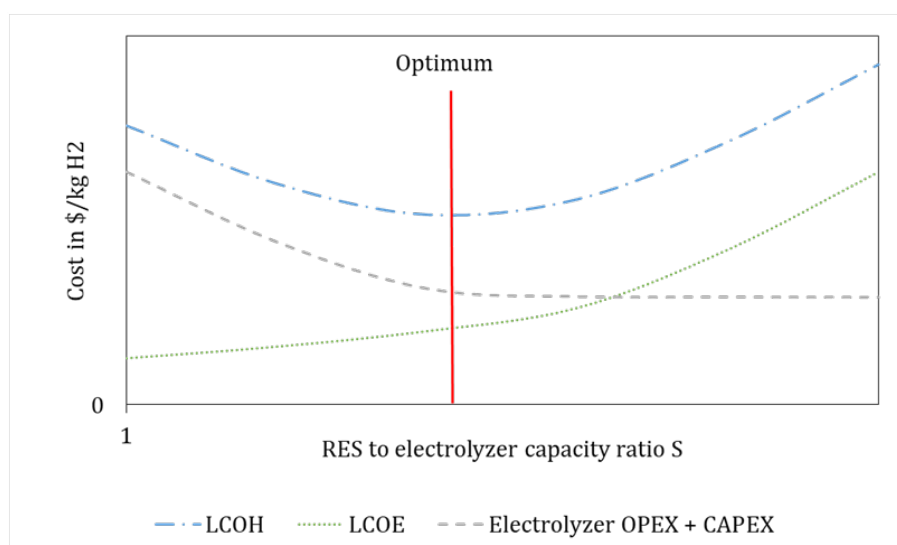

The ratio of electrolyser-to-RES capacity that yields the lowest LCOH is dependent on the capital cost of the electrolyser, the capital cost of the RES, as well as the load profile and capacity factor of the RES. Since all these factors are variable, calculating the optimal ratio between electrolyser and RES capacity is not a trivial problem. Furthermore, both RES and electrolyser capital costs are assumed to decline over time, but at different rates; RES capital costs are assumed to vary between countries. Similarly, RES capacity factors and hourly load profiles differ from location to location. In order to derive optimal RES-to-electrolyser capacity ratios for all combinations of electrolyser technologies, RES, countries, and RES resource classes covered by this study, a linear optimisation model is developed, as described in equations B.3 to B.6. Figure B.12 illustrates the optimisation process.

³⁹It could also be fed into the grid, however, the interaction with the electricity sector is neglected in this study due to its complexity, and the fact for some of the more remote RES resources in particular, a connection to the (far away) power grid may not always be a cost-efficient option.

$$\min_{C_{n,r,y}^{el}, C_{n,r,y}^{res}} TC_{n,r,y}^{el,res} \quad (\text{B.3})$$

s.t.

$$TC_{n,r,y}^{el,res} = \underbrace{\left((CAPEX_y^{el} * a^{el} + OPEX_y^{el}) * C_{n,r,y}^{el} \right)}_{el \text{ OPEX \& CAPEX}} + \underbrace{\left((CAPEX_{n,y}^{res} * a_n^{res} + OPEX_{n,y}^{res}) * C_{n,r,y}^{res} \right)}_{\text{Electricity cost}} * \sum_{n=h}^{8760} Q_{n,r,y,h}^{res,el} \quad (\text{B.4})$$

$$Q_{n,r,y,h}^{res,el} \leq C_{n,r,y}^{res} * CF_{n,r,h}^{res} * \eta_y^{el} \quad (\text{B.5})$$

$$Q_{n,r,y,h}^{res,el} \leq C_{n,r,y}^{el} * \eta_y^{el} \quad (\text{B.6})$$

where

$TC_{n,r,y}^{el,res}$ is the total cost of hydrogen production by the combination of electrolyser el and RES technology res in year y , country n and resource class r ,

$C_{n,r,y}^{el}$ is the installed el capacity in year y , country n and resource class r (expressed in kW-electric),

$C_{n,r,y}^{res}$ is the installed res capacity in year y , country n and resource class r (expressed in kW-electric),

η_y^{el} is the efficiency of electrolyser el in year y in %,

$CF_{n,r,h}^{res}$ is the capacity factor of res in hour h , country n and resource class r , with $h = \{1, 2, \dots, 8760\}$, the generation of hourly profiles is explained in Appendix section [Appendix B.5](#)

$Q_{n,r,y,h}^{res,el}$ is the H₂ production of the respective combination of res , and el in country n , resource class r , year y and hour h .

The optimal ratio of RES-to-electrolyser capacity $S_{n,r,y}^{*el,res}$ that yields the lowest levelised cost of hydrogen ($LCOH_{n,r,y}^{*el,res}$) for a combination of res and el in country i , resource class r and year y is given as

$$S_{n,r,y}^{*el,res} = \frac{C_{n,r,y}^{*res}}{C_{n,r,y}^{*el}}, \quad (\text{B.7})$$

where $C_{n,r,y}^{*el}$ is the optimal installed el capacity in year y , country n and resource class r and $C_{n,r,y}^{*res}$ is the optimal installed res capacity in year y , country n and resource class r . The $LCOH_{n,r,y}^{*el,res}$, expressed in \$/kg of hydrogen, is computed as

$$LCOH_{n,r,y}^{*el,res} = LHV * \frac{TC_{n,r,y}^{*el,res}}{\sum_{n=h}^{8760} Q_{n,r,y,h}^{*res,el}} \quad (\text{B.8})$$

where LHV is the lower heating value of hydrogen (33.33 kWh/kg). The optimisation

Due to the optimisation, electrolysers have an increased utilisation and a higher capacity factor than the associated RES system. The mean yearly capacity factors of electrolyser el in optimum can be obtained as

$$CF_{n,r}^{*el} = \frac{\sum_{n=h}^{8760} Q_{n,r,y,h}^{*res,el}}{C_{n,r,y}^{*el} * 8760} \quad (\text{B.9})$$

Some factors potentially influencing the LCOH from RES are disregarded. This includes

1. interactions of RES and the local electricity market. Installed RES produce electricity only for electrolysis, potential revenues from feeding excess electricity to the grid are disregarded. Instead, hydrogen production is considered a closed system. Hydrogen is produced directly on site and transported from there, see section 3.3.
2. costs of water supply. Electrolysis needs large amounts of demineralised water,⁴⁰ which may first have to be transported to the res production site. However, the impact of water supply on LCOH is insignificantly small (Caldera et al., 2018; Caldera and Breyer, 2017; Jensterle et al., 2020) and therefore excluded in this study for the sake of model simplicity.
3. changes in RES capacity factors over time. Climate change and increasing RES efficiency could lead to changing capacity factors in the future. However, since there are no uniform factors to project changes in capacity factors globally, a detailed capacity factor assessment would go beyond the scope of this study and is therefore only recommended as a possibility for future research.

Appendix B.3. Cost estimation for hydrogen from natural gas

As described in Appendix A.1, natural gas reforming with CCS captures a large part of the CO₂ emissions caused in the process. These emissions have to be transported and stored, which is reflected in the LCOH. In order not to ignore emissions that have not been caught, they are assigned a CO₂ price. The LCOH from NGR with CCS (rf) are calculated as

$$LCOH_{n,y}^{rf} = LHV * \left(\frac{a^{rf} * CAPEX_y^{rf} + OPEX_y^{rf}}{CF^{rf} * 8760} + \frac{P_{n,y}^{NG}}{\eta^{rf}} \right) + \frac{Q^{ce} * P_n^{CCS} + Q^{ue} * P_{n,y}^{CO_2}}{1000}, \quad (\text{B.10})$$

where

a^{rf} is the amortisation factor,

⁴⁰One kg of hydrogen needs about nine litres of water.

$OPEX_y^{rf}$ are operating expenditures in $\$/kW/a$,
 $CAPEX_y^{rf}$ are capital expenditures in $\$/kW H_2$,
 CF^{rf} is the plant's availability in %,
 $P_{n,y}^{NG}$ is the natural gas price in country n and year y in $\$/kW$,
 η^{rf} is the plant efficiency,
 Q^{ce} is the quantity of captured CO_2 emissions in $(kg CO_2)/(kg H_2)$,
 P_n^{CCS} is the cost of transporting and storing CO_2 for country n in $\$/ton$,
 Q^{ue} is the quantity of uncaptured CO_2 emissions in $(kg CO_2)/(kg H_2)$,
 and $P_{n,y}^{CO_2}$ is the CO_2 price for country n in year y in $\$/ton$.

The production of hydrogen by pyrolysis does not produce CO_2 , but solid carbon as a by-product, which can potentially be sold for extra revenue. The $LCOH$ from pyrolysis of natural gas are calculated as

$$LCOH_{n,y}^{pl} = LHV * \left(\frac{a^{pl} * CAPEX_y^{pl} + OPEX_y^{pl}}{CF^{pl} * 8760} + \frac{P^{NG}}{\eta^{pl}} \right) - Q^{sc} * P^{sc}, \quad (B.11)$$

where Q^{sc} is the solid carbon yield in $(kg C)/(kg H_2)$ and P^{CB} is the price for carbon in $\$/kg$. All other variables are used equivalently to equation B.10.

Appendix B.3.1. Estimation of transportation costs

Transport distance is defined as distance from external border to external border, transport distances within a country are disregarded for simplicity. The transport cost of hydrogen in $\$/kg$ to country n from country m is calculated as a minimisation of costs of three possible transport routes, via pipeline (1), ship (2), or a combination of pipeline and ship (3) in equation B.12. If a direct route by pipeline or ship is unfeasible for a combination of two countries, then $d_{n,m}^{pipe} = \{\}$ or $d_{n,m}^{sea} = \{\}$.

$$TraC_{n,m,y} = \min \begin{cases} (1) TraC_{n,m}^{pipe} & \forall d_{n,m}^{pipe} \neq \{\} \\ (2) TraC_{n,m,y}^{sea} & \forall d_{n,m}^{sea} \neq \{\} \\ (3) TraC_{n,m,y}^{combined} \end{cases} \quad (B.12)$$

where

$TraC_{n,m}^{pipe}$ are transport costs via pipeline (constant) in $\$/kg H_2$,
 $d_{n,m}^{pipe}$ is the length of a direct pipeline route between country m and n
 $TraC_{n,m,y}^{sea}$ are transport costs for overseas transport,
 $d_{n,m}^{sea}$ is the direct sea distance between country m and n

$TraC_{n,m,y}^{combined}$ are transport cost of a combination of pipeline and ship transport, if a single mode of transport is not applicable or efficient.

Transport costs via pipeline are assumed to be constant over time, a cost distinction is made between offshore and onshore sections as shown in equation B.13.

$$TraC_{n,m}^{pipe} = \underbrace{(a^{on} * CAPEX^{on} + OPEX^{on}) * d_{n,m}^{on}}_{\text{Onshore pipeline}} + \underbrace{(a^{off} * CAPEX^{off} + OPEX^{off}) * d_{n,m}^{off}}_{\text{Offshore pipeline}}, \quad (\text{B.13})$$

For both pipeline types, a is the amortisation factor, $OPEX$ are operating expenditures in $\$/km/a$, $CAPEX$ are given in $\$/km$, and $d_{n,m}$ is the length of the respective pipeline section in km. For overseas transport, hydrogen is liquefied and transported by ship⁴¹. Total seaborne transport cost are made up of the individual components of the shipping supply chain as shown in equation B.14, superscripts for the hydrogen production technologies res, el, rf, pl are dropped for simplicity. Since, in contrast to pipeline technology, for the transport of hydrogen by ship, significant cost reductions are still expected, the individual cost components change over time.

$$TraC_{n,m,y}^{sea} = LC_{m,y} + EC_{m,y} + SC_{m,y} + IC_{n,y}, \quad (\text{B.14})$$

where $LC_{m,y}$ are liquefaction cost, $EC_{m,y}$ are export terminal costs, $SC_{m,y}$ are shipping costs and $IC_{n,y}$ are costs of the import terminal. The calculation of the individual components is explained below, variables $a, CAPEX$ and $OPEX$ represent the amortisation factor, capital expenditures and operating expenditures of the corresponding supply chain element. Liquefaction plant costs of exporting country m and year y in $\$/kg H_2$ are calculated as

$$LC_{n,y} = (a^{liq} * CAPEX_y^{liq} + OPEX^{liq}) + el_y^{liq} * p_{m,y}^{el}, \quad (\text{B.15})$$

where el_y^{liq} is the electricity needed for the liquefaction in $kWh/kg H_2$ and $p_{m,y}^{el}$ is the price of electricity in exporting country m and year y in $\$/kWh$. Export terminal costs in $\$/kg H_2$ are

$$EC_{m,y}^{tech} = (a^{et} * CAPEX_y^{et} + OPEX^{et}) + el_y^{et} * p_{m,y}^{el} + b^{et} * t^{et} * LCOH_{m,y}, \quad (\text{B.16})$$

where

el_y^{et} and $p_{m,y}^{el}$ are electricity amount and price,

b^{et} is the boil-off, that means the share of hydrogen that escapes and is lost in $\%/h$,

⁴¹A detailed justification for the choice of the transport medium can be found in section 3.3.

t^{et} is the average storage time in the export terminal storage tanks in hours,

$LCOH_{m,y}$ is the cost of the transported hydrogen in $\$/kg H_2$.

Shipping costs to importing country n from country m in year y are also given in $\$/kg H_2$ and are calculated as

$$SC_{n,m,y}^{tech} = \underbrace{(a^{ship} * CAPEX_y^{ship} + OPEX^{ship})}_{\text{Yearly CAPEX per kg of transport capacity}} / \underbrace{\frac{8760}{2 * (\frac{d_{n,m}}{v^{ship}} + h^{ship})}}_{\text{Loads per year}} \quad (B.17)$$

$$/ \underbrace{\left(1 - (b^{ship} * \frac{d_{n,m}^{sea}}{v^{ship}}) - (f^{ship} * d_{n,m}^{sea})\right)}_{\text{Share of load left after shipping}} + \underbrace{(b^{ship} * \frac{d_{ij}^{sea}}{v^{ship}} + f^{ship} * d_{n,m}^{sea}) * LCOH_{m,y}}_{\text{Cost of boil-off}} \quad (B.18)$$

where

$d_{n,m}^{sea}$ is the distance between country i and j via ship in km ,

v^{ship} is the ship speed in km/h ,

h^{ship} is the time a ship spends in a harbour for loading or unloading, also called berthing time, in hours,

b^{ship} is the ship's boil-off in $\%/h$,

f^{ship} is the fuel need of a ship in $kg H_2/km$,⁴²

$LCOH_{m,y}$ is the cost of the transported hydrogen in $\$/kg H_2$.

$$IC_{n,m,y} = (a^{it} * CAPEX_t^{it} + OPEX^{it}) + e_y^{it} * p_{n,y}^{el} + b^{it} * t^{it} * LCOH_{m,y} \quad (B.19)$$

where

e_y^{it} and $p_{n,y}^{el}$ are electricity need (constant) and price in importing country i and year y ,

b^{et} is the import terminal's boil-off in $\%/h$,

t^{et} is the average storage time in the import terminal's tanks in hours,

$LCOH_{m,y}$ is the cost of hydrogen that has been transported from m to n in $\$/kg H_2$.

Finally, transport costs of a route that combines pipeline and overseas transport are the sum of the sections:

$$TraC_{n,m,y}^{combined} = TraC_{n,m}^{pipe} + TraC_{n,m,y}^{sea} \quad (B.20)$$

⁴²It is assumed that the ship uses hydrogen as fuel. On the outward journey, the vessel can use some of the boiled-off hydrogen cargo as fuel. The boil-off is generally higher than the ship's fuel requirements. On the way back, the ship still needs sufficient residual hydrogen in its tanks to cover the fuel required for the return journey. Therefore, the fuel requirement is only calculated for one route (the return journey).

Appendix B.4. Calculation of total hydrogen supply costs

The LCOH from equations B.8, B.10 and B.11 gives the production costs for an investment made in a respective year y . The local hydrogen supply costs $HSC_{n,m,y}$ in year y are the sum of the production costs in country m and the transportation costs from country m to country n (equation B.21):

$$HSC_{n,m,y} = LCOH_{m,y} + TraC_{n,m,y} \quad (\text{B.21})$$

The minimum of equation B.21 is the most efficient pathway to supply hydrogen to country n . Local production cost results and suitable supply options for specific case study countries are discussed in section 4.3.

Appendix B.5. Generation of synthetic hourly RES profiles

Capacity factors for RES are taken from datasets of resource potential assessments. These data sets indicate clustered potentials with annual profiles, but not hourly capacity factors as required for optimisation.

Therefore, artificial RES hourly profiles are generated, which correspond exactly to the annual capacity factors from the data sets used. Hourly profiles for a full year are downloaded from renewables.ninja (Pfenninger and Staffell, 2016; Staffell and Pfenninger, 2016) once for each country and renewable energy source.⁴³ In order to generate synthetic hourly RES production profiles for each technology, country and resource class, an exponential scaling parameter is applied to an original hourly profile $HP_{n,h}^{res}$. The hourly profile is scaled using an exponential scaling factor $\sigma_{n,r}^{res}$, so that the sum of the hourly RES capacity factors $CF_{n,r,h}^{res}$, divided by the number of hours per year (8760) is equal to the annual capacity factor $CF_{n,r,y}^{res}$ for a particular resource class in a particular country:

$$(HP_{n,h}^{res})\sigma_{n,r}^{res} = CF_{n,r,h}^{res} \quad (\text{B.22})$$

$$\frac{\sum_{n=h}^{8760} CF_{n,r,h}^{res}}{8760} = CF_{n,r,y}^{res} \quad (\text{B.23})$$

where

$HP_{n,h}^{res}$ is the unscaled hourly profile of res in country n , with $HP_{n,h}^{res} = [0, 1]$,

$CF_{n,r,h}^{res}$ is the scaled hourly capacity factor of res in country n and resource class r , with $CF_{n,r,h}^{res} = [0, 1]$,

$CF_{n,r,y}^{res}$ is the annual capacity factor of res in country n and resource class r , with $CF_{n,r,y}^{res} = [0, 1]$,

⁴³An overview of coordinates for each country can be found in table C.10.

Figure B.13 illustrates the exponential scaling from the original capacity factor to three different higher capacity factors. To obtain a profile that is more representative of the true variability in single locations, rather than averaging over the entire area of the country or resource class, a single point is chosen to represent the hourly profile for a corresponding country. Using an exponential scaling factor has the advantage that the peaks and troughs of the original profile are preserved, while the overall distribution becomes smoother when scaled up to a higher capacity factor and more variable when scaled down to a lower capacity factor.

Figure B.13: Illustrative scaling of hourly capacity factor profile

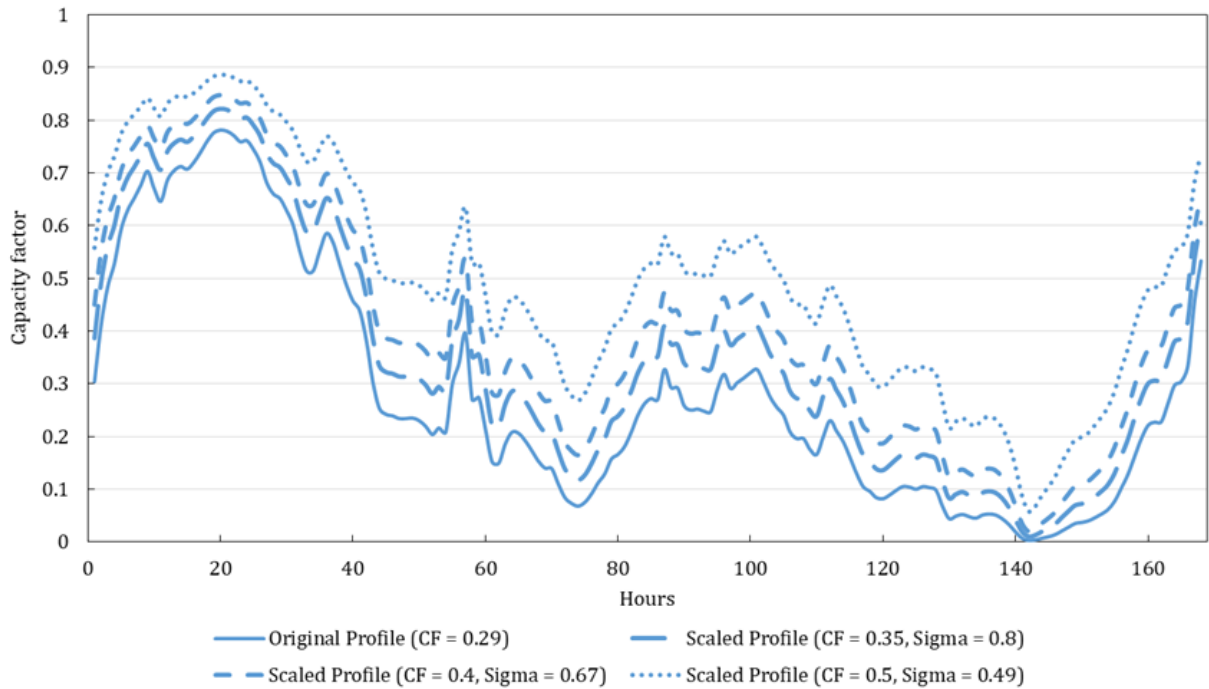

Original profile for 168 hours of onshore wind in Berlin from January 1-7.

For PV and Onshore Wind, the hourly capacity factor is the 2019 profile for selected points in each of the countries considered in this study, obtained from renewables.ninja (Pfenninger and Staffell, 2016). Table C.10 gives an overview of all point coordinates. The individual exponential scaling factors $\sigma_{res,n,r}$ for all combinations of res , countries n and resource classes r were derived through the application of a non-linear, numerical optimisation model. The model determines the optimal scaling parameter $\sigma_{n,r}^{res}$ by minimising the objective value OBJ , subject to the constraint given in equation B.26, which ensures that the algorithm chooses the correct $\sigma_{n,r}^{res}$ to scale the original profile $HP_{n,h}^{res}$ to the desired annual capacity factor.

$$\min OBJ \tag{B.24}$$

s.t.

$$OBJ = slack_{up} + slack_{down} \tag{B.25}$$

$$CF_{n,r,y}^{res} = \frac{\sum_{n=h}^{8760} HP_{n,h}^{res} \sigma_{n,r}^{res}}{8760} + slack_{up} - slack_{down} \tag{B.26}$$

where OBJ is the objective, $slack_{up}$ is a positive slack variable, with $slack_{up} \geq 0$ and $slack_{down}$ is a negative slack variable, with $slack_{down} \geq 0$.

Appendix C. Data

Appendix C.1. Countries and assumptions

Regions

Regional clustering is applied in line with [DNV GL \(2019\)](#). Abbreviations in the region column stand for NAM: North America; LAM: Latin America; EUR: Europe; MEA: Middle East and North Africa; NEE: North East Eurasia; SSA: Sub-Saharan Africa; CHN: Greater China; IND: Indian Subcontinent; SEA: South East Asia; OPA: OECD Pacific.

Hourly profiles

Profiles are taken from renewables ninja ([Pfenninger and Staffell, 2016](#); [Staffell and Pfenninger, 2016](#)) for point coordinates indicated in table [C.10](#)

Costs of CO₂ transport and storage

A weighted average is applied to calculate costs from [Hendriks and Bergen \(2004\)](#). Unrestricted storage includes all forms of storage, onshore and offshore. Original values are converted to \$ and adjusted to 2018\$.

Appendix C.2. RES learning rates in the literature

Table C.7: Overview of the recent literature on learning rates

RES	Reference	Learning rate	Description
PV			
	Comello et al. (2018)	20%	Module costs between 1979 and 2010
	ETIP-PV (2019)	30%	Expected LR for module prices in the next decade
	Fraunhofer ISE (2020)	25%	Module price LR in last 40 years
	IRENA (2020b)	40%	Utility scale solar PV installed cost LR forecast
	ITRPV (2020)	23.5%	LR from long-term module sales prices
	Mauleón (2016)	>27%	PV cost LR above 27% with a 95% probability
	Reichelstein and Sahoo (2018)	34%	long-run marginal costs LR
	Sivaram and Kann (2016)	18%	Historical LR until 2015
	Vartiainen et al. (2020)	20/30/40%	LRs for slow/best case/fast price decrease projection
General wind			
	Mauleón (2019)	12%	Project cost for wind parks
	Rubin et al. (2015a)	12%	Offshore & Onshore technology cost
	Wiser et al. (2016)	16-20%	Implicit LCOE LR for cumulative wind until 2030
	Williams et al. (2017)	9%	LR on LCOE
Onshore wind			
	IRENA (2020b)	23-29%	Onshore LCOE LR from 2010-2021
	Junginger et al. (2020a)	11.4%	Historical LR on onshore LCOE since 1990
	Wiser et al. (2016)	18.6%	Historical global LCOE learning rate
	Wiser et al. (2016)	14-18%	Implicit LR projection for onshore LCOE
Offshore wind			
	Costa (2019)	12.4%	LR on offshore LCOE 2011-2017
	IRENA (2020b)	10%	Offshore LCOE LR for projects 2010-2023
	Junginger et al. (2020b)	27%	CAPEX for wind parks with >250 MW & >20m water depth
	NREL (2020) ATB (moderate)	20%	Calculated from offshore CAPEX & IRENA REmap capacity
	Wiser et al. (2016)	8%	Estimated LCOE LR until 2030

Appendix C.3. Cumulative RES capacity additions in the IRENA REmap scenario

Table C.8: Cumulative global RES capacity additions

	2020	2030	2040	2050
PV installed (GW)	1113	3151	5761	8519
PV cumulated (GW)	1113	3151	5982	10651
Onshore wind installed (GW)	988	2309	3790	5044
Onshore cumulated (GW)	988	2309	4195	6693
Offshore installed (GW)	72	216	540	999
Offshore cumulated (GW)	72	216	552	1143

Because RES have to be decommissioned and replaced after 25 years of assumed lifetime, decommissioned capacities are added to obtain accumulated installed capacity for wind and PV.

Appendix C.4. Comparison of RES cost estimates with the literature

Table C.9: Comparison of major CAPEX and LCOE projections with own estimations

Reference		PV			Onshore			Offshore		
		2030	2040	2050	2030	2040	2050	2030	2040	2050
Literature										
IRENA (2019b)	CAPEX (\$/kW)	340-834	-	165-481	800-1350	-	650-1000	1700-3200	-	1400-2800
	LCOE (\$/MWh)	20-80	-	14-50	30-50	-	0.02-0.03	0.05-0.09	-	0.03-0.07
IEA (2019c)	CAPEX (\$/kW)	-	430-830	-	-	1160-1760	-	-	1460-2580	-
	LCOE (\$/MWh)	-	0.03-0.065	-	-	0.05-0.085	-	-	0.045-0.075	-
BNEF (2019)	CAPEX (\$/kW)	-	-	-	-	-	-	-	-	-
	LCOE (\$/MWh)	~0.045	-	~0.025	~0.037	-	~0.03	~0.037	-	~0.03
Teske (2019)	CAPEX (\$/kW)	730	560	470	1510	1450	1400	3190	2830	2610
	LCOE (\$/MWh)	-	-	-	-	-	-	-	-	-
DNV GL (2019)	CAPEX (\$/kW)	507-815	456-731	431-689	941-1495	879-1359	839-1272	2292-2914	2208-2785	2154-2702
	LCOE (\$/MWh)	0.037-0.07	0.03-0.056	0.025-0.055	0.037-0.084	0.034-0.071	0.032-0.068	0.061-0.1	0.057-0.08	0.055-0.076
Total range	CAPEX (\$/kW)	340-834	-	165-689	800-1510	-	650-1400	1700-3200	-	1400-2800
	LCOE (\$/MWh)	0.02-0.08	-	0.014-0.055	0.03-0.084	-	0.02-0.068	0.037-0.1	-	0.03-0.076
This study										
Base LR	CAPEX (\$/kW)	384-626	322-524	266-434	863-1441	802-1339	762-1271	2052-2713	1852-2449	1708-2258
	LCOE (\$/MWh)	0.023-0.06	0.019-0.05	0.016-0.04	0.028-0.09	0.026-0.08	0.024-0.076	0.05-0.38	0.045-0.33	0.04-0.3
Optimistic LR	CAPEX (\$/kW)	318-518	251-410	195-318	780-1301	702-1172	651-1087	1796-2374	1540-2036	1363-1802
	LCOE (\$/MWh)	0.02-0.05	0.015-0.04	0.012-0.03	0.026-0.08	0.023-0.073	0.022-0.068	0.047-0.35	0.039-0.29	0.034-0.25

Appendix C.5. Country and profile information

Table C.10: Full country information

Country	Region	Onshore & PV coordinates		Offshore coordinates		CCS cost (\$/t)	
		Longitude	Latitude	Longitude	Latitude	Unrestricted	Offshore only
Algeria	MEA	3.086472	36.737232	2.764252	36.891593	6.08	8.07
Angola	SSA	13.234444	-8.838333	13.683006	-11.274237	6.08	8.07
Argentina	LAM	-57.969559	-34.920345	-65.112497	-44.396911	9.93	10.42
Australia	OPA	149.128998	-35.282001	146.720189	-38.916195	12.43	12.12
Austria	EUR	16.363449	48.210033	-	-	8.45	8.90
Azerbaijan	NEE	49.867092	40.409264	50.497842	40.416625	21.07	34.22
Bahrain	MEA	50.606998	26.201001	50.774686	26.360307	10.93	35.57
Bangladesh	IND	90.399452	23.777176	91.736779	22.064911	11.26	10.92
Belarus	NEE	27.567444	53.893009	-	-	21.07	34.22
Belgium	EUR	4.351711	50.850339	2.974966	51.512907	8.45	8.90
Bolivia	LAM	-65.261963	-19.019585	-	-	6.83	8.71
Brazil	LAM	-47.882778	-15.793889	-40.793754	-21.761496	6.83	8.71
Brunei darussalam	MEA	114.939453	4.889694	114.481567	4.937166	11.42	12.63
Bulgaria	EUR	23.319941	42.698334	28.072589	42.821415	9.48	19.37
Cameroon	SSA	11.501346	3.844119	9.617127	2.736100	9.93	10.42
Canada	NAM	-75.695001	45.424721	-131.500513	53.851515	10.55	12.87
Chile	LAM	-70.673676	-33.447487	-71.452426	-29.831955	6.83	8.71
China	CHN	11.733017	40.846333	122.259134	30.909732	11.34	11.73
Colombia	LAM	-74.063644	4.624335	-77.552557	4.738221	6.83	8.71
Croatia	EUR	15.966568	45.815399	15.762576	43.419435	21.07	34.22
Czech Republic	EUR	14.418541	50.073658	-	-	9.48	19.37
Denmark	EUR	12.568337	55.676098	7.529094	55.656649	8.45	8.90
Dominican Republic	LAM	-69.929611	18.483402	-70.046872	18.214019	8.89	10.36
Egypt	MEA	31.233334	30.033333	30.334033	31.678836	6.08	8.07
Equatorial Guinea	SSA	8.781663	3.755781	9.576795	1.735380	9.93	10.42
Estonia	EUR	24.753574	59.436962	20.722967	55.728118	21.07	34.22
Finland	EUR	24.945831	60.192059	23.976852	59.851824	8.45	8.90
France	EUR	2.349014	48.864716	-2.742391	47.202829	8.45	8.90
Georgia	NEE	44.783333	41.716667	41.465224	42.163747	21.07	34.22
Germany	EUR	13.404954	52.520008	7.409051	53.916902	8.45	8.90
Ghana	SSA	-0.196901	5.556025	-0.471426	5.251925	9.93	10.42
Greece	EUR	23.727539	37.982813	25.486830	36.541305	9.48	19.37
Hungary	EUR	19.040236	47.497913	-	-	9.48	19.37
Iceland	EUR	-21.827774	64.128288	-16.992288	63.619733	8.45	8.90
India	IND	77.216721	28.644795	72.677288	18.757909	11.26	10.92
Indonesia	SEA	106.816666	-6.199987	101.556228	-3.493006	11.42	12.63
Iran	MEA	51.404343	35.715298	51.882292	27.675845	10.93	35.57
Iraq	MEA	44.361488	33.312805	48.625098	29.836197	10.93	35.57
Ireland	EUR	-6.266155	53.349996	-7.252736	52.028595	8.45	8.90
Israel	MEA	35.217018	31.771959	34.809070	32.624223	10.93	35.57
Italy	EUR	12.496366	41.902782	12.768698	44.149726	8.45	8.90
Japan	OPA	139.839478	35.652832	141.167345	37.295460	10.86	10.86
Kazakhstan	NEE	71.449074	51.169392	51.482481	46.934975	21.07	34.22

Country	Region	Onshore & PV coordinates		Offshore coordinates		CCS cost (\$/t)	
		Longitude	Latitude	Longitude	Latitude	Unrestricted	Offshore only
Kuwait	MEA	47.990341	29.378586	48.305813	29.196934	10.93	35.57
Libya	MEA	13.180161	32.885353	14.120382	32.880662	6.08	8.07
Malaysia	SEA	101.693207	3.140853	103.578921	3.637505	11.42	12.63
Mexico	LAM	-99.133209	19.432608	-105.970908	22.496933	8.89	10.36
Moldova	NEE	28.907087	47.003671	-	-	21.07	34.22
Morocco	MEA	-6.841648	34.020882	-7.360148	33.888460	6.08	8.07
Mozambique	SSA	32.588711	-25.953724	35.707949	-19.534613	10.04	10.04
Myanmar	SEA	96.129720	19.745000	94.312807	17.313531	11.42	12.63
Netherlands	EUR	4.895168	52.370216	4.264626	52.627737	8.45	8.90
Nigeria	SSA	7.491302	9.072264	3.575211	6.204284	9.93	10.42
Norway	EUR	10.757933	59.911491	4.856371	59.095572	8.45	8.90
Oman	MEA	58.545284	23.614328	59.159880	23.424497	10.93	35.57
Pakistan	IND	73.084488	33.438045	66.628908	24.706976	11.26	10.92
Papua New Guinea	SEA	147.150890	-9.477230	147.698683	-7.561372	12.43	12.12
Peru	LAM	-77.042793	-12.046374	-76.990071	-12.501116	6.83	8.71
Philippines	SEA	120.984222	14.995120	126.663693	8.078208	11.42	12.63
Poland	EUR	21.017532	52.237049	17.384011	54.991130	9.48	19.37
Portugal	EUR	-9.142685	38.736946	-9.109244	41.682254	8.45	8.90
Qatar	MEA	51.534817	25.286106	51.842368	25.119592	10.93	35.57
Republic of Korea	OPA	127.024612	37.532602	125.943429	34.513116	11.34	11.73
Romania	EUR	26.096306	44.439663	29.064786	44.416690	9.48	19.37
Russian Federation	NEE	37.618423	55.751244	29.333282	60.062179	21.07	34.22
Saudi Arabia	MEA	46.738586	24.774265	39.467980	20.312128	10.93	35.57
Singapore	SEA	103.851959	1.290270	103.621874	1.077362	11.42	12.63
Slovakia	EUR	17.107748	48.148598	-	-	9.48	19.37
Slovenia	EUR	14.505751	46.056946	13.351036	45.542545	9.48	19.37
South Africa	SSA	-33.431441	21.052866	18.903624	-34.488003	9.93	10.42
Spain	EUR	3.703791	40.416775	-2.875886	43.509849	8.45	8.90
Sweden	EUR	18.063240	59.334591	17.632432	61.184636	8.45	8.90
Switzerland	EUR	7.451123	46.947456	-	-	8.45	8.90
Syria	MEA	36.278336	33.510414	35.633162	35.241458	10.93	35.57
Taiwan	CHN	121.597366	25.105497	120.783397	24.709394	11.34	11.73
Thailand	SEA	100.523186	13.736717	100.152647	8.861925	11.42	12.63
Trinidad and Tobago	LAM	-61.521206	10.671067	-60.790541	10.456449	6.83	8.71
Tunisia	MEA	10.181667	36.806389	10.128552	37.430981	6.08	8.07
Turkey	MEA	32.866287	39.925533	29.402782	35.974174	10.93	35.57
Turkmenistan	NEE	58.383330	37.950000	52.362964	40.353905	21.07	34.22
Ukraine	NEE	30.517023	50.431759	30.798417	46.166125	21.07	34.22
United Arab Emirates	MEA	54.366669	24.466667	54.443660	25.044579	10.93	35.57
United Kingdom	EUR	-0.118092	51.509865	1.120625	51.581845	8.45	8.90
United States	NAM	-95.358421	29.749907	-120.920998	34.376985	13.43	16.33
Uzbekistan	NEE	69.240562	41.311081	-	-	21.07	34.22
Venezuela	LAM	-66.916664	10.500000	-66.130320	10.814753	6.83	8.71
Vietnam	SEA	105.804817	21.028511	105.735775	9.027149	11.42	12.63
Yemen	MEA	44.191006	15.369445	45.434282	12.960379	10.93	35.57

The point coordinates in the table designate the location of the 2019 hourly profile obtained from renewables.ninja (Pfenninger and Staffell, 2016; Staffell and Pfenninger, 2016) that serves as the starting point for the estimation of the RES resource class-specific synthetic hourly profiles described in Appendix B.5.

Appendix C.6. CO₂ price

Advanced Economies:

Australia, Austria, Belgium, Bulgaria, Canada, Chile, Croatia, Cyprus, Czech Republic, Denmark, Estonia, Finland, France, Germany, Greece, Hungary, Iceland, Ireland, Israel, Italy, Japan, Korea, Latvia, Lithuania, Luxembourg, Malta, Mexico, Netherlands, New Zealand, Norway, Poland, Portugal, Romania,

Slovak Republic, Slovenia, Spain, Sweden, Switzerland, Turkey, United Kingdom and United States.

Emerging Economies:

All other.

Table C.11: Assumptions for global CO₂ price

Region	2020	2030	2050
Advanced economies (\$/tCO ₂)	28	100	160
Emerging economies (\$/tCO ₂)	16	75	145

Table C.12: Techno-economic assumptions for transport infrastructure

		2020	2030	2040	2050
Pipeline	Lifetime (years)	40	40	40	40
	CAPEX (\$/tpa/km)	4	4	4	4
	OPEX (%CAPEX/a)	5	5	5	5
	Utilization (%)	75	75	75	75
Ship	Lifetime (years)	30	30	30	30
	CAPEX (\$/t)	37,455	33,709	25,282	16,855
	OPEX (%CAPEX/a)	4	4	4	4
	Speed (km/h)	30	30	30	30
	Berthing time (h)	48	48	48	48
	Fuel use (MJ H ₂ /km)	1,487	1,487	1,487	1,487
	Boil off (%/day)	0.2	0.2	0.2	0.2
Export Terminal	Lifetime (years)	30	30	30	30
	CAPEX (\$/tpa)	747	672	504	336
	OPEX (%CAPEX/a)	4	4	4	4
	Electricity use (kW/kg H ₂)	0.61	0.61	0.61	0.61
	Boil-off (%/day)	0.1	0.1	0.1	0.1
Import Terminal	Lifetime (years)	30	30	30	30
	CAPEX (\$/tpa)	4,939	4,445	3,334	2,223
	OPEX (%CAPEX/a)	4	4	4	4
	Electricity use (kW/kg H ₂)	0.2	0.2	0.2	0.2
	Boil-off (%/day)	0.1	0.1	0.1	0.1
Liquefaction	Lifetime (years)	30	30	30	30
	CAPEX (\$/tpa)	5,385	4,846	4,362	3,877
	OPEX (%CAPEX/a)	4	4	4	4
	Electricity use (kWh/kg H ₂)	6.1	6.1	6.1	6.1
	Availability (%)	90	90	90	90

Offshore pipeline costs are assumed to be 25% higher than onshore pipeline costs (Gerwen et al., 2019). Assumptions for ships and terminals are based on IEA (2019a), cost reductions are calculated based on projections of Wijayanta et al. (2019, table 7), who project a 20% cost reduction for liquefaction cost, a 50% reduction for shipping cost and a 45-55% cost reduction for import and export terminals from 2030 to 2050. A storage length of 3 days for export terminals and 20 days for import terminals is assumed (Mizuno et al., 2016). In line with this, cost reductions are applied to initial numbers, the results can be found in table CITE. Additionally, in this paper, 10% cost reduction from 2020 to 2030 is assumed for every technology in the seaborne transport supply chain.

Appendix D. Supplementary Results

Appendix D.1. Effects of RES-to-electrolyser capacity ratio optimisation on LCOH

The general optimisation principle is that the ratio of installed electrolysis to RES capacity is adjusted to minimise costs. In optimum, a larger proportion of RES capacity is installed relative to electrolyser capacity, which is expressed by the optimal RES-to-electrolyser ratio S^* . Optimising RES-to-electrolyser capacities yields effects on the costs for all RES types as it decreases LCOH. Figure D.14 shows the relative decrease in

LCOH through optimisation compared to an equal capacity of RES and electrolyser. Relative cost decreases are higher for PV than for wind: PV capacity factors are generally lower, which is a disadvantage concerning production costs, as it leads to a lower electrolyser utilisation and makes electrolysis costs more significant per kg of hydrogen. The optimisation generally increases the electrolyser utilisation and decreases the share of electrolyser costs in the total LCOH. As a consequence, the disadvantage of low PV capacity factors partially disappears, leading to higher relative LCOH decreases.

The slight kinks in the curve at the point of the year 2030 are based on the assumptions about the CAPEX of the electrolyser. Since values are only available for 2020, 2030, and 2050, CAPEX numbers are interpolated linearly between these years. Therefore, the electrolyser CAPEX curve changes its slope at 2030, which is also visibly reflected in the relative cost improvement through optimisation. Optimising capacity ratios decreases electrolyser costs and increases the LCOE per kg of hydrogen. The mean LCOE increase is roughly constant for PV, at 9-10%. A slight decrease in additional LCOE is observable over time for wind, from 6% in 2020 to 4% in 2050 for onshore, and from 5% in 2020 to 4% in 2050 for offshore wind. According to study assumptions, excess electricity that cannot be processed by the electrolyser due to capacity limitations is thrown away. Should it be worthwhile to feed excess power into the grid instead, this would decrease LCOE for hydrogen production in the case with optimisation and thus further decrease LCOH.

Figure D.14: Relative PV and onshore wind LCOH reduction through optimisation compared to the case without optimisation

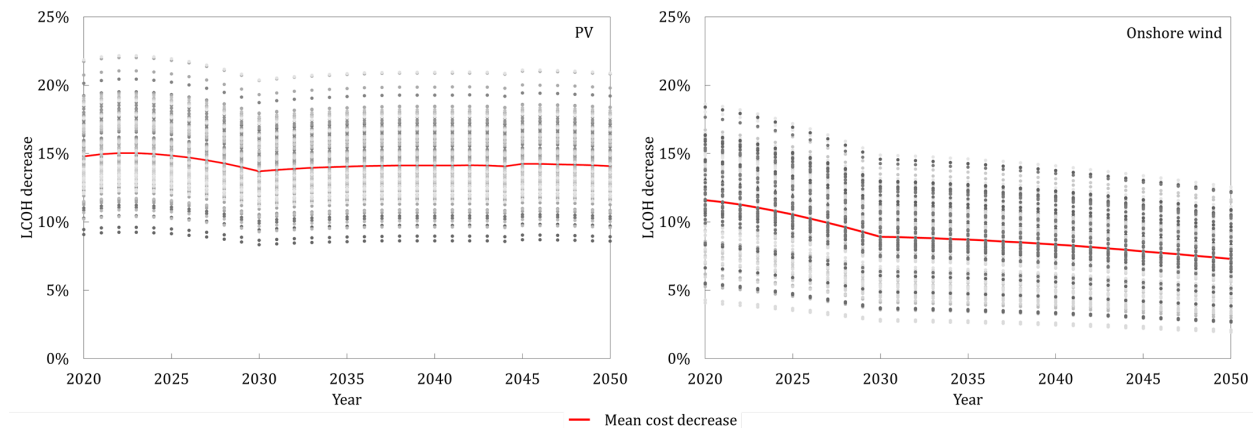

The relative decrease is calculated by comparing LCOH in the case of a 1:1 ratio of RES and electrolyser capacity to the LCOH in the case with an optimised ratio and utilisation. Grey dots indicate relative LCOH decreases for all individual resource classes and years of PV (left) and onshore wind (right). Results are for low-temperature electrolyzers and baseline assumptions.

Figure D.15 shows the results for optimal ratios of RES and a low-temperature electrolyser under baseline assumptions. The grey dots visualise time series for each country and resource class in the figures. The distribution of optimal capacity ratios is wider for onshore wind than for PV. This is because the distribution of global capacity factors is more scattered for onshore wind than for PV, leading to a greater interval of optimal ratios, between 2.5 and 1.3. The exact optimal ratio depends on the local hourly electricity

Figure D.15: Optimal RES-to-electrolyser capacity ratio for PV and onshore wind

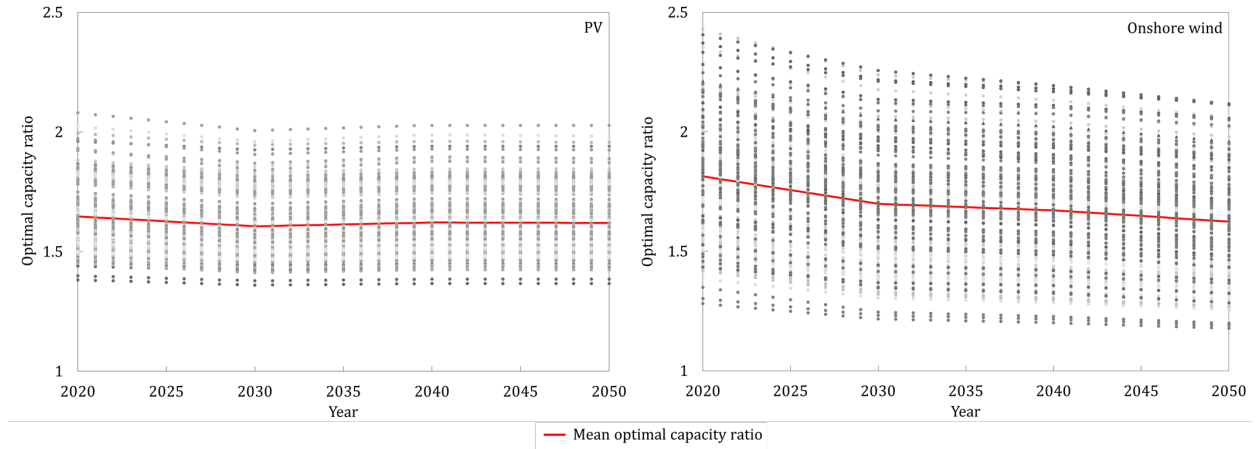

Grey dots indicate results for optimal RES-to-electrolyser ratios for all individual resource classes of PV (left) and onshore wind (right). Results are based on baseline assumptions and low-temperature electrolysis.

generation profile of the wind turbines. The mean optimal RES-to-electrolyser capacity ratio stays constant for PV at 1.6 and decreases for onshore wind, from 1.8 in 2020 to 1.6 in 2050. This is mainly due to different development of relative RES-to-electrolyser cost ratios: The ratio of electrolyser cost to PV cost per kW and year, and consequently also the optimal capacity ratio, remains roughly constant over the years. As learning rates for onshore wind are lower, electrolysis costs drop faster than the onshore wind costs, making electrolysis relatively cheaper. As a result, a high utilisation of the electrolyser system becomes less important, leading to a lower optimal ratio and a lower electrolyser utilisation. Relative cost improvements through optimisation also decrease for onshore wind from 12% in 2020 to 7% in 2050, as shown in figure D.14. LCOH improvements roughly stay constant for PV at a mean of 15%.

Appendix D.2. Potential cost advantages of hybrid systems

Some studies consider hydrogen production from hybrid renewable wind and PV systems (Fasihi et al., 2016; Fasihi and Breyer, 2020; Niepelt and Brendel, 2020; Jensterle et al., 2020; Ram et al., 2019). In a hybrid system, a combination of onshore wind and PV cells is coupled to an electrolyser, which leads to a higher capacity factor of the whole system and reduces the overall intermittency of the electricity supply. Consequently, due to a higher electrolyser utilisation, the LCOH could be lower, which would give the hybrid system a cost advantage over pure wind or PV systems. The decisive factor for the efficient use of capacities is the percentage overlap or balance between the hourly production profiles of the wind and solar components. Estimates for overlap hours of PV and wind range between 5%–25% (Breyer, 2012, p. 386ff). Simulated runs of the optimisation model used in this study, allowing for a pairing of wind and PV capacity, showed that the hybrid systems do lead to a lower LCOH in some cases. However, this is only the case if the best potentials of PV and onshore wind of a country are combined in a hybrid system. Therefore, it would be

necessary to assume that the best wind and PV areas overlap, which seems unlikely for most countries. As soon as one RES has much better conditions than the other, a combination is no longer worthwhile. Instead, it is more cost-effective to produce hydrogen using the cheaper RES exclusively. The big advantage of a hybrid system in the studies without capacity optimisation is a higher installed RES-to-electrolyser capacity ratio,⁴⁴ which increases the electrolyser’s utilisation. But as soon as all capacity ratios are optimised, all electrolyzers are run at a minimum cost, and the relative advantage of hybrid systems is partially lost. Consequently, this study is not considering hybrid systems.

Appendix D.3. Hydrogen supply cost case study: United States

In contrast to Japan, the United States offers excellent conditions for low cost domestic low-carbon hydrogen production. The country is the world’s largest natural gas producer and therefore has access to inexpensive natural gas (IEA, 2019d). There are also favourable areas for renewable energies, which are rich in wind and sunshine. However, the United States is a large country, and good RES potentials are often located far away from demand centres. Thus, supply costs for domestically produced hydrogen could slightly increase for most regions within the United States, as hydrogen potentially needs to be transmitted over substantial distances.

Table D.13: Top ten low-cost resource classes for supply of hydrogen from RES in the United States 2050 under baseline assumptions

Country	RES resource class	RES Potential (GW)	H ₂ Potential (Mt/a)	LCOH (\$/kg)	Transport (\$/kg)	H ₂ supply cost (\$/kg)
United States	PV 1	50.1	2.1	1.9	-	1.9
United States	PV 2	3895.8	154.8	2.0	-	2.0
United States	PV 3	23677.0	894.6	2.0	-	2.0
United States	PV 4	203291.2	6476.8	2.4	-	2.4
United States	Onshore 2	211.0	12.7	2.5	-	2.5
Colombia	Onshore 1	8.3	0.9	1.6	1.4	3.0
Venezuela	Onshore 1	45.5	4.5	1.7	1.4	3.1
Canada	Onshore 1	2.6	0.2	1.9	1.2	3.1
China	Onshore 1	2.5	0.2	1.6	1.5	3.1
Venezuela	PV 1	57.9	2.4	1.7	1.4	3.1

Table D.13 shows the best resource classes of hydrogen from RES under baseline assumptions in 2050. The ranking with all four domestic PV resource classes on top shows how immense the potential for PV electricity is and how potentials increase with decreasing capacity factors. The best resource class PV 1 still has a relatively limited theoretical potential of 2.1Mt/a. For PV 2, it is already 154Mt/a; the PV 3 potential of 895Mt/a exceeds all projections for potential global hydrogen demand in 2050.⁴⁵ As supply

⁴⁴Usually, a ratio of one is installed. For hybrid plants, wind and PV are paired to an electrolyser, leading to a capacity ratio of two.

⁴⁵The highest projected hydrogen demand comes from Hydrogen Council (2017) where up to 650Mt/a are estimated as global demand in 2050.

costs could slightly vary for different regions within the country, regions with favourable RES potential would have advantages: Strong wind exists in the Midwest, good PV conditions in the southwest. Accordingly, hydrogen from RES would probably cost less on the US West Coast than on the East Coast. As shown in figure D.16, transporting hydrogen increases costs so that imports are not competitive compared to the favourable domestic RES potentials. However, despite low costs for hydrogen from RES, the conversion of natural gas to hydrogen will probably be the cheapest solution in the United States in the long term. Under optimistic assumptions, domestic hydrogen costs could fall to \$1.2/kg in the long run. At the natural gas prices projected by the IEA (2019a), pyrolysis would still be cheaper at \$1.14/kg. If upstream costs for domestic gas production were taken as inputs, costs for natural gas reforming and pyrolysis would decrease further.

Figure D.16: Comparison of hydrogen supply costs in the United States 2050

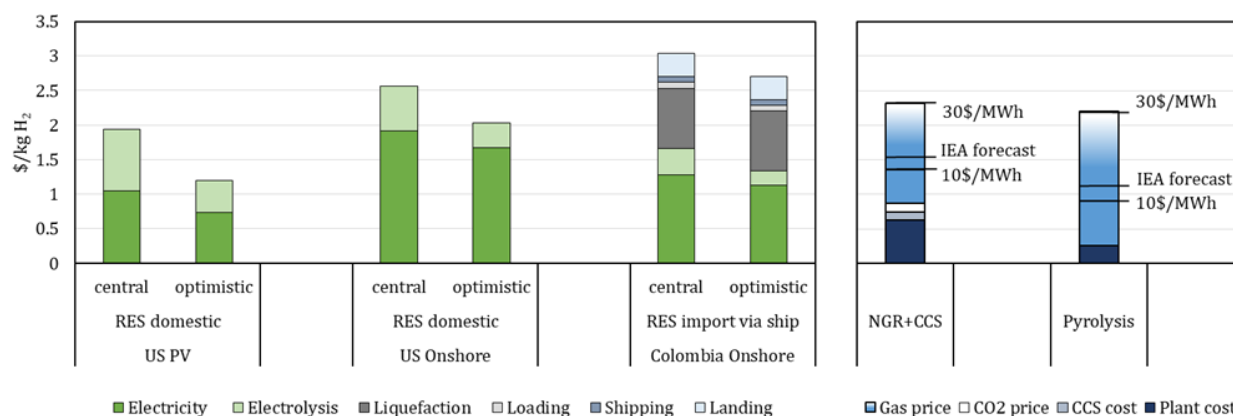

Black lines for hydrogen from natural gas indicate hydrogen costs for different gas prices. Figure D.19 in the Appendix shows a cost comparison for 2030.

For the United States, the following conclusions can be drawn from the above analysis:

- As large potentials for cheap renewable electricity exist, importing hydrogen from RES is not competitive. Instead, the US could potentially become a hydrogen exporter.
- Despite low costs for domestic RES, hydrogen from natural gas, especially from pyrolysis, will probably be the cheapest form of low-carbon hydrogen production in the medium and long term.
- Gas prices and favourable RES conditions leads to particularly low hydrogen costs that could fall to \$1/kg by 2050.

Figure D.17: Comparison of hydrogen supply costs in Germany 2030

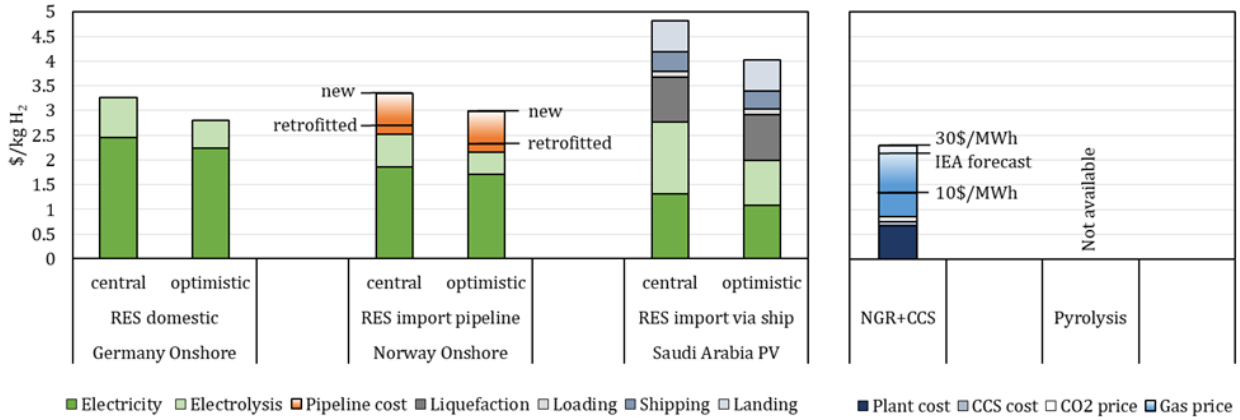

Black lines for RES import via pipeline indicate cost levels for different types of pipeline transport, a retrofitted pipeline and a high cost new pipeline. The same applies for hydrogen from natural gas, where black lines indicate costs for different gas prices.

Figure D.18: Comparison of hydrogen supply costs in Japan 2030

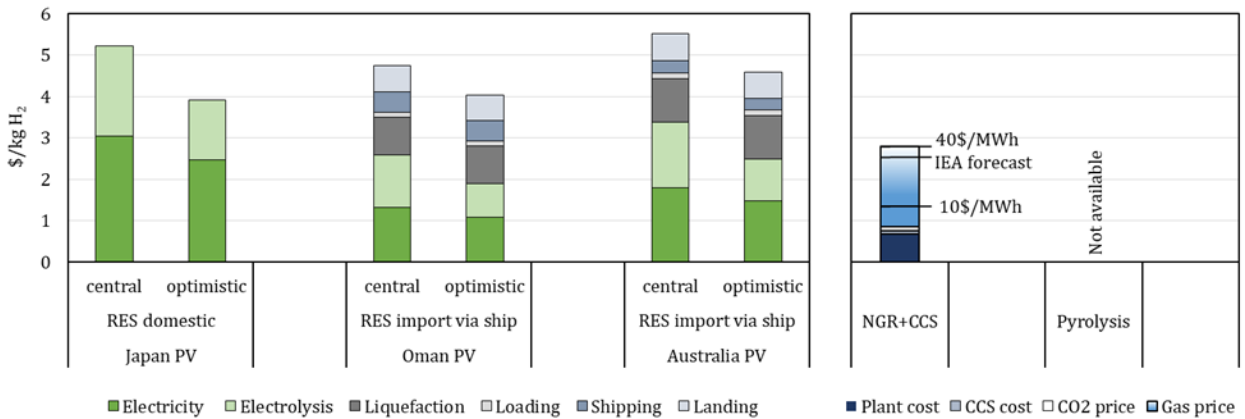

Black lines indicate costs for different gas prices.

Figure D.19: Comparison of hydrogen supply costs in the US 2030

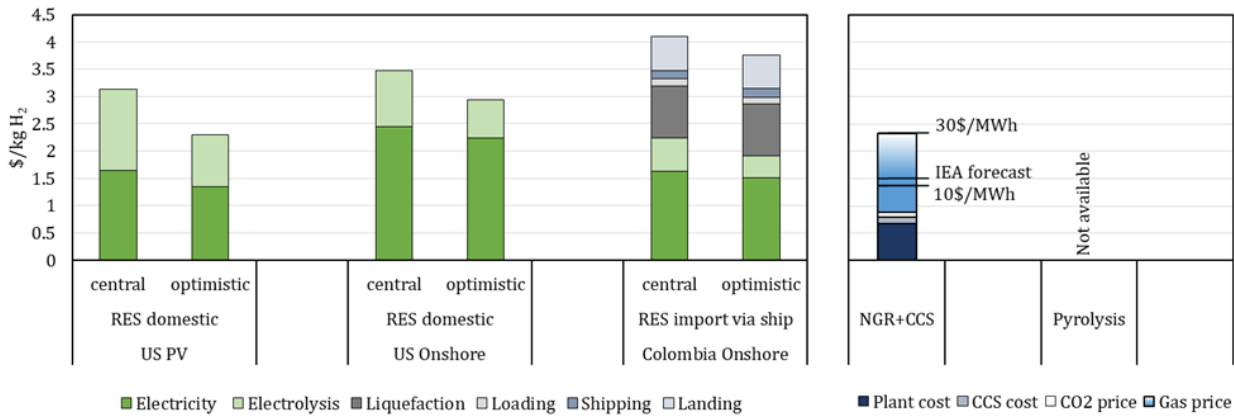

Black lines indicate costs for different gas prices.

This section compares the estimates for production and supply costs with existing literature. The comparison's focus is mainly on hydrogen from RES because there are more studies and higher differences in estimates compared to hydrogen from natural gas.

Appendix D.5. Cost of hydrogen from RES: Comparison to literature estimates

A comparison of production cost results from this study and recent estimates from the literature is shown in figure D.20 for hydrogen from RES. There is a wide scattering of cost estimates from the literature; production costs of hydrogen from RES vary for different WACC and CAPEX assumptions. Cost estimates derived in this study under baseline assumptions are located within the interval of literature estimates.

The LCOH projection from BNEF (2020) is significantly lower than estimates from other studies because lower assumptions are made for capital expenditures, especially for electrolyzers. According to BNEF (2019), alkaline electrolyzers could cost 115\$/kW in 2030, sliding further to 80\$/kW until 2050. These assumptions are substantially lower than in the other studies and also significantly lower than optimistic assumptions in this study. If BNEF is considered a downward outlier, cost results in the literature for the short and medium term are higher than the results obtained by this study (section 4.1). This changes in the long run, where some studies project even lower costs.

IRENA (2019a) estimates current hydrogen costs of 6\$/kg for PV and 4.4\$/kg for wind and expects costs to decrease to an average of 2\$/kg for PV and 1\$/kg for wind. Thus, IRENA projects a higher relative cost reduction. Its estimates for long-term production costs are roughly at the level of this study under optimistic assumptions. The poor performance of PV compared to wind is partly due to IRENA's assumption on electrolyser capacity utilisation being equal to the capacity of RES. It leads to a disadvantaged position of PV due to a generally lower PV capacity factor. On the contrary, the optimisation of RES-to-electrolyser ratios in this study reduces PV's relative disadvantage, making it the cheapest source for hydrogen from RES in the long run.

Figure D.20: Classification of results for hydrogen from RES under baseline assumptions

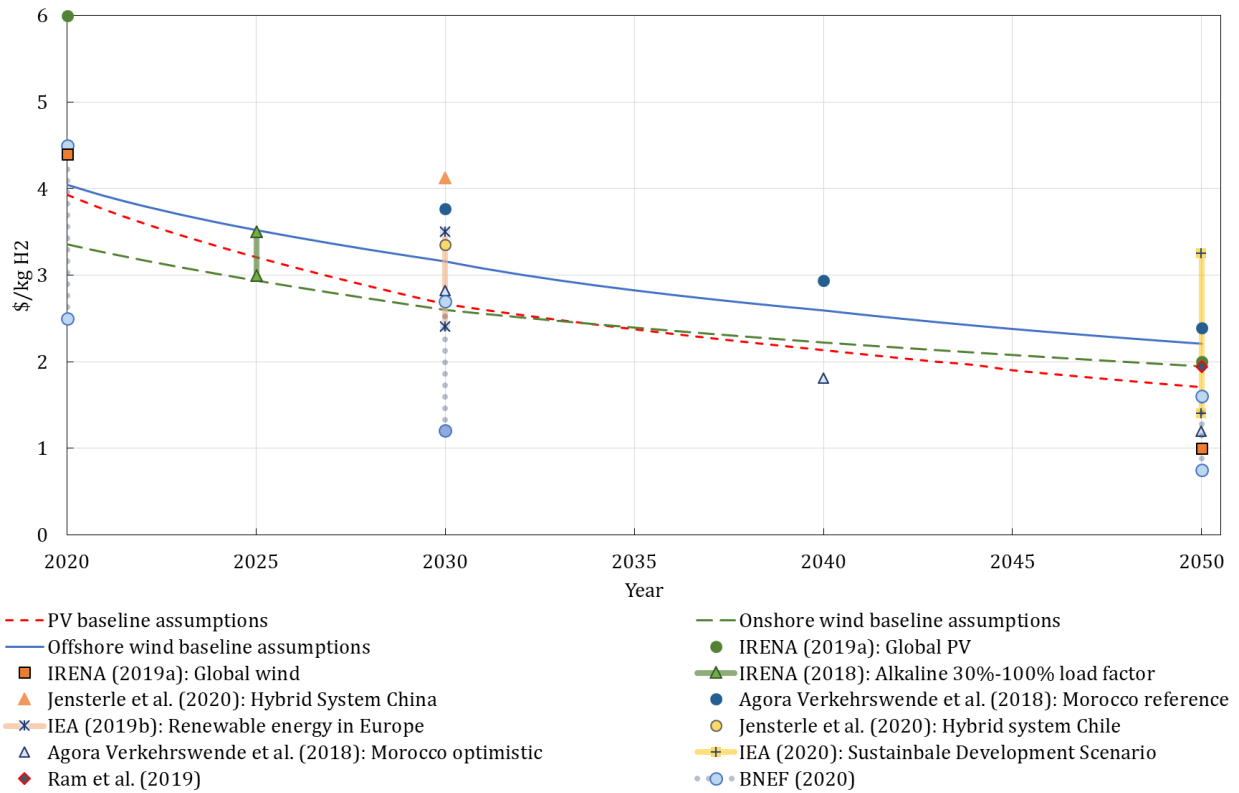

Results shown for this study are weighted mean values of the respective Top 20 global RES potentials, as elaborated in section 4.1. For studies where a cost interval is given, the upper and lower limits are marked as points and connected by a line.

Agora Verkehrswende et al. (2018) provide hydrogen production costs for PV in Morocco for 2050 and report \$2.39/kg in a reference and 1.19\$/kg in an optimistic scenario. This study’s results are slightly lower with \$1.77-\$2/kg under baseline assumptions and \$1.04-\$1.18/kg under optimistic assumptions. Just like IRENA (2019a), Agora Verkehrswende et al. (2018) also assume an electrolyser utilisation according to the capacity factor of the PV plant, lower estimates in this study are therefore mainly due to the optimisation of the RES-to-electrolyser ratio. An estimation of costs with the assumption of equal RES and electrolyser capacity in this study yields \$1.13-\$1.3/kg under optimistic assumptions and \$2-\$2.3/kg under baseline assumptions. Hence, these cost estimates would directly correspond with the literature.

In projections from the IEA (2020), production costs for hydrogen from electrolysis start from a minimum of \$1.4/kg in 2050. This result is very close to this study, where \$1.5/kg is the minimum production cost under baseline assumptions. Many assumptions are in line with those of the IEA, which partly explains the similarity of results.

Appendix D.6. Hydrogen supply costs: Comparison to literature estimates

It is difficult to compare supply costs for a given country with other studies as different assumptions exist concerning transport, storage, and end-use. Nevertheless, the following section compares this study's results with other estimates for supply costs. The primary purpose is to identify different approaches used to estimate supply costs for a given country.

According to [BNEF \(2020\)](#), supply costs as low as \$2/kg in 2030 and \$1/kg in 2050 could be achievable in many parts of the world. Again, BNEF expect much lower costs than other studies, which is mainly due to the very low assumed CAPEX (figure [D.20](#)). In contrast, estimates from other studies on long term hydrogen supply costs are relatively high compared to the results of this analysis.

[Jensterle et al. \(2020\)](#) analyse import potentials for Germany, where the lowest hydrogen cheapest supplies in 2030 come as an import from Norway with a border price of \$5.47/kg. These estimates are substantially higher than the estimates of this study due to higher hydrogen production costs, which [Jensterle et al. \(2020\)](#) expect to be \$4.84/kg in 2030 for the case of Norway.

[Pfennig et al. \(2017\)](#) analyse the potential for import of hydrogen via LH₂-shipping from Morocco to Germany and estimate costs of \$5.17/kg in 2030 and \$4.19/kg in 2050. In contrast, this analysis finds that LH₂ imports are not worthwhile, especially for Germany. Instead, hydrogen from Morocco would best be transported via retrofitted pipelines. Import costs for a ship transport from Morocco in this analysis would be at \$5.14/kg in 2030 and \$3.45/kg in 2050 and, therefore, lower than in [Pfennig et al. \(2017\)](#). The main reason for these differences is that electricity generation costs (LCOE) in Morocco are projected by [Pfennig et al. \(2017\)](#) to fall less than assumed by this study.

According to the [IEA \(2019b\)](#), hydrogen from Australia could be delivered to Japan at a price of \$5.5/kg in 2030, which corresponds almost exactly to the results of this analysis. However, IEA estimates are for ammonia transport, whereas LH₂ transport, as assumed in this study, would cost \$7/kg according to the IEA, mainly due to higher electricity prices that increase costs for liquefaction and transport terminals.

[Heuser et al. \(2020\)](#) assess a global provision scheme for hydrogen and estimate \$4/kg for hydrogen supply to Germany and the US and \$4.5/kg for hydrogen supply to Japan. This study's results are significantly lower, at about \$2/kg for domestic hydrogen in the US, slightly above \$2/kg for supply in Germany, and \$3.3/kg for Japan. Different results can mainly be explained by different research focuses: [Heuser et al. \(2020\)](#) exclusively consider production and trade of hydrogen from RES. For this purpose, they pre-select hydrogen production regions and include domestic hydrogen transport. In contrast, this paper gives a global estimate of hydrogen production costs without pre-selection; hydrogen production is not limited to certain regions. Besides, this analysis considers hydrogen from natural gas as an alternative production route to hydrogen from RES. Thus, results suggest that, for example, the United States could probably produce

low-carbon hydrogen more cost-effectively from natural gas than from RES;⁴⁶ above all, they will probably not import hydrogen. In Heuser et al. (2020), on the other hand, it is assumed that there is no sufficient competitive domestic RES production potential so that the United States has to import hydrogen.

To summarise the points made above, supply cost estimates for countries vary from study to study due to differences in assumptions. LCOH projections depend on techno-economic assumptions; different initial inputs inevitably lead to different results – differing pathways for transport impact import costs. Shipping is especially expensive: if ship transport is used as an exclusive form of hydrogen transport, overall supply costs increase. Another key feature, which affects the results for lowest supply costs, is that production regions are pre-selected in most existing studies. Consequently, hydrogen production is limited to these regions, a predetermined structure that also affects the results. The advantage of this study is that it integrates a large number of countries without pre-selection. Thus, there is a broad basis for hydrogen production cost estimation, and many countries are considered as potential exporters.⁴⁷

⁴⁶The preference depends mainly on the future gas price since supply costs for hydrogen from natural gas are very sensitive to changes in gas price. In IEA (2020), SMR with CCS ranges from \$1.1-\$2.1/kg in 2050 for gas prices of \$6-\$25/MWh, which is also roughly the result in this study.

⁴⁷With this complete mapping of global structures, a worldwide hydrogen trade could be modelled in a next step.