

Taniguchi, Shinichi

Working Paper

Securing access to electricity with variable renewable energy in the Philippines: Learning from the Nordic model

ADB Working Paper Series, No. 1009

Provided in Cooperation with:

Asian Development Bank Institute (ADBI), Tokyo

Suggested Citation: Taniguchi, Shinichi (2019) : Securing access to electricity with variable renewable energy in the Philippines: Learning from the Nordic model, ADB Working Paper Series, No. 1009, Asian Development Bank Institute (ADBI), Tokyo

This Version is available at:

<https://hdl.handle.net/10419/222776>

Standard-Nutzungsbedingungen:

Die Dokumente auf EconStor dürfen zu eigenen wissenschaftlichen Zwecken und zum Privatgebrauch gespeichert und kopiert werden.

Sie dürfen die Dokumente nicht für öffentliche oder kommerzielle Zwecke vervielfältigen, öffentlich ausstellen, öffentlich zugänglich machen, vertreiben oder anderweitig nutzen.

Sofern die Verfasser die Dokumente unter Open-Content-Lizenzen (insbesondere CC-Lizenzen) zur Verfügung gestellt haben sollten, gelten abweichend von diesen Nutzungsbedingungen die in der dort genannten Lizenz gewährten Nutzungsrechte.

Terms of use:

Documents in EconStor may be saved and copied for your personal and scholarly purposes.

You are not to copy documents for public or commercial purposes, to exhibit the documents publicly, to make them publicly available on the internet, or to distribute or otherwise use the documents in public.

If the documents have been made available under an Open Content Licence (especially Creative Commons Licences), you may exercise further usage rights as specified in the indicated licence.



<https://creativecommons.org/licenses/by-nc-nd/3.0/igo/>



ADB Working Paper Series

**SECURING ACCESS TO ELECTRICITY
WITH VARIABLE RENEWABLE ENERGY
IN THE PHILIPPINES: LEARNING FROM
THE NORDIC MODEL**

Shinichi Taniguchi

No. 1009
September 2019

Asian Development Bank Institute

Shinichi Taniguchi is a doctoral program fellow in international studies at the Graduate School of Asia-Pacific Studies of Waseda University.

The views expressed in this paper are the views of the author and do not necessarily reflect the views or policies of ADBI, ADB, its Board of Directors, or the governments they represent. ADBI does not guarantee the accuracy of the data included in this paper and accepts no responsibility for any consequences of their use. Terminology used may not necessarily be consistent with ADB official terms.

Working papers are subject to formal revision and correction before they are finalized and considered published.

The Working Paper series is a continuation of the formerly named Discussion Paper series; the numbering of the papers continued without interruption or change. ADBI's working papers reflect initial ideas on a topic and are posted online for discussion. Some working papers may develop into other forms of publication.

Suggested citation:

Taniguchi, S. 2019. Securing Access to Electricity with Variable Renewable Energy in the Philippines: Learning from the Nordic Model. ADBI Working Paper 1009. Tokyo: Asian Development Bank Institute. Available: <https://www.adb.org/publications/securing-access-electricity-variable-renewable-energy-philippines>

Please contact the authors for information about this paper.

Email: sr-taniguc1207@pf6.so-net.ne.jp

I would like to thank Hitoshi Mitomo and John W. Cheng* for useful comments about the structure of this study and relevant ideas. My thanks also go to Editage (www.editage.jp) for the proofreading and English language editing.

* Graduate School of Asia-Pacific Studies, Waseda University.

Asian Development Bank Institute
Kasumigaseki Building, 8th Floor
3-2-5 Kasumigaseki, Chiyoda-ku
Tokyo 100-6008, Japan

Tel: +81-3-3593-5500
Fax: +81-3-3593-5571
URL: www.adbi.org
E-mail: info@adbi.org

© 2019 Asian Development Bank Institute

Abstract

Although access to electricity has improved in the Philippines, the country still faces an energy insecurity problem. The country is highly dependent on coal power and large-scale transmission lines to meet its growing demand for electricity; while aiming to supply electricity to the cities, rural areas have fallen behind. This approach has resulted in higher electricity rates, urban and rural inequality in electricity distribution, and a huge environmental impact, while the system reliability is at risk.

Variable renewable energy (VRE) plays a key role in resolving this problem, because of its abundance and a recent trend for cost competitiveness. The Nordic model provides useful suggestions in integrating a high share of VRE, but it has a limitation in the interconnection of underdeveloped power grids with off-grid areas, like in the Philippines. Constructing an effective interconnector is difficult, because it is subject to the future installation of VRE.

There is an alternative measure: the distributed VRE model. The Nordic model also provides useful suggestions, such as the requirement for flexible resources (e.g., hydroelectric and storage resources). This model is beneficial in improving the local electrification rate and the energy consumption rate (ECR) per capita, leading to economic growth. The last analysis indicates that the combination of VRE and storage would be more cost-competitive than the traditional fossil fuel generation model.

Keywords: VRE, Nordic model, interconnector, rural electrification, energy consumption rate, ECR, distributed model

JEL Classification: C3, N55, Q21, Q28, Q41, Q42, Q54, R11

Contents

1.	INTRODUCTION	1
2.	LITERATURE REVIEW	4
3.	STEP 1: LEARNING FROM THE NORDIC INTERCONNECTOR MODEL—HOW A FLEXIBLE SYSTEM WORKS.....	8
3.1	Methods: Modeling the Denmark Interconnecting System	8
3.2	Empirical Study of the Nordic Model	9
4.	STEP 2: APPLICATION OF THE INTERCONNECTOR MODEL TO THE PHILIPPINES AND ITS LIMITATIONS	11
4.1	Methods.....	11
4.2	Results	14
5.	STEP 3: AN ALTERNATIVE MEASURE TO OVERCOME THE LIMITATION—DISTRIBUTED VRE MODEL	17
5.1	Methods.....	17
5.2	Results	19
6.	DISCUSSION AND CONCLUSION.....	21
	REFERENCES	23

1. INTRODUCTION

Global electricity consumption is expected to grow steadily until 2040, with the Asia-Pacific region gaining in share and Southeast Asia contributing significantly (Figure 1) (IEA 2018). Their increase in generation capacity is largely dependent on coal generation (IEA 2018). Among the countries with fast-growing economies, the Philippines shows a stable growth rate (Figure 2), being average among Southeast Asian countries. The Philippines' frequency of power outage is relatively high as is the transmission and distribution loss (IEA 2017a). The country enacted the first comprehensive renewable energy legislation in Southeast Asia (IRENA 2017). The reason I chose the Philippines for my study is as follows: a mix of high electricity rate (compared with other countries) (Figure 3), high frequency of electricity outage, and relatively high rate of renewable energy penetration indicates potential problems that lie ahead.

Figure 1: Electricity Generation of the World and Asia (TWh)

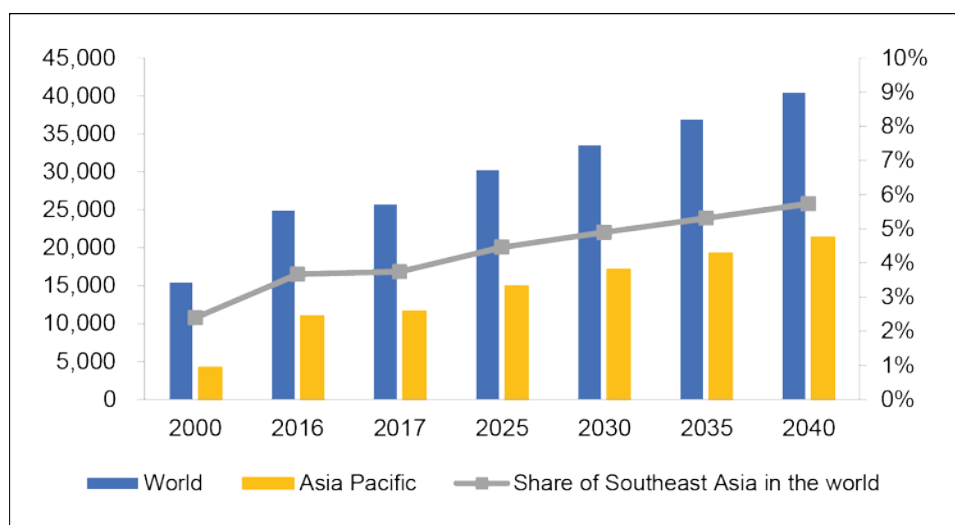

Source: IEA 2018.

The Philippines faces three energy insecurity problems: 1) electricity demand is growing fast; 2) the supply of electricity is often short of demand; 3) the discrepancy in electrification rate between cities and rural areas.

First, the Philippines plans to enhance the generation capacity by approximately three times the 2017 level by 2040 (Department of Energy (DOE) Philippines 2017a). The country is heavily dependent on coal for its electricity supply. Population and electricity demand are growing steadily and the reserve margin is low. Most of the additional capacity is compensated for by coal generation. Even coal generation is expected to grow until 2040 to be more than thrice the 2017 level.

Figure 2: Total Primary Energy Supply Composition of the Philippines (Mtoe)

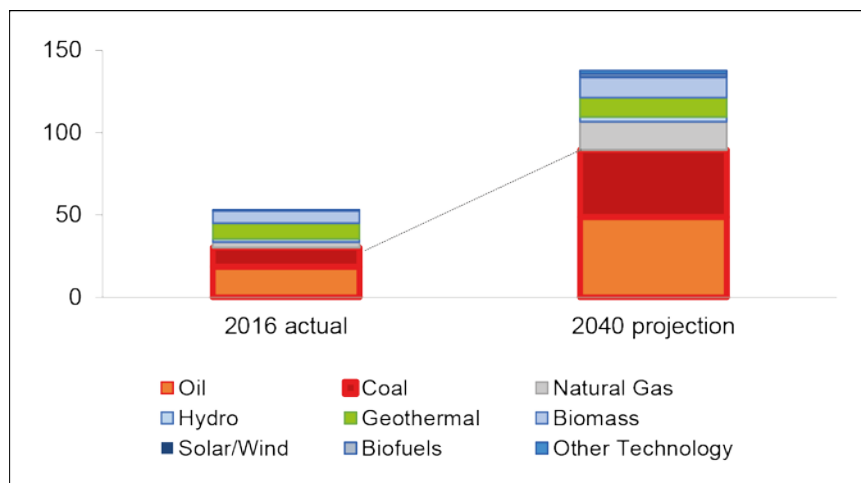

Source: Aquino 2017.

Second, DOE Philippines (2017b) reported that the power supply in the on-grid area had experienced frequent shortage of reserve margins, while off-grid regions had faced limited power supply (4–12 hours a day) (IRENA 2017).

Third, rural areas are still short of affordable energy. The electricity rate is high, because of the invalidity of commercial electricity supply (IRENA 2017). While the electricity access rate of the country has reached 90% as of 2016, it is still low for rural areas, with an average of 85% and 77% in Mindanao (World Bank 2018; Philippine Statics Authority 2018). This archipelago of over a thousand islands is not always connected to the power grid. The isolated places are typically dependent on costly diesel generators, and are suffering owing to both high electricity rates and air pollution (IRENA 2017; IEA 2017a).

Due to the development of a large-scale generation and transmission system, the country's electricity rate is exceedingly high, almost unaffordable for low-income citizens in rural areas. In rural off-grid regions, electricity is generated mostly from diesel, which is very costly due to imports. The electricity rates for rural areas are even higher than those of urban areas. There is a significant discrepancy in the availability and affordability of electricity between urban and rural areas.

Due to a large discrepancy between cities and rural areas, the majority of the population and commercial activities are concentrated in Manila, resulting in various urban problems, such as overpopulation, increased income gap between rich and poor, and air pollution. The distribution map of the energy consumption rate (ECR) per capita [kW/person] highlights the gap in electricity delivery between the regions.

The Philippine's rural electrification program started in the early 1960s. The goal was to achieve a 90% electrification rate by 2001. Later, the timeline to achieve this goal was set to 2017. Then, the government initiated the Missionary Electrification Development Plan, supported by development partners—the World Bank and the United Nations Development Program. Various actions under this plan have improved the electrification rate in rural areas, which the main power grid cannot reach, and then a public and private approach has been adopted (IRENA 2017). NEDA (2017) also launched the target to “prioritize the provision of electricity services to the remaining unelectrified off-grid, island, remote, and last-mile communities,” setting the target of achieving universal electrification by 2022 (IEA 2017a). The country has steadily

improved the national average of household electrification rate, from 62% in 1990 to 91% in 2016 (Figure 3). However, inequality in the rural electrification rate still remains and so does the ECR at local level.

The focus of this study is to extend the installation of wind power and solar photo voltaic (PV) options. Wind and solar generation is called variable renewable energy (VRE) due to their variability and uncertainty in generating outputs. This study promotes the penetration and utilization of VRE in developing Asian countries and the objectives are as follows:

- To enhance VRE penetration to reduce dependency on coal generation and mitigate the effects of climate change
- To improve rural electrification by deploying VRE, thereby alleviating the discrepancy between the cities and rural regions.

There are major barriers to resolving energy insecurity in the Philippines. First, because coal-fired generation is a proven and easy option to meet the growing demand for electricity, abandoning this measure is difficult. Second, VRE necessitates an evolution in power system planning and operation, due to its variability and uncertainty (USAID 2018). The International Energy Agency (IEA) (2014, 2017b), the Danish Energy Agency (DEA) (2015), and Energy Analyses Ea (2015) have expressed “system flexibility” as the key, which indicates the ability of an electrical system to cope with the variable and unexpected change of generation from VRE sources, when the penetration level is high.

Competitive auctions of renewables have accelerated cost reductions, resulting in record low prices for renewables and cost competitiveness vis-à-vis nuclear power plants (IEA 2017c; Schneider and Froggatt 2018). IRENA (2017) also point out that renewable energy sources provide the most cost-effective solutions, thanks to the near-zero marginal production costs of electricity. One difficulty in achieving a high VRE level within the existing system is its variable output. A traditional method for dealing with the variability is to provide backup fossil fuel generators to absorb fluctuations and set a limit on the total acceptance of VRE, thereby keeping the expected fluctuation bandwidth within a manageable level.

Effective use of interconnectors between regions is the key to providing the flexibility that is required in integrating VRE on a large scale. The advanced Nordic model provides some important implications.

A high level of VRE penetration requires “flexibility” in the system (IEA 2014; IEA 2017b; IEA 2017d; DEA 2015; Ea Energy Analyses 2015). DEA (2015: 7) defined “flexibility” as “the ability to cope with variability and uncertainty in both generation and demand, while maintaining a satisfactory level of reliability at a reasonable cost, over different time horizons.” Prior to that, the IEA (2014) elaborated on the concept of flexibility as a solution to the problem of variability within VRE, defining four categories: 1) grid infrastructure; 2) dispatchable generation; 3) storage; and 4) demand-side integration.

Among these four categories, grid infrastructure is thought to be the most effective measure to integrate VRE, because it connects distributed resources and demands. Cross-border interconnectors enable VRE generation to be shared among consumers in different locations. The other categories are still in the development stage (storage), increase CO₂ emissions (dispatchable generation), or are limited in terms of a continuous effect (demand-side integration) (IEA 2014). Additionally, IEA (2018) forecasts that hydroelectric generation and interconnection would make a major contribution to flexibility in 2040, apart from fossil fuel generation.

Research Questions (RQs)

1. Will the existing interconnectors be a solution for handling the expected level of VRE? What is the limitation of the interconnectors?
2. Is the current VRE development program effective in promoting rural electrification and the local economy, while mitigating reliance on fossil fuels? What other measures will be needed to make effective use of VRE?

Step 1 describes what was learned from the Nordic model. Step 2 comprises an economic evaluation of interconnectors, and deriving implications for the Philippines. Step 3 is an alternative measure to the grid connection. This paper is composed of the following sections: Section 1: introduction; Section 2: literature review; Section 3: learning from the Nordic interconnector model; Section 4: application of the interconnector model to the Philippines and its limitations (RQ1); Section 5: an alternative measure to overcome the limitations (RQ2); and Section 6: discussion and conclusion.

2. LITERATURE REVIEW

Status of Energy Security in the Asia-Pacific Region and Southeast Asia

The term “energy security” is defined as “the uninterrupted availability of energy sources at an affordable price” according to the IEA (2019). It covers both long- and short-term energy security. Long-term energy security is related to timely investments to supply energy in line with economic developments and sustainable environmental needs, according to the IEA. Short-term energy security refers to the ability of an energy system to react promptly to sudden changes within the supply–demand balance (IEA 2019).

In terms of long-term energy security, the long-term supply–demand condition, energy prices, and emissions should be observed. Even the self-sufficiency of energy is a lurking risk of long-term energy security. These aspects are discussed below. In the case of short-term energy security, system reliability and losses are the main concerns.

Energy Security in the Philippines

The total final energy consumption of the Philippines is expected to increase at an average rate of 4.3% annually, from 33.1 million tons of oil equivalent (MTOE) in 2016 to 91.0 MTOE in 2040. Electricity will account for 21.8% of the final energy consumption with a rapid growth of an average of 5.5% per annum by 2040, and the total consumption will be three times the consumption of 2016 (DOE Philippines 2018a). However, since the current growth rate of installed generation capacity (from 21,423 MW in 2016 (DOE Philippines 2016a) to 62,300 MW in 2040 (Aquino 2017)) is slower than that of electricity consumption, improvement in the country’s reserve margin will be difficult to achieve.

The self-sufficiency rate of energy also reflects the availability of energy sources of the country. In 2016, indigenous energy accounts for 55.3% of the country’s total primary energy supply. The rest of the share comes from imported energy, with 33.5% oil, 10.8% coal, and 0.3% biofuels (DOE Philippines 2018a). The fact that approximately half of the total energy supply depends on external sources poses a potential risk for energy availability.

From a consumer’s perspective, the country has seen remarkable progress. Thanks to the government’s ambitious goals and strenuous efforts, the electricity access rate has improved dramatically over the past decades to 90.0% in 2017 (DOE Philippines 2018b). The Philippines is one of the more advanced countries in the Southeast Asian region in

terms of household electrification (Figure 4). However, while the electricity access rate is as high as 98% in the capital region of the country, the remote regions are still lagging behind, for example, in the region of Mindanao, the access rate is only 40.9% (DOE Philippines 2018b). This issue is further discussed in Section 5.

Figure 3: Electricity Prices for Households (USD/MWh)

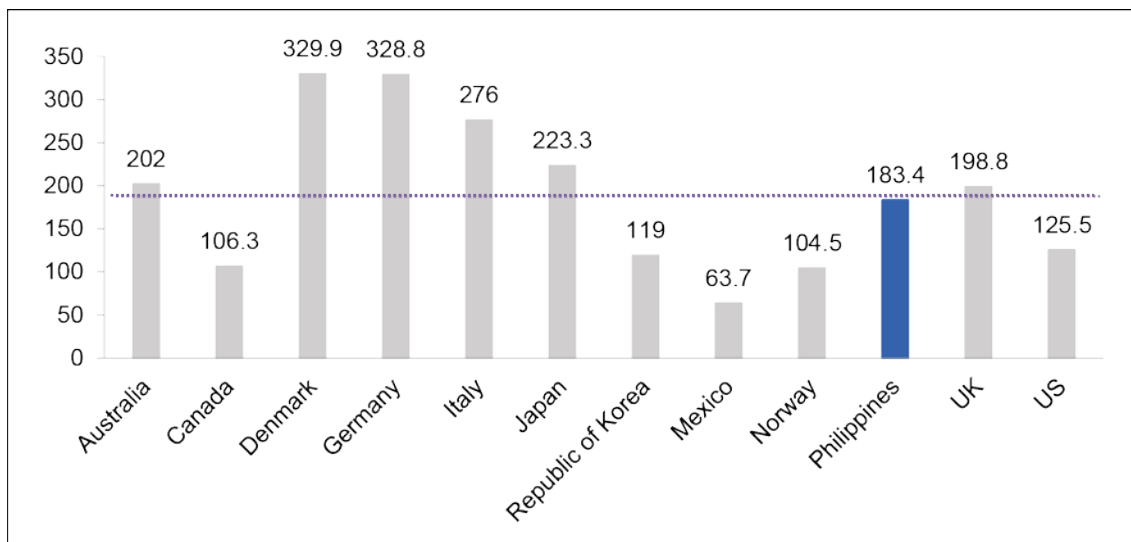

Source: IEA 2017e; DOE Philippines 2017d.

Figure 4: Electricity Access Rates of the Southeast Asian Countries (%)

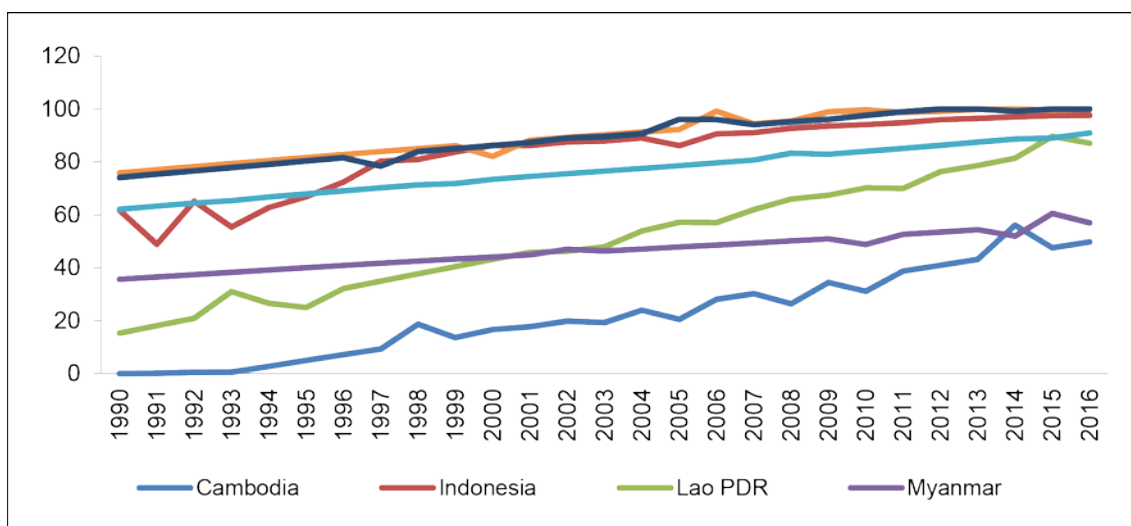

Source: World Bank 2018.

The country requires huge investment in energy infrastructure on the one hand, while the goal of delivering affordable energy has not been achieved on the other. The country’s electricity tariff is one of the highest in the Southeast Asian region, approaching the level of developed nations (Figure 3), though gross domestic product (GDP) per capita is not at that level.

Another consequence of the highly capitalized development of infrastructure is that it causes significant environmental concerns. According to DOE Philippines (2018a), the CO₂ emissions of the country are expected to increase four-fold by 2040.

The short-term energy security of the country has been a major issue of concern, as seen in the following reports.

DOE Philippines (2016a, 2016b, 2017a, 2017b, 2018a, 2018c) provides critical information on the electricity supply and demand situation in the Philippines. Their reports deliver the latest information as well as outlook for 2040.

NGCP (2015, 2016a, 2016b) describes present issues and potential options for the power grid. The topics range from transoceanic interconnections to intra-island transmission issues.

NEDA (2017) declares political targets for national development, including electrification and other social infrastructure.

DOE Philippines (2017b) assesses the condition of the electricity market as a result of industry reforms since 2001. Additionally, PEMC (2017a, 2017b) provides information on electricity market transactions for the year.

IEA (2017a) points out a challenge facing the Philippines. The report says the country's share of firms experiencing power outages is approximately 40%, and transmission and distribution losses amount to nearly 10% as of 2015, which is one of the highest among Southeast Asian countries.

Status of Renewable Energy in Asia and the Philippines

IRENA (2017) objectively and comprehensively explains the country's historical situation and activities in renewable energy and rural electrification. This report provides a brief history of the legislation as well as an overall evaluation from a social perspective.

USAID (2018) provides visible perspectives on the introduction of renewable energy. The Luzon and Visayas areas are included in its scope, but Mindanao is not. Based on the scenarios of renewable energy penetration levels, it simulates curtailment levels of solar and wind power, when they generate more than the demand.

The country has sought to improve its self-sufficiency of energy by increasing indigenous renewable energy, with its goal of doubling renewable installation (DOE Philippines 2016a, 2018a).

The Philippine government set out the Renewable Energy Act of 2008, the first comprehensive legislation on renewable energy in Southeast Asia. The objective of the act is to achieve energy self-reliance, mitigate climate change, and promote socio-economic development in rural areas (IRENA 2017). The act encompasses the development and utilization of renewable energy and the establishment of necessary infrastructure and mechanisms involving a feed-in tariff system. Thanks to this ambitious policy, the country has promoted electricity production from renewable sources for over 40 years. The current penetration rate of renewable sources (excluding hydroelectric) is approximately 15% (Figure 5). As the share of hydroelectric is 10.5% in 2015, the country's renewable share is still 25%. For further increases in renewable resources, more wind generation and solar PV need to be introduced, because the potential of other resources (e.g., geothermal or hydroelectric) is limited. USAID (2018) pointed out that the Philippines is home to abundant solar, wind, and other renewable energy resources, and indicated several potential wind and solar generation sites and their capacities in its report. While the installed capacity of solar and wind

accounts for only 1% of the total at present, it has the potential to be more than 20%, according to DOE Philippines (2018b) and author’s own calculations.

Figure 5: Southeast Asian Electricity Production from Renewable Sources, Excluding Hydroelectric (%)

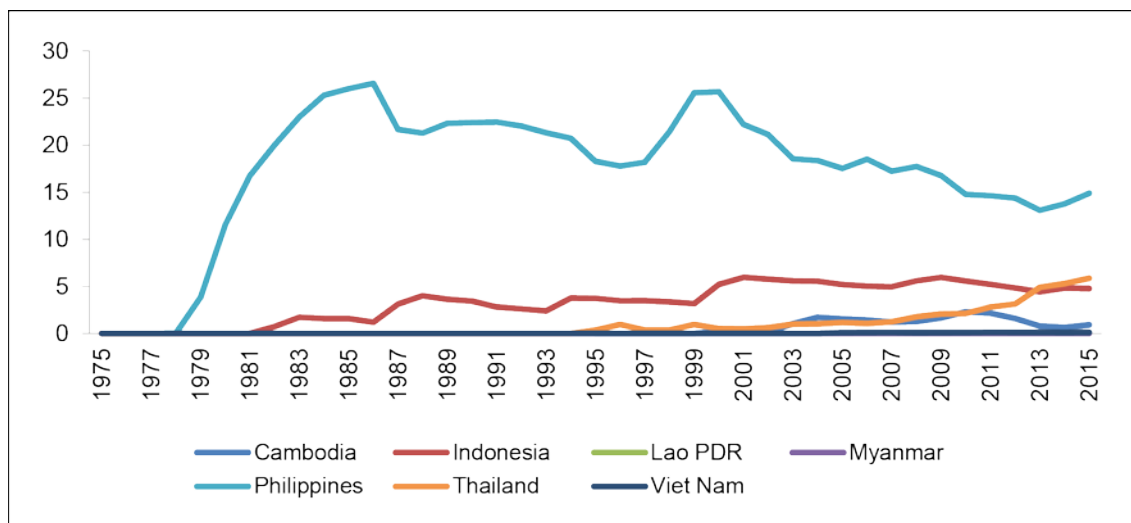

Source: World Bank 2018.

Learning from the Nordic Model

So far, the IEA and DEA have studied the role of interconnectors in providing system flexibility. The IEA (2014, 2017b) reported the trading and aggregation effect of VRE. It also described the typical phenomenon of solar PV consumption in Italy and studied the effects when a variety of VRE plants were aggregated (IEA 2014). The IEA (2017b) emphasized the size of the balancing areas: by expanding these using cross-border interconnectors, the variability and uncertainty of VRE diminishes. The cross-border interconnectors in the Nordic region functioned as transporters to mitigate variability in larger areas. The DEA (2015) analyzed trading between Denmark West and Germany and showed that roughly 80% of the variation in wind power was compensated for by the exchange in 2014. Ea Energy Analyses (2015) studied the trends in energy trade by comparing hydro-capacity in Norway, wind capacity and peak demand in Denmark, and interconnector capacities. Wang et al. (2017) used snapshot data to describe in detail how Denmark managed to integrate wind power through flexible coordination.

Other than interconnections, Virtual Power Plants (VPPs) have also been studied to manage VRE. Pudjianto, Ramsay and Strbac (2007) provided an algorithm for VPP. Shabanzadeh, Sheikh-EI-Eslami and Hashifam (2016) demonstrated a model to operate VPP using data from the Iberian market.

Economic Evaluation (Social Welfare Analysis)

Hogan (1992), Bushnell and Stoft (1996), and Verhoef (2000) examined the social cost of congestion and pricing effects. Belyaev (2011) explained the effect of electricity trading between two areas. Borenstein, Jaske and Rosenfeld (2002) showed the social welfare effect. Felder (2011) provided a complete description on the price-suppression effect which represents the transfer of producer surplus to consumer surplus,

and proposed a holistic approach including environmental-suppression and price-impression effects that avoids the overstatement of a particular effect.

Effects of Rural Electrification

Herrin (1979) studied the effect of rural electrification in the Southern Philippines and provided a conceptual relationship based on a field study. Frederiksen (1981) studied the relationship between the rural electrification rate and population density for the Philippines in 1970 and 1975 and demonstrated a positive relationship between the two variables. Kanagawa and Nakata (2007, 2008) presented a conceptual mechanism of electrification that improves quality of life. Moner-Girona (2009) discussed the effect of rural electrification, where distributed renewable energy helps stimulate the local economy. Pereira et al. (2011) evaluated the impact of access to electricity, taking samples from South Africa, the People's Republic of China, India, and Brazil. Hong and Abe (2012) studied the use of renewable energy for rural electrification in the Philippines and concluded that the trial was effective, though technology, economics, and community challenges existed. Pasten and Santamarina (2012) explored the relationship between the electrification level and quality of life, taking data for 118 countries. This study showed a simple and quantitative relationship between the two factors. Roxas and Santiago (2016) deliberated on how to effectively disseminate renewable energy in rural communities. Nadimi and Tokimatsu (2018) modeled a relationship between the electricity consumption per capita and quality of life, taking samples from 112 countries for 2005–2013.

3. STEP 1: LEARNING FROM THE NORDIC INTERCONNECTOR MODEL—HOW A FLEXIBLE SYSTEM WORKS

3.1 Methods: Modeling the Denmark Interconnecting System

Modeling the Nordic Interconnecting System

For resolving energy security problems in Asia via a renewable energy approach, it is crucial to study the Nordic cases; these countries have been developing advanced systems via renewable energy approaches over the decades, for addressing their energy problems. Among the Nordic countries, I have taken Denmark as a model case, because the system is oceanic and comprises of several islands, similar to the Philippines. In addition, IEA (2018, 2017b) ranks Denmark as the highest among a list of countries in terms of its VRE share and phase of integration. The model functioning of the system delivers important suggestions that will be applicable to developing Asian countries, including the Philippines.

The connection between Denmark West and Germany was used for this study, where a large volume of wind power exists on both sides of the interconnector, along with neighboring alternating current lines. The interconnectors were connected to Sweden, Germany, Norway, and Denmark East–West. Denmark has achieved a high VRE penetration, supported by flexible power systems and interconnection with other Nordic countries. Hydropower in the Nordic countries functioned as a buffer (OECD 1999; Nord REG 2014; DEA 2015; Ea Energy Analyses 2015; IEA 2017b; IEA 2017d; Wang et al. 2017).

Identifying Variables for the Model

The original model includes the prices for both areas. Because these two variables are strongly correlated, only the price in Area B was adopted to avoid multicollinearity. VRE, direct current (DC) lines, and flexible demands (pumped storage and electric boilers) were the other factors for providing flexibility. Decentralized combined heat and power (CHP) and flexible sources such as heat pumps or electric boilers, which can shift production by storing heat, are considered important flexible sources. The importance of DC lines was raised by Wang et al. (2017).

3.2 Empirical Study of the Nordic Model

A more generalized area allocation is shown in Figure 6. In the model, Area A is the low-price area with low demand, and Area B is the high-price area with high demand.

Figure 6: Generalized Interconnector Model

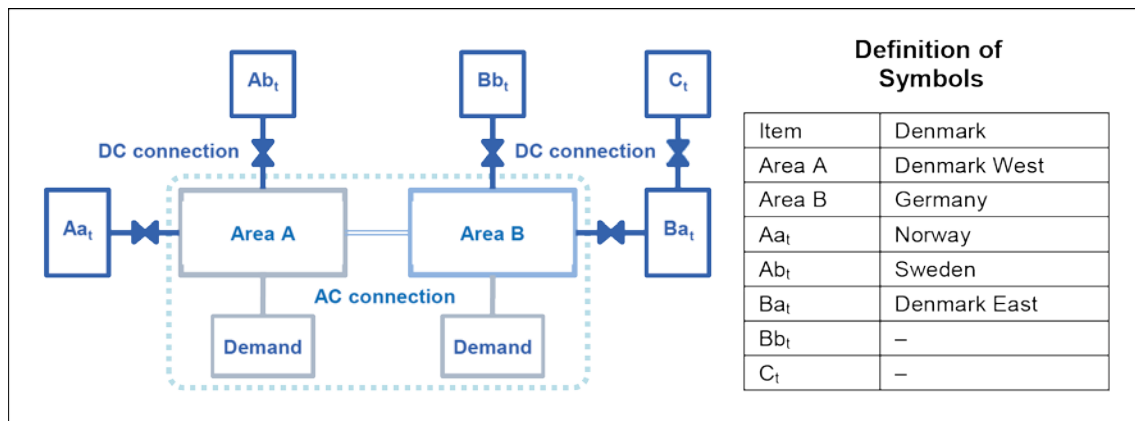

A natural logarithm of the interconnector flow and relevant parameters was applied for the multiple regression analysis. The ln (Flow) was the objective variable for the multiple regression. As it is generally understood, the coefficient of the explanatory variable in the logarithm form indicates the elasticity of the objective variable. For example, a 1% variation in the explanatory variable corresponds to a 1% variation in the objective variable or interconnector flow. Equation (1) shows the log-linear model for the interconnector flow:

$$\begin{aligned}
 \ln (\text{Flow}_t) = & \alpha_0 + \beta_1 * \ln (\text{Price } B_t) + \beta_2 * \ln (\text{Demand } A_t) + \beta_3 * \ln (\text{Demand } B_t) \\
 & + \beta_4 * \ln (\text{VRE } A_t) + \beta_5 * \ln (\text{VRE } B_t) + \beta_6 * \ln (\text{Flexible } A_t) + \beta_7 * \ln (\text{Flexible } B_t) \\
 & + \beta_8 * \ln (\text{DC flow } Aa_t) + \beta_9 * \ln (\text{DC flow } Ab_t) + \beta_{10} * \ln (\text{DC flow } Ba_t) + \beta_{11} * \\
 & \ln (\text{DC flow } C_t) + \beta_{12} * \ln (\text{Dispatchable } \text{Gen}_t)
 \end{aligned} \tag{1}$$

The multiple regression analysis was conducted using empirical data. For comparison, data from 2017 and 2006 were taken. VRE penetration level on the basis of generated electricity was 28.5% in 2006, while it was 42.5% in 2017.

The data from 2017 and 2006 were acquired to follow the historical transition from several sites, combining different resolutions (e.g., Energinet 2018, Nord Pool 2018, ENTSO-E 2018), and time stamps were formalized. The direction of the flow must also be noted. Based on the definition, a positive sign indicates a flow from Germany (export) to Denmark (import).

Key Results

Table 1 shows the key results of the model analysis for Denmark in 2006 and 2017.

In the case of Denmark, the interconnector flow shows a high correlation with VRE, with an elasticity above 1.0. This indicates the important fact that the interconnector flow was open to VRE generation, along with other supporting sources such as the local CHP, flexible demand, and DC line flow.

Table 1: Summary Result of the Multiple Regression Analysis

Item	Significant Variables (Elasticity is Larger than 0.3)	
	2017 (VRE Penetration: 42.5%)	2006 (VRE Penetration: 28.5%)
Area A Denmark West	Demand (3.8), VRE generation (–1.0), Dispatchable fossil CHP (–1.5), Electric boiler (Flexible demand) (0.5)	Demand (12.2), VRE generation (–1.1), Centrally-controlled fossil generation (–5.4), Dispatchable fossil CHP (–3.5)
Area B Germany		Demand (–11.3), Price (0.6)
Aa _t Norway	DC flow (–0.4)	DC flow (–0.3)
Ab _t Sweden	DC flow (–0.4)	
Ba _t Denmark East	DC flow (0.3)	

The underlined variables show significant elasticity (larger than 0.3) in the data for 2017. Those in parentheses show the significance of the data for 2006. Interestingly, the result from 2006 shows that the operation of the interconnector still depended on the dispatchable generators. Subsequently, this reliance decreased significantly (by 2017).

The Nordic model demonstrates that the interconnector flow is coordinated with flexible demands, dispatchable generations, and adjacent DC line flows. As penetration level increased from 28.5% in 2006 to 42.5% in 2017, the dispatchable central generation became less imperative, while DC line interconnections contributed actively.

Another analysis showed that the aggregated capacity of the interconnectors and the domestic flexible resources such as electric boilers or the CHP, was slightly larger than that of the VRE. Although the flexible capacity of the neighboring area (i.e., hydroelectric capacity in Norway) was far larger than the VRE capacity, actual flexibility was defined by that aggregation.

Suggestions for Developing Asian Countries

- In achieving a high penetration of VRE, interconnection between regions is an effective measure.
- The Nordic model shows that interconnector flow is linked to VRE generation, along with other variables (e.g., demand, local CHP, flexible demands, adjacent DC flows).
- As VRE penetration level increases, the role of the DC lines connected to adjacent areas will be even more important. A positive use of DC lines will help mitigate the dependency on fossil fuel generation.
- The aggregated capacity of the interconnectors and the internal flexible resources should be larger than that of the VRE, or at least comparable.

4. STEP 2: APPLICATION OF THE INTERCONNECTOR MODEL TO THE PHILIPPINES AND ITS LIMITATIONS

4.1 Methods

Deriving a Desirable Interconnector Flow—A Theory of Social Welfare in Electricity Trading

The Benefit of Electricity Trading

The basic function of electricity trading between two regions is to gain economic value from that transaction. However, the definition of economic value is ambiguous. The most common driver is to resolve the price difference between these two. This has been the tradition in electricity trading, as described by Hogan (1992) and Bushnell and Stoft (1996).

Belyaev (2011) explained this from a different perspective. Consider the two-area system with an interconnecting line. Assume the case where Area A is the low-price area and Area B is the high-price area, then Area A exports electricity to Area B. In Area A, the supply curve shifts to the left and in Area B it shifts to the right (Belyaev 2011). From this, we can interpret that the demand curve shifts to the right in Area A, and in Area B it shifts to the left. The degree of shift is proportional to the power that Area A exports to Area B (Figure 7).

In this study, I first introduce the concept of social welfare. I assume that in Area A, social welfare is reduced by the hatched area in the left (S_A), while it increases by the hatched area in the right (S_B) in Area B. Exporting electricity is justified only when $S_B > S_A$. This also holds true in the case of infinitesimal difference in interconnector flow. Then, electricity trading is beneficial under the following conditions:

$$(df_A/dx) * d_A < (df_B/dx) * d_B \quad (2)$$

Where f_A : supply function in Area A

f_B : supply function in Area B

d_A : demand in Area A

d_B : demand in Area B

x : demand or transmitted power from Area A to Area B

The condition of $S_B > S_A$ is then specified as given below:

$$x < 2 * \{(df_B/dx) * d_B - (df_A/dx) * d_A\} / \{(df_B/dx) + (df_A/dx)\} \quad (3)$$

Given that $\varepsilon = (dx/x) / (dp/p)$, then $(df/dx) = (1/\varepsilon)*(p/x)$

Here, $W = (1/\epsilon_A) \cdot (P_A/d_A) + (1/\epsilon_B) \cdot (P_B/d_B)$, $Z = (P_B/\epsilon_B) - (P_A/\epsilon_A)$

ϵ_A : price elasticity of supply curve in Area A

ϵ_B : price elasticity of supply curve in Area B

Then, Social Welfare = $S_B - S_A = - (W/2) \cdot (x - Z/W)^2 + Z^2/(2W)$ (4)

Figure 7: Electricity Trading and Social Welfare Change

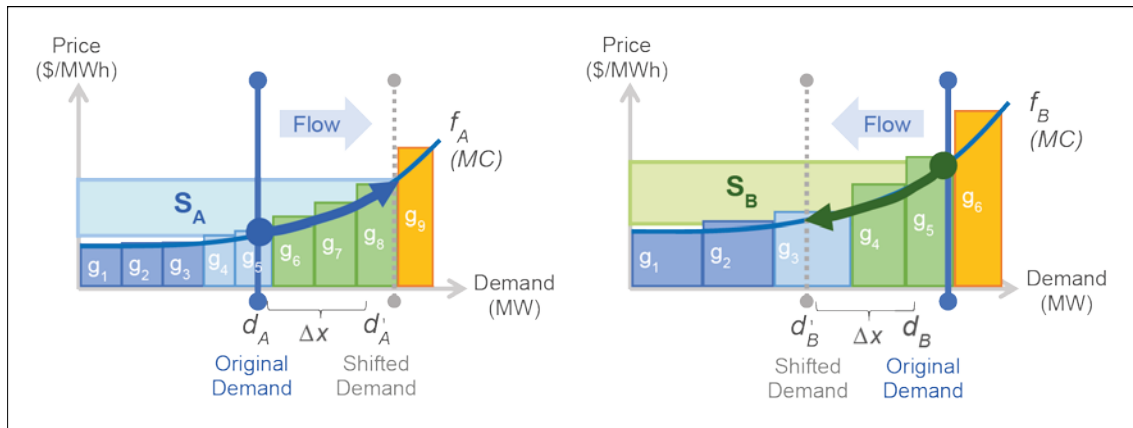

Then, social welfare has to be normalized to compare different nations or different time frames.

Normalized Social Welfare = $(S_B - S_A) / (d_A + d_B)$ (5)

Condition (3) is rewritten as follows:

Social welfare is improved when $0 < x < 2 \cdot Z/W$, and maximized when $x^* = Z/W$ (6)

Analytical Procedure

Power Grid Configuration of the Philippines

Figure 8 shows the power grid configuration of the Philippines. The only inter-zonal connection in the Philippines is the Luzon–Visayas interconnector. The two areas are connected by a high-voltage direct current line with a capacity of 440 MW (Visayas to Luzon) and 250 MW (Luzon to Visayas). The other intra-zonal transmission lines are not analyzed for the market-to-market transaction. The line connecting Visayas and Mindanao is still under planning. The dotted lines are the options for the connecting route (NGCP, 2015, 2016a, 2016b).

Figure 8: Main Power Grid Configuration of the Philippines

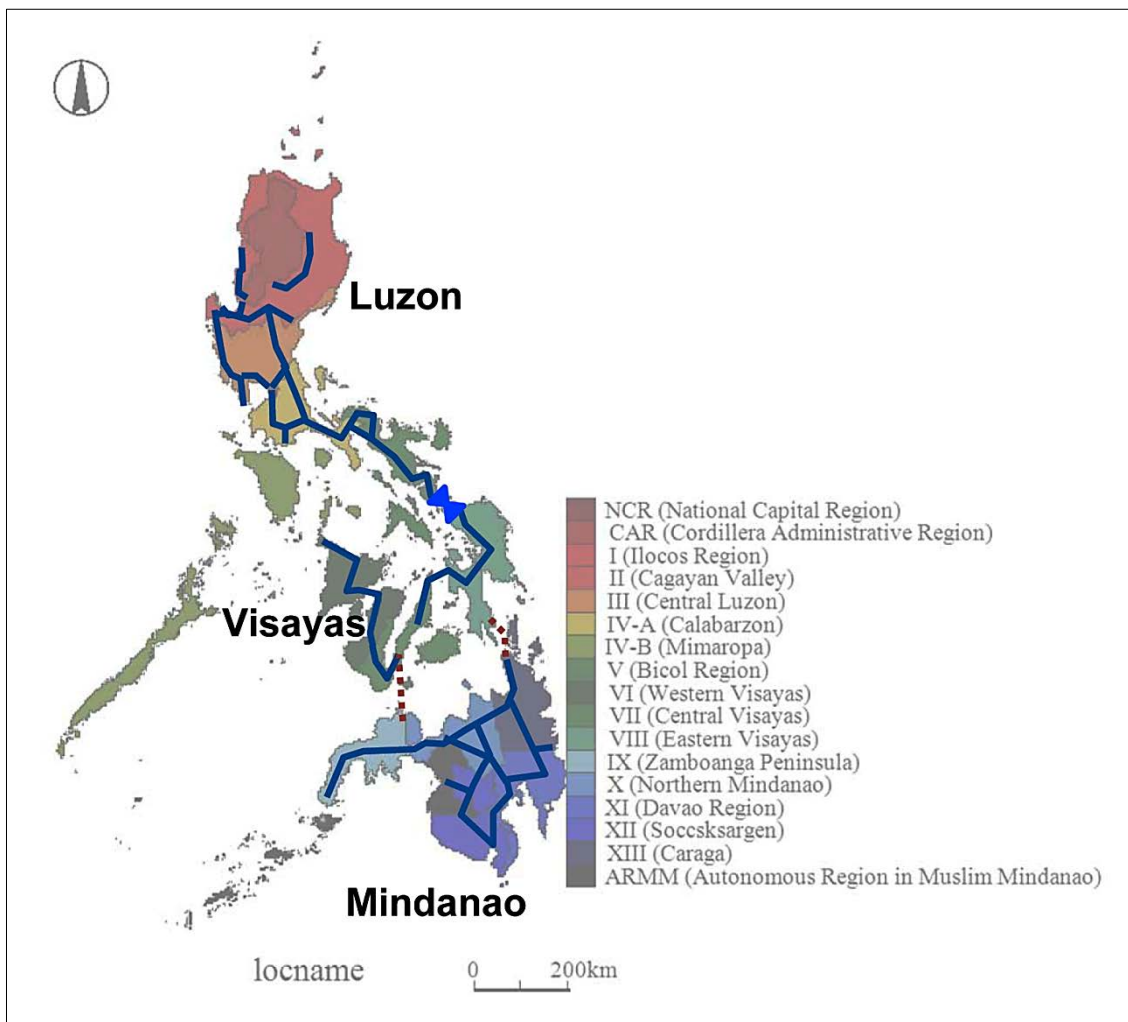

Drawing Supply Curves of the Three Areas (Luzon, Visayas, and Mindanao)

The marginal cost curves of three areas (i.e., Luzon, Visayas, Mindanao) are to be depicted after following the procedure in Section 4.1. In order to draw the marginal cost curves, generation capacity of the respective sources and their corresponding marginal costs need to be acquired. The generation capacity is provided by DOE Philippines (2017e) and the marginal costs can be assumed from the data (i.e., “Marginal Plants”) of the Wholesale Electricity Spot Market (WESM), published on its webpage.

I assume that the marginal cost of a specific generation category depends on the accessibility to corporates’ internal information. Due to the transparency policy of the Philippines, the record of the marginal costs of individual time slots is posted for download from the WESM webpage. The raw data contain some unusually high tender prices, by which market participants try to gain opportunistic high revenues. These outliers can be eliminated by the statistical procedure, producing a frequency distribution, and extracting middle samples for averaging.

By placing the generation capacity of each source in the order of their marginal cost, the supply curves of the three areas will be drawn. As the WESM does not cover Mindanao, the marginal costs of Visayas were used.

Deriving Price Elasticity Values

The next step is to derive the price elasticity values of the supply curves. Applying the same principle as the translog model of Equation (1), it can be said that the ratio of the natural logarithm for the price and capacity represents the price elasticity of the supply curve. By taking the natural logarithm of the corners of the supply curve and calculating a regression line, the general elasticity of the supply curve can be derived.

In contrast to the general elasticity value, the actual effect of trading electricity is subject to the specific shape of the horizontal range, where the demand curve moves due for various reasons. For instance, if a certain amount of VRE is introduced, the demand curve moves to the right due to its low variable cost, but the range of shift varies because of its swinging generation. Then, this study assumes the range of shifting demand by multiplying the installed capacity of VRE sources with their expected capacity factors. As for the specific shifting range of the demand curve and the supply curve, the values will be derived by taking the proportion of their natural logarithm values.

Desirable Interconnector Flow and Capacity Based on the Theory

Based on Equation (6), the desirable interconnector flow is derived to be x^* ($= Z/W$). This value can be obtained when price, peak demand, and the price elasticity of the supply curve is given for each area. For Luzon and Visayas, price and peak demand are given by PEMC (2017a, 2018), and elasticity is to be calculated following the above procedure. In the case of Mindanao, peak demand is given by DOE Philippines (2018c) and elasticity comes from the above procedure. Only price is assumed based on the supply curve and peak demand.

Next, the compatibility of the swing capacity of VRE and the interconnector will be checked. The Nordic model suggested that the capacity of interconnector should be larger than that of the swing volume of VRE or at least compatible. Then, a comparison between these two and their related values is to be conducted. The interconnector capacity and other related data are provided by PEMC (2017b).

4.2 Results

Estimating Supply Curves

The estimated marginal cost curves are shown in Figure 9.

Luzon has a larger generation capacity than the other two areas, approximately five times that of Visayas or Mindanao. The marginal price of Luzon is typically determined by natural gas power plants or coal power plants. Some speculative approach in the tender procedure was observed, especially for the hydroelectric power generators in Luzon, which recorded extremely high prices as a result of bidding behavior, while the reserve margin of the system was scarce.

Because the proposed VRE introduction (USAID 2018) is mostly located in Luzon, the demand curve shifts around the range of coal generation. Hence, the specific elasticity was calculated for coal generation. The supply curves of Visayas and Mindanao were also derived in the same way as those of Luzon.

The typical marginal plant is a coal power plant in Visayas. Since the maximum demand is close to the boundary of the coal and diesel plants, the price frequently spikes. The proposed VRE installation by USAID (2018) was small, and then the specific elasticity was calculated for coal generation.

Figure 9: Luzon Estimated Marginal Cost Curve
(in USD/MWh)

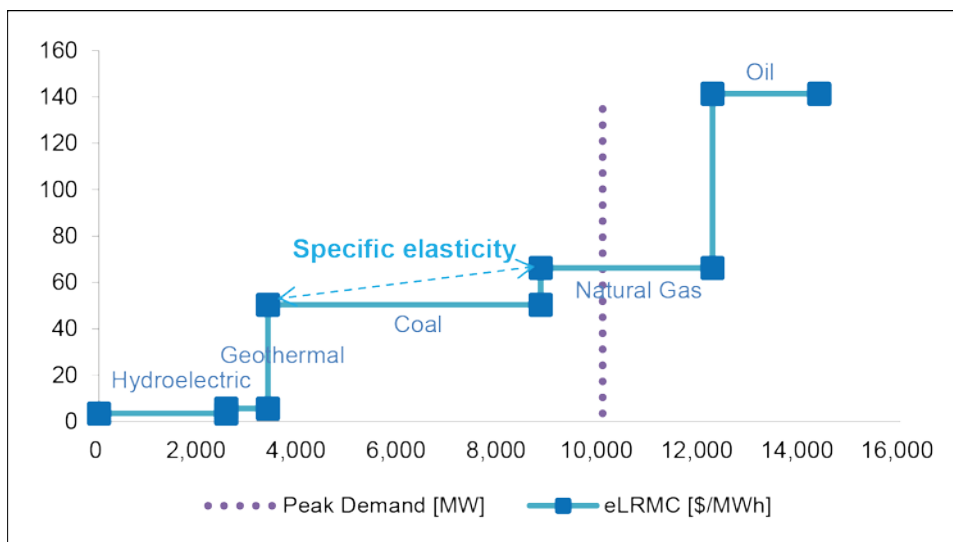

When assuming a universal power grid, the virtual marginal plants are the coal generation plants. However, the electricity price in Mindanao is not universal and the electricity market does not exist there. The off-grid areas remain where the main grid is not installed. In such areas, costly diesel plants are the major power sources. Then, this estimation is only for the study of future interconnection, delivering only hypothetical outcomes.

Elasticity Values of the Supply Curves

The results for the elasticity calculation of the supply curves are shown in Table 2. The results will be used as a part of the inputs for the calculation in this section.

Table 2: Results of the Elasticity Calculation
(in MW)

Item	Target VRE	Estimated Shift of Demand	General Elasticity	Specific Elasticity
Luzon	19,166	4,000	1.18	3.51
Visayas	2,165	500	1.46	0.31
Mindanao	410	60	0.88	0.32

Desirable Interconnector Flows

The desirable interconnector flows are those that maximize the social welfare at peak demands. Table 3 shows the results of the calculations for the desirable interconnector flows.

Table 3: Desirable Interconnector Flows
(in MW)

Item	Desirable Flows with General Elasticity	Desirable Flows with Specific Elasticity	Note
Luzon–Visayas	+ 718 (0.27)	– 1,736	(+) means the flow from Visayas to Luzon
Visayas–Mindanao	+ 529	+ 35	(+) means the flow from Visayas to Mindanao

Note: the value within the parentheses shows the normalized social welfare for the average flow in 2017.

Given the application of the general elasticity, the existing interconnector capacity of 440 MW between Luzon and Visayas is thought to be reasonable and increases the social welfare. However, when assuming the introduction of VRE, the derived capacity does not make sense. Under the proposed renewable resources, the Visayas–Mindanao interconnector has reasonably small specific elasticity, meaning that the project will contribute to social welfare gains.

Because the VRE capacity in Luzon is too large, the variability of the interconnector between Luzon and Visayas is hard to manage. To proceed with this project, other flexible resources will be needed as described in Section 5.

Findings

There is a limitation in applying the Nordic Model to the Philippines. In order to acquire a desirable level of interconnecting capacity, the required investments in transmission lines and the dispatchable fossil fuel generations will be unreasonably high.

For instance, most of the land area is away from the existing power grid in Mindanao, and there is a growing realization that the traditional approach of enhancing electrification rate is not always the right one.

Luzon–Visayas Interconnector

The present capacity is 440 MW for the flow from Visayas to Luzon, and 250 MW from Luzon to Visayas. The actual flow was 222 MW from Visayas to Luzon during 2017, which was reasonable in terms of social welfare. However, under the specific condition where renewable energy is introduced in a large volume, the specific elasticity of the Luzon grid goes up, making electricity trading inefficient. In such a situation, the required interconnector capacity needs to be much larger, or a large volume of flexible resources need to be installed, which leads to huge investments.

Visayas–Mindanao Interconnector

This interconnector is still under the planning stage, but this might be reasonable in terms of the proposed plan for installing renewable energy. The Visayas grid will benefit from accessing the hydroelectric capacity in Mindanao, which will mitigate the variability of VRE generation.

Limitation of the Solution with Interconnectors

The required interconnector capacity and whether it is beneficial or not are dependent on the amount of renewable energy installations, by which the elasticity of the supply curve swings. Hence, it is not possible to make a correct decision concerning interconnector investment before delivering a concrete plan for renewable energy sources. The decision to construct interconnectors requires a long-term planning

procedure, where going backward is not allowed. Because the plan for renewable energy development is still immature in the Philippines, the interconnector option is not a universal solution.

In addition, the interconnector does not provide a measure to mitigate the regional inequality in electricity supplies. When addressing the regional inequality problem, other measures should be simultaneously implemented.

5. STEP 3: AN ALTERNATIVE MEASURE TO OVERCOME THE LIMITATION—DISTRIBUTED VRE MODEL

5.1 Methods

Uneven Distribution of VRE Development and ECR

The interconnector model assumes a universal connection to the transmission lines. However, the places where grid connections are not sufficiently developed will not be suitable for that measure. Uneven distributions of VRE development and the ECR are still issues, to which the interconnector approach does not apply.

Figure 10 shows the distribution map of household population and electrification rate in the Philippines.

Figure 10: Distribution Map of Population Concentration (left) and Electrification Rate (right)

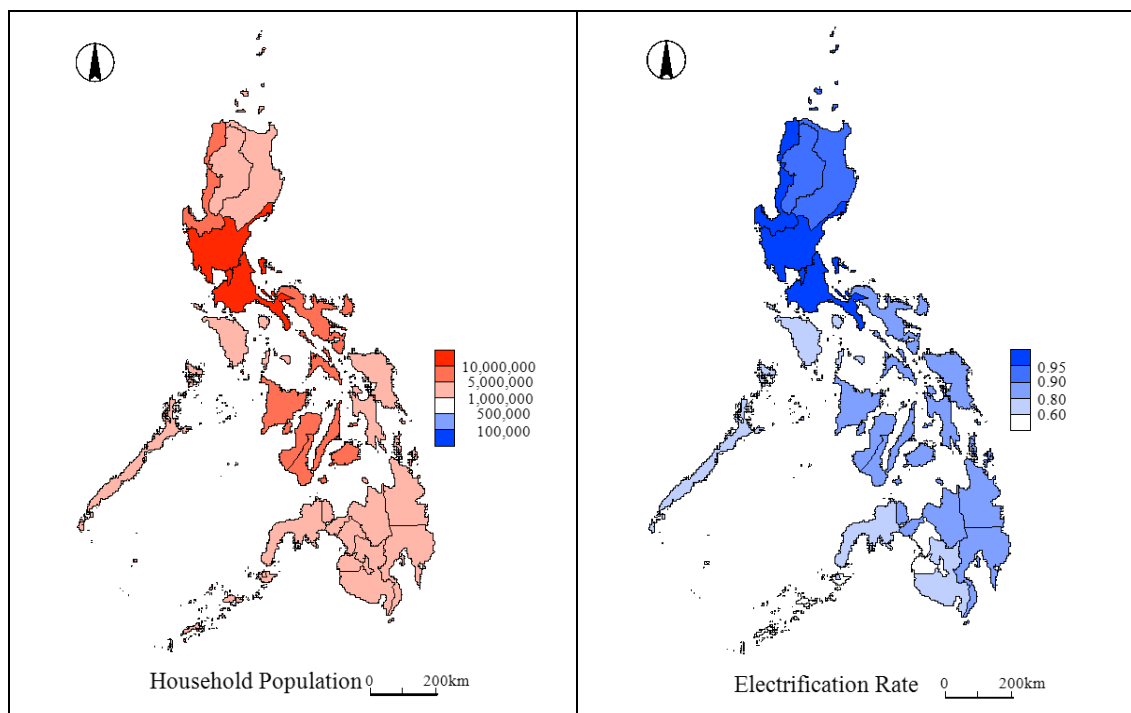

While the national electrification rate has reached 91% in 2016 (as shown in Figure 3), regional unevenness exists (as seen in Figure 10). In this step, the regional distribution of ECR is to be derived along with that of the VRE installation program to assess the effectiveness of the renewable energy proposal.

Relationship Between the ECR and the Quality of Life Index (QoL)

Pasten and Santamarina (2012) demonstrated a log-linear relationship between the ECR and the QoL. The trend analysis showed that when ECR exceeded 5.0, the QoL saturated. When the ECR ranged from 1.0–5.0, the QoL and other indices (e.g., gross national income per capita) were linearly correlated.

According to the model proposed by Nadimi and Tokimatsu (2018), the relationship between the ECR and the QoL showed an S-shape curve, where there were two saturation areas at both the low end and the high end of the ECR values. The linear zone of the ECR was approximately between 2.5–4.0. The range below 2.5 is thought to be that of pre-developing countries.

This step provides quantitative assessments for the distribution of regional ECR, then discusses a practical level of ECR from the QoL perspective.

Benefit Analysis for the Distributed VRE Model

The Nordic model suggests that flexible capacity is needed when additional interconnector capacity is not feasible. Flexible capacity includes hydroelectric generation, storage, or flexible demands (e.g., electric boiler, CHP). Roxas and Santiago (2016) suggested that other flexible resources could be drinking water production or ice for fish producers, which would be especially effective under the conditions of the tropical archipelago.

Then, the following values are to be calculated. There is a special note on calculating (j) backup capacity. One of the important functions of power storage is to equalize the changing output of VRE, and then the average output of the discharge from the storage is the installed capacity of VRE multiplied by its capacity factor. Although the actual output from the storage is restricted by the maximum current, this study employed the simple assumption given above.

The final goal of this step is to compare the cost of installing storage and the saving of additional fossil fuel generation.

- (a) Energy consumption on a regional basis [MWh] (Source: Energy Delivery Per Region in 2016, Philippine Statistics Authority (2018))
- (b) System peak demand, 2016 [MW] (Source: 30th Electric Power Industry Reform Act (EPIRA) Implementation Status Report, DOE Philippines (2017b))
- (c) VRE capacity [MW] (Source: USAID (2018), BR50 scenario from “Greening the Grid” and Power Demand and Supply Highlights (2017), DOE Philippines (2018c); Mindanao Indicative Power Projects as of 31 December 2017)
- (d) Capacity factors for generation sources including wind power and solar PV on a regional basis [%] (Source: Annual Market Assessment Report, PEMC (2017a))
- (e) Expected VRE generation [MWh]
- (f) Installed capacity of hydroelectric [MW] (Source: Power Supply and Demand Highlights, DOE Philippines (2017a))
- (g) Installed capacity of geothermal [MW] (Source: Power Supply and Demand Highlights, DOE Philippines (2017a))
- (h) Installed capacity of biomass [MW] (Source: Power Supply and Demand Highlights, DOE Philippines (2017a))

- (i) Installed capacity of fossil generations [MW] (Source: Power Supply and Demand Highlights, DOE Philippines (2017a))
- (j) Backup capacity needed for the system peak demand [MW]
- (k) The gap between energy delivery and renewable generations [MWh]
- (l) Storage capacity needed [MWh]
- (m) Estimated cost of storage [mm USD]
- (n) Estimated saving of fossil generation capacity [mm USD]

Note 1: The capacity factor for the biomass power plant is assumed to be 85%, as indicated in (k).

Note 2: The storage capacity is assumed to be as much as eight hours by the output of VRE generation, as seen in (l).

Note 3: IEA (2018) projected that the batteries will reduce in cost to US\$100/kWh, by 2030 (m).

Note 4: The cost of constructing a coal power plant appears in (n) and is estimated from that of the Pagbilao coal-fired power plant indicated by DOE Philippines (2017b).

5.2 Results

Distribution Map of VRE Development and ECR

Figure 11 shows the distribution of the projected VRE generation (left) under the proposed BR50 scenario set by USAID (2018), and the projected VRE share of total electricity consumption in 2016 (right).

Figure 11: Distribution Map of Projected VRE Generation (left) and Projected VRE Share (right)

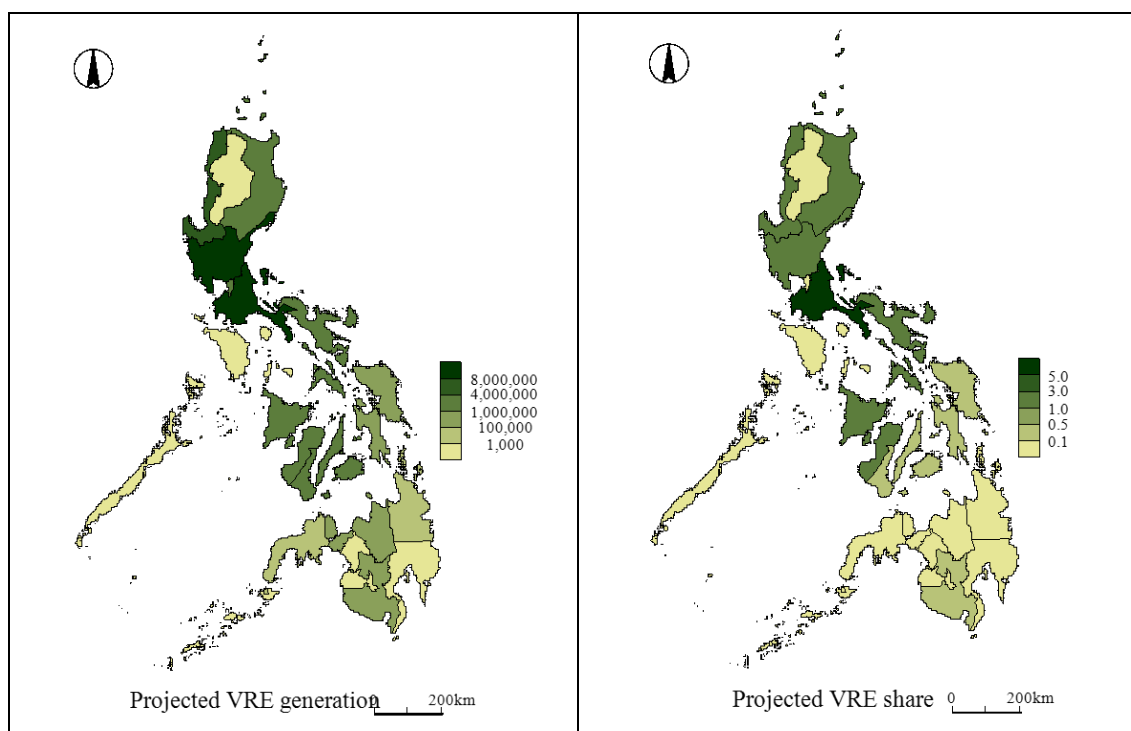

According to the comparison between Figures 10 and 11, the distribution of the proposed VRE generation and share correspond to that of the electrification rate. This means that the urban areas are overpopulated, rich in electricity supply, and abundant in renewable energy development. In contrast, some of the rural areas are left behind in the efforts to enhance renewable resources.

Findings on ECR and QoL

Figure 12 shows the calculated distribution of the ECR [kW/person]. When compared with Figure 10, there is a discrepancy between the distribution of the electrification rate and the ECR. While the electrification rates are high in several provinces, the ECRs are low in most provinces, except for the national capital region. The majority of the provinces show the ECR to be less than 0.1, which is equivalent to the QoL of pre-developing countries (Pasten and Santamarina 2012; Nadimi and Tokimatsu 2018). Even the highest national ECR is 0.37 in the national capital region.

Figure 12: Distribution Map of ECR

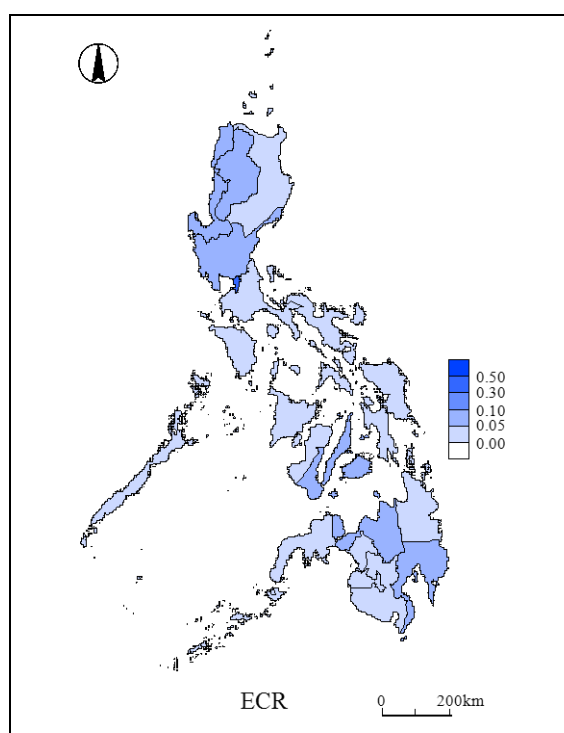

Moner-Girona (2009) suggested that renewable energy mini-grid projects often keep money in the local area and boost the local economy; especially for isolated islands or remote areas, where a well-balanced distribution of VRE and establishment of the energy production cycle, storage, delivery, and relevant services will be an efficient and cost-effective approach to improve the ECR and QoL.

Results: Benefit Analysis for the Distributed VRE Model

The result of the benefit analysis for the distributed VRE model is shown in Table 4. This model assumes the distribution of the nation's VRE development plan prepared by USAID (2018) and indicative projects given by DOE Philippines (2018c).

Table 4: Results of the Cost and Saving Analysis

Item	(a) [GWh]	(b) [MW]	(c) [MW]	(e) [GWh]	(j) [MW]	(k) [GWh]	(l) [MWh]	(m) [US\$ million]	(n) [US\$ million]
Luzon	57,441	9,726	19,166	35,064	3,351	11,325			
Visayas	8,886	1,893	2,165	4,119	673	0			
Mindanao	9,495	1,653	410	535	576	4,038			
Philippines	75,822	13,272	21,741	39,718	4,600	13,005	144,824	14,482	23,768

- (a) Energy consumption on a regional basis [GWh]
 (b) System peak demand 2016 [MW]
 (c) VRE capacity [MW]
 (e) Expected VRE generation [GWh]
 (j) Backup capacity needed for the system peak demand [MW]
 (k) The gap between energy delivery and renewable generations [GWh]
 (l) Storage capacity needed [MWh]
 (m) Estimated cost of storage [US\$ million]
 (n) Estimated saving of fossil generation capacity [US\$ million]

Note: The calculation of (k) and (l) assume electricity trading between Visayas and Luzon.

One of the important findings is that there will be a gap between the energy consumption and the total of renewable generation (as much as 13 TWh annually). Although the expected VRE capacity is greater than the peak demand, the actual output of VRE will be stabilized and lowered through storage, and another 3.4 GW of fossil fuel generation will be needed for compensating the gap. This is by far a smaller capacity than the presently installed one, which leads to a significant reduction in fossil fuel generation in the future. The cost saving from installing fossil fuel generation is estimated to be US\$24 billion which is higher than the expected cost of US\$14 billion for storage; thus, delivering a considerable benefit for society.

In addition, the results from Section 4.2 suggest that additional storage capacity enhances the role of the interconnector, by providing more flexible capability to manage anticipated VRE fluctuation.

6. DISCUSSION AND CONCLUSION

The Nordic model has provided useful suggestions for developing Asian countries that aim to solve their energy security problems using the renewable energy approach: (1) the role of interconnectors is very important in order to serve most of their electricity demand by renewable sources; (2) the interconnector flow should be linked with the aggregation of the VRE generating output; (3) supplementary flexible sources (e.g., hydroelectric, local CHP, electric boiler, DC line flows) are to be coordinated with the interconnector flow; and (4) the aggregated capacity of the interconnector and the internal flexible resources should be larger than that of the VRE, or at least compatible. When the power grid is well developed, the following four suggestions are instantly applicable. However, the effectiveness of the interconnector approach is limited in the case of an underdeveloped power grid. In such systems, points (3) and (4) should be considered.

Looking at the Philippines, the interconnector capacity of Luzon–Visayas is thought to be reasonable according to Step 2, given the present composition of the power system. However, when assuming the proposed VRE generation, the rationale behind the interconnector will disappear. The plan of the Visayas–Mindanao interconnector is

thought to be reasonable, as long as the projected VRE capacity stays within the anticipated level.

During the process of estimating the supply curves, some speculative activities in the bidding procedure of the market were observed. This could be one of the causes for the high price in the market. Along with such structural issues that the system is not fully consolidated, then diesel plants are still the major power source and the country suffers high electricity rates.

Step 3 clarified the discrepancy among the regions in the Philippines. This is the result of the limitation in the traditional approach. The traditional development of power systems assumes the combination of large-scale and centrally-dispatched power plants, and large-capacity, high-voltage, long-distance, and centrally-controlled power grids. In the Philippines, this approach is not efficient, resulting in inequality in electricity access. Following the traditional approach in any manner will be costly and inefficient, worsening the discrepancy between the cities and rural areas. In addition, global warming is an urgent crisis for humanity. If the traditional development style is followed continuously, CO₂ emissions will grow significantly. From this perspective, a shift from fossil energy to renewable resources would be the only option to preserve the environment, improve living standards universally, and enhance national energy security.

Research Question 1 is answered in Step 2; the existing interconnector between Luzon–Visayas may not be capable of handling VRE generation if all the proposed capacity is installed. Provided that the country stays away from fossil fuel generation, the compatible volume of flexible sources, such as hydroelectric, storage, or ice-making plants would be needed to manage the proposed VRE generation. The limitation of this approach is that the desirable capacity of the interconnector cannot be determined without an accurate assumption of the future installation of VRE.

Research Question 2 is discussed in Step 3, concluding that the latest proposal for VRE development is effective in volume, but the distribution of VRE sources may correspond neither to the local electricity demands nor the needs of the local economy. A more coherent promotion of renewable energy development at a regional level would help improve rural ECR, thereby boosting the local economy.

The limitation of this study is that the relationship among the distribution of VRE, ECR, and local economic promotion is discussed qualitatively, which lacks quantitative evidence. Some measures to quantify the relationship among these factors are needed to clarify this issue.

To the best of my knowledge, this is the first report that evaluates the role and value of the interconnector qualitatively, under the virtual condition of a VRE-rich system. Additionally, this study provides an option to increase the VRE penetration level while mitigating the CO₂ emissions, along with a procedure to evaluate its economic viability.

Based on this study, the following political implications are derived:

- First, the distribution plan of renewable energy might be compatible with desired local economy promotion.
- Second, the interconnectors should be subject to the renewable energy development plan. A DC line is desirable.

Third, the combination of VRE and the supporting flexible sources would help reduce dependency on fossil energy. Therefore, it is worthwhile subsidizing the measures bilaterally.

REFERENCES

- Aquino, T. P. 2017. Philippine Energy Plan 2017-2040. Public Consultation on National Policy Review on Energy. 27 October. https://c.ymcdn.com/sites/psme.site-ym.com/resource/resmgr/technical/REVIEW_ON_ENERGY/Dir_Aquino_PEP_2017-2040.pdf (accessed 27 December 2018).
- Belyaev, S. L. 2011. Electricity Market Reforms – Economics and Policy Challenges. Springer Science+Business Media, LLC.
- Borenstein, S., M. Jaske, and A. Rosenfeld. 2002. Dynamic Pricing, Advanced Metering and Demand Response in Electricity Markets. University of California Energy Institute.
- Bushnell, J., and S. Stoff. 1996. Transmission and Generation Investment In a Competitive Electric Power Industry. Program on Workable Energy Regulation (POWER), University of California Energy Institute.
- Danish Energy Agency. 2015. Flexibility in the Power System – Danish and European experiences. Danish Energy Agency.
- Department of Energy (DOE) Philippines. 2016a. Philippine Energy Plan 2016-2030. Republic of the Philippines Department of Energy: <https://www.doe.gov.ph/pep/philippine-energy-plan-2016-2030> (accessed 27 December 2018).
- DOE Philippines. 2016b. 2016 Philippine Power Situation Report. Republic of the Philippines Department of Energy: <https://www.doe.gov.ph/electric-power/2016-philippine-power-situation-report> (accessed 17 July 2018).
- . 2017a. Power Supply and Demand Highlights (January-June 2017). Republic of the Philippines Department of Energy: <https://www.doe.gov.ph/electric-power/power-supply-and-demand-highlights-january-june-2017> (accessed 17 July 2018).
- . 2017b. 30th Electric Power Industry Reform Act (EPIRA) Implementation Status Report. Republic of the Philippines Department of Energy: <https://www.doe.gov.ph/electric-power/30th-status-report-epira-implementation> (accessed 17 July 2018).
- . 2018a. Energy Demand & Supply Outlook 2017-2040. Republic of the Philippines Department of Energy: <https://www.doe.gov.ph/pep/philippine-energy-plan-2017-2040> (accessed 28 December 2018).
- . 2018b. Sectoral Plans and Roadmaps 2017-2040. Republic of the Philippines Department of Energy: https://www.doe.gov.ph/sites/default/files/pdf/pep/pep_volume_2_sectoral_plans_and_roadmaps.pdf (accessed 29 December 2018).
- . 2018c. 2017 POWER DEMAND AND SUPPLY HIGHLIGHTS. Republic of the Philippines Department of Energy: https://www.doe.gov.ph/sites/default/files/pdf/electric_power/2017-power-demand-and-supply-highlights.pdf (accessed 21 December 2018).
- Ea Energy Analyses. 2015. The Danish Experience with Integrating Variable Renewable Energy: Lessons learned and options for improvement. Agora Energiewende: 20–29, 39–43.

- Energinet. 2018. Energy Data. Energinet: http://osp.energinet.dk/_layouts/Markedsdata/framework/integrations/markedsdatatemplate.aspx?language=en (accessed from October 2017 to June 2018).
- European Network of Transmission System Operators for Electricity (ENTSO-E). 2018. ENTSO-E Transparency Platform. ENTSO-E: <https://transparency.entsoe.eu/dashboard/show> (accessed 25 May 2018).
- Felder, A. F. 2011. Examining Electricity Price Suppression Due to Renewable Resources and Other Grid Investments. *The Electricity Journal* 24(4): 34–46
- Frederiksen, C. P. 1981. Further Evidence on the Relationship between Population Density and Infrastructure: The Philippines and Electrification Economic Development and Cultural Change 29(4): The University of Chicago Press.
- Herrin, N. A. 1979. Rural Electrification and Fertility Change in the Southern Philippines. *Population and Development Review* 5(1): Population Council.
- Hogan, W. W. 1992. Contract Networks for Electric Power Transmission. *Journal of Regulatory Economics* 4: 211–242, Kluwer Academic Publishers.
- Hong, W., and N. Abe. 2012. Sustainability assessment of renewable energy projects for off-grid rural electrification: The Pangan-an Island case in the Philippines. *Renewable and Sustainable Energy Reviews* 16: 54–64.
- International Energy Agency (IEA). 2014. *The Power for Transformation: Wind, Sun and the Economics of Flexible Power Systems*. IEA. OECD/ International Energy Agency (IEA).
- . 2017a. *Southeast Asia Energy Outlook 2017*. International Energy Agency (IEA).
- . 2017b. *Status of Power System Transformation 2017*. International Energy Agency (IEA).
- . 2017c. *Renewables 2017: Analysis and Forecasts to 2020*. International Energy Agency (IEA).
- . 2017d. *Energy Policies of IEA countries Denmark 2017 Review*. International Energy Agency (IEA).
- . 2017e. *Energy prices and taxes*. International Energy Agency (IEA).
- . 2018. *World Energy Outlook 2018*. International Energy Agency (IEA).
- . 2019. *What is energy security?*. International Energy Agency (IEA). <https://www.iea.org/topics/energysecurity/whatisenergysecurity/> (accessed 29 June 2019).
- International Renewable Energy Agency (IRENA). 2017. *Renewables Readiness Assessment: The Philippines*. International Renewable Energy Agency. <https://www.irena.org/publications/2017/Mar/Renewables-Readiness-Assessment-The-Philippines> (accessed 25 December 2018)
- Kanagawa, M., and T. Nakata. 2007. Analysis of the energy access improvement and its socio-economic impacts in rural areas of developing countries. *Ecological Economics* 62: 319–329.
- Kanagawa, M., and T. Nakata. 2008. Assessment of access to electricity and the socio-economic impacts in rural areas of developing countries. *Energy Policy* 36: 2016–2029.

- Moner-Girona, M. 2009. A new tailored scheme for the support of renewable energies in developing countries. *Energy Policy* 37: 2037–2041.
- Nadimi, R., and K. Tokimatsu. 2018. Modeling of quality of life in terms of energy and electricity consumption. *Applied Energy* 212: 1282–1294.
- National Economic and Development Authority (NEDA). 2017. Philippine Development Plan 2017-2022. Republic of the Philippines National Economic and Development Authority: http://www.neda.gov.ph/wp-content/uploads/2017/12/Abridged-PDP-2017-2022_Final.pdf (accessed 1 January 2019).
- National Grid Corporation of the Philippines (NGCP). 2015. Procedures and Requirements for Energy Projects & Transmission Development Plans Mindanao. NGCP. 28 October. hopkins.addu.edu.ph/moda/wp-content/uploads/2016/03/03_ngcps_procedures_and_requirements_for_energy_projects_and_transmission_development_plan_for_mindanao.pdf (accessed 4 November 2018).
- . 2016a. Experiences with Grid Integration of Wind Power in the Philippines. Asia Clean Energy Forum 2016. 6 June https://d1jikt90t87hr.cloudfront.net/449/wp-content/uploads/sites/2/2016/03/15Loria_Experiences_Wind_Grid_Integration-NGCP.pdf (accessed 4 November 2018).
- . 2016b. National Grid Corporation's Transmission Plans & Programs in Mindanao Region. Department of Energy (DOE) Investment Forum Mindanao https://www.doe.gov.ph/sites/default/files/pdf/e_ipo/2016_meif_ngcp_transmission_plans_programs_mindanao_region_2.pdf (accessed 4 November 2018).
- Nord Pool. 2018. Historical Market Data. Nord Pool. <https://www.nordpoolgroup.com/Market-data1/#/nordic/table> (accessed from October 2017 to April 2018)
- Nordic Energy Regulators (Nord REG). 2014. Nordic Market Report 2014: Development in the Nordic Electricity Market. Nordic Energy Regulators. <http://www.nordicenergyregulators.org/wp-content/uploads/2014/06/Nordic-Market-Report-2014.pdf> (accessed 31 March 2018).
- Organisation for Economic Co-operation and Development (OECD). 1999. Country Studies: Denmark – Regulatory Reform in Electricity 1999 <http://www.oecd.org/denmark/2497351.pdf> (accessed 3 July 2018).
- Pasten, C., and J. C. Santamarina. 2012. Energy and quality of life. *Energy Policy* 49: 468–476.
- Pereira, G. M., J. A. Sena, M. A. V. Freitas, and N. F. da Silva. 2011. Evaluation of the impact of access to electricity: A comparative analysis of South Africa, China, India and Brazil. *Renewable and Sustainable Energy Reviews* 15: 1427–1441.
- Philippine Electricity Market Corporation (PEMC). 2017a. Annual Market Assessment Report. Philippine Electricity Market Corporation. http://www.wesm.ph/inner.php/downloads/annual_market_assessment_reports (accessed 27 November 2018).
- . 2017b. Market Surveillance Committee 2017 Annual Report. Philippine Electricity Market Corporation. http://www.wesm.ph/inner.php/downloads/msc_reports/page/2 (accessed 27 November 2018).
- . 2018. Wholesale Electricity Spot Market (WESM) Download Center. Philippine Electricity Market Corporation. <http://www.wesm.ph/inner.php/downloads> (accessed 27 November 2018).

- Philippine Statics Authority. Housing Characteristics in the Philippines (Results of the 2015 Census of Population). Philippine Statics Authority. <http://www.psa.gov.ph/content/housing-characteristics-philippines-results-2015-census-population> (accessed 9 December 2018).
- Pudjianto, D., C. Ramsay, and G. Strbac. 2007. Virtual power plant and system integration of distributed energy resources. *IET Renew. Power Gener.*, 1, (1): 10–16.
- Roxas, F., and A. Santiago. 2016. Alternative framework for renewable energy planning in the Philippines. *Renewable and Sustainable Energy Reviews* 59: 1396–1404.
- Schneider, M., and A. Froggatt. 2018. The World Nuclear Industry Status Report 2018. World Nuclear Industry Status Report. A Mycle Schneider Consulting Project. Paris, London. September 2018. <https://www.worldnuclearreport.org/>.
- Shabanzadeh, M., M. Sheikh-EI-Eslami, and M. Haghifam. 2016. A medium-term coalition-forming model of heterogeneous DERs for a commercial virtual power plant. *Applied Energy* 169: 663–681.
- United States Agency for International Development (USAID). 2018. GREENING THE GRID: Solar and Wind Grid Integration Study for the Luzon-Visayas System of the Philippines. A Collaboration Between USAID and the Philippines' Department of Energy. January 2018. <https://www.nrel.gov/docs/fy18osti/68594.pdf> (accessed 4 November 2018).
- Verhoef, T. E. 2000. The implementation of marginal external cost pricing in road transport: Long run vs short run and first-best vs second-best. *Papers in Regional Science* 79: 307–332.
- Wang, J., Y. Zong, S. You, and C. Traholt. 2017. A review of Danish integrated multi-energy system flexibility options for high wind power penetration. *National Institute of Clean-and-Low-Carbon Energy. Clean Energy*: 1–13.
- World Bank. 2018. Access to electricity (% of population). World Bank <https://data.worldbank.org/indicator/EG.ELC.ACCS.ZS> (accessed 28 December 2018).