

Groves, Theodore; Ledyard, John

Working Paper

An Incentive Mechanism for Efficient Resource Allocation in General Equilibrium with Public Goods

Discussion Paper, No. 119

Provided in Cooperation with:

Kellogg School of Management - Center for Mathematical Studies in Economics and Management Science, Northwestern University

Suggested Citation: Groves, Theodore; Ledyard, John (1974) : An Incentive Mechanism for Efficient Resource Allocation in General Equilibrium with Public Goods, Discussion Paper, No. 119, Northwestern University, Kellogg School of Management, Center for Mathematical Studies in Economics and Management Science, Evanston, IL

This Version is available at:

<https://hdl.handle.net/10419/220479>

Standard-Nutzungsbedingungen:

Die Dokumente auf EconStor dürfen zu eigenen wissenschaftlichen Zwecken und zum Privatgebrauch gespeichert und kopiert werden.

Sie dürfen die Dokumente nicht für öffentliche oder kommerzielle Zwecke vervielfältigen, öffentlich ausstellen, öffentlich zugänglich machen, vertreiben oder anderweitig nutzen.

Sofern die Verfasser die Dokumente unter Open-Content-Lizenzen (insbesondere CC-Lizenzen) zur Verfügung gestellt haben sollten, gelten abweichend von diesen Nutzungsbedingungen die in der dort genannten Lizenz gewährten Nutzungsrechte.

Terms of use:

Documents in EconStor may be saved and copied for your personal and scholarly purposes.

You are not to copy documents for public or commercial purposes, to exhibit the documents publicly, to make them publicly available on the internet, or to distribute or otherwise use the documents in public.

If the documents have been made available under an Open Content Licence (especially Creative Commons Licences), you may exercise further usage rights as specified in the indicated licence.

DISCUSSION PAPER NO. 119

AN INCENTIVE MECHANISM FOR EFFICIENT
RESOURCE ALLOCATION IN GENERAL
EQUILIBRIUM WITH PUBLIC GOODS

by

Theodore Groves^{*} and John Ledyard⁺

December 1, 1974

* Research support was provided in part by a grant from the E.I. du Pont de Nemours and Co. to the Graduate School of Management, Northwestern University

+ Research support was provided in part by grants No. SOC 74-04076 and No. GS 31346X from the National Science Foundation to the Center for Mathematical Studies in Economics and Management Science

TABLE OF CONTENTS

| | | |
|------|---|-----|
| I. | Introduction | 1 |
| II. | The General Equilibrium Model | 11 |
| | 1. The Economy | 11 |
| | 2. The Government | 12 |
| | 3. Producer Behavior | 14 |
| | 4. Consumer Behavior | 14 |
| | 5. Equilibrium | 15 |
| | 6. Optimality | 17 |
| | 7. Some Examples of Governments | 19 |
| III. | The Existence of Equilibrium for a Class of Governments | 32 |
| | 1. Quasi-equilibrium and the Minimum Wealth Condition | 32 |
| | 2. The Basic Assumptions | 33 |
| | 3. The Existence of Quasi-Equilibrium | 38 |
| | 4. The Existence of an Equilibrium | 58 |
| | 5. Examples Revisited | 60 |
| IV. | The Groves-Ledyard Government | 65 |
| | 1. The Groves-Ledyard Rules | 65 |
| | 2. The Existence of a Quasi-Equilibrium Relative to the G-L Government | 72 |
| | 3. Pareto-Optimality of a Competitive Equilibrium Relative to the G-L Government | 84 |
| | 4. A Pareto-Optimum is an Equilibrium Relative to the G-L Government | 94 |
| | 5. A Simple Illustrative Example | 98 |
| | Appendix IV | 108 |

I. INTRODUCTION

It is widely believed that the achievement of a Pareto-optimal allocation of resources via decentralized methods in the presence of public goods is fundamentally incompatible with individual incentives. Samuelson [19], in particular, has argued this point most forcefully in showing the difficulties of extending the competitive market system to cover the allocation of public goods. This belief is so firmly embedded in conventional wisdom that the problem has acquired a name - the Free Rider Problem - and a considerable amount of work has been devoted to attempts at mitigating or circumventing the difficulties it poses.

This paper presents, to the best of our knowledge, the first decentralized method for optimally allocating resources in economies with public goods when consumers are allowed extensive opportunities to pursue their own self-interest and be "free riders" if they so choose. Basically our method consists of appending to the traditional competitive market mechanism in the private sectors (as formulated, for example, by Debreu [5]), an explicit procedure for determining consumers' demands for public goods and their tax burdens. Even though consumers are completely free to misrepresent their demands for public goods, the taxing and allocation rules we specify are structured in such a way that it is in each consumer's self-interest to reveal his true demand. Thus, we have not assumed away the Free Rider Problem, but have provided a possible solution to it. ^{1/}

As a guide to the contents of the paper the following summary may be useful. ^{2/} In Section II we formulate a class of mechanisms for allocating

public goods by adding a special agent - the government - to the standard Arrow-Debreu model of a private ownership economy. The government (which could be thought of as a computer similar to a Walrasian auctioneer) chooses according to fixed rules the level of public goods to be provided and the taxes to be levied on consumers and producers based on market prices for all goods and the information ("demands") communicated by consumers.

Consumers are assumed to know (or to be able to discover) the government rules and are free to communicate any information they desire. The government has no way of verifying the "correctness" or "truth" of the information communicated by consumers since it has no basis on which to compare alternative information from a consumer. In addition to choosing what information to send the government, consumers also choose (purchase) private goods bundles on competitive markets. In making their decisions, consumers are assumed to maximize their preferences over consumption bundles (containing both private and public goods) subject to their budget constraints (which include their tax burdens). We assume consumers behave competitively; that is, they treat as parameters the market prices for goods, their shares of firms' profits, and the information sent the government by other consumers. A rational consumer will, however, consider the impact of his decisions on the government's determination of the quantity of public goods to be provided and the taxes he must pay.

Producers are also assumed to behave competitively; that is, as profit maximizers treating prices and the taxes they face as parameters.

A member of the class of mechanisms is thus specified by any set of government allocation and taxing rules. Several examples of well known rules

are presented in Section II.7, both to illustrate the broad coverage of our general model and to emphasize the fact that these particular schemes do not lead to Pareto-optimal equilibrium allocation.

In Section IV we present our government rules. We then prove for these rules the two Fundamental Welfare Theorems - that an equilibrium under our rules is Pareto-optimal and that any Pareto-optimal allocation is an equilibrium following, if necessary, a redistribution of endowments and profit shares. These two theorems provide a partial substantiation for our claim of a solution to the Free Rider Problem.

A full substantiation requires that we demonstrate our claim is not vacuous. In example 2.2 of Section II.7, we present a very simple set of government rules with the property that an equilibrium under these rules is Pareto-optimal. But it is easily demonstrated that an equilibrium in this case rarely exists! Therefore, we have devoted a major portion of this paper (Sections III and IV.2) to proving that, under assumptions on consumers and producers not appreciably stronger than those used by Debreu [5], an equilibrium relative to our rules exists. In the process we prove an existence theorem for a wide class of government rules. The existence theorem thus establishes that our optimality results are not vacuous.

Finally, in Section IV.5 an illustrative example is presented to provide additional insight into the reasons why our rules have desirable incentive properties and others do not.

In order to place this paper in proper perspective, several points concerning its relationship to others in the literature on incentives and resource allocation in economies with public goods should be mentioned.

First of all, while our paper can be viewed as an extension of the Arrow-Debreu model of a private ownership competitive economy, it is clearly not the first such general equilibrium extension. Two others, by Arrow [2] and Foley [8], may be noted by way of contrasting our approach from others. Arrow's paper contains a purely formal extension of the Arrow-Debreu model to economies with externalities including public goods. For public goods economies, the formalization requires that every consumer's consumption of any public good be treated as a distinct commodity that is traded on a separate market. While this redefinition of the commodity space allows the standard welfare theorem that a competitive equilibrium is Pareto-optimal to apply for an economy with public goods it does not provide a solution to the Free Rider Problem for two reasons pointed out by Arrow.^{3/} First, to interpret an individual's consumption of a public good as a commodity distinct from another's consumption of the same public good, as is done for private goods, is to assume implicitly that a consumer can be limited in his consumption to the quantity he "purchases" in the market for that commodity (even though, in equilibrium, all consumers will consume the same good). This implicit assumption is, of course, incompatible with the definition of a public good and is the crux of the Free Rider Problem. Second, since each public good market has but one buyer, the assumption of competitive behavior, that the consumer treats as given the price he faces for his consumption of a public good, is untenable.

Our method of extending the Arrow-Debreu model to economies with public goods avoids both of these difficulties. It is explicitly incorporated in our model that a consumer's consumption of a public good depends not only on

his own decisions, but on other consumers' decisions as well through the government's allocation rule that determines the quantity of the public good to be made available to all consumers. Thus, any consumer may be a free rider if he chooses. Also, in our model, while the market for public goods has but one buyer - the government - the government's demand is determined by a fixed rule that depends on all consumers' decisions. Thus any one consumer can expect to have no more influence on the price of a public good than he can on the price of any private good. Consequently, the competitive behavioral assumption is essentially no stronger in our model with public goods than it is in an Arrow-Debreu model with private goods only.

In Foley's extension of the Arrow-Debreu model to public goods economies, an "equilibrium" is also shown to be Pareto-optimal. However, Foley provides no explicit mechanism for determining the quantity of public goods and the consumers' taxes. An "equilibrium" in his model is defined (in part) by a public goods bundle and a consumer tax distribution such that there exists no other public goods bundle and tax distribution adequate to pay for it that is unanimously preferred to the "equilibrium" bundle and tax distribution. To define an "equilibrium" in this way is rather like defining a competitive equilibrium to be an allocation-price pair such that the allocation is Pareto-optimal! What the mechanism is by which two different goods bundles and tax distributions might be compared or presented for comparison is not specified. In the absence of any such mechanism the behavior of consumers is ill-defined and incompletely specified. How consumers' preferences for public goods get translated into a public goods bundle and taxes is not explained. Thus the entire Free Rider Problem is completely ignored in Foley's paper. ^{4/}

Our paper, in contrast, by formulating an explicit mechanism for determining the quantities of public goods and the taxes, directly confronts the Free Rider Problem. Since every Pareto-optimal allocation is both an equilibrium allocation relative to our government rules and a Foley "equilibrium" allocation, a natural conjecture is that our mechanism is merely a procedure for reaching a Foley "equilibrium." Such a conjecture is, however, false. ^{5/} We conjecture instead that there are no government rules in the entire class our model permits such that an equilibrium relative to these rules is a Foley "equilibrium" for general economies.

Two other papers that formulate a mechanism for selecting public goods bundles and consumer taxes based on information communicated by consumers are those of Dreze and Vallee Poussin [7] and Malinvaud [17]. Furthermore, under the assumptions of these papers, their mechanism provides incentives for consumers to correctly reveal their preferences for public goods and leads to Pareto-optimal allocations. However, the behavioral assumptions made in these papers are more restrictive than those assumed here. In essence what they assume is that a consumer does not take the other consumers' decisions as given (the competitive assumption), but rather assumes the other consumers' decisions will be the least favorable ones for him. In game theoretic language, a consumer in these models is assumed to choose "minimax" decisions, whereas the competitive assumptions we made lead to Nash equilibrium decisions. As we show (in example 2.4 of Section II.7), if consumers behave competitively in the Dreze-Vallee Poussin and Malinvaud models, then an equilibrium under their rules is not, in general, Pareto-optimal.

Another pair of papers dealing with optimal resource allocation mechanisms and individual incentives are those Hurwicz [14] and Ledyard and Roberts [16]. Proved in these papers (by Hurwicz for pure exchange economies with private goods only and by Ledyard and Roberts for economies with public goods) is a theorem stating it is impossible to find a resource allocation mechanism that yields "individually rational" Pareto-optima and which is also "individually incentive compatible " ^{6/} for all agents. Our results are obviously not a counter-example to this theorem. The reason why the Hurwicz-Ledyard-Roberts theorem is not applicable to our model is that they allow consumers a broader range of strategic possibilities in their models than we do. As discussed above, we assume consumer behavior is competitive; in the Hurwicz and Ledyard-Roberts papers, this limitation on behavior is not assumed. Their results, however, imply that under our rules and an additional mechanism to select or find equilibrium prices, ^{7/} a very sophisticated consumer could formulate a decision strategy which would lead to a non-optimal resource allocation by considering how his decisions affect prices and his profit shares. ^{8/}

We have chosen to accept the limitations on strategic behavior implied by assuming competitive behavior not only because they permit us to derive positive results, but also because they are consistent with those of standard competitive models and also with those implicitly assumed in discussion of the Free Rider Problem.

Finally, the rules or methods we present in this paper for solving the Free Rider Problem were suggested by those presented in several papers by Groves [12] and Groves and Loeb [13]. The models of these papers, however, are partial equilibrium models in which payoffs to the different decision makers could be directly compared and transferred. In the language of game

theory, these models are n -person noncooperative games with transferable utility. Not only is our model a general equilibrium model (a characteristic that creates difficulties not present in the papers of Groves and Loeb), but since utility is not directly transferrable in our model their analysis does not attack the Free Rider Problem with public (consumption) goods.

FOOTNOTES FOR SECTION I

1/ We do not suggest, however, that it would be practical to institute directly the mechanism we propose any more than the Walrasian [^]tatonnement procedure could be literally instituted as a realistic mechanism for allocating private resources. Rather the solution we propose is in the nature of an idealized or theoretical solution. However, with a little imagination and further work, more practical versions could undoubtedly be developed. For an example of an attempt in this direction see Green and Laffont [11].

2/ Those interested only in the optimality of resource allocation under our rules can read Sections II. 1-6 and Sections IV. 1 and 3, without missing anything serious. Section IV. 4 should be read by those interested in the unbiasedness of our rules.

Those interested in existence should read II. 1-6, III. 1-4, and IV. 1 and 2.

Finally, examples of four government rules other than ours are used throughout to illustrate the model and the results. These can be found in Sections II. 7, III. 5, and IV. 5. The examples consist of a Naive Government, a Vacuous Government, a government designed to produce Lindahl equilibria if consumers reveal their preferences correctly and a government designed to allocate resources as proposed by Dreze and Vallee Poussin [7] and Malinvaud [17].

3/ See Arrow [2 , p.57]

4/ See Kihlstrom [15] for one possible mechanism which selects Foley "equilibria."

5/ See Remark 4.8, Section IV.

6/ These terms are defined in Hurwicz [14]

7/ By assuming competitive behavior and restricting our analysis to static equilibria, it is not necessary for us to specify precisely how prices are determined in our model. An obvious way to add a price determination mechanism would be to add a tatonnement price adjustment mechanism and show that under suitable assumption (e.g. gross substitutability) the iterative process would converge to a competitive equilibrium relative to our rules if consumers behave competitively. We have not done this yet.

8/ One could view the results of this paper as an extension of the classical welfare theorems proved by Arrow and Debreu to economies with public goods analogous to the Ledyard - Roberts generalization of Hurwicz's Impossibility Theorem:

| | Classical Economies w/ private goods only | Economies w/ public goods |
|--|--|------------------------------|
| Competitive Behavior | Arrow and Debreu | Groves - Ledyard |
| Optimality Theorems | | (this paper) |
| Full Strategic Behavior Impossibility Theorem | Hurwicz | Ledyard - Roberts |

II. THE GENERAL EQUILIBRIUM MODEL

II.1 The Economy

The model we consider is an Arrow-Debreu private ownership economy ^{1/} with public goods and a government. There are L private goods (indexed $\ell = 1, \dots, L$) and K public goods (indexed $k = 1, \dots, K$). A bundle of private goods is denoted by x and is an element of the private goods commodity space \mathbb{R}^L (the L -dimensional Euclidean space). A bundle of public goods is denoted by y and is an element of the public goods commodity space \mathbb{R}^K . Prices for private and public goods are denoted by the vectors $p \in \mathbb{R}^L$ and $q \in \mathbb{R}^K$ respectively, and the price vector $(p, q) \in \mathbb{R}^{L+K}$ of all goods is denoted by s .

The model has two types of ordinary economic agents - consumers and producers - plus a special agent - the government. There are I consumers (indexed $i = 1, \dots, I$), each of which is characterized by . a) his consumption set $\mathcal{X}^i \subseteq \mathbb{R}^{L+K}$, b) his preference relation \preceq_i on \mathcal{X}^i , and c) his initial endowment of private ^{2/} goods, $w^i \in \mathbb{R}^L$.

There are J producers (indexed $j = 1, \dots, J$), each of which is characterized by his production set, $Z^j \subseteq \mathbb{R}^{L+K}$. Each element $z^j = (z_1^j, z_2^j)$ in the set Z^j is a technologically feasible input-output vector whose negative components denote inputs and whose positive components denote outputs. Associated with each producer j is a profit share distribution $\langle \theta^{ij} \rangle_i$ such that $0 \leq \theta^{ij} \leq 1$ and $\sum_i \theta^{ij} = 1$, where θ^{ij} is the i^{th} consumer's share of producer (firm) j 's profits.

Thus far no distinction has been made between private and public goods except for their labeling. The distinction occurs by specifying that the entire

net production of public goods, $\sum_j z_2^j = z_2$ is consumed by each consumer, whereas the net production of private goods, $\sum_j z_1^j = z_1$, must be divided among the consumers. This distinction is formalized by the definition of an attainable allocation:

Definition 2.1: (i) An allocation is an $(I + 1 + J)$ - tuple $(\langle x^i \rangle, y, \langle z^j \rangle)$, where $x^i \in \mathbb{R}^L$, $y \in \mathbb{R}^K$, and $z^j \in \mathbb{R}^{L+K}$.

(ii) An attainable allocation is any allocation such that:

- a) $(x^i, y) \in \mathcal{X}^i$ for $i = 1, \dots, I$,
- b) $z^j \in Z^j$ for $j = 1, \dots, J$, and
- c) $(\sum_i (x^i - \omega^i), y) = \sum_j z^j$

A private ownership economy will be denoted by

$$\mathcal{E} = \{ \langle \mathcal{X}^i, \omega^i \rangle_i, \langle Z^j \rangle_j, \langle \theta^{ij} \rangle_{i,j} \}.$$

II.2 The Government

In the model, private goods may be purchased by consumers in private markets; public goods will be purchased in private markets and provided to the consumers by the special economic agent - the government. This agent has, therefore, two basic tasks or functions to perform. First, it must choose the quantity of each of the K public goods it will purchase and provide the consumers. Second, it must raise, through taxes, the necessary funds to finance its purchases of the public goods. In order to carry out these tasks in a socially desirable or non-arbitrary manner, the government will have to communicate with the consumers. To make precise the concept of communication, we specify an abstract set M to be the language or message space. Each

consumer, i , selects an element $m^i \in M$ where m^i is interpreted to be the consumer's message to the government.

In addition to the language, M , the government is characterized by rules that specify a) what public goods bundle to purchase, the allocation rule, and b) what taxes to levy on consumers and producers, the taxing rules. Given the language, the rules define specific quantities of public goods and taxes for every I -tuple of messages $m = (m^1, \dots, m^I)$ received from consumers and every price vector $s = (p, q)$ prevailing in the private markets for private and public goods.

Formally, the allocation rule is a function $y: M^I \times \mathbb{R}^{L+K} \rightarrow \mathbb{R}^K$. Thus $y(m, s)$ is the vector of public goods purchased by the government and supplied to consumers if it receives the messages $m = (m^1, \dots, m^I)$ from consumers and the prices prevailing in the market place are s . The consumers' tax rules are formally specified as (real-valued) functions $C^i: M^I \times \mathbb{R}^{L+K} \rightarrow \mathbb{R}$, $i = 1, \dots, I$. Thus, $C^i(m, s)$ is the lump-sum tax levied on consumer i when the government receives the messages m and the market prices are s . ^{3/}

The producers' tax rules are formally specified as pairs of (real-valued) functions, $R^j: M^I \times \mathbb{R}^{L+K} \rightarrow \mathbb{R}^2$, $j = 1, \dots, J$. The first function, $R_1^j(\cdot)$, of each pair is defined as a percentage tax rate on (before-tax) profits of firm j and thus is bounded between zero and unity. The second function, $R_2^j(\cdot)$, of each pair is defined as a lump sum tax ^{4/} on the firm.

A government, G , is then completely specified by a language M , an allocation rule $y(\cdot)$, consumer tax rules, $\langle C^i(\cdot) \rangle$, and producer tax rules $\langle R^j(\cdot) \rangle$, and we write $G = \{M, y, \langle C^i \rangle, \langle R^j \rangle\}$. By specifying a government, the behavior of the special agent of our model is given explicitly.

II. 3 Producer Behavior

Producers are assumed to behave as price - and tax-taking profit maximizers. That is, given prices $s = (p, q)$, the tax rate on pre-tax profits, r_1^j , and the lump-sum tax, r_2^j ; producer j chooses an input-output vector in his production set Z^j so as to maximize after-tax profits, $(1 - r_1^j)(s z^j) - r_2^j$.

Definition 2.2: (i) The supply correspondence of the j^{th} firm,

$\phi^j: \mathbb{R}^{L+K} \times \mathbb{R}^2 \rightarrow \mathbb{R}^{L+K}$, is defined by:

$$\phi^j(s, r^j) \equiv \{z^j \in Z^j \mid (1 - r_1^j)(s z^j) - r_2^j \text{ is maximal over } Z^j\}.$$

(ii) The after-tax profit function of the j^{th} firm $\Pi^j: \mathbb{R}^{L+K} \times \mathbb{R}^2 \rightarrow \mathbb{R}$ is defined by:

$$\Pi^j(s, r^j) = (1 - r_1^j)(s \cdot \phi^j(s, r^j)) - r_2^j.$$

II.4 Consumer Behavior

Concerning consumer behavior, each consumer must make two decisions. He must choose a private goods consumption bundle, $x^i \in \mathbb{R}^L$, and a message, $m^i \in M$, to send the government. Consumers are assumed to take as given the prices of all goods, their shares of the firms' profits, and the messages of all other consumers. Consumers do consider the fact that the message they send may affect the quantity, y , of public goods provided by and the tax, C^i , levied by the government. Thus they will choose a decision pair (x^i, m^i) to maximize preferences over consumption bundles (x^i, y) subject to a budget constraint.

Definition 2.3: (i) The budget correspondence of the i^{th} consumer,

$B^i: M^{I-1} \times \mathbb{R}^{L+K} \times \mathbb{R} \rightarrow \mathbb{R}^L \times M$, is defined by $\frac{5}{/}$:

$$B^i(m)^i(s, w^i) \equiv \{(\bar{x}^i, \bar{m}^i) \in \mathbb{R}^L \times M \mid \\ (\bar{x}^i, y(m/\bar{m}^i, s)) \in \mathcal{X}^i, p \cdot \bar{x}^i + C^i(m/\bar{m}^i, s) \leq w^i\}$$

where $w^i = p\omega^i + \sum_j \theta^{ij} \pi^j$ is the value of his wealth.

(ii) The decision correspondence of the i^{th} consumer, $\Delta^i: M^{I-1} \times \mathbb{R}^{L+K} \times \mathbb{R} \rightarrow \mathbb{R}^L \times M$ is defined by:

$$\Delta^i(m)^i(s, w^i) \equiv \{(\bar{x}^i, \bar{m}^i) \in B^i(m)^i(s, w^i) \mid \\ (\bar{x}^i, y(m/\bar{m}^i, s)) \succsim_i (\hat{x}^i, y(m/\hat{m}^i, s)) \text{ for all } (\hat{x}^i, \hat{m}^i) \in B^i(m)^i(s, w^i)\}$$

Loosely speaking, the consumer's choice maximizes the indirect utility of (x^i, m^i) given $(m)^i(s)$ subject to a budget constraint given $(m)^i(s, w^i)$.

II.5 Equilibrium

In defining a competitive equilibrium for a model, it is convenient to reduce notation by defining new mappings which substitute for ϕ^j, π^j, B^i , and Δ^i :

Definition 2.4: The mappings $\varphi^j, \pi^j, \beta^i$, and δ^i are defined as follows:

- i) $\varphi^j: M^I \times \mathbb{R}^{L+K} \rightarrow \mathbb{R}^{L+K}$ where $\varphi^j(m, s) \equiv \phi^j(s, R^j(m, s))$,
- ii) $\pi^j: M^I \times \mathbb{R}^{L+K} \rightarrow \mathbb{R}$ where $\pi^j(m, s) \equiv \pi^j(s, R^j(m, s))$,
- iii) $\beta^i: M^I \times \mathbb{R}^{L+K} \rightarrow \mathbb{R}^L \times M$ where $\beta^i(m, s) \equiv B^i(m)^i(s, w^i(m, s))$
and $w^i(m, s) \equiv p\omega^i + \sum_j \theta^{ij} \pi^j(m, s)$, and
- iv) $\delta^i: M^I \times \mathbb{R}^{L+K} \rightarrow \mathbb{R}^L \times M$ where $\delta^i(m, s) \equiv \Delta^i(m)^i(s, w^i(m, s))$.

The mappings $\varphi^j, \pi^j, \beta^i$, and δ^i are referred to respectively as the supply correspondence, the (after-tax) profit function, the budget correspondence, and the decision correspondence. ^{6/}

Remark 2.1: The budget correspondence β^i depends on the message m^i of consumer i through its effect on the taxes levied on producers and thus on the after tax profit shares of consumer i . The competitive assumption that consumers take their profit shares as given implies, therefore, that they neglect the impact of their messages on their profit shares or on their budget set. However, for all governments such that producer taxes are zero, i.e. $R^j(m,s) \equiv (0,0)$, profits, profit shares, and hence each consumer's budget will be independent of not only of his own message, but of all consumers' messages. In such cases, the budget correspondence will be identical to that of the private goods only model, c.f. Debreu [5].

The examples of various governments discussed in Section II.7 all have zero producer taxes. The specific government we propose in Section IV does not; however, a minor modification to the consumer tax rules can be made that permits zero taxation of producers. Thus our optimality results in Section IV do not depend in any essential way on the implicit assumption that the effect of a consumer's message on his budget set is ignored by the consumer. (See footnote on page 71).

The definition of equilibrium for our model is that of a Nash or non-cooperative equilibrium.

Definition 2.5: A competitive equilibrium relative to the government

$G = \{M, y(\cdot), \langle C^i(\cdot) \rangle, \langle R^j(\cdot) \rangle\}$ in the private ownership economy

$\mathcal{S} = \{\langle x^i, z^i, w^i \rangle, \langle z^j \rangle, \langle \theta^{ij} \rangle\}$ is an $(I + J + 1)$ -tuple $\{\langle x^i, m^i \rangle, \langle z^j \rangle, s\}$ of

consumer decisions, producer decisions, and a price system such that:

- a) $\langle x^i, m^i \rangle \in \delta^i(m,s)$ for all $i = 1, \dots, I$ (preference maximization)
- b) $z^j \in \varphi^j(m,s)$ for all $j = 1, \dots, J$ (profit maximization),

c) $(\sum_i (x^i - w^i), y(m, s)) = \sum_j z^j$ (supply equals demand),
 and d) $s \geq 0$

Remark 2.2: If (a) the allocation rule $y(m, s)$ and the producers' percentage tax rate rules $R_1^j(m, s)$ are all homogeneous of degree zero in prices s , and (b) the consumers' tax rules $C^i(m, s)$ and the producers' lump sum tax rules $R_2^j(m, s)$ are homogeneous of degree one in prices, then (i) the producers' profit functions $\pi^j(m, s)$ and the consumers' wealth functions $w^i(m, s)$ are homogeneous of degree one in prices, and (ii) the supply, budget, and decision correspondences, φ^j, β^i , and δ^i , are homogeneous of degree zero in prices. Thus, if $\{\langle x^i, m^i \rangle, \langle z^j \rangle, s\}$ is an equilibrium under these conditions, then $\{\langle x^i, m^i \rangle, \langle z^j \rangle, \lambda s\}$ is also an equilibrium where λ is any positive real number. Hence under restrictions (a) and (b) on the government rules, the unit simplex S defined by:

$$S = \{s = (p, q) \in \mathbb{R}_+^{L+K} \mid \sum_l p_l + \sum_k q_k = 1\}.$$

may be substituted for the price space \mathbb{R}^{L+K} in all the above specifications and definitions and instead of d) in definition (2.5) the restriction, d') $s \in S$, may be substituted.

Remark 2.3: It can easily be seen that definition (2.5) is a generalization of the definition of a competitive equilibrium for a private ownership Arrow-Debreu economy. ^{7/} Let $X^i \equiv X^i \times \{0\}$ for each i and $Z^j \equiv Y^j \times \{0\}$ for each j (where $0 \in \mathbb{R}^K$). Also, let $y(m, s) \equiv 0, C^i(m, s) \equiv 0$, and $R^j(m, s) \equiv 0$ for all $(m, s) \in M^I \times \mathbb{R}^{L+K}$. Then $\{\langle x^i \rangle, \langle z^j \rangle, p\}$ is a Debreu equilibrium if and only if for all I -tuples of messages $m = (m^1, \dots, m^I)$ $\{\langle x^i, m^i \rangle, \langle z^j \rangle, (p, 0)\}$ is an equilibrium relative to the given government rules.

II.6 Optimality

To discuss the optimality properties of competitive equilibria, the following definition is needed:

Definition 2.6: A competitive allocation relative to the government G is an allocation $\{\langle x^i \rangle, y, \langle z^j \rangle\}$ such that there exist messages $\langle m^i \rangle$ and a price system s such that $\{\langle x^i, m^i \rangle, \langle z^j \rangle, s\}$ is a competitive equilibrium relative to the government G and $y = y(m, s)$.

Two fundamental theorems of welfare economics assert for a private ownership economy (without public goods) that under suitable conditions (i) every competitive allocation is Pareto optimal and (ii) every Pareto-optimal allocation is competitive for some initial distribution of endowments and profit shares. ^{8/} Pareto-optimality is defined for our economy \mathcal{E} with public goods by:

Definition 2.7: An allocation $\{\langle x^i \rangle, y, \langle z^j \rangle\}$ in \mathcal{E} is Pareto-optimal if a) it is attainable and b) there does not exist another attainable allocation, $\{\langle \hat{x}^i \rangle, \hat{y}, \langle \hat{z}^j \rangle\}$ such that $(\hat{x}^i, \hat{y}) \succ_i (x^i, y)$ for all $i = 1, \dots, I$, and $(\hat{x}^{i_0}, \hat{y}) \succ_{i_0} (x^{i_0}, y)$ for at least one i_0 .

Although conventional wisdom on the subject ^{9/} suggests that it is not possible to find government rules such that a competitive allocation relative to these rules is Pareto-optimal, in Section IV we define a specific government and then prove (under conditions on the economy \mathcal{E} that are remarkably similar to those in Debreu [5]) not only that every competitive allocation relative to our government is Pareto-optimal, but also that every Pareto-optimal allocation is competitive relative to our rules for some initial distribution of endowments and profits shares.

In order to prove that the Pareto-optimality of a competitive allocation relative to our rules is not a vacuous result, we also establish in Section IV conditions for the existence of a competitive equilibrium relative to our government. In Section III a general existence theorem is proved for a wide class of governments satisfying certain conditions.

II.7 Some Examples of Governments

Before discussing the existence of competitive equilibria and our specific government, it may be helpful to provide several examples of government rules that have been discussed, more or less explicitly, in the literature. The examples will aid the understanding of the general model detailed above.

Example 2.1 The Naive Government

In this example, public goods are treated just like private goods. Each consumer reports to the government how much of each public good he wants to purchase. The government provides the aggregate amount requested (the sum of consumer demands). Each consumer pays for the amount he requested at the current market prices; however he is able to consume the total amount provided.

In terms of our model, the "naive government" $G^N = \{M, y, \langle C^i \rangle, \langle R^j \rangle\}$ is specified by:

- a) $M = \mathbb{R}_+^K$: the non-negative orthant of the public goods commodity space.
- b) $y(m, s) = \sum_i m^i$
- c) $C^i(m, s) = q \cdot m^i, \quad i = 1, \dots, I$
- c) $R^j(m, s) = 0, \quad j = 1, \dots, J.$

It is well-known that a competitive equilibrium relative to these rules is not Pareto-optimal since each consumer will be a "free-rider" with respect to the public goods. In particular, in selecting his demand, m^i , a consumer will evaluate additional units in terms of their full social costs q , but also only in terms of the marginal private benefit they will confer upon him.

Thus, generally, too few resources will be devoted to the provision of public goods and too many to the provision of private goods for an equilibrium allocation to be Pareto-optimal.

Example 2.2: The Vacuous Government

In this example, a revision of the "Naive Government" is presented that attempts to achieve optimality. The revision consists of altering the consumers' taxing rule to:

$$(c') \quad C^i(m,s) = q \cdot \frac{\sum_i m^i}{I}, \quad i = 1, \dots, I.$$

The language, allocation rule, and producers' tax rules are the same as for the "naive government." The revised consumer tax rules tax each consumer the average per capita cost of providing the public goods $y(m,s)$. It is very easy to establish that if preferences of consumers are locally non-satiated, then a competitive allocation relative to the government defined by $M = R^K$, (b), (c') and (d) above is Pareto-optimal ^{10/} Therefore, this government apparently has very simple rules that lead to optimal resource allocation.

However, this result is essentially vacuous since it is only in exceptionally rare and uninteresting economies that a competitive equilibrium relative to these rules exists! This is quite easy to see by observing that, in equilibrium, each consumer's budget constraint has the same normal vector, $(p,q/I)$, and thus differ only in the wealth term. Also, in equilibrium each consumer must desire the same level of public goods. Thus, in order for an equilibrium to exist, there must be at least one bundle of public goods such that each consumer's marginal rates of substitution are identical at levels of the

private goods adding up to $\sum_i \omega^i$ - an unlikely occurrence.

In Section III.5, the reasons for lack of existence are discussed with an illustrative example. It is also pointed out that if a compact convex subset of \mathbb{R}^K is used for M an equilibrium exists; however, it will not usually be Pareto-optimal. Thus, either an equilibrium exists or it is Pareto-optimal but both occur simultaneously only rarely.

The moral of this example is that optimality results should be accepted only if a demonstration of non-vacuousness is made. We go to great lengths in Sections III and IV to avoid just this difficulty.

Example 2.3: The Lindahl Government

In this example, the government rules are designed so that, if consumers report "truthfully" ^{11/} then an equilibrium allocation will be a Lindahl equilibrium allocation which is, of course, Pareto-optimal. Each consumer is asked to report his marginal "willingness to pay" or his marginal rate of substitution between each public good and some numeraire private good. The amounts of the public goods provided are those such that the sum of the consumers' marginal willingness to pay equals the marginal costs, q , of providing the public goods. Each consumer is then taxed for the total quantity of each public good at a (per unit) rate equal to his reported marginal willingness to pay.

In terms of our model, suppose consumers' preferences are representable by continuously differentiable, strictly quasi-concave utility functions $u^i(x^i, y)$, $i = 1, \dots, I$. The language, M , of the Lindahl Government is defined to be the space of all functions $m^i: \mathbb{R}_+^K \rightarrow \mathbb{R}_+^K$ and $m^i(y)$ is interpreted as the K -dimensional vector of consumer i 's marginal willingness to pay, ^{12/} in terms of some fixed numeraire private good, for an additional unit of each public good at the level y . To motivate this interpretation

consider what it means for a consumer to report "truthfully" or to send the "true" message. We will say that $m^i \in M$ is the true message if $m^i(\cdot)$ is his true vector of marginal rates of substitution; that is, if for each $y^* \in \mathbb{R}_+^K$, (x^{i*}, y^*) solves $\text{Max } u^i(x, y)$ subject to $px^i + m^i(y^*) \cdot y \leq w^i$ then $m^i(\cdot)$ is a true message. 13/ (x^i, y)

With this language M the Lindahl Government is completely defined by the rules:

- a) $y(m, s)$ is any bundle of public goods such that for every k ,
 $\sum_i m_k^i(y_k) = q_k$ unless $\sum_i m_k^i(y_k) < q_k$ for all $y_k \geq 0$ in
 which case $y_k = 0$
- b) $C^i(m, s) = m^i[y(m, s)] \cdot y(m, s)$, $i = 1, \dots, I$,
- c) $R^j(m, s) = 0$, $j = 1, \dots, J$.

The allocation rule selects that bundle of public goods such that the sum of all the reported marginal rates of substitutions for each public good equals its price (marginal cost). The consumer taxing rule assesses each consumer i for the bundle y at the price $m^i(y)$ per unit.

This specification of the Lindahl government might appear somewhat strange at first glance. One might wonder, for example, if it is necessary to use as the message space the space of all functions instead of, say, simply \mathbb{R}_+^K where each message would be interpreted as a vector of marginal rates of substitution for a given bundle of public goods. In fact, the message space $M = \mathbb{R}_+^K$ could be used to specify the Lindahl Government if we adopted much more complicated allocation and consumer tax rules based on a continuous iteration procedure similar to tatonnement. For example, consumers might be asked at every instant t to report their marginal rates of substitution

$\tilde{m}^i(t)$ between the public goods and some numeraire private commodity evaluated at that instant's public good vector $\tilde{y}(t)$ and the private goods bundle $x^i(t)$ that maximizes utility subject to a budget constraint in which they are charged $m^i(t) \cdot y(t)$ for the public goods. The government would then adjust $y(t)$ in accordance with a rule $\dot{y}(t) \equiv \frac{dy(t)}{dt} = f(\tilde{m}(t), s, \tilde{y}(t))$ that increases (decreases) the quantities of those public goods for which the sum of all consumers reported marginal rates of substitution is greater (less) than the price. Problems of dynamics (convergence of the procedure) aside, an equilibrium of this iterative procedure would give the same allocation and taxes as the Lindahl rules defined above where the message $\hat{m}^i \in M \equiv \{m^i \mid m^i: \mathbb{R}_+^K \rightarrow \mathbb{R}_+^K\}$ satisfies $\tilde{m}^i(t) = \hat{m}^i(y(t))$; that is, the consumer's message \hat{m}^i under the Lindahl Government rules is that function which would have given the iterative procedure's messages $\tilde{m}^i(t)$ at every instant t when evaluated at $\tilde{y}(t)$. Thus by our specification of the Lindahl Government's language space M as a space of functions, we have merely short-circuited a lengthy iterative procedure.

It is easy to see that a competitive allocation relative to the Lindahl Government is Pareto-optimal if all consumers report truthfully, since a competitive equilibrium relative to the Lindahl Government is then a Lindahl equilibrium ^{14/} where consumer i 's public goods prices are $t^i = m^i(y^*)$ and y^* is the Lindahl equilibrium level of public goods. And, as is well-known, a Lindahl equilibrium allocation is Pareto-optimal under the assumptions stated above on preferences. ^{15/}

However, as is shown for a simple specific model in Section IV.5, at a competitive equilibrium relative to the Lindahl Government, each consumer will be understating his true marginal willingness to pay and consequently too few

resources will be allocated to public goods for Pareto-optimality to obtain. Thus, although the rules of the Lindahl Government were designed to produce Lindahl equilibria if consumers are truthful, they create incentives for consumers to be untruthful. Hence, while Lindahl equilibrium allocations are, in general Pareto-optimal, competitive allocations relative to the Lindahl government are not.

Example 2.4 The Dreze-Vallee Poussin-Malinvaud (DVM) Government

In this example we attempt to capture, in terms of our model, the planning procedures for guiding and financing the production of public goods that have been proposed by Dreze and Vallee Poussin [7] and Malinvaud [17]. While their rules are developed as a tatonnement process, and our model is expressed in terms of a single message from each consumer to the government, ^{16/} we will define allocation and taxing rules that yield the same solution as their rules do through the iteration procedure. In particular, each consumer will send a message interpreted as the maximum total amount he is willing to pay for each bundle of public goods. The allocation rule will then choose that level of public goods which maximizes the reported social surplus. The consumer's tax will be computed in two parts: ^{17/} (1) the amount that he reports he is willing to pay, and (2) a "dividend" amounting to a share of the government budget surplus at the tax rates defined by (1). Producers are not taxed.

Formally, the language M of the DVM government is the set of all real-valued functions on \mathbb{R}_+^K : $M \equiv \{m^i: \mathbb{R}_+^K \rightarrow \mathbb{R}^1\}$. The rules of the DVM government are defined by:

- a) $y(m,s)$ is the solution ^{18/} to the problem

$$\begin{aligned} & \text{Maximize } \sum_i m^i(y) - qy, \\ & y \in \mathbb{R}_+^K \end{aligned}$$

- b) $C^i(m,s) \equiv m^i[y(m,s)] - \delta^i [\sum_h m^h(y(m,s)) - qy(m,s)]$
 for $i = 1, \dots, I$, where $\delta^i > 0$ and $\sum_i \delta^i = 1$.
- c) $R^j(m,s) \equiv 0$ for $j = 1, \dots, J$.

We assume, for purposes of this example, that there is only one private good (as is assumed by Dreze-Vallee Poussin [7]) and that ^{19/} the aggregate production set Z has the specific form

$$Z = \{ (x,y) \in \mathbb{R}^{1+K} \mid x \leq 0, y \geq 0, x + \gamma y \leq 0, \gamma \text{ a positive vector} \}$$

That this specification of the DVM government is a fair representation of the tatonnement models of Dreze-Vallee Poussin and Malinvaud can be seen as follows: An obvious way of solving the problem in (a) for $y(m,s)$ is through an iterative gradient procedure. In particular, let

$$(a') \quad \dot{y}_k = \begin{cases} \sum_i m_k^i(y) - q_k & \text{if } y_k > 0 \\ \text{Max} [0, \sum_i m_k^i(y) - q_k] & \text{if } y_k = 0 \end{cases}$$

for $k = 1, \dots, K$, where $m_k^i(y) \equiv \partial m^i(y) / \partial y_k$. If the functions $m^i(\cdot)$ are concave and (continuously) differentiable, then any solution to (a') has the property that $y(t)$ converges to $y(m,s)$ which is defined by (a). Having chosen the iterative method for solving (a), iterative tax rules are implied by (a'), (b), and (c). That is:

$$(b') \quad \dot{C}^i = m_y^i[y(t)] \cdot \dot{y} - \delta^i [\sum_h m_g^h(y(t)) \cdot \dot{y} - q \dot{y}], \text{ and}$$

$$(c') \quad \dot{R}^j = 0$$

Because of the special constant returns to scale form of the Production set Z , in equilibrium the relative prices of public goods equals the vector γ ; or, normalizing the private good's price at 1, $q = \gamma$. Also, by (a') it follows that $(\sum_h m_y^h(y(t)) \cdot \dot{y} - q \dot{y}) = \dot{y} \cdot \dot{y}$. Additionally, if $\dot{x} = -\gamma \dot{y}$, then (x, y) will remain in Z if $(x(0), y(0)) \in Z$. Finally, from the budget constraint (for $p = 1$), $x^i = w^i - C^i$. Combining these facts with (a') - (c') yields:

$$(a'') \quad \dot{y}_k = \begin{cases} \sum_i m_k^i(y(t)) - \gamma_k & \text{if } y_k^{(t)} > 0 \\ \text{Max } [0, \sum_i m_k^i(y(t)) - \gamma_k] & \text{if } y_k^{(t)} = 0 \end{cases}$$

$$(d) \quad \dot{x} = -\gamma \dot{y}, \text{ and}$$

$$(e) \quad \dot{x}^i = -m_y^i(y) \cdot \dot{y} + \delta^i \dot{y} \cdot \dot{y}$$

which are identical with equations (1), (3), and (7) of Dreze-Vallee Poussin [7, p.13] when $m_y^i(y(t)) = \pi^i(t)$ where $\pi^i(t) \equiv \pi^i(x^i(t), y(t))$ and

$$\pi_k^i(\cdot) = \left(\frac{\partial u^i}{\partial y_k} / \frac{\partial u^i}{\partial x^i} \right); \quad \text{i.e., when } m_y^i(y(t)) \text{ is the consumer's true}$$

vector of marginal rates of substitution at the consumption bundle $(x^i(t), y(t))$.

Thus, if the message $m^i(y)$ (interpreted as the consumer's maximum reported willingness to pay) has the property that its gradient vector (the reported marginal willingness to pay) equals his true marginal rates of substitution; i.e. $m_y^i(y(t)) = \pi^i(t)$, then we consider the message $m^i(\cdot)$ as "truthful." However, as Dreze and Vallee-Poussin recognize, it is possible that consumer i may be able to benefit by reporting a message $m^i(\cdot)$ such that $m_y^i[y(t)] = \psi^i(t)$ where $\psi^i(t)$ is some function of t other than $\pi^i(t)$. What Dreze-Vallee Poussin

show is that truthful reporting, i.e. selecting $m^i(\cdot)$ such that $m_y^i[y(t)] = \psi^i(t) = \pi^i(t)$, is a minimax strategy (of a particular game) and that, if the process is at an equilibrium (i.e. $\dot{y}_k = 0$ for all k), then $m_y^i[y(t)] = \psi^i(t) = \pi^i(t)$ is a Nash equilibrium strategy.

But, in spite of these results, it is relatively easy to show that a competitive equilibrium relative to the DVM government [(a),(b),(c)] is not, in general, Pareto-optimal. To see this, consider an economy with one private and one public good where production of one unit of the public good requires the input of one unit of the private good. Let consumer preferences be representable by utility function $u^i(x^i, y)$ with continuous derivatives. Now suppose $(\langle x^{i*}, m^{i*} \rangle, z^*, s^*)$ is a competitive equilibrium relative to the DVM government such that $x^{i*} > 0$ for all i and $y(m^*, s^*) > 0$. 20/ Consider the messages $m^{i**}(y) = m^{i*}(y) + \beta^i y$, since m^{i*} is an equilibrium message, it must be the case that:

$$\frac{\partial u^i [p^* w^i - C^i(m^*/m^{i**}, s^*), y(m^*/m^{i**}, s^*)]}{\partial \beta^i} = 0$$

when evaluated at $\beta^i = 0$. That is,

$$u_y^i \cdot \left(\frac{\partial y^*}{\partial \beta^i} \right) - u_{x^i}^i \cdot \left[m_y^{i*} \left(\frac{\partial y^*}{\partial \beta^i} \right) + y^* - \delta^i (\sum m_y^* - q) \frac{\partial y^*}{\partial \beta^i} - \delta^i y^* \right] = 0,$$

or

$$\left[\frac{u_y^i}{u_{x^i}^i} - m_y^{i*} \right] \left(\frac{\partial y^*}{\partial \beta^i} \right) + (1 - \delta^i) y^* = 0.$$

Summing over all i yields

$$\left[\sum_i \frac{u_y^i}{u_x^i} - q^* \right] \frac{\partial y^*}{\partial \beta^i} + \sum_i (1 - \delta^i) y^* = 0.$$

In order for optimality to obtain, it must be true that $\sum_i \frac{u_y^i}{u_x^i} - q^* = 0$.

Thus, if the equilibrium is Pareto-optimal, then

$$\sum_i (1 - \delta^i) y^* = (I-1) y^* = 0 \text{ which implies (for } I > 1) \text{ that } y^* = 0$$

contradicting the condition that $y^* > 0$. Thus, a competitive equilibrium relative to the DVM government is not, in general, Pareto-optimal. 21/

FOOTNOTES FOR SECTION II

1/ See Arrow and Debreu [3], or Debreu [5].

2/ We assume throughout that neither consumers nor the economy possess any initial endowments of public goods.

3/ Although it is not explicit in the above formulation, it is possible to include with this formulation taxing rules that depend on the level of public goods purchased. If $\tilde{C}^i(m, y, s)$ is such a rule, we simply let $C^i(m, s) = \tilde{C}^i(m, y(m, s), s)$ where $y(\cdot)$ is the allocation rule.

4/ Or subsidy, if $R_2^j(m, s)$ is negative.

5/ Throughout this paper we use the notation:

$$m^i \equiv (m^1, \dots, m^{i-1}, m^{i+1}, \dots, m^I)$$

$$(m/\bar{m}^i) \equiv (m^1, \dots, m^{i-1}, \bar{m}^i, m^{i+1}, \dots, m^I).$$

6/ Although ϕ^j, Π^j, B^i , and Δ^i could have been defined originally in this way, we choose not to in order that it be made explicitly clear what parameters are taken as given by the decision makers - consumers and producers.

7/ See, for example, Debreu [5]. Our notation is for Debreu's definition.

8/ See, for example, Debreu [5] Theorems 6.3 and 6.4.

9/ See Section I, Introduction.

10/ The proof that a competitive allocation in a private goods only world is Pareto-optimal can be mimicked. By the form of the budgets, the rules (b) and (c'), and local non-satiation, a Pareto-superior allocation will have the property that:

$$p \sum_i x^i + qy > p \sum_i \omega^i + \sum_j qz^j$$

which is impossible since $(\sum_i (x^i - \omega^i), y) - \sum_j z^j = 0$.

11/ "Truth is defined in the next paragraph.

12/ An alternative, but equivalent, interpretation is that $m_k^i(y)$ is the "maximum price" i is willing to pay for an additional unit of k , given the public goods levels y . Thus, $m_k^i(y)$ is simply the inverse (partial equilibrium) demand function of i for commodity k .

13/ An alternative definition results from letting $x^i(t^i, y)$ solve $\text{Max}_{x^i} u^i(x^i, y)$ subject to $px^i \leq -t^i y + w^i$. Then $\bar{m}^i(\cdot)$ is "true" if, for all $\bar{y} \in \mathbb{R}_+^K$, $MRS_{\ell k}^i(x^i(\bar{m}^i(\bar{y}), \bar{y}), \bar{y}) = \bar{m}_k^i(\bar{y})/P_k$ for all ℓ, k .

14/ See Foley [9]

15/ See Foley [9], Theorem , section 6.

16/ See the discussion above under Example 2.3 relating the Lindahl government rules to an iterative procedure.

17/ Compare, for example, with Dreze-Vallee Poussin [7 , p. 139].

18/ One should notice that this rule for $y(\cdot)$ is essentially the same as that for $y(\cdot)$ under the Lindahl Government. In particular, if $m^i \in M$ (for DVM) is concave and has continuous first derivatives the vector-valued function $\tau^i = (\partial m^i / \partial y_1, \dots, \partial m^i / \partial y_k)$. Then $\tau^i \in M$ (for the Lindahl Government) and the allocation selected will be identical.

19/ More general forms for the aggregate production set could be accommodated by revising the taxing rules. In particular, all profits would be taxed and then redistributed to consumers. While this is easy to specify, it would obscure the comparison between the Dreze-Vallee Poussin and Malinvaud rules and the DVM government defined above.

20/ It is clearly possible to find some utility functions u^i and initial endowments ω^i such that $x^{i*} > 0$ and $y(m^*, s^*) > 0$.

21/ In Ledyard and Roberts [16], further analysis of the DVM procedure is carried out. In particular, its relationship to the results of Hurwicz is explored.

III. THE EXISTENCE OF AN EQUILIBRIUM FOR A CLASS OF GOVERNMENTS

In this section we establish conditions on economic environments and government rules such that a competitive equilibrium relative to those governments will exist in such an environment. Although our major purpose in proving the existence theorem is to establish the existence of an equilibrium relative to the government rules we propose for solving the Free Rider Problem, we have attempted to establish minimal conditions under which existence can be proved in order to include as wide a class of governments as possible. ^{1/}

III.1. Quasi-equilibrium and the Minimum Wealth Condition

In attempting to prove the existence of a competitive equilibrium for our model of a private ownership economy with public goods relative to any particular government a basic difficulty arises that also arises in the standard Arrow-Debreu model. As Debreu [6 , p. 257] has stated, "the basic mathematical difficulty (is) that the (decision) correspondence of a consumer may not be upper semi-continuous when his wealth equals the minimum compatible with his consumption set." Although this situation can be avoided by making suitable assumptions on the economy and government rules (see Section III.4), we have adopted Debreu's approach of [6] and altered the decision correspondences whenever the minimum wealth situation arises. We then prove the existence of a quasi-equilibrium and note that if no consumer is in the minimum wealth condition, the quasi-equilibrium will be a competitive equilibrium.

Definition 3.1: Given an economy \mathcal{E} and a government $G = \{M, y(\cdot), \langle C^i(\cdot) \rangle_i, \langle R^j(\cdot) \rangle_j\}$, a consumer i is said to be in the minimum wealth condition

(m.w.c.) at the joint-message price pair (m', s') if

$$\begin{aligned} \text{Min}_{\substack{x^i \in X^i \\ m^i \in M}} [p' \cdot x^i + C^i(m'/m^i, s')] &= w^i(m', s'). \end{aligned}$$

Definition 3.2: The quasi-decision correspondence of consumer i ,

$\xi^i: M^I \times \mathbb{R}^{L+K} \rightarrow \mathbb{R}^L \times M$ is defined by:

$$\xi^i(m, s) = \begin{cases} \delta^i(m, s) & \text{if the consumer is not in the minimum wealth} \\ & \text{condition at } (m, s) \\ \beta^i(m, s) & \text{otherwise} \end{cases}$$

Definition 3.3: A quasi-competitive equilibrium (quasi-equilibrium) relative

to the government $G = \{M, y(\cdot), \langle C^i(\cdot) \rangle_i, \langle R^j(\cdot) \rangle_j\}$ in the economy \mathcal{E} is an

$(I + J + 1)$ - tuple $(\langle x^i, m^i \rangle_i, \langle z^j \rangle_j, s)$ such that:

- a) $(x^i, m^i) \in \xi^i(m, s)$, $i = 1, \dots, I$,
- b) $z^j \in \varphi^j(m, s)$, $j = 1, \dots, J$,
- c) $(\sum_i (x^i - \omega^i), y(m, s)) = \sum_j z^j$, and
- d) $s \geq 0$.

III.2: The Basic Assumptions

The following assumptions are made to establish the existence of a quasi-equilibrium. Assumptions (a), (b.1) - (b.4), (c), and (d.1) - (d.4) are conditions on the economy that will be assumed to be satisfied for all discussions concerning the existence of a (quasi-) equilibrium. Assumptions (e), (f.1) - (f.5), (g.1) - (g.4), (h.1) - (h.3), and (i) are restrictions on the governments for

which we establish the existence of a quasi-equilibrium.

Assumptions on Consumers: For every consumer i ,

- (a) $\mathcal{X}^i \equiv X^i \times Y \equiv \mathbb{R}_+^L \times \mathbb{R}_+^K$
- (b.1) for every $(x^i, y) \in \mathcal{X}^i$, there exists some $(\bar{x}^i, \bar{y}) \in \mathcal{X}^i$ such that $(\bar{x}^i, \bar{y}) >_i (x^i, y)$ (Non-satiation)
- (b.2) for every $(x^i, y) \in \mathcal{X}^i$, $\{(\bar{x}^i, \bar{y}) \in \mathcal{X}^i \mid (\bar{x}^i, \bar{y}) \succeq_i (x^i, y)\}$ and $\{(\bar{x}^i, \bar{y}) \in \mathcal{X}^i \mid (x^i, y) \succeq_i (\bar{x}^i, \bar{y})\}$ are closed sets (continuity of preferences)
- (b.3) if $(x^i, y) >_i (\bar{x}^i, \bar{y})$, then for every $\lambda \in (0, 1)$, $(\lambda x^i + (1-\lambda)\bar{x}^i, \lambda y + (1-\lambda)\bar{y}) >_i (\bar{x}^i, \bar{y})$ (convexity of preferences)
- (b.4) for every $x^i \in \mathbb{R}_+^L$, $y, \bar{y} \in \mathbb{R}_+^K$ such that $y \geq \bar{y}$, $(x^i, y) \succeq_i (x^i, \bar{y})$ (monotonicity of preferences in public goods)
- (c) $\omega^i \in \mathbb{R}_+^L$.

Each of these assumptions (with the exception of (b.4) are standard ^{2/} and need no discussion. Assumption (b.4), monotonicity of preferences in public goods, could be relaxed under some additional restrictions on $y(\cdot)$ such as linearity. (See lemmas 3.17 and 3.30 for the only uses of (b.4)).

Assumptions on Producers: For every producer j ,

- (d.1) $0 \in Z^j$ (Possibility of inaction)
- (d.2) Z^j is closed and convex.

Defining the aggregate production set Z by $Z \equiv \bigcup_j Z^j$.

- (d.3) $Z \cap (-Z) = \{0\}$ (Irreversibility of production),
- (d.4) $(-\Omega) \subseteq Z$ (Free disposal) where $-\Omega = \mathbb{R}_+^{L+K}$, the non-positive orthant of \mathbb{R}^{L+K} .

Again, these assumptions are standard ^{3/} and need no comment.

The next list of assumptions concerning government rules are not standard and are, therefore, discussed briefly after the formal statement. It should be noted that three of the assumptions [(g.3), (h.3), and (i)] involve an interrelationship between the government rules and the economy. In particular, (g.3) depends on the initial endowments, while (h.3) and (i) depend on the production technology through the maximum profit level for that economy. It is necessary to invoke such assumptions to avoid consumer and/or producer bankruptcy and to insure that, in "equilibrium", government budgets are balanced.

Assumptions on the Government: For all economies satisfying (a) - (d), the government $G = \{M, y(\cdot), \langle C^i(\cdot) \rangle_i, \langle R^j(\cdot) \rangle_j\}$ satisfies

- (e) The message space M is a convex, compact subset of a locally convex topological vector space. ^{4/}
- (f.1) The allocation rule $y(\cdot)$ is a continuous function on $M^I \times \mathbb{R}_+^{L+K}$ and homogeneous of degree zero in $s \in \mathbb{R}_+^{L+K}$.
- (f.2) for all i and for all $(m)^i(s) \in M^{I-1} \times \mathbb{R}_+^{L+K}$, y is concave in m^i on the subset $\bar{M}^i(m)^i(s) \equiv \text{closure} \{m^i \in M \mid y(m/m^i, s) > 0\}$,
- (f.3) for all i and for all $(m)^i(s) \in M^{I-1} \times \mathbb{R}_+^{L+K}$, $\bar{M}^i(m)^i(s) \neq \emptyset$,
- (f.4) $y(m, s) \geq 0$ for all $(m, s) \in M^I \times \mathbb{R}_+^{L+K}$,
- (f.5) $y(m/M, s) \equiv \{y \in \mathbb{R}_+^K \mid y = y(m/m^i, s) \text{ for some } m^i \in M\}$ is a convex set for all i and for all $(m)^i(s) \in M^{I-1} \times \mathbb{R}_+^{L+K}$.

For every consumer i ,

- (g.1) the consumer tax rule $C^i(\cdot)$ is a continuous function on $M^I \times \mathbb{R}_+^{L+K}$ and homogenous of degree one in $s \in \mathbb{R}_+^{L+K}$

(g.2) for all $(m^i, s) \in M^{I-1} \times \mathbb{R}_+^{L+K}$, $C^i(\cdot)$ is convex in m^i

on M

(g.3) $\min_{m^i \in M} C^i(m/m^i, s) \leq p \omega^i$ for all $(m^i, s) \in M^{I-1} \times \mathbb{R}_+^{L+K}$,

(g.4) if $y(m/m^i, s) = y(m/\bar{m}^i, s) > 0$, then $C^i(m/m^i, s) = C^i(m/\bar{m}^i, s)$.

For every producer j ,

(h.1) the producer tax rule $R^j(\cdot) = (R_1^j(\cdot), R_2^j(\cdot))$ is continuous on $M^I \times \mathbb{R}_+^{L+K}$; $R_1^j(\cdot)$ is homogeneous of degree zero and $R_2^j(\cdot)$ is homogeneous of degree one in $s \in \mathbb{R}_+^{L+K}$,

(h.2) $0 \leq R_1^j(m, s) < 1$ for all $(m, s) \in M^I \times \mathbb{R}_+^{L+K}$,

(h.3) $R_2^j(m, s) \leq [1 - R_1^j(m, s)] s \cdot \hat{z}^j(s)$ for all $(m, s) \in M^I \times \mathbb{R}_+^{L+K}$
 where $\hat{z}^j(s) \in \{z^j \in Z^j \mid s z^j \geq s \bar{z}^j \text{ for all } \bar{z}^j \in Z^j\}$.

(i) for every $(m, s) \in M^I \times \mathbb{R}_+^{L+K}$, if $C^i(m, s) \leq p \cdot \omega^i + \pi^i(m, s)$ for all i then $\sum_i C^i(m, s) + \sum_j (R_1^j(m, s) s \hat{z}^j(s) + R_2^j(m, s)) = q y(m, s)$. (Balanced budget condition).

Assumptions (e), (f.1), (g.1), and (h.1) require no discussion beyond recalling that the homogeneity properties permit us to restrict our attention to the unit simplex S in the price space \mathbb{R}_+^{L+K} where $S \equiv \{s \in \mathbb{R}_+^{L+K} \mid \sum_\ell p_\ell + \sum_k q_k = 1\}$ (see Section II, Remark 2.2).

Assumptions (f.2), (f.3), and (f.5) when combined with assumption (b.4) will ensure that a consumer's upper contour sets in the decision space, $\{(x^i, m^i) \in X^i \times M \mid (x^i, y(m/m^i, s)) \succeq_i (\bar{x}^i, y(m/\bar{m}^i, s))\}$, are convex $\frac{5}{/}$ over an appropriate region. Convexity of the upper contour sets along with (g.4) and convexity of the budget set will ensure that the decision correspondence $\xi^i(\cdot)$ are convex-valued (see Corollary 3.17.1 below) and that the

compactification of the economy we use does not create any artificial equilibria (see Lemma 3.30 below). Assumption (f.4) is merely a consistency requirement that ensures public goods allocations are in consumers' consumption sets.

Assumption (g.2) is the most natural assumption to make to ensure that a consumer's budget correspondence β^i is convex valued. Assumption (g.3) in part ensures that the consumer's tax rule will not bankrupt (i.e. lead to an empty budget set) the consumer. ^{6,7/} Assumption (g.4) is used to establish the convexity of the decision correspondences, as indicated above. A particular case of interest in which it is automatically satisfied is when the consumer's tax depends on the message m^i only through the allocation y ; i.e. when $C^i(m,s) \equiv \hat{C}^i(m)^i(y(m,s),s)$ for all (m,s) for some function \hat{C}^i .

Assumption (h.2) is required to ensure that the producer tax rules do not distort producers' decisions. Under tax rules satisfying (h.2), maximizing pre-tax profits is equivalent to maximizing after-tax profits. Assumption (h.3), when combined with (d.1), ensures that maximum after-tax profits are non-negative and thus avoids difficulties of exit (since $0 \in Z^j$) and limited liability. This fact, coupled with assumption (c) and (g.3) ensure that a consumer's budget set $\beta^i(m,s)$ is never empty or that a consumer can always make some decision consistent with his budget constraint and his consumption set.

Assumption (i) guarantees that when consumers satisfy their budget constraint, the government's budget is balanced. This property is needed to ensure that Walras' Law holds at a certain type of fixed point which then enables us to show the fixed point is a quasi-equilibrium.

In summary, assumptions (a), (c), and (d.1) - (d.4) ensure that the set of attainable states of the economy is compact, convex and non-empty. Assumptions (a), (c), (d.1), (f.4), (g.3), (h.2), and (h.3) ensure that consumers are not bankrupted. Assumptions (a), (b.2), (b.4), (d.2), (f.1), (g.1), and (h.1) ensure that the decision correspondences possess the appropriate continuity properties, and assumptions (a), (b.3), (d.2), (f.2), (f.3), (f.5), (g.2), and (g.4) ensure that they are convex valued. These properties, together with assumption (e) imply the existence of an appropriate fixed point and assumptions (b.1) and (i) enable us to demonstrate that the fixed point is a quasi-equilibrium.

III.3 The Existence of a Quasi-Equilibrium

We now prove

THEOREM 1: Under the assumptions of Section III.2, the private ownership economy $\mathcal{E} = \{ \langle \omega^i, \tilde{z}_i, \omega^i \rangle, \langle Z^j \rangle, \langle \theta^{ij} \rangle_{ij} \}$ has a quasi-equilibrium relative to the government $G = \{ M, y(\cdot), \langle C^i(\cdot) \rangle_i, \langle R^j(\cdot) \rangle_j \}$.

Proof: In order to show the use of the various assumptions, the proof is presented in a series of definitions and lemmata. The proof's structure is similar to that of Theorem (1) of Section 5.7 in Debreu's Theory of Value [5, as summarized on page 84]. The economy is first compactified. Then the compactified decision correspondences are shown to be non-empty, upper-hemi continuous, and convex-valued correspondences. These correspondences are then used to define a correspondence from $E \times M^I \times S$ (where E is the space of excess demands) into itself. A fixed point of this correspondence then exists by the Tychanoff-Kakutani-Ky Fan Theorem and the remainder of the

proof converts the fixed point into a quasi-equilibrium.

3.1 The Compactified Economy \widehat{E}

Definition 3.4: The set of attainable states, A , is defined by:

$$A \equiv \{(\langle x^i \rangle_i, y, \langle z^j \rangle_j) \mid (x^i, y) \in \mathcal{X}^i, \text{ for all } i, z^j \in Z^j \text{ for all } j, \\ \text{and } (\sum_i (x^i - w^i), y) - \sum_j z^j = 0\}$$

Lemma 3.1: A is non-empty and bounded.

Proof: By assumptions (a), (c), and (d.1), $(\langle w^i \rangle_i, 0, \langle 0 \rangle_j) \in A$, and thus A is non-empty. To show A is bounded, note that by (a),

$$A = [\mathbb{R}_+^{I \cdot L} \times \mathbb{R}_+^K \times Z^1 \times \dots \times Z^K] \cap \{(\langle x^i \rangle_i, y, \langle z^j \rangle_j) \mid (\sum_i (x^i - w^i), y) = \sum_j z^j\}$$

where the latter set is a linear manifold. Let $\tilde{X}^i = \mathbb{R}_+^L \times \{0\}$ for all i and $\tilde{X}^{I+1} = \{0\} \times \mathbb{R}_+^K$. Then let

$$\tilde{A} = (\prod_{i=1}^{I+1} \tilde{X}^i) \cap \{(\langle \tilde{x}^i \rangle_i, \langle \tilde{z}^j \rangle_j) \mid \sum_{i=1}^{I+1} (\tilde{x}^i - (w^i, 0)) - \sum_j \tilde{z}^j = 0\}$$

Given assumptions (d.2), (d.3), and (d.4), \tilde{A} is bounded as a direct application of proposition (2) of Section 5.4 of [5 p.77]. Since $(\langle \tilde{x}^i \rangle_i, \langle \tilde{z}^j \rangle_j) \in \tilde{A}$ if and only if $\tilde{x}^i = (x^i, 0)$, for $i = 1, \dots, I$, $\tilde{x}^{I+1} = (0, y)$ and $(\langle x^i \rangle_i, y, \langle \tilde{z}^j \rangle_j) \in A$, it follows that A is also bounded.

Definition 3.5: The sets $\hat{X}^i, \hat{Y}, \hat{Z}^j$ for all i and j are the projections of A on the spaces \mathbb{R}^L containing X^i , \mathbb{R}^K containing Y , and \mathbb{R}^{L+K}

containing Z^j respectively.

Lemma 3.2: Each set \hat{X}^i, \hat{Y} , and \hat{Z}^j is bounded.

Proof: Trivial application of lemma 3.1.

Definition 3.6: $\tilde{Y} = y(M^I, S)$

Lemma 3.3: \tilde{Y} is bounded.

Proof: $M^I \times S$ is a compact set by (e) and the definition of S as a simplex. $y(\cdot)$ is continuous by (f.1). \tilde{Y} is therefore compact and hence bounded.

Definition 3.4: Let K be a closed cube in \mathbb{R}^{L+K} with center zero containing in its interior the 2^{I+J} sets $\hat{X}^i \times \hat{Y}, \hat{X}^i \times \tilde{Y}, \hat{Z}^j$. (Such a cube exists by lemmata 3.2 and 3.3). Define $\mathcal{X}^i \equiv \mathcal{X}^i \cap K, \mathcal{Z}^j \equiv Z^j \cap K, \hat{X}^i \equiv \mathbb{R}_+^L \cap K^L$ and $\hat{Y} = \mathbb{R}_+^K \cap K^K$ where K^L and K^K are the projections of K on \mathbb{R}^L and \mathbb{R}^K respectively. Note that, by (a), $\mathcal{X}^i = \hat{X}^i \times \hat{Y}$.

Lemma 3.4: (i) For each i, \mathcal{X}^i is compact, convex, and contains $(\omega^i, 0)$,
(ii) for each i, \hat{X}^i is compact, convex, and contains ω^i ,
(iii) for each j, \mathcal{Z}^j is compact, convex, and contains 0 ,
(iv) \hat{Y} is compact, convex and $y(M^I, S) \subseteq \hat{Y}$.

Proof: (i) and (ii) follow directly from (a) and (c). (iii) follows from (d.1) and (d.2). (iv) follows from (a) and the construction of K .

Definition 3.8: The compactified economy $\hat{\mathcal{E}}$ is defined by:

$\hat{\mathcal{E}} \equiv \{ \langle \hat{Z}^i, \hat{\omega}^i \rangle_i, \langle \hat{Z}^j \rangle_j, \langle \hat{\theta}^{ij} \rangle_{ij} \}$. The mapping $\hat{\varphi}^j$, for example, in $\hat{\mathcal{E}}$ is defined in the same manner as φ^j in \mathcal{E} is defined and similarly for all mappings^{8/} for $\hat{\mathcal{E}}$.

3.2 Properties of $\hat{\varphi}^j$ and $\hat{\pi}^j$

Lemma 3.5: The compactified supply correspondence, $\hat{\varphi}^j: M^I \times S \rightarrow \mathbb{R}^{L+K}$, is non-empty, convex-valued, and upper hemi-continuous (u.h.c.) on $M^I \times S$.

Proof: $\hat{\varphi}^j(m, s)$ is non-empty by a simple application of the Weierstrass theorem since, by (h.2), $\hat{\varphi}^j(m, s) = \{ z^j \in \hat{Z}^j \mid sz^j \geq s\bar{z}^j \text{ for all } \bar{z}^j \in \hat{Z}^j \}$. Convexity follows from the convexity of \hat{Z}^j established in lemma 3.4 (iii). Since \hat{Z}^j is also compact, $\hat{\varphi}^j$ is u.h.c. by proposition (3) of section 3.5 in [5, p. 48].

Lemma 3.6: The compactified after-tax profit function, $\hat{\pi}^j: M^I \times S \rightarrow \mathbb{R}$, is non-negative and continuous on $M^I \times S$.

Proof: $\hat{\pi}^j(m, s) \geq 0$ by assumption (h.3), since $0 \in \hat{Z}^j$. By the characterization of $\hat{\varphi}^j(m, s)$ in the proof of lemma 3.5 and assumption (h.1), $\hat{\pi}^j$ is continuous by proposition (3) of Section 3.5 in [5, p. 48].

3. Properties of $\widehat{\beta}^i$

Lemma 3.7: The compactified budget correspondence $\widehat{\beta}^i$ is non-empty for all $(m, s) \in M^I \times S$.

Proof: Since $0 \in K$ by construction and $0 \in \widehat{X}^i$ by (a), $0 \in \widehat{X}^i$. By (g.3), $C^i(m/\overline{m}^i, s) \leq p\omega^i$ where $\overline{m}^i \in \{\widehat{m}^i \in M \mid C^i(m/\widehat{m}^i, s) \leq C^i(m/m^i, s) \text{ for all } m^i \in M\}$ which is non-empty since M is compact by (e) and $C^i(\cdot)$ is continuous by (g.1). By lemma 3.6, $\widehat{\pi}^j(m, s) \geq 0$. Thus, $p \cdot 0 + C^i(m/\overline{m}^i, s) \leq \widehat{w}^i(m, s)$ and hence $(0, \overline{m}^i) \in \widehat{\beta}^i(m, s)$.

Lemma 3.8: $\widehat{\beta}^i$ is compact valued for all $(m, s) \in M^I \times S$.

Proof: Since $\widehat{\beta}^i(m, s) \subseteq \widehat{X}^i \times M$ which is compact by lemma 3.4(ii) and (e), it is only necessary to show that $\widehat{\beta}^i(m, s)$ is closed. This follows trivially from the continuity of $px^i + C^i(m/m^i, s)$ on $\widehat{X}^i \times M$ assumed in (g.1).

Lemma 3.9: $\widehat{\beta}^i$ is convex valued for all $(m, s) \in M^I \times S$.

Proof: Let (x^i, m^i) and $(\overline{x}^i, \overline{m}^i)$ belong to $\widehat{\beta}^i(m, s)$. Since $\widehat{X}^i \times M$ is convex (lemma 3.4 (ii) and (e)), $\lambda(x^i, m^i) + (1 - \lambda)(\overline{x}^i, \overline{m}^i) \in \widehat{X}^i \times M$ for all $\lambda \in [0, 1]$. By (g.2),

$$p(\lambda x^i + (1-\lambda)\overline{x}^i) + C^i(m/\lambda m^i + (1-\lambda)\overline{m}^i, s) \leq \lambda(px^i + C^i(m/m^i, s)) + (1-\lambda)(p\overline{x}^i + C^i(m/\overline{m}^i, s))$$

for all $\lambda \in [0, 1]$. Thus $\lambda(x^i, m^i) + (1-\lambda)(\overline{x}^i, \overline{m}^i) \in \widehat{\beta}^i(m, s)$ for all $\lambda \in [0, 1]$.

Lemma 3.10: $\widehat{\beta}^i$ is upper hemi-continuous on $M^I \times S$.

Proof: Since $\widehat{X}^i \times M$ is compact, it suffices to show the graph of $\widehat{\beta}^i$ is closed. This follows directly from (g.1) since $\widehat{w}^i(m,s)$ is continuous on $M^I \times S$ from lemma 3.6.

Lemma 3.11: $\widehat{\beta}^i$ is lower hemi-continuous (l.h.c) on the set $B^i \subseteq M^I \times S$

where $B^i = \{(m,s) \in M^I \times S \mid \text{Min}_{(x^{i'}, m^{i'}) \in \widehat{X}^i \times M} px^{i'} + C^i(m/m^{i'}, s) < \widehat{w}^i(m,s)\}$.

(B^i is the set of joint message/price pairs that do not place i in the minimum wealth condition - see Definition 3.1).

Proof: Let $(m,s) \in B^i$. We must show that if $\mathcal{O} \subset \widehat{X}^i \times M$ is an open set such that $\mathcal{O} \cap \widehat{\beta}^i(m,s) \neq \emptyset$, then there exists an open neighborhood N of (m,s) such that, for all $(m',s') \in N$, $\widehat{\beta}^i(m',s') \cap \mathcal{O} \neq \emptyset$.

If for some $(\bar{x}^i, \bar{m}^i) \in \mathcal{O} \cap \widehat{\beta}^i(m,s)$, $p\bar{x}^i + C^i(m/\bar{m}^i, s) < \widehat{w}^i(m,s)$, then the requisite neighborhood of (m,s) exists since $C^i(\cdot)$ and $\widehat{w}^i(\cdot)$ are continuous.

Since $(m,s) \in B^i$ (i.e. i is not in the minimum wealth condition), there exists some $(\hat{x}^i, \hat{m}^i) \in \widehat{X}^i \times M$ such that $p\hat{x}^i + C^i(m/\hat{m}^i, s) < \widehat{w}^i(m,s)$. Since $\mathcal{O} \cap \widehat{\beta}^i(m,s) \neq \emptyset$, there is some $(x^{i'}, m^{i'}) \in \mathcal{O} \cap \widehat{\beta}^i(m,s)$ and $px^{i'} + C^i(m/m^{i'}, s) \leq \widehat{w}^i(m,s)$. By convexity of $(\widehat{X}^i \times M)$, $(x^i(\lambda), m^i(\lambda)) \equiv$

$\lambda(x^{i'}, m^{i'}) + (1-\lambda)(\hat{x}^i, \hat{m}^i) \in \widehat{X}^i \times M$ for all $\lambda \in [0,1]$. By convexity of $C^i(m/m^i, s)$ (assumption (g.2)), $px^i(\lambda) + C^i(m/m^i(\lambda), s) < \widehat{w}^i(m,s)$ for all $0 \leq \lambda < 1$. But for λ sufficiently close to 1, $(\bar{x}^i, \bar{m}^i) = (x^i(\lambda), m^i(\lambda)) \in \mathcal{O} \cap \widehat{\beta}^i(m,s)$.

Lemma 3.12: $\hat{\beta}^i$ is continuous on B^i .

Proof: Immediate from lemmata 3.10, and 3.11.

3.4 Properties of $\hat{\xi}^i$

Lemma 3.13: The compactified quasi-decision correspondence $\hat{\xi}^i$ is non-empty for all $(m,s) \in M^I \times S$.

Proof: If $(m,s) \notin B^i$, then $\hat{\xi}^i(m,s) = \hat{\beta}^i(m,s)$ which is non-empty by lemma 3.7. If $(m,s) \in B^i$, we apply the Weierstrass Theorem. Assumptions (a) and (b.2) imply the existence of a continuous utility function $u^i: X^i \rightarrow \mathbb{R}$ representing \succsim_i . Let $v^i: X^i \times M^I \times S \rightarrow \mathbb{R}$ be defined by $v^i(x^i, m, s) = u^i(x^i, y(m, s))$. v^i is a continuous function by (f.1) and in particular, given $(m,s) \in B^i$, v^i is continuous on $\hat{X}^i \times M$. By lemmas 3.7 and 3.8, $\hat{\beta}^i(m,s)$ is non-empty and compact. The Weierstrass Theorem now applies.

Lemma 3.14: $\hat{\xi}^i$ is upper hemi-continuous on $M^I \times S$.

Proof: If $(m,s) \notin B^i$, then $\hat{\xi}^i(m,s) = \hat{\beta}^i(m,s)$ and is u.h.c. at (m,s) since $\hat{\beta}^i$ is by lemma 3.10. If $(m,s) \in B^i$, then since $\hat{\beta}^i$ is continuous at (m,s) (lemma 3.12), since v^i is continuous (proof of lemma 3.13), and since $\hat{X}^i \times M$ is compact, the maximum theorem (4) of Section 1.9 in [5, p.19] establishes the u.h.c. of $\hat{\xi}^i$ at (m,s) .

Remark 3.1: Unfortunately, under the assumptions of Section III.2, $\hat{\xi}^i$ is not necessarily convex valued since the upper contour set $\{(x^i, m^i) \in \hat{X}^i \times M \mid (x^i, y(m/m^i, s)) \succeq_{\sim_i} (\bar{x}^i, y(m/\bar{m}^i, s))\}$ in the decision space may not be convex when $y(m/\bar{m}^i, s)$ has at least one zero component. ^{9/} For example, if $K = 1$, and $L = 1$, $y(m, s) = \text{Max} \{\sum_i m^i, 0\}$ where M is a compact subset of \mathbb{R} , and \sim_i are representable by the utility function $u^i(x^i, y) = x^i + y$, then preferences in the decision space are representable by the utility function $v^i(x^i, m) \equiv u^i(x^i, y(m, s)) = x^i + \max \{\sum_i m^i, 0\}$. The indifference curves for $v^i(x^i, m/m^i)$, if $\sum_{n \neq i} m^h \equiv b < 0$ are drawn in figure 1:

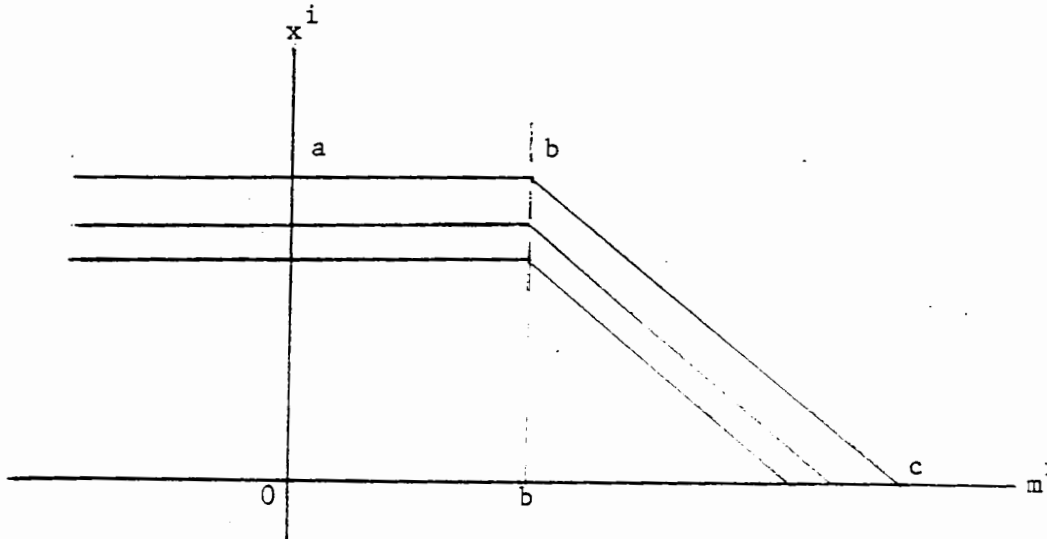

Figure 3.1

The upper contour sets are obviously not convex. Thus, it is possible for the entire segment $a b c$ to be the decision set $\hat{\xi}^i(m, s)$.

A method of circumventing this difficulty is to restrict the decisions to a convex subset of $\hat{\xi}^i(m, s)$; that is, to define a restricted decision correspondence that has the desired properties ^{10/} and such that at a fixed point, the decisions (x^i, m^i) are in the unrestricted decision set. This is done in the next subsection.

3.5 Definition and Properties of ξ^{i*}

Definition 3.9: For every $(m,s) \in M^I \times S$ and real number $\epsilon > 0$ define:

a) $M^i(m)^{i}(\cdot, s; \epsilon) \equiv \{m^i \in M \mid y(m/m^i, s) \geq \epsilon u\}$ where u is the unit vector in \mathbb{R}^K ,

b) $\bar{\beta}^i(m, s; \epsilon) \equiv \hat{\beta}^i(m, s) \cap \hat{X}^i \times M^i(m)^{i}(\cdot, s; \epsilon)$

c) $\xi^i(m, s; \epsilon) \equiv \left\{ \begin{array}{l} \{(x^{i'}, m^{i'}) \in \bar{\beta}^i(m)^{i}(\cdot, s; \epsilon) \mid (x^{i'}, y(m/m^{i'}, s)) \succ_i (\bar{x}^i, y(m/\bar{m}^i, s)) \\ \text{for all } (\bar{x}^i, \bar{m}^i) \in \bar{\beta}^i(m, s; \epsilon)\} \text{ if } i \text{ is not} \\ \text{in the minimum wealth condition at } (m, s) \\ \hat{\beta}^i(m, s) \text{ if } i \text{ is in the m.w.c. at } (m, s). \end{array} \right.$

d) $\xi^{i*}(m, s) \equiv \{(x^{i'}, m^{i'}) \in \hat{X}^i \times M^i \mid \text{there exists a sequence } \{(x_e^i, m_e^i)\}_\epsilon \text{ converging to } (x^{i'}, m^{i'}) \text{ as } \epsilon \text{ goes to } 0 \text{ with } (x_e^i, m_e^i) \in \xi^i(m, s, \epsilon) \text{ for all } \epsilon < \text{some positive } \epsilon^*\}$

Note that if i is in the minimum wealth condition at (m, s) , then

$\xi^{i*}(m, s) = \hat{\beta}^i(m, s)$. Also, note that the set $\bar{M}^i(m)^{i}(\cdot, s) \equiv \text{closure } \{m^i \in M \mid y(m, s) > 0\}$

(see assumption (f.2)) may alternatively be defined by:

$$\bar{M}^i(m)^{i}(\cdot, s) = \text{closure } \bigcup_{\epsilon > 0} M^i(m)^{i}(\cdot, s; \epsilon),$$

and that the relations $M^i(m)^{i}(\cdot, s; \epsilon) \subset \bar{M}^i(m)^{i}(\cdot, s) \subset M^i(m)^{i}(\cdot, s; 0) = M$

hold for all $\epsilon > 0$ (the equality holds by (f.4)).

Lemma 3.15: For every $(m, s) \in M^I \times S$,

$$\bar{M}^i(m)^{i}(\cdot, s) \cap \{m^{i'} \in M \mid y(m/m^{i'}, s) = y(m, s)\} \neq \emptyset.$$

Proof: If $y(m/m^i, s) > 0$, then $m^i \in \bar{M}^i$ and the lemma holds trivially. Suppose $m^i \notin \bar{M}^i$. Let \hat{m}^i be such that $y(m/\hat{m}^i, s) > 0$. Such an \hat{m}^i exists by (f.3). Let $y(\lambda) \equiv \lambda y(m, s) + (1-\lambda)y(m/\hat{m}^i, s)$ for all $\lambda \in [0, 1]$ and consider the correspondence $h: [0, 1] \rightarrow M$ defined by: $h(\lambda) \equiv \{m^{i'} \in M \mid y(m/m^{i'}, s) = y(\lambda)\}$. By assumption (f.5), $h(\lambda) \neq \emptyset$ for all $\lambda \in [0, 1]$. Also, since $y(\cdot)$ is continuous in m^i by (f.1), $h(\cdot)$ is an u.h.c. correspondence on $[0, 1]$ (as $\{(\lambda, m^{i'}) \in [0, 1] \times M \mid y(m/m^{i'}, s) = y(\lambda)\}$ is a closed set and $[0, 1] \times M$ is compact).

Consider an arbitrary sequence $\{\lambda_\tau\} \rightarrow 1$ with $\lambda_\tau < 1$ for all τ (e.g. $\lambda_\tau = 1 - \frac{1}{\tau}$, $\tau > 1$, $\tau \rightarrow \infty$) and a sequence $\{m_\tau^i\}$ such that $m_\tau^i \in h(\lambda_\tau)$ for all τ . $\{m_\tau^i\}$ is contained in the compact set M and thus contains a convergent subsequence. Let m_0^i be the limit point of that subsequence. Since h is u.h.c., $m_0^i \in h(1)$; i.e. $y(m/m_0^i, s) = y(m, s)$. Also, since $m_\tau^i \in \bar{M}^i$ for all τ (since $y(\lambda_\tau) > 0$ for all $\lambda_\tau < 1$), and \bar{M}^i is closed, $m_0^i \in \bar{M}^i(m^i(s))$.

Lemma 3.16: For every $(m, s) \in M^I \times S$, there exists some $\varepsilon^* = \varepsilon^*(m, s) > 0$ such that $\bar{\xi}^i(m, s; \varepsilon) \neq \emptyset$ for all $\varepsilon \leq \varepsilon^*$.

Proof: If i is in the m.w.c. at (m, s) , then $\bar{\xi}^i(m, s; \varepsilon) = \hat{\beta}^i(m, s) \neq \emptyset$ for all ε by lemma 3.7.

If i is not in the m.w.c. at (m, s) , then the lemma follows by the same argument used in the proof of lemma 3.13 if $\bar{\beta}^i(m, s; \varepsilon)$ is compact and non-empty for all $\varepsilon \leq$ some $\varepsilon^*(m, s) > 0$.

Since $\hat{\beta}^i$ is compact valued (lemma 3.3) and $\hat{X}^i \times M^i(m, s; \varepsilon)$ is closed for all ε , $\bar{\beta}^i(m, s; \varepsilon)$ is compact.

Since i is not in the m.w.c. at (m,s) , there exists some $(x^{i'}, m^{i'}) \in \hat{\beta}^i(m,s)$ such that $px^{i'} + C^i(m/m^{i'}, s) < \hat{w}^i(m,s)$. By lemma 3.15, there exists some $\hat{m}^i \in \bar{M}^i(m)^{i'}(s)$ such that $y(m/\hat{m}^i, s) = y(m/m^{i'}, s)$ and therefore, by (g.4) $C^i(m/m^{i'}, s) = C^i(m/\hat{m}^i, s)$. By (f,3), there is some $\bar{\epsilon} > 0$ such that $M^i(m)^{i'}(s; \epsilon) \neq \emptyset$ for all $\epsilon \leq \bar{\epsilon}$. Since $M^i(m)^{i'}(s; \epsilon) \supset M^i(m)^{i'}(s; \bar{\epsilon})$ for all $\epsilon \leq \bar{\epsilon}$, let $m^{i*} \in M^i(m)^{i'}(s; \epsilon)$ for all $\epsilon \leq \bar{\epsilon}$. Define $m^i(\lambda) \equiv \lambda \hat{m}^i + (1-\lambda)m^{i*}$. Since $y(\cdot)$ is concave on \bar{M}^i by (f.2) and $y(m/m^{i*}, s) > 0$, $y(m/m^i(\lambda), s) > 0$ for all $\lambda \in [0,1)$. Since C^i is continuous in m^i by (g.1), $px^{i'} + C^i(m/m^i(\lambda), s) < \hat{w}^i(m,s)$ for some $\bar{\lambda} < 1$. But $y(m/m^i(\bar{\lambda}), s) \geq \hat{\epsilon} u$ for some $\hat{\epsilon} > 0$. Let $\epsilon^* = \text{Min}\{\bar{\epsilon}, \bar{\epsilon}\}$. Then $px^{i'} + C^i(m/m^i(\bar{\lambda}), s) < \hat{w}^i(m,s)$ and $m^i(\bar{\lambda}) \in M^i(m)^{i'}(s; \epsilon)$ for all $\epsilon \leq \epsilon^*$. Hence $(0, m^i(\bar{\lambda})) \in \bar{\beta}^i(m,s; \epsilon)$ for all $\epsilon \leq \epsilon^*$ and the lemma is proved.

Corollary 3.16.1: For every $(m,s) \in M^I \times S$, $\xi^{i*}(m,s) \neq \emptyset$.

Proof: By lemma 3.16, there exists at least one sequence $\{(x_\epsilon^i, m_\epsilon^i)\}_\epsilon$ such that $(x_\epsilon^i, m_\epsilon^i) \in \bar{\xi}^i(m,s; \epsilon)$ for all $\epsilon \leq \text{some } \epsilon^* > 0$. Since $\hat{X}^i \times M$ is compact, there exists at least one limit point of this sequence as $\epsilon \rightarrow 0$ and hence, by the definition of ξ^{i*} , the limit point is in $\xi^{i*}(m,s)$.

Lemma 3.17: For every $\epsilon > 0$, $\bar{\xi}^i(\cdot; \epsilon)$ is convex-valued on $M^I \times S$.

Proof: Since $y(\cdot)$ is concave in m^i on \bar{M}^i by (f.2) and $\bar{M}^i \supset M^i(m)^{i'}(s; \epsilon), M^i(m)^{i'}(s; \epsilon)$ is convex for all $\epsilon > 0$. Since $\bar{\beta}^i(m,s)$ is convex, by lemma 3.9, $\bar{\beta}^i(m,s; \epsilon)$ is convex for all $\epsilon > 0$. Therefore, it suffices

to show when i is not in the m.w.c. that $B \equiv \{(x^i, m^i) \in \widehat{X}^i \times M \mid$

$m^i \in M^i(m^i)^i(\cdot, s; \epsilon), (x^i, y(m/m^i, s)) \succeq_i (\bar{x}^i, y(m/\bar{m}^i, s))\}$ is a convex set when $(\bar{x}^i, \bar{m}^i) \in \bar{\xi}^i(m, s; \epsilon)$. Let (x^i, m^i) and $(\hat{x}^i, \hat{m}^i) \in B$. Define $(x^i(\lambda), m^i(\lambda)) = \lambda(x^i, m^i) + (1-\lambda)(\hat{x}^i, \hat{m}^i)$. Clearly $m^i(\lambda) \in M^i(m^i)^i(\cdot, s; \epsilon)$ (since by (f.2) $y(\cdot)$ is convex in m^i on $\bar{M}^i \supset M^i(m^i)^i(\cdot, s; \epsilon)$) for all $\lambda \in [0, 1]$. Thus, by (f.2), (b.2)-(b.4), $(x^i(\lambda), y(m/m^i(\lambda), s)) \succeq_i (x^i(\lambda), \lambda y(m/m^i, s) + (1-\lambda)y(m/\hat{m}^i, s)) \succeq_i (\hat{x}^i, y(m/\hat{m}^i, s))$. Hence, B is convex.

If i is in the m.w.c., $\bar{\xi}^i(m, s; \epsilon) = \hat{\beta}^i(m, s)$ is convex by lemma 3.9.

Corollary 3.17.1: ξ^{i*} is convex valued on $M^I \times S$.

Proof: Let $(x^{i'}, m^{i'}), (\hat{x}^i, \hat{m}^i) \in \xi^{i*}(m, s)$. Then, there exist sequences

$(x_\epsilon^{i'}, m_\epsilon^{i'}) \rightarrow (x^{i'}, m^{i'})$ and $(\hat{x}_\epsilon^i, \hat{m}_\epsilon^i) \rightarrow (\hat{x}^i, \hat{m}^i)$ such that $(x_\epsilon^{i'}, m_\epsilon^{i'}),$

$(\hat{x}_\epsilon^i, \hat{m}_\epsilon^i) \in \bar{\xi}^i(m, s; \epsilon)$ for all $\epsilon \leq \text{some } \epsilon^*(m, s) > 0$. By lemma 3.17,

$(x_\epsilon^i(\lambda), m_\epsilon^i(\lambda)) \equiv \lambda(x_\epsilon^{i'}, m_\epsilon^{i'}) + (1-\lambda)(\hat{x}_\epsilon^i, \hat{m}_\epsilon^i) \in \bar{\xi}^i(m, s; \epsilon)$ for all $\epsilon \leq \epsilon^*, \lambda \in [0, 1]$.

Also, $(x_\epsilon^i(\lambda), m_\epsilon^i(\lambda)) \rightarrow (x^i(\lambda), m^i(\lambda))$ as $\epsilon \rightarrow 0$. Thus, $(x^i(\lambda), m^i(\lambda)) \in \bar{\xi}^{i*}(m, s)$

for all $\lambda \in [0, 1]$ and ξ^{i*} is convex valued.

Lemma 3.18: For every $(m^i)^i(\cdot, s) \in M^{I-1} \times S$, $M^i(\cdot; \epsilon): M^{I-1} \times S \rightarrow M$ is a continuous correspondence at $(m^i)^i(\cdot, s)$ for all $0 < \epsilon \leq \text{some positive } \hat{\epsilon}$.

Proof: (upper hemi-continuity): Let $(m_t, s_t) \rightarrow (m, s)$ as $t \rightarrow \infty$ with

$m_t^i \in M^i(m_t^i)^i(\cdot, s_t; \epsilon)$ for every t . Then $y(m_t, s_t) \geq \epsilon u$ for all t . Since y

is continuous, $y(m, s) \geq \epsilon u$ and thus $m^i \in M^i(m^i)^i(\cdot, s; \epsilon)$ and since M and

S are compact, $M^i(\cdot; \epsilon)$ is u.h.c. at $(m^i)^i(\cdot, s)$ for all ϵ .

(lower hemi-continuity): To show: For every open set \mathcal{O} in M such that $M^i(m)^i(\cdot, s; \epsilon) \cap \mathcal{O} \neq \emptyset$, there exists an open neighborhood $V(m)^i(\cdot, s) \subset M^{I-1} \times S$ such that $(m')^i(\cdot, s') \in V(m)^i(\cdot, s)$ implies $M^i(m')^i(\cdot, s'; \epsilon) \cap \mathcal{O} \neq \emptyset$.

Let $\hat{m}^i \in M^i(m)^i(\cdot, s; \epsilon) \cap \mathcal{O}$. Then $y(m/\hat{m}^i, s) \geq \epsilon u > 0$ and if $y(m/\hat{m}^i, s) > \epsilon u$ the requisite neighborhood $V^i(m)^i(\cdot, s)$ clearly exists since y is continuous.

Suppose $y(m/\hat{m}^i, s) = \epsilon u$. By (f.3) if $\epsilon \leq$ some sufficiently small $\hat{\epsilon}$, there exists some \bar{m}^i such that $y(m/\bar{m}^i, s) > \epsilon u$. Define $m^i(\lambda) \equiv \lambda \hat{m}^i + (1-\lambda)\bar{m}^i$. Since \hat{m}^i and $\bar{m}^i \in \bar{M}^i(m)^i(\cdot, s)$ and y is concave on \bar{M}^i by (f.2), $y(m/m^i(\lambda), s) \geq \lambda y(m/\hat{m}^i, s) + (1-\lambda)y(m/\bar{m}^i, s) > \epsilon u$ for all $\lambda \in [0, 1)$ and $m^i(\lambda) \in M^i(m)^i(\cdot, s; \epsilon)$. But for λ sufficiently close to 1, $m^i(\lambda) \in \mathcal{O}$.

Corollary 3.18.1: For all $0 < \epsilon$, $\bar{\beta}^i(\cdot; \epsilon)$ is an upper hemi-continuous correspondence on $M^I \times S$.

If i is not in the minimum wealth condition at (m, s) , $\bar{\beta}^i(\cdot; \epsilon)$ is lower hemi-continuous at (m, s) for all $0 < \epsilon \leq$ some $\hat{\epsilon}(m, s) > 0$.

Proof: Since $\bar{\beta}^i(m, s; \epsilon) = \hat{\beta}^i(m, s) \cap \hat{X}^i \times M^i(m)^i(\cdot, s; \epsilon)$, $\hat{\beta}^i$ is u.h.c. (lemma 3.10) and $m^i(\cdot; \epsilon)$ is u.c.h. for all $\epsilon > 0$ (lemma 3.18), $\bar{\beta}^i(\cdot; \epsilon)$ is u.h.c. for all $\epsilon > 0$.

Let (m, s) be such that i is not in the m.w.c. We must show that if $0 \subseteq \hat{X}^i \times M$ is an open set such that $0 \cap \bar{\beta}^i(m, s; \epsilon) \neq \emptyset$, then there exists an open neighborhood N of (m, s) such that, for all $(m', s') \in N$, $\bar{\beta}^i(m', s'; \epsilon) \cap 0 \neq \emptyset$. We mimic the proofs of lemmas 3.11 and 3.18.

Since i is not in the m.w.c., there is $(\hat{x}^i, \hat{m}^i) \in \hat{X}^i \times M$ such that $p\hat{x}^i + C^i(m/\hat{m}^i, s) < \hat{w}^i(m, s)$. Since $0 \cap \bar{\beta}^i(m, s; \epsilon) \neq \emptyset$, there exists some $(x^{i'}, m^{i'}) \in 0 \cap \bar{\beta}^i(m, s; \epsilon)$ such that $p x^{i'} + C^i(m/m^{i'}, s) \leq \hat{w}^i(m, s)$ and

$y(m/m^{i'}, s) \geq \epsilon u$. By convexity of $\widehat{X}^i \times M$, $(x^i(\lambda), m^i(\lambda)) \equiv \lambda(x^{i'}, m^{i'}) + (1-\lambda)(\widehat{x}^i, \widehat{m}^i) \in \widehat{X}^i \times M$ for all $\lambda \in [0, 1]$. By convexity of $C^i(m/m^i, s)$, $p x^i(\lambda) + C^i[m/m^i(\lambda), s] < \widehat{w}^i(m, s)$ for all $0 \leq \lambda < 1$. If $y(m/m^{i'}, s) > \epsilon u$, then for λ sufficiently close to 1, by the concavity of $y(m/m^i, s)$, $y(m/m^i(\lambda), s) \geq \epsilon u$. Hence, for λ sufficiently close to 1, $(x^i(\lambda), m^i(\lambda)) \in \overline{\beta}^i(m, s; \epsilon)$.

If $y(m/m^i, s) = \epsilon u$, let $\widehat{\epsilon} = \frac{\epsilon}{2}$. Then, by the above proof, $\overline{\beta}^i(\cdot, \widehat{\epsilon})$ is l.h.c. on $M^I \times S$ if i is not in the m.w.c. and if $0 < \widehat{\epsilon} \leq \frac{\epsilon}{2} = \widehat{\epsilon}$

Lemma 3.19: $\overline{\xi}^i(\cdot; \epsilon)$ is upper hemi-continuous on $M^I \times S$ for all $0 < \epsilon \leq$
some $\widehat{\epsilon} > 0$.

Proof: If i is in the m.w.c. at (m, s) , then $\overline{\xi}^i(m, s; \epsilon) = \overline{\beta}^i(m, s)$ and is u.h.c. at (m, s) by lemma 3.10.

If i is not in the m.w.c. at (m, s) , $\overline{\beta}^i(\cdot; \epsilon)$ is continuous at (m, s) by corollary 3.18.1 and the u.h.c. of $\overline{\xi}^i(\cdot; \epsilon)$ at (m, s) follows by the same argument as used in the proof of lemma 3.14.

Corollary 3.19.1: $\overline{\xi}^{i*}$ is upper hemi-continuous on $M^I \times S$.

Proof: ^{12/} Let $\{(x_t^{i'}, m_t^{i'})\}_t$ be a sequence converging to $(x_0^{i'}, m_0^{i'})$ as $t \rightarrow \infty$, such that $(x_t^{i'}, m_t^{i'}) \in \overline{\xi}^{i*}(m_t, s_t)$ for all t where (m_t, s_t) converges to (m_0, s_0) . To show: $(x_0^{i'}, m_0^{i'}) \in \overline{\xi}^{i*}(m_0, s_0)$.

For each t , there exists a sequence $\{x_{t\epsilon}^{i'}, m_{t\epsilon}^{i'}\} \rightarrow (x_t^{i'}, m_t^{i'})$ as $\epsilon \rightarrow 0$ where $(x_{t\epsilon}^{i'}, m_{t\epsilon}^{i'}) \in \overline{\xi}^i(m_t, s_t; \epsilon)$ for all $\epsilon \leq \epsilon^*(m_t, s_t)$. But, by lemma 3.19, $\overline{\xi}^i$ is u.h.c. at (m_0, s_0) for all $0 < \epsilon \leq$ some $\widehat{\epsilon} > 0$. Thus, for each

ε , $\{(x_{t_\varepsilon}^{i'}, m_{t_\varepsilon}^{i'})\}_t$ contains a subsequence that converges to $(x_{0\varepsilon}^{i'}, m_{0\varepsilon}^{i'}) \in \bar{\xi}^i(m_0, s_0; \varepsilon)$.
 Letting $\varepsilon \rightarrow 0$, $\{(x_{0\varepsilon}^{i'}, m_{0\varepsilon}^{i'})\}_\varepsilon$ contains a subsequence converging to $(x_0^{i'}, m_0^{i'})$.
 Thus $(x_0^{i'}, m_0^{i'}) \in \bar{\xi}^{i*}(m_0, s_0)$.

Lemma 3.20: For every $(m, s) \in M^I \times S$, $\bar{\xi}^{i*}(m, s) \subseteq \hat{\xi}^i(m, s)$.

Proof: If i is in the m.w.c. at (m, s) , then $\bar{\xi}^{i*}(m, s) = \hat{\beta}^i(m, s) = \hat{\xi}^i(m, s)$.
 By assumption (f.4), $\bar{\xi}^i(m, s; 0) = \hat{\xi}^i(m, s)$. Therefore it suffices to show that $\bar{\xi}^i(m, s; \varepsilon)$ is u.h.c. in ε when i is not in the m.w.c. to establish the result.

By lemma 3.16, there is some $\varepsilon^* > 0$ such that for all $\varepsilon \leq \varepsilon^*$, $\bar{\xi}^i(m, s; \varepsilon) \neq \emptyset$. Let $\{(x_\varepsilon^{i'}, m_\varepsilon^{i'})\}_\varepsilon \rightarrow (x^{i'}, m^{i'})$ as $\varepsilon \rightarrow 0$ be a sequence such that $(x_\varepsilon^{i'}, m_\varepsilon^{i'}) \in \bar{\xi}^i(m, s; \varepsilon)$ for all $\varepsilon \leq \varepsilon^*$. We must show that $(x^{i'}, m^{i'}) \in \bar{\xi}^i(m, s; 0)$.

Since $\hat{\beta}^i(m, s)$ is closed and constant in ε , $(x^{i'}, m^{i'}) \in \hat{\beta}^i(m, s)$. Also, since $y(m/m_\varepsilon^{i'}, s) \geq \varepsilon u > 0$ for all $0 < \varepsilon \leq \varepsilon^*$, $m_\varepsilon^{i'}$ and $m^{i'} \in \bar{M}^i(m)^{i'}(, s) \subseteq M^i(m)^{i'}(, s; 0) = M$ for all $0 < \varepsilon \leq \varepsilon^*$.

Suppose $(x^{i'}, m^{i'}) \notin \bar{\xi}^i(m, s; 0)$. Then, since i is not in the m.w.c., there exists some $(\hat{x}^i, \hat{m}^i) \in \bar{\beta}^i(m, s; 0) = \hat{\beta}^i(m, s)$ such that $(\hat{x}^i, y(m/\hat{m}^i, s)) >_i (x^{i'}, y(m/m^{i'}, s))$. If $\hat{m}^i \notin \bar{M}^i(m)^{i'}(, s)$, then $y(m/\hat{m}^i, s) \not\geq 0$ and by lemma 3.15, there exists some $\bar{m}^i \in \bar{M}^i(m)^{i'}(, s)$ such that $y(m/\bar{m}^i, s) = y(m/\hat{m}^i, s)$ and by (g.4), $C^i(m/\bar{m}^i, s) = C^i(m/\hat{m}^i, s)$. Thus $(\hat{x}^i, \bar{m}^i) \in \bar{\beta}^i(m, s; 0)$ also, and $(\hat{x}^i, y(m/\bar{m}^i, s)) >_i (x^{i'}, y(m/m^{i'}, s))$.

Let $\{(x_\varepsilon^{i*}, m_\varepsilon^{i*})\}_\varepsilon$ be the sequence defined by:
 $(x_\varepsilon^{i*}, m_\varepsilon^{i*}) \equiv \frac{\varepsilon}{\varepsilon^*} (x_{\varepsilon^*}^{i'}, m_{\varepsilon^*}^{i'}) + (1 - \frac{\varepsilon}{\varepsilon^*}) (\hat{x}^i, \bar{m}^i)$ for all $0 < \varepsilon \leq \varepsilon^*$.

Clearly, $(x_\varepsilon^{i*}, m_\varepsilon^{i*}) \rightarrow (\hat{x}^i, \bar{m}^i)$ as $\varepsilon \rightarrow 0$. Also, since $m_\varepsilon^{i'}$ and $\bar{m}^i \in \bar{M}^i$, by

$$(f.2) \quad y(m/m_{\epsilon}^{i*}, s) \geq \frac{\epsilon}{\epsilon^*} y(m/m_{\epsilon^*}^{i'}, s) + (1 - \frac{\epsilon}{\epsilon^*}) y(m/\bar{m}^i, s) \geq \frac{\epsilon}{\epsilon^*} \cdot \epsilon^* u = \epsilon u$$

for every $0 < \epsilon \leq \epsilon^*$. Furthermore, since C^i is convex in m^i (by(g.2)), $p x_{\epsilon}^{i*} + C^i(m/m_{\epsilon}^{i*}, s) \leq \widehat{w}^i(m, s)$ for all $0 < \epsilon \leq \epsilon^*$. Thus $(x_{\epsilon}^{i*}, m_{\epsilon}^{i*}) \in \bar{\beta}^i(m, s; \epsilon)$ for all $0 < \epsilon \leq \epsilon^*$.

Now, since $(x_{\epsilon}^{i*}, m_{\epsilon}^{i*}) \rightarrow (\hat{x}^i, \bar{m}^i)$ and $(x_{\epsilon}^{i'}, m_{\epsilon}^{i'}) \rightarrow (x^{i'}, m^{i'})$ and $(\hat{x}^i, \bar{m}^i) \succ_i (x^{i'}, m^{i'})$, by continuity of preferences (assumption (b.2)), for ϵ' sufficiently close to zero, $(x_{\epsilon'}^{i*}, m_{\epsilon'}^{i*}) \succ_i (x_{\epsilon'}^{i'}, m_{\epsilon'}^{i'})$. But since i is not in the m.w.c. and $(x_{\epsilon'}^{i*}, m_{\epsilon'}^{i*}) \in \bar{\beta}^i(m, s; \epsilon')$, this contradicts the fact that $(x_{\epsilon'}^{i'}, m_{\epsilon'}^{i'}) \in \bar{\xi}^i(m, s; \epsilon')$. Thus $(x^{i'}, m^{i'}) \in \bar{\xi}^i(m, s; 0)$ proving that $\bar{\xi}^i$ is u.h.c. in ϵ at $\epsilon = 0$ and thus, that $\bar{\xi}^{i*}(m, s) \subseteq \widehat{\xi}^i(m, s)$.

In summary of subsection 3.5, we have modified the compactified quasi-decision correspondence $\widehat{\xi}^i$ by defining a new decision correspondence ξ^{i*} (definition 3.9) and showing that on $M^I \times S$

- i) ξ^{i*} is non-empty (corollary 3.16.1)
 - ii) ξ^{i*} is convex valued (corollary 3.17.1)
 - iii) ξ^{i*} is upper hemi-continuous (corollary 3.19.1)
- and iv) $\xi^{i*} \subseteq \widehat{\xi}^i$ (lemma 3.20).

3.6 The Fixed Point

Definition 3.10: The set E of possible values of excess demand in the compactified economy $\widehat{\mathcal{E}}$ is defined by:

$$E = \{e \in \mathbb{R}^{L+K} \mid e = (\sum_i (x^i - w^i), y) - \sum_j z^j, x^i \in \widehat{X}^i, y \in \widehat{Y}, \text{ and } z^j \in \widehat{Z}^j\}.$$

Lemma 3.21: E is a non-empty, compact, and convex subset of \mathbb{R}^{L+K}

Proof: Obvious.

Definition 3.11: The mapping $\eta: E \rightarrow S$ is defined by:

$$\eta(e) = \{s \in S \mid se \geq s'e \text{ for all } s' \in S\}.$$

Lemma 3.22: η is upper hemi-continuous on E and for all $e \in E$, $\eta(e)$ is non-empty and convex.

Proof: See Debreu [5], p. 82, last paragraph].

Lemma 3.23: $E \times M^I \times S$ is a non-empty, compact, and convex subset of a locally convex topological space.

Proof: Immediate from lemma 3.20, assumption (e), and definition of S .

Definition 3.12: The correspondence $\rho: E \times M^I \times S \rightarrow E \times M^I \times S$ is defined by:

$$\rho(e, m, s) = \{(e', m', s') \in E \times M^I \times S \mid e' = (\sum_i (x^{i'} - w^i), y(m, s)) - \sum_j z^{j'}\},$$

$$\text{where } (x^{i'}, m^{i'}) \in \xi^{i*}(m, s), z^{j'} \in \Phi^j(m, s), s' \in \eta(e)\}$$

Lemma 3.24: ρ is an upper hemi-continuous correspondence on $E \times M^I \times S$.

Proof: The result follows easily from lemma 3.5, corollary 3.19.1, lemma 3.22, and assumption (f.1).

Lemma 3.25: For every $(e, m, s) \in E \times M^I \times S$, $\rho(e, m, s)$ is non-empty and convex.

Proof: By lemma 3.5, corollary 3.16.1, and lemma 3.21, $\widehat{\Phi}^j(m,s), \widehat{\xi}^{i*}(m,s)$, and $\eta(e)$ are non-empty. Let $z^{j'} \in \widehat{\Phi}^j(m,s), (x^{i'}, m^{i'}) \in \widehat{\xi}^{i*}(m,s)$, and $s' \in \eta(e)$. By definition $z^{j'} \in \widehat{Z}^j$ and $x^{i'} \in \widehat{X}^i$. By construction of the cube K (definition 3.7), $y(m,s) \subseteq \widehat{Y}$. Therefore $e' = (\sum_i (x^{i'} - \omega^i), y(m,s)) - \sum_j z^{j'} \in E$, establishing the non-emptiness of $\rho(e,m,s)$.

Convexity follows 13/ from lemma 3.5, corollary 3.17.1, and lemma 3.22.

Lemma 3.26: There exists a fixed point of the mapping ρ ; i.e. a triple $(e^*, m^*, s^*) \in E \times M^I \times S$ such that $(e^*, m^*, s^*) \in \rho(e^*, m^*, s^*)$.

Proof: A direct application of the Tychonoff, Kakutani, Ky Fan Fixed Point Theorem (see Berge [4 , p. 251]). The assumptions of the theorem are satisfied by lemmata 3.23, 3.24, and 3.25.

3.7 Quasi-Equilibrium

Remark 3.2: Lemma 3.26 establishes the existence of an $(I + J + 2)$ - tuple $\{ \langle x^{i*}, m^{i*} \rangle_i, y^*, \langle z^{j*} \rangle_j, s^* \}$ such that

- i) $e^* = (\sum_i (x^{i*} - \omega^i), y^*) - \sum_j z^{j*}$
- ii) $(x^{i*}, m^{i*}) \in \widehat{\xi}^{i*}(m^*, s^*)$
- iii) $z^{j*} \in \widehat{\Phi}^j(m^*, s^*)$
- iv) $y^* = y(m^*, s^*)$
- v) $s^* \in \eta(e^*)$, i.e. $s^* e^* \geq s' e^*$ for all $s' \in S$.

For typographic simplicity the superscript $*$ will be dropped hereafter from the notation of the fixed point.

Lemma 3.27: $\sum_i C^i(m, s) + \sum_j [\widehat{R}_1^j(m, s) s \cdot z^j + \widehat{R}_2^j(m, s)] = q \cdot y$, that is, the government's budget is balanced at the fixed point.

Proof: This follows directly from Remark 3.2 (ii) above and assumption (i) of the Basic Assumptions of Section III.2.

Lemma 3.28: Excess demands at the fixed point are non-positive, i.e. $e \leq 0$.

Proof: Summing over all consumers' budgets gives:

$$p \sum_i x^i + \sum_i C^i(m, s) \leq p \cdot \sum_i w^i + \sum_j \widehat{\pi}^j(m, s).$$

But $\sum_j \widehat{\pi}^j(m, s) = \sum_j (1 - \widehat{R}_1^j(m, s)) s z^j - \sum_j \widehat{R}_2^j(m, s)$. Thus, by lemma 3.27,

$$s[(\sum_i (x^i - w^i), y) - \sum_j z^j] = s e \leq 0. \text{ But by Remark 3.2 (v), } 0 \geq s e \geq s' e$$

for all $s' \in S$. The desired result follows as in the proof of statement (1) of Section 5.6 in Debreu [5; note especially the paragraph following statement (2) on p. 83].

Remark 3.3: Let $\sum_j Z^j = Z$. Since $z^j \in \widehat{Z}^j \subseteq Z^j$ it follows that $z \in Z$.

Therefore, since assumptions (d.1), (d.2) and (d.4) imply $(Z - \Omega) \subseteq Z$,

(see statement (2) of section 3.3 in [5 , p. 42]), it follows from lemma 3.28

that $z + e \in Z$. Therefore, there exist $z^{j**} \in Z^j$ such that $\sum_j z^{j**} = z + e$.

We will show that $\{ \langle x^i, m^i \rangle_i, \langle z^{j**} \rangle_j, s \}$ is a quasi-equilibrium for \mathcal{E} .

Lemma 3.29: i) $z^{j**} \in \omega^j(m, s)$

ii) $sz^{j**} = sz^j$

iii) $\pi^j(m, s) = \widehat{\pi}^j(m, s)$

Proof: By lemma 3.27 and assumptions (b.1) and (b.3), it follows as a corollary

to lemma 3.28 that $s_\varepsilon = 0$ since each consumer's budget constraint will hold with equality. Then, since $z^{**} = z + e$, $sz^{**} = sz + se = sz$. The lemma then follows as in the proof of statement (1) of Section 5.7 of Debreu [5, p. 83, see especially part 8, p. 87] since $z^{j**} \in \hat{\Phi}^j(m, s) \subset \hat{Z}^j$, and since $\hat{R}^j(m, s) = R^j(m, s)$ because $\max s \hat{Z}^j = \max s Z^j$ for all j .

Lemma 3.30: $(x^i, m^i) \in \xi^i(m, s)$.

Proof: Suppose $(x^i, m^i) \notin \xi^i(m, s)$. Then, since $(x^i, m^i) \in \hat{\beta}^i(m, s) \subset \beta^i(m, s)$ i is not in the m.w.c. at (m, s) . Thus, there exists some $(x^{i'}, m^{i'}) \in X^i \times M$ such that $px^{i'} + C^i(m/m^{i'}, s) \leq w^i(m, s)$ and $(x^{i'}, y(m/m^{i'}, s)) \succ_i (x^i, y(m, s))$. By lemma 3.15, if $m^{i'} \notin \bar{M}^i(m)^{i'}$, there is an $\tilde{m}^i \in \bar{M}^i$ such that $y(m/\tilde{m}^i, s) = y(m/m^{i'}, s)$ and $C^i(m/\tilde{m}^i, s) = C^i(m/m^{i'}, s)$ by (g.4). Thus, without loss in generality we can assume $m^{i'} \in \bar{M}^i(m)^{i'}$. Similarly, if $m^i \notin \bar{M}^i(m)^i$ there exists an $\hat{m}^i \in \bar{M}^i$ such that $y(m/\hat{m}^i, s) = y(m, s)$ and $C^i(m/\hat{m}^i, s) = C^i(m, s)$ so that $(x^i, \hat{m}^i) \in \xi^i(m, s)$, if and only if $(x^i, m^i) \in \xi^i(m, s)$. Thus, without loss in generality we may assume $m^i \in \bar{M}^i$.

Define $(x^i(\lambda), m^i(\lambda)) = \lambda(x^{i'}, m^{i'}) + (1-\lambda)(x^i, m^i)$. By (b.3), (b.4) and (f.2) $(x^i(\lambda), y(m/m^i(\lambda), s)) \succ_i (x^i, y(m, s))$ for all $\lambda \in (0, 1)$. By (g.2) $px^i(\lambda) + C^i(m/m^i(\lambda), s) \leq w^i(m, s)$ for all $\lambda \in (0, 1)$. Since, by lemma 3.29 (iii), $w^i(m, s) = \hat{w}^i(m, s)$. Finally, since $(x^i, y(m, s)) \in \text{interior } K$, for λ sufficiently close to zero, $(x^i(\lambda), y(m/m^i(\lambda), s)) \in \text{interior } K$. But this contradicts the fact that $(x^i, m^i) \in \xi^{i*}(m, s) \subset \xi^i(m, s)$ by lemma 3.20.

Remark 3.4: It has been established that:

- i) $(x^i, m^i) \in \xi^i(m, s)$ (lemma 3.30)

- (ii) $z^{j**} \in \phi^j(m, s)$ (lemma 3.29)
- (iii) $(\sum_i (x^i - w^i), y(m, s)) - \sum_j z^{j**} = 0$ (Remark 3.3)
- (iv) $s \geq 0$ since $s \in S$.

Thus $\{\langle x^i, m^i \rangle_i, \langle z^{j**} \rangle_j, s\}$ is a quasi-equilibrium relative to the government $G = \{M, y(\cdot), \langle C^i(\cdot) \rangle_i, \langle R^j(\cdot) \rangle_j\}$ in the economy \mathcal{E} . This completes the proof of Theorem 1.

III.4 The Existence of an Equilibrium

If no consumer is in the minimum wealth condition at (m, s) , then the quasi-equilibrium, whose existence was proved in Section III.3, is a competitive equilibrium relative to the government G since $\delta^i(m, s) = \xi^i(m, s)$.

Corollary 1.1: The quasi-equilibrium $\{\langle x^i, m^i \rangle_i, \langle z^j \rangle_j, s\}$ of Theorem 1 is a competitive equilibrium relative to the government G for \mathcal{E} if

$$\text{Min}_{m^{i'} \in M} C^i(m/m^{i'}, s) < w^i(m, s) \text{ for all } i$$

Proof: Trivial from the definition.

Remark 3.5: There are many assumptions which have been utilized to avoid the minimum wealth condition in the Arrow-Debreu model with only private goods. (See [6] for a list of these.) However, these assumptions are not sufficient within the context of our model. For example, one cannot simply assume that $w^i \gg 0$ for all i since an equilibrium value of $p^* = 0$ is possible even though $s^* \in S$. Furthermore, even if $p^* \neq 0$ and $w^i \gg 0$ for all i , it is possible under our assumptions that $C^i(m^*/m^i, s^*) \geq p^{*i}$ for all i and

all $m^i \in M$ and that $s^* z^{*j} = 0$ for all j (if there are constant returns to scale). In this case, if $\sum_i C^i(m^*, s^*) = q^* y(m^*, s^*)$ everyone would be in the minimum wealth condition.

In our model there are assumptions on the government rules and on the economy such that in quasi-equilibrium, no consumer will be in the minimum wealth condition. We consider three of these.

Assumptions to avoid m.w.c.

One can use any one of the following.

(j.1) For every $(m, s) \in M^I \times S$ and for every i there is an $\bar{m}^i \in M$ such that $C^i(m/\bar{m}^i, s) = 0$. Also, there is a private good l' such that, for every i , $w_{l'}^i > 0$ and \tilde{z}_i are strictly monotonic in $x_{l'}^i$.

(j.2) For every $(m, s) \in M^I \times S$, $\sum_i C^i(m, s) - qy(m, s) > 0$. Also, $\theta^{ij} > 0$ for all i and j .

(j.3) For every $(m, s) \in M^I \times S$, $\sum_i C^i(m, s) - qy(m, s) \geq 0$, $\hat{s}z = \max sZ > 0$, and $\theta^{ij} > 0$ for all i, j .

The second sentence of (j.1) ensures that in quasi-equilibrium $p\omega^i > 0$ for all i . The first sentence then implies that no i is in the m.w.c.

The first sentence of (j.2) implies that in quasi-equilibrium, producers are subsidized since the government budget must be balanced. Therefore, after-tax profits must be positive since $0 \in Z^j$ for all j . The second sentence of (j.2) then implies that $p\omega^i < w^i(m, s)$ for all i . That in turn implies that no consumer is in the m.w.c. by assumption (g.3).

(j.3) implies that the after tax profit shares of each consumer are positive. Thus, by (g.3) no one is in the m.w.c.

Using the above arguments it is easy to establish

Corollary 1.2: If either (j.1) or (j.2) or (j.3) hold, the quasi-equilibrium of Theorem 1 is a competitive equilibrium relative to the government G for the economy \mathcal{E} .

III.5 Examples Revisited

To illustrate the generality of assumptions (e) to (i) we turn again to examples 2.1 to 2.4 of Section II.7.

Example 2.1: The Naive Government

It is easy to see that these rules satisfy (f) to (i). Thus, if we let \bar{M} be a compact convex subset of \mathbb{R}_+^K such that $0 \in \bar{M}$, a quasi-equilibrium exists for that compact message space. In general, if \bar{M} is big enough, the quasi-equilibrium for \bar{M} will also be one for \mathbb{R}_+^K .

In this example, $\bar{M}^i(m^i, s) = \mathbb{R}_+^K$ for all $(m^i, s) \in M^{I-1} \times S$ so that (f.2) and (f.3) hold trivially. Also since $R^j \equiv 0$ and $\Sigma C^i = qy$ for any environment (h) and (i) are easily satisfied.

Example 2.2: The Vacuous Government

It is relatively easy to show that, if $M = \mathbb{R}^K$, then (f) to (i) are satisfied. If, on the other hand, $M = \mathbb{R}_+^K$ it is conceivable that (g.3) is violated. Thus, if we wish to avoid bankrupting consumers, we must use \mathbb{R}^K ; however, if we do so, an equilibrium will not, in general, exist. A simple example illustrates this fact. Consider an economy with two consumers, two

commodities, and constant returns to scale in production. Let $u^1 = x^1 + \alpha \ln y$ and $u^2 = x^2 + \beta \ln y$ represent \succsim_1 and \succsim_2 respectively. If $M = \mathbb{R}_+^K = \mathbb{R}_+$, then the message component of $\xi^1(m, s)$ is $\max\{0, (2\alpha/q) - m_2\}$ and of $\xi^2(m, s)$ is $\max\{0, (2\beta/q) - m_1\}$ if consumers are not bankrupted and $p = 1$. Note that $\min C^1(m/m^1, s) = q m^2 / I$ which easily could be larger than ω^1 thus creating bankruptcy ($\beta^i(m, s) = \emptyset$).

If $M = \mathbb{R}$, instead, then (m^1, m^2) is an equilibrium if and only if $m^1 = (2\alpha/q) - m^2$ and $m^2 = (2\beta/q) - m^1$. This is true if and only if $\alpha = \beta$. Thus, unless preferences are identical these government rules are usually vacuous.

Example 2.3: The Lindahl Government

It should be obvious that if $M = \{m \mid m: \mathbb{R}_+^K \rightarrow \mathbb{R}_+^K\}$ then the Lindahl rules satisfy (f.3)(f.4)(f.5)(g.3)(g.4)(h) and (i). The other assumptions need not be satisfied. However, if we replace M with the subset of linear functions, $M^* = \{m \in M \mid m(y) = Ay + b\}$, then one can establish that (f.1)(f.2)(g.1) and (g.2) are satisfied at all m such that $(\sum_i A^i)^{-1}$ exists. Thus, on a compact subset of those m , a quasi-equilibrium exists.

It may appear that by using M^* instead of M we have immediately ruled out many possible equilibria. This is not true since for any equilibrium using M there is an equilibrium using M^* in the following sense. Let m^i be the equilibrium message of i using M . Choose $m^{*i} \in M^*$ such that $m^{*i}(y^*) = m^i(y^*)$ where y^* is the equilibrium allocation. Then if i were to use m^{*i} in place of m^i the equilibrium situation would not change. Thus, restricting attention to M^* neither adds nor subtracts potential equilibrium allocations.

Example 2.4: The DVM Government

Much of the discussion in the previous example applies to this one since in order to apply our existence theorem one needs to restrict the message space for the DVM rules. In particular, let $M^{**} = \{m \in M \mid m(y) = \frac{1}{2} y' Ay + by\}$. One can immediately verify that, given A^i, b^i , for each i the Lindahl rules and the DVM rules are the same except for the term $\delta^i(\cdot)$ in the DVM taxing rule. It is relatively easy to show that if the Lindahl rules satisfy (f) - (i) on M^* then the DVM rules satisfy (f) - (i) on M^{**} . Also, the remarks justifying the restriction to M^* for the Lindahl rules apply to M^{**} in this example. Thus a competitive equilibrium relative to the DVM rules will exist whenever a competitive equilibrium relative to the Lindahl rules exists.

FOOTNOTES FOR SECTION III

- 1/ In section III.5, we show that each of examples 2.1, 2.3, and 2.4 (in section II.7) satisfy the sufficient conditions for some message space. We also indicate why example 2.2 is not covered.
- 2/ See, for example, Debreu [5 ,pp. 83-84].
- 3/ See Debreu [5 ,p.84].
- 4/ We could have assumed instead that M is a compact, convex subset of \mathbb{R}^K ; however, we wish to include governments for which M is a set of functions (as in examples 2.3 and 2.4).
- 5/ We might have assumed that $y(\cdot)$ was concave in m^i on all of M (which implies (f.3) and obviates (f.4)); however, we wish to consider rules of the form $y(m,s) = \max \{0, f(m,s)\}$ where f is concave in m . Examples 2.3, 2.4, and our rules are of this type
- 6/ We could have assumed instead that $\min C^i(m,s) \leq w^i(m,s)$; however, (g.3) is more convenient. Also, while (g.3) requires government monitoring of, at most, initial endowments, this alternative might also require the government to collect information on the profits received by consumers.
- 7/ For many government rules (g.3)(h) and (i) are trivially satisfied for any economy. See example 2.1 of Section II.7 for instance. However, in some cases it may be necessary to have $C^i(\cdot)$ and $R^j(\cdot)$ depend specifically on the economy. In particular one might want $C^i = C^i(m,s,w^i)$ and $R^j = R^j(m,s,\max s Z^j)$. If C^i and R^j are of this form then (g.3), (h), and (i) are assumed to hold for any $(w^i), (Z^j)$ satisfying (c) and (d).

8/ In particular if $R^j = R^j(m, s, \text{Max } Z^j)$ then $\hat{R}^j = \hat{R}^j(m, s, \text{max } s Z^j)$.

9/ Non-convexity of the (compactified quasi-) decision correspondence $\hat{\xi}^i$ prevents the application of the fixed point theorem we use to establish existence.

10/ Application of the fixed point theorem requires that the decision correspondence be non-empty, convex valued, and upper hemi-continuous. From the example illustrated in figure 1, an apparent solution might be to restrict the decisions to the segment bc by defining the restricted decision correspondence by $\hat{\xi}^i(m, s) \cap \bar{M}^i(m)^i(s)$ where $\bar{M}^i(m)^i(s)$ is defined in assumption (f.2). However, one can construct examples to show that such a restricted decision correspondence, although non-empty and convex valued, is not upper hemi-continuous.

11/ Alternatively, let $O(m, s) \equiv \{(x^{i'}, m^{i'}, \epsilon) \in \hat{X}^i \times M \times \mathbb{R} \mid \epsilon > 0 \text{ and } (x^{i'}, m^{i'}) \in \bar{\xi}^i(m, s, \epsilon)\}$.

Let $G(m, s)$ be the closure of $O(m, s)$. Then

$$\bar{\xi}^{i*}(m, s) = \{(x^{i'}, m^{i'}) \in \hat{X}^i \times M \mid (x^{i'}, m^{i'}, 0) \in G(m, s)\} \text{ if } i \text{ is}$$

not in the minimum wealth condition.

12/ If $M^i(m)^i(s, \epsilon)$ were continuous in ϵ at $\epsilon = 0$, the result would follow easily. However, $M^i(m)^i(s, \epsilon)$ is not necessarily lower hemi-continuous at $\epsilon = 0$.

13/ If, in the definition of ρ (definition 3.12), $y(m', s')$ or $y(m', s)$ were used instead of $y(m, s)$, $\rho(e, m, s)$ would not necessarily be convex unless y were linear in m and s .

IV. AN OPTIMAL INCENTIVE COMPATIBLE GOVERNMENT

IV. 1 The Groves-Ledyard Government

In this section we define a specific government G - that is, a language M , an allocation rule $y(\cdot)$, consumer tax rules $\langle C^i(\cdot) \rangle_i$, and producer tax rules $\langle R^j(\cdot) \rangle_j$ - which we refer to as the Groves-Ledyard (G-L) government. Following the specification of the G-L government, the results of Section III are used to establish the existence of a competitive (quasi-) equilibrium relative to the G-L government. Next the two Fundamental Welfare Theorems are proved - 1) that a competitive allocation relative to the G-L government is Pareto Optimal, and 2) that any Pareto Optimum allocation is competitive following, if necessary, a redistribution of endowments and profit shares. Finally, we present a few simple examples to illustrate these results and contrast them with conventional wisdom on the Free Rider Problem.

To begin, the language M of the G-L government is the Euclidean space \mathbb{R}^K of the same dimensionality as the number of public goods:

$$(4.1) \text{ G-L language space } M \equiv \mathbb{R}^K$$

The allocation rule $y(\cdot)$, which specifies the bundle of public goods to be provided given the messages of the consumers (and the prevailing prices) $\frac{1}{}$ is defined by:

$$(4.2) \text{ G-L allocation rules } y(m) \equiv \text{Max} \{ \sum_i m^i, 0 \} \equiv (\text{Max} \{ \sum_i m_k^i, 0 \})_{k=1, \dots, K}$$

With this allocation rule, a consumer's message m^i may be interpreted as communicating to the government how much more (or less) of each public good the consumer would like the government to provide, given the amounts requested by

the other consumers. Given the other's messages, a rational consumer will communicate the increment (or decrement) m^i such that the resulting bundle is the most desired one. ^{2/} Since every rational consumer can insure that the resulting allocation of public goods is his most desired bundle, given the messages of the other consumers, in an equilibrium all consumers' most desired bundles must be equal. ^{3/} It is the role of the taxing rules to ensure that this is possible. Of course, even though in an equilibrium all consumers will desire the same bundle, their messages and taxes need not, and generally will not, all be identical.

Although the allocation rule $y(\cdot)$ is very simple, the consumer tax rules $\langle C^i(\cdot) \rangle_i$ of the G-L government are quite complicated. They are defined by:

(4.3a) G-L consumer tax rule

$$C^i(m, s) \equiv D^i(m)^i(y^i(m, s), s) - \text{Max} \{A^i(m)^i(s), B^i(m)^i(s)\}$$

where

$$(4.3b) \quad D^i(m)^i(y, s) \equiv - (I - |s| \sum_{h \neq i} m^h - \frac{1}{I} q) \cdot y + \frac{I-1}{2} |s| y \cdot y$$

$$(4.3c) \quad y^i(m, s) \equiv \text{Max} \{y(m), y(m/\underline{m}^i(m)^i(s))\}$$

$$(4.3d) \quad \underline{m}^i(m)^i(s) \equiv \text{Max} \left\{ \frac{1}{I-1} \left(\sum_{h \neq i} m^h - \frac{1}{I|s|} q \right), - \sum_{h \neq i} m^h \right\}$$

$$(4.3e) \quad A^i(m)^i(s) \equiv \text{Min}_{m^i} \left\{ D^i(m)^i(y^i(m/m^i, s), s) - \frac{p \omega^i}{p \omega} q \cdot y^i(m/m^i, s) \right\} \quad \frac{4/}{}$$

$$(4.3f) \quad B^i(m)^i(s) = \text{Min}_{m^i} \left\{ D^i(m)^i(y^i(m/m^i, s), s) \right\} - |s| p \cdot \omega^i.$$

The complexity of these tax rules is necessitated by assumptions (g.1) - (g.4) of Section III.2 to ensure the existence of a quasi-equilibrium. Major complications arise at boundary points that the terms $y^i(m, s)$ and

$\bar{m}^i(m^i, s)$ circumvent. These difficulties will be explained in the next section when assumptions (g.1) - (g.4) are verified.

In order to interpret the consumer tax rules we will develop a simpler and economically more meaningful expression that is equivalent to the formulation of (4.3a-f) at interior points.

Proposition 4.1: Suppose preferences are strictly monotonic increasing in each public good k . Given $(s, m) \in S \times M^I$, let $(x^{i'}, m^{i'}) \in \bar{\xi}^i(m, s)$ - the quasi-decision set for i - and suppose that $y(m/m^{i'}) > 0$, $q \cdot y(m/\bar{m}^i, s) \leq p \cdot \omega$, and that the consumer is not in the minimum worth condition at (m, s) , where \bar{m}^i minimizes $[D^i(m^i, y(m, s)) - \frac{p \cdot \omega^i}{p \cdot \omega} q \cdot y(m/m^i)]$. Then, consumer i 's tax is given by:

$$(4.4) \quad C^i(m/m^{i'}, s) = \frac{p \cdot \omega^i}{p \cdot \omega} q \cdot y(m/m^{i'}) + [D^i(m^i, y(m/m^{i'}), s) - \frac{p \cdot \omega^i}{p \cdot \omega} q \cdot y(m/m^{i'})] \\ - [D^i(m^i, y(m/\bar{m}^i), s) - \frac{p \cdot \omega^i}{p \cdot \omega} q \cdot y(m/\bar{m}^i)].$$

Proof: See Appendix IV.A. ||

Although the consumer's tax $C^i(m, s)$ in the form (4.4) is simpler than the form (4.3a-f), it is difficult to interpret directly. To derive an equivalent but more transparent formulation, given any price vector $s \in S$, define for every message $m^h \in M$ the function $f^h(y; m^h, q)$ of public goods bundles y by:

$$(4.5) \quad f^h(y; m^h, q) \equiv (I m^h + \frac{1}{I} q) \cdot y - \frac{1}{2} y \cdot y.$$

The function $f^h(\cdot; m^h, q)$ may be called consumer h 's reported willingness to pay function since, if m^{h*} is the best message for consumer h (i.e.

$(x^{h*}, m^{h*}) \in \xi^h(m, s)$, the gradient of $f^h(y; m^{h*}, q)$ with respect to y evaluated at $y(m/m^{h*})$ equals the vector of the maximum amounts consumer h would be willing to pay for marginal increases in public goods (i.e. the maximum amounts consumer h could pay and remain as well off as he is at $(x^{h*}, y(m/m^{h*}))$). The following proposition formally states this result:

Proposition 4.2: Suppose the preferences of consumer i are representable by a neo-classical $\frac{5}{}$ utility function $u^i(x^i, y)$. Given $(m, s) \in M^I \times S$, suppose $y(m/m^i) > 0$ and $q \cdot y^i(m/m^i, s) \leq p \cdot w$ where m^i is defined in Proposition 4.1. Define $z^i(y)$ by:

(4.6) $z^i(y)$ maximizes z subject to

$$u^i(\hat{x}^i(z), y) \geq u^i(x^{i*}, y(m/m^{i*}))$$

where $\hat{x}^i(z)$ maximizes $u^i(x^i, y)$ subject to $p x^i \leq w^i(m, s) - z$. Then, for every $k = 1, \dots, K$,

$$(4.7) \quad \frac{\partial z^i(y(m/m^{i*}))}{\partial y_k} = \frac{\partial f^i(y(m/m^{i*}); m^{i*}, q)}{\partial y_k}$$

where $(x^{i*}, m^{i*}) \in \xi^i(m, s)$.

Proof: See Appendix IV.B. \parallel

A remarkable implication of Proposition 4.2 is that when the consumer sends his best message m^{i*} , he is in effect communicating to the government the gradient of his true willingness to pay function or his true marginal rates of substitution at the level of the public goods provided by the government. This result is the basis of our claim that an equilibrium relative to the

G-L government yields a Pareto Optimal allocation. The formal proof of this theorem is in Section IV.3.

Now, since each message m^h defines a reported willingness to pay function f^h ; given public goods prices q , the allocation rule $y(m) = \text{Max} \{ \sum_h m^h, 0 \}$ is easily seen to be the solution to the problem:

$$(4.8) \quad \text{Max}_{y \geq 0} \sum_h f^h(y; m^h, q) - qy.$$

Thus, $y(m)$ maximizes the net social reported willingness to pay (gross less the social cost $q \cdot y$) or total reported consumer surplus.

The tax $C^i(m/m^{i'}, s)$ given by (4.4) may be equivalently expressed in terms of the reported willingness to pay functions. It is straightforward to verify that:

$$(4.9) \quad C^i(m/m^{i'}, s) = \frac{p^i \omega^i}{p \omega} q \cdot y(m/m^{i'}) + \sum_{h \neq i} [f^h(y(m/\bar{m}^i); m^h, q) - \frac{p^h \omega^h}{p \omega} q \cdot y(m/\bar{m}^i)] \\ - \sum_{h \neq i} [f^h(y(m/m^{i'}); m^h, q) - \frac{p^h \omega^h}{p \omega} q \cdot y(m/m^{i'})].$$

Calling the term $\frac{p^i \omega^i}{p \omega} q \cdot y$ consumer i 's proportional cost share of y and the term $f^h(y; m^h, q) - \frac{p^h \omega^h}{p \omega} q \cdot y$ consumer h 's reported consumer surplus or net reported willingness to pay, the tax $C^i(m/m^{i'}, s)$ is easily interpreted. The consumer is assessed his proportional cost share plus the total deviation in the aggregate consumer surplus of the other consumers caused by i 's message being $m^{i'}$ instead of \bar{m}^i . Since, by definition, \bar{m}^i minimizes

$$D^i(m)^i(y^i(m, s), s) - \frac{p^i \omega^i}{p \omega} q \cdot y^i(m, s), \bar{m}^i \text{ maximizes}$$

$$\sum_{h \neq i} [f^h(y^i(m, s); m^h, q) - \frac{p^h \omega^h}{p \omega} q \cdot y^i(m, s)]. \text{ Thus, under the conditions of}$$

Proposition 4.1, $y^i(m/\bar{m}^i, s) = y(m/\bar{m}^i)$ maximizes

$$\sum_{h \neq i} [f^h(y; m^h, q) - \frac{p \omega^h}{p \omega} q \cdot y]$$

or the aggregate net reported consumer surplus of all the other consumers. Thus, by sending $m^{i'}$ instead of \bar{m}^i , $y(m/m^{i'})$ is chosen instead of $y(m/\bar{m}^i)$ and consumer i is assessed, in addition to his proportional cost share, the total loss in aggregate net reported consumer surplus of the other consumers. This is most clearly seen by writing $C^i(m/m^{i'}, s)$ as (where $m^i = m^{i'}$):

$$(4.10) \quad C^i(m, s) = \frac{p \omega^i}{p \omega} q \cdot y^* + \sum_{h \neq i} [f^h(\hat{y}; m^h, q) - \frac{p \omega^h}{p \omega} q \cdot \hat{y}] - \sum_{h \neq i} [f^h(y^*, m^h, q) - \frac{p \omega^h}{p \omega} q \cdot y^*]$$

where

$y^* = y(m)$ maximizes reported consumer surplus of all consumers:

$$\sum_h f^h(y; m^h, q) - q \cdot y \equiv \sum_h [f^h(y; m^h, q) - \frac{p \omega^h}{p \omega} q \cdot y]$$

and

$\hat{y} = y(m/\bar{m}^i)$ maximizes reported consumer surplus of all consumers except consumer i :

$$\sum_{h \neq i} [f^h(y; m^h, q) - \frac{p \omega^h}{p \omega} q \cdot y].$$

To complete the specification of the G-L government the producer tax rules $\langle R^j(\cdot) \rangle_j$ need to be given. There are many possibilities for these rules, however for simplicity we set the tax rate on profits at zero and use only lump-sum producer taxes or subsidies:

(4.11) G-L producer tax rule

$$R^j(m,s) = (R_1^j(m,s), R_2^j(m,s)) \equiv (0, R_2^j(m,s))$$

where $\langle R_2^j(m,s) \rangle_j$ is any continuous selection such that

$$i) \quad R_2^j(m,s) \leq \text{Max } sZ^j \quad \text{for all } j$$

$$\text{and } ii) \quad R(m,s) \equiv \sum_j R_2^j(m,s) = \text{Min} \{q \cdot y(m) - \sum_i C^i(m,s); \text{Max } sZ\}$$

The first restriction is imposed to prevent bankrupting producers. The second restriction is imposed to avoid running a government surplus. A government deficit, however, is not ruled out by the G-L government rules^{*/}. Since consumers' minimal tax collections are limited by the values of their initial endowment of private goods (as is shown in the next section) and producer tax collections by their profits, if consumers demand sufficiently large quantities of public goods a deficit may result; i.e.

$$\sum_i C^i(m,s) + R(m,s) \leq \sum_i p \omega^i + \text{Max } sZ \leq q \cdot y(m,s).$$

We will show, however, in the next section (proposition 4.7) that this cannot happen if all consumers obey their budget constraints.

The existence of continuous producer tax rules satisfying (4.11) (i) and (ii) is easily assured under assumption (d.2) on the production sets Z^j .

Consider the correspondence $\zeta: M^I \times S \rightarrow \mathbb{R}^J$

$$\zeta(m,s) \equiv \{r \in \mathbb{R}^J \mid r_j \leq \text{Max } sZ^j, \sum_j r_j = \min \{q \cdot y(m) -$$

$$\sum_i C^i(m,s), \text{Max } sZ\}\}.$$

It is easy to see that ζ is a continuous correspondence on $M^I \times S$. Hence, there exists a continuous function $\bar{R}(m,s) \equiv (R^1(m,s), \dots, R^J(m,s))$ such that $\bar{R}(m,s) \in \zeta(m,s)$ for all (m,s) by the Continuous Selection Theorem of Michael [18].

^{*/} Added in proof: We have recently discovered that by making a minor modification in the consumer tax rules the government's budget can be balanced by taxes on consumers only. In other words, by adding a term to the functions $C^i(m,s)$ that is independent of m^i (thus preserving the incentive properties) we may set $R^j(m,s) \equiv (0,0)$ for all producers. In particular, this change will make the consumer's budget correspondence $\beta^i(m,s)$ independent of m . The modification is similar to that of Groves and Loeb [13, Section 2.6, equation (21)] (See Remark 2.1

IV.2 The Existence of a Quasi-Equilibrium relative to the G-L Government

Having specified the G-L government, we next will prove the existence of a quasi-equilibrium relative to this government. However, since the message space $M \equiv \mathbb{R}^K$ is not compact the assumption of the existence theorem of Section III cannot be directly verified. Our approach will be to compactify M , verify the existence assumption relative to the compactification, and prove directly that a quasi-equilibrium relative to the compact M is a quasi-equilibrium relative to the G-L government (when $M \equiv \mathbb{R}^K$). Throughout this section we assume assumptions (a) - (d.1 - d.5) are satisfied by consumers and producers.

To define the compactified message space, let $\delta = (\bar{\delta}^i, \underline{\delta})$ be any pair of strictly positive vectors in \mathbb{R}^K with equal components such that $\bar{\delta} > I\underline{\delta}$. For every such $\delta = (\bar{\delta}, \underline{\delta})$, define the message space M_δ by: $\frac{6/}{}$

$$(4.12) \quad M_\delta \equiv \{m^i \in \mathbb{R}^K \mid -\underline{\delta} \leq m^i \leq \bar{\delta} \text{ where } \underline{\delta}, \bar{\delta} \in \mathbb{R}^K, \underline{\delta}_k = \underline{\delta}_{k'}, \bar{\delta}_k = \bar{\delta}_{k'}, \text{ for all } k, k'\}$$

The δ -government is identical to the G-L government except that all messages m^i are restricted to be from M_δ . The following propositions verify that the δ -government satisfies assumptions (e) - (i) of the existence theorem.

Proposition 4.3: For every δ, M_δ satisfies assumption (e)

Proof: Obvious.

Proposition 4.4: For every $\delta = (\bar{\delta}, \underline{\delta})$ such that $\bar{\delta} > I\underline{\delta}$, the allocation rule $y(\cdot)$ defined by (4.2) satisfies assumptions (f.1) - (f.5).

Proof: (f.1) $y(m)$ is clearly continuous on $M_\delta^I \times S$, and since it is independent of s , is homogeneous of degree zero in prices.

(f.2) Since $\bar{M}_\delta^i(m)^i(s) = \text{closure} \{m^i \in M_\delta \mid y(m/m^i) > 0\}$, $y(m)$ is linear and hence concave in m^i on \bar{M}_δ^i .

$$(f.3) \quad \bar{M}_\delta^i \neq \emptyset \quad \text{since if } \hat{m}^i = \text{Max}_{m^h \in M_\delta} - \sum_{h \neq i} m^h = - (I-1) \text{Min}_{m^h \in M_\delta} m^h = (I-1) \underline{\delta} < \bar{\delta}$$

then $\hat{m}^i \in M_\delta$ and $\hat{m}^i \in \bar{M}_\delta^i$.

(f.4) $y(m) \geq 0$ by definition.

(f.5) To show $y(m/M_\delta)$ is a convex set, let y' and $y'' \in y(m/M_\delta)$; then $y' = y(m/m^{i'})$ and $y'' = y(m/m^{i''})$ where $m^{i'}$ and $m^{i''} \in M_\delta$. Then, we must show for every $\lambda \in [0,1]$ there exists some $\hat{m}^i \in M_\delta$ such that $y(m/\hat{m}^i) = \lambda y' + (1-\lambda)y''$.

$$\text{Define } \hat{m}_k^i = \begin{cases} \lambda m_k^{i'} + (1-\lambda)m_k^{i''} & \text{if } y'_k \text{ and } y''_k > 0 \\ m_k^{i'} \text{ or } m_k^{i''} & \text{if } y'_k = y''_k = 0 \\ \lambda m^{i'} + (\lambda-1)\sum_{h \neq i} m^h & \text{if } y'_k > 0 \text{ and } y''_k = 0. \end{cases}$$

Now, for every k

$$y_k(m/\hat{m}^i) = \begin{cases} \lambda(\sum_{h \neq i} m_k^h + m_k^{i'}) + (1-\lambda)(\sum_{h \neq i} m_k^h + m_k^{i''}) = \lambda y'_k + (1-\lambda)y''_k & \text{if } y'_k \text{ and } y''_k > 0 \\ y'_k = y''_k = 0 = (1-\lambda)y'_k + (1-\lambda)y''_k & \text{if } y'_k = y''_k = 0 \\ \text{Max} \{ \sum_{h \neq i} m_k^h + \lambda m^{i'} + (\lambda-1)\sum_{h \neq i} m^h, 0 \} = \lambda y' = \lambda y' + (1-\lambda)y'' & \text{if } y'_k > 0 \text{ and } y''_k = 0. \end{cases}$$

Thus $y(m/\hat{m}^i) = \lambda y' + (1-\lambda)y''$. Furthermore, since $-\underline{\delta}_k \leq \lambda m_k^{i'} + (1-\lambda)m_k^{i''} \leq \bar{\delta}_k$, $-\underline{\delta}_k \leq m_k^{i'}$ and $m_k^{i''} \leq \bar{\delta}_k$, $\lambda m^{i'} + (\lambda-1)\sum_{h \neq i} m^h \leq \lambda \bar{\delta}_k + (1-\lambda)(I-1)\underline{\delta}_k < \bar{\delta}_k$ and

if $y'_k > 0$ and $y''_k = 0$, $\sum_{h \neq i} m_k^h \leq \underline{\delta}_k$ which implies that $\lambda m^{i'} + (\lambda-1) \sum_{h \neq i} m_k^h$
 $\geq \lambda (\sum_{h \neq i} m_k^h + m_k^{i'}) - \sum_{h \neq i} m_k^h \geq -\underline{\delta}$, $\hat{m}^i \in M_\delta$. \parallel

Proposition 4.5: For every $\delta = (\bar{\delta}, \underline{\delta})$ with $\bar{\delta} > I\underline{\delta}$ and $\underline{\delta} > u \equiv (1, \dots, 1)$, the consumer tax rules $\langle C^i(\cdot) \rangle$ satisfy assumptions (g.1) - (g.4).

Proof: (g.1) $C^i(m, s)$ is clearly continuous on $M_\delta^I \times S$ and it is straightforward to show $C^i(m, s)$ is homogeneous of degree 1 in prices.

$$(g.3) \quad C^i(m, s) \leq D^i(m)^i(y^i(m, s), s) - B^i(m)^i(s) \\ = D^i(m)^i(y^i(m, s), s) - \text{Min}_{m^i \in M} [D^i(m)^i(y^i(m, s), s)] + p\omega^i$$

By lemma A.4.1, \underline{m}^i minimizes $D^i(m)^i(y^i(m, s), s)$. Thus, if $\underline{m}^i \in M_\delta$, $\text{Min}_{m^i \in M_\delta} C^i(m, s) \leq p\omega^i$. To show $\underline{m}^i \in M_\delta$ consider that

$$\underline{m}^i \equiv \text{Max} \left\{ -\sum_{h \neq i} m^h, \frac{1}{I-1} (\sum_{h \neq i} m^h - \frac{1}{I} q) \right\}. \text{ Since } -\sum_{h \neq i} m^h \leq (I-1)\underline{\delta} < I\underline{\delta} < \bar{\delta}$$

and $\frac{1}{I-1} (\sum_{h \neq i} m^h - \frac{1}{I} q) \leq \bar{\delta} - \frac{1}{I} q < \bar{\delta}$, we have $\underline{m}^i < \bar{\delta}$. If $\sum_{h \neq i} m^h \leq 0$, then

$$\underline{m}^i \geq -\sum_{h \neq i} m^h \geq 0 < -\underline{\delta}. \text{ If } \sum_{h \neq i} m^h \geq 0, \text{ then } \underline{m}^i \geq -\frac{1}{(I-1)I} q > -\underline{\delta} \text{ for}$$

$\underline{\delta} > 1$ since $q \leq 1$. Hence, $-\underline{\delta} < \underline{m}^i < \bar{\delta}$, or $\underline{m}^i \in M_\delta$.

(g.4) If $y(m/m^i) = y(m/m^{i'})$, then $y^i(m/m^i, s) = y^i(m/m^{i'}, s)$ and since C^i depends on m^i only through $y^i(m, s)$, $C^i(m/m^i, s) = C^i(m/m^{i'}, s)$.

(g.2) To show $C^i(m, s)$ is convex in m^i on M_δ we use the following lemma:

Lemma: Let $g: \mathbb{R}^K \rightarrow \mathbb{R}$ be a convex function of z and monotonic increasing

on $\bar{z} = \{z \in \mathbb{R}^K \mid z \geq \bar{z} \text{ where } \bar{z} \text{ minimizes } g(z)\}$. Let $f: M_\delta \rightarrow \mathbb{R}^K$ be a convex function of $m^i \in M_\delta$ such that $f(m^i) \geq \bar{z}$ for every $m^i \in M_\delta$.

Then $g\{f(m^i)\}$ is convex in m^i on M_δ .

Proof: Straightforward.

Now, D^i is a strictly convex function of y and since

$$\frac{\partial D^i}{\partial y} = - \left(\sum_{h \neq i} m^h - \frac{1}{I} q \right) + (I-1)y, \quad D^i \text{ is monotonic increasing on}$$

$$\bar{Y} = \{y \in \mathbb{R}^K \mid y \geq \frac{1}{I-1} \left[\sum_{h \neq i} m^h - \frac{1}{I} q \right] \equiv \bar{y}\}.$$

Also, $y^i(m, s) \geq y(m/\underline{m}^i) \geq \sum_{h \neq i} m^h + \underline{m}^i \geq \frac{1}{I-1} \left[\sum_{h \neq i} m^h - \frac{1}{I} q \right] = \bar{y}$. Thus,

$y^i(m, s) \geq \bar{y}$ for every $m^i \in M_\delta$. Finally

$$y^i(\lambda m^i + (1-\lambda)m^{i'}, s) = \text{Max}\{\text{Max}\left[\sum_{h \neq i} m^h + \lambda m^i + (1-\lambda)m^{i'}, 0\right], y(m/\underline{m}^i)\}$$

$$\leq \lambda \text{Max}\{y(m), y(m/\underline{m}^i)\} + (1-\lambda) \text{Max}\{y(m/m^{i'}), y(m/\underline{m}^i)\}$$

$$= \lambda y^i(m, s) + (1-\lambda) y^i(m/m^{i'}, s). \quad \text{Thus, } y^i(m, s) \text{ is convex in } m^i \text{ on } M_\delta.$$

Applying the lemma establishes that $D^i(m)^i(y^i(m, s), s)$ and thus $C^i(m, s) \equiv D^i(m)^i(y^i(m, s), s) - \text{Max}\{A^i, B^i\}$ is convex in m^i on M_δ .

This completes the proof of Proposition 4.5. \parallel

Remarks 4.2 (1) The properties (g.1) - (g.4) of $C^i(m, s)$ are independent of the definition of $A^i(m)^i(s)$ except that it must be continuous in $(m)^i(s)$ and homogeneous of degree one in s . Thus, if $A^i(m)^i(s)$ were defined to be zero identically (or any other constant times the norm of s), these properties would hold. However, the interpretation of the tax rules following

Proposition 4.1 relied on the particular definition of $A^i(\cdot)$ given in (4.3 e). In general, for any definition of $A^i(\cdot)$, if $A^i(m)^i(s) \leq B^i(m)^i(s)$ and $y^i(m,s) = y(m)$, the consumer i 's tax $C^i(m,s)$ may be expressed as:

$$C^i(m,s) = \frac{p^i \omega^i}{p \omega} q \cdot y(m) + [-A^i(m)^i(s) - \sum_{h \neq i} (f^h(y(m); m^h, q) - \frac{p^h \omega^h}{p \omega} q \cdot y(m))] \\ = q \cdot y(m) - \sum_{h \neq i} f^h(y(m); m^h, q) - A^i(m)^i(s).$$

The first expression may be interpreted as assessing consumer i his proportional cost share plus the deviation of the net consumer surplus of other consumers from a quantity $(-A^i(m)^i(s))$ that is independent of i 's message. The second (and equivalent) expression may be interpreted as assessing i for the full cost of the public goods less the aggregate willingness to pay of all other consumers plus $\frac{1}{\alpha^i}$ an amount $(-A^i(m)^i(s))$ that is independent of i 's message.

Another equivalent expression is:

$$C^i(m,s) = \alpha^i q \cdot y(m) - \sum_{h \neq i} [f^h(y(m); m^h, q) - \alpha^h q \cdot y(m)] - A^i(m)^i(s)$$

where $\sum_i \alpha^i = 1$. In this form, the tax rule assesses each consumer an arbitrary proportion of the total cost less the "net" willingness to pay of all other consumers plus the amount $-A^i(m)^i(s)$.

(2) Only properties (g.1) (continuity and homogeneity) and (g.3) depend on the definition of $B^i(m)^i(s)$. Property (g.3) is required by the existence theorem to ensure that no consumer is bankrupted by his tax. It guarantees that no consumer is forced to pay more than the value of his initial endowment for public goods.

(3) The convexity property (g.2) is chiefly responsible for the complexity of the tax rules $C^i(m,s)$ as defined by (4.3 a-f). The difficulty arises since the allocation rule $y(\cdot)$ is bounded below by 0 (i.e. negative allocations of public goods are not allowed). Figure 2b below illustrates this problem. For all $m^i > -\sum_{h \neq i} m^h$, $y(m) > 0$, but $y(m) = 0$ for all $m^i \leq -\sum_{h \neq i} m^h$. In the case illustrated, since $-\sum_{h \neq i} m^h < m^{i'}$, the function $D^i(m)^i(y(m),s)$ is not convex in m^i . The alternative illustrated in figure 2a would violate assumption (g.4) since all $m^i \leq -\sum_{h \neq i} m^h$ lead to $y(m) = 0$ and hence must (by (g.4)) yield the same tax $C^i(m,s)$. Thus, we have chosen to convexify $C^i(m,s)$ by defining $D^i(\cdot, y^i(m,s), \cdot)$ as illustrated in figure 2c.

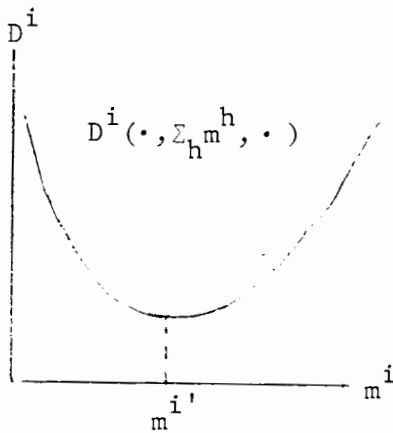

Figure 4.1a

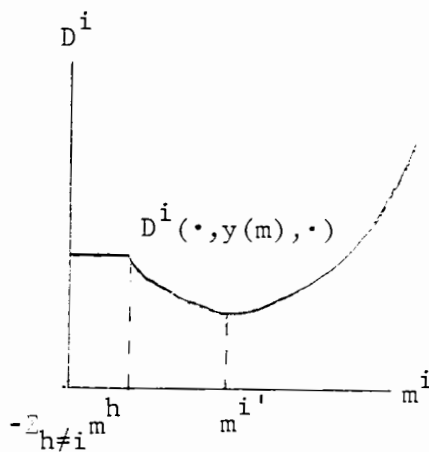

Figure 4.1b

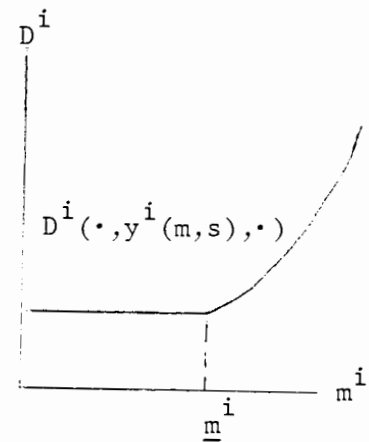

Figure 4.1c

Note: $m^{i'} \equiv \frac{1}{I-1} (\sum_{h \neq i} m^h - \frac{1}{I} q)$, $\underline{m}^i = \text{Max} \{m^{i'}, - \sum_{h \neq i} m^h\}$, and $y^i(m, s) = \text{Max} \{y(m), y(m/\underline{m}^i)\}$.

Proposition 4.6: For every δ , the producer tax rules $\langle R^j(\cdot) \rangle$ satisfy assumptions (h.1)-(h.3).

Proof: Immediate from the definition.

Proposition 4.7: For every δ , the rules of the δ -government satisfy assumption (i).

Proof: By Lemma A.4.4, for every (m, s) , $C^i(m, s) \geq \text{Min} \left\{ \frac{p\omega^i}{p\omega} q \cdot y(m), p\omega^i \right\}$ for all i .

Either (a) $q \cdot y(m) \leq p\omega$, or (b) $p\omega < q \cdot y(m)$.

Case (a): $q \cdot y(m) \leq p\omega$.

In this case $p\omega^i \frac{q \cdot y(m)}{p\omega} \leq p\omega^i$, which implies that $C^i(m, s) \geq \frac{p\omega^i}{p\omega} q \cdot y(m)$.

Summing over i yields $\sum_i C^i(m, s) \geq q \cdot y(m)$. Thus $q \cdot y(m) - \sum_i C^i(m, s) \leq 0$.

Since $R(m, s) = \text{Min} \{q \cdot y(m) - \sum_i C^i(m, s); \text{Max } sZ\}$ and $\text{Max } sZ \geq 0$,

$R(m, s) = q \cdot y(m) - \sum_i C^i(m, s)$.

Case (b): $q \cdot y(m) > p\omega$

In this case, by Lemma A.4.5, $C^i(m, s) > p\omega^i$ unless $m^i \leq \underline{m}^i(m)^i(s)$ in which case $C^i(m, s) = p\omega^i$.

Suppose $C^i(m, s) = p\omega^i$ for every i , i.e. $m^i \leq \underline{m}^i$ for all i .

Claim: $q_k y_k(m) = 0$ for all k .

proof: Suppose not; i.e. suppose $q_k y_k > 0$ for some k . Since $m_k^i \leq \underline{m}_k^i$ for all i and $\underline{m}_k^i = \text{Max} \left\{ - \sum_{h \neq i} m_k^h, \frac{1}{I-1} (\sum_{h \neq i} m_k^h - \frac{1}{I} q_k) \right\}$

if, for any i , $m_k^i = -\sum_{h \neq i} m_k^h$, then $m_k^i \leq -\sum_{h \neq i} m_k^h$ and $y_k(m) = 0$ which is a contradiction.

Thus, for every i , $m_k^i \leq \frac{1}{I-1}(\sum_{h \neq i} m_k^h - \frac{1}{I}q_k)$. Hence $\sum_i m_k^i \leq \sum_i m_k^i - \frac{1}{I-1}q_k$ and thus $0 \leq \frac{1}{I-1}q_k \leq 0$ which implies that $q_k = 0$ which is a contradiction thus completing the proof of the claim.

But if $m^i \leq \underline{m}^i$ for every i , $q \cdot y(m) = 0$ contradicting the premise of Case (b) that $q \cdot y(m) > p\omega \geq 0$.

Hence, for at least one i and one k , $m_k^i \geq \underline{m}_k^i(m^i, s)$ and hence $C^i(m, s) > p\omega^i$ by Lemma B.4.4.

Thus, $\sum_i C^i(m, s) > p\omega$. But since $C^i(m, s) \leq p\omega^i + \sum_j \theta^{ij} \Pi^j(m, s)$ for all i ,

$$0 < \sum_i C^i(m, s) - p\omega \leq \Pi^j(m, s) = \text{Max } sZ - R(m, s).$$

Hence $R(m, s) \neq \text{Max } sZ$ which implies that $R(m, s) = q \cdot y(m) - \sum_i C^i(m, s)$.

This completes the proof of Proposition 4.7. \square

Propositions (4.3) - (4.7) verify all the assumptions of the existence proof for the δ -government. Thus,

Theorem 4.1: For every $\delta = (\underline{\delta}, \bar{\delta})$ such that $I \underline{\delta} < \bar{\delta}$ and $\bar{\delta} > u$, there exists a quasi-equilibrium relative to the G-L rules for the message space M_δ (i.e. the δ -government).

The next step is to show that for some δ satisfying the assumptions of Theorem 4.1 a quasi-equilibrium relative to the δ -government is a quasi-equilibrium relative to the G-L government; that is, that the restriction

on the message space can be dispensed with. This is done in the next two propositions.

Proposition 4.8: Let $\alpha = \{ \langle x^i, m^i \rangle, \langle z^j \rangle, s \}$ be a quasi-equilibrium relative to the δ -government such that $m^i < \bar{\delta}$ for all i . Then, α is a quasi-equilibrium relative to the G-L government.

Proof: Suppose the contrary; i.e. α is not a quasi-equilibrium for M (i.e. relative to the G-L government). Then, for some i , $(x^i, m^i) \notin \xi^i(m, s)$ (the quasi-decision correspondence for M). Since $(x^i, m^i) \in \xi_\delta^i(m, s)$ (the quasi-decision correspondence for M_δ), $p x^i + C^i(m, s) \leq w^i(m, s)$ and hence $(x^i, m^i) \in \beta^i(m, s)$ (the budget correspondence for M). Thus, consumer i is not in the m.w.c. for M , i.e. $\text{Min } p x^i + C^i(m/M, s) \neq w^i(m, s)$.

Since $(x^i, m^i) \notin \xi^i(m, s)$ and i is not in the m.w.c., there exists $(x^{i'}, m^{i'}) \in X^i \times M$ with $m^{i'} \notin M_\delta$ such that $p x^{i'} + C^i(m/m^{i'}, s) \leq w^i(m, s)$ and $(x^{i'}, y(m/m^{i'})) \succ_i (x^i, y(m))$.

By Lemma 3.15 we may assume without loss in generality that $m^{i'} \in \bar{M}^i(m)^i(s) \equiv \text{closure } \{ m^{i'} \in M \mid y(m/m^{i'}) > 0 \}$. Also, by Lemma 3.15 if $m^i \notin \bar{M}_\delta^i(m)^i(s) \equiv \text{closure } \{ m^{i'} \in M_\delta \mid y(m/m^{i'}) > 0 \}$, then there exists some $m^{i*} \in \bar{M}_\delta^i(m)^i(s)$ such that $y(m/m^{i*}) = y(m)$ and hence $(x^i, m^{i*}) \in \xi_\delta^i(m, s)$.

Thus,

$(x^{i'}, y(m/m^{i'})) \succ_i (x^i, y(m)) = (x^i, y(m/m^{i*}))$. Also, since $\bar{M}_\delta^i(m)^i(s) \subset \bar{M}^i(m)^i(s)$, both $m^{i'}$ and $m^{i*} \in \bar{M}^i(m)^i(s)$.

Claim 1: Since $m^i < \bar{\delta}$, $m^{i*} < \bar{\delta}$.

Proof: Suppose the contrary, i.e. for some k , $m_k^{i*} = \bar{\delta}$. Then $m_k^{i*} > m_k^i$.

Since $y(m/m^{i*}) = y(m)$ and $y_k(m) = \text{Max} \{ \sum_{h \neq i} m_k^h, 0 \}$ $y_k(m/m^{i*}) = 0$. But this implies that $\sum_{h \neq i} m_k^h + \bar{\delta} \leq 0$. But since $m_k^h \geq -\underline{\delta}$ for all h and $\bar{\delta} > (1-\underline{\delta}) \sum_{h \neq i} m_k^h + \bar{\delta} \geq \bar{\delta} - (1-\underline{\delta})\underline{\delta} > 0$ contradiction, thus proving Claim 1.

Since i is not in m.w.c. in M at (m,s) , $\underline{m}^i(m)^{i'}$, s minimizes $C^i(m/m^{i'}, s)$ by lemma A.4.1 and $\underline{m}^i \in M_\delta$. Thus, by proof of (g.3) (Proposition 4.5) i is not in the m.w.c. in M_δ at (m,s) .

Thus, by lemma A.4.2, $m_k^i \geq \underline{m}_k^i$ for all k such that $y_k(m) > 0$ and since $y(m/m^{i*}) = y(m)$, $m_k^{i*} \geq \underline{m}_k^i$ for all k such that $y_k(m) = y_k(m/m^{i*}) > 0$.

Now, since $m^{i'} \notin M_\delta$, for some k either (a) $m_k^{i'} < -\underline{\delta} \leq m_k^{i*}$ or (b) $m_k^{i'} > \bar{\delta} > m_k^{i*}$.

Consider any k such that $y_k(m/m^{i*}) = 0$. Since $m^{i'} \in \bar{M}^i(m)^{i'}$, $y_k(m/m^{i'} + \epsilon u) > 0$ for all $\epsilon > 0$. Thus $\sum_{h \neq i} m_k^h + m_k^{i'} + \epsilon > 0$.

Since $y_k(m/m^{i*}) = 0$, $\sum_{h \neq i} m_k^h + m_k^{i*} \leq 0$. Hence $m_k^{i'} - m_k^{i*} + \epsilon u > 0$ for all ϵ and thus $m_k^{i'} \geq m_k^{i*} \geq -\underline{\delta}$.

Thus, for all k such that $y_k(m/m^{i*}) = 0$, $m_k^{i'} \geq m_k^{i*} \geq -\underline{\delta}$, and by the above, for all k such that $y_k(m/m^{i*}) > 0$, $\bar{\delta} > m_k^{i*} \geq 0$.

Define $m^i(\lambda) \equiv \lambda m^{i'} + (1-\lambda)m^{i*}$ and $x^i(\lambda) \equiv \lambda x^{i'} + (1-\lambda)x^{i*}$.

Claim 2: For λ sufficiently close to zero, $m^i(\lambda) \in M_\delta$.

Proof: For any k such that $y_k(m/m^{i*}) = 0$, since $m_k^{i'} \geq m_k^{i*} \geq -\underline{\delta}$, and $m_k^{i*} < \bar{\delta}$ by Claim 1, for λ sufficiently small $-\underline{\delta} \leq m_k^i(\lambda) < \bar{\delta}$.

For any k such that $y_k(m/m^{i*}) > 0$, since $m_k^{i*} \geq \underline{m}_k^i > -\underline{\delta}$ by proof of (g.3) (Proposition 4.5), $-\underline{\delta} < m_k^{i*} < \bar{\delta}$. Thus for λ sufficiently small

- $\underline{\delta} < m_k^i(\lambda) < \bar{\delta}$ also, thus proving Claim 2.

Since $y(m/m^{i''})$ is concave on $\bar{M}^i(m)^{i'}(s)$ and m^{i*} and $m^{i'} \in \bar{M}^i$,
 $y(m/m^i(\lambda)) \geq \lambda y(m/m^{i'}) + (1-\lambda)y(m/m^{i*})$.

By convexity of preferences

$$(x^i(\lambda), \lambda y(m/m^{i'}) + (1-\lambda)y(m/m^{i*})) \succ_i (x^i, y(m/m^{i*})) \text{ for all } \lambda > 0.$$

By monotonicity of preferences in y and concavity of $y(m/m^{i''})$ in $m^{i''}$ on $\bar{M}^i(m)^{i'}(s)$,

$$(x^i(\lambda), y(m/m^i(\lambda))) \succeq_i (x^i(\lambda), \lambda y(m/m^{i'}) + (1-\lambda)y(m/m^{i*})).$$

Thus

$$(x^i(\lambda), y(m/m^i(\lambda))) \succ_i (x^i, y(m/m^{i*})) = (x^i, y(m)) \text{ for all } \lambda > 0.$$

Finally, by convexity of $C^i(m/m^{i''}, s)$ in $m^{i''}$, $C^i(m/m^i(\lambda), s) \leq$
 $\lambda C^i(m/m^{i'}, s) + (1-\lambda)C^i(m/m^{i*}, s)$ for all λ , so that $px^i(\lambda) + C^i(m/m^i(\lambda), s) \leq w^i(m, s)$
since $(x^{i'}, m^{i'})$ and $(x^i, m^{i*}) \in \beta^i(m, s)$.

Since $m^i(\lambda) \in M_\delta$ for λ sufficiently small, for such a λ ,
 $(x^i(\lambda), m^i(\lambda)) \in \beta_\delta^i(m, s)$. But, for all $\lambda > 0$, $(x^i(\lambda), m^i(\lambda)) \succ_i (x^i, y(m/m^{i*}))$.
 However this is a contradiction since $(x^i, m^{i*}) \in \xi_\delta^i(m, s)$ and i is not in
 the m.w.c. at (m, s) in M_δ .

Thus, for every i , $(x^i, m^i) \in \xi^i(m, s)$ and α is a quasi-equilibrium for
 M as well as for M_δ , thus completing the proof of Proposition 4.8. \parallel

Thus, to prove the existence of a quasi-equilibrium for M (i.e. relative
 to the G-L government) we need only show that there exists some $\delta = (\underline{\delta}, \bar{\delta})$ with
 $\bar{\delta} > I\underline{\delta}$ and $\underline{\delta} > 1$ such that if α is a quasi-equilibrium relative to the
 δ -government, then $m^i < \bar{\delta}$ for all i .

Proposition 4.9: Under the assumptions of the existence theorem, there is some $\delta = (\underline{\delta}, \bar{\delta})$ with $\bar{\delta} > I\underline{\delta}$ and $\underline{\delta} > 1$ such that if α is a quasi-equilibrium relative to the δ -government, then $m^i < \bar{\delta}$ for all i .

Proof: Recall that under the assumptions on production, the attainable set of public goods bundles \hat{Y} is bounded. Thus, there exists a vector $\hat{y} \in \mathbb{R}_+^K$ such that $y \leq \hat{y}$ for every $y \in \hat{Y}$. Let

$$\rho_k = \text{Max}_k \{\hat{y}_1, \dots, \hat{y}_K\} \quad \text{and} \quad \rho = (\rho_1, \dots, \rho_K) \in \mathbb{R}^K.$$

Let $\underline{\delta}_k$ be any number greater than 1 and $\underline{\delta} = (\underline{\delta}_1, \dots, \underline{\delta}_K) \in \mathbb{R}^K$. Also, let $\bar{\delta} > \text{Max} \{\underline{\delta}, \rho\} + (I-1)\underline{\delta}$. Clearly $\bar{\delta} > I\underline{\delta}$.

Let α be a quasi-equilibrium for M_δ . Such an α exists by Theorem 4.1. Since $y(m)$ is attainable and $y(m) = \text{Max} \{\sum_{h \neq i} m^h + m^i, 0\}$, $m^i \leq \rho - \sum_{h \neq i} m^h$ for every i . Also, since $m^h \geq \underline{\delta}$ for every h , $m^i \leq \rho + (I-1)\underline{\delta}$ for every i . Thus, $m^i \leq \text{Max} \{\underline{\delta}, \rho\} + (I-1)\underline{\delta} < \bar{\delta}$ for all i .

Thus, we have established the existence theorem.

Theorem 4.2: If consumer characteristics satisfy assumptions (a) - (c) and producers' characteristics satisfy (d.1) - (d.4), then there exists a quasi-equilibrium relative to the G-L government defined by (4.1), (4.2), (4.3a-f), and (4.11) where $M \equiv \mathbb{R}^K$.

IV.3 Pareto Optimality of a Competitive Equilibrium Relative to the G-L Government

In this section we prove the First Fundamental Welfare Theorem for the competitive economy with public goods under the Groves-Ledyard Government.

Theorem 4.3: Let $\{\langle x^{i*}, m^{i*} \rangle_i, \langle z^{j*} \rangle_j, s^*\}$ be a competitive equilibrium relative to the G-L government. If assumptions (b.1) (non-satiation), (b.2) (continuity of preferences), (b.3) (convexity of preferences) are satisfied, and if, in addition.

(4.13) (b.4') for every $y' \geq y$, $y' \neq y$, $\langle x^i, y' \rangle_i > \langle x^i, y \rangle_i$ for all x
for all i (strict monotone preferences in public goods) ,

(4.14) $y^* = y(m^*) > 0$; i.e. all public goods are provided in equilibrium at positive levels; and

(4.15) $\text{Min } p^* X^i + C^i(m^*/M, s^*) < w_i(m^*, s^*)$, i.e. no consumer is in his m.w.c. at (m^*, s^*) ,

then $\{\langle x^{i*}, y(m^*) \rangle_i, \langle z^{j*} \rangle_j\}$ is a Pareto Optimal allocation.

Remark 4.3: It is interesting to note that slightly stronger assumptions on preferences are needed for our theorem than are required to show the analogous theorem for competitive economies with only private goods. Although Debreu also assumes convexity of preferences [5 ,p. 94], all that is required is local non-satiation at an equilibrium. Our proof requires convexity of preferences to ensure the existence of a hyperplane separating a consumer's budget set from his upper contour set. In the Arrow-Debreu model, the upper boundary of the

set is itself the needed separating hyperplane. In our model, since $D^i(m^i(y,s))$ is not linear in y , the boundary of the budget set is not a hyperplane. ^{8/}

Remark 4.4: Assumption (4.14) that positive quantities of every public good are being provided is a crucial one and not merely a technical assumption to avoid consideration of boundary points. Heuristically the reason why it is needed is the following: Suppose for every possible Pareto Optimal allocation for a given economy that positive quantities of all public goods are required. Suppose further that whenever all consumers truthfully reveal their preferences, the government mechanism will select an optimal quantity of public goods (as is the case for our mechanism and many others). Finally, suppose (as is the case for our mechanism, but not for any others of which we are aware) that a consumer never has an incentive to understate his preference for public goods. For our mechanism, however, since the cost to a consumer of the public goods depends on his message only through the quantity being provided and since the quantity provided is bounded below at zero, if some other consumers are sufficiently understating their preferences for public goods, even if consumer i truthfully reveals his preferences, zero quantities may be provided. Thus, if consumer i likewise understates his preferences he will be as well off as if he correctly reveals his preferences. Hence, the situation in which all consumers simultaneously understate the preferences can be an equilibrium but not Pareto Optimal. However, if positive quantities of every public good would be provided when consumer i truthfully reveals his preferences, understating his preferences will (strictly) reduce the quantity provided and lead to a less

desireable outcome for consumer i under our mechanism. Thus, if all public goods would be provided at positive levels if consumer i revealed his preferences truthfully, then he **not** only has no incentive to understate his preferences but he has a strictly positive incentive to truthfully report his preferences.

An obvious corollary to Theorem 4.3 is that if it is not Pareto Optimal to provide any public goods at all, then in equilibrium none will be provided. Furthermore, it can be shown that in this case an equilibrium will yield a Pareto Optimal distribution of private goods. However, this equilibrium may not be the same equilibrium that would result if the possibility of producing public goods were not present - i.e. the Arrow-Debreu equilibrium for the private goods only subset of one economy. This is because some redistribution of initial endowment may take place. But if no public goods would be provided for any $(I-1)$ - subgroup of consumers, then the resulting equilibrium allocation of private goods will coincide with the Arrow-Debreu competitive equilibrium.

These considerations suggest that for a dynamic formulation of our governmental communication and allocation rules, if at the initial point strictly positive quantities of all public goods are proposed and if the dynamic process converges to an equilibrium, then every equilibrium allocation of the process will be Pareto Optimal since it will converge to zero quantities of public goods only if it is optimal. This remark, however, is still a conjecture since we have not yet formulated a dynamic representation of our governmental communication and allocation rules.

Remark 4.5: Assumption (4.15) that no consumer is in his minimum worth condition is required for a reason fundamentally similar to the reason why this condition must be ruled out in proving the existence of a competitive equilibrium in the private goods only economy. In an Arrow-Debreu economy, suppose the only possible relative price for commodity x that will not lead to excess demand for some other commodity is zero. Suppose additionally that consumer i holds as initial endowment only commodity x and that his preferences are strictly monotonic increasing in x . Then at the relative price for x of zero, consumer i will be in his minimum worth condition and furthermore will demand unlimited quantities of x . Hence no equilibrium will exist.^{9/} A quasi-equilibrium does exist, however, since at the zero relative price for x consumer i 's demand set is taken to be his entire budget set which in this case includes his initial endowment point.

In proving the First Fundamental Theorem for the Arrow-Debreu economy, since a true equilibrium is postulated, this circumstance is ruled out. The budget hyperplane separates the budget set from all strictly preferred points so that any preferred point lies strictly above the budget hyperplane.

In our public goods economy, an equilibrium can exist in which the only hyperplane separating the budget set from the preferred points contains strictly preferred points. Thus, although in equilibrium any strictly preferred point must be outside the budget set, since the budget set is strictly convex along the boundary the separating hyperplane may contain strictly preferred points. This, however, will be ruled out when the consumer is not in his minimum worth condition (see lemma 4.5 below).

Proof of Theorem 4.3: In proving this theorem, we proceed by proving several lemmata.

To begin, suppose the equilibrium allocation is not Pareto Optimal. Then, there exists another feasible allocation $\{\langle \hat{x}^i, \hat{y} \rangle \langle \hat{z}^j \rangle\}$ that is at least as desirable for every consumer as the equilibrium allocation and is strictly preferred by at least one consumer:

$$(4.16) \quad (\sum_i (\hat{x}^i - w^i), \hat{y}) = \sum_j \hat{z}^j \in Z, \text{ and}$$

$$(4.17) \quad (\hat{x}^i, \hat{y}) \succ_i (x^{i*}, y^*) \text{ for every } i \text{ with strict preference for at least one } i^0.$$

By Corollary A.4.3, since preferences are strictly monotonic in y (4.13), $y(m^*) > 0$ (4.14), and no consumer is in the m.w.c. at (m^*, s^*) (4.15), $y^i(m^*, s^*) = y(m^*)$ for all i . Thus

$$C^i(m^*, s^*) = D^i(m^i)^i(*, y(m^*), s^*) - \text{Max} \{A^i(m^i)^i(*, s^*), B^i(m^i)^i(*, s^*)\}.$$

Lemma 4.1: $p^* x^{i*} + C^i(m^*, s^*) = w^i(m^*, s^*)$ for every i .

Proof: Suppose not; i.e. for some i , $p^* x^{i*} + C^i(m^*, s^*) < w^i(m^*, s^*)$. By non-satiation (b.1) there exists some $(x^{i'}, y^*) \succ_i (x^{i*}, y^*)$ and by convexity of preferences (b.3), $(x^{i(\lambda)}, y(\lambda)) \succ_i (x^{i*}, y^*)$ for all $\lambda > 0$, $x^{i(\lambda)} \equiv \lambda x^{i'} + (1-\lambda)x^{i*}$ and $y(\lambda) = \lambda y^* + (1-\lambda)y^*$. Since $y^* > 0$ and $y(m^*/m^i)$ is linear on $\bar{M}^i(m^i)^i(*, s^*)$, $y(\lambda) = y(m^*/\lambda m^i) + (1-\lambda)y(m^*/m^i)$ where $y(m^*/\lambda m^i) = y^*$ and $m^i \equiv y^* - \sum_{h \neq i} m_h^*$. Thus, for λ sufficiently close to zero $(x^{i(\lambda)}, y(m^*/\lambda m^i)) \succ_i (x^{i*}, y^*)$, and $p^* x^{i(\lambda)} + C^i(m^*/\lambda m^i, s^*) \leq w^i(m^*, s^*)$ since C^i is convex in m^i , thus contradicting the fact that $(x^{i*}, m^i) \in \bar{\xi}^i(m^*, s^*)$ since i is not in the m.w.c. at (m^*, s^*) .

Lemma 4.2: (a) For every $\bar{y} \in \mathbb{R}_+^K$ there exists some $\bar{m}^i \in M$ such that

$$y(m^*/\bar{m}^i) = \bar{y}.$$

(b) If $(\bar{x}^i, \bar{y}) \succ_i (x^{i*}, y^*)$, then $p \bar{x}^i + C^i(m^*/\bar{m}^i, s^*) \geq w^i(m^*, s^*)$,

(c) If $(\bar{x}^i, \bar{y}) \succ_i (x^{i*}, y^*)$, then $p \bar{x}^i + C^i(m^*/\bar{m}^i, s^*) > w^i(m^*, s^*)$

for every \bar{m}^i such that $y(m^*/\bar{m}^i) = \bar{y}$.

Proof: (a) Let $\bar{m}^i = y - \sum_{h \neq i} m_h^*$. Clearly $\bar{m}^i \in M = \mathbb{R}^K$.

(b) If not, then $p \bar{x}^i + C^i(m^*/\bar{m}^i, s^*) < w^i(m^*, s^*)$ and by the same argument as in the proof of lemma 4.1 there is a preferred point $(x^{i(\lambda)}, m^{i(\lambda)})$ in the budget set contradicting the fact that $(x^{i*}, m^{i*}) \in \xi^i(m^*, s^*)$.

(c) If not, then $(x^{i*}, y^*) \notin \xi^i(m^*, s^*)$ since i is not in the m.w.c.

Lemma 4.3: $D^i(m)^{i*}, \tilde{y}^i(y, m)^{i*}, s^*)$ is differentiable in y at every $y > 0$ where $\tilde{y}^i(y, m)^{i*}, s^*) = \text{Max}\{y, y(m^*/\underline{m}^i)\}$.

Proof: Since D^i is additively separable in y_k for all k , it suffices to prove the lemma for $K = 1$.

$$\text{If } y < y(m^*/\underline{m}^i), \quad \frac{\partial D^i(m)^{i*}, \tilde{y}^i(y, m)^{i*}, s^*)}{\partial y}$$

clearly exists and equals zero.

If $y > y(m^*/\underline{m}^i)$, $\tilde{y}^i(y, m)^{i*}, s^*) = y$ and since $D^i(m)^{i*}, y, s^*)$ is differentiable for every y , $\frac{\partial D^i(m)^{i*}, \tilde{y}^i(y, m)^{i*}, s^*)}{\partial y}$ also exists.

Thus, we only have to show $\frac{\partial D^i(m)^{i*}, \tilde{y}^i(y, s^*)}{\partial y}$ exists at $\tilde{y} = y(m^*/\underline{m}^i)$ if $\tilde{y} > 0$.

Since $\frac{\partial D^i}{\partial y} = 0$ for all $y < y(m^*/\underline{m}^i) = \tilde{y}$, the derivative from the left, $\frac{\partial D^i}{\partial y} = 0$ at $y = y(m^*/\underline{m}^i) = \tilde{y}$.

Since $\tilde{y} = y(m^*/\underline{m}^i) > 0, \tilde{y} = \sum_{h \neq i} m^{h*} + \underline{m}^i = \frac{1}{I-1} [I \sum_{h \neq i} m^{h*} - \frac{1}{I} q]$. Thus,

the derivative from the right $\frac{\partial D^{i+}}{\partial y} \Big|_{\tilde{y}} = \lim_{y \rightarrow \tilde{y}^+} \frac{\partial D^i}{\partial y} = \lim_{y \rightarrow \tilde{y}^+} - (\sum_{h \neq i} m^{h*} - \frac{1}{I} q) + (I-1)y = 0$.

Thus, $\frac{\partial D^i(m^i(*, \tilde{y}(y, m^i(*, s^*)); s^*))}{\partial y}$ exists for all $y > 0$. //

Remark 4.6: In general $\frac{\partial D^i(\cdot, \tilde{y}(y, \cdot), \cdot)}{\partial y}$ does not exist at $y = 0$.

Lemma 4.4: If $(\hat{x}^i, \hat{y}) \succeq_i (x^{i*}, y^*)$ then

$$p^* x^i + D_y^i(m^i(*, y^*, s^*)) \cdot \hat{y} \geq p^* x^{i*} + D_y^i(m^i(*, y^*, s^*)) \cdot y^*$$

where D_y^i is the gradient vector of $D^i(m^i(*, y, s^*))$ with respect to y evaluated at y^* .

Proof: By convexity of preferences,

$A \equiv \{(x^i, y) \in \mathbb{R}^L \times \mathbb{R}_+^K \mid (x^i, y) \succeq_i (x^{i*}, y^*)\}$ is a convex set and (x^{i*}, y^*) is on the boundary of this set by non-satiation (b.1).

Now $D^i(m^i(*, y, s^*)) = - (\sum_{h \neq i} m^{h*} - \frac{1}{I} q^*) y + \frac{1}{2} (I-1)y \cdot y$ is a convex function of y and monotonic increasing on

$$\bar{y} = \{y \in \mathbb{R}^K \mid y \geq \bar{y}\} \text{ where } \bar{y} \text{ minimizes } D^i(m^i(*, y, s^*)) \cdot (\bar{y} = \frac{1}{I-1} (\sum_{h \neq i} m^{h*} - \frac{1}{I} q^*)).$$

Furthermore, $\tilde{y}^i(y, m^i(*, s^*)) = \text{Max}\{y, y(m^*/\underline{m}^i)\}$ is clearly convex in y and $\tilde{y}^i(y, m^i(*, s^*)) \geq \bar{y}$ for all y . Thus, by the lemma in the proof of

(g.2) in Proposition 4.5,

$D^i(m^i(*, \tilde{y}^i(y, m^i(*, s^*)), s^*))$ is a convex function of y . Thus,

$$B \equiv \{(x^i, y) \in \mathbb{R}^L \times \mathbb{R}_+^K \mid p^* x^i + D^i(m^i(*, \tilde{y}^i(y, m^i(*, s^*)), s^*))$$

$$- \text{Max}\{A^i, B^i\} \leq W^i(m^*, s^*)\}$$

is a convex set.

Furthermore, since $D^i(m^i)^i(*, \tilde{y}^i(y^*, m^i)^i(*, s^*), s^*) = D^i(m^i)^i(*, y^*, s^*)$ (since $y^* \geq y(m^*/\underline{m}^i)$ as $m^{i*} \geq \underline{m}^i$), by lemma 4.1, (x^{i*}, y^*) is on the boundary of B.

By lemma 4.2, $(\text{relative interior } A) \cap (\text{relative interior } B) = \emptyset$. Thus, there exists a hyperplane through (x^{i*}, y^*) bounding A from below and B from above.

Since $D^i(m^i)^i(*, \tilde{y}^i(y, m^i)^i(*, s^*), s^*)$ is differentiable at $y^* > 0$, by lemma 4.2, the unique hyperplane bounding B at (x^{i*}, y^*) is defined by the gradient vector $(p^*, D_y^i(m^i)^i(*, y^*, s^*))$ since $y^* = \tilde{y}^i(y^*, m^i)^i(*, s^*)$ and $\frac{\partial \tilde{y}^i}{\partial y} = 1$ at $y = y^*$.

Thus,

$$\begin{aligned} (\hat{x}^i, \hat{y}) \succeq_i (x^{i*}, y^*) \text{ implies } (p^*, D_y^i(m^i)^i(*, y^*, s^*)) \cdot \begin{pmatrix} \hat{x} \\ \hat{y} \end{pmatrix} \geq \\ (p^*, D_y^i(m^i)^i(*, y^*, s^*)) \cdot \begin{pmatrix} x^{i*} \\ y^* \end{pmatrix} \quad . \quad \parallel \end{aligned}$$

Lemma 4.5: If $(\hat{x}^i, \hat{y}) \succ_i (x^{i*}, y^*)$ then

$$p^* \hat{x}^i + D_y^i(m^i)^i(*, y^*, s^*) \cdot \hat{y} > p^* x^{i*} + D_y^i(m^i)^i(*, y^*, s^*) \cdot y^* .$$

Remark 4.7: This lemma requires that consumer i not be in the m.w.c. at (m^*, s^*) . See Remark 4.5 above.

Proof of Lemma 4.5: Suppose the contrary, i.e.

$$p^* \hat{x}^i + D_y^i(m^i)^i(*, y^*, s^*) \cdot \hat{y} = p^* x^{i*} + D_y^i(m^i)^i(*, y^*, s^*) \cdot y^*$$

(Lemma 4.4 implies the equality).

Since i is not in the m.w.c. and $\underline{m}^i(m^i)^i(*, s^*) =$

$\text{Max} \left\{ \frac{1}{I-1} \sum_{h \neq i} m^{h*} - \frac{1}{I} q \right\}, - \sum_{h \neq i} m^{h*} \}$ minimizes $C^i(m^*/m^i, s)$ (by lemma A.4.1),

$(\underline{x}^i, \underline{m}^i) \equiv (0, \underline{m}^i)$ is such that $p^* \underline{x}^i + C^i(m^*/\underline{m}^i, s^*) < p^* x^{i*} + C^i(m^*, s^*) = W^i(m^*, s^*)$.

Thus, $(\underline{x}^i, y) = (\underline{x}^i, y(m^*/\underline{m}^i)) \in \text{interior } B$ (see lemma 4.4) and hence

$$\begin{aligned} p^* \underline{x}^i + D_y^i(m^i)^i(*, y^*, s^*) \cdot \underline{y} &< p^* x^{i*} + D_y^i(m^i)^i(*, y^*, s^*) \cdot y^* \\ &= p^* \hat{x}^i + D_y^i(m^i)^i(*, y^*, s^*) \cdot \hat{y}. \end{aligned}$$

Now define

$$x^i(\lambda) \equiv \lambda \hat{x}^i + (1-\lambda) \underline{x}^i \quad \text{and} \quad m^i(\lambda) \equiv \lambda \hat{m}^i + (1-\lambda) \underline{m}^i \quad \text{where} \quad \hat{m}^i \equiv \hat{y} - \sum_{h \neq i} m^{h*}.$$

Claim: $y(m^*/m^i(\lambda)) = \lambda y(m^*/\hat{m}^i) + (1-\lambda)y(m^*/\underline{m}^i) \equiv y(\lambda)$.

Proof: Straightforward

Thus,

$$p^* x^i(\lambda) + D_y^i(m^i)^i(*, y^*, s^*) \cdot y(\lambda) < p^* x^{i*} + D_y^i(m^i)^i(*, y^*, s^*) \cdot y^* \quad \text{for all } \lambda < 1.$$

Hence $(x^i(\lambda), y(\lambda)) \neq (x^{i*}, y^*)$ for any λ since $(x^i(1), y^i(1)) = (\hat{x}^i, \hat{y})$.

But since

$$\{(x^i(\lambda), y(\lambda)) \mid (x^i(\lambda), y(\lambda)) \succeq_i (x^{i*}, y^*)\} \quad \text{and}$$

$$\{(x^i(\lambda), y(\lambda)) \mid (x^i(\lambda), y(\lambda)) \preceq_i (x^{i*}, y^*)\} \quad \text{are non-empty compact sets whose}$$

union is the line $\{(x^i(\lambda), y(\lambda)) \mid 0 \leq \lambda \leq 1\}$ their intersection is non-empty.

Let $\tilde{\lambda}$ be such that $(x^i(\tilde{\lambda}), y(\tilde{\lambda}))$ is in their intersection. Thus,

$$(x^i(\tilde{\lambda}), y(\tilde{\lambda})) \sim_i (x^{i*}, y^*) \quad \text{where } 0 < \tilde{\lambda} < 1.$$

But $p^* x^i(\tilde{\lambda}) + D_y^i(m^i)^i(*, y^*, s^*) \cdot y(\tilde{\lambda}) < p^* x^{i*} + D_y^i(m^i)^i(*, y^*, s^*) \cdot y^*$. Also, the

hyperplane defined by the vector (p^*, D_y^i) through (x^{i*}, y^*) bounds

$\{(x^i, y) \mid (x^i, y) \succeq_i (x^{i*}, y^*)\}$ from below. Thus,

$$p^* x^i(\tilde{\lambda}) + D_y^i(m^i)^i(*, y^*, s^*) \cdot y(\tilde{\lambda}) \geq p^* x^{i*} + D_y^i(\cdot) \cdot y^*$$

which is a contradiction.

Hence, $p^* \hat{x}^i + D_y^i \hat{y} > p^* x^{i*} + D_y^i y^*$, completing the proof of lemma 4.8.

Returning to the direct proof of Theorem 4.3, applying lemmata 4.4 and 4.5 to $\langle \hat{x}^i, \hat{y} \rangle_i$ of (4.17), we have

$$p^* \sum_i \hat{x}^i + \sum_i D_y^i (m^i)^i(*, y^*, s^*) \cdot \hat{y} > p^* \sum_i x^{i*} + \sum_i D_y^i (m^i)^i(*, y^*, s^*) \cdot y^*$$

By the definition of D^i

$$D_y^i (m^i)^i(*, y^*, s^*) = - (I \sum_{h \neq i} m^{h*} - \frac{1}{I} q^*) + (I-1)y^* \quad \text{for all } i.$$

Thus

$$\sum_i D_y^i (m^i)^i(*, y^*, s^*) = - I(I-1) \sum_i m^{i*} + q^* + I(I-1)y^* = q^*$$

since $y^* > 0$ implies $y^* = \sum_i m^{i*}$. Thus

$$p^* \sum_i \hat{x}^i + q^* \hat{y} > p^* \sum_i x^{i*} + q^* y^* \quad \text{and}$$

$$p^* \sum_i (\hat{x}^i - w^i) + q^* \hat{y} - R(m^*, s^*) > p^* \sum_i (x^{i*} - w^i) + q^* y^* - R(m^*, s^*) \quad \text{or, by (4.16)}$$

$$(p^*, q^*) (\sum_j \hat{z}^j) - R(m^*, s^*) > (p^*, q^*) (\sum_j z^{j*}) - R(m^*, s^*)$$

contradicting the fact that z^{j*} maximizes $(p^*, q^*) z^j - R(m^*, s^*)$ over all $z^j \in Z^j$. This completes the proof of Theorem 4.3.

IV.4: A Pareto Optimum is an Equilibrium Relative to the Groves-Ledyard Government

In this section we prove the Second Fundamental Welfare Theorem for the competitive economy under the Groves-Ledyard Government.

Theorem 4.4: Let $\{(x^{i*}), y^*, (z^{j*})\}$ be a Pareto Optimal allocation for the economy \mathcal{E} . If assumptions (b.1) - (b.4), (d.1), (d.2) and (d.3) are satisfied, and if, in addition

$$(4.18) \quad \sum_i w^i > 0, \quad y^* > 0, \quad \text{and}$$

for each i , $(x^i, y) > (x^{i*}, y^*)$ implies $(x^i, y) \succ_i (x^{i*}, y^*)$, then there exists an $(I+1)$ -tuple of messages and prices $(\langle m^{i*} \rangle_i, s^*) \in M^I \times S$ such that $(\langle x^{i*}, m^{i*} \rangle, \langle z^{j*} \rangle, s^*)$ is a competitive equilibrium relative to the Groves-Ledyard government following, if necessary, a redistribution of initial endowments and profit shares.

Proof: By a slight revision of Foley's Theorem [9, p. 68], it is easy to show that there exists an $(I+1)$ -tuple of "prices" $(s, \langle \tilde{t}^i \rangle_i) \in S \times (\mathbb{R}_+^{L+K})^I$ such that $(\langle x^{i*} \rangle, \langle z^{j*} \rangle, y^*, s, \langle \tilde{t}^i \rangle)$ is a Lindahl equilibrium following, if necessary, a redistribution of initial endowments and profit shares. That is,

$$(4.19a) \quad \tilde{s} z^{j*} = \max_j \tilde{s} z^j \quad \text{for all } j$$

$$(4.19b) \quad (x^{i*}, y^*) \text{ is } \tilde{z}^i \text{-maximal on}$$

$$\{(x^i, y) \in \mathbb{R}^{L+K} \mid p x^i + \tilde{t}^i y \leq p w^i + \sum_j \theta^{ij} \tilde{s} z^{j*}\}$$

$$(4.19c) \quad \tilde{q} = \sum_i \tilde{t}^i$$

$$(4.19d) \quad \tilde{\theta}^{ij} = \tilde{\theta}^i = \tilde{t}^i y^* / q y^* \quad \text{and} \quad \tilde{\omega}^i = x^{i*} - \tilde{\theta}^i z_1^* .$$

By strict monotonicity and non-satiation, $\tilde{s} \gg 0$, $\tilde{t}^i \gg 0$ and since $y^* \neq 0$, $\tilde{\theta}^i$ is well-defined.

Let $m^{i*} = [y^* + \tilde{t}^i - (q/I)]/I$ and let $s^* = \tilde{s}$. We note first that

$$(4.20) \quad y^* = \sum_i m^{i*}$$

since $\sum_i m^{i*} = y^* + (\sum_i \tilde{t}^i - q)/I = y^*$.

Secondly, it is obvious that for every j

$$(4.21) \quad s^* z^{j*} = \max s^* z^j - R_2^j(m^*, s^*).$$

Therefore, (b), (c), and (d) of Definition 2.5 are satisfied. It remains to show that there are endowments ω^{i*} and shares θ^{ij*} such that Definition 2.5(a) is satisfied.

Define the real-valued function $\theta^i: \mathbb{R}^{I \cdot L} \rightarrow \mathbb{R}$ by

$$(4.22) \quad \theta^i(\langle \omega^i \rangle) \equiv C^i(m^*, s^*; \omega^i) / \sum_h C^h(m^*, s^*; \omega^h)$$

Since \tilde{t}^i are strictly monotonic, $\tilde{s} = s^* \gg 0$. Therefore, $p^*_{\omega} > 0$ and $q^*_{y^*} > 0$. Let $\epsilon = \min \{p^*_{\omega}, q^*_{y^*}\}$. By Lemma A.4.4, $\sum_h C^h(m^*, s^*; \omega^h) \geq \epsilon$.

Therefore, $\theta^i(\langle \omega^i \rangle)$ is a continuous, well-defined function. (Continuity in ω^i follows from the obvious continuity of C^h in ω^h for all h).

Claim: There exist $\omega^{i*}, \theta^{ij*}$ for all i and j such that $\theta^{ij*} = \theta^i(\langle \omega^{i*} \rangle)$ and $\omega^{i*} = x^{i*} - \theta^i(\langle \omega^{i*} \rangle) z_1^* \cdot \frac{10}{I}$

Proof: Since $0 \leq \theta^i(\langle \omega^i \rangle) \leq 1$ for all $\langle \omega^i \rangle \in \mathbb{R}^{L \cdot I}$, it follows that

$x^{i*} - |z_1^*| \leq x^{i*} - \theta^i(\langle w^i \rangle) z_1^* \leq x^{i*} + |z_1^*|$ for all $\langle w^i \rangle$. Let k be the radius of a cube centered at zero that contains in its interior the set of attainable states. (Such a cube exists since the attainable states is a compact set.) Then $-2ku < x^{i*} - \theta^i(\langle w^i \rangle) z_1^* < 2ku$ (where $u = (1, \dots, 1) \in \mathbb{R}^L$) for all $\langle w^i \rangle$. Let $W = \{\langle w^i \rangle \in \mathbb{R}^{L \cdot I} \mid -2k \leq w_\ell^i \leq 2k \text{ for all } i, \ell, \text{ and } \sum_i w^i = \omega\}$. W is compact, convex, and non-empty. Let $f^i(\langle w^i \rangle) = x^{i*} - \theta^i(\langle w^i \rangle) z_1^*$ for all i . $f \equiv (f^1, \dots, f^I)$ is a continuous function from W to W since $\sum_i f^i(\omega) = \sum_i x^{i*} - z_1^* \sum_i \theta^i(\omega) = \sum_i x^{i*} - z_1^* = \omega$. Hence, by Brower's Fixed Point Theorem, there exists a $\langle w^{i*} \rangle$ such that $\langle w^{i*} \rangle = f(\langle w^{i*} \rangle)$ and the claim is established.

We next show that, for each i ,

$$(4.23) \quad p^* w^{i*} + \sum_j \theta^{ij*} \Pi^j(m^*, s^*) = p^* x^{i*} + C^i(m^*, s^*; w^{i*}).$$

This follows since

$$\begin{aligned}
 p^* w^{i*} + \sum_j \theta^{ij*} \Pi^j(m^*, s^*) &= p^* x^{i*} - \theta^{i*} p^* z_1^* + \theta^{i*} [p^* z_1^* + q^* z_2^* - R^*] \\
 &= p^* x^{i*} + \theta^{i*} (q^* y^* - R^*) \quad \text{where } R^* \equiv \sum_j R_2^j(m^*, s^*).
 \end{aligned}$$

But, by (4.11ii), $R^* \leq q^* y^* - \sum_i C^i(m^*, s^*)$. Therefore,

$$p^* w^{i*} + \sum_j \theta^{ij*} \Pi^j(m^*, s^*) \geq p^* x^{i*} + \theta^{i*} (\sum_h C^h(m^*, s^*; w^{h*})) = p^* x^{i*} + C^i(m^*, s^*; w^{i*}).$$

But by Proposition 4.7 it follows that $R^* + \sum_h C^h(m^*, s^*; w^{h*}) = q^* y^*$. Therefore

(4.23) holds for all i .

It remains to establish that $(x^{i*}, y(m^*)) \succ_i (x^i, y(m^*/m^i))$ for all $(x^i, m^i) \in B \equiv \{(x^i, m^i) \in \mathbb{R}^L \times M \mid p^* x^i + C^i(m^*/m^i, s^*; w^{i*}) \leq p^* x^{i*} + C^i(m^*, s^*; w^{i*})\}$.

By the convexity of C^i in m^i , B is a convex set and $(x^{i*}, m^{i*}) \in \text{Boundary } B$.

Let $B^* \equiv \{(x^i, y) \in \mathbb{R}^{L+K} \mid (x^i, y) = (x^i, y(m^*/m^i)) \text{ for some } (x^i, m^i) \in B\}$.

We will show that $B^* \subseteq B^L = \{(x^i, y) \mid p^* x^i + \tilde{t}^i y \leq p^* x^{i*} + \tilde{t}^i y^*\}$ which will imply by (4.19b), that $(x^{i*}, m^{i*}) \in \delta^i(m^*, s^*)$ given the endowments w^{i*} and profit shares θ^{ij*} and thus complete the proof of Theorem 4.4.

To establish that $B^* \subseteq B^L$, it suffices to show that if $(x^i, y) \in B^*$, then $p^* x^i + \tilde{t}^i y \leq p^* x^{i*} + \tilde{t}^i y^*$. Now $(x^i, y) \in B^*$ if and only if $p^* x^i + D^i(m^i)(x^i, y(m^*/m^i), s^*) \leq p^* x^{i*} + D^i(m^i)(x^{i*}, y(m^*, s^*), s^*)$. But, as defined in (4.3c) $y^i(m^*, s^*) = \text{Max}\{y(m^*), y(m^*/m^i)\} = \text{Max}\{y^*, \max\{y^* - \frac{1}{I-1} \tilde{t}^i, 0\}\}$. But, since $\tilde{t}^i > 0$ and $y^* > 0$, it follows that $y^i(m^*, s^*) = y^* \geq y(m^*/m^i)$. Now, consider $\partial^+ D^i(m^i)(x^i, y(m^*/m^i), s^*) / \partial y$ as defined in Lemma 4.3 evaluated at $y = y^* \cdot \frac{11}{1}$. Since $\sum_{h \neq i} m^{h*} = y^* - m^{i*}$, it is easy to see that

$$\partial^+ D^i / \partial y \Big|_{y=y^*} = - (I \sum_{h \neq i} m^{h*} - \frac{1}{I} q^*) + (I-1)y^* = \tilde{t}^i.$$

But B^* is a convex set since D^i is convex in y (see proof of Lemma 4.4) and therefore, $(p^*, \partial^+ D^i / \partial y \Big|_{y=y^*})$ is the normal to a supporting hyperplane to B^* through (x^{i*}, y^*) . Therefore, if $(x^i, y) \in B^*$, then $p^* x^i + (\partial^+ D^i / \partial y) \cdot y = p^* x^i + \tilde{t}^i y \leq p^* x^{i*} + \tilde{t}^i y^* = p^* x^{i*} + (\partial^+ D^i / \partial y) \cdot y^*$. This establishes the theorem.

Remark 4.8 : A corollary to Theorem 4.4 is that any Pareto Optimal allocation that can be supported by positive Lindahl prices such that $\sum_1 w^i$ and y^* are non-negative and positive, is a competitive equilibrium relative to the Groves-Ledyard government following, if necessary, a redistribution of initial endowments and profit shares. Theorems 4.3 and 4.4 together imply that any Lindahl equilibrium (with $y \neq 0$) can be a competitive equilibrium relative to the Groves-Ledyard government and conversely - however, in general, a redistribution of resources must occur. That is, given the same initial endowments, the Lindahl allocation will be different than the Groves-Ledyard equilibrium allocation.

IV.5 A Simple Illustrative Example

In this section a particularly elementary example of the general equilibrium model with public goods and the Groves-Ledyard government is examined. In this specific example, many of the complicating features of the general model are avoided, thereby allowing attention to be directed to the central issue of the incentive properties of the G-L government or why the G-L rules solve the Free Rider problem.

We consider an environment with one private and one public commodity. Production is characterized by constant returns to scale with the (aggregate) production set Z given by:

$$Z = \{(z_1, z_2) \in \mathbb{R}^2 \mid z_1 + z_2 \leq 0, z_1 \leq 0, z_2 \geq 0\}.$$

(Thus, one unit of private good is required to produce each unit of the public good.) There is assumed to be a single firm.

The I consumers are each characterized by an initial endowment $(\omega^i, 0) \in \mathbb{R}^2$, the consumption set $X^i \equiv \mathbb{R}_+^2$, and the specific utility function u^i :

$$u^i(x^i, y) = x^i + \alpha^i \ln y.$$

We assume throughout that

$$\sum_i \omega^i > \sum_i \alpha^i$$

so that (as is easily verified) there is a unique interior Pareto-optimal level of public good consumption y^* where

$$y^* = \sum_i \alpha^i.$$

In order to emphasize those aspects of the G-L government rules that lead to the selection in equilibrium of optimal allocations, we ignore those features introduced to avoid boundary problems (e.g. consumer/producer bankruptcy and zero levels of public goods). Also, with the given production technology specified, equilibrium prices must be such that $p = q$. Thus, we will assume throughout that $p = q = 1$ ^{12/} We may thus restate the G-L rules defined by (4.1) - (4.3a-f) as:

$$(4.24a) \quad M = \mathbb{R}$$

$$(4.24b) \quad y(m) = \sum_i m^i$$

$$(4.24c) \quad C^i(m) = -(\sum_{h \neq i} m^h - \frac{1}{I}) \sum_h m^h + \frac{I-1}{2} (\sum_h m^h)^2 + T^i(m)^i()$$

where $T^i(m)^i()$ is a number depending only on the messages of consumers $h \neq i$.

Under these rules a competitive consumer i will choose m^i to maximize

$$\begin{aligned} u^i &= \omega^i - C^i(m/m^i) + \alpha^i \ln y(m) \\ &= \omega^i + (\sum_{h \neq i} m^h - \frac{1}{I}) \sum_h m^h - \frac{I-1}{2} (\sum_h m^h)^2 - T^i(m)^i() + \alpha^i \ln(\sum_h m^h). \end{aligned}$$

Given $T^i(m)^i()$, m^i will thus be chosen to satisfy the first order condition

$$(4.25) \quad (\sum_{h \neq i} m^h - \frac{1}{I}) - (I-1)(\sum_h m^h) + \frac{\alpha_i}{\sum_h m^h} = 0.$$

At a competitive equilibrium, $(\hat{m}^1, \dots, \hat{m}^I) = \hat{m}$, equation (4.25) holds for all i .

Thus, summing over all i implies that

$$(4.26) \quad \sum_i \hat{m}^i = \sum_i \alpha^i.$$

Therefore, since $y(\hat{m}) = \sum_i \hat{m}^i = \sum_i \alpha^i = y^*$, the competitive equilibrium is

Pareto-optimal as was proved in Theorem 4.3.

Since each utility function is described by one parameter α^i , a natural question is whether or not the message m^i might be interpreted as communicating the value of α^i . For the rules given by (4.24 a-c), the answer is no, since in equilibrium \hat{m}^i does not equal α^i although the optimal quantity of public good y^* is chosen and $\sum_i \hat{m}^i = \sum_i \alpha^i = y^*$. Furthermore, since (from equation (4.25)) \hat{m}^i depends not only on α^i but also on \hat{m}^j (there is no obvious way to transform \hat{m}^i independently of \hat{m}^j so that its transformed value equals α^i). However, by altering the consumers' taxing rules, it is possible, for the environments of our special example, to preserve the Pareto-optimality of an equilibrium while simultaneously adding the property that, for any \hat{m}^j , the best message i can send is $m^i = \alpha^i$.

Suppose, specifically, that

$$(4.27a) \quad M = \mathbb{R}$$

$$(4.27b) \quad y(m) = \sum_i m^i$$

$$(4.27c) \quad \hat{C}^i(m) = (\sum_h m^h) - (\sum_{h \neq i} m^h) \ln(\sum_h m^h) + T^i(m^i).$$

Under these rules, the first order condition for the optimal message m^i is:

$$-1 + \frac{\sum_{h \neq i} m^h}{\sum_h m^h} + \frac{\alpha_i}{\sum_h m^h} = 0$$

which easily reduces to $\hat{m}^i = \alpha^i$! Thus, in these quite special environments and under the rules (4.27), the messages m^i may be interpreted as the reported utility parameter and the true parameter α^i is always the optimal response, independent of the messages of the other consumers.

It is interesting to examine why under one set of taxing rules (4.24), the optimal messages (best replay responses) are not independent of other consumers' messages while under another set of rules (4.27) the optimal messages are independent.

To explain this result we note that both (4.24) and (4.27) are members of a very general class of government rules (allocation and consumer tax rules) that yield Pareto-optimal competitive allocations. Consider the following rules:

$$(4.28a) \quad M = \mathbb{R}^T \quad \text{where } T \text{ is some integer } \geq 1;$$

$$(4.28b) \quad y(m,s) \text{ is the solution to the problem:}$$

Maximize w.r.t. y , $\sum_i f^i(m^i, y, s) - q \cdot y$ where f^i is some given function from $M \times \mathbb{R}^K \times \mathbb{R}^{L+K}$ to \mathbb{R} ;

$$(4.28c) \quad C^i(m,s) = q \cdot y(m,s) - \sum_{h \neq i} f^h(m^h, y(m,s), s) + T^i(m)^i(s)$$

where $T^i(m)^i(s)$ is a number independent of m^i .

If the functions f^i are chosen with sufficient continuity and convexity and preferences are representable by sufficiently smooth and convex utility functions it is easy to show that a competitive consumer i will choose his message \hat{m}^i , given the messages $m^{)i(}$ of other consumers, so that his true marginal rate of substitution of y for x^i equals $\partial f^i / \partial y$ at the point $(\hat{m}^i, y(m/\hat{m}^i, s), s)$ and that, therefore, an equilibrium will be Pareto-optimal. Thus, there is a broad class of government rules that yield Pareto-optimal competitive equilibria.

However, in order to prove the existence of a competitive equilibrium relative to such government rules for the general model of Section II, we were aided considerably by letting $f^i(m^i, y, s) = (Im^i + \frac{1}{I}q) \cdot y - \frac{1}{2} y \cdot y$. It is straightforward to verify that this choice of $f^i(\cdot)$ yields the rules of

of equation (4.24) from the rules of equations (4.28) when $M = \mathbb{R}^K$.

The rules of equations (4.27) result from (4.28) if $f^i(m^i, y, s) = m^i \ln y$ where $M = \mathbb{R}$. The reason why m^i , in this case, may be identified with α^i is that $f^i(\alpha^i, y, s)$ is the integral of the true marginal rate of substitution of y independently of x^i , and, therefore, of m^i . This leads us to conjecture that if the class of consumers' utility functions is parametrizable by a finite dimensional vector and if each utility function of the class is additively separable (i.e. $u^i(x^i, y) = u^{1i}(x^i, \theta^{1i}) + u^{2i}(y, \theta^{2i})$) then the rules of (4.28) when $f^i(\cdot) = u^{2i}(y, m^i)$ will lead to competitive equilibrium messages \hat{m}^i such that $\hat{m}^i = \theta^{2i}$ for all i . Additionally, $\hat{m}^i = \theta^{2i}$ will be consumer i 's best replay message to any m^i .

Contrarywise, if the utility functions of consumers are not additively separable in public goods consumption, then consumer i 's best replay message will, in general, depend on the messages of the other consumers, m^i with the "true" parameter θ^i even though, in equilibrium, a Pareto-optimal allocation of resources will occur.

An explanation of the importance of additive separability is that, under the rules of the form (4.28), the message m^i simultaneously conveys information about both the consumer's desired level of public goods output and his marginal rate of substitution at that output level. For example, consider figure 4.2 based on the environments with $u^i = x^i + \alpha^i \ln y$ and the rules (4.27).

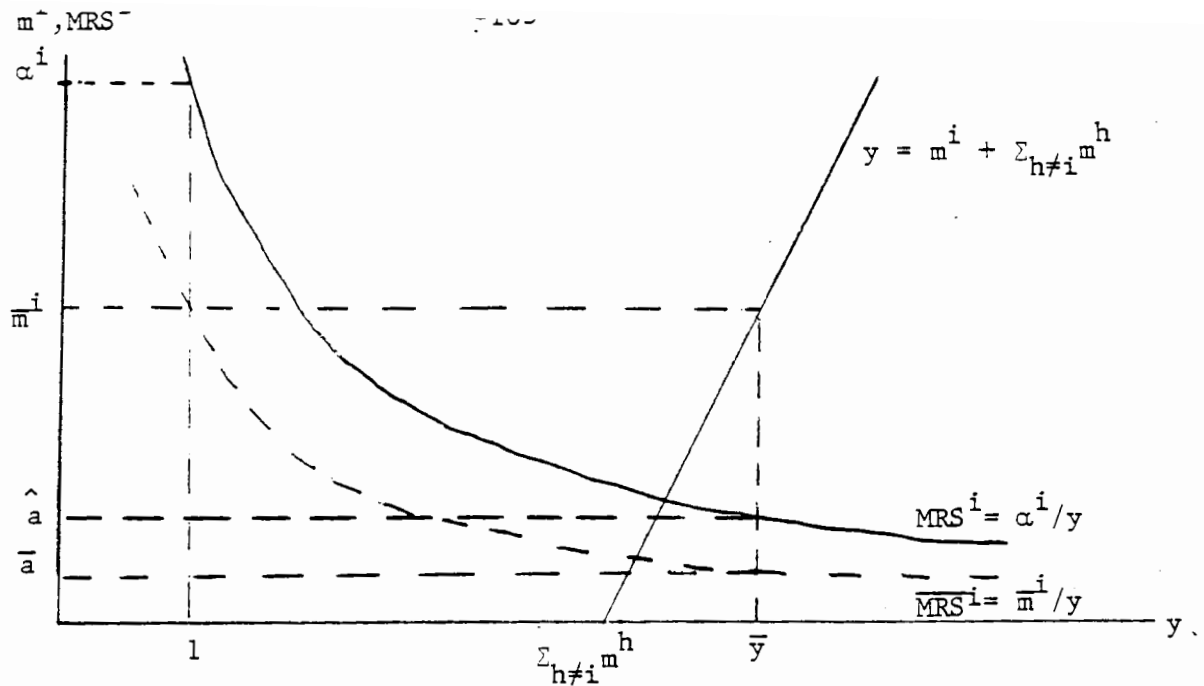

Figure 4.2

If consumer i sends the message \bar{m}^i then \bar{y} is selected by the allocation rule $y(m, s) = \sum_h m^h$. Also, if \bar{m}^i is i 's reported utility parameter, then he is acting as if his MRS curve is $\bar{m}^i / y = MRS^i$. That is, he is conveying the value of his MRS at \bar{y} , which is \bar{a} in this example. Noting that his "true" MRS at \bar{y} is \hat{a} and recognizing from (4.27c) that his marginal (tax) cost of an increase in y by an increase in m^i is $(m^i / \bar{y}) = \bar{a}$ which is less than his marginal benefit, \hat{a} , it follows that \bar{m}^i is not his best message. Figure 4.3 illustrates the configuration appropriate to an optimal message.

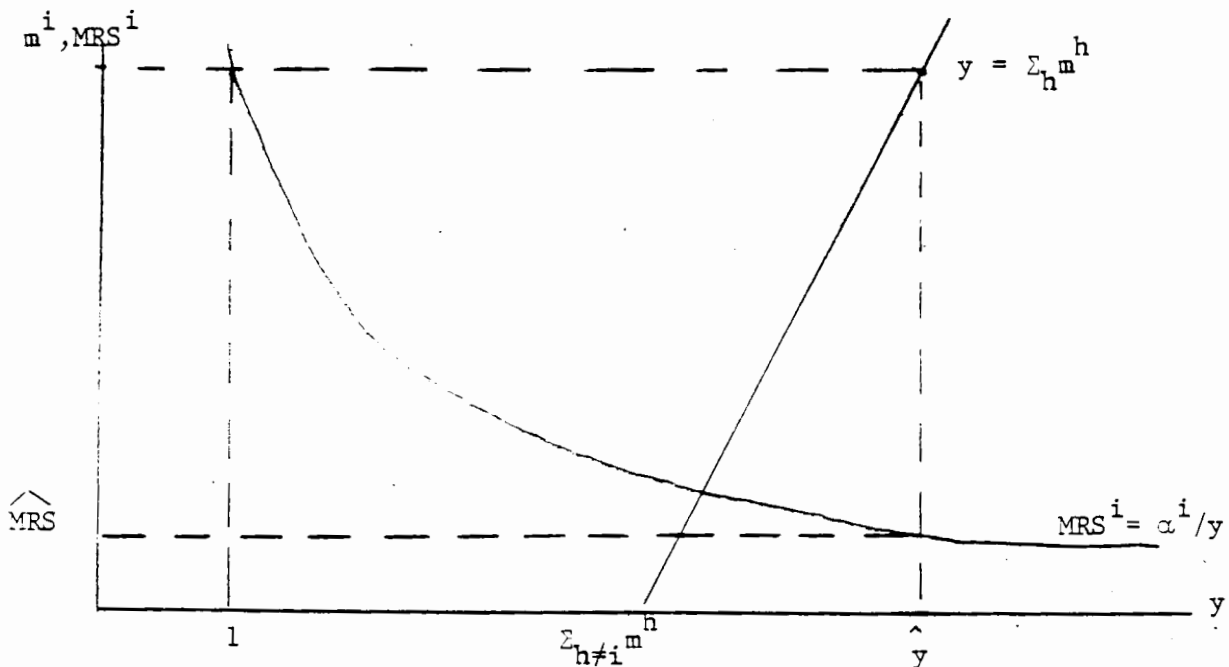

Figure 4.3

At $\hat{m}^i = \alpha^i$, $\hat{m}^i/\hat{y} = \alpha^i/\hat{y}$, and by sending \hat{m}^i i is reporting, in effect, his desired y , \hat{y} , and his "true" marginal rate of substitution, \hat{MRS} , with the single number \hat{m}^i .

If we consider, instead of the rules (4.27), the G-L rules (4.24), we have Figure 4.4:

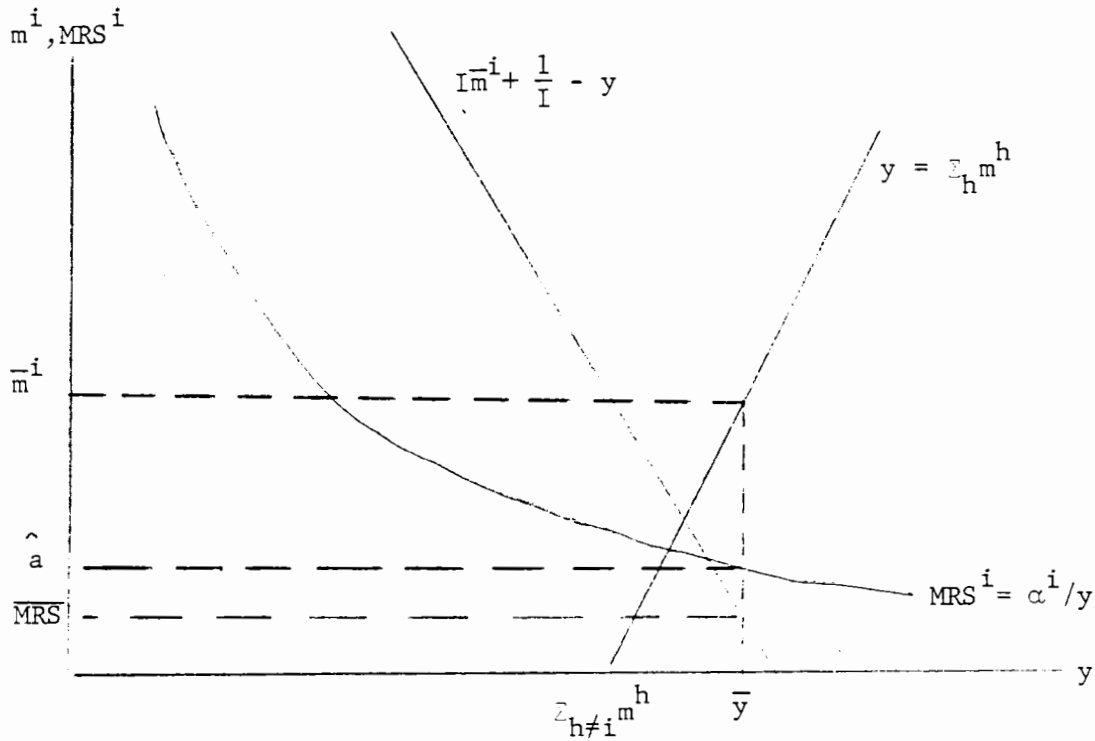

Figure 4.4

Given a message \bar{m}^i , the level of public goods will be \bar{y} . The "reported" marginal rate of substitution is $(I\bar{m}^i + \frac{1}{I}) - \bar{y} = \overline{MRS}$ which may be located by intersecting the line with slope -1 and intercept $(I\bar{m}^i + \frac{1}{I})$ and the vertical line at \bar{y} . As in figure 4.1, here $\overline{MRS} < \hat{a}$ - the "true" MRS at \bar{y} . Also, as in figure 4.1, the marginal cost to i of increasing y at \bar{y} by increasing m^i is $(I-1)\bar{y} - (I\sum_{h \neq i} m^h - \frac{1}{I}) = (I\bar{m}^i + \frac{1}{I}) - \bar{y} = \overline{MRS}$ which again is less than the marginal gain \hat{a} . Therefore, \bar{m}^i is not i 's best response in this situation.

In Figure 4.5, the configuration for i 's best response to m^i is depicted.

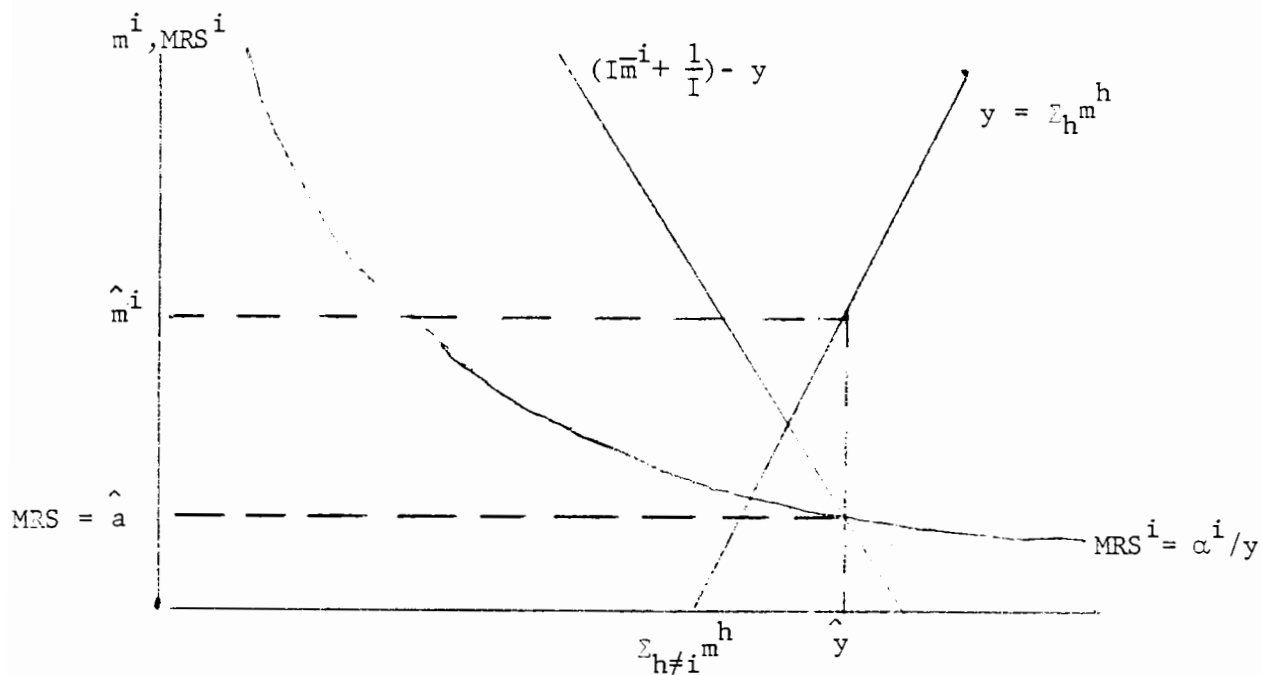

Figure 4.5

In general, there will be a unique \hat{m}^i for each m^i since the vertical coordinates \hat{m}^i and $(I\hat{m}^i + \frac{1}{I}) - y$ cannot be chosen independently. At the best replay message, \hat{m}^i , the true MRS, $\widehat{MRS} = \alpha^i / \hat{y}$. However, one cannot infer i 's MRS at any other level of y from the message \hat{m}^i , unless it is known a priori that $u^i = x^i + a^i \ln y$ for some α^i . Also, as noted earlier, $\hat{m}^i \neq \alpha^i$.

In Figure 4.6, the general situation is depicted for a best replay message for the G-L rules (4.24) when the utility function is not additively separable.

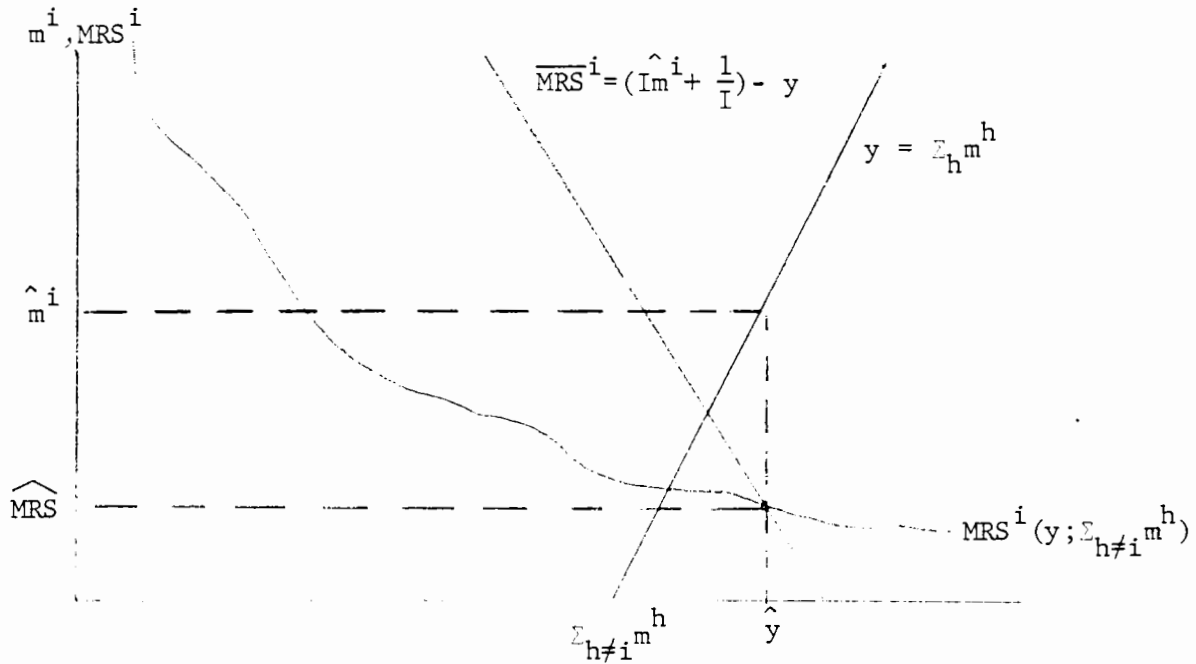

Figure 4.6

In this case, since the utility function is not additively separable, the function $MRS^i(y; \sum_{h \neq i} m^h)$ will generally depend on $\sum_{h \neq i} m^h$ since it will depend on x^i and therefore on $\omega^i - C^i(m)$. It is also not generally hyperbolic. However, in this case as for Figure 4.5, \bar{m}^i conveys information given $m^i(\cdot)$, about the desired y , \hat{y} , and the "true" MRS, \widehat{MRS}^i , and also the "reported" marginal rate of substitution, \overline{MRS}^i , is equal to the "true" MRS at \hat{y} when \hat{m}^i is the optimal response given $m^i(\cdot)$. Thus, if $\hat{m} = (\hat{m}^1, \dots, \hat{m}^I)$ is an equilibrium (i.e. each is a best response given the others), the sum of the true marginal rates of substitutions equals the sum of the reported MRS's, $\sum_h \hat{m}^h + 1 - \hat{y} = 1$ ($=\hat{q}$, here), which equals the true marginal rate of transformation. Hence, an equilibrium is Pareto-optimal.

Finally, as promised in Section II, Example 2.3, we show that for the class of environments described in this section the Lindahl government produces equilibria at which each consumer is understating his true preferences and less than optimal quantities of the public good is provided.

To simplify the example, let M be the space of all functions from \mathbb{R}_+ to \mathbb{R}_+ of the form $m^i(y) = a^i/y$. The true message (described on p. 22) is $\overset{\circ}{m}^i(y) = \alpha^i/y$, and, therefore, belongs to this set. The allocation rule, Example 2.3, a, reduces to $y = \sum_i a^i$ and the consumer tax rule becomes $C^i = a^i/y(m) \cdot y(m) = a^i$. Thus, each consumer chooses \bar{a}^i to maximize $\omega^i - a^i + \alpha^i \ln \sum_h a^h$. Thus, he selects $\bar{a}^i = \alpha^i - \sum_{h \neq i} a^h$ and sends $\bar{m}^i(y) = \bar{a}^i/y$. Note that $\bar{a}^i < \alpha^i$ and therefore \bar{m}^i represents an underreporting of i 's true MRS.

In equilibrium $\sum_i a^i = \sum_i \bar{a}^i - \sum_i \sum_{h \neq i} \bar{a}^h = \sum_i \alpha^i - (I-1) \sum_h \bar{a}^h$. Thus, $\bar{y} = \sum_i \bar{a}^i = \frac{1}{I} (\sum_i \alpha^i)$ which is less than the optimal level $y^* = \sum_i \alpha^i$, when $I \geq 2$. Hence, a competitive equilibrium relative to the Lindahl government is not Pareto-optimal..

APPENDIX IV

A. Proof of Proposition 4.1.

We prove this proposition through a series of lemmata:

Lemma A4.1: Given $(m^i)^i(s) \in M^{I-1} \times S$ and $(m^i \setminus m_k^i) \in \mathbb{R}^{K-1}$,

$$\bar{m}_k^i(m^i)^i(s) \equiv \text{Max} \left\{ \frac{1}{I-1} (\sum_{h \neq i} m_k^h - \frac{1}{I} q_k), - \sum_{h \neq i} m_k^h \right\}$$

a) minimizes $D^i(m^i)^i(y^i(m/(m^i/m_k^i)), s), s)$ over all $m_k^i \in \mathbb{R}$

b) minimizes $D^i(m^i)^i(y(m/(m^i/m_k^i)), s), s)$ over all $m_k^i \in \mathbb{R}$

c) minimizes $C^i(m/(m^i/m_k^i), s)$ over all $m_k^i \in \mathbb{R}$

Proof: Since C^i depends on m_k^i only through $D^i(m^i)^i(y^i(m, s), s)$, a) implies c).

To show a) and b), fix y_k , for all $k' \neq k$ and consider $D^i(m^i)^i(y/y_k, s)$ as a function of y_k . Since $s \in S$, $|s| = 1$ and thus:

$$D^i(m^i)^i(y, s) = - (\sum_{h \neq i} m_k^h - \frac{1}{I} q) y + \frac{I-1}{2} y \cdot y,$$
 which is a strictly convex (quadratic) function of y_k with a (global) unique minimum at

$$\bar{y}_k \equiv \frac{1}{I-1} (\sum_{h \neq i} m_k^h - \frac{1}{I} q_k)$$

Thus, to show a) it suffices to show that

$$(a') \quad y_k^i(m, s) \geq y_k^i(m/(m^i/m_k^i), s) \geq \bar{y}_k \quad \text{for all } m_k^i$$

$$(b') \quad y_k(m/(m^i/m_k^i)) = \text{Max} \{y_k, 0\}.$$

Now

$$y_k^i(m, s) \equiv \text{Max} \{y_k(m), y_k(m/m^i)\} = \text{Max} \{y_k(m), y_k(m/(m^i/m_k^i))\} \quad \text{since } y_k \text{ depends}$$

on m^i only through m_k^i . Thus,

$$y_k^i(m, s) \geq y_k(m/(m^i/m_k^i)) = \text{Max} \{ \sum_{h \neq i} m_k^h + \frac{m_k^i}{I}, 0 \} = \sum_{h \neq i} m_k^h + \frac{m_k^i}{I},$$

since $\frac{m_k^i}{I} \geq - \sum_{h \neq i} m_k^h$, and

$$y_k(m/(m^i/m_k^i)) \geq \sum_{h \neq i} m_k^h + \frac{1}{I-1} (\sum_{h \neq i} m_k^h - \frac{1}{I} q_k) = \frac{1}{I-1} (I \sum_{h \neq i} m_k^h - \frac{1}{I} q_k) = \bar{y}_k.$$

Thus, (a') is shown.

To show (b'),

$$\begin{aligned} y_k(m/(m^i/m_k^i)) &= \text{Max} \{ \sum_{h \neq i} m_k^h + \frac{m_k^i}{I}, 0 \} = \text{Max} \{ \sum_{h \neq i} m_k^h + \frac{1}{I-1} (\sum_{h \neq i} m_k^h - \frac{1}{I} q_k), 0 \} \\ &= \text{Max} \{ \bar{y}_k, 0 \}, \text{ thus verifying (b')}. \quad \blacksquare \end{aligned}$$

Corollary A.4.1: Given $(m)^i(s) \in M^{I-1} \times S$ and $(m^i \setminus m_k^i) \in \mathbb{R}^{K-1}$,

$$C^i(m/(m^i/m_k^i), s) = \text{Min}_{m_k^{i'}} C^i(m/(m^i/m_k^{i'}), s)$$

if and only if $m_k^i \leq m_k^{i'}$.

Proof: If $m_k^i \leq m_k^{i'}$, then $y_k^i(m, s) = \text{Max} \{ y_k(m), y_k(m/(m^i/m_k^i)) \}$
 $= y_k(m/(m^i/m_k^i)) = y_k^i(m/m_k^i, s)$ and $C^i(m, s) = \text{Min}_{m_k^{i'}} C^i(m/(m^i/m_k^{i'}), s)$.

Suppose $m_k^i > m_k^{i'}$. If (a) $-\sum_{n \neq i} m_k^h \geq \frac{1}{I-1} (\sum_{h \neq i} m_k^h - \frac{1}{I} q_k)$,

then $y_k(m) = \sum_h m_k^h > y_k(m/(m^i/m_k^i)) \geq \bar{y}_k$, and, since $\sum_h m_k^h > 0$,

$y_k^i(m, s) = y_k(m) > y_k(m/(m^i/m_k^i)) = y_k(m/m_k^i) = y_k^i(m/m_k^i, s) \geq \bar{y}_k$. Hence

$C^i(m, s) > C^i(m/(m^i/m_k^i), s)$.

If (b) $\frac{1}{I-1}(\sum_{h \neq i} m_k^h - \frac{1}{I} q_k) > - \sum_{h \neq i} m_k^h$, then

$$y_k^i(m) = \text{Max} \{ \sum_{h \neq i} m_k^h + m_k^i, 0 \} = \sum_{h \neq i} m_k^h + m_k^i > \sum_{h \neq i} m_k^h + \frac{m_k^i}{I} = \bar{y}_k > 0.$$

Thus, $y_k^i(m, s) = y_k^i(m) > y_k^i(m/(m/\underline{m}_k^i), s) = \bar{y}_k > 0$ and hence

$$C^i(m, s) > \text{Min}_{m_k^i} C^i(m/(m^i/m_k^i), s). \quad \blacksquare$$

Corollary A.4.2: $B^i(m)^i(s) = D^i(m)^i(y^i(m/\underline{m}^i), s) - p \omega^i$
 $= D^i(m)^i(y(m/\underline{m}^i), s) - p \omega^i.$

Proof: Immediate from the definition of B^i and Lemma A.4.1. \blacksquare

Lemma A.4.2: Suppose preferences of consumer i are strictly monotonic increasing in every public good y_k . Given $(m, s) \in M^I \times S$, let $(x^{i'}, m^{i'}) \in \xi^i(m, s)$ and suppose that $y_k(m/m^{i'}) > 0$. Then, if i is not in the minimum wealth condition at (m, s) , $m_k^{i'} \geq \underline{m}_k^i(m, s)$.

Proof: Suppose the contrary; i.e. let $(x^{i'}, m^{i'}) \in \xi^i(m, s)$ but suppose $m_k^{i'} < \underline{m}_k^i$. Since $y_k(m/m^{i'}) > 0$, $y_k(m/m^{i'}) < y_k(m/(m^{i'}/\underline{m}_k^i))$. But by Corollary A.4.1, $C^i(m/(m^{i'}/\underline{m}_k^i), s) = C^i(m/m^{i'}, s)$. Since preferences are strictly monotonic in y_k , $(x^{i'}, y_k(m/(m^{i'}/\underline{m}_k^i))) \succ_i (x^{i'}, y_k(m/m^{i'}))$. But then, since the consumer is not in the minimum wealth condition and $p x^{i'} + C^i(m/(m^{i'}/\underline{m}_k^i), s) = p x^{i'} + C^i(m/m^{i'}, s) \leq w^i(m, s)$, we have contradicted the fact that $(x^{i'}, m^{i'}) \in \xi^i(m, s)$. \blacksquare

Corollary A.4.3: Under the assumptions of Lemma A.4.2, $y_k^i(m/m^{i'}, s) = y_k^i(m/m^{i'})$.

Proof: $y_k^i(m/m^{i'}, s) = \text{Max} \{y_k^i(m/m^{i'}), y_k^i(m/m^i)\}$. By the lemma $m_k^{i'} \geq m_k^i$. Since $y_k^i(m)$ is non-decreasing in m_k^i and does not depend on m_k^i , for all $k' \neq k$, $y_k^i(m/m^{i'}) \geq y_k^i(m/m^i)$. Thus $y_k^i(m/m^{i'}, s) = y_k^i(m/m^{i'})$ ■

Lemma A.4.3: Given $(m^i)^i(s) \in M^{I-1} \times S$, let $\bar{m}^i(m^i)^i(s)$ minimize $[D^i(m^i)^i(y^i(m/m^i, s), s) - \frac{p\omega^i}{p\omega} q \cdot y^i(m/m^i, s)]$. If $q \cdot y^i(m/\bar{m}^i, s) \leq p\omega$, then

$A^i(m^i)^i(s) \geq B^i(m^i)^i(s)$ and

$$C^i(m, s) = \frac{p\omega^i}{p\omega} q \cdot y^i(m, s) + [D^i(m^i)^i(y^i(m, s), s) - \frac{p\omega^i}{p\omega} q \cdot y^i(m, s)] - A^i(m^i)^i(s).$$

Proof: By definition $A^i(m^i)^i(s) = D^i(m^i)^i(y^i(m/\bar{m}^i, s), s) - \frac{p\omega^i}{p\omega} q \cdot y^i(m/\bar{m}^i, s)$.

Thus

$$A^i(m^i)^i(s) - B^i(m^i)^i(s) = D^i(m^i)^i(y^i(m/\bar{m}^i, s), s) - \text{Min}_{m^i} D^i(m^i)^i(y^i(m, s), s) + p\omega^i - \frac{p\omega^i}{p\omega} q \cdot y^i(m/\bar{m}^i, s).$$

Hence $A^i(m^i)^i(s) - B^i(m^i)^i(s) \geq \frac{p\omega^i}{p\omega} [p\omega - qy^i(m/\bar{m}^i, s)] \geq 0$ ■

Proposition 4.1 follows from Corollary A.4.3 and Lemma A.4.3. QED

B. Proof of Proposition 4.2

$z^i(y)$ satisfies $u^i(\hat{x}^i(z), y) = u^i(x^{i*}, y(m/m^{i*}))$ for all y . Thus

$$\sum_{\ell} u_{x_{\ell}}^i \cdot \frac{dx_{\ell}^i}{dz^i} dz^i + \sum_k u_{y_k}^i \cdot dy_k = 0.$$

Since $\hat{x}^i(z)$ maximizes $u^i(x^i, y)$ subject to $px^i \leq w^i - z^i$,

$$u_{x_\ell}^i(\hat{x}^i(z^i), y) = \hat{\lambda}(z^i) p_\ell \quad \text{for all feasible } z^i \text{ and all } \ell \text{ and } \sum_\ell p_\ell dx_\ell^i(z^i) = -dz^i.$$

$$\begin{aligned} \text{Thus } \sum_\ell u_{x_\ell}^i \cdot \frac{dx_\ell^i}{dz^i} dz^i &= \hat{\lambda}(z^i) \sum_\ell p_\ell \frac{dx_\ell^i}{dz^i} dz^i = -\hat{\lambda}(z^i) dz^i = \frac{u_{x_\ell}^i(\hat{x}^i(z^i), y)}{p_\ell} dz^i \\ &= -\sum_k u_{y_k}^i \cdot dy_k. \end{aligned}$$

Setting $dy_{k'} = 0$ for all $k' \neq k$, we have

$$\frac{\partial z^i(y)}{\partial y_k} = p_\ell \frac{u_{y_k}^i(\hat{x}^i(z^i(y)), y)}{u_{x_\ell}^i(\hat{x}^i(z^i(y)), y)} \quad \text{for all } \ell \text{ and } y.$$

Since $(x^{i*}, m^{i*}) \in \xi^i(m, s)$, (x^{i*}, m^{i*}) maximizes $u^i(x^i, y(m/m^{i*}))$ subject to $px^i + C^i(m/m^{i*}, s) \leq w^i(m, s)$. Thus

$$p_\ell \frac{u_{y_k}^i(x^{i*}, y(m/m^{i*}))}{u_{x_\ell}^i(x^{i*}, y(m/m^{i*}))} = \frac{\partial C^i(m/m^{i*}, s)}{\partial m_k^i} = \frac{\partial D^i(m)^i(y(m/m^{i*}), s)}{\partial y_k}$$

But, by the definition of D^i and $f^i(y; m^{i*}, q)$

$$\begin{aligned} \frac{\partial D^i}{\partial y_k} \bigg|_{y(m/m^{i*})} &= (I-1)y_k(m/m^{i*}) - (I \sum_{h \neq i} m_k^h - \frac{1}{I} q_k) = (I m_k^{i*} + \frac{1}{I} q) - y_k(m/m^{i*}) \\ &= \frac{\partial f^i(y(m/m^{i*}); m^{i*}, q)}{\partial y_k} \end{aligned}$$

Finally, since $\hat{x}^i(z^i(y(m/m^{i*}))) = x^{i*}$,

$$\frac{\partial z^i(y(m/m^{i*}))}{\partial y_k} = \frac{\partial f^i(y(m/m^{i*}); m^{i*}, q)}{\partial y_k}. \quad \text{QED}$$

C. Two Lemmata for Proposition 4.7.

In this appendix two lemmas used to verify assumption (i) (Proposition 4.7) are proved.

Lemma A.4.4: For every (m,s) , $C^i(m,s) \geq \text{Min} \left\{ \frac{p\omega^i}{p\omega} q \cdot y(m), p\omega^i \right\}$

Proof: $C^i(m,s) = \text{Min} \left\{ \frac{p\omega^i}{p\omega} q \cdot y^i(m,s) + [D^i(m)^i(\cdot, y^i(m,s), s) - \frac{p\omega^i}{p\omega} q \cdot y^i(m,s)] \right.$
 $\quad - \text{Min}_{m^i} [D^i(m)^i(\cdot, y^i(m,s), s) - \frac{p\omega^i}{p\omega} q \cdot y^i(m,s)];$
 $\quad p\omega^i + D^i(m)^i(\cdot, y^i(m,s), s) - \text{Min}_{m^i} D^i(m)^i(\cdot, y^i(m,s), s) \left. \right\}$
 $\geq \text{Min} \left\{ \frac{p\omega^i}{p\omega} q \cdot y^i(m,s), p\omega^i \right\} \geq \text{Min} \left\{ \frac{p\omega^i}{p\omega} q \cdot y(m), p\omega^i \right\}$
 since $y^i(m,s) \geq y(m)$. ■

Lemma A.4.5: Given (m,s) , if $q \cdot y(m) > p\omega$, then $C^i(m,s) > p\omega^i$ unless $m^i \leq \underline{m}^i(m)^i(\cdot, s)$ in which case $C^i(m,s) = p\omega^i$.

Proof: If $p\omega^i = 0$, then $C^i(m,s) = D^i(m)^i(\cdot, y^i(m,s), s) - \text{Min}_{m^i} D^i(m)^i(\cdot, y^i(m,s), 0)$
 $\geq 0 = p\omega^i$ and by Corollary 4.1, $C^i(m,s) = 0 = p\omega^i$ only if $m^i \leq \underline{m}^i(m)^i(\cdot, s)$.

If $p\omega^i > 0$, then $q \cdot y^i(m,s) \geq q \cdot y(m) > p\omega \geq p\omega^i > 0$. Let

$\epsilon^i \equiv \left(\frac{q \cdot y^i(m,s)}{p\omega} - 1 \right) p\omega^i > 0$. Then

$C^i(m,s) = \text{Min} \left\{ p\omega^i + \epsilon^i + [D^i - \frac{p\omega^i}{p\omega} q \cdot y^i(m,s)] - \text{Min}_{m^i} [D^i - \frac{p\omega^i}{p\omega} q \cdot y^i(m,s)]; \right.$
 $\quad p\omega^i + D^i - \text{Min}_{m^i} D^i \left. \right\}.$

If $m^i \not\leq \text{Max} \{ - \sum_{h \neq i} m^h, \underline{m}^i \}$, then $D^i \neq \text{Min}_{m^i} D^i$ by Corollary 4.1. Hence

$$C^i(m,s) \geq \text{Min} \{ p\omega^i + \epsilon^i, p\omega^i + D^i - \text{Min}_{m^i} D^i \} > p\omega^i .$$

If $m^i \leq \underline{m}^i(m)^i(s)$, then $D^i = \text{Min}_{m^i} D^i$ and $C^i(m,s) = p\omega^i$. ■

FOOTNOTES FOR SECTION IV

1/ The G-L allocation rule depends only on the messages and not the prices. Thus we write $y(m)$ instead of $y(m,s)$.

2/ Since the most desired bundle for consumer i may contain less of some public good than the aggregate amounts requested by the other consumers, we must permit negative messages. Hence, M was defined to be the entire space \mathbb{R}^K and not just the positive orthant.

3/ Compare with the vacuous government, Section II.7, example 3.

4/ $A^i(m)^i(,s)$ is, of course, not defined if and only if $|p| = \sum_{\ell} p_{\ell} = 0$. However, for any $(m)^i(,q)$, if p is sufficiently close to zero, $A^i(m)^i(,s) < B^i(m)^i(,s)$ and thus $C^i(m,s) = D^i - B^i$ is defined for s such that $|p| = 0$. See proof of continuity of $C^i(m,s)$, Proposition 4.5 below in Section IV.2.

5/ That is, u^i is strictly quasi-concave, continuously differentiable, strictly monotonic increasing in (x^i, y) and

$$\lim_{x_{\ell}^i \rightarrow 0} \frac{\partial u^i}{\partial x_{\ell}^i} = \lim_{y_k \rightarrow 0} \frac{\partial u^i}{\partial y_k} = \infty \quad \text{for all } \ell \text{ and } k.$$

6/ M_{δ} is the closed cube with side length $\bar{\delta}_k + \underline{\delta}_k$ and center at the point $\frac{1}{2}(\bar{\delta} - \underline{\delta})$.

7/ Typically $A^i(m)^i(,s)$ would be chosen to be negative in order to raise positive amounts from each consumer.

8/ This phenomena has also been encountered in general equilibrium models with transaction cost, c.f. [10].

9/ This is Arrow's "exceptional case", c.f. Arrow [1].

10/ Note that this distribution of endowments is essentially identical to that used for the Lindahl mechanism (see equations (4.19d)) since $\tilde{t}^i y^*$ is the tax $C^i(m^*, s^*; \tilde{\omega}^i)$ and $\sum_h C^h(m^*, s^*; \tilde{\omega}^i) = \sum_h \tilde{t}^h y^* = \tilde{q} y^*$.

11/ We use $\partial^+ D^i / \partial y$ instead of $\partial D^i / \partial y$ since it is possible that $y_k^* = y_k(m^* / \underline{m}^i) = 0$ for some k in which case $\partial D^i / \partial y$ is not defined.

12/ We normalize prices here on the simplex defined by all non-negative prices (p, q) with norm equal two (2). Or, we may alternatively and without loss of generality redefine the norm by $|s| = \frac{1}{2}(p+q)$ and normalize on the unit simplex for this norm.

BIBLIOGRAPHY

- [1] ARROW, K.J. (1951) "An Extension of the Basic Theorems of Classical Welfare Economics" in J. Neyman, Ed., Proceedings of the Second Berkeley Symposium on Mathematical Statistics and Probability, University of California Press.
- [2] ARROW, K. J. (1970) "The Organization of Economic Activity: Issues Pertinent to the Choice of Market Versus Nonmarket Allocation" in R. H. Haveman and J. Margolis, eds. Public Expenditures and Policy Analysis, Chicago: Markham.
- [3] ARROW, K.J. and G. DEBREU (1954) "Existence of an Equilibrium for a Competitive Economy" Econometrica pp. 265-290.
- [4] BERGE, C. (1963) Topological Spaces, New York: The Macmillan Co.
- [5] DEBREU, G. (1959) Theory of Value, New York: Wiley and Sons.
- [6] DEBREU, G. (1962), "New Concepts and Techniques for Equilibrium Analysis" International Economic Review, pp. 257-273.
- [7] DREZE, J. and D. de la VALLEE POUSSIN (1971) "A Tatonnement Process for Public Goods" Review of Economic Studies.
- [8] FOLEY, D. (1967) "Resource Allocation and the Public Sector" Yale Economic Essays, 7, pp. 43-98.
- [9] FOLEY, D. (1970) "Lindahl's Solution and the Core of an Economy with Public Goods" Econometrica, pp. 66-72.
- [10] FOLEY, D. (1970) "Economic Equilibrium with Costly Marketing" Journal of Economic Theory, pp. 276-291.
- [11] GREEN, J. and J. LAFFONT (1974) "On the Revelation of Preferences for Public Goods" Technical Report No. 140, Economic Series Institute for Mathematical Studies in the Social Sciences, Stanford University.

- [12] GROVES, T. (1973) "Incentives in Teams" Econometrica, pp. 617-63.
- [13] GROVES, T. and M. LOEB (1973) "Incentives and Public Inputs" Discussion Paper No. 29, The Center for Mathematical Studies in Economics and Management Science, Northwestern University, Evanston, Ill., (forthcoming in Journal of Public Economics).
- [14] HURWICZ, L. (1972) "On Informationally Decentralized Systems" in R. Radner and B. McGuire, eds., Decision and Organization, Amsterdam: North Holland Press.
- [15] KIHLSSTROM, R. (1974) "A Legislative Mechanism for Achieving Lindahl Equilibrium in a Public Goods Economy" unpublished manuscript.
- [16] LEDYARD, J. and D. J. ROBERTS (1974) "On the Incentive Problem with Public Goods" Discussion Paper No. 116, The Center for Mathematical Studies in Economics and Management Science, Northwestern University, Evanston, Illinois.
- [17] MALINVAUD, E. (1971) "A Planning Approach to the Public Goods Problem" Swedish Journal of Economics.
- [18] MICHAEL, E. (1956) "Continuous Selections" Annals of Mathematics pp. 361-382.
- [19] SAMUELSON, P. (1954) "The Pure Theory of Public Expenditures" Review of Economic Studies.