

Grech, Owen; Rapa, Noel

Working Paper

STREAM: A structural macro-econometric model of the Maltese economy

CBM Working Papers, No. WP/01/2016

Provided in Cooperation with:

Central Bank of Malta, Valletta

Suggested Citation: Grech, Owen; Rapa, Noel (2016) : STREAM: A structural macro-econometric model of the Maltese economy, CBM Working Papers, No. WP/01/2016, Central Bank of Malta, Valletta

This Version is available at:

<https://hdl.handle.net/10419/210814>

Standard-Nutzungsbedingungen:

Die Dokumente auf EconStor dürfen zu eigenen wissenschaftlichen Zwecken und zum Privatgebrauch gespeichert und kopiert werden.

Sie dürfen die Dokumente nicht für öffentliche oder kommerzielle Zwecke vervielfältigen, öffentlich ausstellen, öffentlich zugänglich machen, vertreiben oder anderweitig nutzen.

Sofern die Verfasser die Dokumente unter Open-Content-Lizenzen (insbesondere CC-Lizenzen) zur Verfügung gestellt haben sollten, gelten abweichend von diesen Nutzungsbedingungen die in der dort genannten Lizenz gewährten Nutzungsrechte.

Terms of use:

Documents in EconStor may be saved and copied for your personal and scholarly purposes.

You are not to copy documents for public or commercial purposes, to exhibit the documents publicly, to make them publicly available on the internet, or to distribute or otherwise use the documents in public.

If the documents have been made available under an Open Content Licence (especially Creative Commons Licences), you may exercise further usage rights as specified in the indicated licence.



BANK ĊENTRALI TA' MALTA
EUROSISTEMA
CENTRAL BANK OF MALTA

STREAM: A Structural Macro-Econometric Model of the Maltese Economy¹

Owen Grech² and Noel Rapa³

Version 3.0 (February 2016)

WP/01/2016

¹ The authors would like to thank Prof Josef Bonnici, Mr Alfred Mifsud, Mr Alexander Demarco, Dr Bernard Gauci, Dr Aaron G. Grech and participants at an internal research seminar for valuable discussions, comments and suggestions. The views expressed are those of the authors and do not necessarily reflect the views of the Central Bank of Malta. Any errors are their own.

² Owen Grech is a Senior Research Economist in the Bank's Modelling and Research Department and a Visiting Assistant Lecturer at the Faculty of Economics, Management and Accountancy, University of Malta. Corresponding author (Email address: grecho@centralbankmalta.org).

³ Noel Rapa is a Senior Research Economist in the Bank's Modelling and Research Department.

Contents

Abstract	4
1. Introduction	5
2. An Overview of the Model	8
2.1. A Bird’s Eye View of the Model and its Key Features.....	8
2.2. A Word on the Modelling Strategy	10
3. A Closer Look at the Model	12
3.1. The Supply Block.....	12
3.1.1 Potential Output.....	12
3.1.2 Labour Supply	13
3.1.3 Employment	14
3.2. The Demand Block	14
3.2.1 Private Consumption	15
3.2.2 Investment	15
3.2.2.1 Non-Dwelling Private Investment	16
3.2.2.2 Dwelling Private Investment.....	16
3.2.2.3 Government Investment.....	16
3.2.3 Changes in Inventories	16
3.2.4 Government Consumption.....	17
3.2.5 Exports.....	17
3.2.5.1 Exports of Goods and Selected Services	17
3.2.5.2 Exports of Other Services	18
3.2.6 Imports.....	18
3.2.6.1 Imports of Goods and Selected Services	18
3.2.6.2 Imports of Other Services	19

3.3. The Price-Wage Block	21
3.4. The Fiscal Block	24
3.5. The Financial Block	29
3.6. Changes between Version 2.0 and 3.0	36
3.6.1 Changes to the Financial Block.....	36
3.6.2 Re-estimation.....	37
4. Simulation Results	39
4.1. World Demand Shock	39
4.2. Oil Price Shock	40
4.3. Exchange Rate Shock.....	42
4.4. Monetary Policy Shock	43
4.5. Government Consumption Shock	45
4.6. Non-Performing Loans Shock.....	46
5. Conclusion	49
References	50
Annexes	56
A.1. The Steady State: the Long-Run Properties of the Model	56
A.2. Detailed List of Behavioural Equations	58
A.3. List of Variables.....	89
A.4. Modelling of the Fiscal Block.....	94

Abstract

This paper presents the third version of the Central Bank of Malta's core macro-econometric model of the Maltese Economy, STREAM (Structural and TRaditional Econometric model for Malta). It is a traditional structural model built around the neo-classical synthesis. Behavioural equations are estimated in error-correction form on the basis of quarterly data spanning from 2000Q1 to 2013Q4. Economic agents are assumed to have adaptive expectations. The novelty of the model is that it contains fully fledged fiscal and financial blocks, which is uncommon in traditional structural models. Given both the strong links these sectors share with the broader economy, as well as the substantial influence they have on each other, it is ideal to model them within the same framework. This third version of the model includes two key upgrades when compared to the previous version: (i) it has been extended to include an even richer financial block, and (ii) has been re-estimated using more recent European System of Accounts (ESA) 2010, chain-linked data. Simulation results for six shocks illustrate the properties of the updated model and suggest that its mechanics are plausible from both a theoretical and empirical standpoint.

JEL classification: C3, C5, E1, E2.

Keywords: Macro-econometric modelling, Malta.

1. Introduction

Modern economies are considerably complex, with many variables and different sectors being interlinked. A macro-econometric model is a simplified description of this complex reality. It captures the key economic relationships underpinning an economy, usually based on both theory and historical data, and thus serves to assist economists and policymakers in understanding the inner workings of the underlying economy.

This paper presents the third version of the Central Bank of Malta's core macro-econometric model of the Maltese Economy, STREAM (Structural and TRaditional Econometric model for Malta).⁴ The model was built with four key uses in mind. First, it can be used to conduct simulations and thus assess the impact of various shocks on the domestic economy, such as changes in world demand, the price of oil, the exchange rate, short-term interest rates (monetary policy), government consumption (fiscal policy), and financial conditions, represented, for example, by a change in non-performing loans.⁵

Second, the model can contribute towards the projection exercises carried out by the Bank, including the Eurosystem staff macroeconomic projection exercises.⁶ Although other aids are used in the forecasting process, such as satellite models and expert judgement, the model serves as a useful input, particularly with regard to the medium to long run, where the role of judgement diminishes. In addition, it provides a framework that ensures internal consistency in the forecast, serves as a tool for rapidly updating the projections (e.g. upon the arrival of new external assumptions) and acts as an aid when considering the different inter-linkages within the economy.

⁴ The first and second versions of the model are documented in Grech et al. (2013) and Grech and Micallef (2014), respectively.

⁵ Results for these shocks are presented and discussed in section 4.

⁶ The Eurosystem staff macroeconomic projections are prepared jointly by staff from the euro area national central banks and from the ECB on a bi-annual basis. Based on a common set of assumptions and principles, all euro area national central banks produce projections of their respective economies that cover a range of macroeconomic variables, which are then aggregated to provide a short- to medium-term outlook of the euro area. See ECB (2001) for further details.

Another potential use of the model is that of examining the impact of policy actions on the economy.^{7,8} Finally, the model should deepen our understanding of how the Maltese economy functions and ignite further debate in this regard.

STREAM is a traditional structural model built around the neo-classical synthesis. Behavioural equations are estimated in error-correction form on the basis of quarterly data spanning from 2000Q1 to 2013Q4. Economic agents are assumed to have adaptive expectations. The novelty of the model is that it contains fully fledged fiscal and financial blocks, which is uncommon in traditional structural models. The last two economic crises in Europe, the global financial crisis and the sovereign debt crisis, were a bitter reminder of the strong inter-linkages that exist between the financial and fiscal sector, respectively, and the broader economy. Crises that originated in the financial and fiscal sectors propagated through the economy to influence macro-economic variables such as gross domestic product (GDP), prices and unemployment. These crises, however, are also testimony to the high degree of interdependence that exists between the financial sector and the fiscal sector. For example, financial crises often require fiscal intervention and therefore a financial crisis is likely to act as a strain on public finances. On the other hand, a large portion of government debt is often held by banks and thus a fiscal crisis might trigger financial stress. Given both the strong links these sectors share with the broader economy, as well as the substantial influence they have on each other, it is ideal to model them within the same framework.

This third version of the model includes two key upgrades when compared to the previous version: (i) it has been extended to include an even richer financial block, and (ii) has been re-estimated using European System of Accounts (ESA) 2010, chain-linked data that span an additional year. Simulation results for six shocks illustrate the properties of the updated model and suggest that its mechanics are plausible from both a theoretical and empirical standpoint.

⁷ See, for example, Grech (2014), Micallef and Attard (2015) and Grech (2015).

⁸ The model is, however, subject to the Lucas (1976) critique, which suggests that if economic agents are rational and forward-looking, one cannot gauge their reaction to a change in policy on the basis of relationships observed in past data since the announcement of a change in policy will trigger a change in the behaviour of these economic agents.

The rest of this paper is structured as follows. Section 2 provides an overview of STREAM and its key features, and discusses the modelling strategy. In section 3, a more rigorous description of the model's separate blocks and the behavioural equations therein is provided, together with a discussion on the key differences between this version of the model and the previous version. Section 4 assesses the dynamic properties of the model by considering six simulations, while section 5 concludes.

2. An Overview of the Model

2.1 A Bird's Eye View of the Model and its Key Features

In line with many structural macro models, STREAM is built around the neo-classical synthesis which asserts that the economy is classical in the long-run, but Keynesian in the short-run. In other words, output is driven by supply considerations (the factors of production) in the longer term, however, in the short-run, as a result of the sluggish adjustment of quantities and prices, there are deviations from this long-run equilibrium, and output is determined by the expenditure components of aggregate demand; private consumption, investment, stock building, government consumption, and net exports. Departures from long-run output set in motion a sequence of wage and price adjustments that gradually bring the model back to its long-run equilibrium.

The model exhibits two kinds of inertia that allow for short-run deviations from the long-run equilibrium. The first is real inertia, with real variables (quantities) responding sluggishly to shocks and only moving towards their long-run values gradually. This could reflect the costs of adjusting employment or the capital stock. The model also displays nominal inertia since prices do not respond immediately either. This form of inertia could, for example, represent the costs associated with changing prices (menu costs) or wage stickiness brought about by negotiated wages. As a result of real and nominal inertia, the economy deviates from its long-run equilibrium and only moves towards it gradually in the face of shocks. In the model, this deviation is captured by the output gap – the deviation of actual output (aggregate demand) from its potential (aggregate supply) – and the unemployment gap – the deviation of the actual unemployment rate from an exogenous non-accelerating inflation rate of unemployment (NAIRU) – which trigger price and wage adjustments that gradually restore long-run equilibrium.⁹

⁹ NAIRU is the level of unemployment that is consistent with stable inflation. In the short run, an actual unemployment rate below the NAIRU will exert upward pressure on prices, and vice-versa.

STREAM is composed of five blocks: (i) a supply block, (ii) a demand block, (iii) a price-wage block, (iv) a fiscal block, and (v) a financial block. It consists of 232 equations, 28 of which are estimated behavioural equations, and 292 variables; 232 of them are determined endogenously, while the remaining 60 are exogenous.¹⁰ It is therefore a medium scale model, which strikes a reasonable balance between containing sufficient detail to capture the key economic relationships underpinning the domestic economy, and being tractable and manageable. This is in line with the current modelling practice among many central banks worldwide, which generally rely on small or medium-sized models, even when modelling considerably large and complex economies.

The behavioural equations are estimated – rather than calibrated – and specified in error-correction form, as is customary in traditional macro models.¹¹ Under the error-correction framework, dynamic equations are specified such that changes in a variable depend on the deviation of its actual values from the long-run cointegrating relationship in the previous period, which is gradually corrected via the error-correction term, and also on the short-run dynamics of other variables. The error-correction approach, therefore, reflects the underlying inertia in the economy since long-run relationships only assert themselves gradually in the face of shocks. The model is estimated using seasonally unadjusted, ESA 2010, chain-linked, quarterly data covering the 2000Q1 to 2013Q4 period.¹² The 2014Q4 vintage was used. The use of quarterly data allows the economy’s short-run dynamics to be captured more closely than would be the case with lower frequency data and this, in turn, enhances the model’s usefulness with regard to forecasting.

The model is backward-looking with expectation formation entering implicitly through the inclusion of lagged values in the dynamic equations, as is the case with many models in its class. The model thus embodies adaptive expectations.

¹⁰ See Annex A.2 for a detailed list of the behavioural equations, and Annex A.3 for a list of the variables.

¹¹ In contrast to estimation, which allows the modeller to estimate parameter values from historical data, calibration involves setting these values on the basis of prior information, such as that obtained from micro studies, generally with the intention of being more faithful to economic theory and/or producing a model with properties which are in line with some stylised facts about the underlying economy.

¹² Seasonality was treated through the use of seasonal dummy variables as in Daníelsson et al. (2009).

STREAM can therefore be classified as a traditional structural macro-econometric model. The models it bears closest resemblance to are the European System of Central Banks Multi-Country Models.¹³ It is also similar to the models found in Bank of England (2000), Daniélsson et al. (2009) and Livermore (2004). STREAM, however, is different from these models in two important respects: its fiscal and financial blocks generally contain a higher degree of detail. The financial block draws from Miani et al. (2012).

2.2 A Word on the Modelling Strategy

The four envisaged uses of the model mentioned previously, shaped the modelling strategy, which, in turn, is characterised by the following principles:

Balance between richness and parsimony – In light of its potential uses, the model had to contain a sufficient degree of detail. It had to incorporate a number of channels to be able to realistically gauge how different shocks propagate through the economy to affect a range of macroeconomic variables. Moreover, the model had to have the capacity to produce a rich set of forecasts, and also comprise enough detail to capture the salient relationships underlying the domestic economy so that it could serve as a research tool. At the same time, however, the model had to be tractable and manageable, particularly within the context of simulation and forecasting exercises.

Balance between theory and empirics – Considering its potential range of uses, the model had to possess theoretically consistent features but also follow the data closely. A model that reflects economic theory is appealing because it embodies some widely held belief of how the economy operates from a theoretical perspective. Moreover, outputs emerging from such a model are easier to interpret. That said, it is also desirable for a model to match the data as

¹³ For examples of European System of Central Banks Multi-Country Models, see Angelini, Boissay and Ciccarelli (2006), Angelini, D’Agostino and McAdam (2006), Beňkovskis and Stikuts (2006), Boissay and Villetelle (2005), Fagan, Henry and Mestre (2001), Fagan and Morgan (2005), Fenz and Spitzer (2005), Sideris and Zonzilos (2005), Vetlov (2004), Vetlov and Warmedinger (2006) and Willman and Estrada (2002).

closely as possible and capture empirical relationships borne by the data. Another feature of the modelling strategy was therefore to strike a balance between theory and empirics. Theoretical elements within the model include behavioural equations within the supply and price-wage blocks that are broadly derived from the profit maximisation problem of a representative firm, as well as long-run parameter restrictions to ensure that the model stabilises in the long-run. Many equations, however, are postulated and do not originate from an optimisation framework. This allows them to be estimated more flexibly and hence remain more faithful to the data. Fitting the historical data is also achieved by imposing few restrictions on the equations' short-run coefficients. In other words, the short-run dynamics of the model are largely governed by the data. In summary, then, the model's long-run properties are closely tied to economic theory whereas the short-run dynamics are not explicitly derived from theory but, rather, specified in an *ad hoc* manner and empirically estimated to reflect past data.

Balance between statistical soundness and desirable simulation properties – Statistical soundness (e.g. statistical significance at conventional levels, goodness of fit) was a key consideration when selecting behavioural equations among the alternative specifications. However, equations which ranked highly on the basis of statistical criteria did not always produce desirable simulation properties. In some cases, therefore, settling for the final specification involved some trade-off between statistical soundness and desirable simulation properties. For this reason, the behavioural equations should not be viewed as the 'best' single equations, but rather as the equations we found to strike the most reasonable balance between these two, sometimes conflicting, requirements, and work best within the context of a model.

3. A Closer Look at the Model

The model is composed of five blocks: (i) a supply block, (ii) a demand block, (iii) a price-wage block, (iv) a fiscal block, and (v) a financial block. In what follows, we take a closer look at the separate blocks and the key equations therein.

3.1 The Supply Block

The supply block consists of three key elements: potential output, labour supply and total employment. Potential output is determined through a production function, whereas labour supply and total employment are modelled via a behavioural equation.

3.1.1 Potential Output

In the long run, output is driven by supply-side developments, that is, by the factors of production. This long-run equilibrium level of output – or potential output – is provided by an economy-wide Cobb-Douglas production function with constant returns to scale.¹⁴

The labour input, or potential employment, is calculated via decomposition into three components: the working age population, the participation rate and the NAIRU. The working age population is multiplied by the participation rate (since not all of those who form part of the working age population join the labour force), which is further multiplied by one minus the NAIRU (since not all those in the labour force are in employment). All three components are determined exogenously, with the exogenous path for the NAIRU determined by means of a multivariate filter.¹⁵

¹⁴ The Cobb-Douglas production function can be represented as: $Y=AL^\alpha K^\beta$, where Y is potential output, A is total factor productivity, L is the labour input and K is the capital stock. α and β are the elasticity of output with respect to labour and capital, respectively, and $\alpha + \beta$ gives the returns to scale. If $\alpha + \beta = 1$, there are constant returns to scale; if $\alpha + \beta > 1$, there are increasing returns to scale; and if $\alpha + \beta < 1$, there are decreasing returns to scale.

¹⁵ For further details on the multivariate filter, see Micallef (2014).

The capital stock emerges from the law of motion of capital; capital stock in a given period is equal to the capital stock inherited from the previous period, net of depreciation, plus investment. The initial capital stock is unobservable and is calculated following Hall and Jones (1999).¹⁶ The depreciation rate is exogenous and assumed to be six percent per annum. As investment, non-dwelling (private and public) investment is taken, which emerges from the demand block.

Over the period for which actual data are available, total factor productivity is estimated by applying the Hodrick-Prescott filter to the Solow residual resulting from the production function.¹⁷ Going forward, total factor productivity is given an exogenous path. The elasticity of output with respect to labour is calibrated at 0.58, in line with the historical share of labour income (including the self-employed) in gross value added. The elasticity of output with respect to capital is implicitly calibrated at 0.42, since the assumption of constant returns to scale requires that the two coefficients sum to one.¹⁸

In the short run, output is demand driven and may deviate from its potential level. These deviations are measured by the output gap, which serves to gradually bring output in line with its long-run equilibrium through adjustments in prices and wages.

3.1.2 Labour Supply

In the long run, labour supply moves in line with employment, with a unitary restriction that ensures a stable unemployment rate (see annex A.2.1). In the short run, however, the labour force also depends on developments in real economic activity and real wages. The latter enter the labour supply specification with a positive sign, which suggests that in the Maltese labour

¹⁶ More specifically, $K_0 = I_0/(g+d)$ where K_0 is the initial capital stock, I_0 is the initial value of non-dwelling investment, g is the long-run average growth rate of non-dwelling investment and d is the depreciation rate.

¹⁷ Total factor productivity is an unobservable, catch-all variable that incorporates all those factors that influence economic growth but are not captured explicitly by the measures of labour and capital. Therefore, while it is often associated with technological progress, assumed to enhance the productivity of both labour and capital (hence the term total factor productivity), it also includes measurement errors associated with the quality of the factor inputs and their factor shares. It is for this reason that total factor productivity is also referred to as the Solow residual.

¹⁸ For further details on estimating Malta's potential output using the production function approach, see Grech and Micallef (2013).

market, the substitution effect – a positive effect on the labour supply from higher real wages due to the increase in the opportunity cost of leisure – dominates the income effect – which postulates that higher real wages make leisure more affordable, eventually leading to a decline in the labour supply.

3.1.3 Employment

Long-run actual employment is determined by real economic activity, with a unitary restriction, real compensation per employee and total factor productivity (see annex A.2.2). In the short-run, actual employment is driven by real economic activity. The short-run coefficient of real GDP is estimated at 0.08, which is generally lower than that reported for other economies but still in line with a number of estimates.¹⁹

3.2 The Demand Block

Short-run output is determined by aggregate demand. Real aggregate demand is split into ten real expenditure components, with each modelled separately: private consumption, non-dwelling private investment, dwelling private investment, government investment, changes in inventories, government consumption, exports of goods and selected services, exports of other services, imports of goods and selected services, and imports of other services. Private consumption, non-dwelling private investment, dwelling private investment, exports of goods and selected services and imports of goods and selected services are modelled through a behavioural equation. The remaining five variables, however, could not be modelled adequately using this approach. Therefore, an alternative modelling strategy was employed, namely constructing the variable via decomposition in the case of government consumption, or assuming the variable maintains its share in a broader macroeconomic aggregate.

¹⁹ See, for example, Angelini, Boissay and Ciccarelli (2006) and Angelini, D'Agostino and McAdam (2006).

3.2.1 Private Consumption

In the long run, real private consumption is determined by real disposable income and real net wealth, with the sum of these two coefficients set to be equal to one, as well as the real interest rate on credit to households (see annex A.2.3).²⁰ The consumption function therefore captures the two leading theories of consumption; the Keynesian absolute income hypothesis, which asserts that consumption is a function of current income – which may well be a good description of the consumption pattern of credit-constrained households – and the life-cycle/permanent income hypothesis which postulates that economic agents base their consumption decisions on expected lifetime resources, rather than current income.²¹ Over the short run, consumption is driven by real disposable income, real credit to households and the unemployment rate that captures the influence of precautionary saving. The short-run coefficient of real disposable income stands at 0.30, which lies within the range of estimates found in the literature.²²

3.2.2 Investment

Gross fixed capital formation is broken down into three components: non-dwelling private investment, dwelling private investment and government investment.

²⁰ The Bank's measure of disposable income was used, which is defined as the sum of compensation of employees net of national insurance contributions paid by employers and imputed government national insurance contributions in respect of its own employees, income of the self-employed, social benefits received in cash, investment income received by households and imputed rents, less taxes on employment income. For a more rigorous account of the constructed measure of disposable income used in the model, see Grech (2014a).

²¹ For further details on the Keynesian absolute income hypothesis, the life-cycle hypothesis and the permanent income hypothesis, see Keynes (1936), Modigliani and Brumberg (1954) and Friedman (1957), respectively.

²² This coefficient is similar to that reported by Boissay and Villette (2005), Willman and Estrada (2002) and Bank of England (2000).

3.2.2.1 Non-Dwelling Private Investment

Real non-dwelling private investment depends on real GDP and the user cost of capital in the long run, with both elasticities restricted to one (see annex A.2.4).²³ Over the short term, this investment component is influenced by real economic activity and real credit to non-financial corporations.²⁴

3.2.2.2 Dwelling Private Investment

Long-run real dwelling private investment is modelled as a constant share of real private sector GDP (see annex A.2.5). The dynamics of real dwelling private investment are driven by the number of housing permits issued, real credit to households, and real house prices.

3.2.2.3 Government Investment

Since it is a form of government expenditure, real government investment emerges from the fiscal block. It is assumed to maintain its share in overall real investment.

3.2.3 Changes in Inventories

In Maltese national accounts data, errors and omissions account for a substantial portion of changes in inventories. This makes the series volatile and hence difficult to model. For this reason, real changes in inventories are assumed to be a constant share of real GDP.

²³ The user cost of capital is positively related to the bank lending rate to non-financial corporations and the depreciation rate, and negatively related to the long-run inflation rate.

²⁴ In this class of models, the short-run elasticity of investment with respect to real GDP is generally found to be greater than one. In our case, however, this was found to be lower than unity, as in Angelini, D'Agostino and McAdam (2006).

3.2.4 Government Consumption

Real government consumption is determined within the fiscal block through its national accounts identity, that is, as the sum of public sector compensation of employees, public sector intermediate consumption, social benefits in kind and public sector consumption of fixed capital (depreciation), less public sector sales. These five subcomponents are modelled separately, and then combined through identity to produce government consumption.

3.2.5 Exports

Exports are disaggregated into two categories: exports of goods and selected services, and exports of other services. Exports of selected services consist of those services which are relatively ‘well-behaved’ and can thus be modelled within the context of a behavioural equation, such as tourism exports. Exports of other services, on the other hand, include those services which contain a considerable degree of noise. They were therefore separated from remaining exports, to avoid introducing noise in the behavioural equation, and are modelled in an alternative manner.

3.2.5.1 Exports of Goods and Selected Services

Real exports of goods and selected services are modelled in a standard fashion (see annex A.2.6). In the long run, they are a function of world demand and relative price competitiveness, with the latter defined as the ratio of the domestic export deflator to a measure of competitors’ prices on the export side.^{25,26} The long-run elasticity with respect to

²⁵ The variable for world demand is an index constructed by the ECB that specifically measures the demand for Maltese exports. It is a weighted average of the import volumes of trading partners, with weights derived on the basis of the direction of Maltese exports. See Hubrich and Karlsson (2010) for further details.

²⁶ This measure of competitors’ prices on the export side is an index, also constructed by the ECB, computed as a double-weighted average of export prices of Malta’s competitors. In the first stage of the weighting scheme, the competitor’s price faced by Malta in its individual export markets is calculated as a weighted average of competitors’ export prices, with the weights reflecting the importance of each competitor with regard to the imports of that individual country. In the second stage, the competitors’ prices faced by Malta in each of its export markets are weighted according to the share of each market in Malta’s total exports, and aggregated. Further details can be found in Hubrich and Karlsson (2010).

world demand is restricted to one. The export equation can therefore be interpreted as a market share equation, whereby a gain (loss) in market share, in the long run, is driven by an improvement (deterioration) in price competitiveness. The long-run elasticity of Malta's market share with respect to competitiveness was also set to one. In the short run, real exports of goods and selected services are again driven by world demand and relative price competitiveness. The estimated short-run coefficient of world demand is 1.04, which is in accord with the range of estimates reported in the literature.²⁷ The dynamic impact of price competitiveness is estimated at -1.09, which suggests that Maltese exports of goods and selected services are marginally price elastic in the short run.

3.2.5.2 Exports of Other Services

Real exports of other services are assumed to maintain their share in overall exports, a relationship which is strongly supported by the actual data.

3.2.6 Imports

Similarly, imports are split into two components: imports of goods and selected services, and imports of other services. The distinction is analogous to that of exports. The import components that contain a substantial degree of noise, and were thus separated from remaining imports, are identical to those for exports.

3.2.6.1 Imports of Goods and Selected Services

Real imports of goods and selected services depend on an import demand indicator in the long run (see annex A.2.7).²⁸ This elasticity was, by definition, set to one. In the short run,

²⁷ See, for example, Bank of England (2000), Boissay and Villetelle (2005), Angelini, D'Agostino and McAdam (2006) and Vetlov and Warmedinger (2006).

²⁸ The import demand indicator is a measure of the import content of the components of real final demand and is constructed on the basis of information from input-output tables and own calculations. The import content is estimated to be as follows: 55% for private consumption, 65% for overall investment, 20% for government consumption and 35% for exports of goods and selected services. Changes in inventories do not

real imports of goods and selected services are again determined by the import demand indicator, the elasticity of which is estimated at 1.38. While the dynamic impact of import demand is less pronounced than many of the values reported in the literature, it compares favourably to some of the estimates nonetheless.²⁹ In many of the import equations found in other studies, real imports are also a function of import price competitiveness, defined as the ratio of import prices (often measured by the import deflator) to domestic prices (frequently measured by the overall GDP deflator). However, in the case of Malta, relative prices were not included given that a substantial proportion of imports cannot be substituted by domestic products.

3.2.6.2 Imports of Other Services

Real imports of other services are set to be a constant share of exports of other services, a relationship that emerges from the actual data.

Chart 1 provides a schematic representation of the demand block, which is useful in understanding the mechanics of the model. It displays the demand block's structure, links within the block itself and links that the block shares with the rest of the model. Variables enclosed in blue are endogenous. Some of these endogenous variables are identities or governed by a behavioural equation. These are marked in black and dashed blue, respectively. Exogenous variables are enclosed in red, while other blocks are marked in green. Arrows indicate the direction of influence which, in some cases, runs in both directions.

feature in the import demand indicator since it is assumed that their import content is negligible, given that they largely consist of errors and omissions.

²⁹ It is similar, for example, to that reported by Vetlov and Warmedinger (2006).

Chart 1 – Schematic Representation of the Demand Block

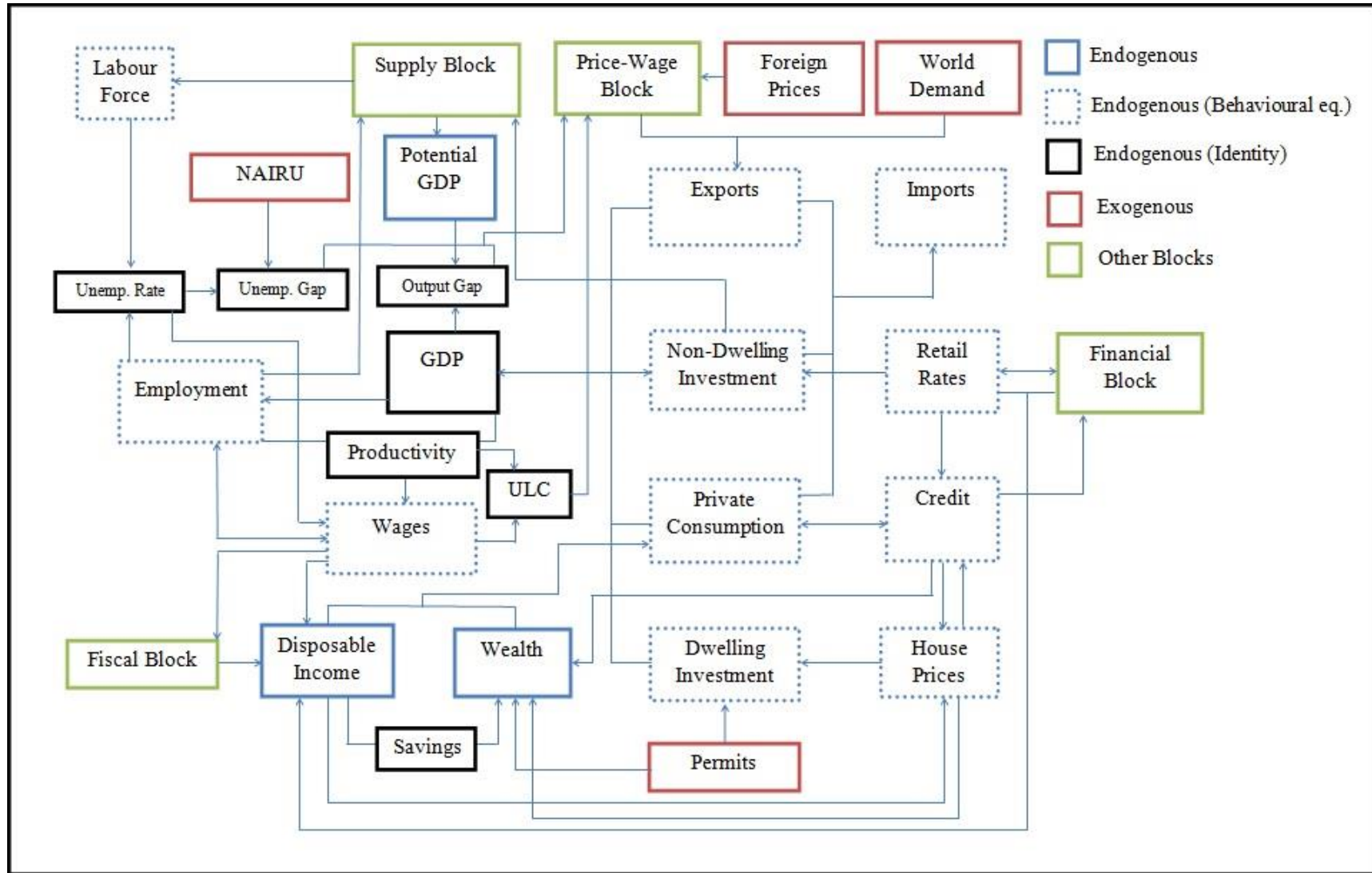

3.3 The Price-Wage Block

The model distinguishes between seven deflators for the following variables: GDP, private consumption, investment, changes in inventories, government consumption, exports and imports. Following a substantial portion of the literature, a top-down approach is adopted in modelling prices, through which the GDP deflator is modelled directly and the deflators for the expenditure components of GDP are influenced by developments in the former.³⁰ The deflators for GDP, private consumption, investment, exports and imports are modelled via a behavioural equation. The other two deflators had to be modelled in an alternative manner. The government consumption deflator is assumed to grow in line with the GDP deflator, while the changes in inventories deflator is computed as an identity, serving as a residual that ensures consistency between the overall GDP deflator and its components. STREAM also contains two types of wages: the private sector wage – which is modelled by means of a behavioural equation – and the public sector wage – which is assumed to grow in line with the former.

The long-run behaviour of the GDP deflator is similar to a theoretically-derived one from neoclassical behaviour in which monopolistically competitive firms maximise profits with respect to prices, given technology and demand (Angelini et al., 2006) (see annex A.2.8). In this framework, optimal prices are equal to a constant mark-up over marginal costs, with the latter being proxied by unit labour costs. We also include an economy-wide indirect tax rate in the long run to capture the effect of indirect taxes, like VAT, on domestic prices. In the short run, the GDP deflator depends on its lagged values, representing inertia in the price setting process, foreign prices, changes in wages and the output gap. The latter variable captures the impact of demand pressures on prices, thereby augmenting the link between the real and the nominal side.

³⁰ Another modelling option is a bottom-up approach, through which the deflators for the expenditure components of GDP are modelled without any influence from developments in the GDP deflator. The latter is then calculated as a residual. The top-down approach, however, is usually preferred because the GDP deflator is generally more “well behaved” than the deflators for the expenditure components of GDP since it measures prices at a more aggregate level.

Import prices are modelled in accordance with a pricing-to-market model, which implies that in setting their prices, importers also take into consideration prevailing domestic factors, such as the degree of competition in domestic markets (see annex A.2.12). In the long run, import prices set by Maltese importers are linked to foreign producer prices denoted in euro, whereas in the short run they depend on foreign producer prices denoted in euro, as well as the GDP deflator.

The consumption, investment and export deflators are modelled as a weighted average of the GDP deflator and the import deflator in the long run (see annexes A.2.9-A.2.11). In the case of consumption prices, in the short run they also depend on changes in oil prices in euro terms, the unemployment gap and the effective exchange rate. The investment and export deflators are driven by import prices and the GDP deflator in the short run.

The government deflator is assumed to grow in line with the GDP deflator, while the inventory deflator is computed as an identity, serving as a residual that ensures consistency between the overall GDP deflator and its components.

The long-run condition for private wages is derived from the first order condition of a profit maximising firm (see annex A.2.13). Thus, the long-run elasticity of nominal private wages with respect to both private labour productivity and prices is set to one. The unemployment rate is also assumed to have an adverse effect on private wage developments in the long run. The short-run dynamics are driven by private productivity and consumer prices. The impact of price developments in the short-run is intended to capture the partial indexation of wages to prices (COLA), which is a specific feature of the domestic labour market.

A schematic representation of the price block is presented in Chart 2.

Chart 2 – Schematic Representation of the Price Block

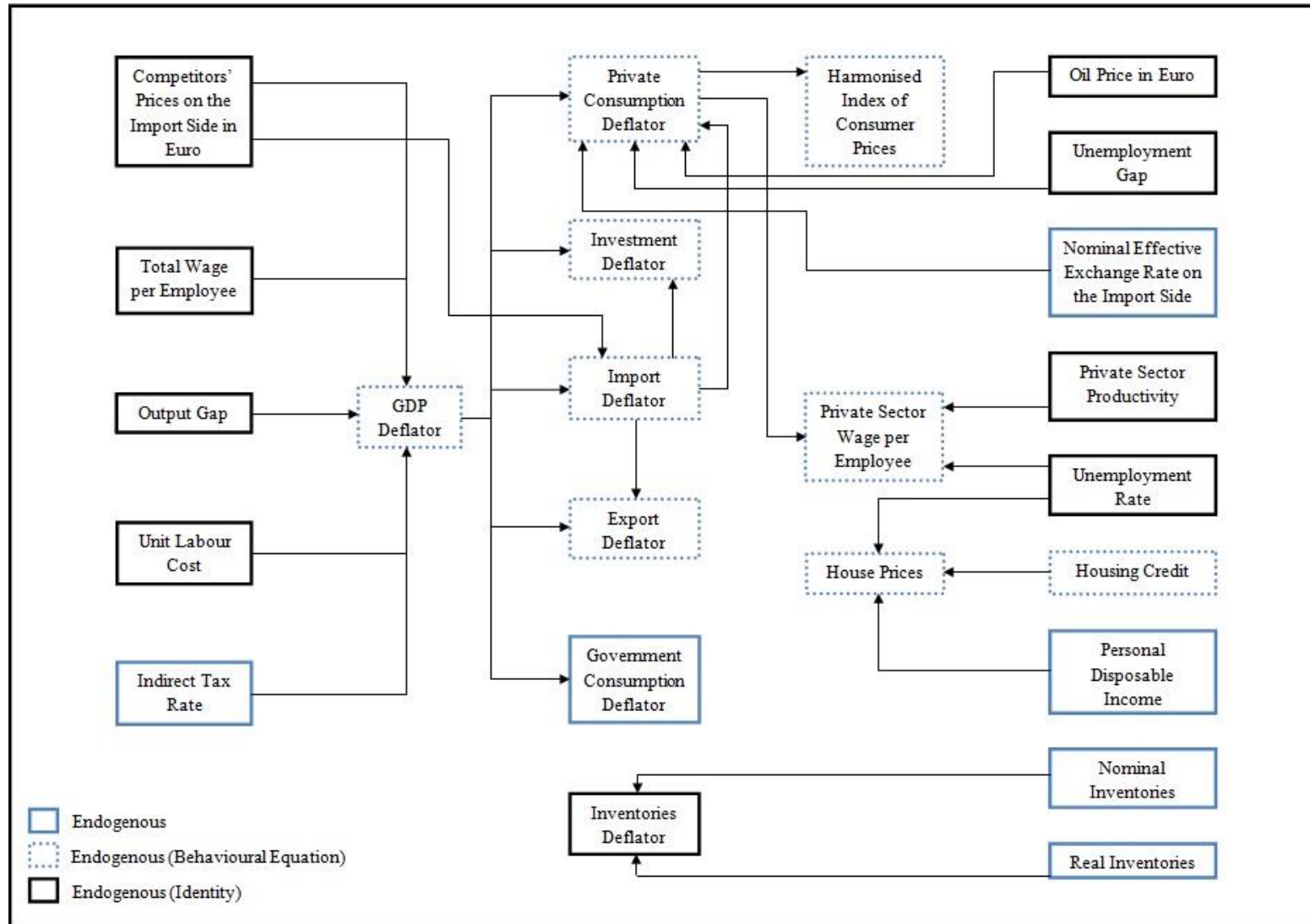

3.4 The Fiscal Block

In constructing the fiscal block, the standard approach in the literature was followed.³¹ Tables A.4.1 and A.4.2 in the annex outline, respectively, how the revenue and expenditure sides of the fiscal block are modelled. The tables show that, at the highest level of disaggregation, there are 15 components on the revenue side and 12 categories on the expenditure side, which make the fiscal block one of medium scale.³²

Many of these fiscal variables are modelled by multiplying an exogenous effective revenue or expenditure rate by a suitable macroeconomic base – a macroeconomic variable to which the fiscal variable is closely tied – where the effective rate is the ratio of the fiscal variable to the chosen base. Since the macroeconomic base is determined endogenously, so will the fiscal variable. For example, VAT receipts are modelled using this approach, where an exogenous effective VAT rate is multiplied by a suitable base, namely nominal consumption, with the effective rate being the ratio of VAT receipts to the base.^{33,34,35} Since nominal consumption is determined endogenously, the response of VAT receipts is also endogenous. Suitable bases were chosen by relying on both theory and empirics. In other words, the macroeconomic bases that were ultimately selected bear a strong relationship to the fiscal variable being modelled, not only from a theoretical standpoint, but also from a statistical one borne out in the data.³⁶ In all, 12 variables are modelled using the ‘effective rate times base’ approach.

In cases when this approach was not deemed to be a suitable one, a different modelling strategy was employed. The fiscal variable was assumed to maintain its share in a broader

³¹ For examples and descriptions of fiscal blocks within traditional structural macro-econometric models, see Fagan and Morgan (2005) and Bank of England (2000).

³² In this context, a component at the highest level of disaggregation is not one that cannot be subdivided further, but rather one which is not decomposed to a greater degree in the model.

³³ See ECB (2014) for definitions of fiscal variables.

³⁴ In the absence of additional information, the effective rate is generally based on trends in the actual data.

³⁵ Mathematically:

$$VAT\ receipts = effective\ VAT\ rate * nominal\ consumption, \text{ i.e.}$$

$$VAT\ receipts = \frac{VAT\ receipts}{nominal\ consumption} * nominal\ consumption.$$

³⁶ Arguably, the only contentious base is that for direct taxes on corporations. From a theoretical point of view, this variable should move in line with gross operating surplus. However, this is not supported empirically, largely as a result of noise in the data. Consequently, nominal GDP was chosen as the base since the data suggest that this variable bears a stronger link with direct taxes on corporations and the choice can also be justified on theoretical grounds.

fiscal aggregate, was constructed via decomposition, or was given an exogenous path. For instance, a substantial portion of property income consists of profits earned by the Central Bank of Malta that were passed on to the Government. These profits are not closely tied to some macroeconomic variable and hence the ‘effective rate times base’ approach would not be appropriate. Instead, this variable is assumed to maintain its share in government revenue. There are ten fiscal variables in total that are modelled using this strategy. Four fiscal variables are constructed through decomposition. Public sector compensation of employees, for example, is calculated by multiplying the number of government employees by the average wage in the public sector, and adding employers’ national insurance contributions paid by the government and imputed national insurance contributions. The remaining fiscal variable was given an exogenous path. At the highest level of disaggregation, the most significant revenue categories are VAT receipts, direct taxes on households and direct taxes on corporations, which together account for more than half of total revenue, whereas compensation of employees, pension benefits and intermediate consumption are the largest expenditure components, with a combined weight in total expenditure of more than two-thirds.³⁷

From these 15 components of government revenue and 12 categories of government expenditure, fiscal aggregates are produced through identities. For example, on the revenue side, direct taxes on households and direct taxes on corporations are added to generate direct taxes, while, on the expenditure side, the summation of pension benefits, unemployment benefits and other social benefits in cash produces social benefits in cash. Charts 3 and 4 provide a schematic representation of the revenue and expenditure sides, respectively.

Besides government revenue and government expenditure, and their main components, model users are likely to be interested in key fiscal variables, such as government consumption, the government balance, the government primary balance and government debt.³⁸ These key fiscal variables can easily be computed since they are composed almost entirely of variables that emerge from the revenue side and the expenditure side.³⁹ Moreover, since the variables

³⁷ These figures are based on shares as at 2014.

³⁸ For definitions of these key fiscal variables, see Grech (2014b).

³⁹ The only two variables that are needed to calculate the key fiscal variables but do not emerge from the revenue side or from the expenditure side are consumption of fixed capital and the deficit-debt adjustment.

needed to compute these key fiscal variables are determined endogenously, the response of the latter is also endogenous. For example, since government consumption is equal to the summation of public sector compensation of employees, intermediate consumption, social benefits in kind and consumption of fixed capital, less sales, and, except for consumption of fixed capital, these components have an endogenous response, government consumption will also be determined in an endogenous manner.

In practice, governments are restricted by the inter-temporal government budget constraint, which implies that, for debt to be sustainable, the initial government debt and the interest accumulated over time have to eventually be paid through sufficiently large primary balances.⁴⁰ For this reason, the fiscal block includes a fiscal rule that is activated in long-run simulations to ensure some degree of fiscal solvency. This is achieved by adjusting the direct tax rate on households to reach a target debt ratio with a threshold value of 60%.^{41,42,43}

In this context, consumption of fixed capital refers to depreciation of public sector capital, while the deficit-debt adjustment, commonly referred to as the stock-flow adjustment, captures those transactions or factors that influence the outstanding debt but are not reflected in the primary balance. For further details on the deficit-debt adjustment, see Farrugia and Grech (2013). In the model, both consumption of fixed capital and the deficit-debt adjustment are given an exogenous path.

⁴⁰ For further details on fiscal sustainability, see Farrugia and Grech (2013) and references therein.

⁴¹ See Mitchell, Sault and Wallis (2000) for a comparison of fiscal rules.

⁴² For further details on the fiscal block, particularly the data used, see Grech (2014b).

⁴³ For an application of the fiscal block, namely calculating the size of fiscal multipliers in Malta, see Borg, Grech and Micallef (2015).

Chart 3 – Schematic Representation of the Fiscal Block (Revenue Side)

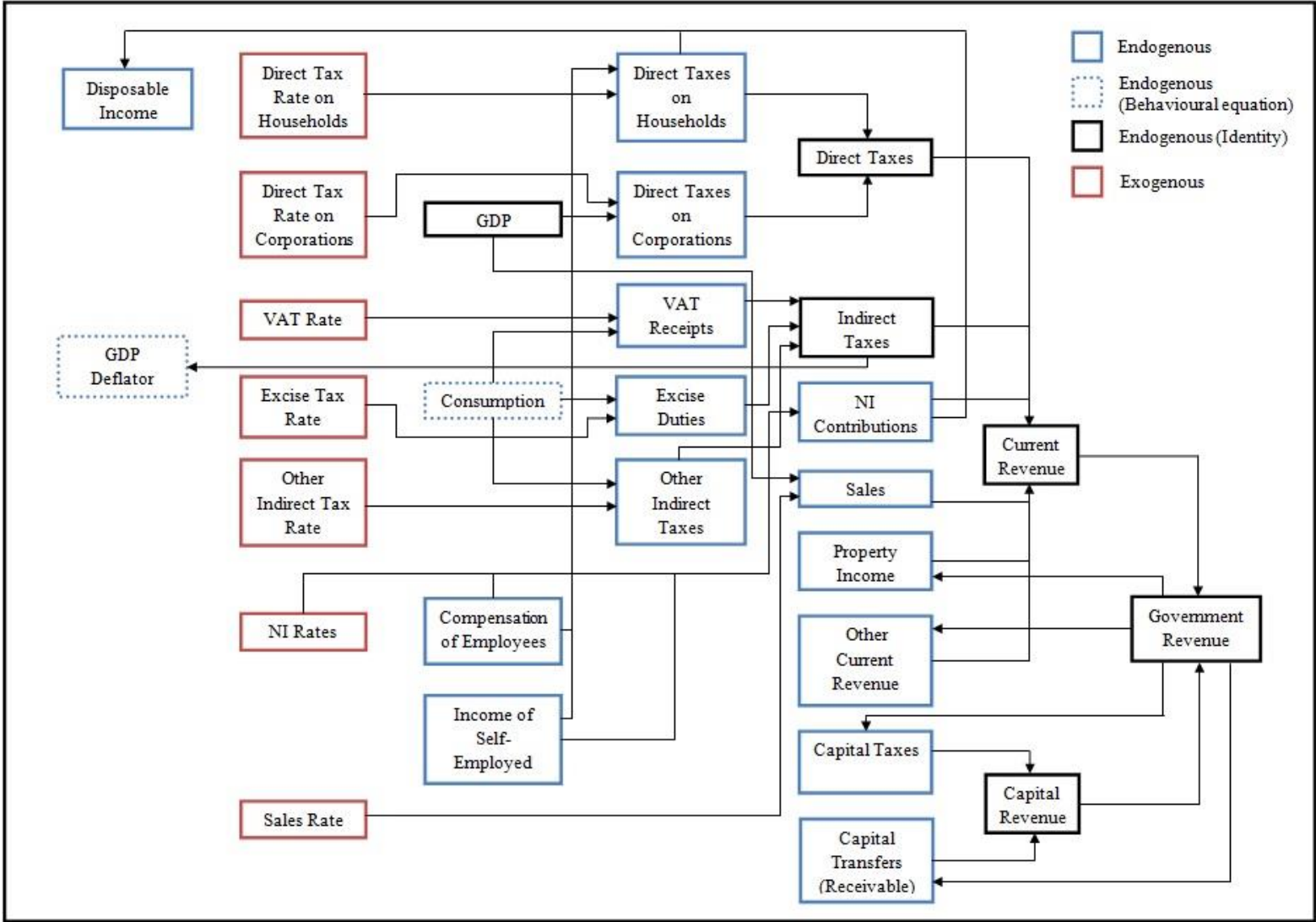
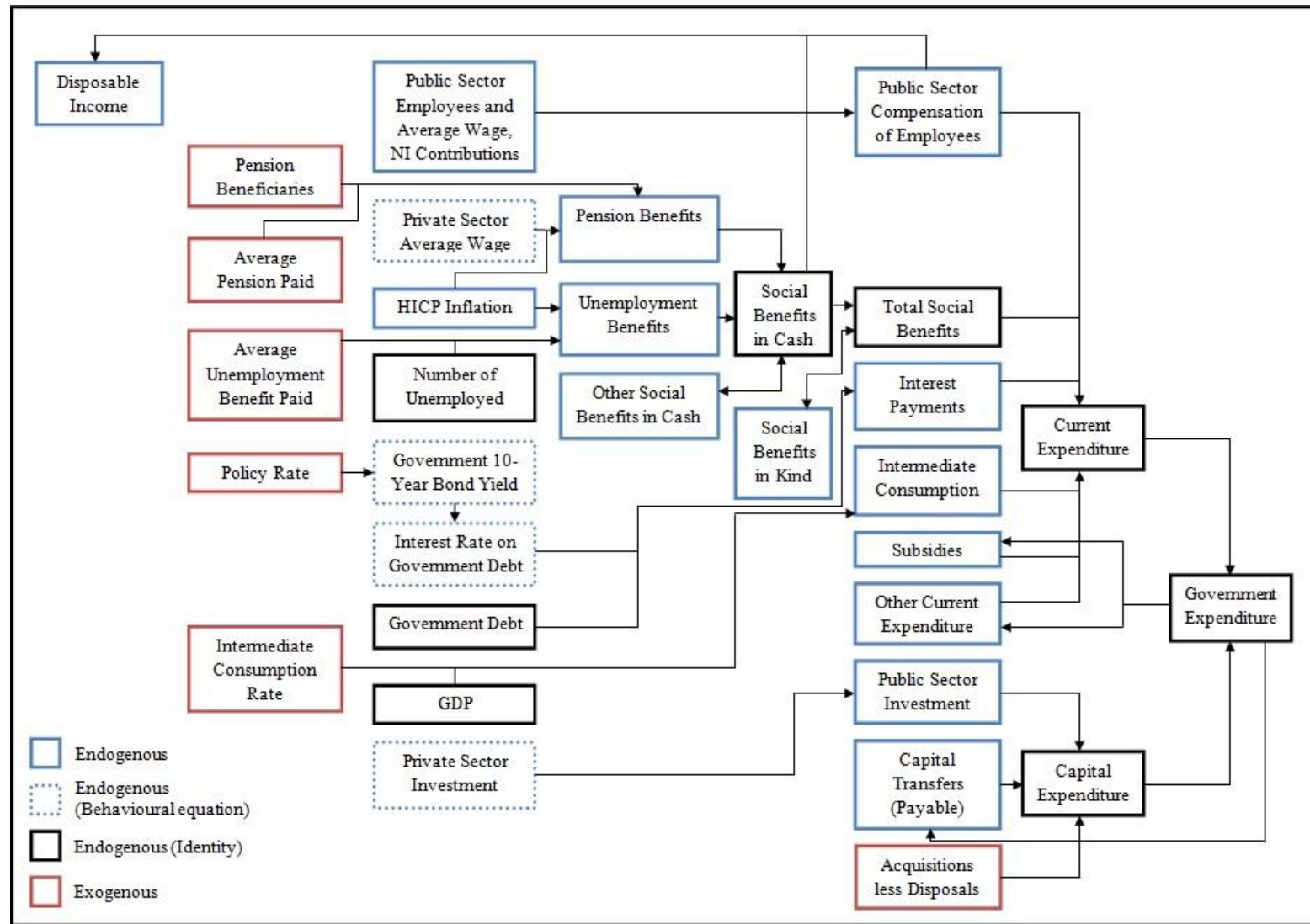

Chart 4 – Schematic Representation of the Fiscal Block (Expenditure Side)



3.5 The Financial Block

The financial block models credit, interest rates, non-performing loans, the banking sector's profit and loss account and balance sheet, as well as house prices. The block explicitly models both demand and supply side aspects of credit intermediation in Malta allowing the model to generate a financial accelerator mechanism through the co-movement of credit and asset prices as well as credit constraints emanating from the financial health of Maltese banking institutions.

A distinction is made between three types of credit – consumer and other credit, housing credit and credit to non-financial corporations – each of which is modelled through a behavioural equation (see annexes A.2.16-A.2.18) . In line with other models in its class, the demand side of each credit type is affected by indicators that are thought to directly affect economic agents' demand for credit. Real credit for consumption purposes is affected by real consumption, both in the short run and also in the long run. Real credit to non-financial corporations is influenced by real GDP in the short run and real non-dwelling private investment in the long run. Real credit to households for mortgages is determined by disposable income in the short run and by house prices both in the short and long run. In addition, all credit types are negatively affected, both in the short run and the long run, by their specific lending rates as well as by the credit risk associated with each type of credit.

This, together with the way in which bank lending rates are determined in the model, allows the introduction of supply side considerations that affect overall credit extended by the banking system. Indeed, unlike other traditional structural models, STREAM possesses a fully-fledged banking sector framework which allows the explicit modelling of macro-financial linkages by taking into account both the health of Maltese financial intermediaries as well as the links that exist between savings generated by the economy and credit developments. Also, the endogenous determination of the banking sector's profit or loss and balance sheet allows the model to capture the simultaneous response that exists between developments in the real economy and banks' ability and willingness to extend credit, allowing the model to be used for financial stability and macro-prudential purposes.

The model distinguishes between four retail rates; three bank lending rates that determine the price of the three types of private credit considered in the model and a deposit rate that determines the return on deposits held at local banks (see annexes A.2.19-A.2.22). In contrast to the majority of macro-econometric models in its class, the retail rates in the model are determined via augmented pass-through equations that are designed to capture three transmission channels; a direct interest rate channel, an indirect interest rate channel and a probability of default channel.

The direct interest rate channel predicts that a monetary tightening by the central bank is transmitted in an imperfect way to the four retail rates considered in STREAM. The extent of the pass-through depends on the level of risk faced by the banks – captured by the probability of default channel – as well as on specific bank characteristics that can raise or lower the costs of financing – a channel referred to as the indirect interest rate channel.

With regard to the latter channel, there are two alternative theories which can explain a varying degree of pass-through owing to changes in the cost of financing of banks; the bank lending theory and the bank capital theory.⁴⁴ According to the bank lending thesis, an exogenous drop in bank deposits cannot be completely offset by the issue of other forms of finance, such as bonds. Since these types of liabilities are uninsured and are subject to asymmetric information issues, the interest rates of such financial assets carry a premium to compensate investors for the higher risk. Therefore, following a negative shock to their deposits, banks will usually find it cheaper to restore their liquidity position by increasing deposit rates to attract new deposits rather than issuing new bank debt, especially when operating in relatively less developed financial systems. This rise in deposit rates will then be accompanied by increases in bank lending rates as banks try to protect their net interest margins. The bank lending proposition is introduced by augmenting the commercial interest rate pass-through equations with a cost of funding indicator.⁴⁵ Given that most of the

⁴⁴ These two theories provide two different propositions of how the indirect interest rate channel works. Therefore, they can be seen as two mutually exclusive ways of how to model the cost of funding channels of commercial banks. Despite the fact that only one theory can be operative at each point in time, both theories are retained in the model. Indeed, despite the similarity in the way these two theories operate within the model, as well as in the simulation results they produce, both theories can provide unique interpretations of the manner in which some shocks are transmitted to the economy.

⁴⁵ This study augments the simple pass-through equations discussed in Gauci and Micallef (2014).

financing needs of Maltese banks are serviced through deposits, the loan-to-deposit ratio is a good gauge of the maturity transformation risk faced by banks and can thus be used as a cost of funding indicator that allows for the simultaneous analysis of both the asset and liability sides of Maltese banks.⁴⁶

The bank capital theory is based on two hypotheses. First, the market for bank equity is imperfect and therefore banks cannot issue new capital without incurring costs. Second, commercial banks are subject to risk-based regulatory capital requirements that limit the supply of credit. These two conditions imply the failure of the Modigliani-Miller theorem for bank lending, suggesting that bank credit will depend on the financial structure of the bank.⁴⁷ When capital is sufficiently low, either due to credit defaults or other losses, banks will find it too costly to recapitalise through the issue of new shares.⁴⁸ Therefore, they will opt to reduce credit, either directly through credit rationing, or by increasing bank lending rates, which, in turn, also increases profits and therefore boosts capital accumulation, raising the capital adequacy ratio to optimal levels. In line with the literature, the bank capital channel is captured by introducing the amount of bank capitalisation relative to its risk-weighted assets or the capital adequacy ratio held in excess of an exogenously set minimum requirement.⁴⁹ Since regulatory bodies can impose changes in the capital requirements of banks, the financial block includes a banking regulation rule. When switched on, this mechanism ensures the compliance of banks to any changes in their capital adequacy requirements, also taking into account any phase-in periods allowed by the new regulations.

The third channel used to model the determination of domestic retail rates is the probability of default channel. This channel predicts that an increase in the credit risk of some classes of assets will prompt banks to re-allocate their portfolio towards less risky assets. In the case of

⁴⁶ See Van den End (2013).

⁴⁷ See Modigliani and Miller (1958).

⁴⁸ Literature shows that even if the capital requirement is not binding at a specific point in time, low capitalised banks may find it optimal to forgo profitable lending to lower the risk of future capital inadequacy. Therefore, banks will seek to retain an optimal capital adequacy ratio, which is above the minimum required by regulatory bodies. For a more in-depth discussion, see Van den Heuvel (2002).

⁴⁹ In studies such as Gambacorta and Mistrulli (2004), the measure of excess bank capitalisation used is the total capital adequacy ratio held in excess of a minimum of eight percent, as required by the European Commission's capital requirement directive IV. Other studies, such as Miani, Nicoletti, Notarpietro and Pisani (2012), suggest using the capital adequacy ratio held in excess of an endogenous minimum requirement that takes in consideration the overall riskiness of the bank's portfolio.

increases in the probabilities of default of credit, banks will either seek to reduce their credit exposure by shifting their portfolio to less risky alternatives (such as government or corporate bonds), in effect rationing credit supply to the private sector, or else continue extending credit, though at higher interest rates as compensation for the higher credit risk exposure. Similar to the other channels, the probability of default channel was included in the retail rates pass-through equations, allowing bank lending rates to respond positively following higher credit risk faced by banks. Contrary to the other channels, the probability of default channel was also included in the credit equations, which allows banks to directly ration credit availability in the event of higher probabilities of default.⁵⁰

The link between developments in the real economy and banking sector conditions is modelled by introducing a stylised framework for the Maltese banking system. The approach adopted is similar to the one recently used by the Banca d'Italia in the extension to its core macro-econometric model that allows for the determination of a number of important banking variables, such as risk-weighted assets, probabilities of default, bank profits, bank equity and deposits.⁵¹ A schematic representation of the financial block is displayed in Chart 5.

On the profit and loss side of the block, the most significant variable is net interest income, which is assumed to grow in line with total credit and the net interest rate spread between lending and deposit rates (see annex A.2.25). Given that government debt makes up the majority of the non-credit assets of Maltese banks, non-interest income is assumed to grow proportionally with government debt outstanding, and to be positively related to government bond yields (see annex A.2.26). Operating expenses are positively affected by total credit and private wages, while net provisions are assumed to grow in line with non-performing loans, assuming a constant coverage ratio (see annex A.2.27).

The law of motion for capital assumes that equity accumulates with profits after tax and the distribution of dividends, both of which are assumed to be a fixed proportion of profits before

⁵⁰ Contrary to the probability of default channel, the hypothesis that credit volumes can be directly affected by both bank lending and bank equity theories was rejected by the data.

⁵¹ See Miani, Nicoletti, Notarpietro and Pisani (2012).

tax.⁵² The financial block distinguishes between two types of probabilities of default; one for household credit and another for credit to non-financial corporations. In line with Buncic and Melecky (2012), the probabilities of default are determined via an identity that links their dynamics to those of non-performing loan rates. The latter are determined by two behavioural equations linking the long-run evolution of non-performing loans to a measure of leverage, proxied by the ratio of net wealth to total gross wealth (see annexes A.2.23-A.2.24). In the short run, non-performing loan dynamics are determined by lagged real GDP, as well as the lagged difference between real house price growth and real mortgage rates (for household non-performing loans) and the lagged unemployment rate (for non-financial corporation non-performing loans). Risk weighted assets are modelled consistently with the method adopted in banking supervision regulatory guidelines.

Deposits are determined as the difference between total private savings generated by the economy and the change in general government debt. This assumes that the economy's private savings can be either used to finance government debt or deposited at local banks, and that economic agents will always demand enough government bonds to cover the financing needs of the public sector. This simple framework allows for a direct link to exist between savings, deposits and, ultimately, private sector credit via the transmission channels explained above. Also, it introduces an element of crowding out, through which extra credit demanded by the Government will adversely affect bank deposits and, eventually, bank lending via the indirect interest rate channel.

This setup for the financial block also allows for the partial modelling of local household investment income. The endogenous determination of deposits, credit and banks' profits or losses allows net investment income to depend on the amount of net household deposits, commercial lending and deposit rates, and bank dividends earned.

Unlike the rest of the financial block, house price determination does not take into account supply side considerations pertaining to the availability of housing stock (see annex A.2.28). In the short run, nominal house prices are positively affected by developments in nominal

⁵² In the event that banks incur losses, dividends and taxes paid are assumed to be zero.

mortgages and disposable income, and negatively influenced by changes in the unemployment rate. In the long run, property prices are assumed to grow in line with nominal disposable income so as to ensure the long-run affordability of house prices. While the impact of interest rates on house prices was not statistically significant, changes in interest rates still exert an indirect impact on property prices through their effects on labour market variables and bank credit to households for mortgages.⁵³

⁵³ For further details on the financial block, see Rapa (2015).

3.6 Changes between Version 2.0 and 3.0

This third version of the model includes two key upgrades when compared to the previous version: (i) it has been extended to include an even richer financial block, and (ii) has been re-estimated using more recent ESA 2010, chain-linked data.

3.6.1 Changes to the Financial Block

The recent global financial crisis was a bitter reminder of the strong ties that exist in many economies between the financial sector and the broader economy. The model has been enhanced with a more detailed financial block that captures more of the inter-linkages that exist, not only within the financial sector itself, but also between the financial sector and the broader economy, so called macro-financial linkages. In particular, the model now contains two new channels – the indirect interest rate channel and the probability of default channel – as well as an aggregate banking sector framework, both aimed towards modelling credit supply constraints in a richer manner by taking into account the health of the banking sector, in terms of both liquidity as well as solvency.⁵⁴

In light of the four key uses of the model mentioned previously, the enhanced financial block is useful in a number of ways. First, it improves the capacity to conduct simulations on two fronts. On the one hand, the block captures the impact of shocks on a broader range of financial variables. For example, it can gauge the impact a monetary policy shock has on the probability of default, risk-weighted assets and the capital adequacy ratio. On the other hand, it opens up channels that allow for a broader range of shocks, making it possible, for instance, to study the macro-economic effect of an increase in banks' risk-weighted assets. Second, the richer financial block can complement the Bank's current forecasting framework even further, particularly with regard to medium to long-term forecasts, since it can produce more detailed forecasts when compared to earlier versions of the model. A third reason behind the new financial block's usefulness is that it broadens the policy questions that can be addressed. In particular, it can serve as a tool for macro-prudential policy. Since banks'

⁵⁴ Further details on the financial block can be found in section 3.5.

balance sheets are determined endogenously, which allows for a simultaneous response between developments in the real economy and banks' ability and willingness to extend credit, it is possible to study, for example, the impact caps on loan-to-value ratios, limits on credit growth, other balance sheet restrictions or capital requirements will have not only on the financial system itself, but also on the broader economy. Finally, modelling the financial sector – a key sector that bears strong links with the rest of the economy – in greater detail, provides a deeper, more complete understanding of how the Maltese economy functions.

3.6.2 Re-estimation

The previous version of the model was estimated until 2012Q4, using ESA 1995, constant base year (non-chain-linked) data. In 2014Q3, the National Statistics Office introduced two key methodological changes to national accounts data, namely, the shift from ESA 1995 to ESA 2010, and the transition from constant base year to chain-linked data. In view of this, this version of the model is re-estimated using an additional year of data, that is, until 2013Q4, using ESA 2010, chain-linked data.

The introduction of ESA 2010 has mainly affected the treatment of research and development spending and the classification of units within or outside the government sector. However, it coincided with a periodic revision that largely reflects the introduction of special purpose entities (SPEs), revisions to the insurance sector, alignment with balance of payment statistics, regular revisions, new data sources, the harmonisation of the measurement of certain illegal activities, reclassifications and changes to national methodologies.⁵⁵

Under the previous 'constant base year' methodology, real values of GDP were weighted using their value share in the whole economy in a particular year. This approach assumes that the value shares do not change over time. In a dynamic economy, where the relative importance of different goods and services changes rapidly, this methodology is likely to be unsuitable. Chain linking is a method that aggregates real GDP based on weights that are

⁵⁵ For further details on the transition from ESA 1995 to ESA 2010 and the periodic revision, including what these changes incorporate and the impact they have had on Maltese national accounts data, see Pace Ross, Bonello and Dimech (2014).

updated frequently. Rather than relying on the value shares from a fixed base year, real values for each year are produced on the basis of prices in the previous year. There are different techniques for chain linking quarterly data. The one used in Maltese national accounts is the annual overlap method. Finally, it is worth noting that chain-linked volume series are non-additive. For example, the components of GDP in real terms do not add up to the aggregate real GDP figure.^{56,57}

Re-estimating the model with recent data ensures that it remains a faithful representation of how the domestic economy functions. Despite considerable changes in national accounts data, many of the key relationships underlying the Maltese economy have remained broadly unchanged.

⁵⁶ Refer to Robjohns (2006) and Scheiblecker (2010) for additional details on chain linking.

⁵⁷ See Pace Ross, Bonello and Dimech (2014) for further details on the chain linking of Maltese national accounts data.

4. Simulation Results

To illustrate the properties of the model, this section presents the results of six simulations. The first five simulations are standard: a world demand shock, an oil price shock, an exchange rate shock, a monetary policy shock and a government consumption shock. Unlike most traditional structural macro-econometric models, STREAM is equipped with a detailed financial block and thus caters for a range of financial simulations. The sixth simulation is therefore a financial one, namely a shock to non-performing loans. The scope of simulation analysis is largely twofold. First, it sheds light on the dynamic properties of the model and the main propagation channels. Second, it allows us to examine the plausibility of the simulation results the model generates, both from a theoretical and an empirical perspective.

4.1 World Demand Shock

The world demand shock is defined as a permanent increase in total world demand by one percent.⁵⁸ An increase in world demand leads to higher exports, and thus GDP (see table 1). This boosts employment and wages, and hence disposable income, which, in turn, raises private consumption. Buoyant economic activity also gives rise to an increase in government consumption, as a result of higher public compensation of employees and public intermediate consumption, as well as an increase in investment. These developments stimulate GDP further, but this is partially offset by a rise in imports. The increase in GDP exerts upward pressure on prices. This brings about a loss in competitiveness and consequently export growth slows down gradually. Higher GDP results in lower unemployment. Turning to fiscal developments, government revenue rises due to higher macroeconomic bases. Government expenditure also increases because of the rise in public compensation of employees, public intermediate consumption and government investment. The net effect translates into an increase in the government balance ratio – implying an improvement in the deficit ratio – which causes the government debt ratio to fall.

⁵⁸ Following common practice, the fiscal rule was switched off in all simulations.

Table 1 - The Macroeconomic Impact of a World Demand Shock*Percentage changes from baseline levels unless otherwise specified*

	Year 1	Year 2	Year 3
Economic Activity			
Real GDP	0.54	0.66	0.62
Private Consumption	0.07	0.52	0.53
Government Consumption	0.22	0.32	0.15
Gross Fixed Capital Formation	0.32	0.76	0.66
Exports	1.00	0.84	0.73
Imports	0.60	0.73	0.61
Price Developments			
GDP Deflator	0.03	0.19	0.44
Labour Market			
Unemployment Rate*	-0.01	-0.06	-0.06
Fiscal Developments			
Balance**	0.04	0.14	0.17
Gross Debt**	-0.44	-0.78	-1.08
Financial Developments			
Loans to the Private Sector	0.17	0.48	0.70
Non-Performing Loans Ratio*	0.01	-0.02	-0.01
House Prices	0.03	0.49	0.82

* Absolute changes from baseline in percentage points.

** Absolute changes from baseline as a percent of GDP.

Source: author's calculations.

4.2 Oil Price Shock

This shock is defined as a permanent increase in the price of oil by 20 percent. Higher oil prices exert upward pressure on domestic prices throughout (see table 2). Elevated export prices lead to a loss in competitiveness. This, in turn, translates into lower exports, and thus GDP. As a result, employment and real wages decline, which brings about a reduction in disposable income, and hence private consumption. Subdued economic activity also causes a decrease in government consumption, due to a fall in real public compensation of employees and public intermediate consumption, as well as a drop in investment. Consequently, GDP contracts further, offset to some degree by lower imports. As a result of declining GDP, prices grow only moderately in the second and third years of the simulation horizon. Turning to unemployment, in the first year, despite the contraction in GDP, the unemployment rate falls slightly since the decline in the labour force marginally outweighs the reduction in

employment. In the following years, however, the latter effect dominates and thus the unemployment rate rises.

Table 2 - The Macroeconomic Impact of an Oil Price Shock

Percentage changes from baseline levels unless otherwise specified

	Year 1	Year 2	Year 3
Economic Activity			
Real GDP	-0.20	-0.32	-0.38
Private Consumption	-0.27	-0.48	-0.54
Government Consumption	-0.19	-0.05	-0.22
Gross Fixed Capital Formation	-0.07	-0.39	-0.45
Exports	-0.31	-0.46	-0.53
Imports	-0.33	-0.46	-0.53
Price Developments			
GDP Deflator	0.07	0.02	0.02
Labour Market			
Unemployment Rate*	-0.01	0.02	0.06
Fiscal Developments			
Balance**	0.02	-0.03	-0.06
Gross Debt**	0.07	0.22	0.32
Financial Developments			
Loans to the Private Sector	0.32	-0.01	-0.04
Non-Performing Loans Ratio*	0.04	0.06	0.11
House Prices	0.28	0.27	0.00

* Absolute changes from baseline in percentage points.

** Absolute changes from baseline as a percent of GDP.

Source: author's calculations.

With regard to fiscal developments, in the first two years, even though GDP shrinks, government revenue increases because some macroeconomic bases expand in nominal terms on the back of higher prices. However, in the final year of the simulation horizon, government revenue decreases, as the effect of subdued economic activity is reinforced by a drop in macroeconomic bases, even in nominal terms. In the case of government expenditure, it decreases marginally in the first year, largely due to lower intermediate consumption. In the outer years of the simulation horizon, however, government expenditure rises. This occurs mainly because the increase in nominal public compensation of employees, brought about by the gradual pass through of elevated prices, coupled with higher social benefits resulting from rising unemployment, outweigh the drop in intermediate consumption. These developments give rise to an improvement in the government balance ratio in the first year, but a deterioration thereafter. The government debt ratio rises, even in the first year where an

improvement in the balance ratio is recorded, since the fall in nominal GDP outweighs this effect.

4.3 Exchange Rate Shock

The exchange rate shock is defined as a permanent appreciation of the euro vis-à-vis the dollar by ten percent. The appreciation of the euro lowers import prices, which, in turn, reduces the price of exports (see table 3). Export prices, however, do not fall as fast as those of competitors which leads to a loss in competitiveness. As a result, exports, and hence GDP, decline. This brings about a decrease in employment and wages. Government consumption contracts because of the drop in public compensation of employees and public intermediate consumption. The decline in GDP also dampens investment. Despite the reduction in employment and wages, real disposable income rises, on the back of lower prices. Overall, however, GDP still falls further, but this is partially offset by lower imports. Subdued economic activity exerts downward pressure on prices, which improves competitiveness, in turn reducing the negative impact of the shock on exports. The decrease in GDP gives rise to higher unemployment. On the fiscal front, government revenue shrinks due to lower macroeconomic bases. This effect outweighs the decline in government expenditure brought about by the decrease in public compensation of employees, public intermediate consumption and government investment. Consequently, the government balance ratio deteriorates, which causes the government debt ratio to increase.

Table 3 - The Macroeconomic Impact of an Exchange Rate Shock*Percentage changes from baseline levels unless otherwise specified*

	Year 1	Year 2	Year 3
Economic Activity			
Real GDP	-0.23	-0.20	-0.12
Private Consumption	0.09	-0.01	0.12
Government Consumption	-0.06	-0.14	-0.03
Gross Fixed Capital Formation	-0.18	-0.21	-0.15
Exports	-0.44	-0.24	-0.14
Imports	-0.19	-0.15	-0.02
Price Developments			
GDP Deflator	-0.08	-0.20	-0.40
Labour Market			
Unemployment Rate*	0.01	0.03	0.01
Fiscal Developments			
Balance**	-0.04	-0.08	-0.09
Gross Debt**	0.26	0.41	0.58
Financial Developments			
Loans to the Private Sector	-0.26	-0.46	-0.63
Non-Performing Loans Ratio*	-0.01	0.03	-0.01
House Prices	-0.17	-0.50	-0.67

* Absolute changes from baseline in percentage points.

** Absolute changes from baseline as a percent of GDP.

Source: author's calculations.

4.4 Monetary Policy Shock

This shock is defined as a permanent increase in the policy rate by 50 basis points that also leads to an appreciation of the euro against other currencies by 0.5%. A contractionary monetary policy shock raises lending rates and thus reduces the demand for credit (see table 4). A decrease in the demand for mortgages exerts downward pressure on house prices, which causes net wealth to decline. As a result of a higher lending rate to households, as well as lower demand for credit by households and net wealth, private consumption falls. Investment also contracts due to an increase in the user cost of capital together with weaker demand for credit and house prices. The appreciation brought about by the monetary policy shock, gives rise to a loss in competitiveness and, consequently, a drop in exports. The declines in private consumption, investment and exports result in lower GDP. This leads to a decrease in employment and wages. Subdued economic activity also gives rise to a fall in government consumption, because of reductions in public compensation of employees and public intermediate consumption, and dampens investment even further. These developments cause

GDP to contract more, offset to some degree by lower imports. Weak economic activity exerts downward pressure on prices, which improves competitiveness, in turn reducing the negative impact of the shock on exports. The decline in GDP translates into higher unemployment.

Table 4 - The Macroeconomic Impact of a Monetary Policy Shock
Percentage changes from baseline levels unless otherwise specified

	Year 1	Year 2	Year 3
Economic Activity			
Real GDP	-0.05	-0.08	-0.08
Private Consumption	-0.08	-0.24	-0.16
Government Consumption	-0.01	-0.04	-0.03
Gross Fixed Capital Formation	-0.09	-0.53	-0.62
Exports	-0.07	-0.03	-0.01
Imports	-0.10	-0.19	-0.14
Price Developments			
GDP Deflator	-0.01	-0.03	-0.06
Labour Market			
Unemployment Rate*	0.00	0.01	0.01
Fiscal Developments			
Balance**	-0.07	-0.13	-0.17
Gross Debt**	0.11	0.28	0.46
Financial Developments			
Loans to the Private Sector	-0.70	-1.34	-1.78
Non-Performing Loans Ratio*	0.16	0.10	0.06
House Prices	-0.21	-0.82	-1.20

* Absolute changes from baseline in percentage points.

** Absolute changes from baseline as a percent of GDP.

Source: author's calculations.

On the fiscal front, government revenue shrinks due to lower macroeconomic bases. This adverse impact on government finance is reinforced by elevated government expenditure, as a result of higher interest payments paid by the Government outweighing declines in public compensation of employees, public intermediate consumption and government investment. Consequently, the government balance ratio deteriorates, which causes the government debt ratio to rise. Turning to financial developments, the increase in bank lending rates, together with weaker economic activity, bring about a rise in non-performing loans which, in turn, raises the probability of default of non-financial corporations and households. The latter are also affected by the fall in house prices, which reduces the incentive of mortgage holders to honour their debt. The probability of default channel prompts banks to decrease the volume

of loans extended to the private sector, both directly via credit rationing, as well as indirectly through an increase in lending rates. The slowdown in private credit improves the liquidity position of the banking sector, which, consequently, exerts downward pressure on deposit rates through the bank lending channel. This partially offsets the rise in deposit rates following the contractionary monetary policy shock. On balance, the effects of higher interest rate margins outweigh those of the probability of default channel, which leads to an increase in bank profits and the capital adequacy ratio.

4.5 Government Consumption Shock

The government consumption shock is defined as a permanent increase in public intermediate consumption that leads to an *ex-ante* change in the share of nominal government consumption in nominal GDP by one percentage point.⁵⁹ The rise in government consumption results in an immediate increase in GDP (see table 5). This leads to higher employment and wages, and hence disposable income, which, in turn, raises private consumption. Moreover, the increase in GDP also stimulates investment. These developments bring about a further rise in GDP, offset to some degree by higher imports. This raises the output gap which, in turn, leads to an increase in prices. Higher prices give rise to a loss in competitiveness and thus a decline in exports. Still, the net effect on GDP is positive, which translates into lower unemployment. On the fiscal side, as a result of the increase in government consumption, government expenditure rises. Due to higher macroeconomic bases, government revenue also rises, but, on balance, the government balance ratio deteriorates and, consequently, the government debt ratio increases.

⁵⁹ This is equivalent to an *ex-ante* increase in public intermediate consumption equal to one percent of nominal GDP.

Table 5 - The Macroeconomic Impact of a Government Consumption Shock*Percentage changes from baseline levels unless otherwise specified*

	Year 1	Year 2	Year 3
Economic Activity			
Real GDP	0.78	0.87	0.76
Private Consumption	0.11	0.72	0.56
Government Consumption	5.18	5.31	4.99
Gross Fixed Capital Formation	0.50	1.02	0.81
Exports	-0.05	-0.24	-0.36
Imports	0.44	0.61	0.37
Price Developments			
GDP Deflator	0.05	0.26	0.65
Labour Market			
Unemployment Rate*	-0.02	-0.08	-0.09
Fiscal Developments			
Balance**	-0.95	-0.86	-0.84
Gross Debt**	0.38	1.03	1.65
Financial Developments			
Loans to the Private Sector	0.26	0.70	1.00
Non-Performing Loans Ratio*	0.02	-0.03	-0.02
House Prices	0.06	0.71	1.22

* Absolute changes from baseline in percentage points.

** Absolute changes from baseline as a percent of GDP.

Source: author's calculations.

4.6 Non-Performing Loans Shock

This shock is defined as a permanent *ex-ante* increase in non-performing loans by twenty percent. Following the shock in non-performing loans, the overall probability of default rises, leading to higher risk-weighted assets (see table 6). Together with the fall in bank equity, caused by an expansion in net provisions, the increase in risk-weighted assets lowers the capital adequacy ratio of the banking system. In an effort to address the deterioration in their solvency position, banks seek to boost net profits – thereby improving capital accumulation – by raising their net interest margin. Moreover, higher bank lending rates reduce the demand for credit, which dampens credit extended by banks. This partly offsets the increase in risk-weighted assets brought about by higher probabilities of default. The volume of credit extended by financial institutions is also affected by the probability of default channel. Elevated probabilities of default attached to bank lending prompt banks to re-allocate their asset portfolio towards less risky assets, thereby decreasing their exposure to bank credit, both by raising lending rates, as well as through direct credit rationing. These measures allow

banks to limit the decline in their capital adequacy ratio in the first year to around 0.10 percentage points. In subsequent years, banks continue to cut their credit exposure further by increasing their lending rates and rationing credit, improving their capital adequacy ratio to levels above those registered in the baseline scenario. The results therefore suggest that, when faced with a heightened degree of economic uncertainty, banks seek to raise their capital buffers in the medium term so as to be able to sustain adverse solvency shocks.⁶⁰

Table 6 - The Macroeconomic Impact of a Non-Performing Loans Shock

Percentage changes from baseline levels unless otherwise specified

	Year 1	Year 2	Year 3
Economic Activity			
Real GDP	-0.05	-0.08	-0.09
Private Consumption	-0.34	-0.41	-0.33
Government Consumption	-0.02	-0.04	-0.04
Gross Fixed Capital Formation	-0.05	-0.73	-0.88
Exports	0.00	0.02	0.03
Imports	-0.18	-0.26	-0.20
Price Developments			
GDP Deflator	-0.01	-0.03	-0.06
Labour Market			
Unemployment Rate*	0.00	0.01	0.01
Fiscal Developments			
Balance**	-0.06	-0.05	-0.04
Gross Debt**	0.09	0.18	0.25
Financial Developments			
Loans to the Private Sector	-1.73	-2.62	-3.36
Non-Performing Loans Ratio*	7.56	6.96	6.73
House Prices	-0.58	-1.18	-1.55

* Absolute changes from baseline in percentage points.

** Absolute changes from baseline as a percent of GDP.

Source: author's calculations.

Turning to developments in the broader economy, weaker demand for mortgages exerts downward pressure on house prices, which leads to a decline in net wealth. As a result of a higher lending rate to households, together with lower demand for credit by households and net wealth, private consumption contracts. Investment also falls because of an increase in the user cost of capital, as well as subdued demand for credit and house prices. Government consumption and exports remain broadly unchanged. Declines in private consumption and investment give rise to a decrease in GDP, offset to some degree by a rise in imports. The

⁶⁰ This result is in line with conclusions put forward by McShane and Sharpe (1985).

drop in GDP depresses investment even further. The slowdown in economic activity, translates into lower prices and higher unemployment. On the fiscal front, government revenue shrinks on the back of smaller macroeconomic bases. This outweighs the decline in government expenditure brought about by reductions in public compensation of employees, public intermediate consumption and government investment offset only partially by the increase in interest payments paid by the Government. As a consequence, the government balance ratio deteriorates, which causes the government debt ratio to rise.

The model therefore generates simulation results that are plausible from both a theoretical and an empirical perspective.⁶¹

⁶¹ For a range of simulation results, covering a number of shocks, that emerge from traditional structural macro-econometric models, see Fagan and Morgan (2005).

5. Conclusion

This paper presents the third version of the Central Bank of Malta's core macro-econometric model of the Maltese economy, STREAM. It is a traditional structural model built around the neo-classical synthesis. Behavioural equations are estimated in error-correction form on the basis of quarterly data spanning from 2000Q1 to 2013Q4. Economic agents are assumed to have adaptive expectations. The novelty of the model is that it contains detailed fiscal and financial blocks, which is uncommon in traditional structural models. Given the strong links these sectors share, not only with the broader economy but also between them, it is ideal to model them within the same framework.

This third version of the model includes two key upgrades when compared to the previous version: (i) it has been extended to include an even richer financial block, and (ii) has been re-estimated using ESA 2010, chain-linked data that span an additional year. Simulation results for six shocks illustrate the properties of the updated model and suggest that its mechanics are plausible from both a theoretical and empirical standpoint. STREAM is a valuable tool in the Bank's toolkit, particularly in view of recent developments, such as the increased attention directed towards macro-prudential policies aimed at safeguarding financial stability, and the sustainability of public finances, in the wake of the global financial crisis and the European sovereign debt crisis, respectively.

The development of STREAM has now reached an advanced stage and therefore no major changes to its structure are envisaged in the short term. That said, further refinements are possible, such as an enhanced integration of the supply side, particularly with regard to the labour market. Moreover, the model will continue to be evaluated on a regular basis to ensure that it is able to fulfil its ultimate purpose; serving as a reliable simplification of how the Maltese economy functions.

References

Angelini, E., F. Boissay and M. Ciccarelli (2006), “The Dutch Block of the ESCB Multi-Country Model”, European Central Bank Working Paper No. 646.

Angelini, E., A. D’Agostino and P. McAdam (2006), “The Italian Block of the ESCB Multi-Country Model”, European Central Bank Working Paper No. 660.

Bank of England (2000), “Economic Models at the Bank of England”, London: Bank of England.

Beņkovskis, K., and D. Stikuts (2006), “Latvia’s Macroeconomic Model”, Latvijas Banka Working Paper No. 2·2006.

Boissay, F. and J. P. Villette (2005), “The French Block of the ESCB Multi-Country Model”, European Central Bank Working Paper No. 456.

Borg, I., O. Grech and B. Micallef (2015), “Fiscal Multipliers in the Maltese Economy”, *Quarterly Review*, 48(3), pp. 59-68, Central Bank of Malta.

Buncic, D. and M. Melecky (2012), “Macroprudential Stress Testing of Credit Risk: A Practical Approach for Policy Makers”, World Bank Policy Research Working Paper No. 5936.

Daníelsson, Á., M. Gudmundsson, S. Haraldsdóttir, T. Ólafsson, Á.Ó. Pétursson and R. Sveinsdóttir (2009), “QMM: A Quarterly Macroeconomic Model of the Icelandic Economy”, Central Bank of Iceland Working Paper No. 41.

European Central Bank (2001), “A Guide to Eurosystem Staff Macroeconomic Projection Exercises”, Frankfurt: European Central Bank.

European Central Bank (2014), “Government Finance Statistics Guide”, Frankfurt: European Central Bank.

Fagan, G., J. Henry and R. Mestre (2001), “An Area-Wide Model (AWM) for the Euro Area”, European Central Bank Working Paper No. 42.

Fagan, G. and J. Morgan (eds.) (2005), *Econometric Models of the Euro-area Central Banks*, Edward Elgar.

Farrugia, J. and O. Grech (2013), “Assessing the Sustainability of Maltese Government Debt”, Central Bank of Malta Working Paper No. 04/2013.

Fenz, G. and M. Spitzer (2005), “AQM: The Austrian Quarterly Model of the Oesterreichische Nationalbank”, Oesterreichische Nationalbank Working Paper No. 104.

Friedman, M. (1957), *A Theory of the Consumption Function*, Princeton, New Jersey: Princeton University Press.

Gambacorta, L. and P. Mistrulli (2004), “Does Bank Capital Affect Lending Behaviour?”, *Journal of Financial Intermediation*, 13(4), pp. 436-457.

Grech, A. G. (2014), “An Estimate of the Possible Impact of Lower Electricity and Water Tariffs on the Maltese Economy”, Central Bank of Malta Working Paper No. 01/2014.

Grech, A. G. (2015), “The Macroeconomic Impact of the Income Tax Reductions in Malta”, Central Bank of Malta Working Paper No. 02/2015.

Grech, A. G. and B. Micallef (2013), “Assessing the Supply Side of the Maltese Economy Using a Production Function Approach”, *Quarterly Review*, 46(4), pp. 37-44, Central Bank of Malta.

Grech, O. (2014a), “A New Measure of Household Disposable Income for Malta”, Annual Report 2013, pp. 42-48, Central Bank of Malta.

Grech, O. (2014b), “A Fiscal Block for the Bank’s Structural Macro-Econometric Model of the Maltese Economy”, *Quarterly Review*, 47(2), pp. 60-67, Central Bank of Malta.

Grech, O. and B. Micallef (2014), “A Structural Macro-Econometric Model of the Maltese Economy”, Central Bank of Malta.

Grech, O., B. Micallef, N. Rapa, A. G. Grech and W. Gatt (2013), “A Structural Macro-Econometric Model of the Maltese Economy”, Central Bank of Malta Working Paper No. 02/2013.

Hall, R. E. and C. I. Jones (1999), “Why do Some Countries Produce So Much Output Per Worker than Others”, *The Quarterly Journal of Economics*, 114(1), pp. 83-116.

Hammersland, R. and C. B. Traeø (2012), “The Financial Accelerator and the Real Economy: A Small Macroeconomic Model for Norway with Financial Frictions”, Norges Bank Staff Memo 2/2012.

Hubrich, K. and T. Karlsson (2010), “Trade Consistency in the Context of the Eurosystem Projection Exercises: An Overview”, European Central Bank Occasional Paper Series No. 108.

Keynes, J. M. (1936), *The General Theory of Employment, Interest and Money*, London: Macmillan.

Livermore, S. (2004), “An Econometric Model of the Slovak Republic”, Financial Policy Institute, Ministry of Finance of the Slovak Republic.

Lucas, R. E. (1976), “Econometric Policy Evaluation: A Critique” in Brunner, K. and A. H. Meltzer (eds.), *The Phillips Curve and Labour Markets*, Carnegie-Rochester Conference Series on Public Policy, Vol. 1, pp. 19-46, Amsterdam: North Holland.

McShane, R. W. and G. Sharpe (1985), “A Time Series/Cross Section Analysis of the Determinants of Australian Trading Bank Loan/Deposit Interest Rate Margins: 1962-1981”, *Journal of Banking and Finance*, 9(1), pp. 115-136.

Miani, C., G. Nicoletti, A. Notarpietro, and M. Pisani (2012), “Banks’ Balance Sheets and the Macroeconomy in the Bank of Italy Quarterly Model”, Banca d'Italia Occasional Paper (Questioni di Economia e Finanza) No. 64.

Micallef, B. (2014), “A Multivariate Filter to Estimate Potential Output and NAIRU for the Maltese Economy”, Central Bank of Malta Working Paper No. 05/2014.

Micallef, B. and S. Attard (2015), “Assessing the Macroeconomic Impact of Extending Hotel Height Limitations”, Central Bank of Malta Working Paper No. 01/2015.

Micallef, B. and T. Gauci (2014), “Interest Rate Pass-through in Malta”, *Quarterly Review*, 47(1), pp. 71-82, Central Bank of Malta.

Mitchell, P., J. Sault and K. Wallis (2000), “Fiscal Policy Rules in Macroeconomic Models: Principles and Practice”, *Economic Modelling*, 17(2), pp. 171-193.

Modigliani, F. and R. Brumberg (1954), “Utility Analysis and the Consumption Function: An Interpretation of Cross-Section Data” in Kurihara, K. (ed.), *Post-Keynesian Economics*, New Brunswick, New Jersey: Rutgers University Press, pp. 388-436.

Modigliani, F. and M. H. Miller (1958), “The Cost of Capital, Corporation Finance and the Theory of Investment”, *The American Economic Review*, 48(3), pp. 261-297.

Pace Ross, M., J. Bonello and V. Dimech (2014), “A New National Accounts Framework”, *Quarterly Review*, 47(2), pp. 82-90, Central Bank of Malta.

Rapa, N. (2015), “The Banking Sector Extension to the Bank’s Macro-Econometric Model”, *Quarterly Review*, 48(3), pp. 78-85, Central Bank of Malta.

Robjohns, J. (2006), “Methodology Notes: Annual Chain-Linking”, *Economic Trends*, No. 630, Office for National Statistics.

Scheiblecker, M. (2010), “Chain-Linking in Austrian Quarterly National Accounts and the Business Cycle”, *OECD Journal: Journal of Business Cycle Measurement and Analysis*, Vol. 2010/1.

Sideris, D. and N. Zonzilos (2005), “The Greek Model of the European System of Central Banks Multi-Country Model”, Bank of Greece Working Paper No. 20.

Van den End, J. W. (2013), “A Macroprudential Approach to Address Liquidity Risk with the Loan-to-Deposit Ratio”, De Nederlandsche Bank Working Paper No. 372.

Van den Heuvel, S. (2002), “Does Bank Capital Matter for Monetary Transmission?”, *Economic Policy Review*, 8(1), pp. 259-265, Federal Reserve Bank of New York.

Vetlov, I. (2004), “The Lithuanian Block of the ESCB Multi-Country Model”, Bank of Finland BOFIT Discussion Papers No. 13.

Vetlov, I. and T. Warmedinger (2006), “The German Block of the ESCB Multi-Country Model”, European Central Bank Working Paper No. 654.

Willman, A. and A. Estrada (2002), “The Spanish Block of the ESCB Multi-Country Model”, European Central Bank Working Paper No. 149.

Annexes

A.1 The Steady State: the Long-Run Properties of the Model

This section presents the long run properties of the model. The long run solution cannot be interpreted as a forecast of the Maltese economy but just as a technical exercise to check the convergence to the stable path in the long run and the plausibility of the ratios obtained.

The long run solution of the model is plausible and realistic (see charts A.1.1-A.1.2). The great ratios converge gradually to more or less their historical averages. The output gap and the unemployment gap are closed in the steady state. The annual growth rate of prices converges to 2.0%.

Chart A.1.1 – Great Ratios

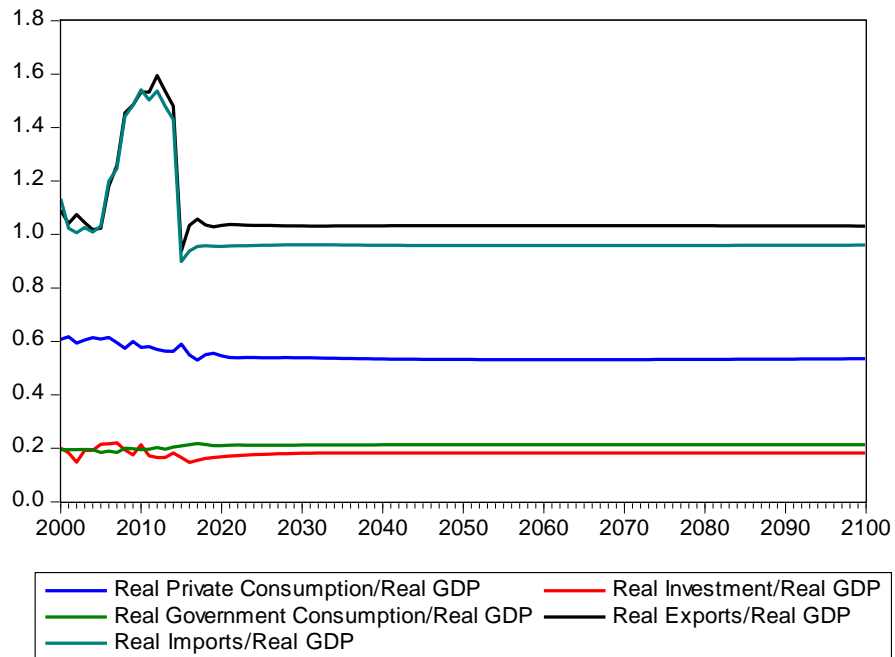
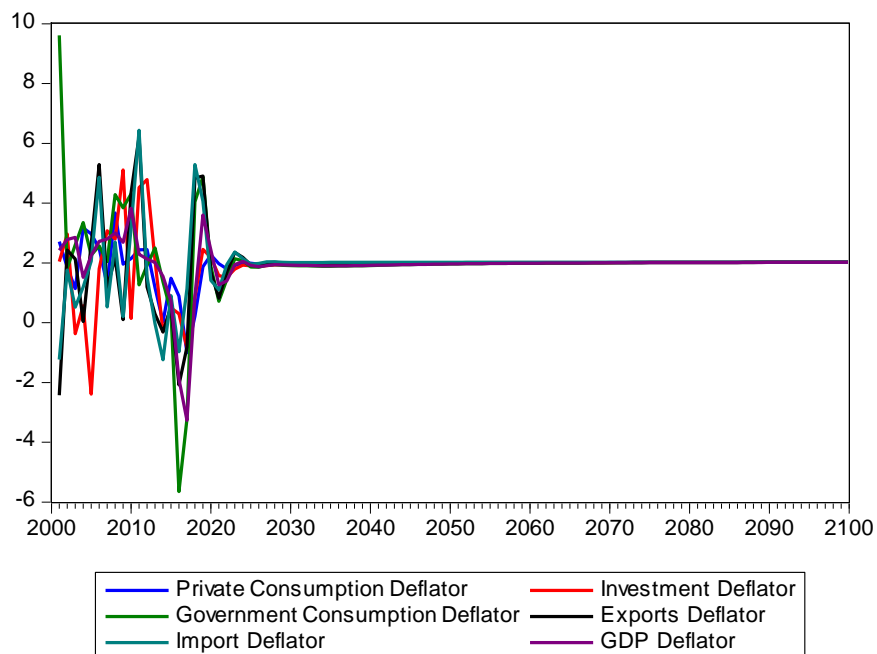

Chart A.1.2 – Prices (year-on-year growth rates)



A.2 Detailed List of Behavioural Equations

This annex describes the behavioural equations of the model which is estimated in EViews. Several conventions and functions are used in the presentation of the empirical results. Data are quarterly; LOG denotes the natural logarithm of a variable; D refers to the first-difference of the variable; @MOVAV(variable_name,n) denotes an n-quarter moving-average of a variable; @PCY refers to the annual percentage change in a variable; @SEAS(n)/100 refer to seasonal dummies. Lagged values are shown in brackets.

The regression output is divided into three panels. The top panel summarises the input to the regression (the dependent variable, the estimation method, the sample period, and the number of observations). The middle panel gives information about each regression coefficient (estimated coefficient, standard errors, T-statistics and the associated p-values). The bottom panel provides summary statistics about the whole regression equation, such as R^2 , adjusted R^2 , the standard error of the regression, the Durbin-Watson statistic and the F-statistic. Definitions of the model variables can be found in annex A.3. Two charts are also shown at the bottom. The first compares the actual data of the variable being modelled to the fitted data that emerges from the behavioural equation. The second displays the actual data, fitted data and residuals of the dependent variable.

Supply Block

A.2.1 Labour Supply

Dependent Variable: DLOG(LABFOR)

Method: Least Squares (Gauss-Newton / Marquardt steps)

Sample (adjusted): 2001Q1 2013Q4

Included observations: 52 after adjustments

$$\begin{aligned} \text{DLOG(LABFOR)} = & C_LF(1) + 0.5 \cdot \text{DLOG(TOTEMPLOY)} + C_LF(3) \\ & * \text{DLOG(GDPF)} + C_LF(4) * \text{DLOG(TOTWAGE(-3)/PCN(-3))} + C_LF(5) \\ & * \text{LOG(LABFOR(-1)/TOTEMPLOY(-1))} + C_LF(6) * @SEAS(2)/100 + \\ & C_LF(7) * @SEAS(3)/100 + C_LF(8) * @SEAS(4)/100 \end{aligned}$$

	Coefficient	Std. Error	t-Statistic	Prob.
C_LF(1)	0.035506	0.008942	3.970745	0.0003
C_LF(3)	0.090738	0.037395	2.426492	0.0193
C_LF(4)	0.103311	0.035497	2.910394	0.0056
C_LF(5)	-0.372064	0.118262	-3.146093	0.0029
C_LF(6)	-0.988847	0.665515	-1.485837	0.1443
C_LF(7)	-2.227557	0.940843	-2.367619	0.0223
C_LF(8)	-0.330388	0.279702	-1.181217	0.2437

R-squared	0.834132	Mean dependent var	0.003820
Adjusted R-squared	0.812016	S.D. dependent var	0.010749
S.E. of regression	0.004661	Akaike info criterion	-7.774728
Sum squared resid	0.000977	Schwarz criterion	-7.512060
Log likelihood	209.1429	Hannan-Quinn criter.	-7.674027
F-statistic	37.71667	Durbin-Watson stat	2.505169
Prob(F-statistic)	0.000000		

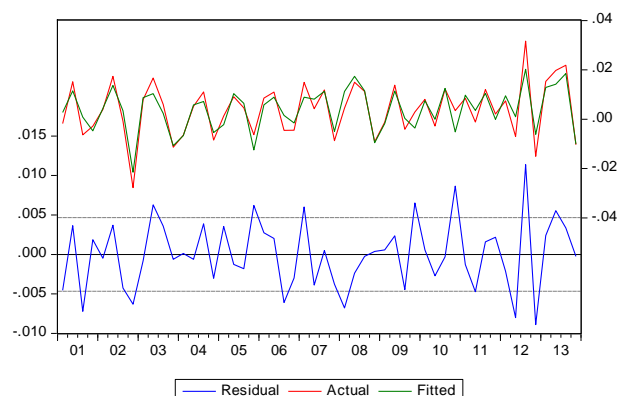
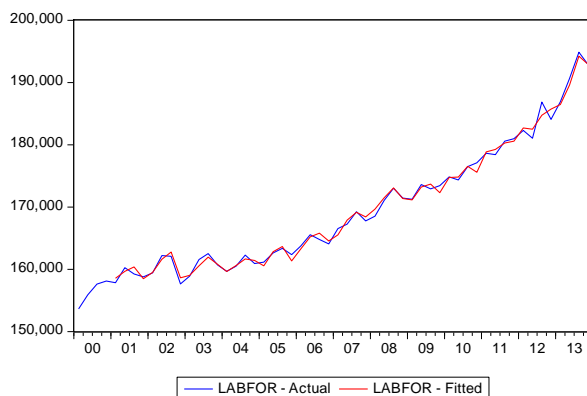

A.2.2 Employment

Dependent Variable: DLOG(TOEMPLOY)

Method: Least Squares (Gauss-Newton / Marquardt steps)

Sample: 2000Q1 2013Q4

Included observations: 56

$$\begin{aligned} \text{DLOG(TOEMPLOY)} = & C_EMP(1) + C_EMP(2)*\text{DLOG(GDPF(-1))} + \\ & C_EMP(4)*(\text{LOG(TOEMPLOY(-1))}-\text{LOG}(@\text{MOVAV}(\text{GDPF}(-1),4))) + \\ & C_EMP(5)*\text{LOG}(@\text{MOVAV}(\text{CPE}(-1)/\text{PGDP}(-1),4)) + C_EMP(6) \\ & *@\text{SEAS}(2)/100 + C_EMP(7)*@\text{SEAS}(3)/100 + C_EMP(8)*@\text{SEAS}(4) \\ & /100 + C_EMP(9)*\text{D02Q4}/100 + C_EMP(10)*\text{LOG}(@\text{MOVAV}(\text{TFPF} \\ & (-1),4)) \end{aligned}$$

	Coefficient	Std. Error	t-Statistic	Prob.
C_EMP(1)	-0.978929	0.451658	-2.167413	0.0353
C_EMP(2)	0.082192	0.054496	1.508225	0.1382
C_EMP(4)	-0.362834	0.128935	-2.814092	0.0071
C_EMP(5)	-0.104356	0.077089	-1.353703	0.1823
C_EMP(6)	0.687094	0.327284	2.099382	0.0412
C_EMP(7)	-0.305784	0.860275	-0.355449	0.7238
C_EMP(8)	-2.351942	1.218386	-1.930376	0.0596
C_EMP(9)	-2.457641	0.791515	-3.104983	0.0032
C_EMP(10)	-0.293920	0.129426	-2.270943	0.0278
R-squared	0.630728	Mean dependent var		0.003734
Adjusted R-squared	0.567874	S.D. dependent var		0.011385
S.E. of regression	0.007484	Akaike info criterion		-6.805905
Sum squared resid	0.002632	Schwarz criterion		-6.480402
Log likelihood	199.5653	Hannan-Quinn criter.		-6.679708
F-statistic	10.03470	Durbin-Watson stat		2.029339
Prob(F-statistic)	0.000000			

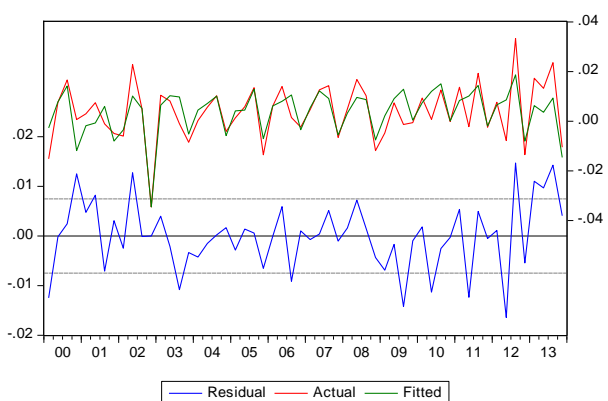
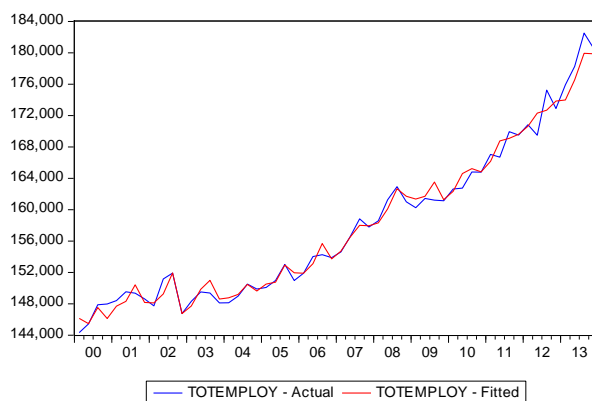

Demand Block

A.2.3 Private Consumption

Dependent Variable: DLOG(CNF)

Method: Least Squares (Gauss-Newton / Marquardt steps)

Sample (adjusted): 2000Q4 2013Q4

Included observations: 53 after adjustments

$$\begin{aligned} \text{DLOG(CNF)} = & C_CNF(1) + C_CNF(2)*\text{DLOG(YPDF)} + C_CNF(3)*\text{D(URB} \\ & -3)/100 + C_CNF(4)*\text{DLOG(TCHHF(-2))} + C_CNF(5)*(\text{LOG(CNF(-1))} - \\ & C_CNF(6)*\text{LOG(YPDF(-1))} - (1-C_CNF(6))*\text{LOG(WEALTHNET(-1)} \\ & /PCN(-1))) + C_CNF(7)*\text{HHRATF(-1)} + C_CNF(8)*@SEAS(2)/100 + \\ & C_CNF(9)*@SEAS(3)/100 + C_CNF(10)*@SEAS(4)/100 + C_CNF(11) \\ & *DUM_YPD \end{aligned}$$

	Coefficient	Std. Error	t-Statistic	Prob.
C_CNF(1)	-0.050653	0.016224	-3.122025	0.0032
C_CNF(2)	0.298205	0.148499	2.008130	0.0511
C_CNF(3)	-1.423821	0.603413	-2.359613	0.0230
C_CNF(4)	0.720499	0.242308	2.973491	0.0049
C_CNF(5)	-0.552564	0.132404	-4.173310	0.0001
C_CNF(6)	0.916142	0.052475	17.45859	0.0000
C_CNF(7)	-0.248415	0.335327	-0.740813	0.4629
C_CNF(8)	4.383970	1.176129	3.727456	0.0006
C_CNF(9)	8.451150	0.890286	9.492620	0.0000
C_CNF(10)	4.567732	0.815719	5.599642	0.0000
C_CNF(11)	0.030856	0.011418	2.702347	0.0099
R-squared	0.843166	Mean dependent var		0.003817
Adjusted R-squared	0.805825	S.D. dependent var		0.042855
S.E. of regression	0.018884	Akaike info criterion		-4.918507
Sum squared resid	0.014978	Schwarz criterion		-4.509578
Log likelihood	141.3404	Hannan-Quinn criter.		-4.761252
F-statistic	22.57995	Durbin-Watson stat		2.239156
Prob(F-statistic)	0.000000			

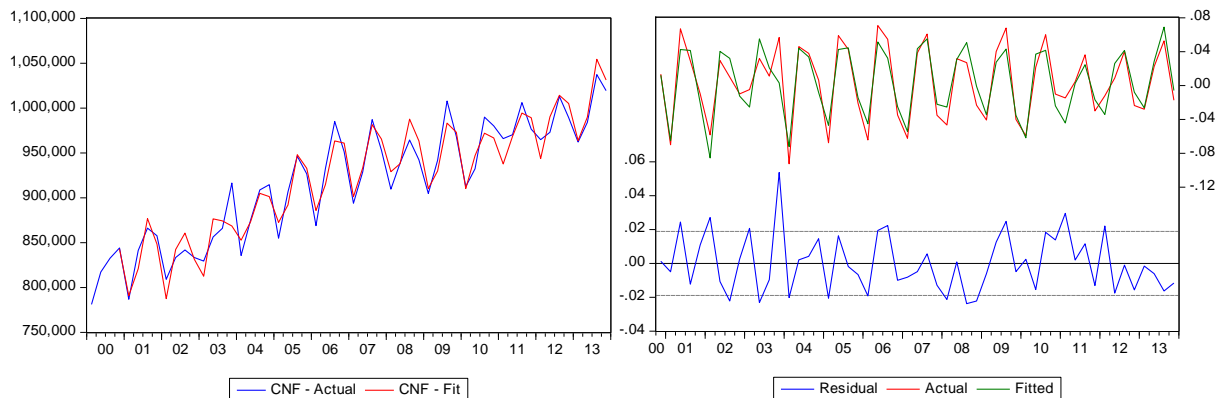

A.2.4 Non-Dwelling Private Investment

Dependent Variable: DLOG(NDIPRIVF)
 Method: Least Squares (Gauss-Newton / Marquardt steps)
 Sample (adjusted): 2001Q2 2013Q4
 Included observations: 51 after adjustments

$$\text{DLOG(NDIPRIVF)} = \text{C_NDIPRIVF(1)} + \text{C_NDIPRIVF(2)*DLOG(GDPF(-3))} + \\
 \text{C_NDIPRIVF(3)*DLOG(CNFCF(-4))} + \text{C_NDIPRIVF(4)} \\
 *(\text{LOG(NDIPRIVF(-1))}-\text{LOG(GDPF(-1))}+\text{LOG(PCAP(-1))}) + \\
 \text{C_NDIPRIVF(5)*D02Q2/100}$$

	Coefficient	Std. Error	t-Statistic	Prob.
C_NDIPRIVF(1)	1.293445	0.167366	7.728252	0.0000
C_NDIPRIVF(2)	0.782319	0.205274	3.811095	0.0004
C_NDIPRIVF(3)	0.630646	0.348884	1.807611	0.0772
C_NDIPRIVF(4)	-0.527297	0.069577	-7.578585	0.0000
C_NDIPRIVF(5)	-143.4672	13.67364	-10.49225	0.0000
R-squared	0.775062	Mean dependent var		0.007151
Adjusted R-squared	0.755502	S.D. dependent var		0.265997
S.E. of regression	0.131527	Akaike info criterion		-1.126321
Sum squared resid	0.795765	Schwarz criterion		-0.936926
Log likelihood	33.72119	Hannan-Quinn criter.		-1.053948
F-statistic	39.62516	Durbin-Watson stat		2.054977
Prob(F-statistic)	0.000000			

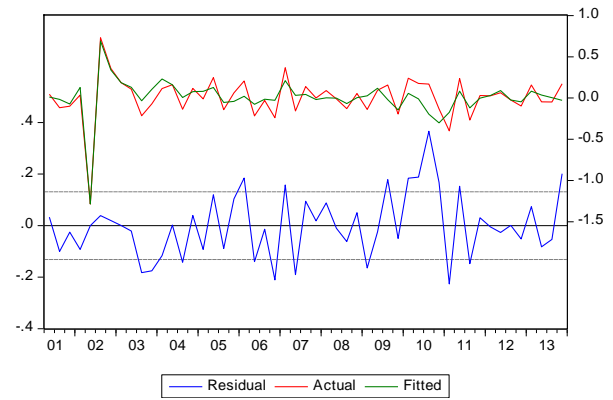
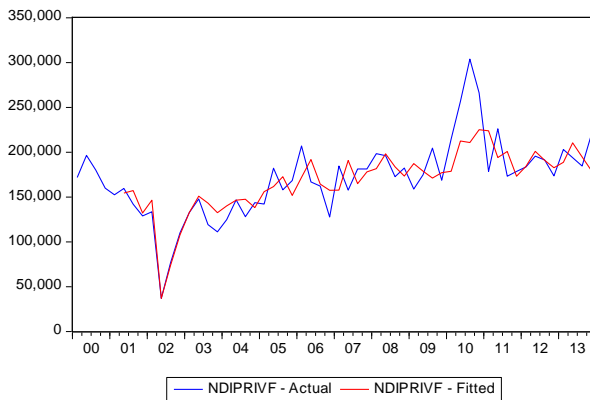

A.2.5 Dwelling Private Investment

Dependent Variable: DLOG(DWELLINGF)
 Method: Least Squares
 Sample (adjusted): 2000Q4 2013Q4
 Included observations: 53 after adjustments

Variable	Coefficient	Std. Error	t-Statistic	Prob.
C	-0.213530	0.110281	-1.936229	0.0596
DLOG(PERMIT)	0.100504	0.046715	2.151432	0.0372
DLOG(PERMIT(-1))	0.203176	0.055432	3.665318	0.0007
DLOG(PERMIT(-2))	0.206201	0.056859	3.626514	0.0008
DLOG(PERMIT(-3))	0.146829	0.045776	3.207539	0.0026
DLOG(TCHHF(-2))	1.003919	0.764234	1.313628	0.1961
DLOG(PIHF(-2))	0.475621	0.215617	2.205861	0.0329
LOG(DWELLINGF(-1)/PRIVGDPF(-1))	-0.072607	0.032401	-2.240899	0.0304
@QUARTER=2	-0.018693	0.029784	-0.627614	0.5337
@QUARTER=3	-0.041323	0.033145	-1.246754	0.2194
@QUARTER=4	-0.033167	0.030439	-1.089630	0.2821
R-squared	0.507906	Mean dependent var	-0.001403	
Adjusted R-squared	0.390741	S.D. dependent var	0.081192	
S.E. of regression	0.063375	Akaike info criterion	-2.497035	
Sum squared resid	0.168686	Schwarz criterion	-2.088106	
Log likelihood	77.17142	Hannan-Quinn criter.	-2.339781	
F-statistic	4.334960	Durbin-Watson stat	2.118211	
Prob(F-statistic)	0.000345			

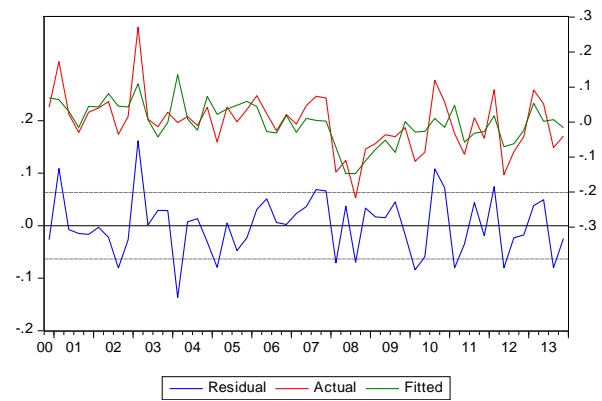
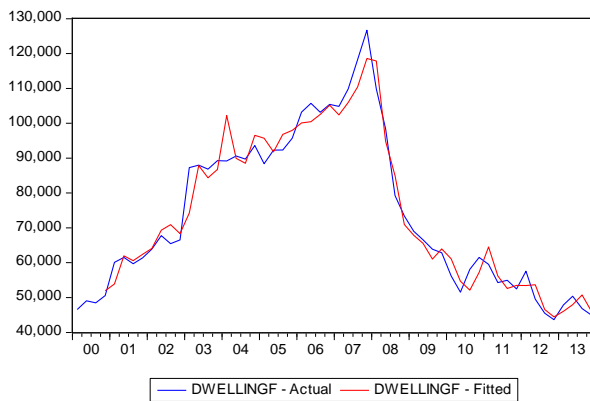

A.2.6 Exports of Goods and Selected Services

Dependent Variable: DLOG(XFGSS)

Method: Least Squares (Gauss-Newton / Marquardt steps)

Sample (adjusted): 2000Q2 2013Q4

Included observations: 55 after adjustments

DLOG(XFGSS)= C_EXP(1) + C_EXP(2)*DLOG(WDR) + C_EXP(3)
 DLOG(PX/CXD1) + C_EXP(4)(LOG(XFGSS(-1))-LOG(WDR(-1))
 +LOG(@MOVAV(PX(-1)/CXD1(-1),4))) + C_EXP(5)*@SEAS(2)/100 +
 C_EXP(6)*@SEAS(3)/100 + C_EXP(7)*@SEAS(4)/100

	Coefficient	Std. Error	t-Statistic	Prob.
C_EXP(1)	2.170958	0.896518	2.421545	0.0193
C_EXP(2)	1.039349	0.338244	3.072780	0.0035
C_EXP(3)	-1.093280	0.277902	-3.934044	0.0003
C_EXP(4)	-0.235366	0.094111	-2.500942	0.0159
C_EXP(5)	17.01853	2.356392	7.222281	0.0000
C_EXP(6)	14.14260	3.700426	3.821884	0.0004
C_EXP(7)	-1.097451	2.523274	-0.434932	0.6656
R-squared	0.888220	Mean dependent var		0.008505
Adjusted R-squared	0.874248	S.D. dependent var		0.148536
S.E. of regression	0.052673	Akaike info criterion		-2.931006
Sum squared resid	0.133174	Schwarz criterion		-2.675527
Log likelihood	87.60267	Hannan-Quinn criter.		-2.832210
F-statistic	63.56922	Durbin-Watson stat		2.218778
Prob(F-statistic)	0.000000			

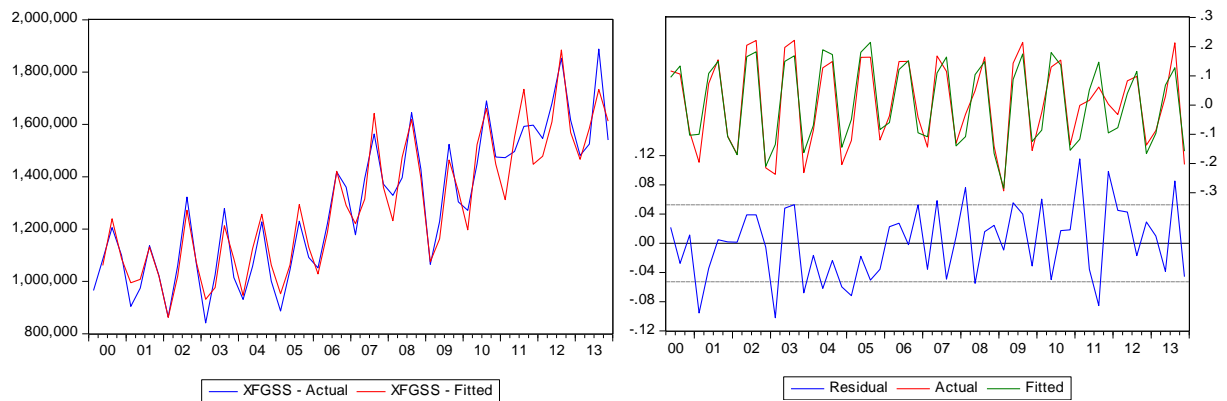

A.2.7 Imports of Goods and Selected Services

Dependent Variable: DLOG(MFGSS)
 Method: Least Squares (Gauss-Newton / Marquardt steps)
 Sample (adjusted): 2000Q2 2012Q4
 Included observations: 51 after adjustments

$$\text{DLOG(MFGSS)} = \text{C_MF(1)} + \text{C_MF(2)} * \text{DLOG(MFDEM)} + \text{C_MF(3)} * \text{LOG(MFGSS (-1)/MFDEM(-1))} + \text{C_MF(4)} * @\text{SEAS(2)/100} + \text{C_MF(5)} * @\text{SEAS(3)/100} + \text{C_MF(6)} * @\text{SEAS(4)/100} + \text{C_MF(7)} * \text{TREND00Q1/100}$$

	Coefficient	Std. Error	t-Statistic	Prob.
C_MF(1)	-0.020090	0.026208	-0.766574	0.4474
C_MF(2)	1.383274	0.243860	5.672411	0.0000
C_MF(3)	-0.439588	0.117641	-3.736687	0.0005
C_MF(4)	-0.051811	3.694328	-0.014024	0.9889
C_MF(5)	-9.816317	3.901017	-2.516348	0.0156
C_MF(6)	5.284023	2.166623	2.438829	0.0188
C_MF(7)	0.170639	0.061446	2.777047	0.0080
R-squared	0.770353	Mean dependent var		0.006181
Adjusted R-squared	0.739037	S.D. dependent var		0.097844
S.E. of regression	0.049983	Akaike info criterion		-3.027395
Sum squared resid	0.109925	Schwarz criterion		-2.762242
Log likelihood	84.19857	Hannan-Quinn criter.		-2.926072
F-statistic	24.59971	Durbin-Watson stat		2.260194
Prob(F-statistic)	0.000000			

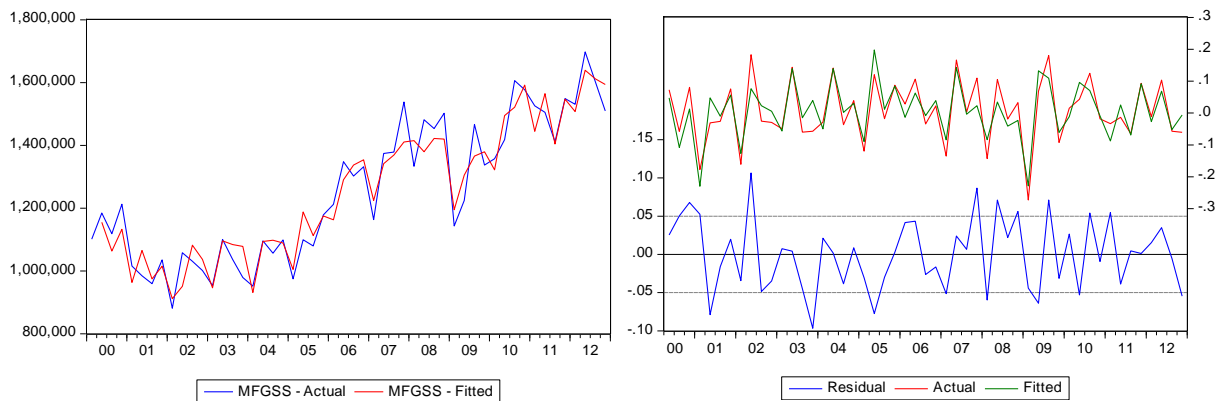

Price-Wage Block

A.2.8 GDP Deflator

Dependent Variable: DLOG(PGDP)
 Method: Least Squares (Gauss-Newton / Marquardt steps)
 Sample (adjusted): 2000Q3 2013Q4
 Included observations: 54 after adjustments

$$\text{DLOG(PGDP)} = \text{C_PGDP}(1) + \text{C_PGDP}(2) * \text{DLOG(PGDP}(-4)) + \text{C_PGDP}(3) * \text{DLOG(CMD1}(-1)) + \text{C_PGDP}(4) * \text{DLOG(TOTWAGE}(-1)) + \text{C_PGDP}(5) * \text{GDPFGAP}/100 + \text{C_PGDP}(6) * (\text{LOG(PGDP}(-1)) - \text{LOG}(@\text{MOVAV}(\text{ULC}(-1),4))) + \text{C_PGDP}(8) * @\text{SEAS}(2)/100 + \text{C_PGDP}(9) * @\text{SEAS}(3)/100 + \text{C_PGDP}(10) * @\text{SEAS}(4)/100 + 0.12 * \text{LOG(TSR}(-1))$$

	Coefficient	Std. Error	t-Statistic	Prob.
C_PGDP(1)	1.858967	0.519196	3.580476	0.0008
C_PGDP(2)	0.506381	0.116842	4.333899	0.0001
C_PGDP(3)	0.136302	0.113378	1.202193	0.2356
C_PGDP(4)	0.113358	0.060480	1.874319	0.0674
C_PGDP(5)	0.343842	0.154581	2.224355	0.0312
C_PGDP(6)	-0.350957	0.098084	-3.578122	0.0008
C_PGDP(8)	-0.118029	0.925093	-0.127586	0.8990
C_PGDP(9)	-4.772927	1.685574	-2.831633	0.0069
C_PGDP(10)	-2.050617	0.595358	-3.444342	0.0012

R-squared	0.978925	Mean dependent var	0.005312
Adjusted R-squared	0.975179	S.D. dependent var	0.055145
S.E. of regression	0.008688	Akaike info criterion	-6.502742
Sum squared resid	0.003397	Schwarz criterion	-6.171245
Log likelihood	184.5740	Hannan-Quinn criter.	-6.374897
F-statistic	261.2848	Durbin-Watson stat	2.428838
Prob(F-statistic)	0.000000		

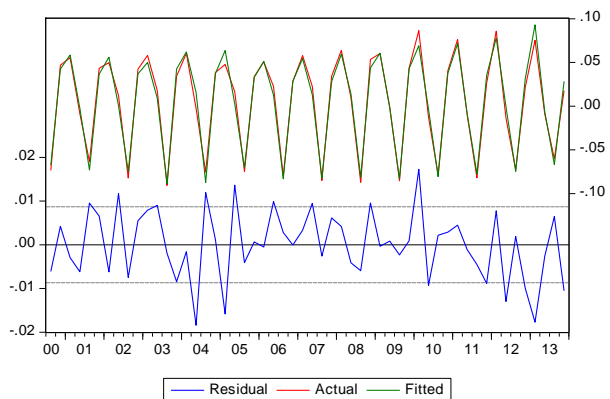
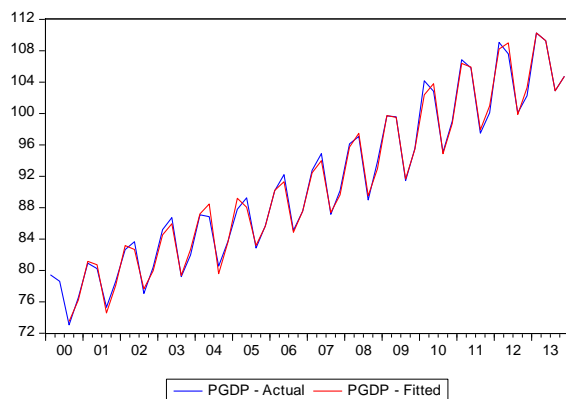

A.2.9 Private Consumption Deflator

Dependent Variable: DLOG(PCN)

Method: Least Squares (Gauss-Newton / Marquardt steps)

Sample: 2000Q1 2013Q4

Included observations: 56

$$\begin{aligned} \text{DLOG(PCN)} = & C_PCN(1) + C_PCN(2)*\text{DLOG(BRENT_EUR(-1))} + \\ & C_PCN(3)*\text{URBGAP(-4)/100} + C_PCN(5)*\text{DLOG(EENM1(-1))} + \\ & C_PCN(6)*(\text{LOG(PCN(-1))}-0.45*\text{LOG(PM(-1))}-0.55*\text{LOG(PGDP(-1))}) + \\ & C_PCN(8)*\text{@SEAS(2)/100} + C_PCN(9)*\text{@SEAS(3)/100} + C_PCN(10) \\ & *\text{@SEAS(4)/100} + 0.15*\text{DLOG(PGDP(-1))} \end{aligned}$$

	Coefficient	Std. Error	t-Statistic	Prob.
C_PCN(1)	0.005316	0.001751	3.035344	0.0039
C_PCN(2)	0.013251	0.006527	2.030124	0.0479
C_PCN(3)	-0.185436	0.190696	-0.972417	0.3357
C_PCN(5)	0.077306	0.108706	0.711148	0.4804
C_PCN(6)	-0.056860	0.056330	-1.009419	0.3178
C_PCN(8)	-1.096085	0.273612	-4.005985	0.0002
C_PCN(9)	-0.656063	0.301918	-2.172981	0.0347
C_PCN(10)	1.119284	0.246582	4.539204	0.0000
R-squared	0.280535	Mean dependent var	0.005332	
Adjusted R-squared	0.175613	S.D. dependent var	0.006440	
S.E. of regression	0.005847	Akaike info criterion	-7.314113	
Sum squared resid	0.001641	Schwarz criterion	-7.024777	
Log likelihood	212.7952	Hannan-Quinn criter.	-7.201938	
F-statistic	2.673746	Durbin-Watson stat	2.142791	
Prob(F-statistic)	0.020224			

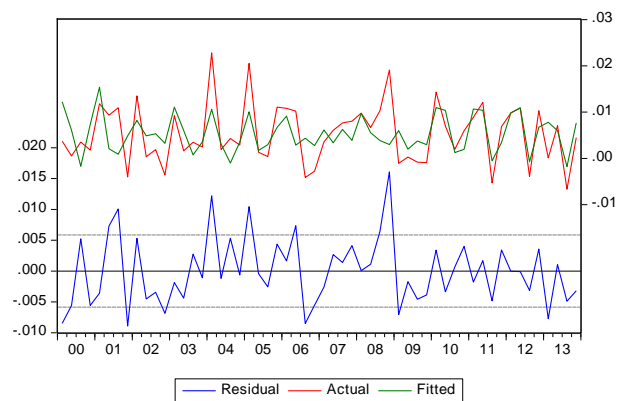
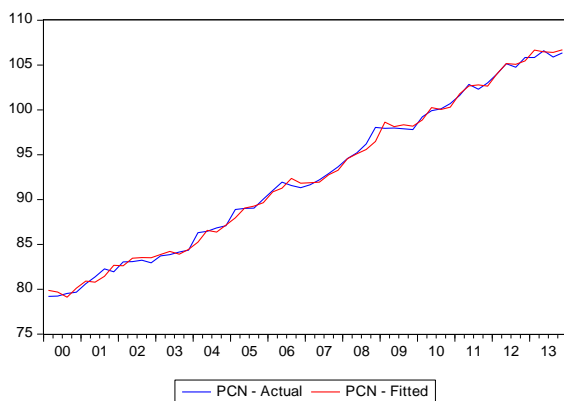

A.2.10 Investment Deflator

Dependent Variable: DLOG(PI)

Method: Least Squares (Gauss-Newton / Marquardt steps)

Sample: 2000Q1 2013Q4

Included observations: 56

$$\begin{aligned} \text{DLOG(PI)} = & C_PI(1) + C_PI(2)*\text{DLOG(PGDP(-1))} + C_PI(3)*\text{DLOG(PM(-3))} + \\ & C_PI(4)*(\text{LOG(PI(-1))}-0.6*\text{LOG(PGDP(-1))}-0.4*\text{LOG(PM(-1))}) + C_PI(5) \\ & *DUM00Q1 + C_PI(6)*@SEAS(2) + C_PI(7)*@SEAS(3) + C_PI(8) \\ & *@SEAS(4) \end{aligned}$$

	Coefficient	Std. Error	t-Statistic	Prob.
C_PI(1)	0.005320	0.005185	1.025995	0.3100
C_PI(2)	0.137296	0.107661	1.275264	0.2084
C_PI(3)	0.074721	0.044471	1.680240	0.0994
C_PI(4)	-0.074286	0.035246	-2.107652	0.0403
C_PI(5)	-0.065641	0.010444	-6.284827	0.0000
C_PI(6)	-0.011795	0.004338	-2.718862	0.0091
C_PI(7)	-5.90E-05	0.005374	-0.010970	0.9913
C_PI(8)	0.014314	0.012955	1.104877	0.2747
R-squared	0.607383	Mean dependent var	0.003698	
Adjusted R-squared	0.550126	S.D. dependent var	0.012617	
S.E. of regression	0.008463	Akaike info criterion	-6.574729	
Sum squared resid	0.003438	Schwarz criterion	-6.285393	
Log likelihood	192.0924	Hannan-Quinn criter.	-6.462554	
F-statistic	10.60808	Durbin-Watson stat	1.582885	
Prob(F-statistic)	0.000000			

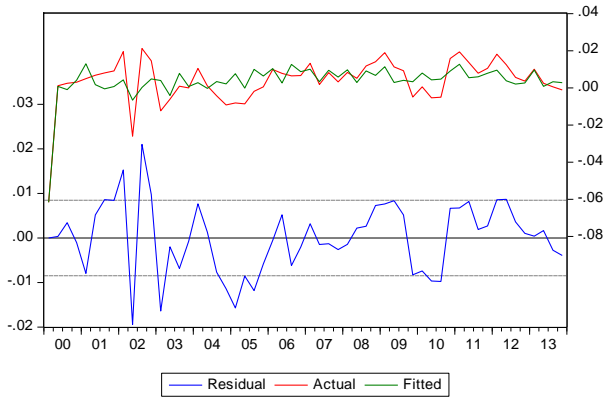
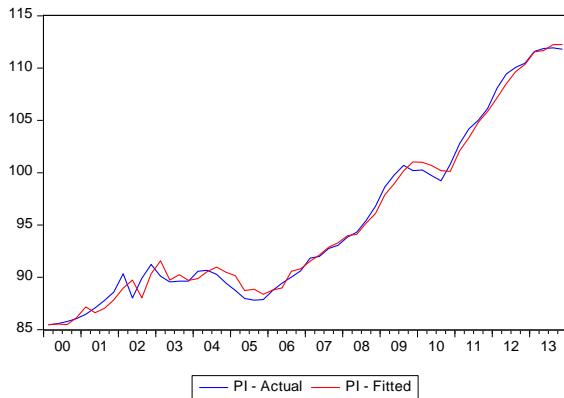

A.2.11 Export Deflator

Dependent Variable: DLOG(PX)

Method: Least Squares (Gauss-Newton / Marquardt steps)

Sample: 2000Q1 2013Q4

Included observations: 56

$$\begin{aligned} \text{DLOG(PX)} = & C_PX(1) + C_PX(2)*\text{DLOG(PM)} + C_PX(3)*\text{DLOG(PGDP(-4))} + \\ & C_PX(4)*(\text{LOG(PX(-1))} - 0.75*\text{LOG(PM(-1))} - 0.25*\text{LOG(PGDP(-1))}) + \\ & C_PX(5)*\text{@SEAS(2)/100} + C_PX(6)*\text{@SEAS(3)/100} + C_PX(7) \\ & *\text{@SEAS(4)/100} \end{aligned}$$

	Coefficient	Std. Error	t-Statistic	Prob.
C_PX(1)	0.020506	0.008120	2.525478	0.0148
C_PX(2)	0.880355	0.052360	16.81347	0.0000
C_PX(3)	0.213800	0.121562	1.758779	0.0849
C_PX(4)	-0.487480	0.132464	-3.680094	0.0006
C_PX(5)	-1.197414	0.842361	-1.421498	0.1615
C_PX(6)	-5.717214	1.797831	-3.180062	0.0026
C_PX(7)	-1.606200	0.484909	-3.312376	0.0017
R-squared	0.971733	Mean dependent var		0.006385
Adjusted R-squared	0.968272	S.D. dependent var		0.049047
S.E. of regression	0.008737	Akaike info criterion		-6.526128
Sum squared resid	0.003740	Schwarz criterion		-6.272959
Log likelihood	189.7316	Hannan-Quinn criter.		-6.427975
F-statistic	280.7430	Durbin-Watson stat		2.453879
Prob(F-statistic)	0.000000			

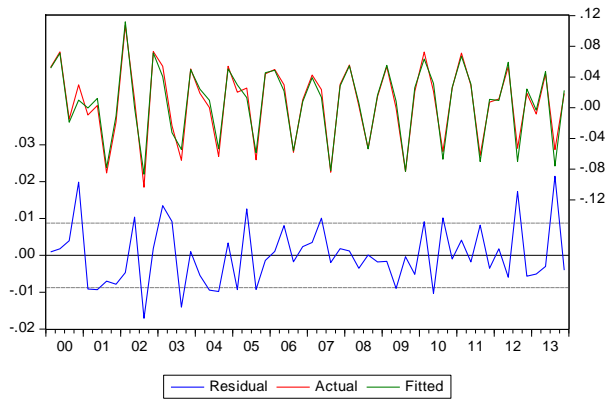
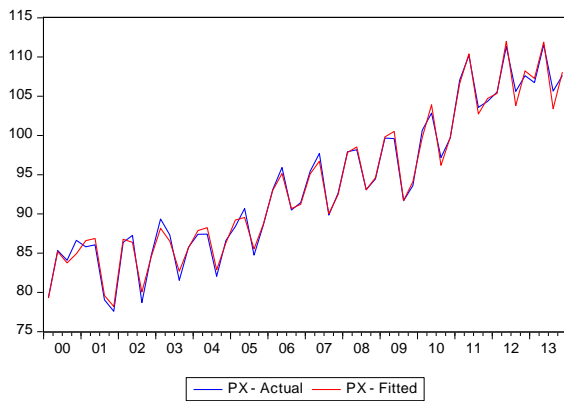

A.2.12 Import Deflator

Dependent Variable: DLOG(PM)
 Method: Least Squares
 Sample: 2000Q1 2013Q4
 Included observations: 56

Variable	Coefficient	Std. Error	t-Statistic	Prob.
C	-0.031153	0.012083	-2.578293	0.0131
DLOG(CMD1)	0.497488	0.271934	1.829443	0.0735
DLOG(PGDP(-1))	0.648789	0.276641	2.345240	0.0232
LOG(PM(-1)/CMD1(-1))	-0.230958	0.068036	-3.394632	0.0014
@ISPRIOD("2001q4")	-0.080164	0.023624	-3.393398	0.0014
@SEAS(2)	-0.000264	0.010871	-0.024246	0.9808
@SEAS(3)	0.019537	0.012920	1.512193	0.1370
@SEAS(4)	0.083412	0.033352	2.500996	0.0159
R-squared	0.441361	Mean dependent var	0.005862	
Adjusted R-squared	0.359892	S.D. dependent var	0.027244	
S.E. of regression	0.021797	Akaike info criterion	-4.682515	
Sum squared resid	0.022805	Schwarz criterion	-4.393179	
Log likelihood	139.1104	Hannan-Quinn criter.	-4.570340	
F-statistic	5.417578	Durbin-Watson stat	2.013704	
Prob(F-statistic)	0.000127			

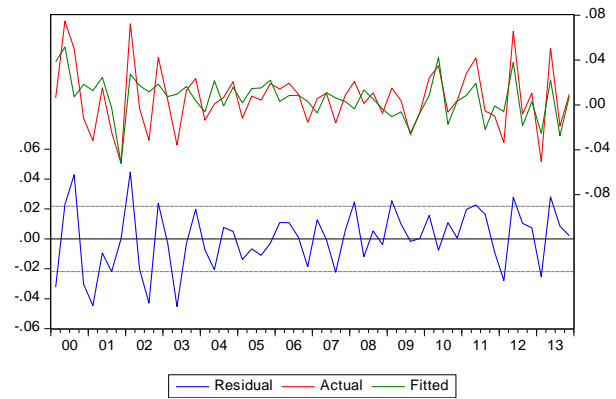
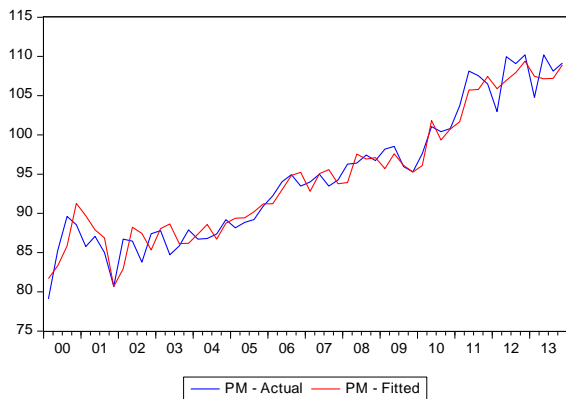

A.2.13 Private Sector Wage

Dependent Variable: DLOG(PRIVWAGE)
 Method: Least Squares (Gauss-Newton / Marquardt steps)
 Sample (adjusted): 2001Q1 2013Q4
 Included observations: 52 after adjustments
 DLOG(PRIVWAGE) = C_PW(1) + C_PW(2)*DLOG(@MOVAV(PRIVPRODF(-2),2)) + C_PW(3)*DLOG(PCN(-4)) + C_PW(4)*LOG(((PRIVWAGE(-1)/(@MOVAV(PCN(-1),4)))/(@MOVAV(PRIVPRODF(-1),4)))) - 0.05*URB(-1)/100 + C_PW(5)*@SEAS(2) + C_PW(6)*@SEAS(3) + C_PW(7)*@SEAS(4) + C_PW(8)*D03Q1 + C_PW(9)*DUM12Q4

	Coefficient	Std. Error	t-Statistic	Prob.
C_PW(1)	-2.886830	0.550700	-5.242106	0.0000
C_PW(2)	0.516109	0.249298	2.070251	0.0445
C_PW(3)	0.555021	0.495450	1.120234	0.2688
C_PW(4)	-0.506026	0.101444	-4.988219	0.0000
C_PW(5)	0.095553	0.023369	4.088852	0.0002
C_PW(6)	0.135241	0.055551	2.434549	0.0191
C_PW(7)	0.136612	0.038992	3.503583	0.0011
C_PW(8)	0.061147	0.019344	3.160960	0.0029
C_PW(9)	0.083720	0.019478	4.298248	0.0001
R-squared	0.836450	Mean dependent var		0.008209
Adjusted R-squared	0.806022	S.D. dependent var		0.041871
S.E. of regression	0.018441	Akaike info criterion		-4.992354
Sum squared resid	0.014623	Schwarz criterion		-4.654639
Log likelihood	138.8012	Hannan-Quinn criter.		-4.862882
F-statistic	27.48960	Durbin-Watson stat		2.150616
Prob(F-statistic)	0.000000			

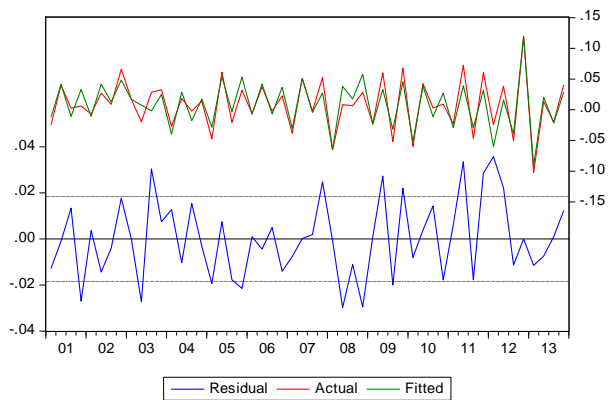
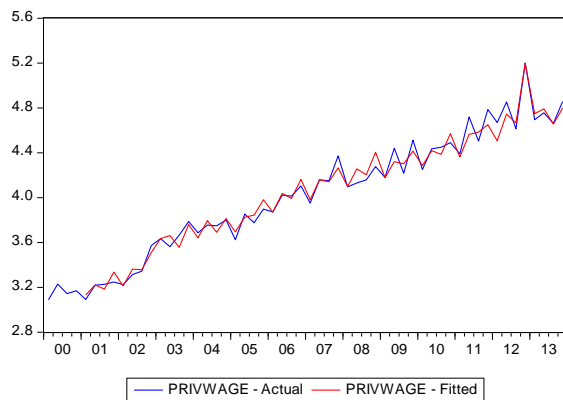

Fiscal Block

A.2.14 Interest Rate on Government Debt

Dependent Variable: IPD
 Method: Least Squares (Gauss-Newton / Marquardt steps)
 Sample: 2000Q1 2013Q4
 Included observations: 56
 IPD = C_IPD(1) + C_IPD(2)*GOV10

	Coefficient	Std. Error	t-Statistic	Prob.
C_IPD(1)	0.447247	0.180914	2.472156	0.0166
C_IPD(2)	0.185167	0.037558	4.930176	0.0000
R-squared	0.310403	Mean dependent var		1.328489
Adjusted R-squared	0.297633	S.D. dependent var		0.249400
S.E. of regression	0.209016	Akaike info criterion		-0.257754
Sum squared resid	2.359127	Schwarz criterion		-0.185420
Log likelihood	9.217121	Hannan-Quinn criter.		-0.229711
F-statistic	24.30664	Durbin-Watson stat		2.400723
Prob(F-statistic)	0.000008			

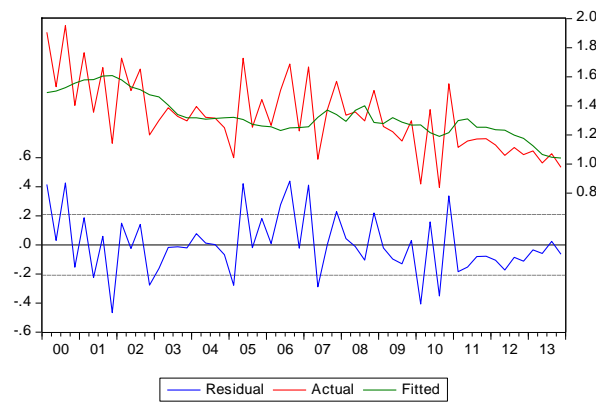
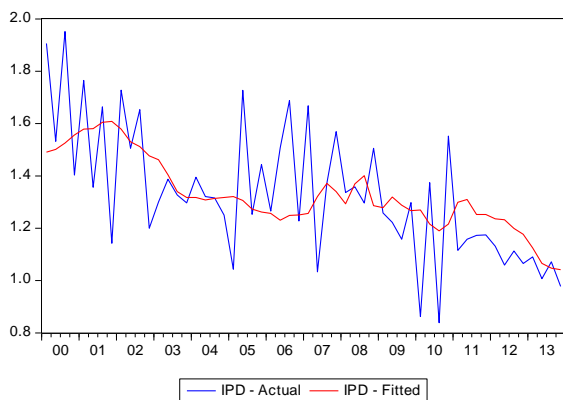

A.2.15 10-Year Maltese Government Bond Yield

Dependent Variable: D(GOV10)
 Method: Least Squares
 Sample: 2000Q1 2013Q4
 Included observations: 56

Variable	Coefficient	Std. Error	t-Statistic	Prob.
C	0.352927	0.159697	2.209980	0.0318
D(POLICYRAT)	0.384762	0.082127	4.684940	0.0000
D(POLICYRAT(-1))	-0.357624	0.085698	-4.173063	0.0001
D(SPREAD)	0.271204	0.071429	3.796833	0.0004
GOV10(-1)	-0.140596	0.042475	-3.310131	0.0018
POLICYRAT(-1)	0.092214	0.021664	4.256485	0.0001
@ISPERIOD("2011q1")	0.612742	0.143049	4.283456	0.0001
R-squared	0.542081	Mean dependent var	-0.042798	
Adjusted R-squared	0.486009	S.D. dependent var	0.193842	
S.E. of regression	0.138972	Akaike info criterion	-0.992624	
Sum squared resid	0.946344	Schwarz criterion	-0.739455	
Log likelihood	34.79348	Hannan-Quinn criter.	-0.894471	
F-statistic	9.667633	Durbin-Watson stat	2.061805	
Prob(F-statistic)	0.000001			

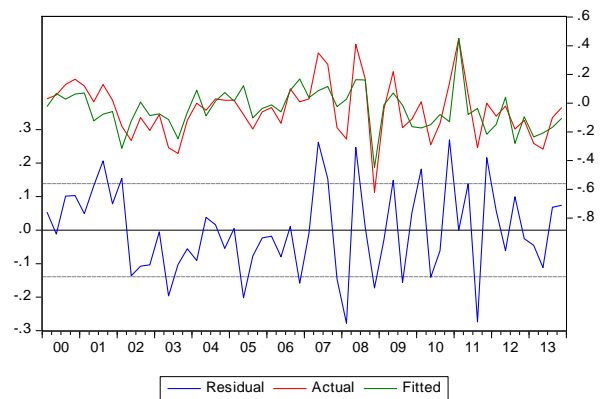
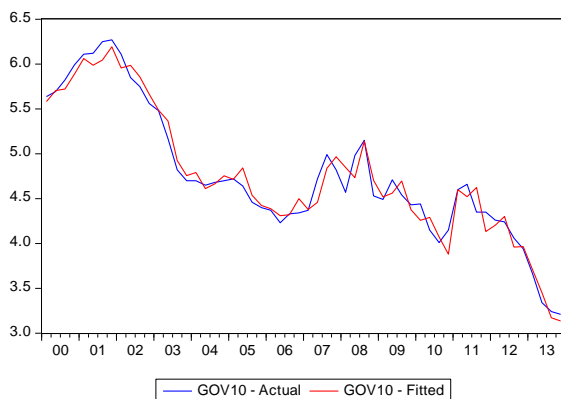

Financial Block

A.2.16 Consumer and Other Credit

Dependent Variable: DLOG(CCOCF)

Method: Least Squares (Gauss-Newton / Marquardt steps)

Sample: 2002Q1 2012Q4

Included observations: 44

$$\begin{aligned} \text{DLOG(CCOCF)} = & C_CCOCF(1) + C_CCOCF(2)*\text{DLOG(CNF)} + \\ & 0.6827*\text{D}(@\text{MOVAV}(\text{CCOCRATF},2)) + 0.058 \\ & *\text{DLOG}(\text{PIHF}(-1)) + C_CCOCF(3)*\text{LOG}(\text{CCOCF}(-1)/\text{CNF}(-1)) \\ & C_CCOCF(4) *\text{PD_HH_NEW}(-1)/100 \\ & + C_CCOCF(5)*\text{CCOCRATF}(-1) + C_CCOCF(6)*@\text{ISPERIOD}("2003q") \\ & + C_CCOCF(7)*@\text{ISPERIOD}("2005q2") \end{aligned}$$

	Coefficient	Std. Error	t-Statistic	Prob.
C_CCOCF(1)	0.006527	0.003543	1.752401	0.0880
C_CCOCF(2)	0.241967	0.085119	2.842675	0.0072
C_CCOCF(3)	-0.068207	0.031030	-2.198074	0.0343
C_CCOCF(4)	-0.800420	0.202457	3.955354	0.0003
C_CCOCF(5)	-0.412183	0.146303	-2.817323	0.0072
C_CCOCF(6)	0.115492	0.028572	4.042079	0.0003
C_CCOCF(7)	-0.050180	0.023829	-2.105872	0.0421
R-squared	0.596045	Mean dependent var	0.012050	
Adjusted R-squared	0.530538	S.D. dependent var	0.032829	
S.E. of regression	0.022493	Akaike info criterion	-4.606281	
Sum squared resid	0.018720	Schwarz criterion	-4.322433	
Log likelihood	108.3382	Hannan-Quinn criter.	-4.501016	
F-statistic	9.099048	Durbin-Watson stat	1.862771	
Prob(F-statistic)	0.000004			

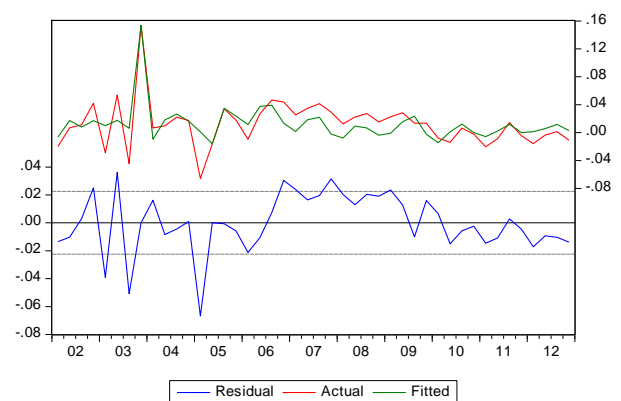
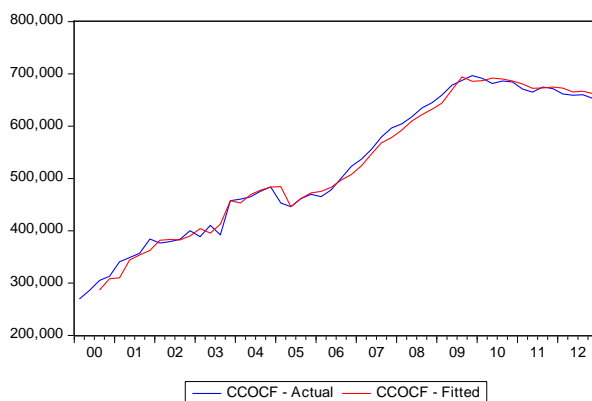

A.2.17 Housing Credit

Dependent Variable: DLOG(HCF)

Method: Least Squares (Gauss-Newton / Marquardt steps)

Sample (adjusted): 2001Q2 2013Q4

Included observations: 51 after adjustments

$$\begin{aligned} \text{DLOG(HCF)} = & C_HCF(1) + C_HCF(2)*\text{DLOG(HCF(-4))} + C_HCF(3) \\ & *D(\text{HCRATF(-1)}) + C_HCF(4)*\text{DLOG(PIHF)} + C_HCF(5)*\text{DLOG(YPDF} \\ & \text{-2)} + C_HCF(6)*D(\text{PD_HH_NEW})/100 + C_HCF(7)*\text{LOG(HCF(-1)} \\ & /PIHF(-1)) + C_HCF(8)*\text{PD_HH_NEW(-1)}/100 \\ & + C_HCF(9)*\text{HCRATF(-1)} + C_HCF(10)*@ISPERIOD("2003q \\ & 3") + C_HCF(11)*@ISPERIOD("2005q1") + C_HCF(12)*D(\text{CAPRATIO} \\ & \text{-1))} \end{aligned}$$

	Coefficient	Std. Error	t-Statistic	Prob.
C_HCF(1)	0.332439	0.070399	4.722236	0.0000
C_HCF(2)	0.239902	0.099989	2.399272	0.0211
C_HCF(3)	-0.447115	0.337034	-1.326618	0.1920
C_HCF(4)	0.124729	0.033209	3.755826	0.0005
C_HCF(5)	0.127183	0.046250	2.749879	0.0088
C_HCF(6)	-0.862512	0.599440	-1.438863	0.1578
C_HCF(7)	-0.030409	0.006608	-4.601991	0.0000
C_HCF(8)	-0.229130	0.118070	-1.940598	0.0576
C_HCF(9)	-0.556761	0.010616	-5.244785	0.0000
C_HCF(10)	0.029946	0.010196	2.937112	0.0054
C_HCF(11)	0.006511	0.008596	0.757450	0.4531
C_HCF(12)	0.004527	0.002538	1.783722	0.0819
R-squared	0.795251	Mean dependent var	0.026813	
Adjusted R-squared	0.750306	S.D. dependent var	0.016165	
S.E. of regression	0.008077	Akaike info criterion	-6.625575	
Sum squared resid	0.002675	Schwarz criterion	-6.246786	
Log likelihood	178.9522	Hannan-Quinn criter.	-6.480829	
F-statistic	17.69393	Durbin-Watson stat	2.218885	
Prob(F-statistic)	0.000000			

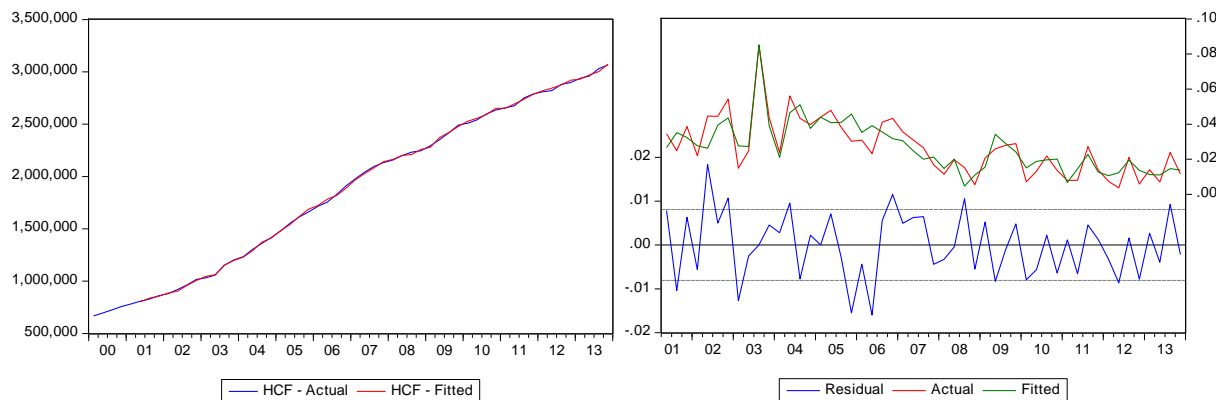

A.2.18 Credit to Non-Financial Corporations

Dependent Variable: DLOG(CNFCF)

Method: Least Squares (Gauss-Newton / Marquardt steps)

Sample (adjusted): 2001Q1 2013Q4

Included observations: 52 after adjustments

$$\begin{aligned} \text{DLOG(CNFCF)} = & C_CNFCF(1) + C_CNFCF(2)*\text{DLOG(GDPF)} + \\ & C_CNFCF(3)*\text{D(NFCRATF(-2))} + C_CNFCF(4)*\text{D(PD_NFC_NEW(-3))} \\ & /100 + C_CNFCF(5)*\text{LOG(CNFCF(-1)/ITF(-1))} + C_CNFCF(6)* \\ & \text{NFCRATF(-1)} - 0.0968*\text{PD_NFC_NEW(-1)/100} + \\ & C_CNFCF(7)*\text{@SEAS(1)/100} + C_CNFCF(8)*\text{@SEAS(2)/100} + \\ & C_CNFCF(9)*\text{@SEAS(3)/100} + C_CNFCF(10)*\text{@ISPERIOD("2005q1")} \end{aligned}$$

	Coefficient	Std. Error	t-Statistic	Prob.
C_CNFCF(1)	0.006197	0.011070	0.559857	0.5785
C_CNFCF(2)	0.244760	0.129166	1.894919	0.0648
C_CNFCF(3)	-2.119192	0.833692	-2.541937	0.0147
C_CNFCF(4)	-0.893430	0.208529	-4.284438	0.0001
C_CNFCF(5)	-0.019360	0.006892	-2.808979	0.0074
C_CNFCF(6)	-0.173280	0.038636	-4.684910	0.0000
C_CNFCF(7)	-2.943519	0.726680	-4.050641	0.0002
C_CNFCF(8)	-2.189200	1.943704	-1.126303	0.2663
C_CNFCF(9)	5.066027	2.827614	1.791626	0.0802
C_CNFCF(10)	-0.041019	0.016877	-2.430462	0.0193
R-squared	0.932650	Mean dependent var		0.000205
Adjusted R-squared	0.920120	S.D. dependent var		0.055202
S.E. of regression	0.015602	Akaike info criterion		-5.326760
Sum squared resid	0.010467	Schwarz criterion		-4.989045
Log likelihood	147.4958	Hannan-Quinn criter.		-5.197288
F-statistic	74.43236	Durbin-Watson stat		2.066986
Prob(F-statistic)	0.000000			

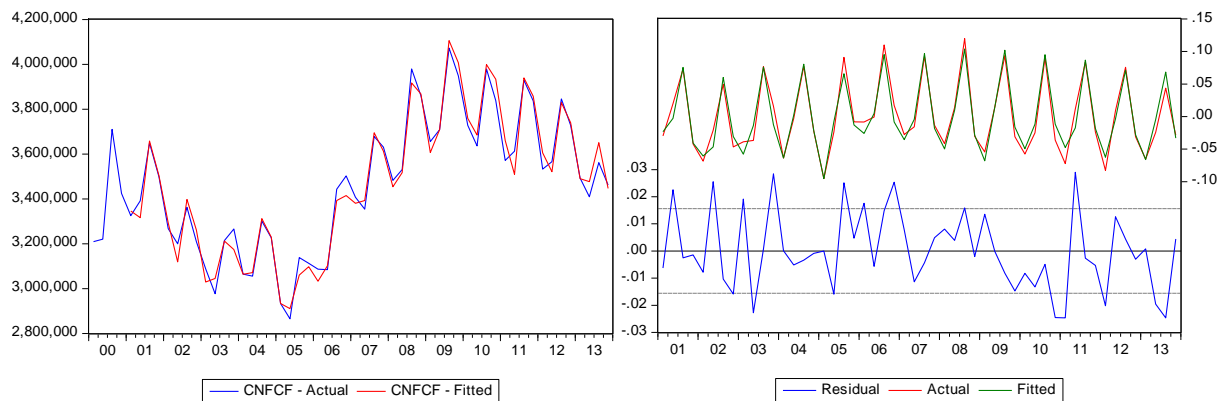

A.2.19 Lending Rate on Consumer and Other Credit

(a) Bank Lending Theory

Dependent Variable: D(CCOCRAT)
 Method: Least Squares (Gauss-Newton / Marquardt steps)
 Sample (adjusted): 2001Q3 2011Q4
 Included observations: 42 after adjustments

$$D(CCOCRAT) = C_CRL(1) + C_CRL(2)*D(POLICYRAT) + C_CRL(3) \\ *D(@MOVAV(LDR(-5),1)) + C_CRL(4)*D(PD_HH_NEW(-2)) + \\ C_CRL(5)*CCOCRAT(-1) + C_CRL(6)*LDR(-1) \\ + C_CRL(7)*PD_HH_NEW(-1) + C_CRL(8)*POLICYRAT(-1)$$

	Coefficient	Std. Error	t-Statistic	Prob.
C_CRL(1)	0.794680	0.253119	3.139552	0.0033
C_CRL(2)	0.569912	0.092180	6.182575	0.0000
C_CRL(3)	2.206531	1.761388	1.252723	0.2182
C_CRL(4)	0.155460	0.128196	1.212672	0.2329
C_CRL(5)	-0.401389	0.125514	-3.197948	0.0028
C_CRL(6)	1.156514	0.294303	3.929667	0.0003
C_CRL(7)	0.112571	0.012893	8.730848	0.0000
C_CRL(8)	0.234988	0.014716	15.96828	0.0000
R-squared	0.634361	Mean dependent var	-0.061274	
Adjusted R-squared	0.594833	S.D. dependent var	0.286443	
S.E. of regression	0.182329	Akaike info criterion	-0.454663	
Sum squared resid	1.230024	Schwarz criterion	-0.247798	
Log likelihood	14.54793	Hannan-Quinn criter.	-0.378839	
F-statistic	16.04819	Durbin-Watson stat	2.044737	
Prob(F-statistic)	0.000000			

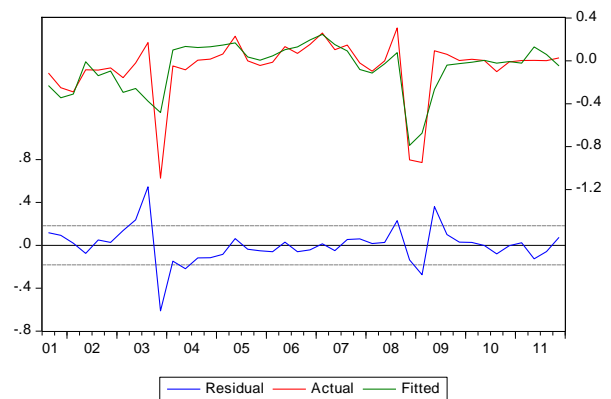
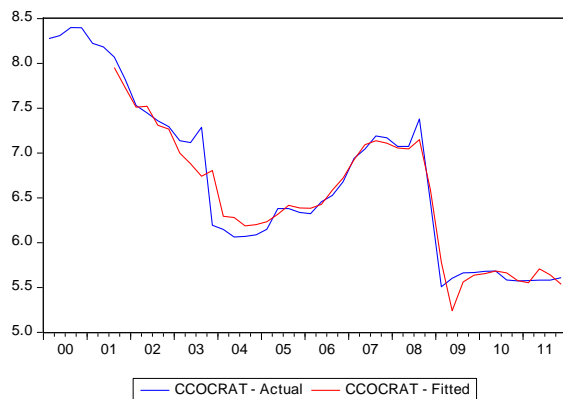

(b) Bank Equity Theory

Dependent Variable: D(CCOCRAT)
 Method: Least Squares (Gauss-Newton / Marquardt steps)
 Sample (adjusted): 2001Q1 2013Q4
 Included observations: 52 after adjustments
 $D(CCOCRAT) = C_CRE(1) + C_CRE(2)*D(POLICYRAT) + C_CRE(3)$
 $*D(@MOVAV(PD_HH_NEW(-2),2)) + C_CRE(4)*CCOCRAT(-1) +$
 $C_CRE(5)*CAPRATIO(-1) + C_CRE(6)*POLICYRAT(-1) + C_CRE(7)$
 $*PD_HH_NEW(-1)$

	Coefficient	Std. Error	t-Statistic	Prob.
C_CRE(1)	2.332544	0.715389	3.260525	0.0021
C_CRE(2)	0.627899	0.088331	7.108461	0.0000
C_CRE(3)	0.214006	0.172458	1.240912	0.2211
C_CRE(4)	-0.318824	0.104773	-3.042988	0.0039
C_CRE(5)	-0.065672	0.030138	-2.179029	0.0346
C_CRE(6)	0.132012	0.051667	2.555071	0.0141
C_CRE(7)	0.120250	0.057209	2.101925	0.0412
R-squared	0.596462	Mean dependent var		-0.054624
Adjusted R-squared	0.542657	S.D. dependent var		0.258289
S.E. of regression	0.174673	Akaike info criterion		-0.527148
Sum squared resid	1.372987	Schwarz criterion		-0.264480
Log likelihood	20.70584	Hannan-Quinn criter.		-0.426447
F-statistic	11.08562	Durbin-Watson stat		1.894421
Prob(F-statistic)	0.000000			

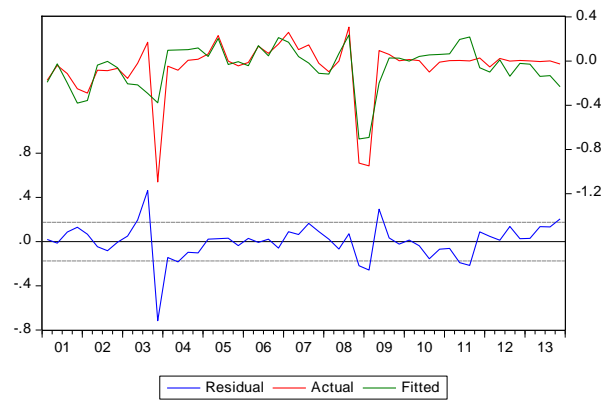
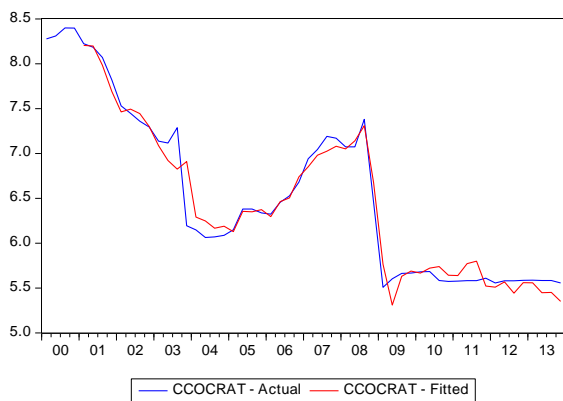

A.2.20 Lending Rate on Housing Credit

(a) Bank Lending Theory

Dependent Variable: D(HCRAT)
 Method: Least Squares (Gauss-Newton / Marquardt steps)
 Sample (adjusted): 2002Q2 2013Q4
 Included observations: 47 after adjustments
 $D(HCRAT) = C_HRL(1) + C_HRL(2)*D(POLICYRAT) + C_HRL(3)$
 $*D(@MOVAV(LDR(-5),4)) + C_HRL(4)*D(PD_HH_NEW(-2)) +$
 $C_HRL(5)*HCRAT(-1) + C_HRL(6)*LDR(-1)$
 $+ C_HRL(7)*PD_HH_NEW(-1) + C_HRL(9) *POLICYRAT(-1)$

	Coefficient	Std. Error	t-Statistic	Prob.
C_HRL(1)	0.621844	0.184086	3.378013	0.0016
C_HRL(2)	0.575924	0.090222	6.383407	0.0000
C_HRL(3)	3.276103	2.658745	1.232199	0.2247
C_HRL(4)	0.307162	0.175372	1.751491	0.0872
C_HRL(5)	-0.422519	0.122717	-3.443042	0.0013
C_HRL(6)	0.443680	0.612150	1.766402	0.0832
C_HRL(7)	0.108830	0.029516	8.791488	0.0000
C_HRL(8)	0.254558	0.026350	23.02830	0.0000
R-squared	0.627125	Mean dependent var	-0.050713	
Adjusted R-squared	0.591613	S.D. dependent var	0.258243	
S.E. of regression	0.165031	Akaike info criterion	-0.665084	
Sum squared resid	1.143873	Schwarz criterion	-0.468260	
Log likelihood	20.62948	Hannan-Quinn criter.	-0.591018	
F-statistic	17.65954	Durbin-Watson stat	1.979934	
Prob(F-statistic)	0.000000			

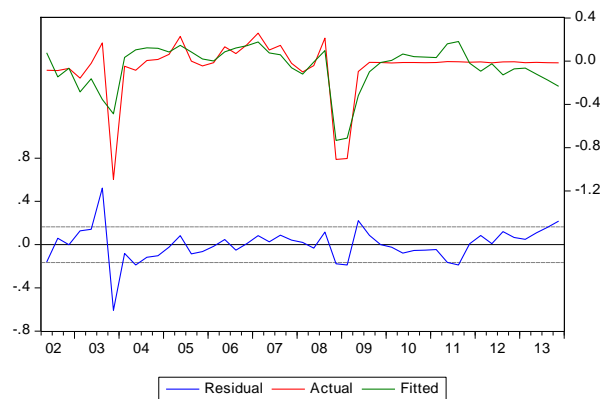
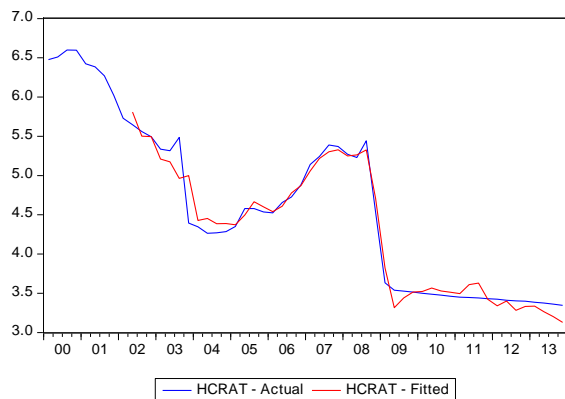

(b) Bank Equity Theory

Dependent Variable: D(HCRAT)
 Method: Least Squares (Gauss-Newton / Marquardt steps)
 Sample (adjusted): 2001Q1 2013Q4
 Included observations: 52 after adjustments
 $D(HCRAT) = C_HRE(1) + C_HRE(2)*D(@MOVAV(PD_HH_NEW(-2),2)) +$
 $C_HRE(3)*D(POLICYRAT) + C_HRE(4)*HCRAT(-1) + C_HRE(5)$
 $*CAPRATIO(-1) + C_HRE(6)*PD_HH_NEW(-1) + C_HRE(7)$
 $*POLICYRAT(-1)$

	Coefficient	Std. Error	t-Statistic	Prob.
C_HRE(1)	1.466316	0.500373	2.930446	0.0053
C_HRE(2)	0.184591	0.161900	1.140158	0.2603
C_HRE(3)	0.626947	0.082857	7.566575	0.0000
C_HRE(4)	-0.364039	0.115195	-3.160201	0.0028
C_HRE(5)	-0.045971	0.027396	-1.678018	0.1003
C_HRE(6)	0.115855	0.054906	2.110075	0.0404
C_HRE(7)	0.200108	0.068954	2.902045	0.0057
R-squared	0.619895	Mean dependent var	-0.062503	
Adjusted R-squared	0.569214	S.D. dependent var	0.249569	
S.E. of regression	0.163803	Akaike info criterion	-0.655655	
Sum squared resid	1.207414	Schwarz criterion	-0.392987	
Log likelihood	24.04702	Hannan-Quinn criter.	-0.554954	
F-statistic	12.23138	Durbin-Watson stat	1.867496	
Prob(F-statistic)	0.000000			

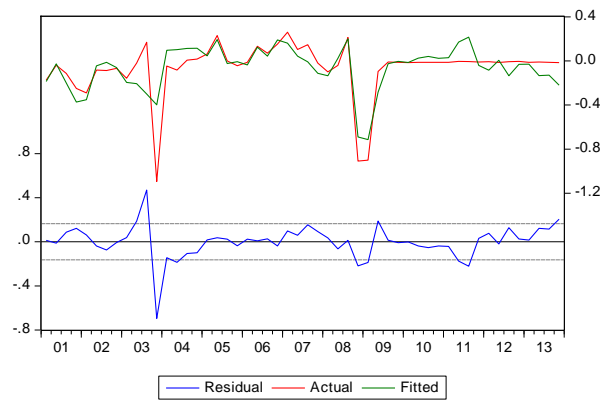
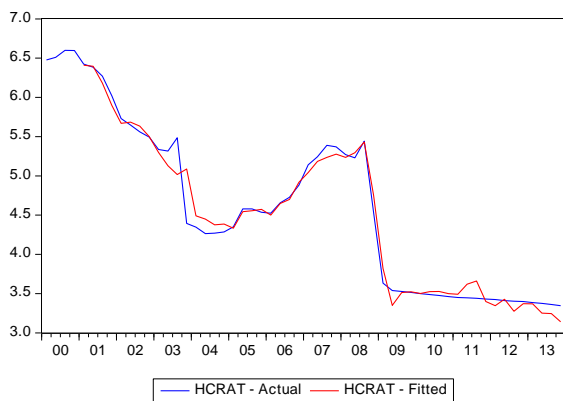

A.2.21 Lending Rate on Credit to Non-Financial Corporations

Dependent Variable: D(NFCRAT)

Method: Least Squares (Gauss-Newton / Marquardt steps)

Sample (adjusted): 2001Q3 2013Q4

Included observations: 50 after adjustments

$$D(NFCRAT) = C_NRL(1) + C_NRL(2)*D(POLICYRAT) + C_NRL(3)*D(LDR(-1)) + C_NRL(4)*D(NPLNFCRAT(-5)) + C_NRL(5)*NFCRAT(-1) + C_NRL(6)*LDR(-1) + C_NRL(7)*PD_NFC_NEW(-1) + C_NRL(8)*POLICYRAT(-1)$$

	Coefficient	Std. Error	t-Statistic	Prob.
C_NRL(1)	0.396788	0.312869	1.268224	0.2112
C_NRL(2)	0.549909	0.043382	12.67611	0.0000
C_NRL(3)	1.074693	0.904054	1.188748	0.2408
C_NRL(4)	0.011197	0.007922	1.413408	0.1644
C_NRL(5)	-0.130308	0.103332	-1.261058	0.2138
C_NRL(6)	0.161351	0.107051	1.507231	0.1378
C_NRL(7)	0.286521	0.139636	2.051905	0.0452
C_NRL(8)	0.079282	0.003013	26.31205	0.0000
R-squared	0.782994	Mean dependent var	-0.047298	
Adjusted R-squared	0.763705	S.D. dependent var	0.184244	
S.E. of regression	0.089561	Akaike info criterion	-1.893149	
Sum squared resid	0.360955	Schwarz criterion	-1.701946	
Log likelihood	52.32872	Hannan-Quinn criter.	-1.820338	
F-statistic	40.59193	Durbin-Watson stat	1.663832	
Prob(F-statistic)	0.000000			

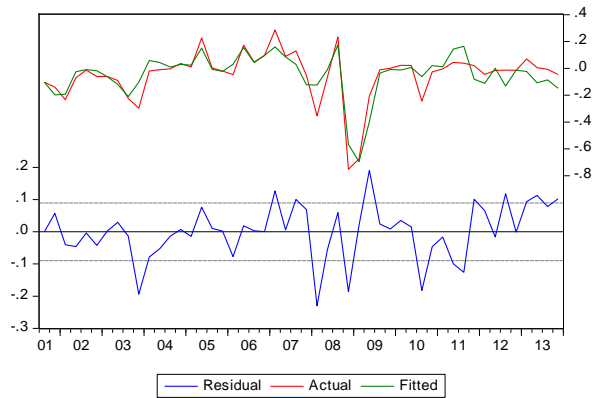
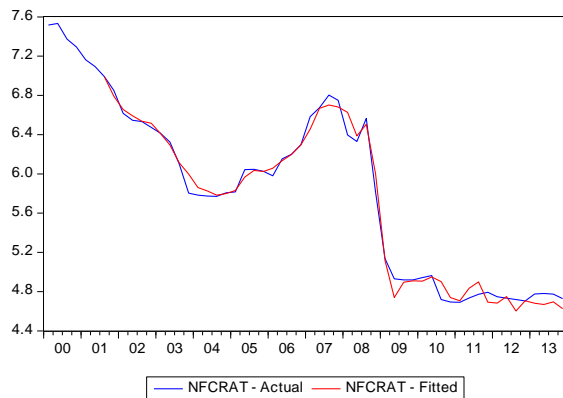

A.2.22 Deposit Rate

Dependent Variable: D(DEPRAT)
 Method: Least Squares
 Sample (adjusted): 2000Q3 2013Q4
 Included observations: 54 after adjustments

Variable	Coefficient	Std. Error	t-Statistic	Prob.
C	-0.486059	0.123964	-3.920954	0.0003
D(POLICYRAT)	0.117688	0.074799	1.573395	0.1222
D(TCRAT)	0.175956	0.102876	1.710369	0.0937
D(TCRAT(-1))	0.113407	0.065196	1.739473	0.0884
DEPRAT(-1)-TCRAT(-1)	-0.149113	0.038931	-3.830227	0.0004
@ISPERIOD("2003q4")	-0.192191	0.085255	-2.254309	0.0288
R-squared	0.741545	Mean dependent var	-0.051543	
Adjusted R-squared	0.714622	S.D. dependent var	0.132671	
S.E. of regression	0.070874	Akaike info criterion	-2.351397	
Sum squared resid	0.241108	Schwarz criterion	-2.130399	
Log likelihood	69.48772	Hannan-Quinn criter.	-2.266167	
F-statistic	27.54378	Durbin-Watson stat	0.696791	
Prob(F-statistic)	0.000000			

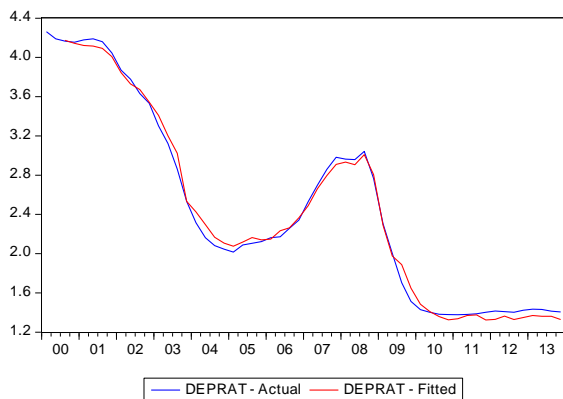

A.2.23 Household Non-Performing Loans

Dependent Variable: D(NPHH/TCHH)

Method: Least Squares (Gauss-Newton / Marquardt steps)

Sample (adjusted): 2001Q2 2013Q4

Included observations: 51 after adjustments

$$D(NPHH/TCHH) = C_NPLHH(1) + C_NPLHH(2)*DLOG(GDPF(-1)) + C_NPLHH(3)*(DLOG(PIHF(-3))-HHRATF(-3)) + C_NPLHH(4)*D(TCHH(-4)/WEALTH(-4)) + C_NPLHH(5)*(NPHH(-1)/TCHH(-1)) + C_NPLHH(6)*(TCHH(-1)/WEALTH(-1)) + C_NPLHH(7)*@ISPERIOD("2001q3")$$

	Coefficient	Std. Error	t-Statistic	Prob.
C_NPLHH(1)	-0.003431	0.002636	-1.301715	0.1998
C_NPLHH(2)	-0.008681	0.003181	-2.729074	0.0091
C_NPLHH(3)	-0.022419	0.007439	-3.013790	0.0043
C_NPLHH(4)	0.398628	0.161696	2.465294	0.0177
C_NPLHH(5)	-0.029231	0.024302	-1.202823	0.2355
C_NPLHH(6)	0.070520	0.044036	1.601412	0.1164
C_NPLHH(7)	-0.019030	0.002598	-7.324420	0.0000
R-squared	0.746302	Mean dependent var	-0.001229	
Adjusted R-squared	0.711707	S.D. dependent var	0.004274	
S.E. of regression	0.002295	Akaike info criterion	-9.189342	
Sum squared resid	0.000232	Schwarz criterion	-8.924190	
Log likelihood	241.3282	Hannan-Quinn criter.	-9.088020	
F-statistic	21.57245	Durbin-Watson stat	2.736424	
Prob(F-statistic)	0.000000			

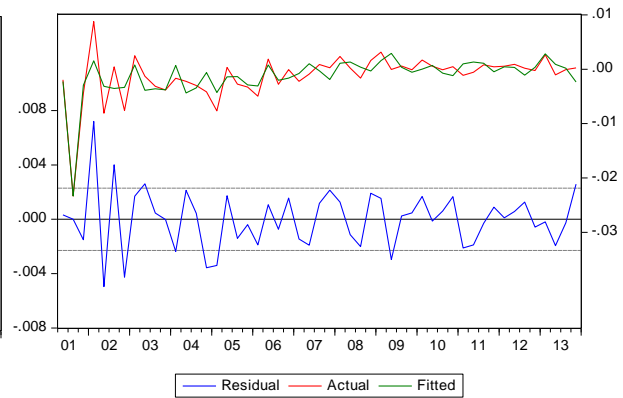
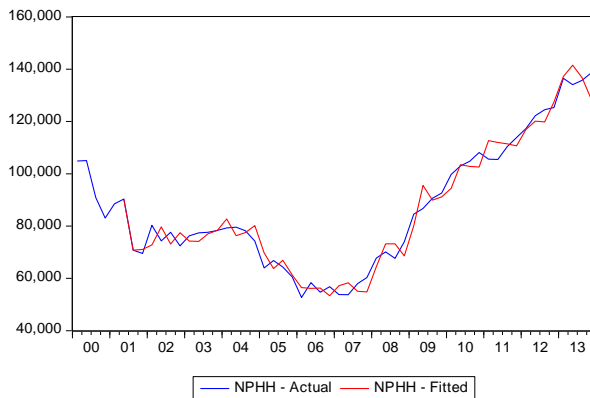

A.2.24 Non-Financial Corporation Non-Performing Loans

Dependent Variable: D(NPNFC/CNFC)
 Method: Least Squares (Gauss-Newton / Marquardt steps)
 Sample (adjusted): 2000Q2 2013Q4
 Included observations: 55 after adjustments

$$D(NPNFC/CNFC) = C_NPLNFC(1) + C_NPLNFC(2)*DLOG(@MOVAV(GDP F,2)) + C_NPLNFC(3)*D(@MOVAV(URB(-3),4)) + C_NPLNFC(4)*D(NFCRATF(-3)) + C_NPLNFC(5)*(NPNFC(-1)/CNFC(-1)) + C_NPLNFC(6)*(CNFC(-1)/(WEALTHNET(-1)+TOT_CREDIT(-1))) + C_NPLNFC(7)*@ISPERIOD("2000q3") + C_NPLNFC(8)*@ISPERIOD("2001q4")$$

	Coefficient	Std. Error	t-Statistic	Prob.
C_NPLNFC(1)	-0.026209	0.008855	-2.959871	0.0048
C_NPLNFC(2)	-0.025838	0.018867	-1.369456	0.1774
C_NPLNFC(3)	0.015973	0.008316	1.920762	0.0608
C_NPLNFC(4)	1.449375	0.567452	2.554181	0.0139
C_NPLNFC(5)	-0.116121	0.029159	-3.982283	0.0002
C_NPLNFC(6)	0.719095	0.170504	4.217473	0.0001
C_NPLNFC(7)	-0.063482	0.010400	-6.104054	0.0000
C_NPLNFC(8)	0.044659	0.010159	4.395895	0.0001
R-squared	0.681720	Mean dependent var		-0.001265
Adjusted R-squared	0.634317	S.D. dependent var		0.015953
S.E. of regression	0.009647	Akaike info criterion		-6.310595
Sum squared resid	0.004374	Schwarz criterion		-6.018620
Log likelihood	181.5414	Hannan-Quinn criter.		-6.197686
F-statistic	14.38128	Durbin-Watson stat		1.836099
Prob(F-statistic)	0.000000			

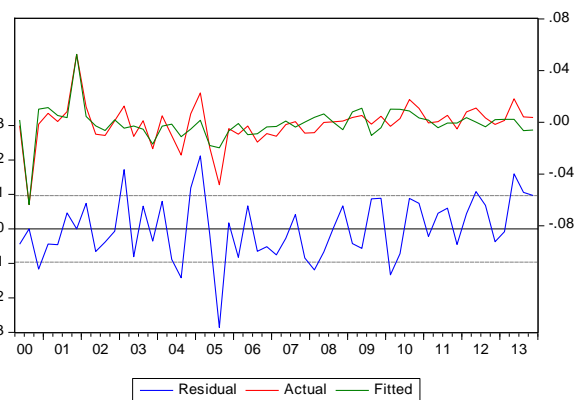
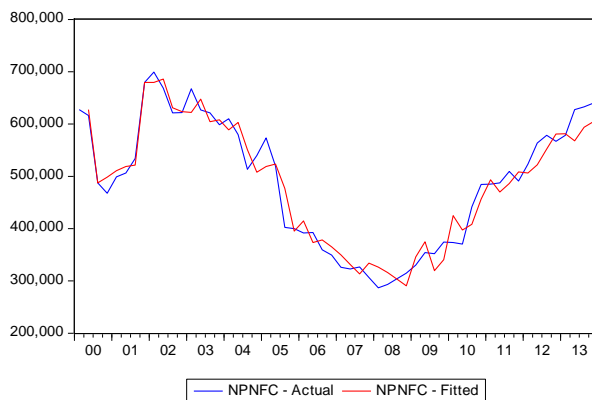

A.2.25 Banks' Net Interest Income

Dependent Variable: DLOG(NET)

Method: Least Squares (Gauss-Newton / Marquardt steps)

Sample (adjusted): 2000Q2 2013Q4

Included observations: 55 after adjustments

$$\begin{aligned} \text{DLOG(NET)} = & \text{C_NETINT(1)} + \text{C_NETINT(2)*DLOG(GDP(-1))} + \\ & \text{C_NETINT(3)*D(TCRAT-DEPRAT)} + \text{C_NETINT(4)*LOG(NET(-1))} \\ & / \text{TOT_CREDIT(-1)} + \text{C_NETINT(5)*(TCRAT(-1)-DEPRAT(-1))} + \\ & \text{C_NETINT(6)*@ISPERIOD("2002q3")} + \text{C_NETINT(7)} \\ & * \text{@ISPERIOD("2001q3")} \end{aligned}$$

	Coefficient	Std. Error	t-Statistic	Prob.
C_NETINT(1)	-3.863829	0.476655	-8.106132	0.0000
C_NETINT(2)	0.314059	0.209410	1.499733	0.1401
C_NETINT(3)	0.205271	0.081136	2.529965	0.0147
C_NETINT(4)	-0.730472	0.090255	-8.093432	0.0000
C_NETINT(5)	0.191798	0.043248	4.434892	0.0000
C_NETINT(6)	-0.235278	0.090392	-2.602854	0.0122
C_NETINT(7)	0.286628	0.090598	3.163739	0.0027
R-squared	0.706238	Mean dependent var	-0.000544	
Adjusted R-squared	0.676262	S.D. dependent var	0.151756	
S.E. of regression	0.086346	Akaike info criterion	-1.958236	
Sum squared resid	0.365327	Schwarz criterion	-1.739254	
Log likelihood	59.85149	Hannan-Quinn criter.	-1.873554	
F-statistic	23.56030	Durbin-Watson stat	1.140926	
Prob(F-statistic)	0.000000			

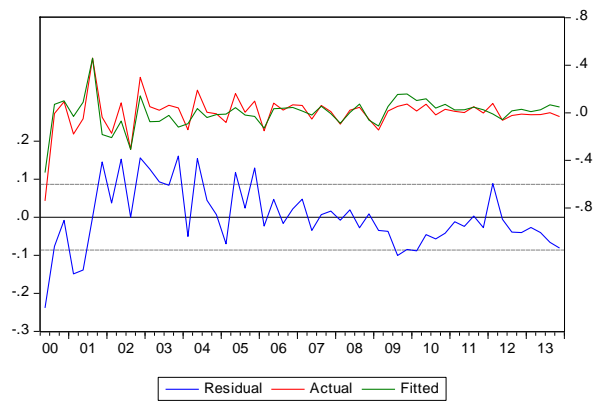
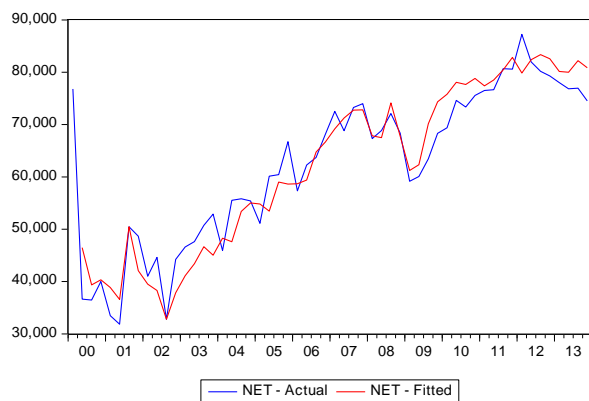

A.2.26 Banks' Fixed Non-Interest Income

Dependent Variable: DLOG(FXD)
 Method: Least Squares (Gauss-Newton / Marquardt steps)
 Sample: 2002Q1 2013Q4
 Included observations: 48
 DLOG(FXD) = C_FXD(1) + C_FXD(2)*DLOG(FXD(-1))
 + C_FXD(3)*D(GOV10(-2)) + C_FXD(4)*DLOG(GOVDEBT(-2)) +
 C_FXD(5)*LOG(FXD(-1)/TOT_CREDIT(-1)) + C_FXD(6)
 *@ISPERIOD("2011q1")

	Coefficient	Std. Error	t-Statistic	Prob.
C_FXD(1)	-3.309880	0.766337	-4.319091	0.0001
C_FXD(2)	-0.132542	0.113173	-1.171145	0.2481
C_FXD(3)	0.242073	0.129142	1.874468	0.0678
C_FXD(4)	1.879317	1.209723	1.553510	0.1278
C_FXD(5)	-0.611407	0.140510	-4.351344	0.0001
C_FXD(6)	-0.910557	0.173491	-5.248435	0.0000
R-squared	0.649182	Mean dependent var	0.015530	
Adjusted R-squared	0.607418	S.D. dependent var	0.272466	
S.E. of regression	0.170717	Akaike info criterion	-0.581145	
Sum squared resid	1.224067	Schwarz criterion	-0.347245	
Log likelihood	19.94748	Hannan-Quinn criter.	-0.492754	
F-statistic	15.54404	Durbin-Watson stat	1.735117	
Prob(F-statistic)	0.000000			

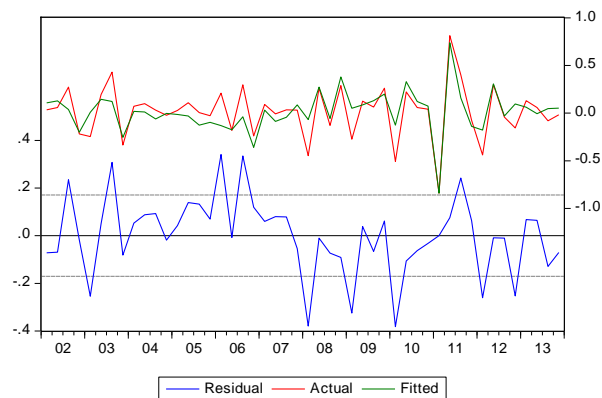
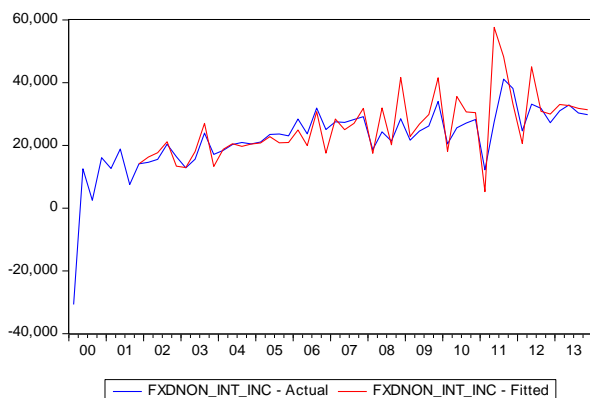

A.2.27 Bank's Other Expenses

Dependent Variable: DLOG(OTH_EXP)
 Method: Least Squares (Gauss-Newton / Marquardt steps)
 Sample (adjusted): 2000Q2 2014Q4
 Included observations: 59 after adjustments
 DLOG(OTH_EXP) = C_OTE(1) + C_OTE(2)*DLOG(PRIVWAGE) + C_OTE(3)
 *DLOG(GDP(-1)) + C_OTE(4)*LOG(OTH_EXP(-1)/TOT_CREDIT(-1))

	Coefficient	Std. Error	t-Statistic	Prob.
C_OTE(1)	-0.835100	0.337220	-2.476423	0.0164
C_OTE(2)	1.140254	0.212934	5.354975	0.0000
C_OTE(3)	0.326582	0.148735	2.195730	0.0323
C_OTE(4)	-0.174351	0.070547	-2.471403	0.0166
R-squared	0.450859	Mean dependent var		0.011463
Adjusted R-squared	0.420906	S.D. dependent var		0.085981
S.E. of regression	0.065430	Akaike info criterion		-2.550279
Sum squared resid	0.235460	Schwarz criterion		-2.409429
Log likelihood	79.23324	Hannan-Quinn criter.		-2.495297
F-statistic	15.05214	Durbin-Watson stat		2.534656
Prob(F-statistic)	0.000000			

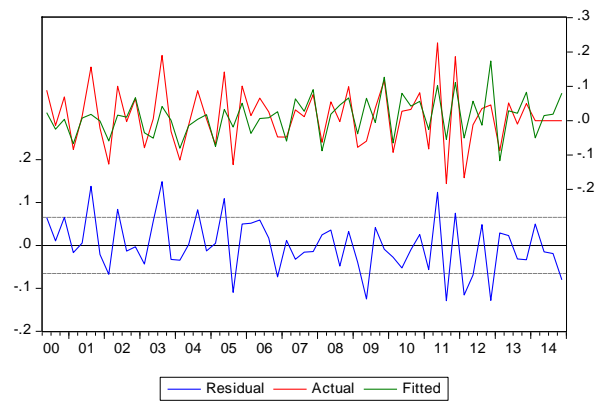
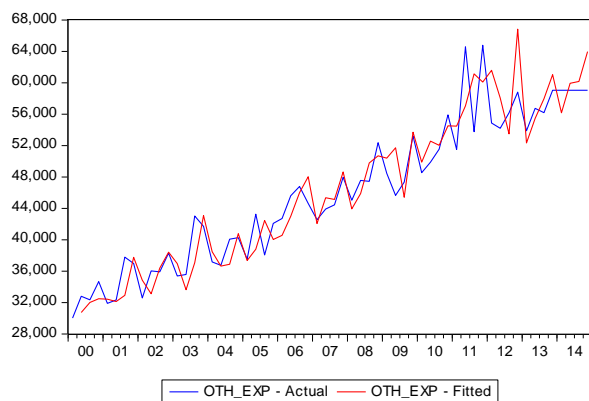

A.2.28 House Prices

Dependent Variable: DLOG(PIH)

Method: Least Squares (Gauss-Newton / Marquardt steps)

Sample: 2002Q1 2013Q4

Included observations: 48

$$\begin{aligned} \text{DLOG(PIH)} = & C_PIH(1) + 0.2 * \text{DLOG(YPD(-1))} + C_PIH(2) * \text{DLOG(HC(-1))} + \\ & C_PIH(3) * \text{D(URB(-1))} / 100 + C_PIH(4) * (\text{LOG(PIH(-1))} - \text{LOG(YPD(-1))}) + \\ & C_PIH(5) * \text{D02Q2} / 100 + C_PIH(6) * \text{D03Q3} / 100 + C_PIH(7) * @SEAS(2) \\ & / 100 + C_PIH(8) * @SEAS(3) / 100 + C_PIH(9) * @SEAS(4) / 100 \end{aligned}$$

	Coefficient	Std. Error	t-Statistic	Prob.
C_PIH(1)	-1.065031	0.389014	-2.737771	0.0093
C_PIH(2)	1.157647	0.361239	3.204660	0.0027
C_PIH(3)	-2.226354	1.170117	-1.902676	0.0645
C_PIH(4)	-0.113547	0.041751	-2.719644	0.0097
C_PIH(5)	-8.159236	3.415468	-2.388907	0.0218
C_PIH(6)	16.17094	3.382867	4.780247	0.0000
C_PIH(7)	-0.102410	1.291997	-0.079265	0.9372
C_PIH(8)	-0.697190	1.290183	-0.540381	0.5920
C_PIH(9)	-1.498572	1.319214	-1.135958	0.2629
R-squared	0.578022	Mean dependent var	0.010405	
Adjusted R-squared	0.491462	S.D. dependent var	0.042764	
S.E. of regression	0.030496	Akaike info criterion	-3.975088	
Sum squared resid	0.036270	Schwarz criterion	-3.624237	
Log likelihood	104.4021	Hannan-Quinn criter.	-3.842501	
F-statistic	6.677726	Durbin-Watson stat	2.168052	
Prob(F-statistic)	0.000018			

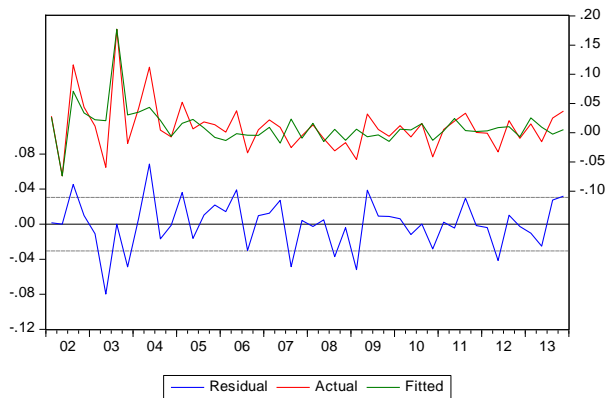

A.3 List of Variables

Table A.3.1 – Endogenous Variables

Code	Variable
BNK_EQUITY	Nominal equity of core banks
BNK_TAX	Nominal taxes paid on profits by core banks
BRENT_EUR	Price of Brent crude oil in euro
CAPEXP	Nominal government capital expenditure
CAPRATIO	Equity as a ratio of risk weighted assets of core banks
CAPREV	Nominal government capital revenue
CAPSTOCK	Real capital stock
CAPTAX	Nominal capital taxes
CAPTAXRAT	Nominal capital tax rate
CAPTRANSREV	Nominal capital transfers on the revenue side
CAPTRANSREVRAT	Nominal capital transfers on the revenue side rate
CCOC	Nominal consumer and other credit
CCOCF	Real consumer and other credit
CCOCRAT	Nominal lending rate on consumer and other credit
CCOCRATF	Real lending rate on consumer and other credit
CG	Nominal government consumption
CG_ANN	Nominal government consumption where the value in each quarter is equal to the annual value of the previous year
CG_ANN_DEF	Government consumption deflator based on nominal and real data where the value in each quarter is equal to the annual value of the previous year
CGF	Real government consumption
CGF_ANN	Real government consumption where the value in each quarter is equal to the annual value of the previous year
CMD1	Competitors' prices on the import side in domestic currency
CMDFOR1	Competitors' prices on the import side in foreign currency
CN	Nominal private consumption
CN_ANN	Nominal private consumption where the value in each quarter is equal to the annual value of the previous year
CN_ANN_DEF	Private consumption deflator based on nominal and real data where the value in each quarter is equal to the annual value of the previous year
CNF	Real private consumption
CNF_ANN	Real private consumption where the value in each quarter is equal to the annual value of the previous year
CNFC	Nominal credit to non-financial corporations
CNFCF	Real credit to non-financial corporations
CONT_CG	Contribution of real government consumption to real gross domestic product growth
CONT_CN	Contribution of real private consumption to real gross domestic product growth
CONT_I	Contribution of real investment to real gross domestic product growth
CONT_II	Contribution of real inventories to real gross domestic product growth
CONT_M	Contribution of real imports to real gross domestic product growth
CONT_X	Contribution of real exports to real gross domestic product growth
CORPDIRTAX	Nominal direct taxes on corporations
COUP	Nominal interest paid by government to households
CPE	Nominal compensation per employee
CPEF	Real compensation per employee
CUREXP	Nominal government current expenditure
CURREV	Nominal government current revenue
CXD1	Competitors' prices on the export side in domestic currency
CXDFOR1	Competitors' prices on the export side in foreign currency
DEPRAT	Nominal deposit rate
DEPRATF	Real deposit rate
DIRTAX	Nominal direct taxes
DIV_PD	Nominal dividends paid to shareholders by core banks
DWELLINGF	Real dwelling private investment
ECAPRATIO	Excess capital adequacy ratio over minimum requirement
EENM1	Nominal effective exchange rate on the import side
EENX1	Nominal effective exchange rate on the export side
EMPGOVGEN	Government employees
EMPLOYEES	Employees
EMPLOYEESGOVNI	Nominal national insurance contributions paid by government employees
EMPLOYEESNI	Nominal national insurance contributions paid by employees
EMPLOYEESPRIVNI	Nominal national insurance contributions paid by private sector employees
EMPLOYERSGOVNI	Nominal national insurance contributions paid by the government as an employer
EMPLOYERSNI	Nominal national insurance contributions paid by employers
EMPLOYERSPRIVNI	Nominal national insurance contributions paid by private sector employers

EMPELFNA	Self-employed
EXCISETAX	Nominal excise duties
FXDNON_INT_INC	Nominal fixed non-interest income
GDP	Nominal gross domestic product
GDP_ANN	Nominal gross domestic product where the value in each quarter is equal to the annual value of the previous year
GDP_ANN_DEF	Gross domestic product deflator based on nominal and real data where the value in each quarter is equal to the annual value of the previous year
GDPF	Real gross domestic product
GDPF_ANN	Real gross domestic product where the value in each quarter is equal to the annual value of the previous year
GDPF_GR	Real gross domestic product year-on-year growth rate
GDPFGAP	Real output gap
GDPFPO	Real potential gross domestic product
GOV10	Nominal 10-year Maltese government bond yield
GOVBAL_GFS	Nominal government balance according to government finance statistics
GOVBALRAT	Nominal government balance according to government finance statistics-to-nominal gross domestic product ratio
GOVDEBT	Nominal government debt
GOVDEBRAT	Nominal government debt-to-nominal gross domestic product ratio
GOVEXP	Nominal government expenditure
GOVPRIBAL	Nominal government primary balance
GOVPRIBALRAT	Nominal government primary balance-to-nominal gross domestic product ratio
GOVREV	Nominal government revenue
GOVSHARE	Ratio of government employees to total employees
GOVWAGE	Nominal public sector wage
GOVWAGERAT	Ratio of nominal public sector wage to nominal private sector wage
HC	Nominal housing credit
HCF	Real housing credit
HCRAT	Nominal lending rate on housing credit
HCRATF	Real lending rate on housing credit
HH_DEPOSITS	Nominal deposits held by households
HHDIRTAX	Nominal direct taxes on households
HHRATF	Real lending rate on credit to households
HPAPA	House prices for apartments
HPMAS	House prices for maisonettes
HPTER	House prices for terraced houses
HSAPA	Housing stock of apartments
HSMAS	Housing stock of maisonettes
HSTER	Housing stock of terraced houses
I	Nominal investment
I_ANN	Nominal investment where the value in each quarter is equal to the annual value of the previous year
I_ANN_DEF	Investment deflator based on nominal and real data where the value in each quarter is equal to the annual value of the previous year
IGOV	Nominal government investment
IGOVF	Real government investment
IGOVSHARE	Ratio of real government investment to real private sector investment
II	Nominal inventories
II_ANN	Nominal inventories where the value in each quarter is equal to the annual value of the previous year
II_ANN_DEF	Inventories deflator based on nominal and real data where the value in each quarter is equal to the annual value of the previous year
IIFR	Real inventories
IIFR_ANN	Real inventories where the value in each quarter is equal to the annual value of the previous year
IMPRENTS	Nominal imputed rents
IMPRENTSRAT	Ratio of nominal imputed rents to nominal private consumption
IMPUTEDNI	Nominal imputed national insurance contributions
INC_OTH	Nominal other non-interest income of core banks
INDIRTAX	Nominal indirect taxes
INTCONS	Nominal government intermediate consumption
INTEARNED	Nominal interest earned on deposits by households
INTPAID	Nominal interest paid on loans by households
INTPAYGOV	Nominal interest paid on government debt
INVINC	Nominal investment income earned by households
INVINCFOR2	Nominal investment income earned by households from abroad
INVINCRAT	Ratio of nominal investment income earned by households to nominal net financial wealth of households
IPD	Effective nominal interest rate on nominal government debt
IPRIVF	Real private investment

ITF	Real investment
ITF_ANN	Real investment where the value in each quarter is equal to the annual value of the previous year
LABFOR	Labour force
LDR	Loan-to-deposit ratio of core banks
M	Nominal imports
M_ANN	Nominal imports where the value in each quarter is equal to the annual value of the previous year
M_ANN_DEF	Imports deflator based on nominal and real data where the value in each quarter is equal to the annual value of the previous year
MF	Real imports
MF_ANN	Real imports where the value in each quarter is equal to the annual value of the previous year
MFDEM	Real demand for imports
MFSS	Real imports of goods and selected services
MFOS	Real imports of other services
NDIF	Real non-dwelling investment
NDIPRIV	Real non-dwelling private investment
NET	Nominal net interest income of core banks
NET_PROV	Nominal net provisions of core banks
NFC_DEPOSITS	Nominal deposits held by non-financial corporations
NFC_SAVING	Nominal flow of savings of non-financial corporations
NFC_SAVINGS	Nominal stock of savings of non-financial corporations
NFCRAT	Nominal lending rate on credit to non-financial corporations
NFCRATF	Real lending rate on credit to non-financial corporations
NPHH	Nominal non-performing loans of households
NPHHF	Real non-performing loans of households
NPL	Nominal non-performing loans
NPLHHRAT	Non-performing loans of households as a percentage of loans of households
NPLNFCRAT	Non-performing loans of non-financial corporations as a percentage of loans of non-financial corporations
NPLRAT	Non-performing loans as a percentage of loans
NPNFC	Nominal non-performing loans of non-financial corporations
NPNFCF	Real non-performing loans of non-financial corporations
OTH_EXP	Nominal other non-interest expenses of core banks
OTH_INC	Nominal other non-interest income excluding fixed income of core banks
OTHERBENC	Nominal other social benefits in cash
OTHERBENCRAT	Effective rate of nominal other social benefits in cash
OTHERCURREV	Nominal government other current revenue
OTHERINDIRTAX	Other indirect taxes
PARTICRAT	Participation rate
PCAP	Real user cost of capital
PCG	Government consumption deflator
PCN	Private consumption deflator
PD_HH_NEW	Probability of default of credit to households
PD_NFC_NEW	Probability of default of credit to non-financial corporations
PD_TOT_NEW	Probability of default
PENBENC	Nominal pension benefits
PERMITS	Building permits
PGDP	Gross domestic product deflator
PI	Investment deflator
PIH	Nominal house prices
PIHF	Real house prices
PII	Inventory deflator
PL_BT	Nominal profits or losses before taxes of core banks
PM	Import deflator
PRIVCOMP	Nominal private sector compensation per employee
PRIVEMPLOY	Private sector employment
PRIVEMPLOYEES	Private sector employees
PRIVGDPF	Real private sector gross domestic product
PRIVPRODF	Real private sector productivity
PRIVULC	Private sector unit labour cost
PRIVWAGE	Nominal private sector wage
PRIVWAGEBILL	Nominal private sector wage bill
PRODF	Real productivity
PROPINC	Nominal government property income

PROPINCRAT	Effective rate of nominal property income
PROV_BS	Initial value of nominal net provisions of core banks
PX	Export deflator
RWA	Nominal risk-weighted assets of core banks
SALES	Nominal government sales
SAVING	Nominal flow of savings of households
SAVINGS	Nominal stock of savings of households
SELFEMPINC	Nominal income of the self-employed
SELFSHARE	Ratio of self-employed to total employed
SOCBEN	Nominal social benefits
SOCBENC	Nominal social benefits in cash
SSC	Nominal social security contributions
TAXEMPINCH	Nominal taxes on employment income paid by households
TCHH	Nominal credit to households
TCHHF	Real credit to households
TCRAT	Nominal average lending rate on credit
TFPF	Real total factor productivity
TOT_CREDIT	Nominal credit extended by core banks
TOT_DEPOSITS	Nominal deposits held at core banks
TOT_DEPOSITSF	Real deposits held at core banks
TOT_SAVING	Nominal flow of savings of the private sector
TOT_SAVINGS	Nominal stock of savings of the private sector
TOTEMPLOY	Employment
TOTWAGE	Nominal wage
TOTWAGEBILL	Nominal wage bill
TSR	Effective rate of nominal net indirect taxes
ULC	Unit labour cost
UNEMPBENC	Nominal unemployment benefits
UNEMPLOYF	Unemployment
URB	Unemployment rate
URBGAP	Unemployment gap
VATTAX	Nominal value added taxes
W_HH	Weight of credit to households in total credit
W_NFC	Weight of credit to non-financial corporations in total credit
WAP	Working-age population
WEALTHFIN	Nominal gross financial wealth of households
WEALTHFINNET	Nominal net financial wealth of households
WEALTHHOUSE	Nominal housing wealth of households
WEALTHNET	Nominal net wealth
X	Nominal exports
X_ANN	Nominal exports where the value in each quarter is equal to the annual value of the previous year
X_ANN_DEF	Exports deflator based on nominal and real data where the value in each quarter is equal to the annual value of the previous year
XF	Real exports
XF_ANN	Real exports where the value in each quarter is equal to the annual value of the previous year
XFGSS	Real exports of goods and selected services
XFOS	Real exports of other services
YEMP	Nominal compensation of employees
YEMPGOV	Nominal compensation of government employees
YEMPPRIV	Nominal compensation of private sector employees
YPD	Nominal household disposable income
YPDF	Real household disposable income

Table A.3.2 – Exogenous Variables

Code	Variable
ACQLESSDIS	Nominal government acquisitions less disposals
BNK_TAXRATE	Tax rate charged on profits of core banks
BRENT_USD	Price of Brent crude oil in US dollars
CAP_DUM	Dummy variable active when bank equity rule is switched on
CAPTRANSEXP	Nominal capital transfers on the expenditure side
CORPDIRRAT	Effective rate of nominal direct taxes on corporations
D02Q2	Dummy variable active in 2002Q2
D02Q4	Dummy variable active in 2002Q4
D03Q1	Dummy variable active in 2003Q1
D03Q3	Dummy variable active in 2003Q3
DBYTARGET	Target nominal government debt-to-nominal gross domestic product ratio
DDA	Nominal deficit-debt adjustment
DEPNGOV	Nominal public sector depreciation
DIV_PDRATE	Percentage of profits paid as dividends
DUM00Q1	Dummy variable active in 2000Q1
DUM12Q4	Dummy variable active in 2012Q3
DUM_YPD	Dummy variable active between 2005Q1 and 2006Q4
EMPLOYEESGOVNIRAT	Effective rate of nominal national insurance contributions paid by government employees
EMPLOYEESPRIVNIRAT	Effective rate of nominal national insurance contributions paid by private sector employees
EMPLOYERSGOVNIRAT	Effective rate of nominal national insurance contributions paid by the government as an employer
EMPLOYERSPRIVNIRAT	Effective rate of nominal national insurance contributions paid by private sector employers
EXCISERAT	Effective rate of nominal excise duties
FISC_DUM	Dummy variable active when fiscal rule is switched on
HH_SHARE_GOV_DEBT	Share of government debt held by households
HHDIRRAT	Effective rate of nominal direct taxes on households
HIF	Food prices
IIFRRAT	Effective rate of real inventories
IIRAT	Effective rate of nominal inventories
IMPUTEDNIRAT	Effective rate of nominal imputed national insurance contributions
LDR_DUM	Dummy variable active when bank lending channel is switched on
MTLEUR	Maltese lira to euro exchange rate
NAIRU	Non-accelerating inflation rate of unemployment
NFC_SHARE_GOV_DEBT	Share of government debt held by non-financial corporations
OTHERCUREXP	Nominal government other current expenditure
OTHERINDIRRAT	Effective rate of nominal other indirect taxes
PD_BAR	Initial value of probability of default
PD_HH_START	Initial value of probability of default of credit to households
PD_NFC_START	Initial value of probability of default of credit to non-financial corporations
PENAV	Nominal average pension paid
PENBENEFIC	Pension beneficiaries
PERMITSAPA	Building permits for apartments
PERMITSMAS	Building permits for maisonettes
PERMITSTER	Building permits for terraced houses
POLICYRAT	Policy rate
POP	Population
RES_CMDFOR	Competitors' prices on the import side in foreign currency of goods excluding oil and food
RES_CXDFOR	Competitors' prices on the export side in foreign currency of goods excluding oil and food
RES_EENM	Nominal effective exchange rate on the import side of key currencies except dollar and euro
RES_EENX	Nominal effective exchange rate on the export side of key currencies except dollar and euro
SALESRAT	Effective rate of nominal sales
SOCBENK	Nominal social benefits in kind
SPREAD	Spread between nominal 10-year Maltese government bond yield and nominal 10-year German government bond yield
SUBSIDIES	Nominal subsidies
TFPFT	Smoothened real total factor productivity
TREND00Q1	Linear time trend from 2000Q1 to period until which model is estimated
UNEMPAV	Nominal average unemployment benefits paid
USD	US dollar to euro exchange rate
VATRAT	Effective rate of nominal value added taxes
WASHARE	Ratio of working-age population to total population
WDR	World demand

A.4 Modelling of Fiscal Block

Table A.4.1 – Revenue Side

		Share in Total Revenue (%)	Modelling Strategy	Details
	Revenue		Identity	
	Current Revenue	94.0	Identity	
	Direct Taxes	34.8	Identity	
1	Direct Taxes on Households	18.9	Endogenous: rate times base	Base: Compensation of Employees + Income of the Self-Employed
2	Direct Taxes on Corporations	15.9	Endogenous: rate times base	Base: GDP
	Indirect Taxes	32.7	Identity	
3	VAT	19.3	Endogenous: rate times base	Base: Private Consumption
4	Excise Duties	6.6	Endogenous: rate times base	Base: Private Consumption
5	Other Indirect Taxes	6.8	Endogenous: rate times base	Base: Private Consumption
	Social Security Contributions	16.9	Identity	
	Actual SSC	14.1	Identity	
	Employers' SSC	6.5	Identity	
6	Private	4.6	Endogenous: rate times base	Base: Compensation of Employees in the Private Sector
7	Government	1.9	Endogenous: rate times base	Base: Compensation of Employees in the Public Sector
	Employees' SSC	7.6	Identity	
8	Private	5.7	Endogenous: rate times base	Base: Compensation of Employees in the Private Sector
9	Government	1.9	Endogenous: rate times base	Base: Compensation of Employees in the Public Sector
10	Imputed SSC	2.7	Endogenous: rate times base	Base: Compensation of Employees in the Public Sector
11	Sales	5.6	Endogenous: rate times base	Base: GDP
12	Property Income	2.8	Endogenous: maintains share	Share of: Government Revenue
13	Other	1.1	Endogenous: maintains share	Share of: Government Revenue
	Capital Revenue	6.0	Identity	
14	Capital Taxes	0.4	Endogenous: maintains share	Share of: Government Revenue
15	Capital Transfers	5.7	Endogenous: maintains share	Share of: Government Revenue

Table A.4.1 – Expenditure Side

		Share in Total Expenditure (%)	Modelling Strategy	Details
	Expenditure		Identity	
	Current Expenditure	88.9	Identity	
1	Compensation of Employees	30.1	Endogenous: decomposition	(Public Sector Employees x Average Wage in the Public Sector) + Employers' NI Contributions paid by the Government + Imputed NI Contributions, with public sector employees and the average wage in the public sector moving in line with their private sector counterparts
	Social Benefits	28.9	Identity	
	Social Benefits in Cash	27.6	Identity	
2	Pension Benefits	22.8	Endogenous: decomposition	Pension Beneficiaries x Average Pension Paid, with the latter adjusted according to growth in wages and prices
3	Unemployment Benefits	1.4	Endogenous: decomposition	Number of Unemployed x Average Unemployment Benefit Paid, with the latter adjusted according to growth in prices
4	Other Social Benefits in Cash	3.5	Endogenous: maintains share	Share of: Social Benefits in Cash
5	Social Benefits in Kind	1.3	Endogenous: maintains share	Share of: Social Benefits
6	Interest	6.6	Endogenous: decomposition	Government Debt in previous period x Interest Rate on Government Debt, with latter dependent on Government 10-Year Bond Yield (via behavioural equation), which is, in turn, dependent on the Policy Rate (via behavioural equation)
7	Intermediate Consumption	15.1	Endogenous: rate times base	Base: GDP
8	Subsidies	3.0	Endogenous: maintains share	Share of: Government Expenditure
9	Other	5.3	Endogenous: maintains share	Share of: Government Expenditure
	Capital Expenditure	11.1	Identity	
10	Investment	8.6	Endogenous: maintains share	Share of: Private Investment
11	Capital Transfers	2.5	Endogenous: maintains share	Share of: Government Expenditure
12	Acquisitions less Disposals	0.0	Exogenous	