

Brubakk, Leif; Husebø, Tore Anders; Maih, Junior; Olsen, Kjetil; Østnor, Magne

Research Report

Finding NEMO: Documentation of the Norwegian Economy Model

Staff Memo, No. 2006/6

Provided in Cooperation with:

Norges Bank, Oslo

Suggested Citation: Brubakk, Leif; Husebø, Tore Anders; Maih, Junior; Olsen, Kjetil; Østnor, Magne (2006) : Finding NEMO: Documentation of the Norwegian Economy Model, Staff Memo, No. 2006/6, ISBN 82-7553-374-0, Norges Bank, Oslo, <http://hdl.handle.net/11250/2508017>

This Version is available at:

<http://hdl.handle.net/10419/210178>

Standard-Nutzungsbedingungen:

Die Dokumente auf EconStor dürfen zu eigenen wissenschaftlichen Zwecken und zum Privatgebrauch gespeichert und kopiert werden.

Sie dürfen die Dokumente nicht für öffentliche oder kommerzielle Zwecke vervielfältigen, öffentlich ausstellen, öffentlich zugänglich machen, vertreiben oder anderweitig nutzen.

Sofern die Verfasser die Dokumente unter Open-Content-Lizenzen (insbesondere CC-Lizenzen) zur Verfügung gestellt haben sollten, gelten abweichend von diesen Nutzungsbedingungen die in der dort genannten Lizenz gewährten Nutzungsrechte.

Terms of use:

Documents in EconStor may be saved and copied for your personal and scholarly purposes.

You are not to copy documents for public or commercial purposes, to exhibit the documents publicly, to make them publicly available on the internet, or to distribute or otherwise use the documents in public.

If the documents have been made available under an Open Content Licence (especially Creative Commons Licences), you may exercise further usage rights as specified in the indicated licence.



<http://creativecommons.org/licenses/by-nc-nd/4.0/deed.no>

N^o 2006/6

Oslo December 12, 2006

Staff Memo

Monetary Policy

Finding NEMO: Documentation of the Norwegian economy model

by

Leif Brubakk, Tore Anders Husebø, Junior Maih,
Kjetil Olsen and Magne Østnor

Publications from Norges Bank can be ordered by e-mail:

posten@norges-bank.no

or from: Norges Bank, Subscription service,

P.O.Box. 1179 Sentrum

N-0107 Oslo, Norway.

Tel. +47 22 31 63 83, Fax. +47 22 41 31 05

*Publications in the series Staff Memo are available as pdf-files on the bank's web site:
www.norges-bank.no, under "Publications".*

Staff Memos present reports on key issues written by staff members of Norges Bank, the central bank of Norway - and are intended to encourage comments from colleagues and other interested parties. Views and conclusions expressed in Staff Memos can not be taken to represent the views of Norges Bank.

© 2005 Norges Bank

The text may be quoted or referred to, provided that due acknowledgement is given to source.

Publikasjoner fra Norges Bank kan bestilles over e-post:

posten@norges-bank.no

eller ved henvendelse til:

Norges Bank, Abonnementservice

Postboks 1179 Sentrum

0107 Oslo

Telefon 22 31 63 83, Telefaks 22 41 31 05

Utgivelser i serien Staff Memo er tilgjengelige som pdf-filer på www.norges-bank.no, under «Publikasjoner».

Staff Memo inneholder utredninger som inngår i bankens arbeid med sentrale problemstillinger. Hensikten er å motta kommentarer fra kolleger og andre interesserte. Synspunkter og konklusjoner i arbeidene representerer ikke nødvendigvis Norges Banks synspunkter.

© 2005 Norges Bank

Det kan siteres fra eller henvises til dette arbeid, gitt at forfatter og Norges Bank oppgis som kilde.

ISSN 1504-2596 (online only)

ISBN 82-7553-374-0 (online only)

Finding NEMO: Documentation of the Norwegian Economy Model*

Leif Brubakk[†], Tore Anders Husebø,
Junior Maih, Kjetil Olsen and Magne Østnor
Norges Bank (Central Bank of Norway)

December 12, 2006

Abstract

Over the last decade monetary policy in Norway has gradually evolved from exchange rate targeting to flexible inflation targeting. In addition, globalization has affected the Norwegian economy substantially over the last decade. Monetary policy has increasingly been challenged on how to respond to supply side shocks, including shocks to productivity, the degree of competition both in product and labour markets, and terms of trade shocks. With all these developments came the need for new modeling tools. In this paper we document a new open-economy model for Norway named NEMO, that has been developed at Norges Bank as a tool for forecasting and policy analysis under the new monetary policy regime. In addition to a full technical account and description of the model properties, we explain the motivation and the modeling approaches that have been used, including the parameterization.

*The views and conclusions expressed in this paper are the responsibility of the authors alone and should not be interpreted as reflecting the views of Norges Bank.

[†]Corresponding author leif.brubakk@norges-bank.no

Contents

1	Introduction	6
2	The model	10
2.1	Main features	10
2.2	The linearized stationary model	12
2.2.1	The supply side	12
2.2.2	The demand side	15
2.3	A symmetric two-country model	18
2.3.1	Final goods	18
2.3.2	Intermediate goods	20
2.3.3	Households	24
2.3.4	Government	27
2.3.5	Market clearing	28
2.4	The small open economy: A stationary model	29
2.4.1	Final goods	30
2.4.2	Intermediate goods	30
2.4.3	Households	32
2.4.4	Market clearing	33
2.4.5	An exogenous foreign block	34
3	Parameterization	35
3.1	Steady state parameters	35
3.2	Dynamic parameters	38
3.2.1	Data, variables, priors and identification	39
3.2.2	Estimation results	41
4	Model Properties	43
4.1	A monetary policy shock	43
4.2	A temporary positive shock to labor-augmenting productivity	44
4.3	A temporary positive shock to competition in the domestic product market	45
4.4	A temporary positive shock to the degree of competition in the labor market	45
4.5	A temporary negative shock to household preferences for consumption	46
4.6	A temporary but persistent increase in the risk premium	46
5	Final remarks	47
A	Appendix	50
A.1	List of Variables and Parameters	50
A.2	The full stationary small open economy model	54
A.2.1	The domestic sector	54
A.2.2	The foreign sector	56

A.2.3	Shock processes	57
A.3	The steady state model	58
A.3.1	The domestic sector	58
A.3.2	Market clearing	60
A.3.3	The foreign sector	60
A.4	The linearized model for the domestic economy	61
A.4.1	Final goods	61
A.4.2	Intermediate goods	62
A.4.3	Houholds	62
A.4.4	Market clearing	63
A.4.5	Definitions	63
A.4.6	Shock processes	64
A.5	List of gross coefficients in the linearized model	65
A.6	Data description and sources	66
A.7	Estimation results	67
A.8	Dynamic repsonses to shocks	79

List of Figures

1	The production structure of NEMO	11
2	Demand components in per cent of GDP Mainland Norway.	36
3	Priors and posteriors for standard errors of the shock innovations	69
4	Priors and posteriors	70
5	Priors and posteriors for adjustment costs and interest rate reaction function parameters	71
6	Priors and posteriors for the persistence parameters	72
7	Actual and filtered Norway	73
8	Actual and filtered Norway	74
9	Smoothed innovations	75
10	Smoothed innovations	76
11	Shock processes	77
12	Impulse responses to a monetary policy shock	78
13	A monetary policy shock	79
14	A temporary positive shock to labor augmenting productivity	80
15	A temporary positive shock to competition in the domestic product market	81
16	A temporary positive shock to competition in the labor market	82
17	A temporary negative shock to household preferences for consumption	83
18	A temporary but persistent increase in the risk premium	84

List of Tables

1	Parameters that affect the steady state	38
---	---	----

2	List of variables and parameters	50
3	List of gross coefficients in the linearized model	65
4	Data description and sources	66
5	Results from Metropolis Hastings (parameters)	67
6	Results from Metropolis Hastings (standard deviation of structural shocks)	68
7	Results from Metropolis Hastings (standard deviation of measurement errors)	68
8	Standard deviations in per cent from model and data.	68

Acknowledgements

The authors would like to thank a number of people for both direct and indirect contributions to the development of NEMO and this documentation. First of all a special thank goes to Michel Juillard (CEPREMAP), Douglas Laxton (IMF), Paolo Pesenti (Federal Reserve Bank of New York) and Alasdair Scott (Bank of England) for invaluable support and help throughout the project. Also, without the contribution from a number of people at Norges Bank and other institutions, the project would not have been completed. We are therefore grateful to Hilde Bjørnland (Norwegian School of Management), Anne Berit Christiansen, Kari Due-Andresen, Jostein Eide, Kaj Halvorsen, Amund Holmsen, Kristine Høegh-Omdahl, Sharon McCaw (Reserve Bank of New Zealand), Dirk Muir (Bank of Canada), Jan Qvigstad, Øistein Røisland, Kjetil Storesletten (University of Oslo), Tommy Sveen, Ingvild Svendsen, Bjørn-Roger Wilhelmsen (First Securities) and Ida Wolden Bache for all their help, advice and support.

1 Introduction

Over the past decade, monetary policy in Norway has gradually evolved from exchange rate targeting to flexible inflation targeting. The key question in the new regime is: “What should interest rates be today and in the future in order to best achieve our objectives?”. To provide a good basis for answering this question, analytical tools with a number of prerequisites are needed. First and foremost, monetary policy must have a clearly defined role in a model designed to support inflation targeting. The model framework must be such that it is possible and necessary for monetary policy to act to bring inflation back to target following economic disturbances. For the model to be of practical use in the policy process, it should reflect the policymakers’ view about the workings of the economy. In particular, the role of expectations has to be taken seriously. A core policy model must reflect that agents not only take account of today’s economic policy, but also form expectations of future policy, and act accordingly. Furthermore, compared to an exchange rate peg, inflation targeting requires a more comprehensive understanding of the workings of the macroeconomy and the current economic situation. The increased importance of transparency and communication requires that the models are interpretable and well understood by the users and the policymakers. However, at the same time the model must be large enough to address the key issues and questions with which monetary policy is faced. Not the least, it must be confronted with data to avoid elements of wishful thinking.

The overriding evaluation criterion for a central bank model is how useful it proves to be in helping the policymakers conduct monetary policy. This criterion is somewhat vague, but rests on the fact that even the largest and most complex of macro models are gross simplifications of reality that can never hope to capture the “truth”. Rather, most policymakers today have a pragmatic view of the role of models in policymaking. Models are tools, not sources of definitive answers. From a central bank perspective, although the economic relationships built into a macro model must be based on careful and ongoing empirical analysis, the key advantage of using a well-formulated macroeconomic model is that it imposes structure and discipline on the forecast and policy analysis processes, by revealing and focusing attention on the relevant but perhaps non-obvious implications of what is known or assumed.

When designing and evaluating models, one must keep focus on the tasks for which they are to be used. Broadly speaking, policymaking can be divided into three interrelated tasks: identification of shocks and creation of forecasts, risk and policy analysis, and communication.

- *Identification of shocks and forecasting.* Because of the importance of expectations and the lags with which monetary policy affects the economy, an inflation-targeting central bank needs to be forward-looking and make projections of economic developments. Monetary policy is believed to have its greatest impact on inflation after some 2-3 years. However, the short-, medium- and long runs are all crucial. Creating forecasts is essentially a process of identifying

the forces that are driving current economic developments, and predicting how disequilibria will play out. The task of stabilization inherent in an inflation targeting regime also requires an active and explicit approach to defining the steady state of the economy.

- *Risk and policy analysis.* Given that the economy is subject to unforeseen shocks and will therefore almost always evolve differently than projected, it is essential that the central bank evaluates the risks around the chosen projection path. Inflation-targeting central banks must constantly deal with pervasive uncertainty regarding both the current situation and the workings of the economy and monetary policy. Yet they must make assumptions and set monetary policy such that inflation is expected to be on target within an appropriate time horizon. It is therefore very useful to set out assumptions explicitly in the context of an economic model, such that the implications of alternative assumptions, i.e. risks, can be explored and discussed in a systematic way.
- *Communication.* Since monetary policy is forward looking and operates largely through expectations, communication is an essential part of the central bank's brief. Open communication and transparency, and a clear, well-structured story around the projections help economic agents to understand the "typical" behavior of the central bank so that they can respond to new information in a way that contributes to the achievement of the central bank's objectives. This may enhance the effectiveness of the expectations channel of the monetary transmission mechanism.

A macro model cannot provide definitive answers. However, it can help ensure that the projections are internally consistent and that the policymakers' judgement calls are thought through and consistent over time. Also, no single model will be superior for all purposes, given the multi-faceted aspects of the three basic tasks at hand. For example, it is unlikely that a single model would be preferred for forecasting developments in both the very near term and the medium- to long term. Thus, there are benefits to a "suite" of models approach, where the comparative advantages of different model types are exploited. In practice, current information about economic developments, various economic models and judgment are all employed in the forecasting process.

Norges Bank's Inflation Report contains projections for developments in the Norwegian economy and presents an assessment of the monetary policy outlook, including a path for the interest rate. The interest rate path is the result of a broad assessment in which judgement plays an important role. The first chapter of the Inflation Report contains a discussion of a number of criteria that can be useful in assessing whether a future interest rate path appears reasonable compared with the monetary policy objective, see Qvigstad (2006).

At Norges Bank,¹ a core model is used² as an important tool for synthesizing information and estimating how the economy will move from the current situation towards long-term equilibrium. NEMO can be viewed as an extension of the current core model. In this paper we document and motivate these extensions and the choices made in order to meet the demands and prerequisites referred to above.

NEMO is an open economy Dynamic Stochastic General Equilibrium (DSGE) model,³ incorporating price- and wage stickiness, capital accumulation and balanced growth. It is a dynamic quarterly model. The theoretical framework of NEMO is based on the Global Economy Model developed at the International Monetary Fund, see Laxton and Pesenti (2003) and Bayoumi (2004), which again builds on the New Open-Economy Macroeconomics (NOEM) literature see for example Obstfeld and Rogoff (1995), Obstfeld and Rogoff (2000), Corsetti and Pesenti (2001) and Lane (2001), and empirical DSGE open-economy applications like Smets and Wouters (2003, 2004).

A distinct feature of a DSGE model is that the behavior of the different economic agents is modeled explicitly and founded on choice-theoretic assumptions. Households maximize expected utility given their budget constraints, and choose the optimal allocation of time between work and leisure, and the optimal allocation of income between consumption and saving. Firms set prices by maximizing expected profit given their production technology. Modeling behavior explicitly aids interpretation. Moreover, the various disturbances can be interpreted and attributed to changes in preferences, technology, market structure, policy etc.

The earlier DSGE models had new classical features, such as perfect competition and fully flexible prices, and are often denoted 'real business cycle' (RBC) models. These models often focused on supply side factors, such as technology shocks, as the main source of economic fluctuations. Business cycles could be explained by rational agents reacting to exogenous disturbances, and since the cycles represented optimal behavior, they should thus not be counteracted by economic policy. Since prices and wages were perfectly flexible, monetary policy could not affect the real economy in this type of models, only the general price level.

During the last ten years a new class of DSGE models has become influential, both within academic research and, more recently, as forecasting and policy tools for central banks. This class of DSGE models has two additional key features:

- *Nominal rigidities.* In NEMO we assume that there are costs, either implicit or explicit, associated with changing prices and wages. These costs imply that prices and wages change only gradually in response to shocks. The policy

¹For a description of the forecasting process and the tools used at Norges Bank, see Kloster and Solberg-Johansen (2006).

²For a documentation of the core model in use currently, see Husebø, McCaw, Olsen and Røisland (2004).

³By dynamic we mean that model solution determines dynamic paths for all endogenous variables in the system, by stochastic we mean that the dynamic path is driven by stochastic shocks and by general equilibrium we mean that all markets clear in all periods.

implication of nominal rigidities is that monetary policy now affects the real economy in the short run.

- *Monopolistic competition.* Firms have market power and set prices as a mark-up over their marginal costs. This makes it profitable to meet increased demand even if prices do not change.

These features imply traditional Keynesian effects in the short run. The long-run properties of DSGE models are, however, similar to those of the earlier RBC models. The reason is that prices and wages are assumed to adjust fully in the long run even if there are nominal rigidities in the short run. Thus, whereas monetary policy affects the real economy in the short run, in the long run monetary policy can influence only nominal variables, and is therefore neutral with respect to real variables. In the long run, production is determined by technology, preferences and the supply of inputs. The new type of DSGE models therefore have 'Keynesian' features in the short run, and new classical (RBC) features in the long run. They are therefore often referred to as 'New Classical Synthesis', or 'New Keynesian' models.

The paper is organized as follows. In section 2 we derive and describe the theoretical structure of NEMO. For readers that are interested in a brief overview of the model, we refer to the introduction in section 2.1 and section 2.2 that explains the log-linearized version of the model. Section 3 discusses the current parameterization of NEMO where we have used both calibration and estimation techniques. In section 4 we discuss model properties by examining how key variables respond to the most important shocks. An important purpose of this section is to illustrate how the shocks can be disentangled when the model is confronted with data. Section 5 offers some concluding remarks. The complete stationary model is summarized in the appendix, along with the steady state solution. The appendix also offers a description of the mnemonics used for variables and parameters.

2 The model

In this section we present and derive the model. For pedagogical reasons, we start in section 2.2 by presenting an overview of the general structure of the model in linearized form. In section 2.3 and 2.4, we take a step back and derive the model from the basic optimization problems of the households and firms in the economy. The model presented in section 2.2 is a linearized version of the model presented in section 2.4.

2.1 Main features

In NEMO, the world economy consists of two countries, *home* and *foreign*, which will be interpreted as Norway and its trading partners, respectively. Our point of departure is a two-country model, where the structure of the two countries are the same. In order to ease notation, we present the model in terms of the home economy. An identical set of equations can be used to describe the foreign economy.⁴ We adopt the small open economy assumption, implying that the foreign economy is fully exogenous from the point of view of the home country. Hence, economic developments in Norway have no effects on its trading partners. This is a reasonable description, given the relative size of the Norwegian economy.

Both economies consist of households, firms and a government sector, including the monetary authority. There are two production sectors, an *intermediate goods sector* and a *final goods sector*. Each intermediate good is produced by a single firm, using differentiated labor, l , and capital services, K , as inputs. The market for intermediate goods is characterized by monopolistic competition. The intermediate good, T , can be exported or sold domestically to the final goods sector. Under the assumption of monopolistic competition, intermediate firms will set their prices as a mark-up over marginal costs. Since we abstract from the possibility of arbitrage across countries, intermediate firms can set different prices at home and abroad.⁵ Furthermore, we assume that it is costly for intermediate firms to change their prices. The specification of the price adjustment costs is consistent with Rotemberg (1982).

Each firm is assumed to make an independent investment decision each period. The capital stock is specific to each firm, and there exists no single capital good that can be rented for use in any firm. Thus, capital is firm specific and there is no rental market for capital. The level of capital services, which is the input factor relevant for production, depends both on the rate of capacity utilization and the physical capital stock. Within a given period, the capital stock is fixed, so increasing the input of capital services requires a higher rate of capacity utilization.

In the final goods sector, domestic and imported intermediate goods, Q and M respectively, are combined to produce a final retail good, A . Firms in this sector are assumed to operate under perfect competition. The final good can be used

⁴Foreign variables are indexed with a star.

⁵We abstract from transportation costs in this model.

for consumption, C , investment, I , government spending, G , and oil investment, $IOIL$.⁶

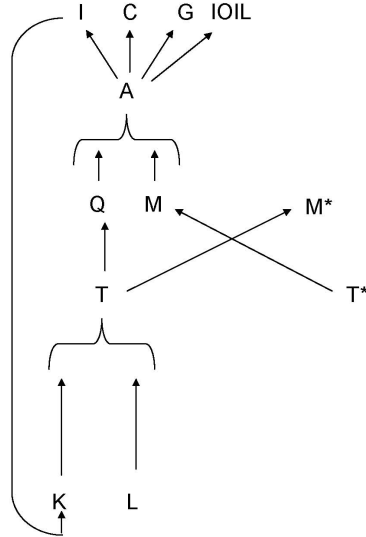

Figure 1: The production structure of NEMO

We assume that there are two types of households in the economy. One type, the *savers*, maximize utility subject to an intertemporal budget constraint. They optimize their consumption intertemporally by using credit markets to achieve a smooth consumption path. They also supply labor and set their wage subject to adjustment costs (nominal wage rigidities) and demand for labor by intermediate firms. The other set of households, labelled *spenders* (or liquidity constrained households), simply consume their wage income each period.⁷ We assume that spenders take the wage negotiated by the savers as given and supply the labor demanded for this given wage rate.

Government spending is financed through lump-sum tax revenues. The monetary authority controls the national short-term nominal interest rate. Monetary policy is specified either in terms of a interest rate rule, e.g. a Taylor rule, or in terms of a targeting rule where a loss function is minimized. In this paper we employ an interest rate rule, targeting expected inflation. Thus, monetary policy ensures that

⁶We model the mainland economy, that is, the total economy excluding the oil sector. However, whereas oil production is not modeled, we include (exogenously) oil investments on the demand side, affecting mainland industries.

⁷If households were all of the forward-looking optimizing type, temporary changes in income would have only a negligible effect on consumption, since it is the "permanent income" which affects consumption for such households. Empirical studies show, however, that temporary changes in income also affect consumption. This is captured by introducing "spenders". In reality, there are not two distinct types of consumers; most consumers can probably be characterized as partly forward-looking and optimizing, and partly as following simpler rules of thumb. For technical reasons it is simpler to model this as two separate groups, but this should not be interpreted too literally.

the steady state inflation rate is equal to the inflation target.

We assume that the economy evolves along a balanced growth path, driven by an exogenous productivity shock. We use the convention that capital letters refer to non-stationary variables whereas lower-case letters indicate that the variable in question is stationary.

2.2 The linearized stationary model

In this section, we present the key behavioral equations⁸ of the model in log-linearized form. For pedagogical purposes and in many applications, it can be useful to work with a linearized representation of the model.⁹ A linear model can be more transparent and, hence, make it easier to understand the important aspects of the model. However, it should be noted that the linearized model is only an approximation of the non-linear system. It is only valid if the economy is close to steady state. In the following, \hat{x} indicates that the variable x is measured as the log-deviation from its steady state¹⁰. The parameters of the log-linearized model will depend on the structural parameters from the non-linear model and steady state values of the endogenous variables. In the following, the linearized model will be represented in terms of gross parameters, f_j , defined in table 3 in appendix A.5. This is done in order to keep the exposition as transparent as possible.

2.2.1 The supply side

Intermediate goods

Intermediate firms produce a differentiated good, t_t , using labor, l_t , and capital services, \bar{k}_t , as inputs. We assume a Constant Elasticity of Substitution (CES) production function, which in log-linear form can be expressed as:

$$\hat{t}_t = f_1 \left(\hat{z}_t^L + \hat{l}_t \right) + (1 - f_1) \hat{k}_t, \quad (2.2.1)$$

where z_t^L is a stationary labor augmenting productivity shock. The parameter $f_1 \in [0, 1]$ denotes the wage income share, and depends on the the share of labor in the production function and the elasticity of substitution between labor and capital.

To shed some light on how total factor productivity and labor productivity is related around the stochastic trend, we can rewrite (2.2.1) as:

$$\widehat{TFP}_t \equiv f_1 \hat{z}_t^L = \underbrace{\hat{t}_t - \hat{l}_t}_{\text{labor productivity}} - (1 - f_1) \underbrace{\left(\hat{k}_t - \hat{l}_t \right)}_{\text{capital intensity}}. \quad (2.2.2)$$

⁸The full linearized model is given in appendix A.4.

⁹The linearized model is based on the first-order Taylor approximation to the non-linear equations, around the steady state.

¹⁰In the case where the variable is zero in steady state, \hat{x} refers to the level deviation from steady state.

This equation states that total factor productivity is equal to labor productivity adjusted for changes in capital intensity. As is clear from (2.2.2), total factor productivity is exogenous in the model, driven by the labor-augmenting productivity shock.

Capital services, \bar{k}_t , depends on the physical capital stock, k_{t-1} , and the utilization rate of capital, u_t , according to:

$$\hat{k}_t = \hat{u}_t + \hat{k}_{t-1} - \hat{\pi}_t^z, \quad (2.2.3)$$

where π_t^z is a shock to the trend growth rate.¹¹

Intermediate firms choose inputs of labor and capital, and prices for their goods, both at home and abroad, in order to maximize their discounted profits. This yields a set of first-order conditions. The optimal condition for labor input can be expressed in terms of the marginal costs, mc_t , according to:

$$\hat{m}c_t = \hat{w}_t - \widehat{mpl}_t, \quad (2.2.4)$$

where w_t denotes the real wage and mpl_t is the marginal product of labor, defined as:

$$\widehat{mpl}_t = f_2 (\hat{t}_t - \hat{l}_t) + (1 - f_2) \hat{z}_t^L.$$

The parameter $f_2 > 0$ is the inverse of the elasticity of substitution between capital and labor. Alternatively, we can express the marginal costs as:

$$\hat{m}c_t = f_1 (\hat{w}_t - \hat{z}_t^L) + (1 - f_1) \hat{r}_t^K, \quad (2.2.5)$$

where

$$\hat{r}_t^K \equiv \hat{m}c_t + f_2 (\hat{t}_t - \hat{k}_t).$$

The motivation for making use of this definition is that r_t^K can be interpreted as a *shadow* rental rate of capital services. Using this interpretation, equation (2.2.5) states that marginal costs are a function of real factor prices and the labor augmenting productivity shock. Alternatively, r_t^K can be interpreted as the real return on capital. A shock to labor productivity, i.e. an increase in z^L , unambiguously reduces marginal costs.

As already mentioned, firms can change the input of capital services by changing the utilization rate or by adjusting the physical capital stock. In optimum, the cost of increasing the utilization rate with one unit should equal the return of doing so. Log-linearizing the first-order condition for the capital utilization rate, we obtain:

$$f_3 \hat{u}_t = \hat{r}_t^K, \quad (2.2.6)$$

where f_3 is a parameter measuring the costs of changing the utilization rate. Hence, the left hand side of (2.2.6) measures the marginal costs of increasing the utilization rate by one unit. This is equal to the real return on capital services, \hat{r}_t^K .

¹¹This term originates from the fact that real variables are measured relative to the underlying trend growth.

Intermediate firms are assumed to have some degree of market power, both in the domestic and foreign market. This implies that firms will set prices as a mark-up over marginal costs. Furthermore, we assume that there are costs, either implicitly or explicitly, to adjusting prices. Log-linearizing the expression for the optimal price of goods sold in the domestic market, yields the following linear Phillips-curve for domestic inflation, π_t^Q :

$$\hat{\pi}_t^Q = f_4 \hat{\pi}_{t-1}^Q + (1 - f_4) E_t \hat{\pi}_{t+1}^Q + f_5 (\hat{m}c_t - \hat{p}_t^Q) - f_6 \hat{\theta}_t. \quad (2.2.7)$$

This equation states that domestic inflation is a function of its own lead and lag, marginal costs relative to the price of domestic intermediates, p_t^Q . The term $\hat{m}c_t - \hat{p}_t^Q$ operates as an error correction term; whenever the marginal costs increase more than the current price charged by firms, there will be a tendency for nominal prices to increase. Due to the price adjustment costs, it will not be optimal for firms to increase prices one to one with marginal costs in the short run. The variable θ_t represents a shock to the degree of substitution between the different varieties of domestic intermediate goods (demanded by the final good producers). It can be interpreted as a measure of the degree of competition facing intermediate firms in the domestic market. For example, if θ_t increases, implying a loss in market power, there will be downward pressure on domestic prices. The weight on lagged inflation in the Phillips curve is determined by $f_4 \in [0.5, 1]$. The effect of current and expected changes in marginal costs on domestic inflation is governed by the parameter $f_5 \geq 0$, which is a function of structural parameters related to the degree of market competition and the cost of adjusting prices.

Domestic firms also export to foreign markets. Export prices are set in the local currency, and evolve according to:

$$\hat{\pi}_t^{M*} = f_4 \hat{\pi}_{t-1}^{M*} + (1 - f_4) E_t \hat{\pi}_{t+1}^{M*} + f_7 (\hat{m}c_t - \hat{s}_t - \hat{p}_t^{M*}) - f_8 \hat{\theta}_t^*, \quad (2.2.8)$$

where p_t^{M*} is the real export price, denoted in foreign currency, π_t^{M*} denotes percentage change in the nominal price, s_t is the real exchange rate and θ_t^* measures the degree of competition in the foreign imports market. Since we assume an identical set-up for foreign intermediate firms, we have a corresponding Phillips-curve for imported inflation, π_t^M , at home:

$$\hat{\pi}_t^M = f_4 \hat{\pi}_{t-1}^M + (1 - f_4) E_t \hat{\pi}_{t+1}^M + f_9 (\hat{m}c_t^* + \hat{s}_t - \hat{p}_t^M) - f_{10} \hat{\theta}_t^*, \quad (2.2.9)$$

where p_t^M denotes the real import price. Imported inflation is an increasing function of its own lead and lag, marginal costs abroad, the real exchange rate and shocks to market power.

Final goods

Domestic and imported intermediates, denoted q_t and m_t , are used to produce an aggregate final good, a_t . The final good can be used for consumption, investment,

government spending and oil investment. We assume a CES production function, which in log-linearized form reads:

$$\hat{a}_t = f_{11}\hat{q}_t + (1 - f_{11})\hat{m}_t, \quad (2.2.10)$$

where $f_{11} \in [0, 1]$ denotes the share of domestically produced in the final goods aggregate. The optimal input of domestic and imported goods in the production of the final good depends on real prices and domestic demand, according to:

$$\hat{q}_t = -f_{12}\hat{p}_t^Q + \hat{a}_t, \quad (2.2.11)$$

$$\hat{m}_t = -f_{12}\hat{p}_t^M + \hat{a}_t, \quad (2.2.12)$$

where $f_{12} > 0$ equals the elasticity of substitution between domestic and imported goods in the final goods aggregate. From (2.2.11) and (2.2.12), it is clear that the relative input of domestic and imported intermediates is driven by relative prices. For example, if the relative price on imports increases, final good producers will increase their relative demand for domestic intermediates.

Each household supplies a differentiated type of labor. This gives households some monopoly power when setting wages. Furthermore, we assume that it is costly for households to reset their wages. This assumption introduces some sluggishness in the wage formation, consistent with what we observe in the data. Log-linearizing the first order condition for wages, yields the following wage Phillips-curve:

$$\hat{\pi}_t^W = f_4\hat{\pi}_{t-1}^W + (1 - f_4)E_t\hat{\pi}_{t+1}^W + f_{13}(\hat{m}rs_t - \hat{w}_t) - f_{14}\hat{\psi}_t, \quad (2.2.13)$$

where:

$$\hat{m}rs_t = f_{15}\hat{c}_t + f_{16}\hat{c}_{t-1} + f_{17}\hat{l}_t - \hat{z}_t^U. \quad (2.2.14)$$

Equation (2.2.13) states that nominal wage inflation, $\hat{\pi}_t^W$, is a function of its own lead and lag, the marginal rate of substitution, $\hat{m}rs_t$, and the degree of monopoly power, $\hat{\psi}_t$. The marginal rate of substitution measures the cost in utility terms of supplying an extra hour of labor. Hence, (2.2.13) indicates that there will be a tendency for nominal wages to increase whenever the compensation households receive from working, i.e. the real wage, is lower than the ‘marginal costs’. The size of adjustment in nominal wages is governed by $f_{13} > 0$, which is determined by the degree of competition in the labor market and the costs of adjusting wages. Furthermore, nominal wages will fall to the extent that competition in the labor market increases (higher $\hat{\psi}_t$). This could be interpreted as a loss in bargaining power. \hat{z}_t^U is a positive preference shock, raising the marginal utility of consumption relative to leisure. Hence, an increase in \hat{z}_t^U reduces the marginal rate of substitution.

2.2.2 The demand side

The optimality conditions for consumption and bonds can be summarized in the consumption euler equation, which in log-linearized form is given by:

$$\hat{c}_t = f_{18}E_t\hat{c}_{t+1} + (1 - f_{18})\hat{c}_{t-1} - f_{19}E_t(\hat{r}_t - \hat{\pi}_{t+1}) + \text{shocks}_t^c, \quad (2.2.15)$$

where \hat{c}_t denotes consumption, r_t is the nominal interest rate and π_{t+1} is the overall inflation. Maximizing lifetime utility implies choosing a consumption path such that the utility loss of giving up one unit of consumption in period t equals the expected utility gain that can be achieved in period $t + 1$, by investing in bonds and consuming the gross real return. Equation (2.2.15) could be solved forward to show that the consumption path is fully determined by expected real interest rates and lagged consumption. This does not mean that consumption is independent of wage income. Rather, the interpretation is that transitory changes in labor income have no effect on changes in consumption. This is consistent with the results emphasized by Friedman (1956) and Modigliani (1986). By combining the consumption euler equation with the household budget constraint, it is possible to derive a standard consumption function depending on initial wealth and expected income. Households are assumed to dislike changes in the consumption over time, consumption in period t will therefore also depend on the level of consumption in period $t - 1$. This assumption is further described in section 2.3. The parameter $f_{19} > 0$ determines how sensitive consumption demand is to changes in the real interest rate. This will, among other factors, depend on the degree of habit in consumption. If households dislike changing their consumption habits, changes in the real interest rate will only gradually affect consumption.

Investment is derived from firms' future demand for capital. We assume that changing the rate of investment relative to the existing capital stock is costly.¹² The first order conditions for investment, i_t , and capital yields the following log-linear investment Euler equation:

$$\begin{aligned} \hat{i}_t - \hat{k}_{t-1} = & f_{20} \left(\hat{i}_{t-1} - \hat{k}_{t-2} \right) + f_{21} E_t \left(\hat{i}_{t+1} - \hat{k}_t \right) \\ & - f_{22} E_t \left(r_t - \hat{\pi}_{t+1} \right) + f_{23} E_t \hat{r}_{t+1}^K + shocks_t^I. \end{aligned} \quad (2.2.16)$$

The investment to capital ratio,¹³ is decreasing in the real interest rate and increasing in the expected real return on capital. An increase in the real interest rate reduces the discounted value of a given expected return on capital. The inclusion of the lag and lead of the investment to capital ratio is related to the capital adjustment costs.

In log-linearized form, the capital accumulation equation can be written:

$$\hat{k}_t = f_{24} \left(\hat{k}_{t-1} - \hat{\pi}_t^z \right) + (1 - f_{24}) \hat{i}_t. \quad (2.2.17)$$

The trade balance, defined as export revenues minus import costs, can be sum-

¹²More precisely, the investment costs originates from two sources. First, it is costly to choose a *level* of investment to capital ratio that deviates from the trend ratio. Second, we also assume that *changes* in the investment to capital ratio is costly. An alternative set-up would be to introduce lumpy investments along the lines of Sveen and Weinke (2007). In their formulation, a given firm can only change its capital stock at random intervals. However, to a first order approximation, this yields the same investment euler equation as in our model.

¹³The reason why we obtain an Euler equation in the investment to capital ratio and not simply in investment, is due to the fact that investment adjustment costs are specified in terms of the capital stock.

marized by the following log-linear equation:

$$\hat{e}x_t - f_{25}\hat{i}m_t = (\hat{s}_t + \hat{p}_t^{M*} + \hat{m}_t^*) - f_{25}(\hat{p}_t^M + \hat{m}_t), \quad (2.2.18)$$

where ex_t and im_t denote real export revenues and import costs, respectively. Correspondingly, \hat{m}_t^* and \hat{m}_t denote export and import (volume) demand. From the left hand side of (2.2.18), it is clear that the trade balance depends on the demand for exports and imports, relative prices and the real exchange rate.

Based on the market clearing condition for intermediate goods, which simply states that the supply of intermediates must equal the domestic and foreign demand:

$$\hat{t}_t = f_{26}\hat{q}_t + f_{27}\hat{m}_t^*, \quad (2.2.19)$$

we can define an expression for GDP, y_t :

$$y_t = f_{28}\hat{a}_t + f_{29}(\hat{e}x_t - f_{25}\hat{i}m_t), \quad (2.2.20)$$

where

$$\hat{a}_t = f_{30}\hat{c}_t + f_{31}\hat{u}_t + f_{32}\hat{g}_t + f_{33}\hat{i}oil_t, \quad (2.2.21)$$

is the market clearing equation for final goods. Government spending, g_t , and oil investments, $ioil_t$, are assumed to be exogenous processes.

The optimal allocation of domestic and foreign bonds gives the UIP condition:

$$\hat{s}_t = \hat{s}_{t+1} - \{(r_t - \hat{\pi}_{t+1}) - (\hat{r}_t^* - \hat{\pi}_{t+1}^*)\} - f_{34}\hat{b}_{H,t}^* + \hat{z}_t^B,$$

where $b_{H,t}^*$ denotes household holdings of foreign bonds. In optimum, the return on domestic and foreign bonds must be equal. We assume that households must pay a fee to trade in the foreign bond market. This financial intermediary cost is assumed to be increasing in the level of borrowing. Hence, a high level of foreign debt, i.e. $\hat{b}_{H,t}^* < 0$, implies a high premium on foreign real interest rates. The financial premium is introduced in order to ensure that consumption follows a stationary process. In addition to the endogenous risk premium, we also include an exogenous premium, denoted \hat{z}_t^B . This shock is described in section 4.6.

Starting from the household budget constraint, we can derive an equation for the accumulation of foreign assets. In linearized form this reads:

$$\hat{b}_{H,t}^* = f_{35}\hat{b}_{H,t-1}^* + f_{36}(\hat{e}x_t - f_{25}\hat{i}m_t). \quad (2.2.22)$$

The end of period net foreign asset position is determined by the asset position at the beginning of the period and changes in the trade balance.¹⁴

¹⁴In the general set-up, the change in net foreign assets is equal to the current account, i.e. interest payments on asset holdings plus the trade balance. Hence we would expect the interest rate on foreign assets to appear in (2.2.22). However, since we assume that the level of net foreign assets is zero in steady state, the first order effect of changes in the foreign interest rate on the accumulation of foreign assets is zero.

As mentioned, monetary policy can either be specified in terms of a simple rule for the policy instrument, for example given by:

$$r_t = \omega_r r_{t-1} + (1 - \omega_r) [r + \omega_p \hat{\pi}_{t+4}] + z_t^R, \quad (2.2.23)$$

or in terms of a targeting rule where the central bank loss function is minimized and the optimal policy response is derived. z_t^R is a shock to the monetary policy rule, see section 4.1 for a description of how key variables respond to this shock.

Adding an equation for foreign imports, \hat{m}_t^* , and 4 identities determining price and wage growth, this leaves us with 27 equations to determine an equal number of endogenous variables:

$$\begin{aligned} & \hat{y}_t, \hat{w}_t, \hat{p}_t^{M^*}, \hat{p}_t^M, \hat{p}_t^Q, \hat{a}_t, \hat{t}_t, \hat{b}_t^{*H}, \hat{r}_t, \hat{c}_t, \hat{k}_t, \hat{c}u_t, \hat{k}_t, \hat{t}_t, \\ & \hat{l}_t, \hat{s}_t, \hat{m}_t^*, \hat{m}_t, \hat{q}_t, \hat{\pi}_t, \hat{\pi}_t^W, \hat{\pi}_t^{M^*}, \hat{\pi}_t^M, \hat{\pi}_t^Q, \hat{r}_t^K, \widehat{m}c_t, \widehat{m}r_{st}. \end{aligned}$$

The model includes 4 foreign variables, which are exogenous shocks from the point of view of the home economy:

$$\hat{y}_t^*, \hat{\pi}_t^*, \hat{r}_t^*, \widehat{m}c_t^*,$$

In addition there are 10 domestic exogenous shocks.

2.3 A symmetric two-country model

In this section, we take a step back and derive the general theoretical framework underlying the linearized model discussed above. We start by assuming a symmetric two-country set-up. Each country consists of households, firms and a government sector which includes the central bank. There are two production sectors. In the *intermediate* sector a continuum of firms produce a differentiated good, using labor and capital as inputs. Combining domestic and imported intermediate goods, the firms in the *final goods* sector produce a final good that can be used for consumption, investment, government spending and oil investment. The model is derived under the assumption that the various agents in the economy maximize their respective objective functions, given a set of constraints.

2.3.1 Final goods

The relative size of the home country is measured by the normalized parameter $n \in [0, 1]$. We assume that there is a continuum of final good producers indexed by $x \in [0, n]$ ($0 \leq n \leq 1$). The final good, A , is produced using a composite of domestic intermediate goods, Q , and imports, M , as inputs. The specific technology adopted is a constant elasticity of substitution (CES) production function:

$$A_t(x) = \left[\eta^{\frac{1}{\mu}} Q_t(x)^{1-\frac{1}{\mu}} + (1 - \eta)^{\frac{1}{\mu}} M_t(x)^{1-\frac{1}{\mu}} \right]^{\frac{\mu}{\mu-1}}, \quad (2.3.1)$$

where the degree of substitutability between the indices of domestic and imported goods is determined by the parameter $\mu > 0$, whereas η ($0 \leq \eta \leq 1$) measures the steady-state share of domestic intermediates in the case where relative prices are equal to 1. Hence, the latter is often interpreted as the degree of home bias.

Furthermore, the composite good $Q(x)$ is an index of differentiated domestic intermediate goods, produced by a continuum of firms $h \in [0, n]$:

$$Q_t(x) = \left[\left(\frac{1}{n} \right)^{\frac{1}{\theta_t}} \int_0^n Q_t(h, x)^{1-\frac{1}{\theta_t}} dh \right]^{\frac{\theta_t}{\theta_t-1}}, \quad (2.3.2)$$

where the degree of substitution between domestic intermediates is captured by $\theta > 1$. We allow this parameter to be time varying according to:

$$\ln \left(\frac{\theta_t}{\theta} \right) = \lambda^\theta \ln \left(\frac{\theta_{t-1}}{\theta} \right) + \varepsilon_t^\theta, \quad (2.3.3)$$

where θ is the steady state value and λ^θ is the autocorrelation coefficient, determining the persistence of the shock process. The error term ε_t^θ is assumed to be white noise.

Similarly, the composite imported input is an aggregate of differentiated import goods indexed $f \in [n, 1]$:

$$M_t(x) = \left[\left(\frac{1}{1-n} \right)^{\frac{1}{\theta_t^*}} \int_n^1 M_t(f, x)^{1-\frac{1}{\theta_t^*}} df \right]^{\frac{\theta_t^*}{\theta_t^*-1}}, \quad (2.3.4)$$

where $\theta^* > 1$ is the degree of substitution between imported goods. The elasticity of substitution across differentiated imports evolves according to:

$$\ln \left(\frac{\theta_t^*}{\theta^*} \right) = \lambda^{\theta^*} \ln \left(\frac{\theta_{t-1}^*}{\theta^*} \right) + \varepsilon_t^{\theta^*}. \quad (2.3.5)$$

The demand for the different varieties of domestic goods, $Q(h, x)$, is obtained by minimizing total outlays on domestic intermediate goods given (2.3.2). This yields the following demand functions:

$$Q_t(h, x) = \left(\frac{P_t^Q(h)}{P_t^Q} \right)^{-\theta_t} Q_t(x), \quad (2.3.6)$$

where $P_t^Q(h)$ denotes the price of variety h produced at home and P_t^Q is the corresponding aggregate price,¹⁵ given by:

$$P_t^Q = \left[\left(\frac{1}{n} \right) \int_0^n P_t^Q(h)^{1-\theta_t} dh \right]^{\frac{1}{1-\theta_t}}. \quad (2.3.7)$$

¹⁵Defined as the minimal outlay required to produce one unit of the composite.

In a similar fashion, the demand for differentiated imports is given by:

$$M_t(x, f) = \left(\frac{P_t^M(f)}{P_t^M} \right)^{-\theta_t^*} M_t(x), \quad (2.3.8)$$

where $P_t^M(f)$ denotes the price of imported variety f and P_t^M is the aggregate import price:

$$P_t^M = \left[\left(\frac{1}{1-n} \right) \int_{1-n}^1 P_t^M(f)^{1-\theta_t^*} df \right]^{\frac{1}{1-\theta_t^*}}. \quad (2.3.9)$$

The optimal choice of $Q_t(x)$ and $M_t(x)$ can be found by minimizing $P_t^Q Q_t(x) + P_t^M M_t(x)$ given (2.3.1). This yields the following demand functions:

$$Q_t(x) = \eta \left(\frac{P_t^Q}{P_t} \right)^{-\mu} A_t(x), \quad (2.3.10)$$

$$M_t(x) = (1-\eta) \left(\frac{P_t^M}{P_t} \right)^{-\mu} A_t(x), \quad (2.3.11)$$

where P_t is the aggregate price of the final good. The final goods sector is characterized by perfect competition, implying that profits are zero:

$$P_t A_t(x) = P_t^Q Q_t(x) + P_t^M M_t(x). \quad (2.3.12)$$

2.3.2 Intermediate goods

Each intermediate firm h is assumed to produce a differentiated good $T_t(h)$ for the domestic and the foreign market using the following CES production function:

$$T_t(h) = \left[(1-\alpha)^{\frac{1}{\xi}} (Z_t z_t^L l_t(h))^{1-\frac{1}{\xi}} + \alpha^{\frac{1}{\xi}} \bar{K}_t(h)^{1-\frac{1}{\xi}} \right]^{\frac{\xi}{\xi-1}}, \quad (2.3.13)$$

where $\alpha \in [0, 1]$ is the capital share and ξ denotes the elasticity of substitution between labor and capital. The variables $l_t(h)$ and $\bar{K}_t(h)$ denote, respectively, hours used and effective capital of firm h in period t . There are two exogenous shocks to productivity in the model: Z_t refers to an exogenous permanent (level) technology process, which grows at the gross rate π_t^z , whereas z_t^L denotes a temporary (stationary) shock to productivity (or labor utilization). We assume the following processes:

$$\ln(Z_t) = \ln(Z_{t-1}) + \ln(\pi^z) + \ln \frac{\pi_t^z}{\pi^z}, \quad (2.3.14)$$

where

$$\ln \frac{\pi_t^z}{\pi^z} = \lambda^z \ln \frac{\pi_{t-1}^z}{\pi^z} + \varepsilon_t^z, \quad (2.3.15)$$

and

$$\ln \left(\frac{z_t^L}{z^L} \right) = \ln \left(\frac{z_{t-1}^L}{z^L} \right) + \varepsilon_t^{z^L}. \quad (2.3.16)$$

We make the following assumptions regarding the firms' capital accumulation. First, the additional capital resulting from an investment decision becomes productive with a one period delay. We therefore define $K_t(h)$ as firm h 's capital stock chosen in period t which becomes productive in period $t + 1$. Second, firm h 's effective capital in period t is related to the capital stock that was chosen in period $t - 1$ by

$$\bar{K}_t(h) = u_t(h) K_{t-1}(h), \quad (2.3.17)$$

where $u_t(h)$ is the rate of capital utilization. By utilizing its capital stock the firm incurs the cost of $\gamma_t^u(h)$ units of final goods per unit of capital. We assume the following functional form:

$$\gamma_t^u(h) = \phi^{u1} \left(e^{\phi^{u2}(u_t(h)-1)} - 1 \right), \quad (2.3.18)$$

where ϕ^{u1} and ϕ^{u2} are parameters determining the cost of deviating from the steady state utilization rate (normalized to one).

Third, firms face a convex capital adjustment cost. Firm h 's law of motion of physical capital reads:

$$K_t(h) = (1 - \delta) K_{t-1}(h) + \Psi_t(h) K_{t-1}(h), \quad (2.3.19)$$

where $\delta \in [0, 1]$ is the rate of depreciation. In order to capture investment flows in a realistic way we assume convex capital adjustment costs. This is reflected in the function Ψ_t , which measures the rate of capital accumulation. It is given by:

$$\begin{aligned} \kappa_t(h) = & \frac{I_t(h)}{K_{t-1}(h)} - \frac{\phi^{I1}}{2} \left[\left(\frac{I_t(h)}{K_{t-1}(h)} - \frac{I}{K} \right) \right]^2 \\ & - \frac{\phi^{I2}}{2} \left(\frac{I_t(h)}{K_{t-1}(h)} - \frac{I_{t-1}}{K_{t-2}} \right)^2, \end{aligned} \quad (2.3.20)$$

where I_t denotes investment and z_t^I is an investment shock.¹⁶ The parameters ϕ^{I1} and ϕ^{I2} determine the cost of deviating from the steady state investment to capital ratio and the cost of changing this ratio, respectively.

The labor input is an aggregate of hours supplied by the different households. We assume the following technology:

$$l_t(h) = \left[\frac{1}{n} \int_0^n l_t(h, j)^{1-\frac{1}{\psi_t}} dj \right]^{\frac{\psi_t}{\psi_t-1}}, \quad (2.3.21)$$

where ψ_t denotes the elasticity of substitution between different types of labor, and evolves according to:

$$\ln \left(\frac{\psi_t}{\psi} \right) = \lambda^\psi \ln \left(\frac{\psi_{t-1}}{\psi} \right) + \varepsilon_t^\psi. \quad (2.3.22)$$

¹⁶This shock could e.g. represent changes in the relative price of consumption and investment.

Cost-minimization by intermediate firms implies the following demand for labor type j :

$$l_t(h, j) = \left(\frac{W_t(j)}{W_t} \right)^{-\psi_t} l_t(h), \quad (2.3.23)$$

where $W_t(j)$ is the nominal wage chosen by household j and W_t is the aggregate nominal wage, defined as the unit cost of the labor input, $l_t(h)$.

Firms sell their goods under monopolistic competition. Each firm h charges different prices at home and abroad: $P_t^Q(h)$ in the home market and $P_t^{M^*}(h)$ abroad, where the latter is denoted in foreign currency.¹⁷ Following Rotemberg (1982), we assume that firms want to avoid changing their prices. When a firm changes its prices it incurs intangible costs that do not affect cash-flow but enter the maximization problem as a form of “disutility”. The intangible costs of adjusting prices in the domestic and the foreign market are, respectively:

$$\gamma_t^{PQ}(h) \equiv \frac{\phi^{PQ}}{2} \left[\frac{P_t^Q(h)/P_{t-1}^Q(h)}{P_{t-1}^Q/P_{t-2}^Q} - 1 \right]^2, \quad (2.3.24)$$

$$\gamma_t^{PM^*}(h) \equiv \frac{\phi^{M^*}}{2} \left[\frac{P_t^{M^*}(h)/P_{t-1}^{M^*}(h)}{P_{t-1}^{M^*}/P_{t-2}^{M^*}} - 1 \right]^2, \quad (2.3.25)$$

where the cost of changing prices is governed by the parameters ϕ^{PQ} and ϕ^{M^*} .

Cash-flows in a given period are immediately paid out to shareholders (savers) as dividends, $DIV_t(h)$:

$$\begin{aligned} DIV_t(h) &= P_t^Q(h) \int_0^n Q_t(h, x) dx + P_t^{M^*}(h) S_t \int_{1-n}^1 M_t^*(h, x^*) dx^* \\ &\quad - W_t l_t(h) - P_t I_t(h) - P_t \gamma_t^{cu}(h), \end{aligned} \quad (2.3.26)$$

where S_t is the nominal exchange rate.

Firms choose hours, capital, investment, the utilization rate and prices to maximize present discounted value of cash-flows, adjusted for the intangible cost of changing prices, taking into account the capital law of motion (2.3.19), and demand both at home and abroad, $T_t^D(h)$. The latter is given by:

$$\begin{aligned} T_t^D(h) &= \int_0^n Q_t(h, x) dx + \int_{1-n}^1 M_t^*(h, x^*) dx^* \\ &= \left(\frac{P_t^Q(h)}{P_t^Q} \right)^{-\theta_t} Q_t(x) + \left(\frac{P_t^{M^*}(h)}{P_t^{M^*}} \right)^{-\theta_t^*} M_t^*(x). \end{aligned} \quad (2.3.27)$$

¹⁷Hence, we assume "local currency pricing" explored by Devereux and Engel (2000), Corsetti and Pesenti (2001) and others.

The first order condition for optimal price setting in the domestic market can be written:

$$\begin{aligned}
& Q_t - \theta_t Q_t + MC_t(h) \theta_t Q_t / P_t^Q \\
& - \phi^{PQ} \left[\frac{P_t^Q(h) / P_{t-1}^Q(h)}{P_{t-1}^Q / P_{t-2}^Q} - 1 \right] P_t^Q Q_t \frac{1 / P_{t-1}^Q(h)}{P_{t-1}^Q / P_{t-2}^Q} \\
& + E_t D_{t,t+1} \left\{ \begin{array}{l} \phi^{PQ} \left[\frac{P_{t+1}^Q(h) / P_t^Q(h)}{P_t^Q / P_{t-1}^Q} - 1 \right] \times \\ P_{t+1}^Q Q_{t+1} \left(\frac{1}{P_t^Q(h)} \right)^2 \frac{P_{t+1}^Q(h)}{P_t^Q / P_{t-1}^Q} \end{array} \right\} = 0,
\end{aligned} \tag{2.3.28}$$

where MC_t is the nominal marginal cost and $D_{t,t+1}$ denotes the stochastic discount factor, defined in (2.3.46).

The first-order condition for foreign price setting is given by:

$$\begin{aligned}
& S_t M_t^* - \theta_t^* S_t M_t^* + \theta_t^{*F} MC_t(h) M_t^* / P_t^{M^*} \\
& - \phi^{M^*} \left[\frac{P_t^{M^*}(h) / P_{t-1}^{M^*}(h)}{P_{t-1}^{M^*} / P_{t-2}^{M^*}} - 1 \right] P_t^{M^*} S_t M_t^* \left[\frac{1 / P_{t-1}^{M^*}(h)}{P_{t-1}^{M^*} / P_{t-2}^{M^*}} \right] \\
& + E_t D_{t,t+1} \left\{ \begin{array}{l} \phi^{M^*} \left[\frac{P_{t+1}^{M^*}(h) / P_t^{M^*}(h)}{P_t^{M^*} / P_{t-1}^{M^*}} - 1 \right] \times \\ P_{t+1}^{M^*} S_{t+1} M_{t+1}^* \left(\frac{1}{P_t^{M^*}(h)} \right)^2 \left(\frac{P_{t+1}^{M^*}(h)}{P_t^{M^*} / P_{t-1}^{M^*}} \right) \end{array} \right\} = 0.
\end{aligned} \tag{2.3.29}$$

Combining the first-order conditions for capital and investment we obtain:

$$\frac{1}{\kappa_t'(h)} = E_t D_{t,t+1} \frac{P_{t+1}(h)}{P_t(h)} \left[\begin{array}{l} \frac{R_{t+1}^K(h) u(h)_{t+1} - \gamma^u(h)}{P_{t+1}(h)} \\ + \frac{1}{\kappa_{t+1}'(h)} \left((1 - \delta) + \kappa_{t+1}(h) - \kappa_{t+1}'(h) \frac{I_{t+1}(h)}{K_t(h)} \right) \end{array} \right], \tag{2.3.30}$$

where

$$\kappa_t'(h) = 1 - \phi^{I1} \left(\frac{I_t(h)}{K_{t-1}(h)} - (\pi^z - 1 + \delta) Z_t^I \right) - \phi^{I2} \left(\frac{I_t(h)}{K_{t-1}(h)} - \frac{I_{t-1}}{K_{t-2}} \right), \tag{2.3.31}$$

and R_t^K is the real shadow rental price of effective capital, defined as:

$$R_t^K(h) \equiv \frac{\alpha^{\frac{1}{\xi}} MC_t(h)}{u_t(h)} \left(\frac{T_t(h)}{K_{t-1}(h)} \right)^{\frac{1}{\xi}}. \tag{2.3.32}$$

The first order condition for optimal labor input can be written as:

$$MC_t(h) = \frac{W_t}{(1 - \alpha)^{\frac{1}{\xi}}} \left(\frac{l_t(h)}{T_t(h)} \right)^{\frac{1}{\xi}} (Z_t z_t^L)^{\left(\frac{1}{\xi} - 1\right)}. \tag{2.3.33}$$

Finally, the first order condition for the capacity utilization can be written:

$$[\gamma_t^u(h)]' = \frac{R_t^K(h)}{P_t}, \quad (2.3.34)$$

where the marginal utilization cost is given by:¹⁸

$$[\gamma_t^u(h)]' = \phi^{u1} \phi^{u2} e^{\phi^{u2}(u_t(h)-1)}. \quad (2.3.35)$$

2.3.3 Households

There are two types of households in the home economy, 'spenders' (or liquidity constrained households) and 'savers'. The spenders, comprising a share equal to $slc \in [0, 1)$, simply consume their disposable income. We may think of this group as agents following a simple rule-of-thumb for their consumption decisions, but it also captures credit constraints in a simplified way. The remaining $(1 - slc)$ share of households, the savers, have access to capital markets and choose a state-contingent plan to maximize expected utility given a set of restrictions. Moreover, savers own all domestic firms and receive dividends from ownership of firms. Savers also pay a lump-sum tax to cover exogenous government spending.

Each household supplies a differentiated labor input to intermediate firms. Wages are set by savers under the assumption of monopolistic competition. Spenders simply take the (average) wage rate negotiated by savers as given and supply the resulting effective labor input demanded by intermediate firms.

Savers are indexed by $j \in [0, (1 - slc)]$. Preferences are additively separable in consumption and labor. Letting $U_t(j)$ denote the lifetime expected utility of home agent j , we have:

$$U_t(j) = E_t \sum_{i=0}^{\infty} \beta^i [z_{t+i}^U u(C_{t+i}^{sa}(j)) - v(l_{t+i}(j))], \quad (2.3.36)$$

where C^{sa} denotes consumption by savers and l is labor. Households are assumed to live infinitely, but are impatient; they discount future utility (that is, future levels of consumption and labor) by a discount factor $0 < \beta < 1$. We include a random taste shifter, z^U , to allow for shocks to preferences. The consumption shock evolves according to:

$$\ln\left(\frac{z_t^u}{z^u}\right) = \lambda^u \ln\left(\frac{z_{t-1}^u}{z^u}\right) + \varepsilon_t^u. \quad (2.3.37)$$

The current period utility functions for consumption and labor choices, $u(C_t^{sa}(j))$ and $v(l_t(j))$, are given by:

$$u(C_t^{sa}(j)) = (1 - b^c/\pi^z) \ln\left[\frac{(C_t^{sa}(j) - b^c C_{t-1}^{sa})}{1 - b^c/\pi^z}\right], \quad (2.3.38)$$

¹⁸Setting $u = 1$ in steady state introduces a restriction on one of the $\phi^{u'}$ s. In particular, we assume that:

$$\phi^{u1} = \frac{R^K}{\phi^{u2} P}$$

and

$$v(l_t(j)) = \frac{1}{1+\zeta} l_t(j)^{1+\zeta}. \quad (2.3.39)$$

We assume external habit persistence in consumption. The degree of habit in consumption is governed by the parameter b^c ($0 < b^c < 1$). Thus, what generates utility is not only how much household j consumes, but also how much it consumes relative to aggregate consumption in the previous period. This type of habit persistence is sometimes referred to as “keeping up with the Joneses”. The motivation for this kind of utility is primarily to generate some sluggishness in consumption in response to shocks, which is consistent with stylized facts.¹⁹ The degree of disutility of supplying labor is captured by the parameter $\zeta > 0$. The log-utility specification for consumption is chosen to ensure a balanced growth path.²⁰

Each household is the monopolistic supplier of a labor input j (i.e. possesses a particular variety of labor, which it offers to firms), and sets the nominal wage for input type j , taking into account the demand for labor from firms in the intermediate sector, given by (2.3.23). Following Kim (2000), there is sluggish wage adjustment due to resource costs that are measured in terms of the total wage bill. The adjustment costs, γ^W , are specified as:

$$\gamma_t^W(j) \equiv \frac{\phi^W}{2} \left[\frac{W_t(j)/W_{t-1}(j)}{W_{t-1}/W_{t-2}} - 1 \right]^2, \quad (2.3.40)$$

where W_t is the nominal wage rate. As can be seen from (2.3.40), costs are related to changes in wage inflation relative to the past observed rate for the whole economy. The parameter $\phi^W > 0$ determines how costly it is to change the wage inflation rate.

The individual flow budget constraint for agent j is:

$$\begin{aligned} P_t C_t^{sa}(j) + S_t B_{H,t}^*(j) + B_t(j) &\leq W_t(j) l_t(j) [1 - \gamma_t^W(j)] \\ &+ [1 - \gamma_{t-1}^{B^*}] (1 + r_{t-1}^*) S_t B_{H,t-1}^*(j) \\ + (1 + r_{t-1}) B_{t-1}(j) &+ \frac{1}{1 - slc} DIV_t(j) - \frac{1}{1 - slc} TAX_t(j), \end{aligned} \quad (2.3.41)$$

where $B_t(j)$ is household j 's end of period t stock of domestic bonds, $B_{H,t}^*(j)$ is end of period t portfolio of foreign bonds (held by domestic households). Furthermore, the domestic short-term nominal interest rate is denoted by r_t , and the nominal return on foreign bonds is r_t^* . Only foreign bonds are traded internationally, and they are in zero net supply worldwide, while the home bond is in zero net supply

¹⁹The specific functional form of the subutility function, $u(j)$, adapted here ensures that the habit parameter does not enter the steady state solution of the model.

²⁰This is equivalent to letting $\sigma \rightarrow 1$ in the more general specification

$$u_t(C_t^{sa}(j)) = \frac{(C_t^{sa}(j) - b^c C_{t-1}^{sa})^{1-\sigma}}{1-\sigma}$$

where σ is the inverse of the intertemporal elasticity of substitution.

at the domestic level. The variable DIV includes all profits and also household nominal adjustment costs, which are rebated in a lump-sum fashion. Finally, home agents pay lump-sum (non-distortionary) net taxes, TAX , denominated in home currency.²¹

A financial friction, γ^{B^*} , is introduced to guarantee that the net asset positions follow a stationary process.²² This cost depends on the average net foreign asset position (detrended) of the domestic economy relative to some desired net foreign asset position (which may deviate from zero). Specifically, we adopt the following functional form:

$$\gamma_t^{B^*} = \phi^{B1} \frac{\exp\left(\phi^{B2} \left((1 - slc) \frac{S_t B_t^{H^*}}{P_t Z_t}\right)\right) - 1}{\exp\left(\phi^{B2} \left((1 - slc) \frac{S_t B_t^{H^*}}{P_t Z_t}\right)\right) + 1} + z_t^B, \quad (2.3.42)$$

where $0 \leq \phi^{B1} \leq 1$, $\phi^{B2} > 0$ and $B_t^{H^*} \equiv \left(\frac{1}{(1 - slc)}\right) \int_0^{(1 - slc)} B_{H,t}^*(j) dj$ defines the home country's holdings of foreign bonds per saver. The variable z_t^B can be interpreted as a risk premium shock. When $B_{H,t}^* = 0$, $\gamma_t^{B^*} = 0$ (when, of course, $z_t^B = 0$), whereas deviating from the desired level of net foreign assets will imply a cost to households. This cost approaches $\pm\phi^{B1}$ as the net foreign asset position goes to $\pm\infty$. The parameter ϕ^{B2} controls the slope of the $\gamma_t^{B^*}$ function, and hence the speed of convergence to the steady state. Furthermore, since the financial cost depends on aggregate quantities only, agents take it as given when deciding on the optimal holdings of the foreign bond. The exogenous risk premium, z_t^B , is given by the following AR(1) process:

$$z_t^B = \lambda^B z_{t-1}^B + \varepsilon_t^B. \quad (2.3.43)$$

Households choose consumption, labor, bond holdings, and wages to maximize the discounted utility given by (2.3.36), taking into account the budget restriction (2.3.41) and the demand for labor (2.3.23).

The intertemporal optimality conditions are given by:

$$\frac{1}{1 + r_t} = E_t D_{t,t+1} \quad (2.3.44)$$

$$E_t \left(D_{t,t+1} \frac{S_{t+1}}{S_t} \right) = \frac{(1 + r_t) E_t D_{t,t+1}}{(1 + r_t^*) [1 - \gamma_t^{B^*}]}, \quad (2.3.45)$$

where the stochastic discount factor, $D_{t,t+1}$, is defined as:

$$D_{t,t+1} = \beta \frac{U'_{C_{t+1}}}{U'_{C_t}} \frac{P_t}{P_{t+1}} = \beta \frac{P_t}{P_{t+1}} \frac{Z_{t+1}^U C_t^{sa} - b^c C_{t-1}^{sa}}{Z_t^U C_{t+1}^{sa} - b^c C_t^{sa}}. \quad (2.3.46)$$

²¹Since it is assumed that intermediate firms are owned by savers, they all receive a share $\frac{1}{(1 - slc)}$ of per capita dividends. Furthermore, only savers pay tax.

²²See Schmitt-Grohe and Uribe (2003) for a discussion and for alternative ways to ensure stationarity.

Equation (2.3.44) is the consumption Euler equation for the savers. It states that along an optimal consumption path the marginal rate of substitution between consumption tomorrow and consumption today must equal the gross real interest rate. If this does not hold, utility could be increased by reallocating resources across time. Equation (2.3.45) is a version of the Uncovered Interest Parity (UIP). It summarizes the optimal holdings of domestic and international bonds. In equilibrium, it should not be possible to increase the portfolio return by changing the composition of domestic and foreign bonds.

The first-order condition for wage setting reads:

$$\frac{W_t^{sa}(j)}{P_t} = \psi_t MRS_t(j) \left[\begin{array}{c} (1 - \gamma_t^W(j)) \\ + \frac{\phi^W W_t(j)/W_{t-1}(j)}{W_{t-1}/W_{t-2}} \left(\frac{W_t(j)/W_{t-1}(j)}{W_{t-1}/W_{t-2}} - 1 \right) \\ - E_t \left\{ \frac{D_{t,t+1}(j) \pi_{t+1}^W(j) \times}{\frac{l_{t+1}^{sa}(j)}{l_t^{sa}(j)} \frac{\phi^W W_{t+1}(j)/W_t(j)}{W_t(j)/W_{t-1}(j)}} \left(\frac{W_{t+1}(j)/W_t(j)}{W_t(j)/W_{t-1}(j)} - 1 \right) \right\} \end{array} \right]^{-1}, \quad (2.3.47)$$

where MRS_t measures the savers' marginal rate of substitution of consumption for leisure:

$$MRS_t = -\frac{U'_{L_t}}{U'_{C_t}} = \frac{C_t^{sa} - b^c C_{t-1}^{sa}}{1 - b^c/\pi^z} (L_t^{sa})^\zeta. \quad (2.3.48)$$

When setting wages, households balance their disutility from working and their utility of consumption generated from their labor income. The optimal real wage is set as a markup over MRS . The markup depends on how much market power households have in the labor market, governed by the time-varying parameter ψ_t (the elasticity of substitution between differentiated labor types). Hence, the size of ψ_t could be interpreted as the bargaining power of the households (or labor unions) in the wage setting process. The total markup also depends on the costs of adjusting wages.

Spenders consume their disposable income. Moreover, we assume that their wage rate is equal to the savers' (average) wage and that they supply whatever is demanded of their type of labor. This implies that $W_t^{sp} = W_t^{sa} \equiv W_t$ and $L_t^{sp} = L_t^{sa} \equiv L_t$, and (in per spender terms):

$$P_t C_t^{sp} = W_t L_t, \quad (2.3.49)$$

where C_t^{sp} denotes the representative spender's period t consumption.

Moreover, total per capita consumption, C_t , is given by:

$$C_t = (slc) C_t^{sp} + (1 - slc) C_t^{sa}. \quad (2.3.50)$$

2.3.4 Government

The government purchases final goods financed through a lump-sum tax, TAX , and receives the return on an exogenously given fund invested in foreign assets, $OILR$,

(the oil fund):

$$P_t G_t = TAX_t + OILR, \quad (2.3.51)$$

where G_t is real per capita government spending.

The government also controls the short-term interest rate, r_t . As mentioned, different frameworks can be used to represent monetary policy, summarized as instrument rules or targeting rules. For most purposes, we use the following simple forward-looking instrument rule:

$$(1 + r_t)^4 = \omega_r (1 + r_{t-1})^4 + (1 - \omega_r) \left[(1 + r)^4 + \omega_1 \left(\frac{P_{t+4}}{P_t} - \pi^{tar} \right) \right] + z_t^R, \quad (2.3.52)$$

where $\omega_r \in [0, 1)$ determines the degree of interest rate smoothing, r is the steady state nominal interest rate²³ and $\omega_1 > 0$ and $\omega_2 > 0$ denotes the interest rate response to inflation (from the inflation target, π^{tar}) and the output gap respectively. z_t^R is a time-varying shock to monetary policy. We assume that this shock is white noise, that is:

$$z_t^R = \varepsilon_t^R.$$

2.3.5 Market clearing

The model is closed by a set of market-clearing conditions, ensuring that demand equals supply. Supply of intermediates must equal demand. Furthermore, the supply of final goods must equal the total demand for consumption, investment and government spending:

$$\int_0^n A_t(x) dx = \int_0^n C_t(x) dx + \int_0^n I_t(x) dx + nIOIL_t + nG_t + \int_0^n \gamma_t^u(u_t(h)) K_{t-1}(h) dh. \quad (2.3.53)$$

The intermediate good is used both at home and exported, so after correcting for the real cost of varying the utilization rate, we have that:

$$T_t(h) - \gamma_t^u(u_t(h)) K_{t-1}(h) = \int_0^n Q_t(x, h) dx + \int_n^1 M_t^*(x^*, h) dx^*. \quad (2.3.54)$$

Domestic bonds are assumed to be in zero net supply at the domestic level:

$$\int_0^{1-slc} B_t(j) dj = 0. \quad (2.3.55)$$

²³The nominal steady state interest rate can be found from the consumption Euler equation in steady state, as:

$$r = \frac{\pi^z \pi^{tar}}{\beta} - 1$$

Given that we have a similar set of equations for the foreign economy, we need one more condition to close the two-country model, namely that the net holdings of foreign bonds equal zero:

$$\int_0^{(1-s)c} B_t^{*H} dj + \int_{1-n}^1 B_t^{*F} dj^* + OILR = 0. \quad (2.3.56)$$

2.4 The small open economy: A stationary model

In this section, we present the stationary model for a *small open economy* in *symmetric equilibrium*. Due to the permanent (unit root) productivity shock Z_t , the economy will evolve along a stochastic growth path. In order to render the model stationary, we therefore need to detrend all relevant variables with Z_t .²⁴ Furthermore, since we assume a positive steady-state inflation rate, all nominal measures will be converted to real terms by dividing through by P_t (domestic variables) and P_t^* (foreign variables), respectively.

The small open economy model is a special case of the two-country model developed above, obtained by letting the relative size of the home economy, n , approach zero. To this end, we shall make use of a re-parameterization of the home bias parameter at home and abroad, respectively. We assume that the home bias parameter is determined by both size and openness, such that:

$$1 - \eta = (1 - n)(1 - \nu), \quad (2.4.1)$$

and

$$1 - \eta^* = n(1 - \nu^*), \quad (2.4.2)$$

where $1 - \nu$ ($0 \leq \nu \leq 1$) and $1 - \nu^*$ ($0 \leq \nu^* \leq 1$) are measures of openness in home and foreign, respectively. The interpretation is that home bias increases with size, but decreases with openness, see Sutherland (2005). From (2.4.1) and (2.4.2), it is clear that letting $n \rightarrow 0$, leads to the following:

$$\eta = \nu, \quad (2.4.3)$$

and

$$\eta^* = 1. \quad (2.4.4)$$

In section 2.3, the model variables were stated in level terms. Given the fact that we assume a positive steady state growth rate and inflation rate, these variables will not be stationary. Hence, in order to render the model stationary, all nominal variables must be deflated by a numeraire price, and real variables evolving along the balanced growth path must be detrended by the stochastic productivity shock.

²⁴In addition, the variables are to be interpreted in per capita terms.

2.4.1 Final goods

Since all firms are identical, we can drop the index, x . Dividing through by Z_t and letting $n \rightarrow 0$, the supply of final goods, given by (2.3.1), can be written:

$$a_t = \left[\nu^{\frac{1}{\mu}} q_t^{\frac{\mu-1}{\mu}} + (1-\nu)^{\frac{1}{\mu}} m_t^{\frac{\mu-1}{\mu}} \right]^{\frac{\mu}{\mu-1}}, \quad (2.4.5)$$

where $a_t = \frac{A_t}{Z_t}$, $q_t = \frac{Q_t}{Z_t}$, $m_t = \frac{M_t}{Z_t}$.

The demand functions for domestic and imported goods, given in (2.3.10) and (2.3.11), are accordingly:

$$q_t = \nu \left(p_t^Q \right)^{-\mu} a_t, \quad (2.4.6)$$

$$m_t = (1-\nu) \left(p_t^M \right)^{-\mu} a_t, \quad (2.4.7)$$

where $p_t^Q = \frac{P_t^Q}{P_t}$ and $p_t^M = \frac{P_t^M}{P_t}$.

2.4.2 Intermediate goods

All intermediate firms are assumed to be identical. Hence, in symmetric equilibrium, we can disregard the index, h . The production function for the intermediate good is given by (2.3.13). Since hours is assumed to be a stationary variable, detrending yields:

$$t_t = \left[(1-\alpha)^{\frac{1}{\xi}} (z_t^L l_t)^{1-\frac{1}{\xi}} + \alpha^{\frac{1}{\xi}} \bar{k}_t^{1-\frac{1}{\xi}} \right]^{\frac{\xi}{\xi-1}}, \quad (2.4.8)$$

where $t_t = \frac{T_t}{Z_t}$ and $\bar{k}_t = \frac{\bar{K}_t}{Z_t}$. Furthermore, effective capital is now:

$$\bar{k}_t = \frac{u_t k_{t-1}}{\pi_t^z},$$

where $k_t = \frac{K_t}{Z_t}$ and $\pi_t^z = \frac{Z_t}{Z_{t-1}}$ is the one period growth in productivity.

Detrending the real shadow price of capital in (2.3.32) we get:

$$r_t^K \equiv \alpha^{\frac{1}{\xi}} m c_t \left(\frac{t_t}{\bar{k}_{t-1}} \right)^{\frac{1}{\xi}}. \quad (2.4.9)$$

The first order condition for hours can now be written:

$$m c_t = \frac{w_t}{(1-\alpha)^{\frac{1}{\xi}}} \left(\frac{l_t}{t_t} \right)^{\frac{1}{\xi}}, \quad (2.4.10)$$

where $m c_t = \frac{M C_t}{P_t}$ and $w_t = \frac{W_t}{Z_t P_t}$.

The stationary version of the capital accumulation rate, given in (2.3.19), can be expressed as:

$$\pi_t^z k_t = (1 - \delta) k_{t-1} + \Psi_t k_{t-1}. \quad (2.4.11)$$

The investment euler equation, given by (2.3.30), now reads:

$$\frac{1}{\kappa_t} = E_t d_{t,t+1} \pi_{t+1} \left\{ \begin{array}{l} r_{t+1}^K u_{t+1} - \phi^{u1} \left(e^{\phi^{u2}(u_{t+1}-1)} - 1 \right) \\ + \frac{1}{\kappa'_{t+1}} \left[(1 - \delta) + \kappa_{t+1} - \kappa'_{t+1} \frac{\pi_{t+1}^z i_{t+1}}{k_t} \right] \end{array} \right\}, \quad (2.4.12)$$

where $i_t = \frac{I_t}{Z_t}$ and:

$$\kappa'_t = 1 - \phi^{I1} \left(\frac{i_t \pi_t^z}{k_{t-1}} - (\pi^z - 1 + \delta) Z_t^I \right) - \phi^{I2} \left(\frac{i_t \pi_t^z}{k_{t-1}} - \frac{i_{t-1} \pi_{t-1}^z}{k_{t-2}} \right). \quad (2.4.13)$$

The optimal choice of the utilization rate satisfies:

$$\phi^{cu2} \phi^{cu1} e^{\phi^{cu2}(u_t-1)} = r_t^K. \quad (2.4.14)$$

In a stationary symmetric equilibrium, the pricing equations (2.3.28) and (2.3.29) reduce to:

$$p_t^Q = \theta_t m c_t \left[\begin{array}{l} (\theta_t - 1) + \phi^{PQ} \left[\frac{\pi_t^Q}{\pi_{t-1}^Q} - 1 \right] \frac{\pi_t^Q}{\pi_{t-1}^Q} \\ - \phi^{PQ} E_t \left\{ d_{t,t+1} \frac{\pi_{t+1}^z q_{t+1}}{q_t} \pi_{t+1}^Q \left[\frac{\pi_{t+1}^Q}{\pi_t^Q} - 1 \right] \frac{\pi_{t+1}^Q}{\pi_t^Q} \right\} \end{array} \right]^{-1}, \quad (2.4.15)$$

$$p_t^{M*} = \theta_t^* \frac{m c_t}{s_t} \left[\begin{array}{l} \theta_t^* - 1 + \phi^{M*} \left(\frac{\pi_t^{M*}}{\pi_{t-1}^{M*}} - 1 \right) \frac{\pi_t^{M*}}{\pi_{t-1}^{M*}} \\ - \phi^{M*} E_t d_{t,t+1} \left\{ \begin{array}{l} \left(\frac{\pi_{t+1}^{M*}}{\pi_t^{M*}} - 1 \right) \times \\ \pi_{t+1}^{M*} \left(\frac{\pi_{t+1}^{M*}}{\pi_t^{M*}} \right) \frac{s_{t+1} m_{t+1}^* \pi_{t+1}^z}{s_t m_t^* \pi_{t+1}^z} \end{array} \right\} \end{array} \right]^{-1}, \quad (2.4.16)$$

where $d_{t,t+1} = \frac{D_{t,t+1}}{Z_{t+1}}$, $m_t^* = \frac{M_t^*}{Z_t}$ and $p_t^{M*} = \frac{P_t^{M*}}{P_t^*}$ is the real price of exports, denominated in the foreign final good. The real exchange rate is defined as: $s_t = \frac{S_t P_t^*}{P_t}$. Furthermore, $\pi_t^Q = \frac{P_t^Q}{P_{t-1}^Q}$ and $\pi_t^{M*} = \frac{P_t^{M*}}{P_{t-1}^{M*}}$ denote the one period gross change in the domestic good price and imported good price, respectively. Using the definitions of the relative prices, it follows that:

$$\pi_t^Q = \frac{p_t^Q}{p_{t-1}^Q} \pi_t, \quad (2.4.17)$$

and:

$$\pi_t^{M*} = \frac{p_{t-1}^{M*}}{p_{t-1}^{M*}} \pi_t^*. \quad (2.4.18)$$

2.4.3 Households

All savers are assumed to be identical. This implies that in a symmetric equilibrium, we can drop the index j . The stationary version of the euler consumption equation given by (2.3.44), is:

$$\frac{1}{1+r_t} = E_t d_{t,t+1}, \quad (2.4.19)$$

where

$$d_{t,t+1} = \frac{\beta}{\pi_{t+1}} \frac{z_{t+1}^U}{z_t^U} \frac{1}{\pi_{t+1}^z} \frac{c_t^{sa} - b^c \frac{c_{t-1}^{sa}}{\pi_t^z}}{c_{t+1}^{sa} - b^c \frac{c_t^{sa}}{\pi_{t+1}^z}}, \quad (2.4.20)$$

and $c_t^{sa} = \frac{C_t^{sa}}{Z_t}$.

Rearranging (2.3.45) gives the following stationary expression for the UIP equation.

$$E_t \left(d_{t,t+1} \frac{s_{t+1} \pi_{t+1}}{s_t \pi_{t+1}^*} \right) = \frac{(1+r_t) E_t d_{t,t+1}}{(1+r_t^*) [1 - \gamma_t^{B^*}]}. \quad (2.4.21)$$

Furthermore, we have that (2.3.43) can be written as:

$$\gamma_t^{B^*} = \phi^{B1} \frac{\exp(\phi^{B2} ((1-slc) s_t b_{H,t}^*)) - 1}{\exp(\phi^{B2} ((1-slc) s_t b b_{H,t}^*)) + 1} + z_t^B, \quad (2.4.22)$$

where $b_{H,t}^* = \frac{B_{H,t}^*}{P_t^* Z_t}$.

Detrending the wage equation, given by (2.3.47), yields:

$$w_t = \psi_t m r s_t^{sa} \left[\begin{array}{c} (\psi_t - 1) (1 - \gamma_t^W) + \frac{\phi^W \pi_t^W}{\pi_{t-1}^W} \left(\frac{\pi_t^W}{\pi_{t-1}^W} - 1 \right) \\ - E_t d_{t,t+1} \pi_{t+1}^W \frac{l_{t+1}}{l_t} \frac{\phi^W \pi_{t+1}^W}{\pi_t^W} \left(\frac{\pi_{t+1}^W}{\pi_t^W} - 1 \right) \end{array} \right]^{-1}, \quad (2.4.23)$$

where $\pi_t^W = \frac{W_t}{W_{t-1}}$. Combined with the definition of the real wage, this implies that:

$$\pi_t^W = \frac{w_t}{w_{t-1}} \pi_t \pi_t^z. \quad (2.4.24)$$

In stationary form, the marginal rate of substitution reads:

$$m r s_t^{sa} = \frac{c_t^{sa} - b^c \frac{c_{t-1}^{sa}}{\pi_t^z}}{1 - b^c} (l_t)^\zeta. \quad (2.4.25)$$

Starting with the savers' budget constraint in symmetric equilibrium, we can derive an expression for the current account:

$$(1-slc)s_t b_{H,t}^* = (1-slc)(1-r_{t-1}^*) \frac{s_t b_{H,t-1}^*}{\pi_t^z \pi_t^*} + \frac{1-n}{n} s_t p_t^{M^*} m_t^* - p_t^M m_t + oilr. \quad (2.4.26)$$

The correction $\frac{1-n}{n}$ ensures consistency with our convention that foreign variables are measured in terms of foreign per capita. Using the expression for m_t^* , which is the foreign counterpart of (2.4.7), and letting $n \rightarrow 0$, we obtain the following current account equation for the small open economy:²⁵

$$(1-slc)s_t b_{H,t}^* = (1-slc)(1-r_{t-1}^*) \frac{s_t b_{H,t-1}^*}{\pi_t^z \pi_t^*} + s_t(1-\nu^*) (p_t^{M^*})^{1-\theta^*} y_t^* - p_t^M m_t + oilr. \quad (2.4.27)$$

Since all spenders are identical, and they are assumed to have the same wage and supply the same number of hours as savers, we have that

$$c_t^{sp} = w_t l_t, \quad (2.4.28)$$

where $c_t^{sp} = \frac{C_t^{sp}}{Z_t}$.

Detrended aggregate consumption can now be expressed as:

$$c_t = (slc)c_t^{sp} + (1-slc)c_t^{sa}, \quad (2.4.29)$$

where $c_t = \frac{C_t}{Z_t}$.

2.4.4 Market clearing

The market clearing conditions in a stationary symmetric equilibrium can be written as follows:

$$a_t = c_t + (1-slc)i_t + g_t, \quad (2.4.30)$$

$$t_t - \gamma_t^u(u_t) \frac{k_{t-1}}{\pi_t^z} = q_t + (1-\nu^*) (p_t^{M^*})^{-\theta^*} y_t^*. \quad (2.4.31)$$

GDP, denoted by y , can be defined as follows:

$$y_t = c_t + i_t + g_t + ioil_t + s_t(1-\nu^*) (p_t^{M^*})^{1-\theta^*} y_t^* - p_t^M m_t.$$

²⁵Foreign imports (home exports) in per capita terms is given by:

$$\begin{aligned} m_t^* &= (1-\eta^*) p_t^{M^*} a_t^* \\ &= n(1-\nu^*) p_t^{M^*} a_t^* \end{aligned}$$

From the point of view of the foreign economy, imports per capita will equal zero when the relative size of the small economy approaches zero. This implies that the final price is equal to the intermediate price and that total production equals aggregate demand.

2.4.5 An exogenous foreign block

When $n \rightarrow 0$, foreign variables will be independent of domestic shocks. Hence there will be no feed-back from the domestic economy to the foreign economy. This means that the foreign economy can be treated as an exogenous block in the full model. To see this, we start by writing out the equilibrium condition for the foreign economy (the foreign counterpart of (2.4.31)) :

$$t_t^* - \gamma_t^{u^*}(u_t^*) \frac{k_{t-1}^*}{\pi_t^z} = q_t^* + \frac{n}{1-n} m_t. \quad (2.4.32)$$

Letting $n \rightarrow 0$, this reduces to:

$$t_t^* - \gamma_t^{u^*}(u_t^*) \frac{k_{t-1}^*}{\pi_t^z} = q_t^*. \quad (2.4.33)$$

Furthermore, we have that:

$$m_t^* = (1 - \eta^*) (p_t^{M^*})^{-\mu^*} a_t^* \quad (2.4.34)$$

$$\begin{aligned} &= n (1 - \nu^*) (p_t^{M^*})^{-\mu^*} a_t^* \\ &= 0, \end{aligned} \quad (2.4.35)$$

and the weight of the foreign import price in the foreign final good price will approach zero, implying that $p_t^{Q^*} = 1$. Hence, foreign production, relative prices and, hence, interest rates are independent of home variables.

In the current version of NEMO, we have simplified the specification of the foreign economy somewhat. The main departure from the set-up described above, is that we abstract from capital in the production function of the foreign economy. Furthermore, all foreign consumers are forward looking, i.e. there are no spenders in the foreign economy. The full representation of the current foreign block in NEMO is given in A.2.2.

3 Parameterization

The current parameterization of NEMO is based on both calibration and estimation. As a first step, all parameters that affect the steady state of the model were calibrated. Hence, these parameters were treated as given in the estimation exercise. Information from different sources and various empirical methods were used for the calibration, including stylized facts for the business cycle and great ratios, estimated single equation models, identified VAR models and other Norwegian macro models. In addition, we have compared our parameterization with models in the literature and other central bank models which have similar characteristics to NEMO. Given the set of calibrated parameters, the remaining parameters were estimated. This estimation exercise should be seen as a first step towards a full probabilistic assessment of the model. A more elaborate estimation exercise, including estimation of steady state parameters, is under way and will be documented in Brubakk, Maih, Wolden Bache and Østnor (2007).

Calibration can be a very useful step to learn about the dynamic properties of the model and to gain important qualitative insights into the model economy. It can also be a good way of ensuring concordance with the data along some dimensions of particular interest. However, in order to build confidence in the simulation output, with respect to both policy experiments and forecasting, it is desirable that most parameters are estimated using a formal approach. A common approach to estimate DSGE models is now to use Bayesian Maximum Likelihood.²⁶ This requires that we specify priors for the distribution of the parameters. Hence, the calibration exercise can be seen as a way of establishing a sensible set of initial priors before estimating the model as a system.

One obvious advantage of a more formal approach is that it provides an estimate of the uncertainty attached to the chosen parameters. This is very useful, since risk assessment is an important aspect of the projection exercise. In addition, a more formal approach enables us to derive some measure of how well the model fits the data, and allow for model comparison in a systematic way.

3.1 Steady state parameters

In this section, we document the calibration of parameters that affect the steady state of the model. We start out by setting parameters that will determine inflation and interest rates in steady state. The inflation targets in Norway and the foreign economy are set to 2.5 and 2.0 per cent, respectively, on an annual basis. Based on current estimates,²⁷ we assume a long-run annual real interest rate for the Norwegian economy of 2.5 per cent. The same level for the long-run annual real interest rate is assumed for the foreign economy. To match the average per capita growth rate for the Norwegian economy for the period 1990-2005, π^z , is set to 2.25 per cent on an annual basis. In steady state, the quarterly real interest rate, r , for both the home

²⁶See for example Smets and Wouters (2003) and Adolfson, Laséen, Lindé and Villani (2005).

²⁷See Bernhardsen (2005) and Inflation Report 2/06.

and foreign economy is given by $1 + r = \pi^z/\beta$. Hence, our priors on the steady state values of the real interest rate and the long term growth rate is consistent with a discount factor, β , of $1.005^{-1/4}$. The National Account figures for the quarterly depreciation rate of capital has been stable at 1.8 per cent for the last five years. The depreciation rate, δ , is set accordingly.

Figure 2 illustrates the main demand components of the National Accounts relative to GDP for the period 1990-2005. With the exception of consumption and investment, we have used rough estimates of the mean ratio for the whole period as a guidance for the calibration. Both consumption (including housing) and investment exhibit an increasing trend relative to gdp over this period. However, the low ratios at the beginning of the 90's is related to the a major crisis in the banking sector. Hence, we have used the period after the banking crisis as a guidance to the steady state consumption to GDP ratio and investement to GDP ratio, respectively. For investments, this ratio has been fairly stable at around 8.5 per cent from 1995 and onwards, whereas the average consumption to gdp ratio over the same period is roughly 61 per cent

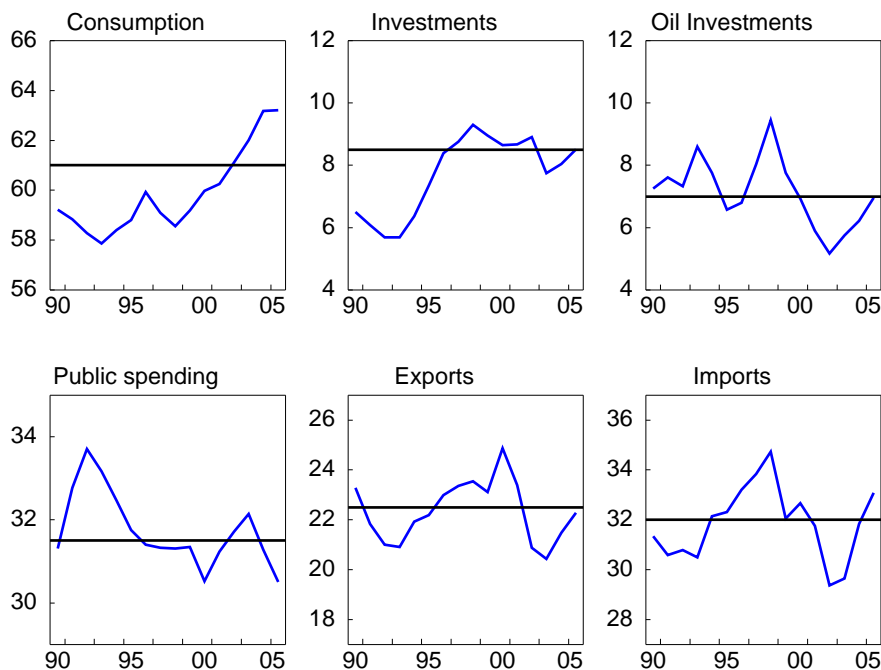

Figure 2: Demand components in per cent of GDP Mainland Norway. Nominal figures from 1980 to 2005. Source: Statistics Norway

Estimates of the elasticity of substitution between domestically-produced and imported goods in final goods production, μ , typically found in models for the US, the euro area and the UK, range from 1 to 5. The effect of an elasticity of substitution between domestic and imported goods close to one is that the import share of GDP hardly moves when relative prices between domestic and imported goods changes.

A low elasticity in Norway compared to many other countries is appropriate due to a more specialized production structure. For most imported consumption goods, for example, there are no Norwegian-produced substitutes. In Naug (2002, chapter 2), the elasticity of substitution between domestically-produced and imported goods in final goods production in Norway is estimated to be 1.5. However, this study is based on data for the industrial sector where one would expect the elasticity of substitution to be somewhat higher than for the economy-wide average. Hence, the elasticity, μ , is set to 1.1. The corresponding elasticity for trading partners, μ^* , is also set to 1.1.

In order to reproduce an historical average import share of 0.32 in steady state, the home bias parameter,²⁸ ν , is set to 0.686. Given μ , this yields a steady state weight on imported goods in the final goods deflator close to 0.3, which is in line with the corresponding share found in the official consumer price index.

The wage income share ranges between 65 and 75 per cent depending on how it is measured. In order to match the the wage income share and the investment to GDP ratio in the data, the capital share in production, α , is set to 0.33, and the elasticity of substitution between capital and labour, ξ , is set to 0.7.

The degree of disutility of supplying an additional unit of labor, or the inverse of the Frisch elasticity of labor supply, is captured by ζ . The higher is ζ , the higher is the compensation demanded by workers to supply an additional unit of labor. Stylized facts indicate that a pro-cyclical real wage is an inherent feature of the Norwegian economy, see Husebø and Wilhelmsen (2005). Real wages seem to be more pro-cyclical in Norway than in both the US and the euro area. Hence, we set ζ to 3, which is at the high end of what most other macro models for the US economy and the euro area use,²⁹ and significantly higher than what is typically used in the real business cycle literature.

The elasticity of substitution between differentiated intermediate domestic goods can be used as a proxy for the degree of competition in the markets in question. The higher the elasticity, the closer the market is to free competition, with a correspondingly lower markup. In models for the US, the euro area and the UK estimates of this elasticity typically range from 3 to 11. In NEMO, θ is set to 6, implying a price markup over marginal cost in steady state for domestically produced goods of 1.2 (i.e. a 20 per cent markup). This is in line with estimates for the average markup in Norway found for manufacturing sectors in Martins, Scarpetta and Pilat (1996), over the period 1980-92. The corresponding elasticity for imported goods, θ^* , is also set to 6.

The elasticity of substitution for labor services, ψ , can be interpreted as the degree of market power of the workers (or unions) in the wage setting process, and reflects the deviation from free competition in the labor market. The lower is ψ ,

²⁸This parameter represents the share of domestic intermediates in the final goods aggregate that would prevail in the hypothetical case where the prices on domestic and imported goods were equal.

²⁹For the US economy, estimates typically ranges between 2.5 and 3. For the euro area, estimates are typically around 2.

Parameter	Value	Description
β	0.999	Discount rate (quarterly)
π^z	1.005	Steady state growth rate of unit root technology shock (quarterly)
π^{tar}	0.625	Inflation target (quarterly)
α	0.33	Capital share in intermediate goods production
δ	0.018	Depreciation rate on capital (quarterly)
ζ	3	Inverse of Frisch elasticity of labor supply
μ	1.1	Elast. of subst. between domestic and imported goods
μ^*	1.1	Elast. of subst. between domestic and imported goods, foreign
ν	0.686	Degree of home bias
θ	6	Elast. of subst. between domestic intermediate goods
θ^*	6	Elast. of subst. between imported intermediate goods
ψ	5.5	Elast. of subst. between differentiated labor services
slc	0	Share of spenders/liquidity constrained consumers

Table 1: Parameters that affect the steady state

the more market power the workers have in determining wages (i.e. the higher is the wage markup). Estimates for the US economy for this parameter range from 4 to 21. Estimates for the euro area are typically in the range from 2 to 4, i.e. there is a broad consensus that this number is higher in the US than in the euro area. Following Gali (1996), the degree of market power can be seen as a measure of inefficiencies in the labor market, and thereby as a measure of equilibrium, or structural, unemployment. Interpreted this way, the estimates for Norway should probably be closer to the US estimates than to the estimates for the euro area, given the higher level of structural unemployment in (continental) Europe. In the model this elasticity is set to 5.5, similar to that in the Bank of England Quarterly Model (BEQM). This seems reasonable, given the fairly similar workings of the labor market and the similar levels of (structural) unemployment in Norway and the UK.

In the current version of the calibration, the share of the spenders, slc , is set to zero.

3.2 Dynamic parameters

In this section we describe the estimation of parameters that only affect the dynamic properties of the model. The dynamic parameters were estimated conditional on the calibrated steady state parameters, using a Bayesian approach.

Based on prior distributions for the parameters and a likelihood function for the data, a posterior distribution for the parameters is derived, conditional on the observed data. The point of departure is the following statement, derived from Bayes law:

$$p(\eta|y) \propto \ell(y|\eta)p(\eta) \quad (3.2.1)$$

which says that the distribution of the parameters conditional on the data, named the posterior distribution $p(\eta|y)$, is proportional to the likelihood function, $\ell(y|\eta)$, times the prior distribution of the parameters, $p(\eta)$. In some sense, the posterior distribution of the parameters is an optimal weighting of our prior beliefs and what the data tell us. Given the posterior distribution, different moments of interest, such as the mean and variance, can be calculated.

Based on the solution to the linearised version of the model, and a set of observational equations linking the model variables to the observables, the Kalman filter is used to derive the likelihood function. Combined with the prior distributions, this yields an expression for the posterior distribution of the structural parameters. The posterior distribution is estimated in two steps; in the first step, the starting value for the Metropolis-Hastings algorithm is found by maximizing the posterior. Second, the algorithm is run using the Normal distribution as a proposal distribution, with moments based on the results from the first step. For the results presented in this paper 100.000 draws were made.

3.2.1 Data, variables, priors and identification

We have used quarterly data for the period 1990:1-2004:4. The first three years of data were used as a burn-in sample to initialise the unobserved shocks. Data were primarily taken from Statistics Norway³⁰ and OECD. The following variables were used: GDP, consumption, investment, public expenditures, exports, imports, hours worked, nominal wage growth, imported CPI inflation, domestic CPI inflation, the real exchange rate, and the nominal interest rate. For the foreign economy we used data on GDP, inflation, the nominal interest rate and a proxy for foreign real marginal cost.³¹ The foreign economy is defined as a trade weighted average of Norway's main trading partners. Representing monetary policy by a constant reaction function for the whole sample is not without problems. In order to make the reaction function as flexible as possible, we used a more general specification than the one described in 2.3.52:

$$r_t = \lambda_r r_{t-1} + (1 - \lambda_r) \left[\begin{array}{c} r + \omega^\pi \widehat{\pi}_{t-1} + \omega^y \widehat{gpd}_{t-1} + \omega^s \widehat{s}_{t-1} \\ + \omega^{\Delta\pi} (\widehat{\pi}_{t-1} - \widehat{\pi}_{t-1}) + \omega^{\Delta y} (\widehat{gpd}_{t-1} - \widehat{gpd}_{t-2}) \end{array} \right] + \varepsilon_t^r \quad (3.2.2)$$

The model assumes that GDP, consumption, investment, imports and exports grow at a constant rate in steady state. In order to render the data stationary, we used the first differences in line with Adolfson *et.al.* (2005a) and Del Negro *et al.* (2005). This approach was also used for hours per capita. For the trading partner

³⁰The national accounts data are for mainland Norway, i.e. excluding the direct effect of oil production.

³¹We used an indicator of imported price impulses denominated in foreign currency divided by aggregated foreign prices, see Røstøen (2004)

variables we used the HP-filter to detrend GDP and first differences for the proxy for foreign real marginal cost. The vector of the 15 observed variables which were used in the observation equations is given by:

$$\left[\begin{array}{c} \Delta \ln Y, \Delta \ln C, \Delta \ln G, \Delta \ln I, \Delta \ln EX, \Delta \ln IM, \Delta \ln l, \\ s, \pi^Q, \pi^M, r, \bar{y}^*, \pi^*, r^*, \Delta \ln mc^* \end{array} \right]$$

where a bar indicates that the series is HP-filtered. The inflation series used refers to quarterly inflation, and are adjusted for taxes and energy. All variables are demeaned, i.e. they have zero mean over the sample. Norwegian National Accounts data are highly volatile, partly reflecting the fact that Norway is a small economy. However, this is also partly due to measurement problems. Thus, we have removed both the seasonal and irregular components of the data using the X12 ARIMA filter.³²

In NEMO, all real variables are measured in units of the final good, which we have proxied by the consumer price index. To be consistent with the model, the final good price should be used as numeraire when deflating nominal variables. In order to make the National Accounts data compatible with the model definition, all nominal National Accounts data are divided by the consumer price index.

The estimated model has fourteen structural shocks, of which four originate from the foreign sector. In addition, we included two observational shocks (or measurement errors), on GDP and imports. Given that Norway is a small economy with little impact on the rest of the world, we follow the approach of Adolfson *et.al.* (2005a), where the foreign economy is represented by a VAR and estimated separately. In addition, the public spending shock, which is observable over history, was also estimated in advance.

Estimating large simultaneous systems may involve identification problems. Identification has to do with the ability to draw inference about the parameters of a theoretical structure from an observed sample. The basic intuition is that for a model to be identified, the objective function used in the estimation of parameters must have a unique maximum. It can be difficult to directly detect identification problems in large DSGE models. But in a Bayesian framework, a direct comparison of priors and posteriors can often provide valuable insights about the extent to which data provide information about the parameters of interest.

Some of the parameters turned out to be difficult to identify, like for example one of the parameters related to investment costs, ϕ^{I1} . A potential way of overcoming this problem would be to include the capital stock in the information set. Furthermore, it is not possible to identify both intermediation cost parameters ϕ^{B1} and ϕ^{B2} , using a first order approximation of the model. For those parameters that

³²The seasonally adjusted data (not adjusted for irregular components) Norway is much more volatile than similar data for UK, Sweden and the US. Having to remove also the irregular part is not without its challenges, though. While hours is by far the most volatile series when not adjusting for the irregular components, they become much smoother than for instance GDP when we adjust for them.

were not estimated, we used the calibrated parameters. This can be thought of as imposing strict priors on the parameters.

The prior means for the parameters that were estimated, were taken from the calibrated version of NEMO. The Beta distribution was employed for parameters assumed to be between zero and one. The Inverse Gamma distribution was used for parameters assumed to be positive. We used the Normal distribution for the rest of the parameters. For the persistence parameters in the shock processes, we used a prior with mean of 0.75 and standard deviation of 0.1. Priors on the adjustment costs on wages, domestic prices, import prices and export prices were guided by:

- the fairly slow and muted responses of prices and wages we tend to see in VAR and other econometric analyses,
- stylized facts that indicate that domestic price inflation tends to lag the overall business cycle by some 5 quarters, and
- indications that real wages react pro-cyclically in response to, for instance, a monetary policy shock.

3.2.2 Estimation results

The estimation results of the posterior distribution, along with the prior assumptions can be found in the appendix, see tables 5, 6 and 7. Figures 3, 4, 5 and 6 (in the appendix) report the posterior distribution along with the prior. With the exception of one borderline case (the standard deviation of the unit root technology shock), the parameters estimated seem to be well identified, as the posterior distribution either has moved away from, or is sharper than, the prior distribution.

The empirical content of the estimated model can be assessed along several dimensions. The model fit can be gauged by comparing actual and filtered estimates of the same variables, see figures 7 and 8. The model does a very good job in tracking domestic inflation, imported inflation, wage inflation, the interest rate, consumption, investment and the real exchange rate. However, the model does not explain the observed growth in hours, imports and exports and, hence, GDP equally well. The model is unable to explain the volatility of the trade series. This also impacts the fit of GDP, although the measurement errors included on GDP and imports explain some of the mismatch between the actual and filtered series. The bad fit of hours might be due to measurement problems of hours (hours are not very well measured in the National accounts), but is also due to correlated labour utilisation shocks (the innovations), see figures 9 and 10 which show the innovations to the shock processes.

Another way to look at the empirical fit of the model is to assess how well the model does in replicating the volatility shown in the data. The theoretical moments seems fairly consistent with the empirical counterpart, see table 8.

A third way to evaluate the model is to look at the estimated processes for the shocks (the smoothed shocks, not their innovations), found in figure 11. The estimated processes seem fairly consistent with prior beliefs. The recovery in activity

from 1993-1994 is ascribed to positive technology shocks together with a normalisation of interest rates.³³ The sharp appreciation of the real exchange rate in 2002 and 2003 translates into a risk premium shock. The downturn in the economy in the same period seems to be mainly explained by this risk premium shock, but also negative technology shocks, a negative investment shock and a downturn internationally contributed.

A fourth way of assessing the empirical performance of the model is to compare impulse responses to those coming from estimated identified VARs. Compared to the responses of a monetary policy shock in an estimated identified VAR on Norwegian data, see Bjørnland (2005), the estimated version of NEMO is by and large within the (two standard deviations) confidence bands of the identified VAR for the nominal interest rate, GDP, domestic inflation and the real exchange rate, see figure 12. The dynamic profile of the impulse responses are very similar for inflation and output. The identified VAR gives some support to the UIP condition in that the exchange rate jumps on impact, but NEMO is, however, not able to match the persistence found in the identified VAR. This is in line with the results reported by Chari et al. (2002). They argue that sticky price models are able to generate the volatility of exchange rates observed in the data, but that they cannot match the persistence. Obviously, the high persistence in the real exchange rate found in the identified VAR compared to NEMO may, in itself, explain the somewhat more muted output response in NEMO. It must also be noted that NEMO and the VAR are not directly comparable due to differences in the recursive structure in the two models. In the VAR, the monetary policy shock is identified by the restriction that output and inflation do not respond contemporaneously to the monetary policy shock, whereas the exchange rate do (taking into account the simultaneity between the interest rate and the exchange rate). We have not restricted NEMO accordingly for output and inflation. One way to do that would have been to assume that economic agents make some of their decisions before they observe the monetary policy shock also in NEMO (see for instance Christiano *et.al.* (2005)). By construction this would have generated a zero response on impact for output, and thereby a more gradual response for this variable also in NEMO. Notwithstanding this, the responses shown for NEMO are qualitatively in line with the conclusions from the empirical literature in general on monetary policy shocks. The responses of output and inflation are 'hump-shaped' and persistent. Output contracts after a monetary policy tightening and inflation falls. The peak effect on inflation lags the peak effect on output.

³³The high interest rates in the early 1990's can be attributed to the exchange rate regime of the time. Up until December 1992, the krone was tied to ECU. The German unification led to high interest rates in Europe, and, due to the exchange rate regime, consequently in Norway. The extreme levels of interest rates seen in late 1992 reflects the attempt to defend the parity against the ECU during the EMU crisis.

4 Model Properties

In this section, we discuss model properties by examining how key variables respond to a range of shocks. The purpose is to explain some of the most important properties of the model. We start from steady-state and introduce the shocks one at a time. In reality, the economy is hit by multiple shocks each period, and the economy is never in a steady-state equilibrium. To study model properties, however, it is helpful to keep things as simple as possible and look at one issue at a time.

It is important to recognize the role of monetary policy in these exercises. Monetary policy will, together with other mechanisms in the model economy, endogenously counteract the effects of the initial shocks. The simple instrument rule used, ensures that monetary policy reacts sufficiently in order to anchor inflation expectations. However, the simple rule does not necessarily give an optimal response to the shocks.

4.1 A monetary policy shock

This monetary policy shock increases short term interest rates with one percentage point (annualized) at impact, see figure 13. The shock is designed to show the surprised effects of an interest rate change on the model economy.

Due to nominal rigidities, higher nominal interest rates will increase real interest rates as well. Higher real interest rates lower both consumption and investment demand. When demand for the final good falls, firms will produce less and demand less of the factor inputs. Lower demand for labor puts downward pressure on nominal wages. Expected marginal costs decrease and prices start to fall. Whether real wages fall or not, depends on the degree of rigidity in wages versus prices, as well as the degree of market power among workers and their disutility from working. In NEMO, real wages decrease as monetary policy tightens.

Firms are able to adjust their utilization of capital. In the very short run, the input of effective capital services can therefore fall even if the physical capital stock is fixed. This mechanism contributes to a more muted response in real marginal costs.

The exchange rate appreciates following the unexpected increase in the interest rates. This puts downward pressure on import prices and adds to the fall in total inflation. This will lead to substitution towards imported goods in the short run, but the scale effect from lower consumption and investment will nevertheless produce a fall in imports. The appreciation of the currency will increase export prices, and the demand for exports will fall. After the initial increase in export prices, the reduction of the marginal costs will lead to a fall in export prices. Therefore, the demand for exports will pick up again.

The responses shown are qualitatively in line with the conclusions from the empirical literature on monetary policy shocks. The responses of both real and nominal variables are all 'hump-shaped' and persistent. Output contracts after a monetary policy tightening, real wages and marginal cost fall and inflation falls.

The peak effect on inflation lags the peak effect on output. This is in line with the results from an estimated VAR on Norwegian data, see Bjørnland (2005).

4.2 A temporary positive shock to labor-augmenting productivity

In this experiment, we show the effects of a temporary, but persistent, one per cent shock to labor-augmenting productivity, see figure 14.

A positive labor-augmenting productivity shock will enable firms to produce more for a given level of inputs. This is equivalent to a reduction in marginal costs. When costs are reduced, firms will find it profitable to produce more. Due to a downward-sloping demand curve, an isolated increase in supply implies lower prices. There will therefore be pressure towards lower prices and lower inflation. But because prices are rigid, they move less in the short run than if prices had been fully flexible.

As inflation falls, the central bank reduces interest rates in order to make inflation return to the target. Nominal rates must be reduced sufficiently so that the real interest rate also falls.

Lower real interest rates will increase consumption demand. Investment will also increase as real interest rates fall. In addition, higher labor productivity will raise the expected return on capital increases, further stimulating investment.

Higher demand will lead to an increase in output. A higher level of output would normally require more labor and capital services. However, due to increased productivity, firms can now produce more with less input of labor and capital services. Hence, the demand for both labor and capital services actually falls. Since the capital stock is more or less fixed in the short run, a reduction in the input of capital services means a lower utilization rate. Furthermore, lower demand for labor will put downward pressure on nominal wages. However, the fall in nominal wages is smaller than the fall in prices. As a consequence, real wages increase. This is also consistent with the increase in productivity and profit for the firms.

Furthermore, lower interest rates will lead to a depreciation of the currency in the short run, putting upward pressure on import prices. Hence, overall inflation will fall by less than the reduction in domestic inflation. The relative price of domestic to imported goods will fall, leading to a substitution towards domestically produced goods. However, the volume effect from changes in demand will outweigh the substitution effect. Imports therefore increase in the short run.

The reduction in marginal costs will stimulate exporters to lower their price and, hence, to increase their production. A depreciation of the currency will have the same effect, so exports will unambiguously increase.

4.3 A temporary positive shock to competition in the domestic product market

Here, we temporarily increase the price elasticity of demand for domestically produced goods, θ , see figure 15. This can be interpreted as stronger competition in the domestic product market.

Stronger competition reduces firms' pricing power, i.e. reduces firms' price mark-up over marginal cost. Firms will find it optimal to lower their prices, thereby stimulating demand for intermediate goods. As inflation falls, the monetary authorities will reduce interest rates, stimulating consumption. Lower interest rates and higher expected return on capital will induce firms to increase investments. This will raise output, and lead to increased demand for labor and capital services, pushing up the real wage. As a consequence, marginal costs will increase.

The currency depreciation following the monetary stimulus will make imports more expensive relative to domestic goods. However, higher demand for final goods will lead to higher imports. The overall positive price effect of a currency depreciation on exports is dampened by an increase in marginal costs in the intermediate sector.

After a while, inflation starts to pick up. The negative inflation gap starts to close. To head off a future inflationary spiral, interest rates are increased. This will dampen demand and output, closing the output gap.

4.4 A temporary positive shock to the degree of competition in the labor market

Here we look at the impulse responses of a temporary increase in the degree of competition in labor market, see figure 16. This can be interpreted as a temporary reduction in the market power of the employees. Increased competition in the labor market decreases workers' ability to exploit market power by restricting the supply of labor, putting downward pressure on wages.

On the production side, marginal costs decrease, leading intermediate firms to lower their prices. The monetary authorities will respond by reducing interest rates. Hence, households will increase consumption. Lower interest rates will also stimulate private investments. A higher expected return on capital will work in the same direction. This will stimulate aggregate demand and output, increasing input of both labor and effective capital. Since the stock of capital is more or less fixed in the short run, the initial demand for capital services is met by an increase in the utilization rate.

Lower interest rates leads to a currency depreciation. As a result, import prices increase. Higher import prices will dampen the increase in import volumes stimulated by higher domestic demand. A weaker currency has the opposite effect on export prices. Thus, exports increase.

4.5 A temporary negative shock to household preferences for consumption

This shock can be interpreted as a temporary negative shock to households preferences for consumption relative to leisure, see figure 17. As a consequence, household consumption decreases. The initial effect of lower consumption is to reduce aggregate demand and output. Hence, firms will find it optimal to reduce input of both labor and capital services. Because the capital stock is more or less fixed in the short to medium run, the capital utilization rate decreases. Lower demand for labor will put downward pressure on wages. Following the fall in marginal costs, firms will have an incentive to reduce their prices. The monetary policy authority reacts by lowering the nominal interest rate to stimulate output and production. This will partly counteract the initial fall in consumption. A lower expected return on capital will work to decrease investment demand. However, the effect of lower real interest rates will dominate, and investment increases.

A lower interest rate leads to a depreciation of the local currency. The depreciation of the exchange rate causes imported goods to become relatively more expensive. Together with the initial fall in demand, this leads to an unambiguous fall in imports. The depreciation of the currency and the fall in marginal costs will lead exporters to reduce their prices, hence, stimulating export demand.

4.6 A temporary but persistent increase in the risk premium

A positive shock to the risk premium can be interpreted as an increase in the return on foreign bonds relative to the return on domestic bonds, see figure 18. As a result, the exchange rate depreciates. This will put upward pressure on both imported and headline inflation. To fend off inflationary pressure, the central bank increases the nominal interest rate. The nominal interest rate must be increased sufficiently so that the real interest rate also increases. Higher real interest will lead to a reduction in both consumption and investment. However, the production increases in the short run due to a strong increase in net exports. Higher prices on imported goods and reduced domestic demand leads to a fall in imports. Export revenues go up due to the sharp depreciation of the currency.

In order to increase output, firms will demand more labor and capital services. This will in turn lead to an increase in the utilization rate of capital. However, even though the demand for labor increases, the real wage falls slightly. The reason for this is that the nominal wage increases less than inflation. The dip in real wages will lower marginal costs.

5 Final remarks

In this paper we have provided a technical documentation of NEMO. NEMO has already proved itself to be useful for practical purposes, both in identifying the economic forces driving the historical economic development and as a tool for policy analysis. The model has also been used for forecasting, but more experience is needed here. A thorough documentation of the empirical evaluation and real-time forecasting properties is a natural next step.

Model development is a continuous process, where improvements and extension should be envisaged, and where the model users should strive to gain experience with the models at hand. At the moment, there are several extensions and refinements to the current version of NEMO that are interesting and which will be the object for future research at Norges Bank. The challenge is to balance the degree of coherence with observed data, the degree of coherence with economic theory and the degree to which the model is useful as a tool for decision-makers. In our view we have found an appropriate balance, given the current regime for monetary policy and the environment in which the model is supposed to be used.

References

- Adolfson, M., Laséen, S., Lindé, J. and Villani, M.: 2005, Bayesian estimation of an open economy DSGE model with incomplete pass-through, *Working Paper 179*, Sveriges Riksbank.
- Bayoumi, T.: 2004, GEM: A new international macroeconomic model, *Occasional Paper 239*, International Monetary Fund.
- Bernhardsen, T.: 2005, The neutral interest rate, *Staff Memo 2005/1*, Norges Bank.
- Bjørnland, H. C.: 2005, Monetary policy and exchange rate interactions in a small open economy, *Working Paper 2005/16*, Norges Bank.
- Brubakk, L., Maih, J., Wolden Bache, I. and Østnor, M.: 2007, Empirical evaluation of the norwegian economy model, *Staff Memo forthcoming*, Norges Bank.
- Corsetti, G. and Pesenti, P.: 2001, Welfare and macroeconomic interdependence, *The Quarterly Journal of Economics* **116**(2), 421–445.
- Devereux, M. B. and Engel, C.: 2000, Monetary policy in the open economy revisited: Price setting and exchange rate flexibility, *Working Paper 7665*, NBER.
- Friedman, M.: 1956, *Studies in the Quantity Theory of Money*, University of Chicago Press, Chicago.
- Gali, J.: 1996, Unemployment in dynamic general equilibrium economies, *European Economic Review* **40**, 839–845.
- Husebø, T. A., McCaw, S., Olsen, K. and Røisland, Ø.: 2004, A small, calibrated macromodel to support inflation targeting at Norges Bank, *Staff Memo 2004/3*, Norges Bank.
- Husebø, T. A. and Wilhelmsen, B.-R.: 2005, The norwegian business cycle 1982-2003, *Staff Memo 2005/2*, Norges Bank.
- Kim, J.: 2000, Constructing and estimating a realistic optimizing model of monetary policy, *Journal of Monetary Economics* **45**(2).
- Kloster, A. and Solberg-Johansen, K.: 2006, Forecasting in Norges Bank, *Economic Bulletin* **LXXVII**(3), 112–122.
- Lane, P. R.: 2001, The new open economy macroeconomics: A survey, *Journal of International Economics* **54**, 235–266.
- Laxton, D. and Pesenti, P.: 2003, Monetary rules for small, open, emerging economies, *Journal of Monetary Economics* **50**, 1109–1146.

- Martins, J. O., Scarpetta, S. and Pilat, D.: 1996, Mark-up pricing, market structure and the business cycle, *OECD Economic Studies* **27**, 71–106.
- Modigliani, F.: 1986, Life cycle, individual thrift and the wealth of nations, *The American Economic Review* **76**(3), 297–313.
- Naug, B. E.: 2002, *Ekspport, Import Og Importpriser: En Empirisk Studie På Norske Tidsseriedata.*, PhD thesis, University of Oslo.
- Obstfeld, M. and Rogoff, K.: 1995, Exchange rate dynamics redux, *Journal of Political Economy* **103**(3), 624–660.
- Obstfeld, M. and Rogoff, K.: 2000, The six major puzzles in international macroeconomics: Is there a common cause?, *Working Paper 7777*, NBER.
- Qvigstad, J. F.: 2006, When does an interest rate path "look good"? criteria for an appropriate future interest rate path, *Working Paper 5*, Norges Bank.
- Røstøen, J. Ø.: 2004, External price impulses to imported consumer goods, *Economic Bulletin* **LXXV**(3), 96–102.
- Rotemberg, J. J.: 1982, Sticky Prices in the United States, *Journal of Political Economy* **90**, 1187–1211.
- Schmitt-Grohe, S. and Uribe, M.: 2003, Closing small open economy models, *Journal of International Economics* **61**, 163–185.
- Smets, F. and Wouters, R.: 2003, An estimated dynamic stochastic general equilibrium model of the euro area, *Journal of the European Economic Association* **1**(5), 1123 – 1175.
- Smets, F. and Wouters, R.: 2004, Comparing shocks and frictions in US and euro area business cycles: A bayesian DSGE approach, *Discussion Paper 4750*, Centre for Economic Policy Research (CEPR).
- Sutherland, A.: 2005, Incomplete pass-through and the welfare effects of exchange rate variability, *Journal of International Economics* **65**(2), 375–399.
- Svein, T. and Weinke, L.: 2007, Lumpy investment, sticky prices and the monetary transmission mechanism, *Journal of Monetary Economics* **forthcoming**.

A Appendix

A.1 List of Variables and Parameters

Variable	Description
<i>Prices and wages</i>	
π_t	Inflation, Q-on-Q, consumer price index
π_t^A	Inflation, Y-on-Y, consumer price index
π_t^Q	Inflation, Q-on-Q, domestic intermediate goods
π_t^M	Inflation, Q-on-Q, imported intermediate goods
π_t^{M*}	Inflation, Q-on-Q, exported intermediate goods
π_t^W	Nominal wage inflation, Q-on-Q
p_t^Q	Real price domestic intermediate goods
p_t^M	Real price imported intermediate goods
p_t^{M*}	Real price exported intermediate goods
w_t	Real wage
mc_t	Real marginal costs
<i>Production and demand</i>	
y_t	Gross domestic product, National account measure
c_t	Total consumption
c_t^{sp}	Consumption spenders
c_t^{sa}	Consumption savers
i_t	Investment
i_t^{oil}	Oil investment
g_t	Government spending
im_t	Imports, National account measure
ex_t	Exports, National account measure
a_t	Final goods
q_t	Demand for domestic intermediates
m_t	Demand for imported intermediates
m_t^*	Demand for exported intermediates
t_t	Intermediate production
l_t	Labor hours
k_t	Physical capital stock
u_t	Capital utilization rate
\bar{k}_t	Effective capital services
κ_t	Capital accumulation rate

Table 2: List of variables and parameters

Parameter	Description
<i>Controlling steady state</i>	
α	Capital share in intermediate goods production
β	Discount factor
δ	Depreciation rate fixed capital
Δz	Steady state growth rate of unit root technology shock
μ	Elasticity of substitution between domestic and imported goods
ν	Degree of home bias
ψ	Elasticity of substitution between labor inputs
r	Steady state nominal interest rate
slc	Share of spenders/liquidity constrained consumers
π^{tar}	Inflation target
θ	Elasticity of substitution between domestic intermediates
θ^*	Elasticity of substitution between imported intermediates
ζ	Inverse of Frisch Elasticity of labor supply
<i>Adjustment costs</i>	
b^c	Habit persistence in consumption
ϕ^{B1}	Financial intermediation parameter ensuring that net asset position converges to its steady state level
ϕ^{B2}	Financial intermediation parameter controlling speed of convergence to steady state
ϕ^U	Capital utilization adjustment cost parameter
ϕ^{I1}	Investment adjustment cost parameter relating to the deviation of the investment-capital ratio from steady-state
ϕ^{I2}	Investment adjustment cost parameter relating to the change in the investment-capital ratio
ϕ^{PM}	Nominal price adjustment cost parameter, imported goods
ϕ^{PQ}	Nominal price adjustment cost parameter, domestic goods
ϕ^W	Nominal wage adjustment cost parameter

Variable	Description
<i>Interest and exchange rates etc</i>	
r_t	Nominal interest rate
r_t^K	Real rental rate of capital
s_t	Real exchange rate
S_t	Nominal exchange rate
d_t	Stochastic discount rate
b_t	Domestic holdings of foreign bonds
ca_t	Current account
tb_t	Trade balance
$tboil_t$	Trade balance oil
<i>Adjustment Costs</i>	
γ_t^B	Intermediation cost, foreign bonds
γ_t^{PQ}	Price adjustment cost, domestic intermediate goods
$\gamma_t^{PM^*}$	Price adjustment cost, exported intermediate goods
γ_t^{PM}	Price adjustment cost, imported intermediate goods
γ_t^U	Adjustment cost, capital utilization
γ_t^W	Wage adjustment cost
$\gamma_t^{U'}$	Marginal adjustment cost, capital utilization
κ_t'	Marginal adjustment cost, investment
<i>Shock Processes</i>	
Δz_t	Growth of unit root technology shock
z_t^L	Temporary labor productivity shock
z_t^U	Consumption preference shock
z_t^I	Investment shock
z_t^{IOIL}	Oil investment shock
z_t^B	Risk premium shock
z_t^R	Monetary policy shock
z_t^M	Import shock, measurement error
z_t^X	Export shock, measurement error
θ_t	Elasticity of substitution between domestic intermediates
θ_t^*	Elasticity of substitution between imported intermediates
ψ_t	Elasticity of substitution between labor inputs

Variable	Description
<i>Monetary policy reaction function</i>	
ω^r	Weight on smoothing
ω^p	Weight on inflation deviations from target
ω^y	Weight on output gap
ω^s	Weight on real exchange rate
$\omega^{\Delta y}$	Weight on change in output gap
<i>Shock Processes</i>	
$\lambda^{\Delta z}$	Decay root for the temporary shock to the growth rate of the labor-augmenting technology
λ^L	Decay root for the temporary productivity shock
λ^{θ^*}	Decay root for the temporary shock to the elast. of subst. between imported intermediates
λ^θ	Decay root for the temporary shock to the elast. of subst. between domestic intermediates
λ^ψ	Decay root for the temporary shock to the elast. of subst. between differentiated labor inputs
λ^U	Decay root for the temporary shock to preferences
λ^B	Decay root for the temporary shock to bond holdings
λ^I	Decay root for the temporary shock to investments
λ^{IOIL}	Decay root for the temporary shock to oil investments
λ^{INV}	Decay root for the temporary shock to inventories
λ^G	Decay root for the temporary shock to government spending
λ^M	Decay root for the temporary shock to imports
λ^X	Decay root for the temporary shock to exports

A.2 The full stationary small open economy model

A.2.1 The domestic sector

Final goods

$$a_t = \left[\nu^{\frac{1}{\mu}} q_t^{\frac{\mu-1}{\mu}} + (1-\nu)^{\frac{1}{\mu}} m_t^{\frac{\mu-1}{\mu}} \right]^{\frac{\mu}{\mu-1}} \quad (\text{A.2.1})$$

$$q_t = \nu \left(p_t^Q \right)^{-\mu} a_t, \quad (\text{A.2.2})$$

$$m_t = (1-\nu) \left(p_t^M \right)^{-\mu} a_t \quad (\text{A.2.3})$$

Intermediate goods

$$t_t = \left[(1-\alpha)^{\frac{1}{\xi}} (z_t^L l_t)^{1-\frac{1}{\xi}} + \alpha^{\frac{1}{\xi}} \bar{k}_t^{1-\frac{1}{\xi}} \right]^{\frac{\xi}{\xi-1}}, \quad (\text{A.2.4})$$

$$\bar{k}_t = u_t \frac{k_{t-1}}{\pi_t^z} \quad (\text{A.2.5})$$

$$m c_t = \frac{w_t}{(1-\alpha)^{\frac{1}{\xi}}} \left(\frac{l_t}{t_t} \right)^{\frac{1}{\xi}} \quad (\text{A.2.6})$$

$$r_t^K \equiv \alpha^{\frac{1}{\xi}} m c_t \left(\frac{t_t}{\bar{k}_{t-1}} \right)^{\frac{1}{\xi}}$$

$$k_t = \frac{(1-\delta)}{\pi_t^z} k_{t-1} + \frac{\kappa_t}{\pi_t^z} k_{t-1} \quad (\text{A.2.7})$$

$$\frac{1}{\kappa'_t} = E_t d_{t,t+1} \pi_{t+1} \left\{ r_{t+1}^{SK} u_{t+1} - \gamma_{t+1}^{cu} + \frac{1}{\kappa'_{t+1}} \left[(1-\delta) + \kappa_{t+1} - \kappa'_{t+1} \frac{\pi_{t+1}^z i_{t+1}}{k_t} \right] \right\} \quad (\text{A.2.8})$$

$$\kappa_t = \left\{ \begin{array}{l} \frac{\pi_t^z i_t}{k_{t-1}} - \frac{\phi^{I1}}{2} \left[\left(\frac{\pi_t^z i_t}{k_{t-1}} - (\pi^z - 1 + \delta) z_t^I \right) \right]^2 \\ - \frac{\phi^{I2}}{2} \left(\frac{\pi_t^z i_t}{k_{t-1}} - \frac{\pi_{t-1}^z i_{t-1}}{k_{t-2}} \right)^2 \end{array} \right\} \quad (\text{A.2.9})$$

$$\kappa'_t = 1 - \phi^{I1} \left(\frac{\pi_t^z i_t}{k_{t-1}} - (\pi^z - 1 + \delta) z_t^I \right) - \phi^{I2} \left(\frac{\pi_t^z i_t}{k_{t-1}} - \frac{\pi_{t-1}^z i_{t-1}}{k_{t-2}} \right) \quad (\text{A.2.10})$$

$$p_t^Q = \theta_t m c_t \left[\begin{array}{l} (\theta_t - 1) + \phi^Q \left[\frac{\pi_t^Q}{\pi_{t-1}^Q} - 1 \right] \frac{\pi_t^Q}{\pi_{t-1}^Q} \\ - \phi^Q E_t \left\{ d_{t,t+1} \frac{\pi_{t+1}^z q_{t+1}}{q_t} \pi_{t+1}^Q \left[\frac{\pi_{t+1}^Q}{\pi_t^Q} - 1 \right] \frac{\pi_{t+1}^Q}{\pi_t^Q} \right\} \end{array} \right]^{-1} \quad (\text{A.2.11})$$

$$p_t^{M^*} = \theta_t^* \frac{m c_t}{s_t} \left[-\phi^{M^*} E_t d_{t,t+1} \left\{ \left(\frac{\pi_{t+1}^{M^*}}{\pi_t^{M^*}} - 1 \right) \pi_{t+1}^{M^*} \left(\frac{\pi_{t+1}^{M^*}}{\pi_t^{M^*}} \right) \frac{s_{t+1} m_{t+1}^* \pi_{t+1}^z}{s_t m_t^* \pi_{t+1}^*} \right\} \right]^{-1} \quad (\text{A.2.12})$$

$$\gamma_t^{PQ} \equiv \frac{\phi^Q}{2} \left[\frac{\pi_t^Q}{\pi_{t-1}^Q} - 1 \right]^2 \quad (\text{A.2.13})$$

$$\gamma_t^{PM^*} \equiv \frac{\phi^{M^*}}{2} \left[\frac{\pi_t^{M^*}}{\pi_{t-1}^{M^*}} - 1 \right]^2 \quad (\text{A.2.14})$$

$$\gamma_t^u = \phi^{cu1} \left(e^{\phi^{cu2}(u_t-1)} - 1 \right) \quad (\text{A.2.15})$$

$$[\gamma_t^u]' \equiv r_t^{SK} \quad (\text{A.2.16})$$

$$[\gamma_t^u]' = \phi^{u2} \phi^{cu1} e^{\phi^{u2}(u_t-1)} \quad (\text{A.2.17})$$

Households

$$\frac{1}{1+r_t} = E_t d_{t,t+1} \quad (\text{A.2.18})$$

$$d_{t,t+1} = \frac{\beta}{\pi_{t+1}} \frac{z_{t+1}^U}{z_t^U} \frac{1}{\pi_{t+1}^z} \frac{c_t^{sa} - b^c \frac{c_{t-1}^{sa}}{\pi_t^z}}{c_{t+1}^{sa} - b^c \frac{c_t^{sa}}{\pi_{t+1}^z}} \quad (\text{A.2.19})$$

$$E_t \left(d_{t,t+1} \frac{s_{t+1} \pi_{t+1}}{s_t \pi_{t+1}^*} \right) = \frac{(1+r_t) E_t d_{t,t+1}}{(1+r_t^*) [1-\gamma_t^{B^*}]} \quad (\text{A.2.20})$$

$$\gamma_t^{B^*} = \phi^{B1} \frac{\exp(\phi^{B2} ((1-slc) s_t b_{H,t}^*)) - 1}{\exp(\phi^{B2} ((1-slc) s_t b_{H,t}^*)) + 1} + z_t^B \quad (\text{A.2.21})$$

$$w_t = \psi_t m r s_t^{sa} \left[(\psi_t - 1) (1 - \gamma_t^W) + \frac{\phi^W \pi_t^W}{\pi_{t-1}^W} \left(\frac{\pi_t^W}{\pi_{t-1}^W} - 1 \right) - E_t d_{t,t+1} \pi_{t+1}^W \frac{l_{t+1}}{l_t} \frac{\phi^W \pi_{t+1}^W}{\pi_t^W} \left(\frac{\pi_{t+1}^W}{\pi_t^W} - 1 \right) \right]^{-1} \quad (\text{A.2.22})$$

$$m r s_t^{sa} = \frac{c_t^{sa} - b^c \frac{c_{t-1}^{sa}}{\pi_t^z}}{1 - \frac{b^c}{\pi_t^z}} (l_t) \zeta \quad (\text{A.2.23})$$

$$\gamma_t^W \equiv \frac{\phi^W}{2} \left[\frac{\pi_t^W}{\pi_{t-1}^W} - 1 \right]^2 \quad (\text{A.2.24})$$

$$c_t^{sp} = w_t l_t \quad (\text{A.2.25})$$

$$c_t = (slc) c_t^{sp} + (1-slc) c_t^{sa} \quad (\text{A.2.26})$$

$$(1 - slc)s_t b_{H,t}^* = (1 - slc)(1 - r_{t-1}^*) \frac{s_t b_{H,t-1}^*}{\pi_t^z \pi_t^*} + s_t (1 - \nu^*) (p_t^{M^*})^{1-\mu^*} y_t^* - p_t^M m_t + oilr \quad (\text{A.2.27})$$

Market clearing

$$t_t - \gamma_t^u(u_t) \frac{k_{t-1}}{\pi_t^z} = q_t + (1 - \nu^*) (p_t^{M^*})^{-\theta^*} y_t^* \quad (\text{A.2.28})$$

$$a_t = c_t + i_t + ioil_t + g_t \quad (\text{A.2.29})$$

$$y_t = c_t + i_t + g_t + ioil_t + s_t p_t^{M^*} m_t^* - p_t^M m_t \quad (\text{A.2.30})$$

Monetary policy reaction function

$$(1 + r_t)^4 = \omega_r (1 + r_{t-1})^4 + (1 - \omega_r) \left[(1 + r)^4 + \omega_1 \left(\frac{P_{t+4}}{P_t} - \pi^{tar} \right) \right] + z_t^R \quad (\text{A.2.31})$$

Definitions

$$\pi_t^Q \equiv \frac{p_t^Q}{p_{t-1}^Q} \pi_t \quad (\text{A.2.32})$$

$$\pi_t^{M^*} \equiv \frac{p_t^{M^*}}{p_{t-1}^{M^*}} \pi_t^* \quad (\text{A.2.33})$$

$$\pi_t^W \equiv \frac{w_t}{w_{t-1}} \pi_t^z \pi_t \quad (\text{A.2.34})$$

A.2.2 The foreign sector

$$\gamma_t^{PM} \equiv \frac{\phi^M}{2} \left[\frac{\pi_t^M}{\pi_{t-1}^M} - 1 \right]^2 \quad (\text{A.2.35})$$

$$\gamma_t^{W^*} \equiv \frac{\phi^{W^*}}{2} \left[\frac{\pi_t^{W^*}}{\pi_{t-1}^{W^*}} - 1 \right]^2 \quad (\text{A.2.36})$$

$$d_{t,t+1}^* = \frac{\beta}{\pi_{t+1}} \frac{z_{t+1}^{U^*}}{z_t^{U^*}} \frac{1}{\pi_{t+1}^z} \frac{c_t^* - b^* \frac{c_{t-1}^*}{\pi_t^z}}{c_{t+1}^* - b^* \frac{c_t^*}{\pi_{t+1}^z}} \quad (\text{A.2.37})$$

$$mrs_t^* = \frac{c_t^* - b^* \frac{c_{t-1}^*}{\pi_t^z}}{1 - \frac{b^* c_t^*}{\pi_t^z}} (l_t^*)^{\zeta^*} \quad (\text{A.2.38})$$

$$\pi_t^{W^*} \equiv \frac{w_t^*}{w_{t-1}^*} \pi_t^z \pi_t^* \quad (\text{A.2.39})$$

$$\pi_t^M \equiv \frac{p_t^M}{p_{t-1}^M} \pi_t \quad (\text{A.2.40})$$

$$\frac{1}{1+r_t^*} = E_t d_{t,t+1}^* \quad (\text{A.2.41})$$

$$w_t^* = \psi_t^* m r s_t^* \left[\begin{array}{c} (\psi_t^* - 1) (1 - \gamma_t^{W^*}) + \frac{\phi^{W^*} \pi_t^{W^*}}{\pi_{t-1}^{W^*}} \left(\frac{\pi_t^{W^*}}{\pi_{t-1}^{W^*}} - 1 \right) \\ - E_t d_{t,t+1}^* \pi_{t+1}^W \frac{l_{t+1}}{l_t} \frac{\phi^{W^*} \pi_{t+1}^{W^*}}{\pi_t^{W^*}} \left(\frac{\pi_{t+1}^{W^*}}{\pi_t^{W^*}} - 1 \right) \end{array} \right]^{-1} \quad (\text{A.2.42})$$

$$y_t^* = z_t^{L^*} l_t^* \quad (\text{A.2.43})$$

$$m c_t^* = \frac{w_t^*}{z_t^{L^*}} \quad (\text{A.2.44})$$

$$1 = \theta_t m c_t^* \left[\begin{array}{c} (\theta_t - 1) + \phi^{Q^*} \left[\frac{\pi_t^{Q^*}}{\pi_{t-1}^{Q^*}} - 1 \right] \frac{\pi_t^{Q^*}}{\pi_{t-1}^{Q^*}} \\ - \phi^{Q^*} E_t \left\{ d_{t,t+1}^* \frac{\pi_{t+1}^z q_{t+1}}{q_t} \pi_{t+1}^Q \left[\frac{\pi_{t+1}^{Q^*}}{\pi_t^{Q^*}} - 1 \right] \frac{\pi_{t+1}^{Q^*}}{\pi_t^{Q^*}} \right\} \end{array} \right]^{-1} \quad (\text{A.2.45})$$

$$p_t^M = \theta_t^* (m c_t^* s_t) \left[\begin{array}{c} (\theta_t^* - 1) + \phi^M \left[\frac{\pi_t^M}{\pi_{t-1}^M} - 1 \right] \frac{\pi_t^M}{\pi_{t-1}^M} \\ - \phi^M E_t \left\{ d_{t,t+1}^* \frac{\pi_{t+1}}{\pi_{t+1}^*} \frac{s_{t+1} \pi_{t+1}^z m_{t+1}}{s_t m_t} \pi_{t+1}^M \left[\frac{\pi_{t+1}^M}{\pi_t^M} - 1 \right] \frac{\pi_{t+1}^M}{\pi_t^M} \right\} \end{array} \right]^{-1} \quad (\text{A.2.46})$$

$$(1+r_t^*)^4 = \left\{ \begin{array}{c} \omega_r^* (1+r_{t-1}^*)^4 + \Omega^*(F_t^*) + z_t^{R^*} \\ + (1-\omega_r^*) [(1+r_t^*)^4 + \omega_1 (\pi_{t-1}^* \pi_{t-2}^* \pi_{t-3}^* \pi_{t-4}^* - \pi^{*,tar})] \end{array} \right\} \quad (\text{A.2.47})$$

$$y_t^* = c_t^* + g_t^* \quad (\text{A.2.48})$$

A.2.3 Shock processes

$$\log \left(\frac{\pi_t^z}{\pi^z} \right) = \lambda^{\pi^z} \log \left(\frac{\pi_{t-1}^z}{\pi^z} \right) + \varepsilon_{\pi_t^z}$$

$$\log \left(\frac{z_t^L}{z^L} \right) = \lambda^L \log \left(\frac{z_{t-1}^L}{z^L} \right) + \varepsilon_{z_t^L}$$

$$\log \left(\frac{g_t}{g} \right) = \lambda^G \log \left(\frac{g_{t-1}}{g} \right) + \varepsilon_{g_t}$$

$$\log\left(\frac{ioil_t}{ioil}\right) = \lambda^{IOIL} \log\left(\frac{ioil_{t-1}}{ioil}\right) + \varepsilon_{ioil_t}$$

$$\log\left(\frac{\theta_t}{\theta}\right) = \lambda^{\theta^H} \log\left(\frac{\theta_{t-1}}{\theta}\right) + \varepsilon_{\theta_t}$$

$$\log\left(\frac{\theta_t^*}{\theta^*}\right) = \lambda^{\theta^*} \log\left(\frac{\theta_{t-1}^*}{\theta^*}\right) + \varepsilon_{\theta_t^*}$$

$$\log\left(\frac{\psi_t}{\psi}\right) = \lambda^\psi \log\left(\frac{\psi_{t-1}}{\psi}\right) + \varepsilon_{\psi_t}$$

$$\log\left(\frac{z_t^U}{z^U}\right) = \lambda^U \log\left(\frac{z_{t-1}^U}{z^U}\right) + \varepsilon_{z_t^U}$$

$$\ln\left(\frac{z_t^B}{z^B}\right) = \lambda^B \left(\frac{z_t^B}{z^B}\right) + \varepsilon_{z_t^B}$$

$$\log\left(\frac{z_t^I}{z^I}\right) = \lambda^I \log\left(\frac{z_{t-1}^I}{z^I}\right) + \varepsilon_{z_t^I}$$

$$z_t^R = \varepsilon_{z_t^R}$$

A.3 The steady state model

A.3.1 The domestic sector

Final goods

$$a = \left[\nu^{\frac{1}{\mu}} q^{\frac{\mu-1}{\mu}} + (1-\nu)^{\frac{1}{\mu}} m^{\frac{\mu-1}{\mu}} \right]^{\frac{\mu}{\mu-1}} \quad (\text{A.3.1})$$

$$q = \nu (p^Q)^{-\mu} a, \quad (\text{A.3.2})$$

$$m = (1-\nu) (p^M)^{-\mu} a \quad (\text{A.3.3})$$

Intermediate goods

$$t = \left[(1-\alpha)^{\frac{1}{\xi}} l^{1-\frac{1}{\xi}} + \alpha^{\frac{1}{\xi}} \bar{k}^{-1-\frac{1}{\xi}} \right]^{\frac{\xi}{\xi-1}}, \quad (\text{A.3.4})$$

$$\bar{k} = \frac{k}{\pi^z} \quad (\text{A.3.5})$$

$$u = 1$$

$$r^K \equiv \alpha^{\frac{1}{\xi}} m c \left(\frac{t}{\bar{k}} \right)^{\frac{1}{\xi}}$$

$$mc = \frac{w}{(1-\alpha)^{\frac{1}{\xi}}} \left(\frac{l}{t}\right)^{\frac{1}{\xi}} \quad (\text{A.3.6})$$

$$\pi^z = (1-\delta) + \Psi \quad (\text{A.3.7})$$

$$\kappa = \frac{\pi^z i}{k} \quad (\text{A.3.8})$$

$$\kappa'_t = 1 \quad (\text{A.3.9})$$

$$[\gamma^{u'}] \equiv \phi^{u2} \phi^{u1} \quad (\text{A.3.10})$$

$$r^K = \frac{r}{\pi} - (1-\delta) \quad (\text{A.3.11})$$

$$\gamma^{PQ} \equiv 0 \quad (\text{A.3.12})$$

$$\gamma^{PM^*} \equiv 0 \quad (\text{A.3.13})$$

$$p^Q = \frac{\theta}{\theta-1} mc \quad (\text{A.3.14})$$

$$sp^{M^*} = \frac{\theta^*}{\theta^*-1} mc \quad (\text{A.3.15})$$

$$\gamma^u = 0$$

$$[\gamma^u]' = r^K \quad (\text{A.3.16})$$

Housholds

$$\frac{1}{1+r} = d \quad (\text{A.3.17})$$

$$d = \frac{\beta}{\pi} \frac{1}{\pi^z} \quad (\text{A.3.18})$$

$$\frac{\pi}{\pi^*} = \frac{(1+r)}{(1+r^*)} \quad (\text{A.3.19})$$

$$w = \frac{\psi}{(\psi-1)} mrs^{sa} \quad (\text{A.3.20})$$

$$mrs^{sa} = c^{sa} l^\zeta \quad (\text{A.3.21})$$

$$\gamma^W \equiv 0 \quad (\text{A.3.22})$$

$$\gamma^{B^*} = 0 \quad (\text{A.3.23})$$

$$b_H^* = 0 \quad (\text{A.3.24})$$

$$c^{sp} = wl \quad (\text{A.3.25})$$

$$c = (slc)c^{sp} + (1 - slc)c^{sa} \quad (\text{A.3.26})$$

$$0 = s(1 - \nu^*) (p^{M^*})^{1-\theta^*} y^* - p^M m + oilr \quad (\text{A.3.27})$$

A.3.2 Market clearing

$$t = q + (1 - \nu^*) (p^{M^*})^{-\theta^*} y^* \quad (\text{A.3.28})$$

$$a = c + i + ioil + g \quad (\text{A.3.29})$$

$$y = c + i + g + ioil + s(1 - \nu^*) (p^{M^*})^{1-\mu^*} y^* - p^M m \quad (\text{A.3.30})$$

Definitions

$$\pi^W \equiv \pi^z \pi \quad (\text{A.3.31})$$

$$\pi^Q \equiv \pi \quad (\text{A.3.32})$$

$$\pi^{M^*} \equiv \pi^* \quad (\text{A.3.33})$$

$$\pi \equiv \pi^{tar} \quad (\text{A.3.34})$$

A.3.3 The foreign sector

$$\gamma^{PQ} \equiv 0 \quad (\text{A.3.35})$$

$$\gamma^{PM} \equiv 0 \quad (\text{A.3.36})$$

$$\gamma^{W^*} \equiv 0 \quad (\text{A.3.37})$$

$$d^* = \frac{\beta}{\pi} \frac{1}{\pi^z} \quad (\text{A.3.38})$$

$$mrs^* = c^*(l^*)^\zeta^* \quad (\text{A.3.39})$$

$$\pi^{W^*} \equiv \pi^z \pi^* \quad (\text{A.3.40})$$

$$\pi^M \equiv \pi \quad (\text{A.3.41})$$

$$\frac{1}{1+r^*} = d^* \quad (\text{A.3.42})$$

$$w^* = \frac{\psi^*}{\psi^* - 1} mrs^* \quad (\text{A.3.43})$$

$$y^* = l^* \quad (\text{A.3.44})$$

$$mc^* = w^* \quad (\text{A.3.45})$$

$$1 = \frac{\theta}{(\theta - 1)} mc^* \quad (\text{A.3.46})$$

$$p^M = \frac{\theta^*}{\theta^* - 1} mc^* s \quad (\text{A.3.47})$$

$$\pi^* = \pi^{*,tar} \quad (\text{A.3.48})$$

$$y^* = c^* + g^* \quad (\text{A.3.49})$$

A.4 The linearized model for the domestic economy

A.4.1 Final goods

$$\hat{a}_t = \nu^{\frac{1}{\mu}} \left(\frac{q}{a}\right)^{\frac{\mu-1}{\mu}} \hat{q}_t + (1-\nu)^{\frac{1}{\mu}} \left(\frac{m}{a}\right)^{\frac{\mu-1}{\mu}} \hat{m}_t \quad (\text{A.4.1})$$

$$\hat{q}_t = -\mu \hat{p}_t^Q + \hat{a}_t$$

$$\hat{m}_t = -\mu \hat{p}_t^M + \hat{a}_t \quad (\text{A.4.2})$$

A.4.2 Intermediate goods

$$\widehat{t}_t = (1 - \alpha)^{\frac{1}{\xi}} \left(\frac{z^L l}{t} \right)^{1 - \frac{1}{\xi}} \left(\widehat{z}_t^L + \widehat{l}_t \right) + \alpha^{\frac{1}{\xi}} \left(\frac{\bar{k}}{t} \right)^{1 - \frac{1}{\xi}} \bar{k}_t \quad (\text{A.4.3})$$

$$\widehat{k}_t = \widehat{u}_t + \widehat{k}_{t-1} - \widehat{\pi}_t^z \quad (\text{A.4.4})$$

$$\widehat{m}c_t = \widehat{w}_t + \frac{1}{\xi} \left(\widehat{l}_t - \widehat{t}_t \right) - \left(1 - \frac{1}{\xi} \right) \widehat{z}_t^L \quad (\text{A.4.5})$$

$$\widehat{r}_t^K = \widehat{m}c_t - \frac{1}{\xi} \left(\widehat{k}_t - \widehat{t}_t \right) \quad (\text{A.4.6})$$

$$\widehat{k}_t = \frac{(1 - \delta)}{\pi^z} \left(\widehat{k}_{t-1} - \widehat{\pi}_t^z \right) + \left(1 - \frac{(1 - \delta)}{\pi^z} \right) \widehat{i}_{t-1} \quad (\text{A.4.7})$$

$$\widehat{\pi}_t^Q = \frac{1}{1 + \beta} \widehat{\pi}_{t-1}^Q + \frac{\beta}{1 + \beta} E_t \widehat{\pi}_{t+1}^Q + \frac{\theta - 1}{\phi^Q (1 + \beta)} \widehat{m}c_t^Q - \frac{1}{\phi^Q (1 + \beta)} \widehat{\theta}_t \quad (\text{A.4.8})$$

$$\widehat{\pi}_t^{M^*} = \frac{1}{1 + \beta} \widehat{\pi}_{t-1}^{M^*} + \frac{\beta}{1 + \beta} E_t \widehat{\pi}_{t+1}^{M^*} + \frac{\theta^* - 1}{\phi^{M^*} (1 + \beta)} \left(\widehat{m}c_t - \widehat{s}_t - \widehat{p}_t^{M^*} \right) - \frac{1}{\phi^{M^*} (1 + \beta)} \widehat{\theta}_t^* \quad (\text{A.4.9})$$

$$\begin{aligned} \widehat{i}_t - \widehat{k}_{t-1} &= \frac{\phi^{I2} i \pi^z}{v} \left(\widehat{i}_{t-1} - \widehat{k}_{t-2} \right) + \beta E_t \frac{(\phi^{I1} + \phi^{I2}) i \pi^z}{v} \frac{1}{k} \left(\widehat{i}_{t+1} - \widehat{k}_t \right) \\ &\quad - \frac{1}{v} E_t (r_t - \widehat{\pi}_{t+1}) + \frac{\beta}{\pi^z} \frac{r_K}{v} E_t \widehat{r}_{t+1}^K \quad (\text{A.4.10}) \\ &\quad + \frac{\phi^{I1} i \pi^z}{v} \widehat{z}_t^I - \beta \frac{\phi^{I1} i \pi^z}{v} E_t \widehat{z}_{t+1}^I + \beta \frac{(\phi^{I1} + \phi^{I2}) i \pi^z}{v} \frac{1}{k} E_t \widehat{\pi}_{t+1}^z - \widehat{\pi}_t^z + \frac{\phi^{I2} i \pi^z}{v} \frac{1}{k} \widehat{\pi}_{t-1}^z \end{aligned}$$

where:

$$v = (\phi^{I1} + (1 - \beta) \phi^{I2}) \frac{i \pi^z}{k}$$

$$\phi^{cu2} \widehat{u}_t = \widehat{r}_t^K \quad (\text{A.4.11})$$

A.4.3 Housholds

$$\begin{aligned} \widehat{c}_t^{sa} &= \frac{\pi^z}{\pi^z + b^c} E_t \widehat{c}_{t+1}^{sa} + \frac{b^c}{\pi^z + b^c} \widehat{c}_{t-1}^{sa} - \frac{\pi^z - b^c}{\pi^z + b^c} E_t (\widehat{r}_t - \widehat{\pi}_{t+1}) \\ &\quad + \frac{\mu}{\pi^z + b^c} E_t \widehat{\pi}_{t+1}^z - \frac{b^c}{\pi^z + b^c} \widehat{\pi}_t^z - \frac{\pi^z - b^c}{\pi^z + b^c} (E_t \widehat{z}_{t+1}^U - \widehat{z}_t^U) \quad (\text{A.4.12}) \end{aligned}$$

$$\widehat{s}_t = \widehat{s}_{t+1} - \left\{ (r_t - \widehat{\pi}_{t+1}) - [(\widehat{r}_t^* - \widehat{\pi}_{t+1}^*) - \Delta\gamma_t^{B^*}] \right\}$$

where:

$$\Delta\gamma_t^{B^*} = \frac{\phi_{B1}\phi_{B2}}{2}(1 - slc)\widehat{b}_{H,t}^* + \widehat{z}_t^B$$

$$\widehat{\pi}_t^W = \frac{1}{1+\beta}\widehat{\pi}_{t-1}^W + \frac{\beta}{1+\beta}E_t\widehat{\pi}_{t+1}^W + \frac{\psi-1}{\phi^W(1+\beta)}(\widehat{mrs}_t - \widehat{w}_t) - \frac{1}{\phi^W(1+\beta)}\widehat{\psi}_t \quad (\text{A.4.13})$$

$$\widehat{mrs}_t = \zeta\widehat{l}_t + \frac{1}{\pi^z - bc}(\pi^z\widehat{c}_t^{sa} - b^c\widehat{c}_{t-1}^{sa}) - \widehat{z}_t^U$$

$$\begin{aligned} \widehat{b}_{H,t}^* &= \frac{(1+r)}{\pi^z\pi^*}\widehat{b}_{H,t-1}^* \\ &+ \frac{p^{M^*}m^*}{(1-slc)} \left[(\widehat{s}_t + \widehat{p}_t^{M^*} + \widehat{m}_t^*) - \frac{p^M m}{sp^{M^*}m^*}(\widehat{p}_t^M + \widehat{m}_t) \right] \end{aligned} \quad (\text{A.4.14})$$

$$\widehat{c}_t^{sp} = \widehat{w}_t + \widehat{l}_t \quad (\text{A.4.15})$$

A.4.4 Market clearing

$$\widehat{a}_t = \frac{c}{a}\widehat{c}_t + \frac{i}{a}\widehat{i}_t + \frac{g}{a}\widehat{g}_t + \frac{ioil}{a}\widehat{ioil}_t \quad (\text{A.4.16})$$

$$\widehat{t}_t = \frac{q}{t}\widehat{q}_t + \frac{m^*}{t}\widehat{m}_t^* \quad (\text{A.4.17})$$

$$\widehat{c}_t = (slc)\frac{c^{sp}}{c}\widehat{c}_t^{sp} + (1-slc)\frac{c^{sa}}{c}\widehat{c}_t^{sa}. \quad (\text{A.4.18})$$

$$y_t = \frac{a}{y}\widehat{a}_t + \frac{sp^{M^*}m^*}{y} \left[(\widehat{s}_t + \widehat{p}_t^{M^*} + \widehat{m}_t^*) - \frac{p^M m}{sp^{M^*}m^*}(\widehat{p}_t^M + \widehat{m}_t) \right] \quad (\text{A.4.19})$$

A.4.5 Definitions

$$\widehat{\pi}_t^Q = \widehat{p}_t^Q - \widehat{p}_{t-1}^Q + \widehat{\pi}_t \quad (\text{A.4.20})$$

$$\widehat{\pi}_t^{M^*} = \widehat{p}_t^{M^*} - \widehat{p}_{t-1}^{M^*} + \widehat{\pi}_t \quad (\text{A.4.21})$$

$$\widehat{\pi}_t^W = \widehat{w}_t - \widehat{w}_{t-1} + \widehat{\pi}_t + \widehat{\pi}_t^z \quad (\text{A.4.22})$$

A.4.6 Shock processes

$$\widehat{z}_t^L = \lambda^L \widehat{z}_{t-1}^L + \varepsilon_t^L \quad (\text{A.4.23})$$

$$\widehat{\pi}_t^z = \lambda^{\pi^z} \widehat{\pi}_{t-1}^z + \varepsilon_t^{\pi^z} \quad (\text{A.4.24})$$

$$\widehat{\theta}_t = \lambda^\theta \widehat{\theta}_{t-1} + \varepsilon_t^\theta \quad (\text{A.4.25})$$

$$\widehat{\theta}_t^* = \lambda^{\theta^*} \widehat{\theta}_{t-1}^* + \varepsilon_t^{\theta^*} \quad (\text{A.4.26})$$

$$\widehat{z}_t^U = \lambda^U \widehat{z}_{t-1}^U + \varepsilon_t^U \quad (\text{A.4.27})$$

$$\widehat{z}_t^I = \lambda^I \widehat{z}_{t-1}^I + \varepsilon_t^I \quad (\text{A.4.28})$$

$$\widehat{z}_t^B = \lambda^B \widehat{z}_{t-1}^B + \varepsilon_t^B \quad (\text{A.4.29})$$

$$\widehat{\psi}_t = \lambda^\psi \widehat{\psi}_{t-1} + \varepsilon_t^\psi \quad (\text{A.4.30})$$

$$\widehat{g}_t = \lambda^G \widehat{g}_{t-1} + \varepsilon_t^g \quad (\text{A.4.31})$$

$$\widehat{ioil}_t = \lambda^{IOIL} \widehat{ioil}_{t-1} + \varepsilon_t^{ioil} \quad (\text{A.4.32})$$

A.5 List of gross coefficients in the linearized model

Description		Description	
f_1	$(1 - \alpha)^{\frac{1}{\xi}} \left(\frac{zLl}{t} \right)^{1 - \frac{1}{\xi}}$	f_{19}	$\frac{\pi^z - b^c}{\pi^z + b^c}$
f_2	$\frac{1}{\xi}$	f_{20}	$\frac{\phi^{I2}}{(\phi^{I1} + (1 - \beta)\phi^{I2})}$
f_3	ϕ^{cu2}	f_{21}	$\beta \frac{(\phi^{I1} + \phi^{I2})}{(\phi^{I1} + (1 - \beta)\phi^{I2})}$
f_4	$\frac{1}{1 + \beta}$	f_{22}	$\frac{1}{(\phi^{I1} + (1 - \beta)\phi^{I2})^{\frac{i\pi^z}{k}}}$
f_5	$\frac{\theta - 1}{\phi^{PQ}(1 + \beta)}$	f_{23}	$\frac{\beta}{\pi^z} \frac{r_K}{(\phi^{I1} + (1 - \beta)\phi^{I2})^{\frac{i\pi^z}{k}}}$
f_6	$\frac{1}{\phi^{PQ}(1 + \beta)}$	f_{24}	$\frac{(1 - \delta)}{\pi^z}$
f_7	$\frac{\theta^* - 1}{\phi^{M^*}(1 + \beta)}$	f_{25}	$\frac{p^M m}{sp^{M^*} m^*}$
f_8	$\frac{1}{\phi^{M^*}(1 + \beta)}$	f_{26}	$\frac{q}{t}$
f_9	$\frac{\theta - 1}{\phi^M(1 + \beta)}$	f_{27}	$\frac{m^*}{t}$
f_{10}	$\frac{1}{\phi^M(1 + \beta)}$	f_{28}	$\frac{a}{y}$
f_{11}	$\nu^{\frac{1}{\mu}} \left(\frac{q}{a} \right)^{\frac{\mu - 1}{\mu}}$	f_{29}	$\frac{sp^{M^*} m^*}{y}$
f_{12}	μ	f_{30}	$\frac{c}{a}$
f_{13}	$\frac{\psi - 1}{\phi^W(1 + \beta)}$	f_{31}	$\frac{i}{a}$
f_{14}	$\frac{1}{\phi^W(1 + \beta)}$	f_{32}	$\frac{g}{a}$
f_{15}	$\frac{\pi^z}{\pi^z - b^c}$	f_{33}	$\frac{ioil}{a}$
f_{16}	$\frac{b^c}{\pi^z - b^c}$	f_{34}	$\frac{\phi^{B1}\phi^{B2}}{2} (1 - slc)$
f_{17}	ζ	f_{35}	$\frac{(1 + r^*)}{\pi^z \pi^*}$
f_{18}	$\frac{\pi^z}{\pi^z + b^c}$	f_{36}	$\frac{p^{M^*} m^*}{(1 - slc)}$

Table 3: List of gross coefficients in the linearized model

A.6 Data description and sources

Variable	Description
p_t	Consumer Price Index Adjusted for Taxes and Energy Prices (KPIJAE), trend component. Source: Statistics Norway and Norges Bank.
p_t^*	Consumer Price Index Trading Partners (24 countries), trend component. Source: EcoWin and Norges Bank.
p_t^M	Consumer Price Index Imported Consumer Goods (KPIJAEIMP), trend component. Source: Statistics Norway and Norges Bank.
p_t^{M*}	Deflator Export of traditional goods, trend component. Source: Statistics Norway and Norges Bank.
mc_t^*	International Price Impulses to Imported Consumer Good Prices, trend component. Source: Statistics Norway and Norges Bank.
y_t	Gross domestic product Mainland Norway, trend component. Million NOK at fixed prices. Source: Statistics Norway and Norges Bank.
\hat{y}_t^*	Output gap Trading Partners, seasonally adjusted. Source: OECD, Statistics Norway and Norges Bank.
c_t	Private consumption, trend component + Gross investment Housing, trend component. Million NOK at fixed prices. Source: Statistics Norway and Norges Bank.
i_t	Gross Investment corporate sector mainland Norway, trend component. Measured in million NOK. Source: Statistics Norway and Norges Bank.
i_t^{oil}	Gross Investment Oil activities and Sea transport, public sector, trend component. Million NOK. Source: Statistics Norway and Norges Bank.
g_t	Public consumption + Gross investment public sector, trend component. Million NOK. Source: Statistics Norway and Norges Bank.
im_t	Imports Mainland Norway, trend component. Million NOK. Source: Statistics Norway and Norges Bank.
ex_t	Exports Mainland Norway, trend component. Million NOK. Source: Statistics Norway and Norges Bank.
r_t	3 months effective nominal money market rate. Source: Norges Bank.
r_t^*	3 month effective foreign nominal money market rate. Trade weighted (USA, EUR, SWE and GBR). Source: Reuters and Norges Bank.
s_t	Nominal Exchange Rate. Import weighted 44 Countries (I-44). Source: Norges Bank.
π_t^W	Wage growth. Technical Reporting Committee on Income Settlements (TBU) definition. Source: TBU and Norges Bank.
l_t	Total hours worked mainland Norway, trend component. Source: Statistics Norway and Norges Bank.

Table 4: Data description and sources

A.7 Estimation results

	Prior distr.	Prior mean	Prior s.d.	Post. mean	HPD inf	HPD sup
b^c	beta	0.750	0.0500	0.8862	0.8592	0.9171
ϕ^M	invg	3.000	1.0000	2.3498	1.6008	3.1146
ϕ^{PQ}	invg	1.200	0.3000	1.4893	0.9543	1.9702
ϕ^W	invg	1.200	0.3000	1.4663	0.8877	1.9263
ϕ^{cu2}	invg	0.500	0.2000	0.3862	0.2389	0.5197
ϕ^{I2}	invg	100.000	Inf	132.5627	84.3165	175.2731
ω^r	beta	0.800	0.0500	0.8013	0.7634	0.8408
ω^y	norm	0.000	0.1000	0.0613	0.0154	0.1054
ω^s	norm	0.000	0.1000	0.1951	0.1078	0.2821
$\omega^{\Delta y}$	norm	0.000	0.2000	-0.0469	-0.0810	-0.0165
$\omega^{\Delta \pi}$	norm	0.000	0.5000	0.2370	-0.1051	0.5703
λ^{θ^H}	beta	0.750	0.1000	0.5359	0.4043	0.6764
λ^{θ^F}	beta	0.750	0.1000	0.4651	0.3185	0.6154
λ^ψ	beta	0.750	0.1000	0.7330	0.6260	0.8502
λ^U	beta	0.750	0.1000	0.7584	0.6581	0.8653
λ^L	beta	0.750	0.1000	0.8864	0.8370	0.9354
λ^I	beta	0.750	0.1000	0.8600	0.8067	0.9230
$\lambda^{\Delta z}$	beta	0.750	0.1000	0.7359	0.5892	0.8740
λ^X	beta	0.750	0.1000	0.9580	0.9342	0.9828
λ^B	beta	0.750	0.1000	0.8774	0.8093	0.9483

Table 5: Results from Metropolis Hastings (parameters)

	Prior distr.	Prior mean	Prior s.d.	Post. mean	HPD inf	HPD sup
$\varepsilon_t^{\Delta z}$	invg	0.001	Inf	0.0008	0.0003	0.0003
$\varepsilon_t^{z^X}$	invg	0.001	Inf	0.0196	0.0164	0.0164
$\varepsilon_t^{z^r}$	invg	0.001	Inf	0.0025	0.0020	0.0020
ε_t^ψ	invg	1.000	Inf	0.5988	0.3498	0.3498
$\varepsilon_t^{\theta^H}$	invg	1.000	Inf	0.3884	0.2500	0.2500
$\varepsilon_t^{\theta^F}$	invg	1.000	Inf	0.9419	0.5777	0.5777
$\varepsilon_t^{z^I}$	invg	0.001	Inf	0.0186	0.0118	0.0118
$\varepsilon_t^{z^U}$	invg	0.001	Inf	0.0159	0.0115	0.0115
$\varepsilon_t^{z^L}$	invg	0.001	Inf	0.0098	0.0082	0.0082
$\varepsilon_t^{z^B}$	invg	0.001	Inf	0.0026	0.0014	0.0014

Table 6: Results from Metropolis Hastings (standard deviation of structural shocks)

	Prior distr.	Prior mean	Prior s.d.	Post. mean	HPD inf	HPD sup
Δy	invg	0.001	Inf	0.0030	0.0025	0.0035
Δim_t	invg	0.001	Inf	0.0030	0.0025	0.0035

Table 7: Results from Metropolis Hastings (standard deviation of measurement errors)

y_t	c_t	i_t	x_t	m_t	π_t	π_t^Q	π_t^M	π_t^W	L_t	r_t	s_t
1.7	2.1	12.9	4.3	2.1	0.7	1.0	0.7	0.7	2.1	0.9	3.8
(2.6)	(2.0)	(13.8)	(5.3)	(4.9)	(0.2)	(0.3)	(0.4)	(0.3)	(2.4)	(0.4)	(5.0)

Table 8: Standard deviations in per cent from model and data. Empirical moments in parentheses

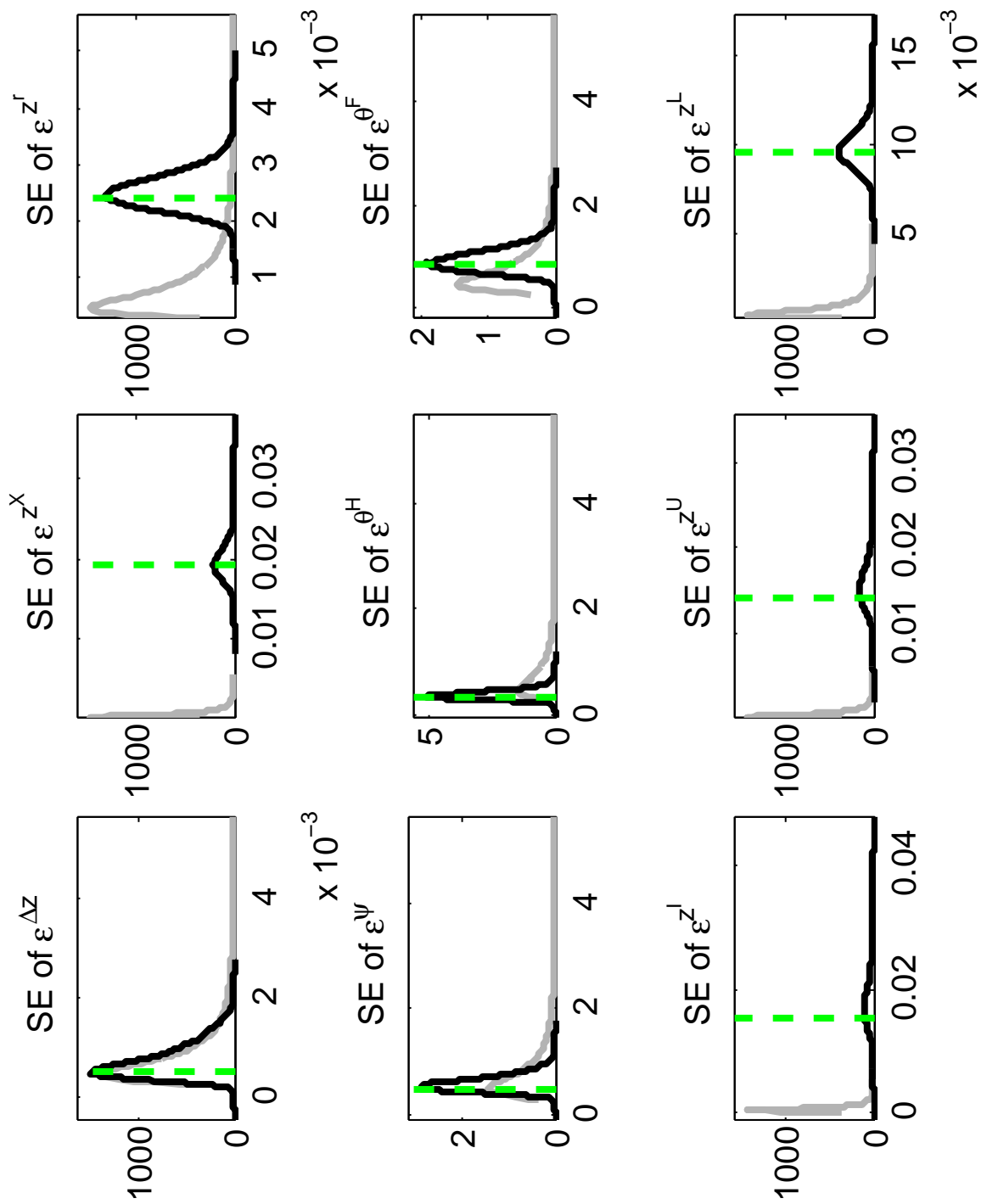

Figure 3: Priors and posteriors for standard errors of the shock innovations

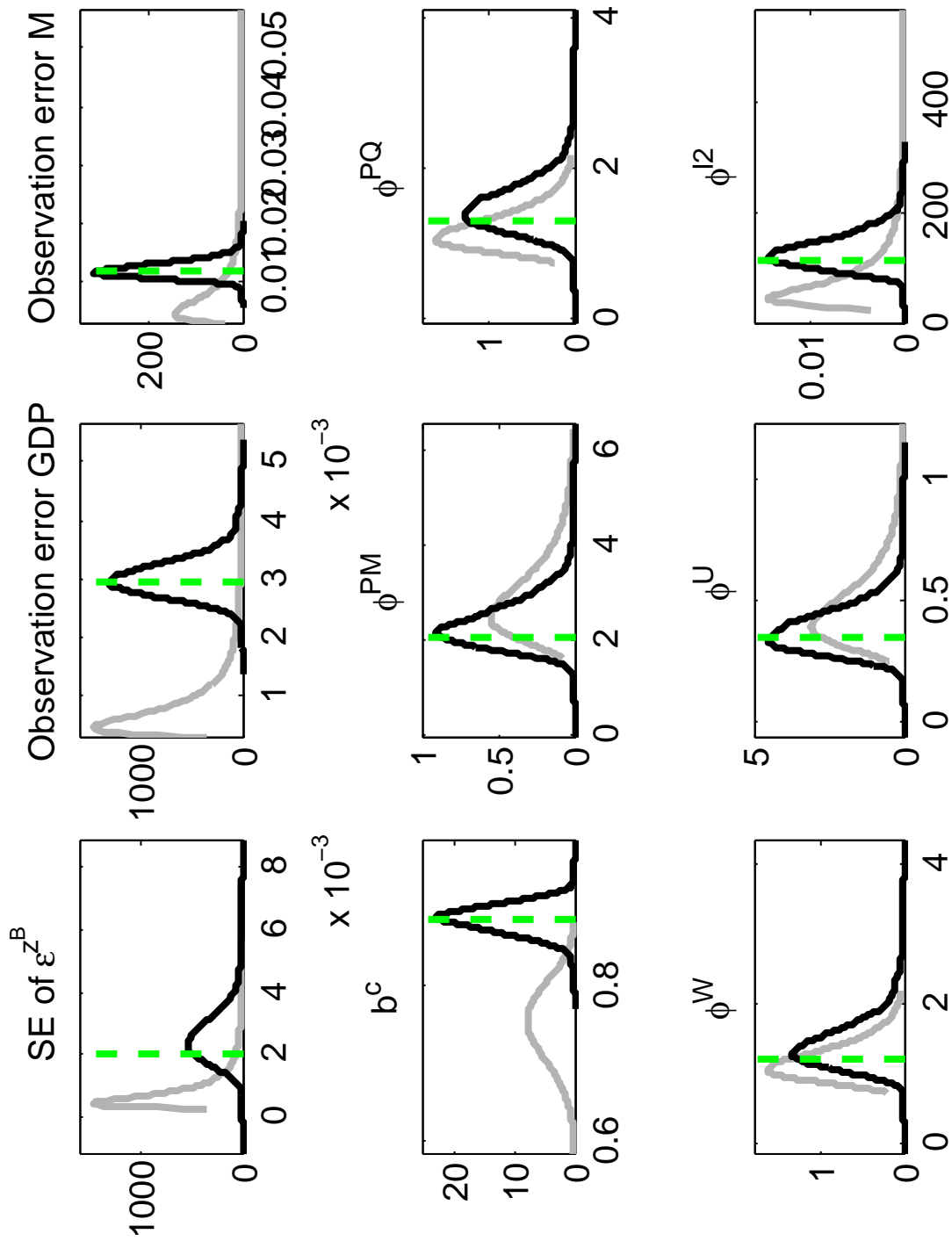

Figure 4: Priors and posteriors

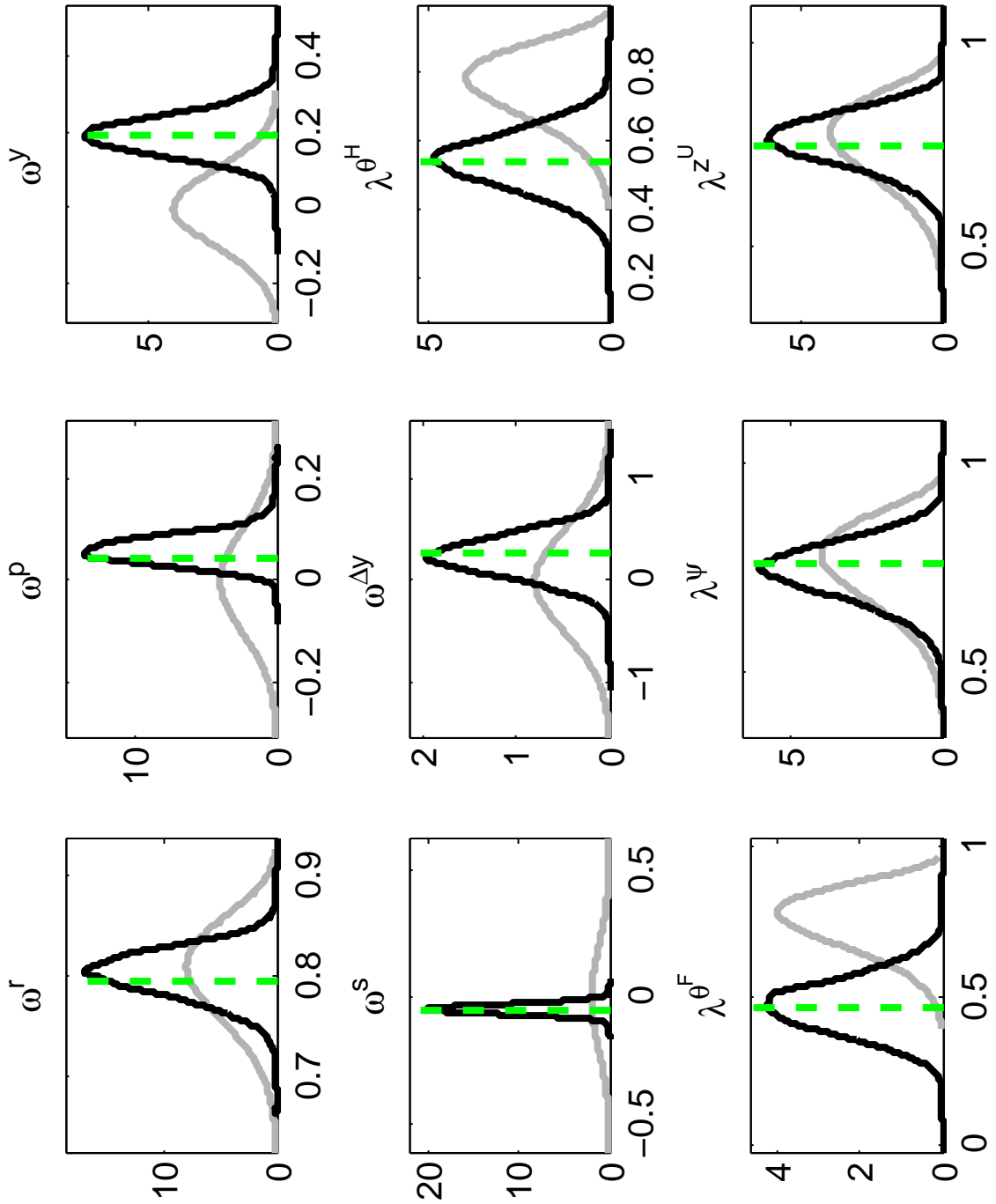

Figure 5: Priors and posteriors for adjustment costs and interest rate reaction function parameters

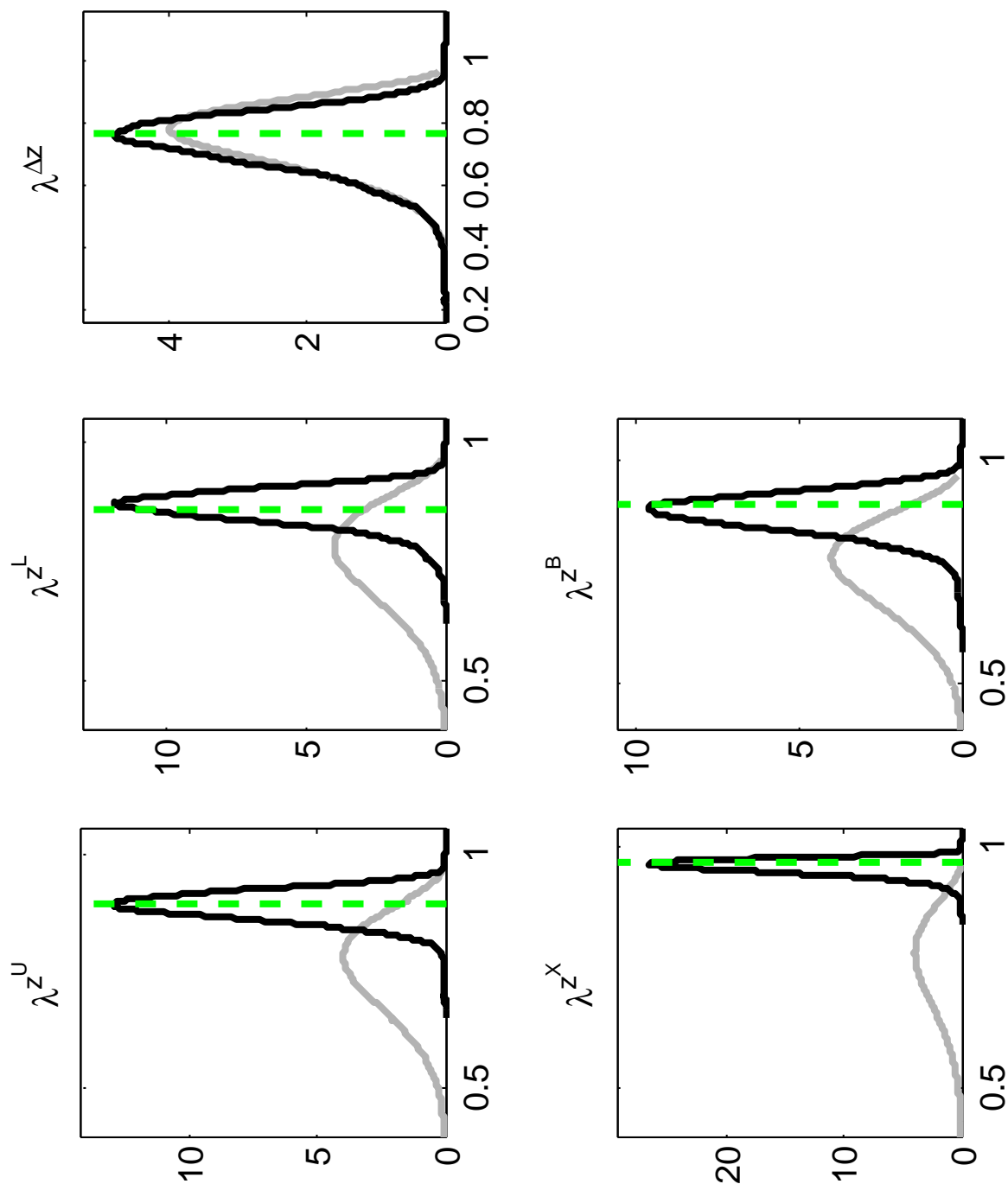

Figure 6: Priors and posteriors for the persistence parameters

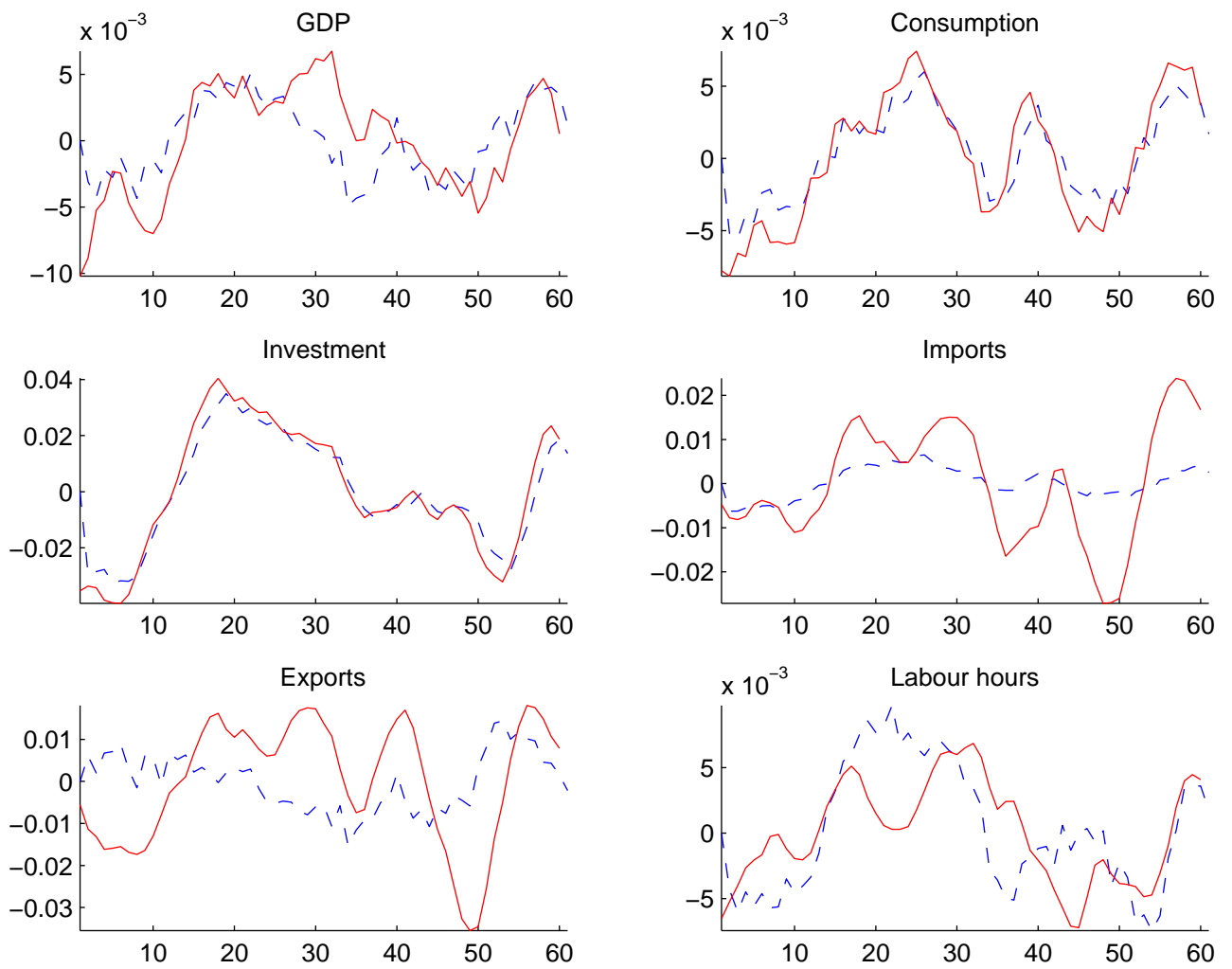

Figure 7: Actual (solid red) and filtered (dashed blue) Norway

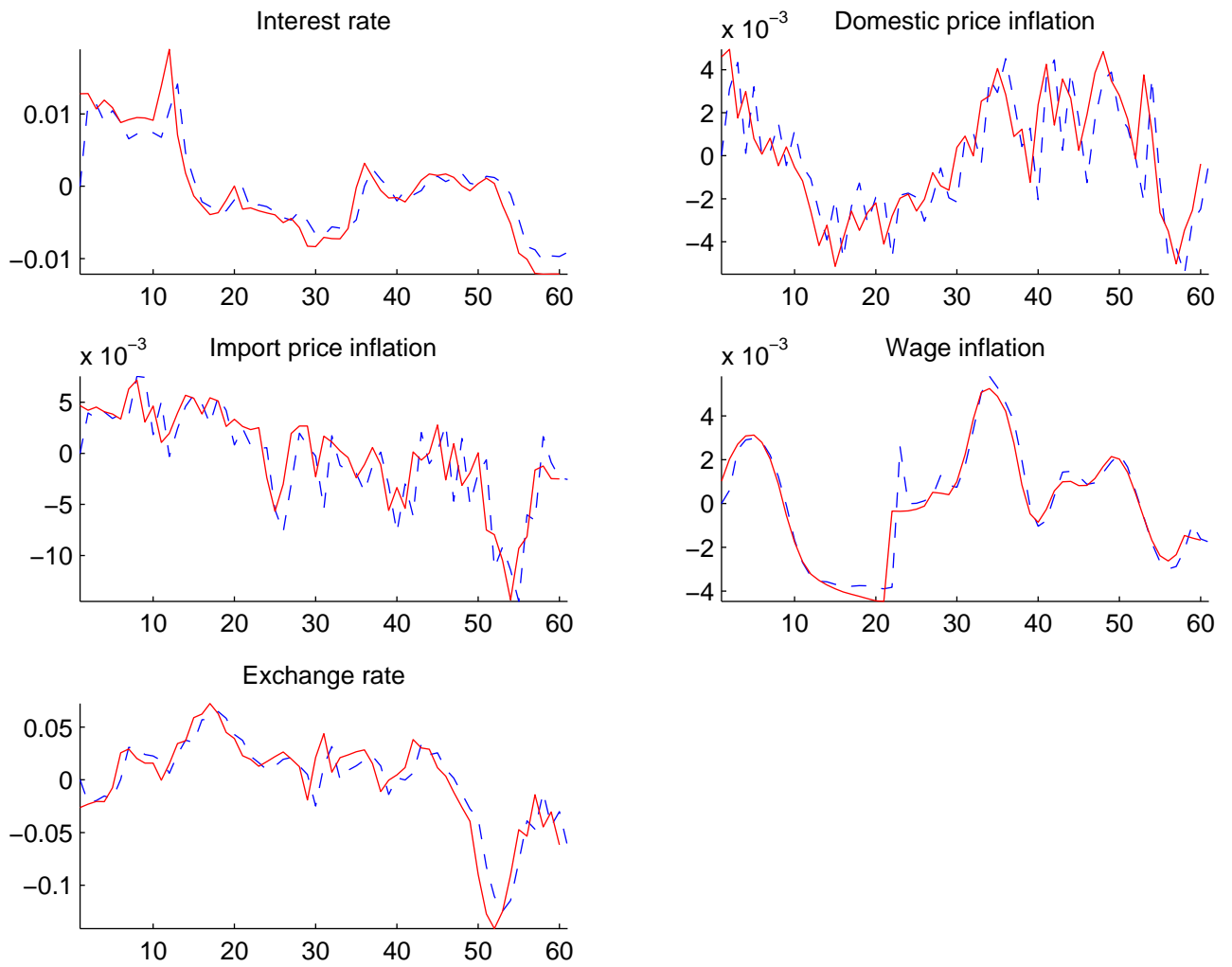

Figure 8: Actual (solid red) and filtered (dashed blue) Norway

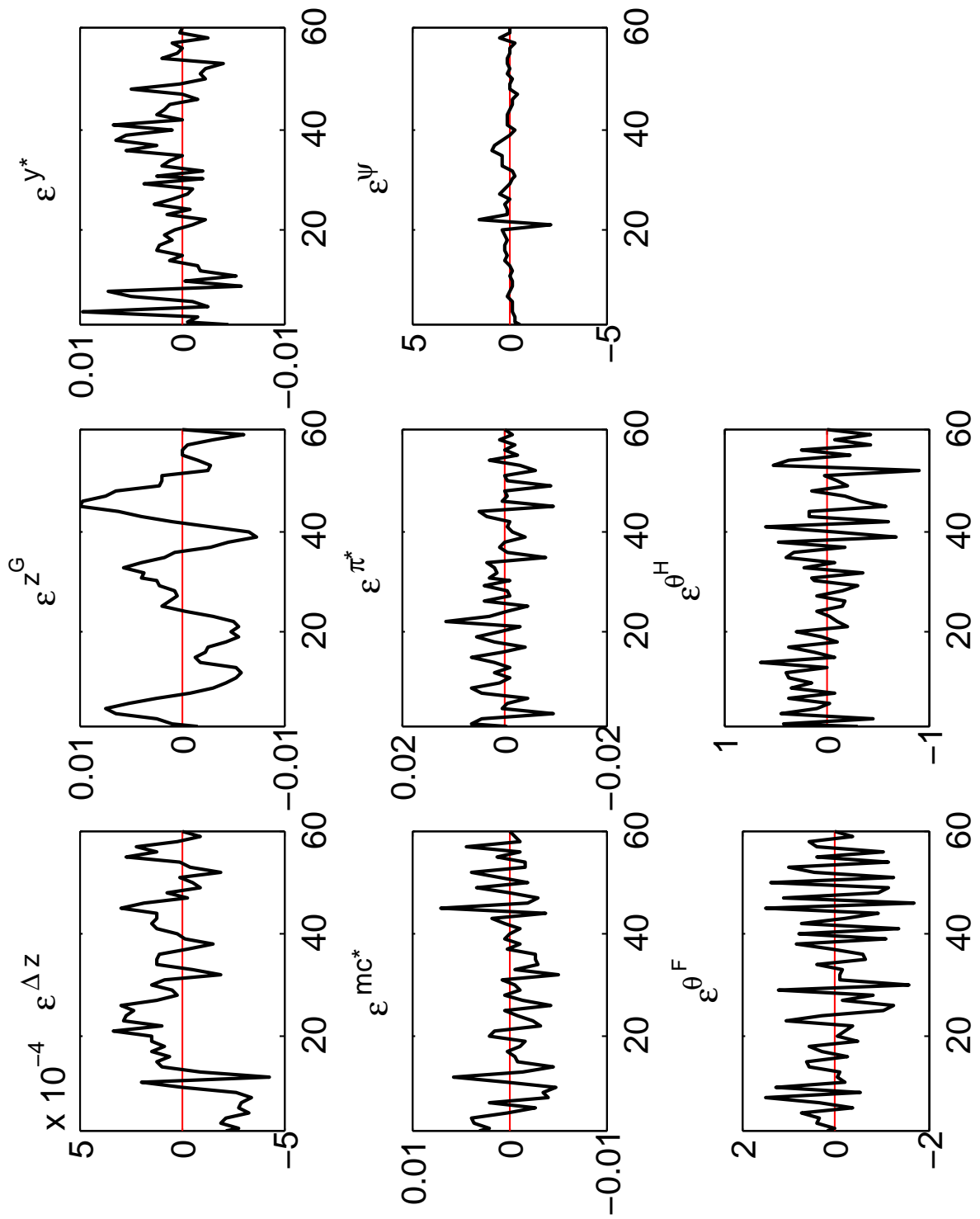

Figure 9: Smoothed innovations

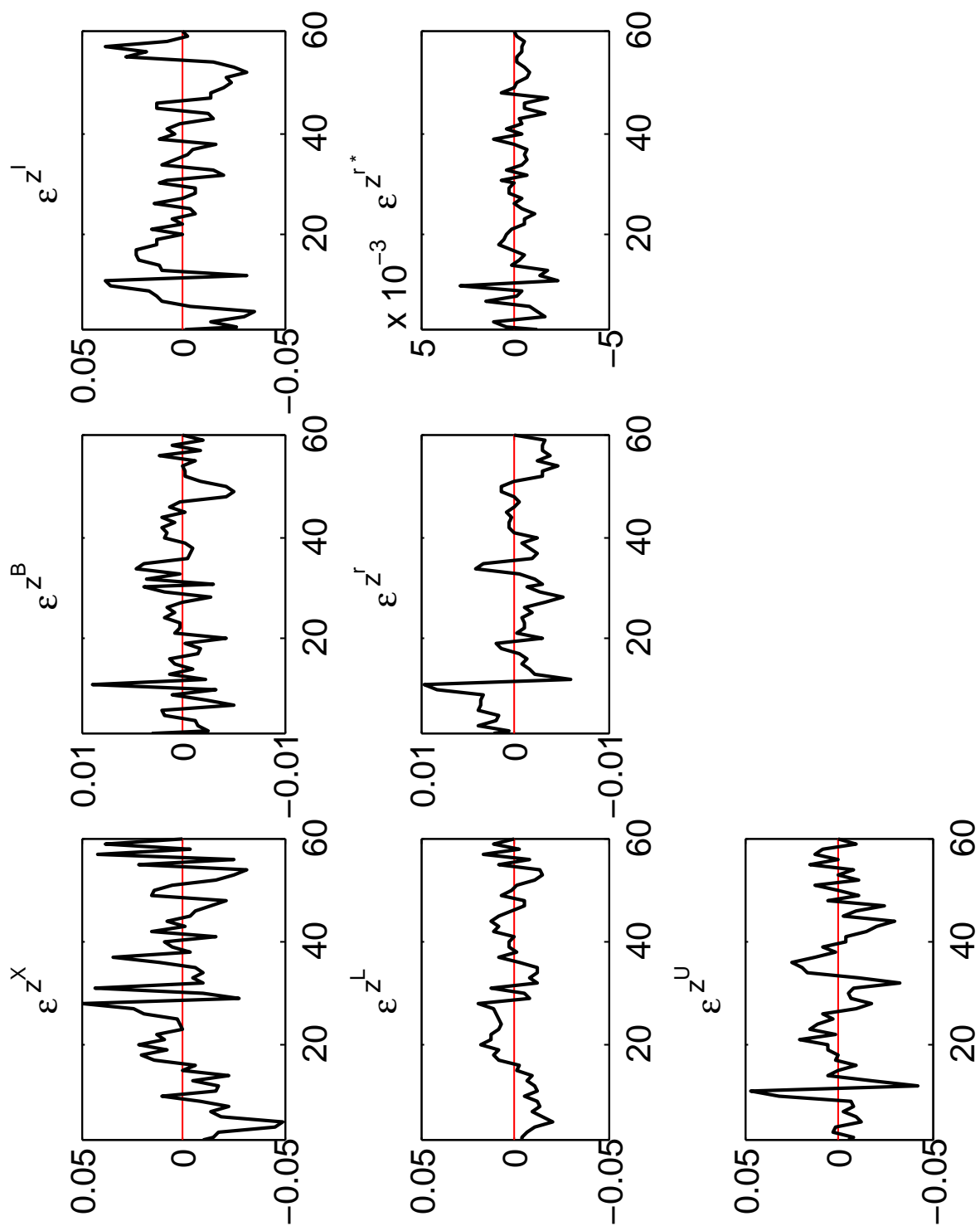

Figure 10: Smoothed innovations

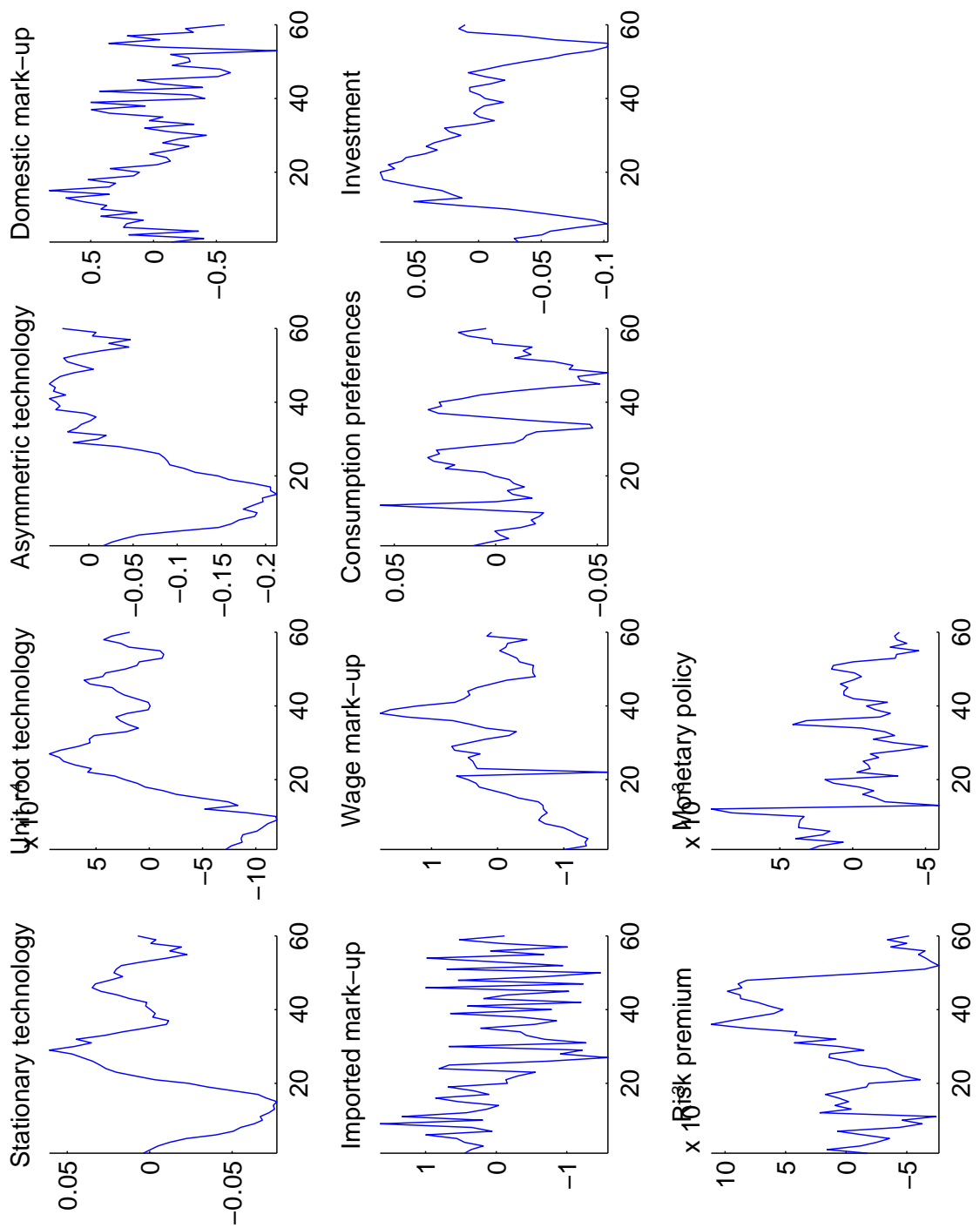

Figure 11: Shock processes

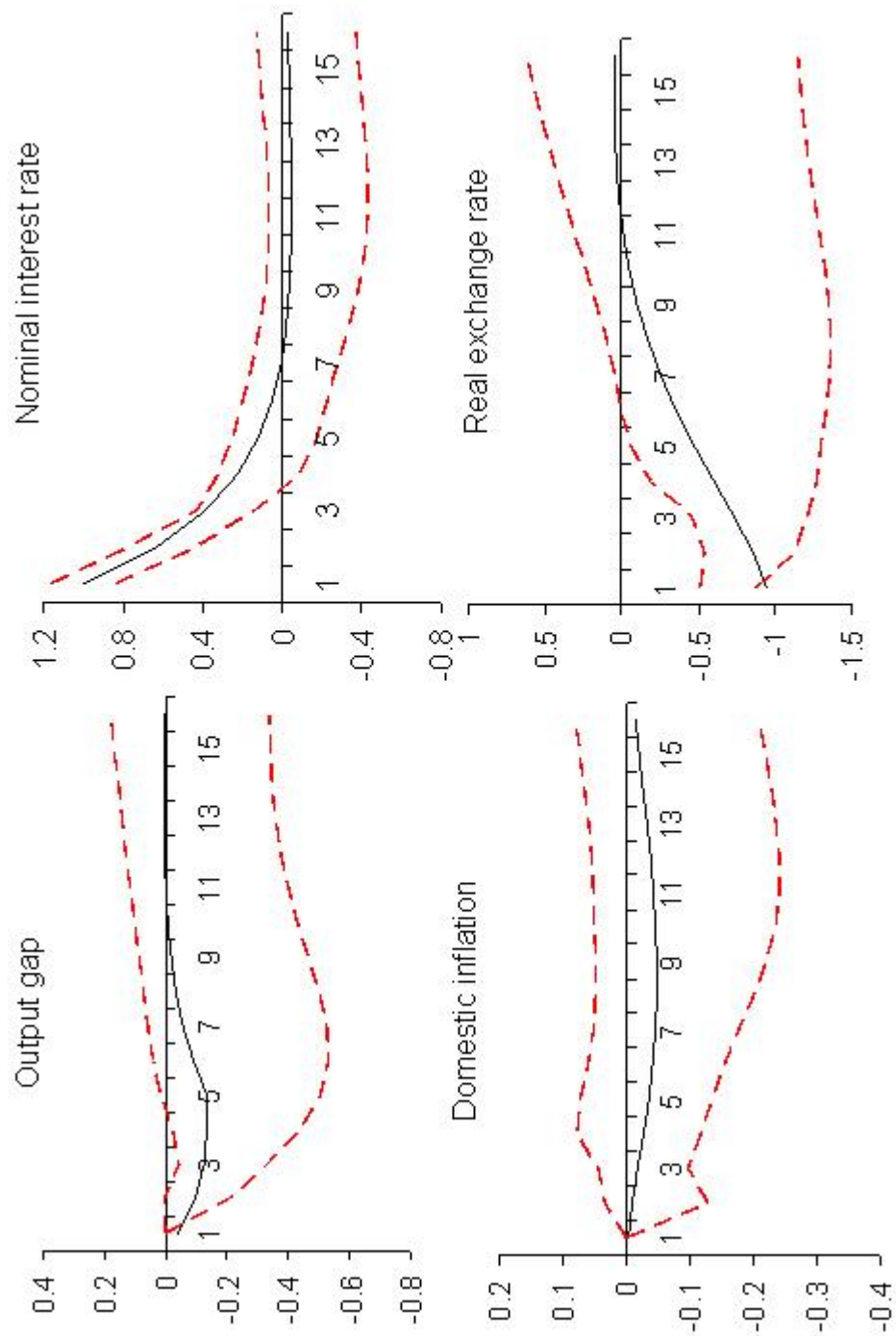

Figure 12: Impulse responses to a monetary policy shock from NEMO (solid) and VAR (dashed) estimated by Bjørnland (2005). Impulse responses for the VAR are illustrated by their 95% confidence interval

A.8 Dynamic responses to shocks

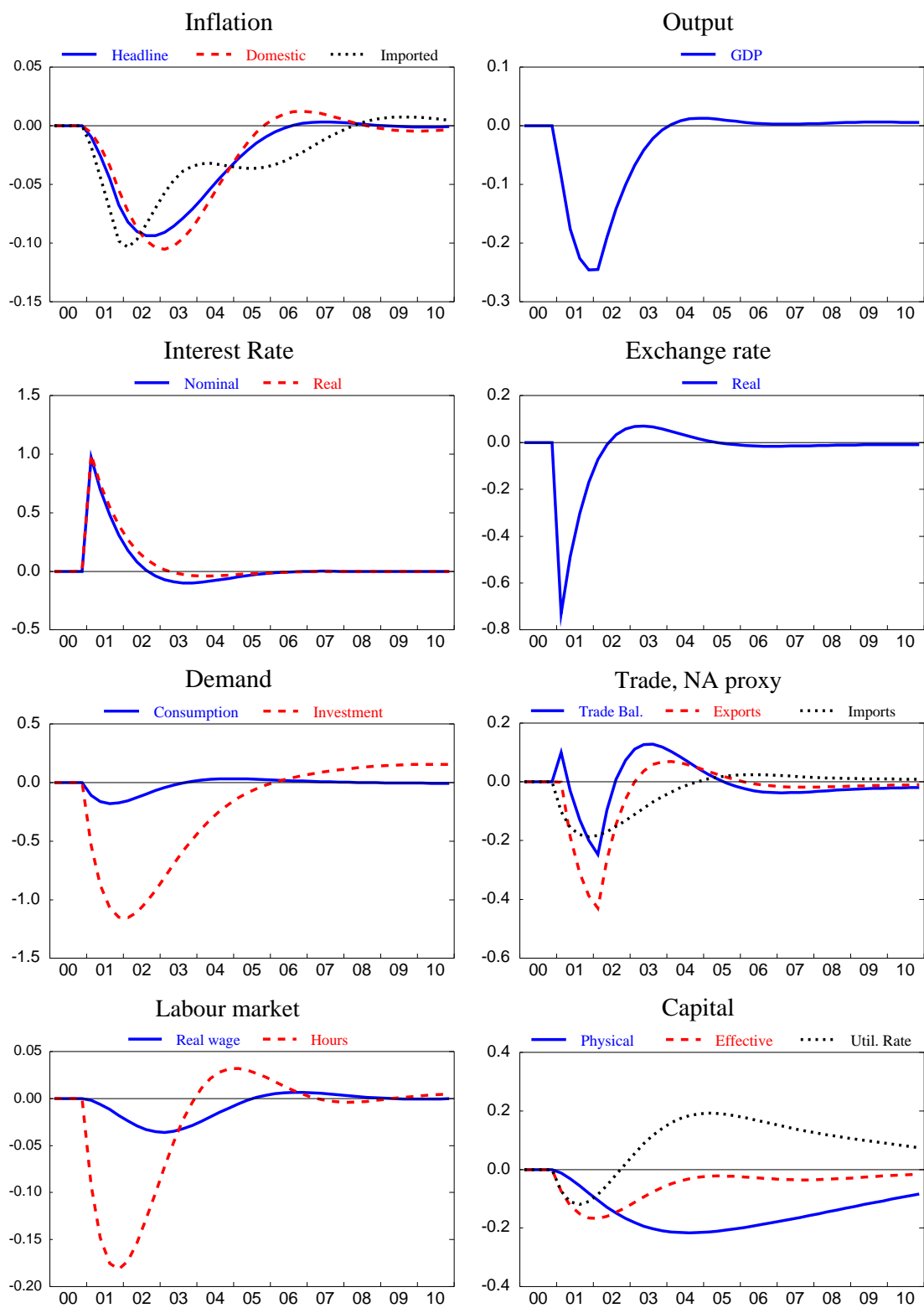

Figure 13: A monetary policy shock

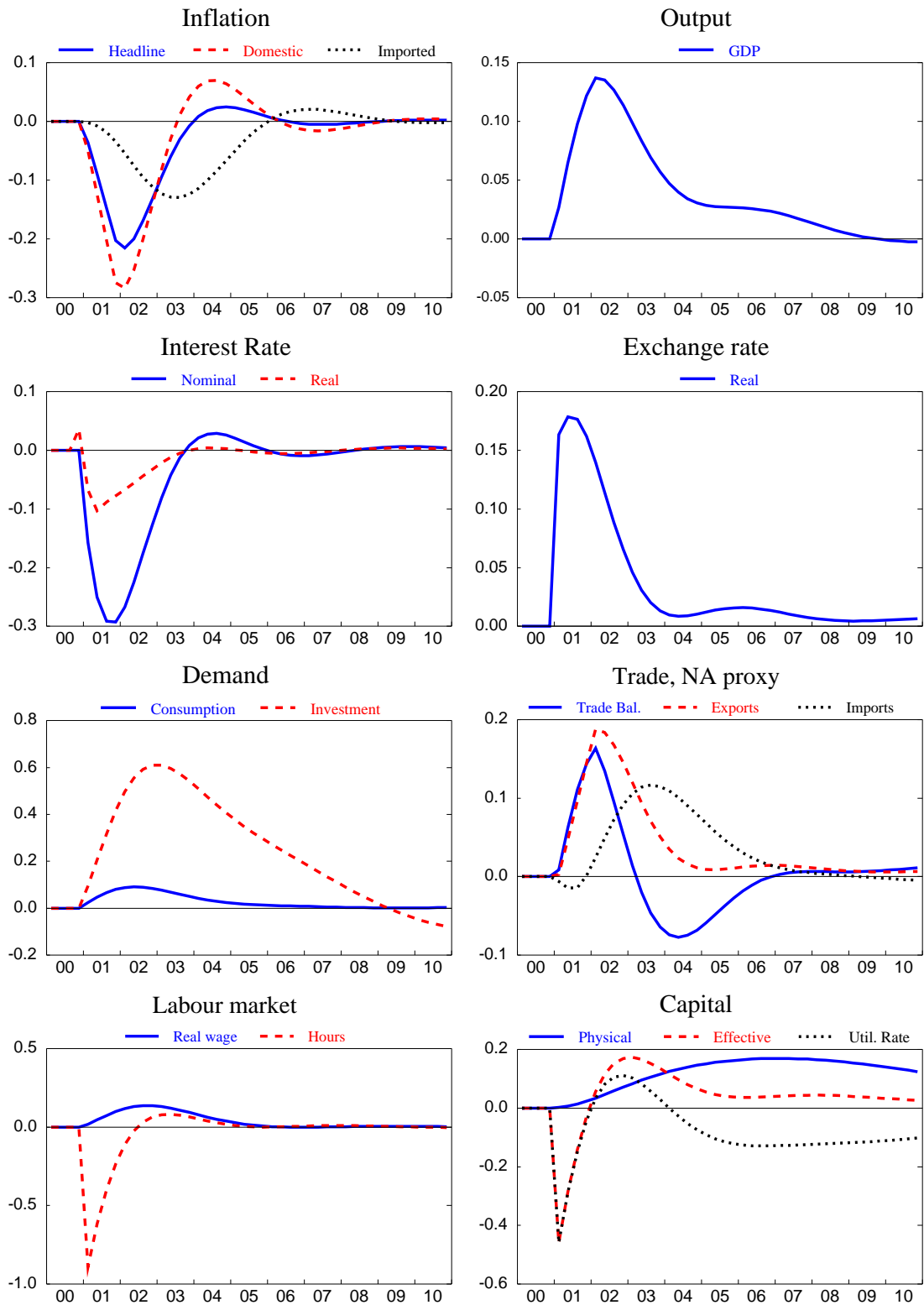

Figure 14: A temporary positive shock to labor augmenting productivity

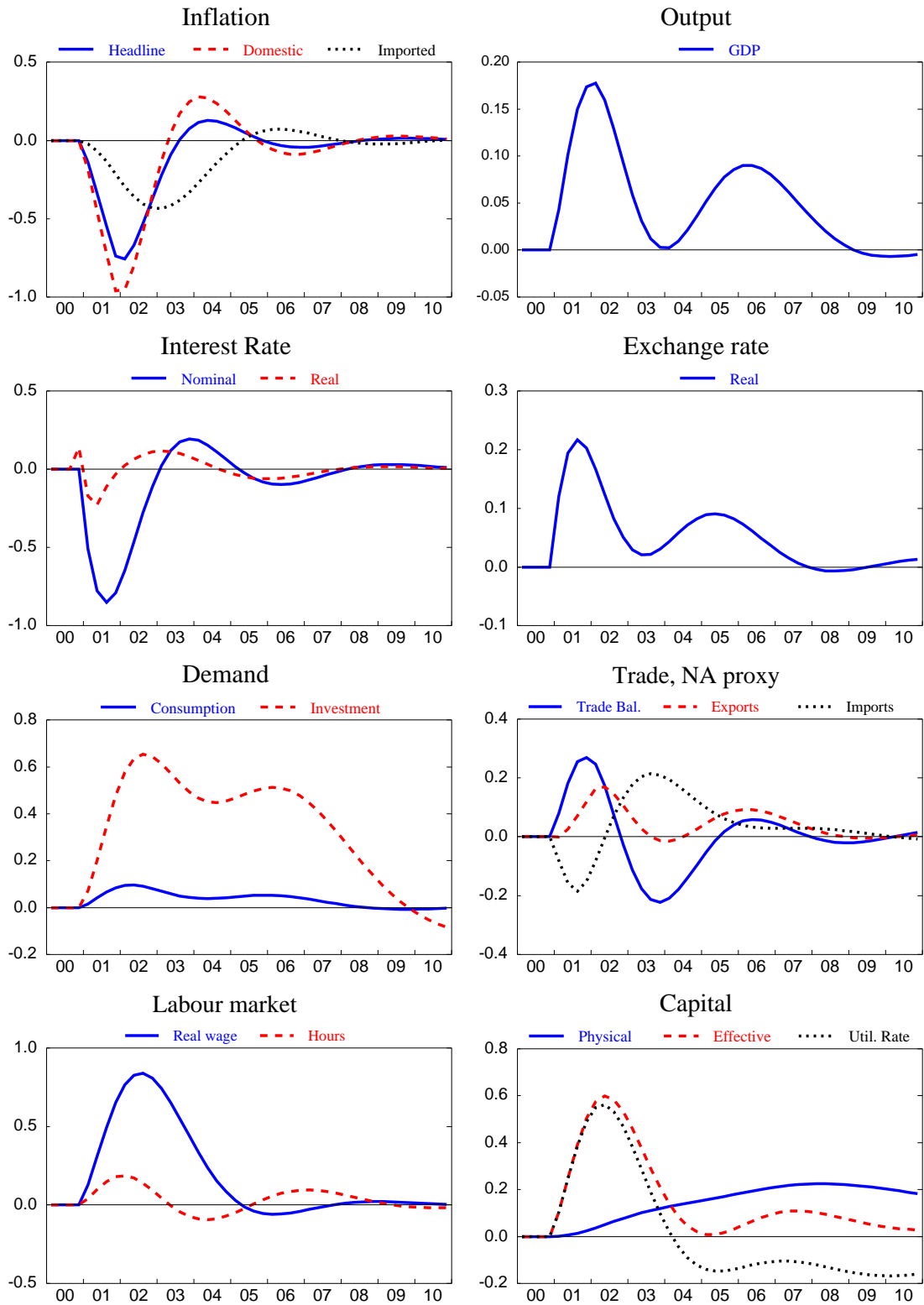

Figure 15: A temporary positive shock to competition in the domestic product market

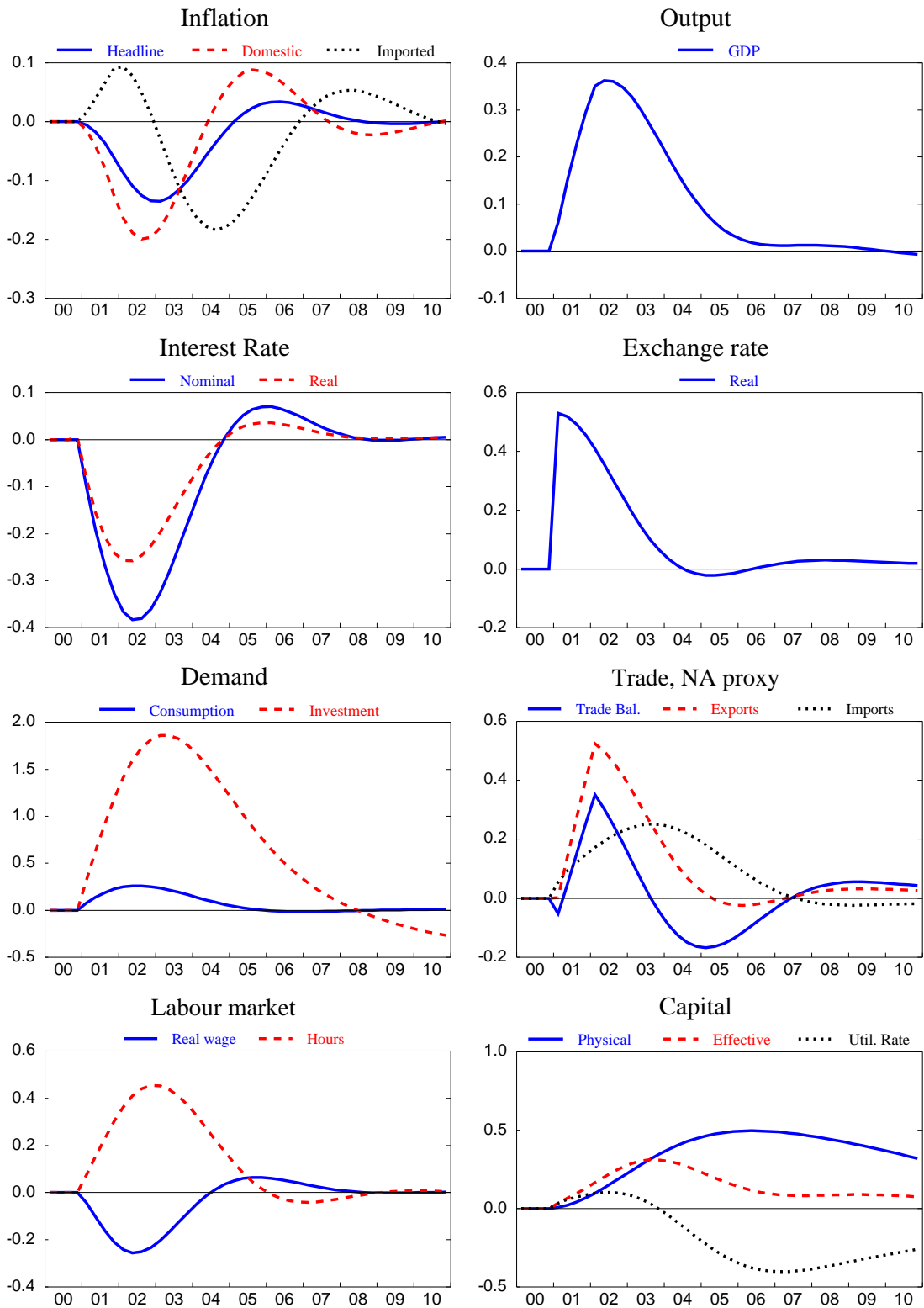

Figure 16: A temporary positive shock to competition in the labor market

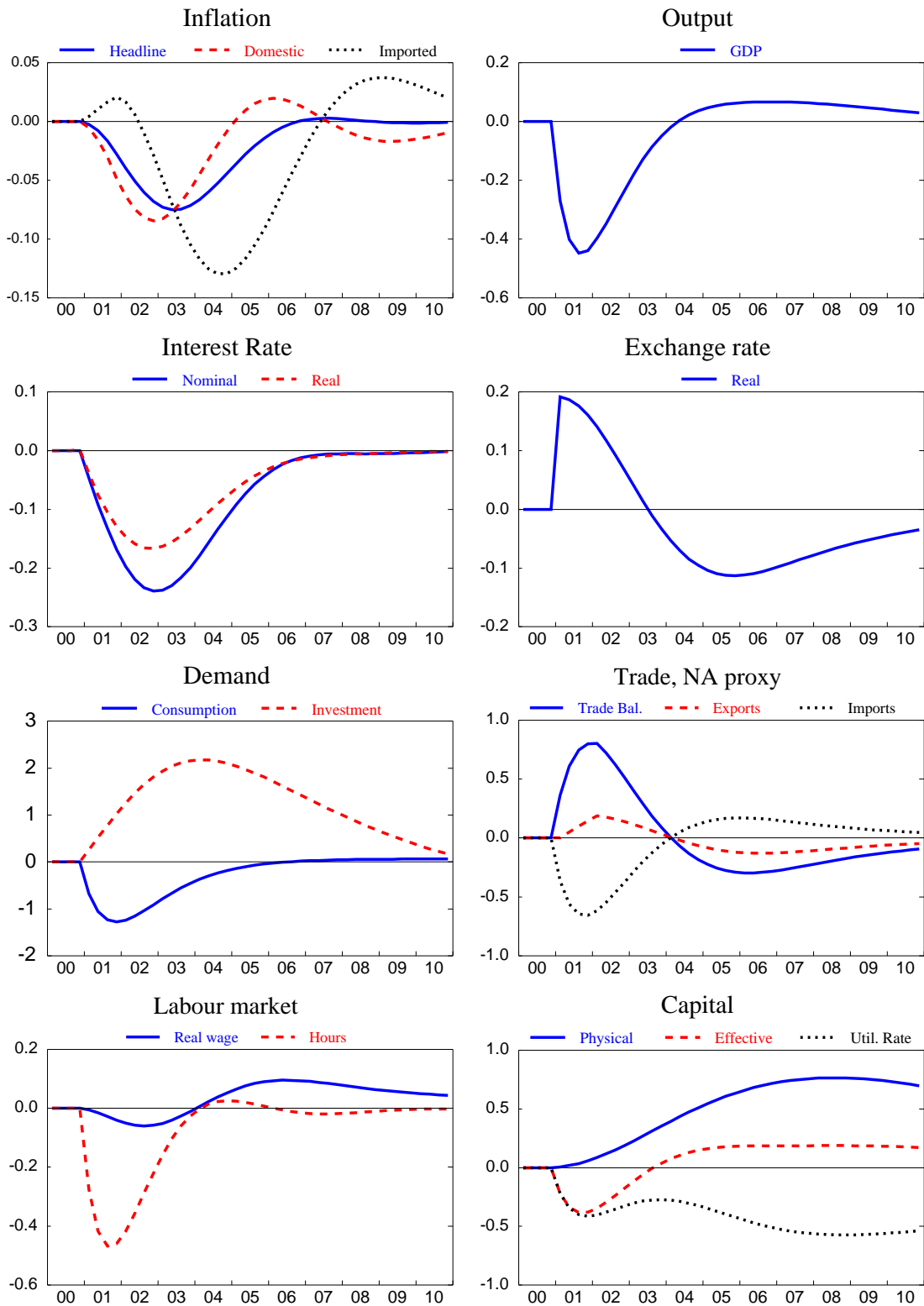

Figure 17: A temporary negative shock to household preferences for consumption

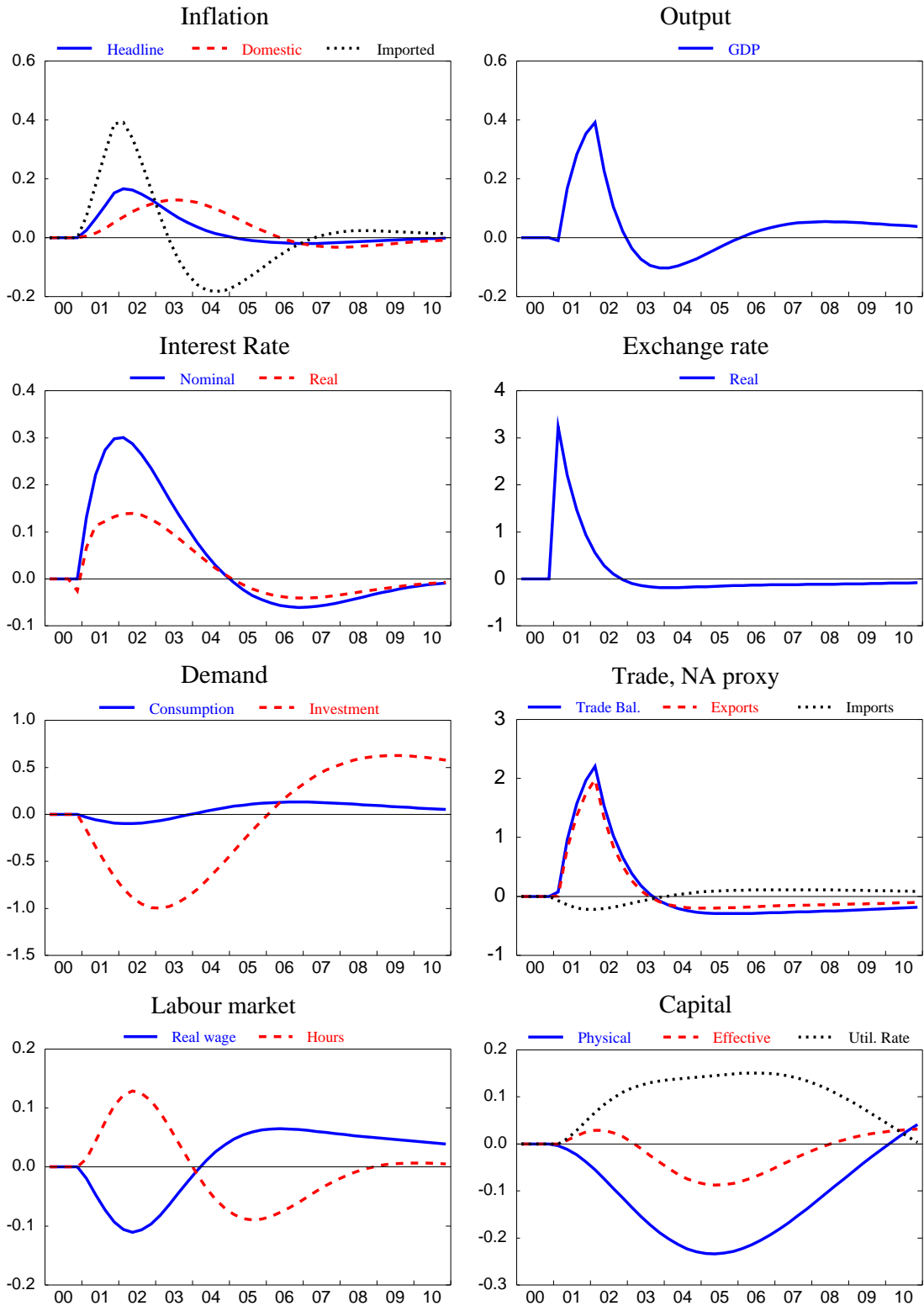

Figure 18: A temporary but persistent increase in the risk premium

