

Sørensen, Lars Bøge

Doctoral Thesis

Risk Management in the Supply Chain

PhD Series, No. 33.2007

Provided in Cooperation with:

Copenhagen Business School (CBS)

Suggested Citation: Sørensen, Lars Bøge (2007) : Risk Management in the Supply Chain, PhD Series, No. 33.2007, ISBN 9788759383421, Copenhagen Business School (CBS), Frederiksberg,
<https://hdl.handle.net/10398/9615>

This Version is available at:

<https://hdl.handle.net/10419/208684>

Standard-Nutzungsbedingungen:

Die Dokumente auf EconStor dürfen zu eigenen wissenschaftlichen Zwecken und zum Privatgebrauch gespeichert und kopiert werden.

Sie dürfen die Dokumente nicht für öffentliche oder kommerzielle Zwecke vervielfältigen, öffentlich ausstellen, öffentlich zugänglich machen, vertreiben oder anderweitig nutzen.

Sofern die Verfasser die Dokumente unter Open-Content-Lizenzen (insbesondere CC-Lizenzen) zur Verfügung gestellt haben sollten, gelten abweichend von diesen Nutzungsbedingungen die in der dort genannten Lizenz gewährten Nutzungsrechte.

Terms of use:

Documents in EconStor may be saved and copied for your personal and scholarly purposes.

You are not to copy documents for public or commercial purposes, to exhibit the documents publicly, to make them publicly available on the internet, or to distribute or otherwise use the documents in public.

If the documents have been made available under an Open Content Licence (especially Creative Commons Licences), you may exercise further usage rights as specified in the indicated licence.



<https://creativecommons.org/licenses/by-nc-nd/3.0/>

Lars Bøge Sørensen

Risk Management in the Supply Chain

**PhD School of Technologies of Managing
CBS / Copenhagen Business School**

PhD Series 33.2007

Lars Bøge Sørensen

Risk Management in the Supply Chain

CBS / COPENHAGEN BUSINESS SCHOOL
PhD School of Technologies of Managing
PhD Series 33.2007

Lars Bøge Sørensen
Risk Management in the Supply Chain
1. edition 2007
PhD Series 33.2007

© The Author

ISBN: 978-87-593-8342-1
ISSN: 0906-6934

Distributed by:

Samfundslitteratur Publishers

Rosenørns Alle 9

DK-1970 Frederiksberg C

Tlf.: +45 38 15 38 80

Fax: +45 35 35 78 22

forlagetsl@sl.cbs.dk

www.samfundslitteratur.dk

All rights reserved.

No parts of this book may be reproduced or transmitted in any form or by any means, electronic or mechanical, including photocopying, recording, or by any information storage or retrieval system, without permission in writing from the publisher.

Risk Management in the Supply Chain

Dissertation

Resume

Bevæggrunden for studiet er en undring over det tilsyneladende fravær på risikostyring ifm. reducere af lagre, afkortning af leveringstider, specialisering, etc. Der opstilles en hypotese om at graden (eller niveauet) af SCM må hænge sammen med niveauet for risikostyring, da et tættere integreret netværk vil resultere i en forholdsmæssigt større konsekvens af en forstyrrelse (Perrow, 1984).

Pilotstudier

Det første trin i afdækning af disse forhold sker i et pilotstudie hvor et antal medlemmer af brancheorganisationen CLM (senere CSCMP) indvilliger i at deltage i en paneldiskussion af deres SCM and risikostyrings-praksis. Dette studie viser, at den grundlæggende SCM model fremsat af Stevens (1989) ikke afspejler de deltagende virksomheders virkelighed, da resultaterne af analysen viser at integration ikke starter indefra. Endnu et pilotstudie gennemføres derfor – med en revideret forskningsramme. Igen viser analysen det samme resultat: Stevens' model afspejler ikke virkeligheden.

Et Eksplorativt Forskningsdesign – og en Risikomatrix

Forskningsdesignet ændres derfor til et mere eksplorativt forskningsdesign, der har til formål at afdække sammenfaldet mellem risikostyring og SCM – empirisk som konceptuelt/teoretisk. I forlængelse af en beskrivelse af de to domæner præsenteres en matrice (Supply Chain Risk Matrix – se Figure 2-14) der forsøger at afgrænse risikostyring ift. de helt specifikke forhold, der gør sig gældende ved ledelse af forsyningskæder. De fire risici indeholdt i matricen (samt logikken i opdelingen i de to akser) forudsættes at være dækkende for risikostyring af forsyningskæder. Der opstilles endvidere en række hypoteser, der senere i afhandlingen styrer udvælgelsen af case-virksomheder.

Litteraturstudier

Første trin i det eksplorative forskningsdesign er gennemførelse af to litteraturstudier.

Det første litteraturstudium afdækker SCM-domænet for bidrag der refererer til Risiko, Usikkerhed, og Sårbarhed (samt bidrag fra risiko-domænet der refererer SCM/Logistik). Bidragene er overvejende a-teoretiske og orienteret mod et større antal emner indenfor domænet. Der identificeres elleve temaer, der efterfølgende illustreres i et Supply Chain Risk Framework (se Figure 3-16).

Det andet litteraturstudium er orienteret mod design af forsyningskæder. Søgning foregår i de samme journaler, men ved brug af en mere effektiv metode – og igen afdækkes et større antal bidrag (se Appendix F). De identificerede, relevante bidrag illustreres igen i et Supply Chain Risk Framework (se Figure 4-2) og der sammenlignes med temaet ”Supply Chain Design” fra det første litteraturstudium (se Figure 4-3 for det endelige resultat). Igen må det konkluderes at det teoretiske indhold er begrænset og ganske smalt da kun Kaos Teori og Transaktionsomkostningsteori er refereret. En analyse af bidragene viser at kun syv artikler har risiko som

design-mål, mens tretten har enten omkostninger eller performance som mål. Overordnet set må det konkluderes at risiko ikke er et dominerende tema indenfor design af forsyningskæder.

Teorianalyse

I forlængelse af litteraturstudierne gennemføres en analyse af de indenfor SCM oftest anvendte teorier: Transaktionsomkostningsteori, Principal/agent Teori, Ressourcebaseret Teori, samt Netværksteori. Analysen omfatter teoriernes anvendelighed på SCM domænet (med fokus på design og analyse) samt anvendelighed ift. håndtering af de fire definerede forsyningskæde-risici. Analysen konkluderer, at alle teorierne hver for sig har svagheder ift. SCM-domænet, men at disse til dels kan imødegås ved foreslåede ”udvidelser” af teorierne. Anvendeligheden ift. håndtering af omtalte forsyningskæde-risici er dog noget mangelfuld da ingen af teorierne adresserer alle fire risici.

Det Empiriske Studium

Der udvælges en convenience sample på ti virksomheder med støtte af en række kriterier. For hvert virksomhed gennemføres en række interviews med personale fra henholdsvis SCM/Logistik og Indkøb. På denne basis udvikles der to konstrukt-hierarkier, én for SCM og én for risikostyring. Ud fra de opstillede hierarkier gennemføres analyse på tværs af virksomhederne. Denne analyse støttes af en værditildeling til omtalte hierarkier med efterfølgende beskrivende analyse. Analysen viser at de kriterier der blev brugt ved udvælgelse af virksomheder stort set ikke beskriver forskelle – og de afvises derfor. Det viser sig dog, at der er en vis sammenhæng mellem den opnåede score for SCM og SCRM. En efterfølgende vurdering af hvorvidt den eksisterende praksis er passende viser at SCM praksisserne for ni af virksomhederne er under fortløbende udvikling og derfor ikke kan vurderes på denne måde. Den manglende modenhed indenfor risikostyring gør spørgsmålet ugyldigt.

Den Videre Forskning

I forlængelse af afdækningen af praksisser indenfor SCM og risikostyring er det blevet åbenlyst at der er behov for en mere sammenhængende ramme for forklaring af begge domæner. Herudover opfattes det som kritisk vigtigt at forstå hvordan kontrakter kan understøtte risikostyring indenfor inter-organisatoriske samarbejder.

Måske mest væsentligt er det at opnå bedre forståelse af hvordan mindre virksomheder kan sikre sig selv ved tvungen outsourcing som det er set i fx Brüel & Kjør og Bang & Olufsen. Når virksomheder tvinges til at flytte værdiskabelse udenfor virksomheden bør det sikrestilles at virksomheden undgår ensidig afhængighed hvor muligt.

Contents

PART I	INTRODUCTION.....	1
Chapter 1	Introduction.....	3
1.1	More SCM → More Supply Chain Risk?.....	5
1.1.1	Testing the Relevance of the Study.....	6
1.2	Re-designing the Study.....	8
1.2.1	Overall Research Objective.....	8
1.2.2	Research Questions.....	10
1.3	Methodology.....	11
1.4	Method Applied – Literature Studies.....	13
1.5	Method Applied – Analysis of Theories.....	15
1.6	Method Applied – Current Practice.....	15
1.7	Overall Research Design.....	20
Chapter 2	SCM & Risk Management.....	23
2.1	The Coming of Supply Chain Management.....	23
2.2	Risk Management.....	30
2.3	Corporate Governance.....	33
2.4	Combining SCM & Risk Management.....	36
2.4.1	Choosing a Perspective on SCM.....	37
2.4.2	Designing for Supply Chain Stability.....	42
2.5	Introducing the Supply Chain Risk Matrix.....	44
PART II	LITERATURE AND THEORY REVIEWS.....	47
Chapter 3	Risk, Vulnerability, and Uncertainty.....	49
3.1	Research Methodology.....	49
3.2	Results.....	50
3.2.1	Categories: Term & Phase.....	51
3.2.2	Categories: Orientation & Level.....	52
3.2.3	Category: Research Method.....	52
3.2.4	Category: Explicitly Referencing Theory.....	52
3.3	Themes.....	52
3.3.1	Theme: Securing the Supply Chain.....	53
3.3.2	Theme: Supply Management.....	55
3.3.3	Theme: Supply Chain Design.....	66
3.3.4	Theme: Risk Management in Supply Chains.....	71
3.4	Conclusion.....	77
3.5	Epilogue: SCM in the Risk Domain.....	78
Chapter 4	Supply Chain Design.....	79
4.1	Research Methodology.....	79
4.2	Results.....	80
4.2.1	Categories: Design Object & Orientation.....	81
4.2.2	Category: Research Method.....	81
4.2.3	Category: Explicit Theory.....	81
4.2.4	Subject Area and Design Objective(s).....	82
4.2.5	Reference to Risk/Uncertainty.....	84
4.2.6	Conclusion.....	86
4.3	Comparing With Theme ‘Supply Chain Design’.....	86
4.3.1	Conclusion.....	88

Contents (cont'd)

4.4	Comparing with Classic Articles	88
4.5	Conclusion	91
Chapter 5	Supply Chain Theories and Risk.....	93
5.1	Transaction Cost Economics (TCE)	95
5.1.1	TCE and SCM	109
5.1.2	Contributions Referencing TCE	115
5.1.3	TCE and the Supply Chain Risks	117
5.2	Principal-agent Theory (P/A)	118
5.2.1	P/A Theory and SCM	121
5.2.2	Contributions Referencing P/A Theory	123
5.2.3	P/A Theory and Supply Chain Risks	124
5.3	Resource Based Theory (RBT).....	125
5.3.1	RBT and SCM	133
5.3.2	Contributions Referencing RBT	135
5.3.3	RBT and Supply Chain Risks	135
5.4	The Interaction Approach (IA)	136
5.4.1	IA and SCM.....	143
5.4.2	Contributions Referencing IA	144
5.4.3	IA and Supply Chain Risks	144
5.5	Conclusions	148
5.5.1	The Frameworks and SCM.....	148
5.5.2	Intentional Disruptions and Exits	149
5.5.3	Unintentional Disruptions and Exits.....	151
5.5.4	Overall Conclusion	152
PART III	EMPIRICAL INVESTIGATIONS	155
Chapter 6	Case Study Design.....	157
6.1	Theory (Development)	157
6.1.1	Constructs for SCM	159
6.1.2	Constructs for SCRM	163
6.2	Case Selection.....	165
6.2.1	External Conditions (for SCM and SCRM)	165
6.2.2	Case Selection Method	167
6.2.3	Learning Points.....	169
6.3	Design of Data Collection Protocol.....	171
6.4	Documenting the Cases	172
Chapter 7	Case Studies	173
7.1	Bang & Olufsen A/S	174
7.2	Brüel & Kjær Sound and Vibration Measurement a/s.....	189
7.3	Coloplast A/S.....	200
7.4	Dyrup a/s.....	210
7.5	Fritz Hansen a/s	221
7.6	LINAK A/S.....	233
7.7	Novozymes a/s.....	247
7.8	Oticon a/s	256
7.9	RIEGENS a/s	269
7.10	SDC DANDISC A/S	278

Contents (cont'd)

Chapter 8	Cross-case Analysis.....	289
8.1	Evaluating SCM Practices by Constructs	289
8.1.1	Construct ‘Supply Chain Organization’	289
8.1.2	Construct ‘Process Orientation’	293
8.1.3	Construct ‘Production Philosophy’	297
8.1.4	Construct ‘IT Support’	301
8.1.5	Construct ‘External Integration’	307
8.1.6	Construct ‘Inter-organizational Management’	310
8.1.7	Developing 2 nd Level Constructs	313
8.1.8	Evaluating SCM Practices.....	315
8.2	Evaluating SCRM Practices by Constructs.....	318
8.2.1	Construct ‘Risk Management Organization’	318
8.2.2	Construct ‘Risk Types and Management Effort’	320
8.2.3	Construct ‘Risk Identification and Assessment’	324
8.2.4	Construct ‘Supplier Risk Management’	326
8.2.5	Developing 2 nd Level Constructs	327
8.2.6	Evaluating SCRM Practices.....	328
8.3	SCM versus SCRM Practices.....	331
8.3.1	Appropriateness.....	333
8.4	Conclusions	337
8.5	Epilogue... ..	338
8.5.1	Triangulation I: External Reporting	338
8.5.2	Triangulation II: Financial Department / Staff Perspective	341
8.5.3	Conclusion.....	345
PART IV	CONTRIBUTIONS, CONCLUSIONS, CONCERNS... ..	347
Chapter 9	Contributions, Conclusions, Concerns... ..	349
9.1	Contributions and Conclusions	349
9.1.1	The Pilot Studies	349
9.1.2	The Conceptualization	349
9.1.3	The Literature Studies	350
9.1.4	The Review of the SCM Theories.....	353
9.1.5	The Empirical Investigations	355
9.1.6	Policy Implications / Modification to Theory	358
9.2	Concerns.....	359
9.2.1	Concerns on Assumptions.....	359
9.2.2	Concerns on Literature Reviews	360
9.2.3	Concerns on Empirical Research Design	360
9.3	Future Research.....	361

List of Tables

Table 1-1:	Journals Defining the SCM/Logistics Domain	14
Table 1-2:	Journals Defining the Risk Domain	14
Table 1-3:	E-databases Available	15
Table 2-1:	Identified Supply Chain Management Components	27
Table 2-2:	Re-inventing Risk Management	32
Table 3-1:	Risk Management Strategies in Theme “Securing the Supply Chain”	54
Table 3-2:	Risk Management Strategies in Theme “Supply Management”	66
Table 3-3:	Risk Management Strategies in Theme “Supply Chain Design”	71
Table 3-4:	Summary of Risk Management Lessons.....	76
Table 3-5:	Risk Management Strategies in Theme “Supply Chain Risk Management”	76
Table 4-1:	Further Classification of Articles on Supply Chain Design.....	82
Table 4-2:	Grouping articles on Supply Chain Design by Subject Area.....	83
Table 4-3:	Extracts from Appendix D	87
Table 4-4:	Articles Classified According to Design Objective(s).....	87
Table 5-1:	Distinguishing Attributes of Market, Hybrid, and Hierarchy Governance Structures	99
Table 5-2:	Comparison of assumptions (Agency vs. Organizational perspectives).....	120
Table 5-3:	Variables in Agency Models.....	121
Table 5-4:	Prior Research on Supply Risk	123
Table 5-5:	Assumptions of the Two Schools of Resource-Based Theory.....	129
Table 5-6:	Attributes of the Two Resource-Based Models	129
Table 6-1:	Dimensions of different levels of CPFR.....	161
Table 6-2:	Collaboration Model	162
Table 6-3:	SCM Constructs	163
Table 6-4:	SCRM Constructs	165
Table 6-5:	The Danish Logistics Award	168
Table 6-6:	The Post Denmark Supply Chain Award.....	168
Table 6-7:	Classification for Size	169
Table 6-8:	External Conditions per Supply Chain	170
Table 6-9:	External Conditions per Company.....	170
Table 6-10:	Application of Interview Guides.....	172
Table 7-1:	Financial Profile – Bang & Olufsen A/S	175
Table 7-2:	Financial Profile – Brüel & Kjør Sound & Vibration Measurement A/S	191
Table 7-3:	Milestones – Coloplast A/S	200
Table 7-4:	Financial Profile – Coloplast A/S	201
Table 7-5:	Revenue by Business Activities.....	202
Table 7-6:	Market Share.....	202
Table 7-7:	Revenue by Market.....	203
Table 7-8:	Milestones – Dyrup A/S.....	210
Table 7-9:	Financial Profile – Dyrup A/S	211
Table 7-10:	Financial Profile – Fritz Hansen a/s.....	229
Table 7-11:	Milestones – LINAK A/S	234
Table 7-12:	LINAK’s Product Divisions	235
Table 7-13:	Financial Profile – LINAK A/S	238
Table 7-14:	Milestones – Novozymes a/s	247
Table 7-15:	Financial Profile – Novozymes A/S	248
Table 7-16:	Market situation for Novozymes a/s.....	251
Table 7-17:	Milestones – Oticon a/s.....	256
Table 7-18:	Financial Profile – Oticon A/S.....	259

List of Tables (cont'd)

Table 7-19:	Financial Profile – RIEGENS a/s	272
Table 7-20:	Milestones – SDC DANDISC A/S	278
Table 7-21:	Financial Profile – SDC DANDISC A/S	281
Table 8-1:	Summary of ‘Supply Chain Organization’	291
Table 8-2:	Coverage of the Fulfillment Meta-process	292
Table 8-3:	Summary of ‘Process Orientation’	294
Table 8-4:	Categorization of Processes.....	295
Table 8-5:	Summary of ‘Production Philosophy’	299
Table 8-6:	Production Philosophies for Recurrent Transactions	300
Table 8-7:	Summary of ‘IT Support’	302
Table 8-8:	SCM, Process Orientation, and ERP.....	304
Table 8-9:	IT Support for Interfaces	306
Table 8-10:	Coupling of IT Systems.....	307
Table 8-11:	Summary of ‘Relationship Length’	308
Table 8-12:	Summary of ‘Collaboration’	310
Table 8-13:	Summary of ‘Inter-organizational Management’	311
Table 8-14:	Summary of Sub-constructs for ‘Inter-org. Mgmt.’	313
Table 8-15:	The ‘Supply Chain Management Practice’ Construct.....	314
Table 8-16:	Coding of 2 nd Level SCM Constructs.....	315
Table 8-17:	Ratings for SCM Constructs.....	315
Table 8-18:	Scores for SCM Constructs (Level 1)	316
Table 8-19:	Summary of ‘Risk Management Organization’	320
Table 8-20:	Summary of ‘Risk Types and Management Effort’	322
Table 8-21:	Summary of ‘Risk Identification and Assessment’	325
Table 8-22:	Summary of ‘Supplier Segmentation’	326
Table 8-23:	Summary of ‘Supplier Audits’	327
Table 8-24:	The ‘Supply Chain Risk Management’ Construct	328
Table 8-25:	Coding of 2 nd Level SCRM Constructs.....	328
Table 8-26:	Ratings for SCRM Constructs.....	329
Table 8-27:	Scores for SCRM Constructs	330
Table 8-28:	Summary of ‘External Reporting’	340

List of Figures

Figure 1-1:	Impact of Failure vs. Degree of Redundancy	5
Figure 1-2:	Methodology	11
Figure 1-3:	Methodological Approaches	12
Figure 1-4:	Research Design.....	20
Figure 1-5:	Structure of the Dissertation	21
Figure 2-1:	Achieving an Integrated Supply Chain	24
Figure 2-2:	A Framework of Supply Chain Management	26
Figure 2-3:	Chronology of influences on SCM	29
Figure 2-4:	The (Business) Risk Management Process	33
Figure 2-5:	The Supply Chain Complexity Triangle	37
Figure 2-6:	The Innovation Perspective.....	39
Figure 2-7:	The Generic Value Chain.....	40
Figure 2-8:	The Fulfillment Perspective	40
Figure 2-9:	Supply Chain Process Model	41
Figure 2-10:	Performance objectives... ..	43
Figure 2-11:	The Supply Chain Risk Matrix	45
Figure 3-1:	Supply Chain Risk Framework.....	49
Figure 3-2:	Risk Assessment and Contingency Planning.....	56
Figure 3-3:	Vertical integration decisions associated with combinations of strategic risk and buyer qualification	58
Figure 3-4:	A risk/benefit framework for industrial buying.....	60
Figure 3-5:	A risk management model for outsourcing.....	61
Figure 3-6:	Ericsson’s approach to Supply Chain Risk Management	63
Figure 3-7:	Risk assessment framework.....	64
Figure 3-8:	Risk management process in network environment	64
Figure 3-9:	The Global Supply Chain Design Process	67
Figure 3-10:	Maturity and Uncertainty Levels	68
Figure 3-11:	Removing Uncertainties in a Particular Pattern.....	69
Figure 3-12:	The Uncertainty Reduction Strategies	70
Figure 3-13:	Matched Strategies.....	70
Figure 3-14:	Risk and chance management process	73
Figure 3-15:	The Risk Spiral	74
Figure 3-16:	Themes Identified	77
Figure 4-1:	Supply Chain Risk Framework.....	79
Figure 4-2:	Articles on Supply Chain Design.....	85
Figure 4-3:	Articles on Supply Chain Design (& Risk/Uncertainty).....	88
Figure 4-4:	Partnership Component Levels	90
Figure 5-1:	Supply Chain Risk Framework.....	94
Figure 5-2:	Efficient Governance	97
Figure 5-3:	Simple Contracting Schema.....	102
Figure 5-4:	The impact of uncertainty on governance structure.....	104
Figure 5-5:	Organization form responses to changes in frequency	105
Figure 5-6:	Models of Opportunistic Behavior.....	107
Figure 5-7:	SCM and the Governance Structures	114
Figure 5-8:	Shifts in Governance Structure	115
Figure 5-9:	The cornerstone of competitive advantage	128
Figure 5-10:	A Resource-Based Approach to Strategy Analysis: A Practical Framework .	131
Figure 5-11:	Competencies, capabilities and strategic hierarchy	132
Figure 5-12:	An Inter-organizational RBT Model.....	134

List of Figures (cont'd)

Figure 5-13:	The Interaction Model (overview)	137
Figure 5-14:	The Interaction Model (full).....	138
Figure 5-15:	The ARA Model.....	140
Figure 5-16:	The Development of Buyer/Seller Relationships in Industrial Markets - Summary	142
Figure 5-17:	Types and Sources of Uncertainties in Relationships	146
Figure 5-18:	Risk Management Schema for Network Membership Classes	147
Figure 5-19:	Management of Intentional Supply Chain Risks.....	150
Figure 5-20:	Management of Unintentional Supply Chain Risks	152
Figure 6-1:	Case Study Method	157
Figure 6-2:	(An Iterative) Case Selection Method	167
Figure 7-1:	Organization Chart – Bang & Olufsen Group.....	177
Figure 7-2:	Bang & Olufsen's Supplier Segmentation Model	178
Figure 7-3:	Bang & Olufsen's Basic Risk Assessment Questions.....	181
Figure 7-4:	Bang & Olufsen – Supply Chain Concept.....	184
Figure 7-5:	Supply Chain Diagram – Bang & Olufsen.....	185
Figure 7-6:	Organization Chart – Brüel & Kjær	190
Figure 7-7:	Supply Chain Diagram – Brüel & Kjær	197
Figure 7-8:	Coloplast Group Structure.....	203
Figure 7-9:	Coloplast SCM Organization	204
Figure 7-10:	Supply Chain Diagram – Coloplast.....	207
Figure 7-11:	Dyrup's Group Structure	213
Figure 7-12:	Supply Chain Diagram – Dyrup.....	216
Figure 7-13:	Organization Chart – Dyrup.....	217
Figure 7-14:	Goals for Fritz Hansen's LEAN project	222
Figure 7-15:	Organization Chart – Fritz Hansen.....	228
Figure 7-16:	Supply Chain Diagram – Fritz Hansen.....	230
Figure 7-17:	Organization Chart (SCM) – Fritz Hansen.....	231
Figure 7-18:	Legal Structure – LINAK.....	237
Figure 7-19:	Supplier Performance Metrics – LINAK	243
Figure 7-20:	Supply Chain Diagram – LINAK.....	244
Figure 7-21:	Organization Chart – Novozymes	252
Figure 7-22:	Supply Chain Diagram – Novozymes	253
Figure 7-23:	Overall Structure of William Demant Holding	258
Figure 7-24:	Generic Product for Oticon	261
Figure 7-25:	Oticon's Generic Production Process (BTE)	263
Figure 7-26:	Supply Chain Diagram – Oticon a/s (BTE).....	267
Figure 7-27:	RIEGENS Group Structure	270
Figure 7-28:	Organization Chart – RIEGENS	271
Figure 7-29:	Supply Chain Diagram – RIEGENS	276
Figure 7-30:	SDC VALUE CHAIN	279
Figure 7-31:	Business Cycle for the Media Industry	283
Figure 7-32:	Supply Chain Diagram – SDC DANDISC A/S	285
Figure 8-1:	SCM Total Score vs. External Conditions	317
Figure 8-2:	SCM Total Score vs. SCM Award	318
Figure 8-3:	SCRM Total Score vs. External Conditions.....	330
Figure 8-4:	SCM Total Score vs. SCRM Total Score.....	332
Figure 8-5:	SCM Total Score vs. SCRM Total Score (II)	333
Figure 8-6:	SCM Total Score vs. SCRM Total Score (III)	338

PART I

INTRODUCTION

Chapter 1 Introduction

Disruptions to business-as-usual take many forms, from general disruptions like diseases, nuclear accidents, and strikes to the company-specific such as e.g. a fire in a plant. The emphasis in this thesis is on the company-specific incidents.

The Aisin – Toyota Fire

This famous incident occurred at the Aisin facility at Kariya on February 1st 1997¹. The fire started on the Saturday morning at 4:18 AM and lasted less than six hours. By 8:52 AM the lines dedicated to P-valves and other brake-related parts were almost completely destroyed, along with special-purpose machinery and drills that could take months to reorder. The near destruction of the P-valve lines was potentially disastrous for Toyota; nearly all its vehicles used Aisin P-valves manufactured exclusively at the Kariya plant, which turned out 32.500 P-valves a day for Toyota and other Toyota-group assemblers. The potential damage to the Toyota group was promptly recognized by the Aisin management, who quickly set up an emergency task force to deal with the initial tasks of communicating the bad news to their customers (actually, it was set up at 5:30 AM, while the lines were still on fire). Besides talking to their customers, possible collaborators were contacted and asked for assistance. After consulting its customers, Aisin started faxing design drawings of all prioritized parts to the volunteering collaborators on Sunday February 2nd. The race for design and manufacturing of prototypes for replacement parts had begun. On Tuesday February 4th, it was reported that only one of thirty assembly plants were operating, and that it would take Toyota at least a week to identify alternative suppliers (Reitman, 1997b). Progress in developing prototypes for replacement of the Aisin parts showed such promise, that Toyota the following day was able to announce that they expected to be back on normal output by Friday February 7th (Reitman, 1997c). Following a truly amazing display of cooperation, Toyota was back on normal output by Friday, not least due to the informal coordination by first tier suppliers (Reitman, 1997a). In total, Toyota lost production of 72.000 vehicles and 160 billion YEN in revenues. Most of the lost revenue was recouped through overtime and holiday shifts, but losses in the range 20-30 billion YEN were unavoidable. For Aisin, the fire cost 7.8 billion YEN, but enhanced their position in the Toyota network through their efforts in minimizing the impact of the disaster. To compensate the collaborating suppliers Toyota paid out a bonus, amounting to 1.5 billion YEN.

The aftermath of the Aisin fire was a realization by the Toyota management of the dual vulnerability of having too many (unique) parts and too few suppliers. The fire left Toyota plants in need of more than 200 unique valve types, a number deemed unacceptable by the Toyota management. An emergency purchasing review was performed, aiming at identifying sole suppliers or severe capacity constraints, as well as opportunities to further limit the number of unique parts (Treece & Rehtin, 1997). A positive consequence was the

¹ Source: Nishiguchi & Beaudet (1998).

reassurance of the toughness of the Toyota group, and the Toyota Production System's² capability of problem solving. The world famous production system thereby was both the cause and the cure of the problem – the cause being the high degree of dependency on even very minor suppliers and the absence of redundancies, the cure being the close relationships with (at least major) suppliers. Whether the response from the suppliers was based on an urge to help a prominent, long-term business partner or on a calculated interest of helping out is an open question, but whatever the rationale the problem was solved and continuation of business secured.

Ericsson/Albuquerque

A less successful recovery from a comparative accident is presented in Norrman & Jansson (2004). Being the world's largest supplier of mobile telecom systems in the world, with a history of more than 130 years and a staff count of more than 61.000 people in more than 140 countries, the effects of a ten minute fire at a sub-suppliers plant came as a complete surprise to management and employees at Ericsson. For the past ten years, Ericsson had outsourced a great deal of its assembly and production to contract manufacturers and sub-suppliers. Like most companies, Ericsson had been exposed to a number of risks and incidents in the last few years: e.g. suppliers having quality and delivery problem, industries' general lack of capacity, and power disruption. These issues had been dealt with and operations were running smoothly until a fire broke out on March 18th 2000 in a very small production cell (small as a conference room for ten people) at a sub-supplier's plant in Albuquerque, New Mexico (USA). The ten-minute fire was an effect of a lightning bolt hitting an electric line causing power fluctuations throughout the state. The problem was that when the power was out, there was no spare diesel motor to supply the fans with power, so the fans stopped. The resulting fire was almost negligible and the fire was quickly put out.

But for Ericsson the impact was huge. In the spring of 2001, when the annual report from Ericsson was announced, a major loss of about \$400 million was indicated, primarily resulting from the shortage in the supply of radio-frequency chips from this supplier. The reason was that the fire occurred in one of the plant's "clean rooms", where absolutely no dust is tolerated. Due to the fire, and especially the smoke and sprinkler water, it took almost three weeks until the production was up and running. After six months, the yield was only 50 percent, and it would take years to get new equipment delivered and installed. As this plant was Ericsson's only source for this chip, Ericsson was not able to sell and deliver one of its key consumer products during its booming "market window". The company lost many months of mobile phone production, and the accident finally had a great impact on Ericsson's decision to withdraw from the mobile phone terminal business. It also had the effect that Ericsson changed its procedures for supply chain risk management.

² For more on the Toyota Production System, see e.g. Ohno (1988) or Spear & Bowen (1999).

Nokia/Alberquerque

Interestingly, Nokia also fell victim to this accident but due to their strategies the impact on them was quite different. As reported in e.g. Lee (2004) and Chopra & Sodhi (2004), Nokia and Ericsson differed in the degree of redundancy in the supply of IC's. Where Ericsson had trimmed the supply base for this category down to one or two, Nokia had chosen to keep a higher degree of redundancy, just in case. Combined with the ability to quickly redesign their products, Nokia was able to quickly (within five days) to have their production back on track. In the short run this earned Nokia market shares - in the long run Ericsson left the market.

1.1 More SCM → More Supply Chain Risk?

Intuitively the risks described in the three cases could all be dealt with by introducing the appropriate level of redundancy. But doing so leads to other problems: first and foremost the introduction of more redundancy can be perceived as “anti-SCM” – within the SCM domain it is often advocated that buffers must be removed, that lead times must be minimized, that the supply base must be reduced and that all relevant (critical?) partners must be tightly integrated creating what Wilding (1998a) would call a complex system. Secondly, the uncritical introduction of redundancy will lead to a de-coupling from reality, resulting in a sense of safety and a subsequent relaxation of procedures and routines (Carroll, 2004). The “trimming down” of companies to achieve goals of cost minimization and speed by reduction of buffers (time, inventory, and other types of redundancy) thereby introduces risks of failure. And the increased specialization (Gripsrud, Jahre, & Persson, 2006) and closer integration of companies in supply chain lead to more complex systems, amplifying the impact of a failure (Perrow, 1984)³. The generic relationship between impact and degree of redundancy is illustrated in Figure 1-1 below.

Figure 1-1: Impact of Failure vs. Degree of Redundancy

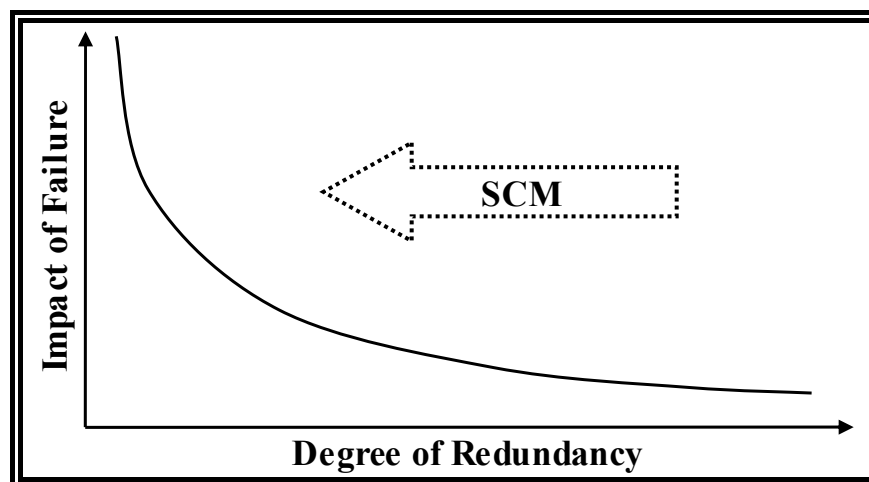

³ Using the terms “interactive complexity” and “tight coupling” Perrow (1984) illustrates the effects of normal (inevitable) accidents. The point is that the removal of redundancies will dramatically increase the impact of a failure as activities in human systems are not independent. Autonomous action of individuals is described as the primary source of accident avoidance.

So, if chasing cost (and other) advantages by implementing SCM leads to a more complex system, the more mature SCM practices will require more mature Supply Chain Risk Management (SCRM) practices? A preliminary hypothesis is therefore:

H₁: The level of SCRM practices corresponds with the level of SCM practices.

To test this hypothesis measures of maturity for SCM and SCRM are needed.

1.1.1 Testing the Relevance of the Study⁴

Before performing the actual study it is often recommended to perform a pilot study to test the relevance and validity of the indented research:

“...the case study design is not something completed only at the outset of a study. The design can be altered and revised after the initial stages of a study, but only under stringent circumstances. As an example, pilot case studies may reveal inadequacies in the initial design or may help to articulate it. ... [A]fter some early data collection and analysis, an investigator has every right to conclude that the initial design was faulty and to modify the design. This is an appropriate and desirable use of pilot studies.” (Yin, 1994, p. 52).

To speed up data collection a panel group study method is applied. The primary purpose is to measure the maturity of SCM practices and secondary to obtain knowledge on the present state of SCRM in the participating companies.

Models and Data Collection Vehicle

To measure the maturity of the SCM practice a model is created from a number of “classic” contributions. Combining the stage models by Stevens (1989) and Mentzer et al. (2001), the process model by Cooper, Lambert, & Pagh (1997), and using existing maturity models (e.g. Lockamy III & McCormack, 2004) a (simple) model for the measurement of SCM Maturity is developed. The assumptions underlying the questions on SCRM is somewhat simpler as it is assumed the presence of formal structure (department/positions) indicates a more mature practice than otherwise, and the use of an integrated approach is more mature than a functionally divided approach. Using these two models in the form of a questionnaire, the pilot study is performed in cooperation with CLM⁵ at a regular meeting. The study has ten participants (representatives from software companies and consultancies participate in the discussions but do not fill in a questionnaire as their perspectives differ from the rest).

⁴ The pilot studies are described in detail in Appendix A. See also Sørensen (2005, 2007).

⁵ Being quite a select club of logistics and SCM professionals, it was initially assumed that the practices reported by these companies would be somewhat more sophisticated than the average company. The organization has since then changed name to Council of Supply Chain Management Professionals (CSCMP). For more information, please see www.cscmp.org.

Findings

The findings within the SCM practices are a bit troubling. Analyzing the returned questionnaires does not lead to the expected results, as e.g. most of the companies claim to be working process-oriented, but process names clearly show the term ‘Process’ has little or no meaning. Another troubling finding is that half the companies claiming to work with SCM do not do so internally within the company. And apparently length of relationship with customers and suppliers has little to do with SCM as no correlation between these two phenomena can be identified. The findings within SCRM are somewhat ambiguous. The overwhelming interest in the subject is reassuring, but the lack of current practice is a bit troubling. Even if half the companies report working with SCRM, only one reports having positions within the domain. It seems as if SCRM is underdeveloped – or at least not formalized. All in all it is concluded SCRM is critically important but apparently not practiced (or communicated).

Revising the Constructs...

These findings naturally result in a thorough analysis of the assumptions in the models used and a revision of the questionnaire.

... and Repeating the Study

The study is then repeated at a seminar at Copenhagen Business School with specially invited companies all (known to be) working with SCM. Surprisingly, not all the companies in this study reports doing so. Most of the companies claiming to perform SCM can name processes, but again: not all process names are accepted (as they resemble department names). The companies all have ERP⁶ systems, and all but one exchange EDI⁷ documents with suppliers and/or customers. None of the companies participate in CPFR⁸ initiatives, but most claim having adapted processes to the requirements of the suppliers or customers. Updating the constructs to measure the maturity of the SCM practices thereby repeats the finding from the previous study: the answers from the respondents do not “fit” the model.

Perhaps due to a more thorough introduction to the categorization of risks, more than half the respondents are able to estimate the impact and probability for their company’s most critical risks. Again: all agree that SCRM is of critical importance due to the high degree of dependency on other companies, and nobody within the organization has the formal responsibility. So, the overall conclusions are identical to the first study: 1. the practices of SCM does not “fit” the theoretical/conceptual models, and 2. SCRM is critically important but not performed in a systematic, structured, formalized manner.

⁶ Enterprise Resource Planning – type of IT system integrating multiple administrative and production oriented functionality in one integrated system. Examples are SAP, Baan, PeopleSoft etc.

⁷ Electronic Data Interchange - a technology used to automatically share information. Implementation relies on dyadic interpretations of the definitions in the “standard” applied (such as UN/EDIFACT).

⁸ Collaborative Forecasting, Planning, and Replenishment – a concept for planning/forecasting across company boundaries, see e.g. Skjøtt-Larsen, Thernøe, & Andresen (2003).

Elaborating on the Pilot Studies

The pilot studies performed are thereby both successes and failures. Successes in the sense they confirm the relevance of SCRM but failures in the sense the idea of progression in SCM practices as described in the literature is rejected⁹. The classification of SCM practices in the companies participating seems pointless as the fit between the domain's assumptions and reality is quite poor. Especially the assumption that "SCM starts from within" is discarded as most companies have long-term relationships with suppliers and customer, but no internal integration (no cross-functional processes implemented). The pilot studies thereby disqualify the intended research design: an explanatory investigation of SCM and SCRM maturity.

Interviewing Consultancies for Risk Management Frameworks

Before the research design is changed, though, another reality check is performed: consultancies are interviewed for their knowledge of (the market for) integrated risk management frameworks¹⁰. The results of this study are ambiguous:

- On the one hand the risk management consultancy Marsh recognizes the need for SCRM, and apparently has resources allocated towards the creation of such a framework (albeit not able to document it). In a separate effort PwC is working on the COSO/ERM framework integrating the departmental risk functions into a framework for risk and opportunities management.
- On the other hand Marsh and PwC have very little empirical evidence of the relevance of performing risk management in relation to SCM. Marsh and PwC report how the vast majority of projects focus on insurance brokerage and incremental improvement of departmental risk management functions. Even more discouraging, most of the remaining consultancies did not even respond to the request for an interview.

Weighing these results up against the findings from the two pilot studies it is concluded SCM and SCRM are subjects worthy of scrutinization.

1.2 Re-designing the Study

Altering the research design from an explanatory design (by means of a two-construct contingency model) to a more exploratory design is thereby a direct consequence of the rejection of the fundamental assumptions on SCM (the stage model) and the paradoxical difference between the observable absence of and the documented need for SCRM.

1.2.1 Overall Research Objective

The challenge is thereby to understand the business practices on SCRM alongside the practices on SCM in general. For any production system or service organization the management of operational risks is of obvious relevance as to minimize losses and ensure continuation of the organization. A poorly performing supplier is most likely to be replaced,

⁹ As reported in Appendix A and Sørensen (2005, 2007).

¹⁰ The findings from the study are described in detail in Appendix B.

and a customer continually changing order quantity and/or delivery terms are not likely to receive (above) average attention. But even if both suppliers and customers are important to any business there are differences.

The Downstream Side...

At least in the short term the loss of a customer simply represents a decrease in demand resulting in a need to adjust output and thereby capacity. The threat changes in case e.g. the customer is the key reference enabling the company to market its products. In other words, if the customer is a dominant player (in terms of volume, turnover etc.) either directly or by proxy this customer relationship must be safeguarded or the customer portfolio must be altered. Consequently, from a risk perspective, it is important to have as many customers as possible, or to make customers dependent. For customers representing a smaller portion of revenue (and not representing any other advantage/value) less resources are to be spent on the relationship. For larger customers, on the other hand, the effort in “locking in” the customer should be proportionate with the customer’s importance in terms of current and future turnover (and other advantage/value).

...Versus Upstream

For suppliers the basic mechanism in play to reduce risk is to remain as independent as possible to ensure price competition and redundancy on all inputs. In cases where this is not possible, critical suppliers should be made dependent on the company thereby ensuring a certain balance between the two companies. A practice for ongoing evaluation of the portfolio of activities and inputs will “protect” this balance – determining whether to in- or outsource a certain activity based on portfolio composition and market uniqueness. The main difference between the risk management requirements towards customers and suppliers is thereby partially related to the time perspective: all inputs (standard and non-standard) must be available to produce the required output (short term) whereas the impact of a loss of a customer has turnover and market implications (longer-term).

Choosing Chain Orientation

Applying the risk perspective up- and down-stream reveals that the level of complexity differs greatly. Where on the downstream side the generic risk mitigation argument may be reduced to increasing the number of customers and avoiding “lock-in” by individual (large) customers the argument on the upstream side may prove less simple. Accepting analyzing both upstream and downstream is beyond the reach of this study the upstream side is chosen over the downstream side. Therefore the investigations of current practice focus on SCM/Logistics and Purchasing¹¹.

¹¹ Albeit the SCRM practices researched are not limited to the supply side alone, the practicalities of the project have restricted the setup of interviews with representatives from the sales organization of the case companies. More on the selection of interviewees in Chapter 6.

Overall Research Objective

The overall research objective is thereby:

How do leading Danish companies engaging in inter-organizational relationships safeguard their organization through supplier management and design of their supply chains?

1.2.2 Research Questions

Understanding the current practice of SCRM is therefore the primary objective of the study, but first a more thorough understanding of risk and uncertainty within the SCM domain is required. Furthermore it is important to understand the state-of-art of Supply Chain Design, and more specifically the role played by Risk and Uncertainty. The investigation of the domain thereby consists of two research questions:

Research Question 1: Which are the major themes on Risk and Uncertainty within the SCM literature?

Research Question 2: How does state-of-the-art supply chain design address the management of supply chain risks?

Also it is considered relevant to understand to which extent the management of risks is supported by the theories applied within the SCM domain. Acknowledging SCM is a multi-disciplinary domain (e.g. Giannakis, Croom, & Slack, 2004; Gripsrud, Jahre, & Persson, 2006) a short list of theories must be developed before answering the third research question:

Research Question 3: How do the theories most commonly applied within the SCM domain address the management of supply chain risks?

As mentioned previously the conclusions from the pilot studies resulted in a redesign of the study. Assumptions on the evolution of SCM practices are discarded as a direct consequence of these studies, and the nature of the study is changed from a contingency type study into a more exploratory design. The stated hypothesis (H1, see page 6) still stands, though.

The investigations of the two domains are thereby linked, hopefully resulting in useful knowledge on 'safe SCM'. The last research question is defined as:

Research Question 4: How do the case companies perform SCM and SCRM?

To answer these research questions a research design is needed – but first a stance on methodology must be taken.

1.3 Methodology

In Arbnor & Bjerke (1997) the relation between ultimate presumptions and study area is described as depicted in Figure 1-2 below.

Figure 1-2: Methodology¹²

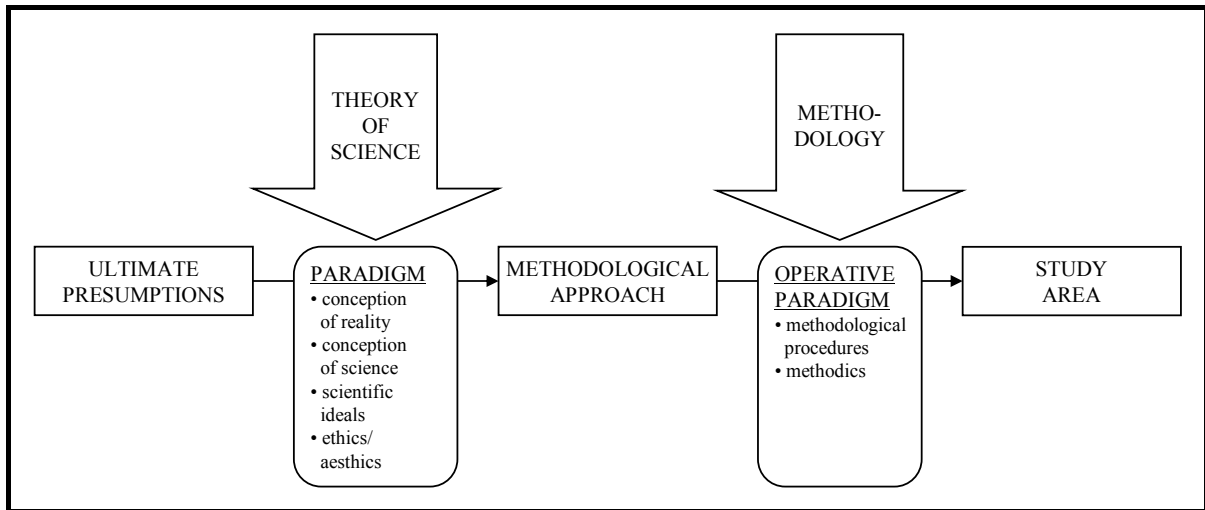

The logic of the model is that two choices are made:

1. With the use of theory of science and based on one's ultimate presumptions to determine paradigm, and subsequently to choose the most appropriate methodological approach, and
2. Based on the chosen methodological approach to determine the operative paradigm for the study.

The former choice is heavily influenced by the researcher's personal beliefs but also by the study area. Further, certain disciplines will have traditions limiting the "accepted" methodological approaches. In Arbnor & Bjerke (1997) social science paradigms are categorized¹³ and ranked according to a scale ranging from 'Objectivist-Rationalistic – Explaining Reality' to 'Subjectivist-Relativistic – Understanding Reality'. From this categorization Arbnor & Bjerke develop three methodological approaches for business: The Analytical Approach, The Systems Approach, and The Actors Approach.

Arbnor & Bjerke then further characterize each approach according to 1. 'Concept of reality', 2. 'Knowledge creation', 3. 'Explanation/understanding', 4. 'Result', and 5. 'Prerequisites for continuing' enabling the researcher to position him/her-self according to personal preferences

¹² Source: Figure 1.8 in Arbnor & Bjerke (1997), p. 17.

¹³ Categories are: 'Ultimate reality presumptions', 'Stipulations about human nature', 'Ambitions for creating knowledge', 'Some common metaphores, pictures, and descriptions', and 'Some techniques for creating knowledge', see Table 2.1 in Arbnor & Bjerke (1997), p. 27.

and the nature of the study. In this instance the re-design of the study has resulted in a more exploratory study than initially intended, but this has not altered the ultimate presumptions of the researcher. The study still falls within the ‘Systems Approach’ class, see Figure 1-3 below.

Figure 1-3: Methodological Approaches¹⁴

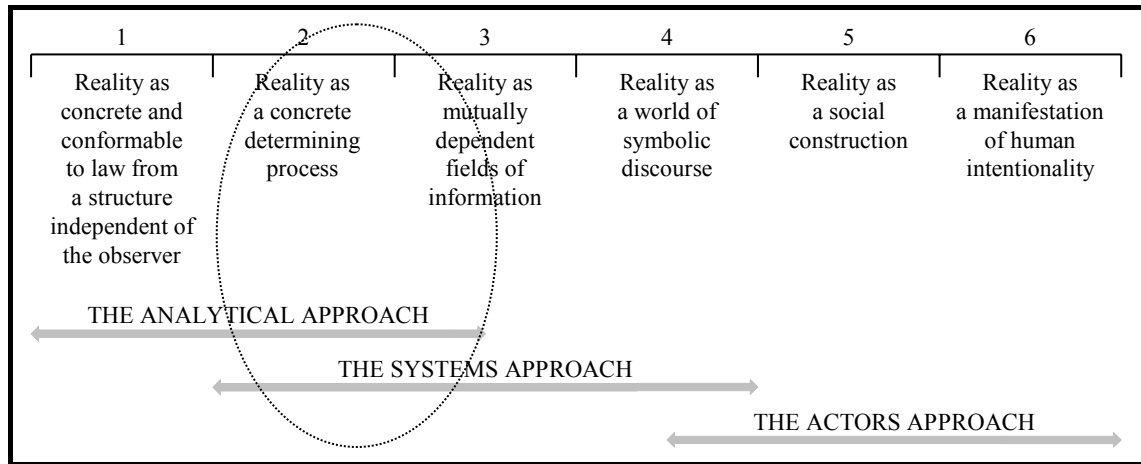

As illustrated above the ‘Analytical Approach’ and ‘Systems Approach’ overlap when depicted on a simple scale, but differ in e.g. reality assumptions:

“The analytical approach has its origins in classic analytical philosophy and therefore has a deeply rooted tradition in Western thinking. Its assumption about the quality of reality is that reality has a summative character, that is, the whole is the sum of its parts. ... Knowledge created using the analytical approach is characterized as being independent of the observer.” (Arbnor & Bjerke, 1997, p. 50), and

“The assumption behind the systems approach, different from the assumption underlying the analytical approach, is that reality is arranged in such a way that the whole differs from the sum of its parts. This means that not only the parts but also their relations are essential, as the latter will lead to plus or minus effects (synergy)... Knowledge developed through the systems approach depends on systems. ... Consequently, the systems approach explains or understands parts through the characteristics of the whole (of which they are parts).” (pp. 51-52).

The ‘Actors Approach’ is radically different as e.g. systemic characteristics as recognized in the other two approaches are meaningless concepts. The actors approach is directed towards reproducing the meanings of the actors, and:

“...reality is therefore taken as a social construction that is intentionally created by processes at different levels of meaning structures. ... Systems - as these are understood by the systems approach – are not real. The actors approach asserts that such systems exist only in the head of the systems approach researcher/consultant/investigator and are therefore not based on the way actors interpret themselves in relation to their own experienced and

¹⁴ Source: Figure 2.1 in Arbnor & Bjerke (1997), p. 44.

constructed totality of meaning structures.. ... Knowledge developed with the actors approach is therefore dependent on actors... ” (p. 52).

As indicated in Figure 1-3 above, the evaluation of before mentioned categories (see footnote 13) results in the study being positioned under the heading ‘Reality as concrete determining process’. The methodological approach chosen is the ‘Systems Approach’, as the notion that context and relations (externally and between system components) are necessary to understand a system is appealing to the researcher.

1.4 Method Applied – Literature Studies

As for other dissertations (and research projects/reports in general) literature studies are of critical importance to understand the state-of-art within the domain/subject area (e.g. Bell, 1993; Ghauri, Grønhaug, & Kristianslund, 1995). Failing to perform a thorough and stringent investigation into existing knowledge will inevitably lead to unnecessary repetition of trivial studies (Yin, Bingham, & Heald, 1976; Burgess, Singh, & Koroglu, 2006). As a direct consequence of the pilot studies, the researcher experienced an acute need to understand the state-of-art of two areas: 1. the use of the terms Risk, Uncertainty, and Vulnerability, and 2. arguments/principles for Supply Chain Design.

Strategies for performing literatures vary from the thorough, stringent procedures to the almost haphazard “critical” literature studies. Justified by the surprising results from before mentioned pilot studies the researcher chose to perform both literature studies following a stringent method. A typology of strategies for literatures studies is presented in Appendix C, the strategy applied in both literature studies is the ‘Domain-based Strategy’¹⁵.

Defining the Domain

As indicated by the name of the strategy, a definition of the domain is required to identify relevant contributions. In this dissertation two distinct domains are investigated: the SCM/Logistics domain and the Risk domain. For reasons of e.g. time criticality, ease of identification, resource consumption, tradition etc. it was decided to use journals as the primary source for both literature studies.

For the SCM/Logistics domain the population is derived as a compromise between other literature studies performed within the field (e.g. Zsidisin, 2003b) and evaluations of the usefulness of journals (e.g. Gibson & Hanna, 2003; Fawcett, Vellenga, & Truitt, 1995; Emmelhainz & Stock, 1989). The journals investigated fall in three categories, listed in Table 1-1 below.

¹⁵ The literature used in the preliminary work (i.e. the pilot studies) is best described as an application of the ‘Snowballing Strategy’. So-called ‘critical literature studies’ have just these characteristics.

Table 1-1: Journals Defining the SCM/Logistics Domain

Area	Journal Name	Abbrev.	E-database
Logistics			
	European Journal of Purchasing and Supply Management ¹⁶	EJPSM	ScienceDirect
	International Journal of Logistics: Research and Application	IJL-RA	Business Source Premier
	International Journal of Logistics Management	IJLM	ABI/INFORM
	International Journal of Physical Distribution & Logistics Mgmt	IJPDLM	EMERALD
	International Journal of Purchasing and Materials Management ¹⁷	IJPM	ABI/INFORM
	Journal of Business Logistics	JBL	Business Source Premier
	Journal of Purchasing and Supply Management	JPSM	ScienceDirect
	Journal of Supply Chain Management	JSCM	ABI/INFORM
	Supply Chain Management: An International Journal	SCM-IJ	EMERALD
	Supply Chain Management Review	SCMR	Business Source Premier
Operations Management			
	Interfaces	I	Business Source Premier
	Integrated Manufacturing Systems ¹⁸	IMS	EMERALD
	International Journal of Operations & Production Management	IJOPM	Business Source Premier
	International Journal of Production Economics	IJPE	ScienceDirect
	Journal of Manufacturing Technology Management	JMTM	EMERALD
	Journal of Operations Management	JOM	ScienceDirect
	Production and Operations Management	POM	ABI/INFORM
	Production Planning & Control	PPC	Business Source Premier
Management			
	California Management Review	CMR	Business Source Premier
	Decision Science	DS	ABI/INFORM
	European Management Journal	EMJ	ScienceDirect
	Harvard Business Review	HBR	Business Source Premier
	Industrial Marketing Management	IMM	ScienceDirect
	Journal of Occupational Behaviour ¹⁹	JOcB	JSTOR
	Journal of Organizational Behavior	JOrB	JSTOR
	Scandinavian Journal of Management	SJM	ScienceDirect
	Sloan Management Review	SMR	Business Source Premier

For the Risk domain, the journals included in the population are all journals identified in the available e-databases, see Table 1-2.

Table 1-2: Journals Defining the Risk Domain

Area	Journal Name	Abbrev.	E-database
Risk			
	Journal of Risk	JR	[dedicated website]
	Journal of Risk & Insurance	JRI	Business Source Premier
	Journal of Risk Research	JRR	Business Source Premier
	Journal of Risk and Uncertainty	JRU	Kluwer
	Risk Management	RM	ABI/INFORM
	Risk Analysis: An International Journal	RA-IJ	Kluwer

For an overview of the e-databases used, see Table 1-3 below.

¹⁶ The journal changed name to “Journal of Purchasing and Supply Management” in 2003.

¹⁷ The journal changed name to “Journal of Supply Chain Management” in 1999.

¹⁸ The journal changed name to “Journal of Manufacturing Technology Management” in 2004.

¹⁹ The journal changed name to “Journal of Organizational Behavior” in 1988.

Table 1-3: E-databases Available

E-database	Description
ABI/INFORM	A.k.a. ProQuest. Contains articles from approx. 700 journals within Economics.
Business Source Premier	Contains articles from approx. 3800 journals within Management, Economics, Finance, Accounting, Law, and International Business.
EMERALD	Contains articles from approx. 100 journals within Management, Marketing, Logistics, Quality Assurance, HRM, Higher Education etc.
JSTOR	Contains recent articles (2-5 years) from journals within the social sciences.
Kluwer	Contains articles from approx. 650 journals from a variety of areas.
ScienceDirect	Contains articles from approx. 1700 journals from a variety of areas.
www.thejournalofrisk.com	Website for “The Journal of Risk”.

From these two populations the literature studies are performed, and the first two research questions are answered. The strategy applied is described in the introduction to each study.

1.5 Method Applied – Analysis of Theories

In order to answer the third research question theories routinely applied within the SCM domain are analyzed to determine how the management of the relevant risks (as defined in the ‘Risk Matrix’ in Chapter 2.4.2) is addressed. As no methods for the analysis of theories have been identified the method applied is “homegrown”. For each theory the basic assumptions, the causalities, and the objects recognized are described, followed by an evaluation of the appropriateness of the application of the theory to the SCM domain in general. Subsequently the generic risks identified are evaluated against the theory and its assumptions and causalities (if any). Answering the third research question is thereby highly dependent on the viewpoint of the researcher.

1.6 Method Applied – Current Practice

To answer the last research question empirical data on current practices is needed – and to that end a research strategy must be carefully chosen.

Choosing a Research Strategy

One of the characteristics of the research situation determining the appropriateness of a research strategy is the existing body of knowledge (Yin, 1994; Ghauri, Grønhaug, & Kristianslund, 1995 etc.). As pointed out several times already, a certain degree of skepticism is felt towards the current knowledge of SCM. Coupling this uncertainty with the lack of knowledge of the practices on SCRM, the research design for the empirical part has to enable an understanding of the phenomenon, instead of testing existing hypotheses.

In Ghauri, Grønhaug, & Kristianslund (1995) it is emphasized that the understanding of the problem is a classifying variable:

“Based on the problem structure, we may distinguish between three main classes of research design:

<i>Research design</i>	<i>Problem structure</i>
<i>1. Exploratory</i>	<i>Unstructured</i>
<i>2. Descriptive</i>	<i>Structured</i>

3. *Causal Structured*" (p. 27).

According to Ghauri, Grønhaug, & Kristianslund an exploratory research design is appropriate when the research problem is badly understood, whereas both descriptive and causal research design are appropriate when the problem is structured and well understood. They consider the case study method of special relevance when the area of interest is poorly understood:

"In relatively less-known areas, where there is little experience and theory available to serve as a guide, intensive study of selected examples is a very useful method of gaining insight and suggesting hypotheses for further research. ... The main focus is on seeking insight rather than testing: instead of testing existing hypotheses we seek insight through the features and characteristics of the object being studied." (pp. 87-88).

This position is challenged by Yin (1994) who claim case studies can be exploratory as well as exploratory/descriptive:

"A common misconception is that the various research strategies should be arrayed hierarchically. We were once taught to believe that case studies were appropriate for the exploratory phase of an investigation, that surveys and histories were appropriate for the descriptive phase, and that experiments were the only way of doing explanatory or causal inquiries. ... This hierarchical view, however, is incorrect. ... The more appropriate view of these different strategies is a pluralistic one. Each strategy can be used for all three purposes – exploratory, descriptive, or explanatory." (pp. 3-4).

To Yin the case study research strategy is well suited in a very specific situation:

"In general, case studies are the preferred strategy when 'how' or 'why' questions are being posed, when the investigator has little control over events, and when the focus is on a contemporary phenomenon within some real-life context. Such 'explanatory' case studies also can be complemented by two other types – 'exploratory' and 'descriptive' case studies." (p. 1).

The case study research strategy thereby fits this specific combination of research question, control over events, and "contemporariness" of events to be studied. 'How' and 'when' questions can also be studied by applying research strategies 'experiments' or 'history', but the former requires control over events, the latter focuses on non-contemporary events²⁰. Albeit Yin does not agree with Eisenhardt (1989b) (and others) that case study research is especially well-suited when performing research of more exploratory nature, he does not disqualify the research strategy neither.

But others have criticized the research strategy. In a special issue of the journal *Administrative Science Quarterly* on qualitative methods, Miles (1979) criticizes the case study method (or rather qualitative methods) for producing results that can not be analyzed, neither with-in case nor cross-case. Furthermore Miles points out that the frequency of objections from participants to research results far exceeds the frequency from other types of studies. In a reply published two years later in the same journal, Yin (1981) reciprocates by questioning the link between qualitative data and case study research (case study research can

²⁰ Summary in Figure 1.1 in Yin (1994), p. 6.

use both qualitative and quantitative data) and by suggesting methods of performing within-case and cross-case analysis.

A Model for Theory-building in Case Study Research

This line of development was continued in Eisenhardt (1989b) where a method for theory development from case study research is presented. Referencing other researchers performing case study research it is claimed the a priori definition of research question and possibly even constructs is beneficial:

“... definition of research question within a broad topic permitted these investigators to specify the kind of organization to be approached, and, once there, the kind of data to be collected. ... A priori specification of constructs can also help shape the initial design of theory-building research.” (Eisenhardt, 1989b, p. 536).

Knowing state-of-art of the subject through stringent literature review is an important requirement for defining the initial research question and preliminary constructs, but it is emphasized the researcher should be willing to alter these as appropriate during the study:

“Although early identification of the research question and possible constructs is helpful, it is equally important to recognize that both are tentative in this type of research. No construct is guaranteed a place in the resultant theory, no matter how well it is measured. Also, the research question may shift during the research.” (p. 536).

Differentiating the knowledge available in the literature from theoretical perspectives it is also emphasized that theory should delineate neither research question nor constructs, but:

“... theory building research is begun as close as possible to the ideal of no theory under consideration and no hypotheses to test. ... [A]ttempting to approach this is important because preordained theoretical perspectives or propositions may bias and limit the findings. Thus, investigators should formulate a research problem and possibly specify some potentially important variables, with some reference to extant literature. However, they should avoid thinking about specific relationships between variables and theories as much as possible, especially at the outset of the process.” (p. 536).

Progressing to the case selection Eisenhardt further describes the difference in the sampling method for theory testing versus theory building studies:

“The cases may be chosen to replicate previous cases or extend emergent theory, or they may be chosen to fill theoretical categories and provide examples of polar types. While the cases may be chosen randomly, random selection is neither necessary, nor even preferable. As Pettigrew (1988) noted, given the limited number of cases which can usually be studied, it makes sense to choose cases such as extreme situations and polar types in which the process of interest is ‘transparently observable’. ... In contrast, traditional within-experiment hypothesis-testing studies rely on statistical sampling, in which researchers randomly select the sample from the population. In this type of study, the goal of the sampling process is to obtain accurate statistical evidence on the distributions of variables within the population.” (p. 537).

The case selection method thereby determines the type of conclusion reached – the exploratory case study might naturally be limited to theory-generation if not supplemented by studies of a more explanatory nature.

But also the theory generation requires a stringent process for analysis of the often staggering volumes of data. Eisenhardt proposes to start with the with-in case analysis “to become intimately familiar with each case as a stand-alone entity” (p. 540) followed by a cross-case analysis to identify patterns of similarity. Various strategies for the cross-case analysis are proposed, all aiming at increasing the quality of the analysis and:

“... to force investigators to go beyond initial impressions, especially through the use of structured and diverse lenses on the data. These tactics improve the likelihood of accurate and reliable theory, that is, a theory with a close fit with the data. Also, cross-case searching tactics enhance the probability that the investigators will capture the novel findings which may exist in the data.” (p. 541).

The fit between the data and the emerging theory improve as the iterative process of systematically comparing data with hypotheses progresses. Between iterations constructs are refined and measures are developed, and multiple sources of evidence might be introduced to further improve construct validity. In conclusion the strengths of the case study research strategy are:

- the likelihood of generating novel theory,
- the emergent theory is likely to be testable with constructs that can be readily measured and hypotheses that can be proven false, and
- the resultant theory is likely to be empirically valid.

Conversely, some of the characteristics which lead to the strengths also may lead to some of the weaknesses when building theory from case studies. These include:

- the intensive use of empirical evidence may lead to overly complex theory, as well as the opposite, namely
- the creation of idiosyncratic theory stemming from the bottom-up approach of case study theory creation.

These shortcomings obviously are quite severe.

An Ongoing Discussion

Two years later a critique by Dyer & Wilkins (1991) was published objecting to:

“...three critical areas: (a) the in-depth study of a single case (context) versus the study of multiple cases (contexts), (b) deep versus surface description, and (c) the telling of good stories versus the creating of good constructs.” (p. 613).

The basis for their criticism was a defense for the “classic case study” where a single (or possibly two or three) cases are included in the study. They argue that the method put forward by Eisenhardt is cases study instead of case study and go on to argue that the “rich story” is an important exception to the argument made by Eisenhardt:

“With fewer than 4 cases, it is often difficult to generate theory with much complexity, and its empirical grounding is likely to be unconvincing, unless the case has several mini-cases within it.” (Eisenhardt, 1989b, p. 545).

To Eisenhardt knowledge is obtained and verified through cross-case examination whereas Dyer & Wilkins argue getting close to the case is a valid source of knowledge, resulting in “deep insights”. They argue that the ultimate goal is to “provide a rich description of the social scene, to describe the context in which events occur, and to reveal ... the *deep structure* of social behaviour.” (p. 615). Dyer & Wilkins further claim the main advantage of the classic case study is the “quality” of the theory generated:

“Theory that is born of such deep insights will be both more accurate and more appropriately tentative because the researcher must take into account the intricacies and qualifications of a particular context. ... Eisenhardt’s method [is] necessarily constrained by the number of cases that will be studied, and description will be rather ‘thin’, focusing on surface data rather on deeper dynamics.” (p. 615).

Dyer & Wilkins admit Eisenhardt’s method might provide “flashes of insight” but insist the method will:

“... neglect the more tacit and less obvious aspects of the setting under investigation. [It] is more likely to provide a rather distorted picture or no picture at all, of the underlying dynamics of the case.” (p. 615).

Dyer & Wilkins end their criticism by insisting on the advantages of the classic case study (the rich story of a single or a few cases) and argue:

“... that the classic case study approach has been extremely powerful because these authors have described general phenomena so well that others have little difficulty seeing the same phenomena in their own experience and research. We return to the classics because they are good stories, not because they are merely clear statements of a construct.” (p. 617).

In a response Eisenhardt (1991) first rejects the critiques put forward and continues to repeat the claim that rigor and stringent methods are necessary in order to create generalizable theory. In the concluding comments the relevance of good story telling is emphasized:

“... the similarities between single- and multiple-setting research are vastly more important than the differences. For both, storytelling is an essential first step, but good theory is fundamentally the result of rigorous methodology and comparative, multiple-case logic. This is as evident in the classic case studies as it is in contemporary multiple-case research.” (p. 627).

The authors mentioned above are but a few of the participants in the ongoing debate over the relevance and applications of case study research. Many other could have been mentioned but the examples described above clearly describe the intensity of the debate, and give some indications on the advancements within case study research.

Case Study Research for Exploratory Studies

The use of case study research is now accepted within Management/Organization Theory (e.g. Woodside & Wilson, 2003), Operations Management (e.g. Meredith, 1998; Lewis, 1998),

Marketing (e.g. Johnston, Leach, & Liu, 1999; Hillebrand, Kok, & Biemans, 2001) and Logistics/SCM (e.g. Gammelgaard, 2004; Frankel, Naslund, & Bolumole, 2005) albeit debate on the application and contingencies surrounding case study research is still ongoing. In this dissertation the case study research strategy has been chosen due to its capability to unravel and make possible description of complex organizational phenomena of which little is known. The detailed design of the case studies is described in Chapter 6.

1.7 Overall Research Design

The overall research design (including the pilot studies) thereby can be illustrated conceptually as in Figure 1-4 below. The upper part of the figure depicts the pilot studies already reported, whereas the lower part shows the planned study.

Figure 1-4: Research Design

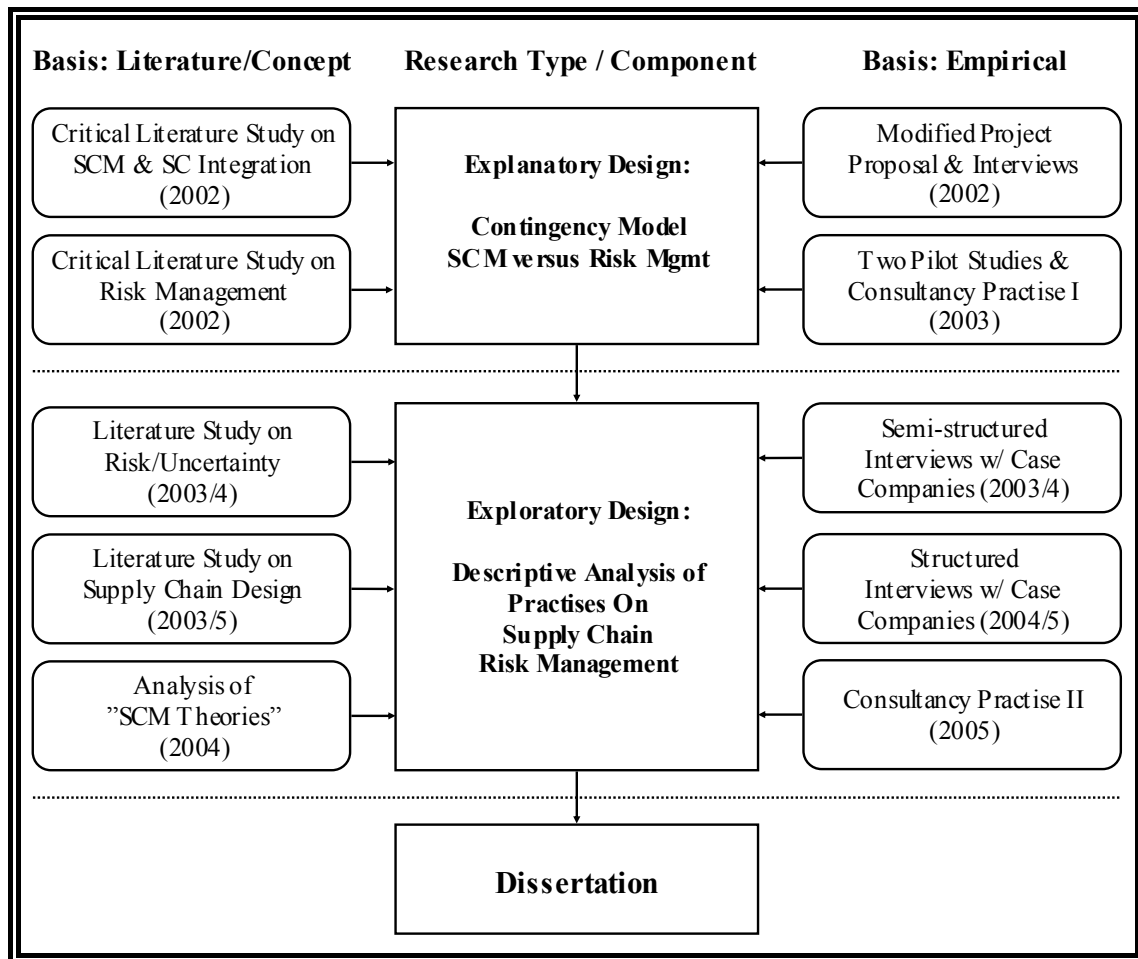

The conceptual model translates into chapters as depicted in Figure 1-5 below.

Figure 1-5: Structure of the Dissertation

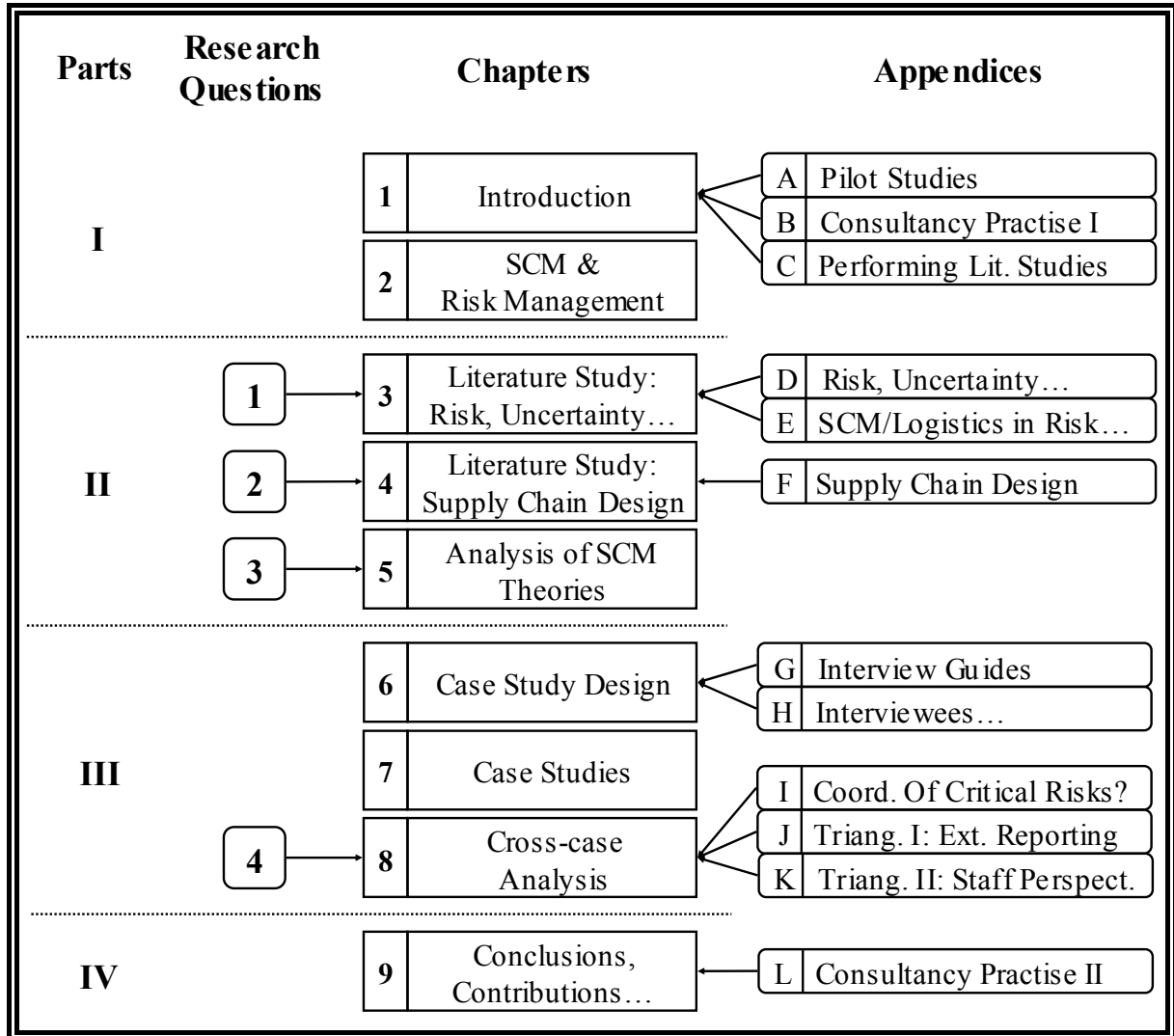

Chapter 2 SCM & Risk Management

The purpose of this chapter is to introduce the idea of integrating SCM and Risk Management. First, the SCM and Risk Management domains are described by a brief historical account of both domains, and trends within Risk Management and general management (Corporate Governance) are briefly described as mechanisms to integrate SCM and Risk Management. From the general perspective of Corporate Governance attention is directed at the SCM domain, and a Supply Chain Risk Matrix is put forward as a generic model for the rest of the dissertation. The chapter closes with a preliminary discussion of the impact of risk management on the design of supply chains.

2.1 The Coming of Supply Chain Management

The term Supply Chain Management (SCM) was introduced more than twenty years ago in an article (Oliver & Webber, 1982) advocating the strategic importance of logistics. Instead of focusing on the optimization of operations in the individual company, Oliver & Webber proposed taking a more holistic perspective on operations. Their definition differentiated SCM from logistics:

“Supply-chain management differs significantly from classic materials and manufacturing control in four respects. First, it views the supply chain as a single entity rather than relegating fragmented responsibility for various segments in the supply chain to functional areas such as purchasing, manufacturing, distribution, and sales. The second distinctive feature of supply-chain management flows directly from the first: It calls for – and in the end, depends upon – strategic decision making. ‘Supply’ is a shared objective of practically every function in the chain and is of particular strategic significance because of its impact on overall costs and market share. Third, supply-chain management provides a different perspective on inventories, which are used as a balancing mechanism of last, not first, resort. Finally, supply-chain management requires a new approach to systems: Integration, not interfacing, is the key.” (Christopher, 1992, p. 66).

The outcry for strategic attention was a result of the increased pressures for cost reduction. In the early 1980’s logisticians were “back seat drivers” but this was to change. Scale production did no longer seem to result in winning market share, and corporate cost reduction schemes did not seem to be successful enough. In order to remain competitive the corporate strategists needed to look beyond the corporate boundaries for efficiencies in the logistics flow. Theoretical and conceptual developments had enabled the increased sophistication of previously quite “practice-oriented” disciplines such as purchasing, manufacturing and logistics, and political upheaval was about to change the world into a global marketplace. The deregulation of industries and the increased globalization combined with the advances within IT and logistics concepts have resulted in increased pressures on the logistics function, as the need for better products at lower costs, modified for each customer, and delivered anywhere on the planet became valid claims.

Within academia the SCM concept took on quite slowly - in the beginning the contributions referencing SCM (e.g. Jones & Riley, 1985; Houlihan, 1988) all dealt with smoothing the

flow of materials and were quite similar as they aimed at removing inefficiencies caused by the “bullwhip effect” as described by Forrester (1961)¹.

In the seminal work by Stevens (1989) the scope of SCM is extended:

“The scope of the supply chain begins with the source of supply and ends at the point of consumption. It extends much further than simply a concern with the physical movement of material and is just as much concerned with supplier management, purchasing, materials management, manufacturing management, facilities planning, customer service and information flow as with transport and physical distribution.” (p. 3).

Stevens continues:

“The objective of managing the supply chain is to synchronise the requirements of the customer with the flow of materials from supplier in order to effect a balance between what is often seen as the conflicting goals of high customer service, low inventory investment and low unit cost. The design and operation of an effective supply chain is of fundamental importance to every company.” (p. 3).

Besides obtaining effectiveness in operations, Stevens advocates the early involvement of suppliers in product development, which is only possible when long term commitments are made between suppliers and focal company (i.e. the elimination of multiple sourcing).

Figure 2-1: Achieving an Integrated Supply Chain²

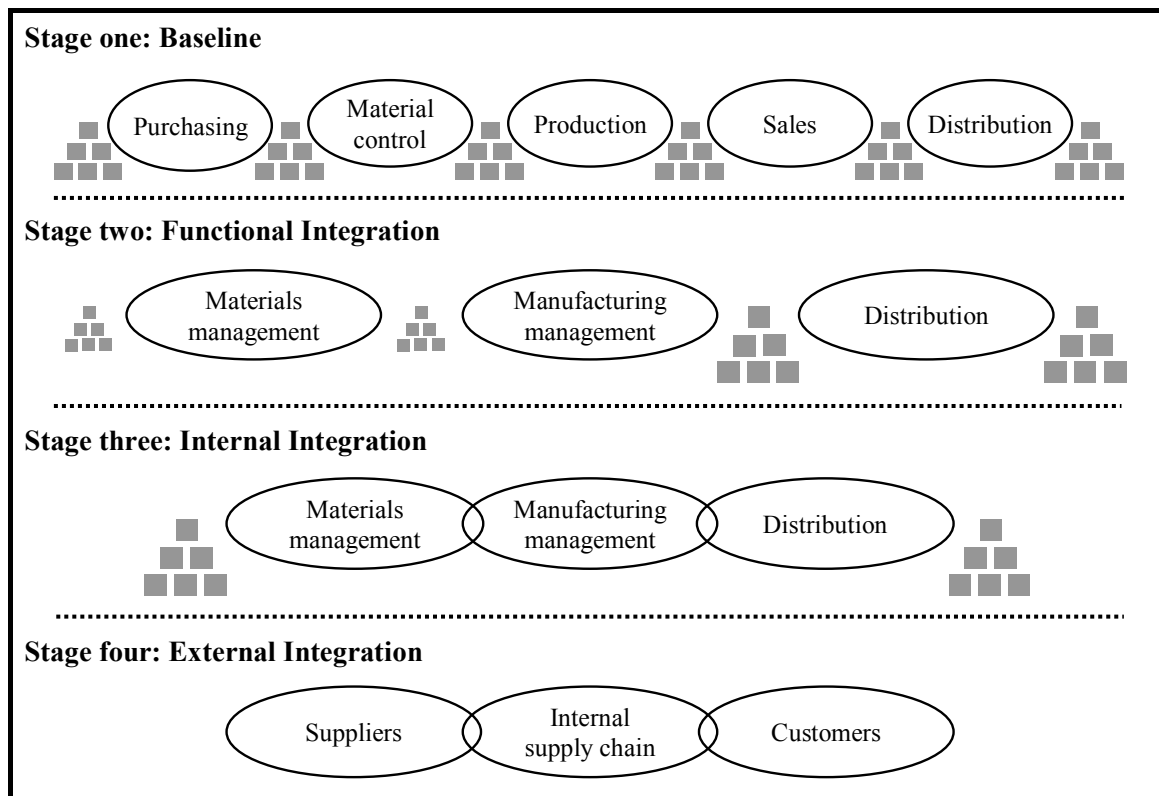

¹ Often forgotten, the Burbidge effect describes the inefficiencies created by lack of synchronization across echelons, see e.g. Towill (1997).

² Source: Figure 5 in Stevens (1989), p. 7.

The main contribution though in Stevens (1989) is the integration model (see Figure 2-1 above) which has had an enormous effect on the work on supply chain integration and supply chain design (referenced in e.g. Hewitt, 1994; Cooper, Lambert, & Pagh, 1997; Towill, Childerhouse, & Disney, 2002; Lockamy III & McCormack, 2004). The progression model describes how the integration of functions (breaking down of functional silos) enables the removal of interim buffer stock, making external integration and the removal of buffers all together possible. Internal integration of materials and information flow is thereby a prerequisite for SCM.

This idea is brought even further in Cooper & Ellram (1993) where SCM is compared to other types of channel relationships. Besides the overall reduction of inventory and other costs, the authors identify e.g. time horizon (relationship and planning), compatibility in corporate philosophies, sharing of risk and reward, and breadth of supplier base as characteristics distinguishing SCM. An additional goal for SCM is introduced:

“A goal of supply chain management is continuous improvement. This includes increased speed of operations, as well as improved information and inventory flows, due to better coordination and focused goals across supply chain members.” (p. 21).

Besides the smooth flow of materials and information the strategies and corporate philosophies need to be compatible in order for the cooperation to work.

The idea of optimality in supply chains is explicated in an article (Hewitt, 1994) taking a BPR view on cooperation on logistics activities across firm boundaries:

“What emerges is a long series of small steps leading to an increasingly cross-functional and process-oriented view of the activity. [...] It is significant but unsurprising that the historical evidence shows that progressive co-ordination of existing functional activities, followed by rationalization of these activities has been more common than radical moves to a totally revised process management approach. Currently, few of the companies surveyed in either Europe or the U.S. have reached even the level of integration implied in Stages III or IV³. On the other hand, taking a BPR view of the reported findings, it is clear that a few enterprises are now going beyond cross-functional co-ordination to an explicitly process oriented way of working, thereby truly justifying the term supply chain process management.” (p. 3).

Redesigning the company towards process orientation might lead to improved efficiencies but

“...process redesign is only likely to be successful if it is recognized as a multi-dimensional activity, simultaneously and explicitly addressing the work activity dimension, the information flow dimension and the decision/authority dimension” (p. 5).

In the studies reported by Hewitt redesign extending beyond the scope of the individual firm is rare. Reporting from a number of leading edge companies in Europe and the U.S., Hewitt

³ The phases in the referenced framework are: I. Fragmented Technical Disciplines, II. Functional Scope, III. Broad Scope Logistics, and IV. Links with Customers and Suppliers. It thereby resembles Stevens (1989) framework.

suggests that principles for intra-firm redesign may be appropriate for inter-firm initiatives as well.

Integration of Processes

The concept of integration is further elaborated upon in Cooper, Lambert & Pagh (1997) where the integration is described by a number of processes. They support the idea of early supplier involvement in product development, and further expand the scope of SCM by suggesting that more functions than just logistics should be integrated across firm boundaries. The importance of process is emphasized as they claim:

“The integration of business processes across the supply chain is what we are calling supply chain management.” (p. 2).

They list of number of possible supply chain business processes and describe a SCM framework by means of three components: business processes, supply chain structure, and management components.

Figure 2-2: A Framework of Supply Chain Management⁴

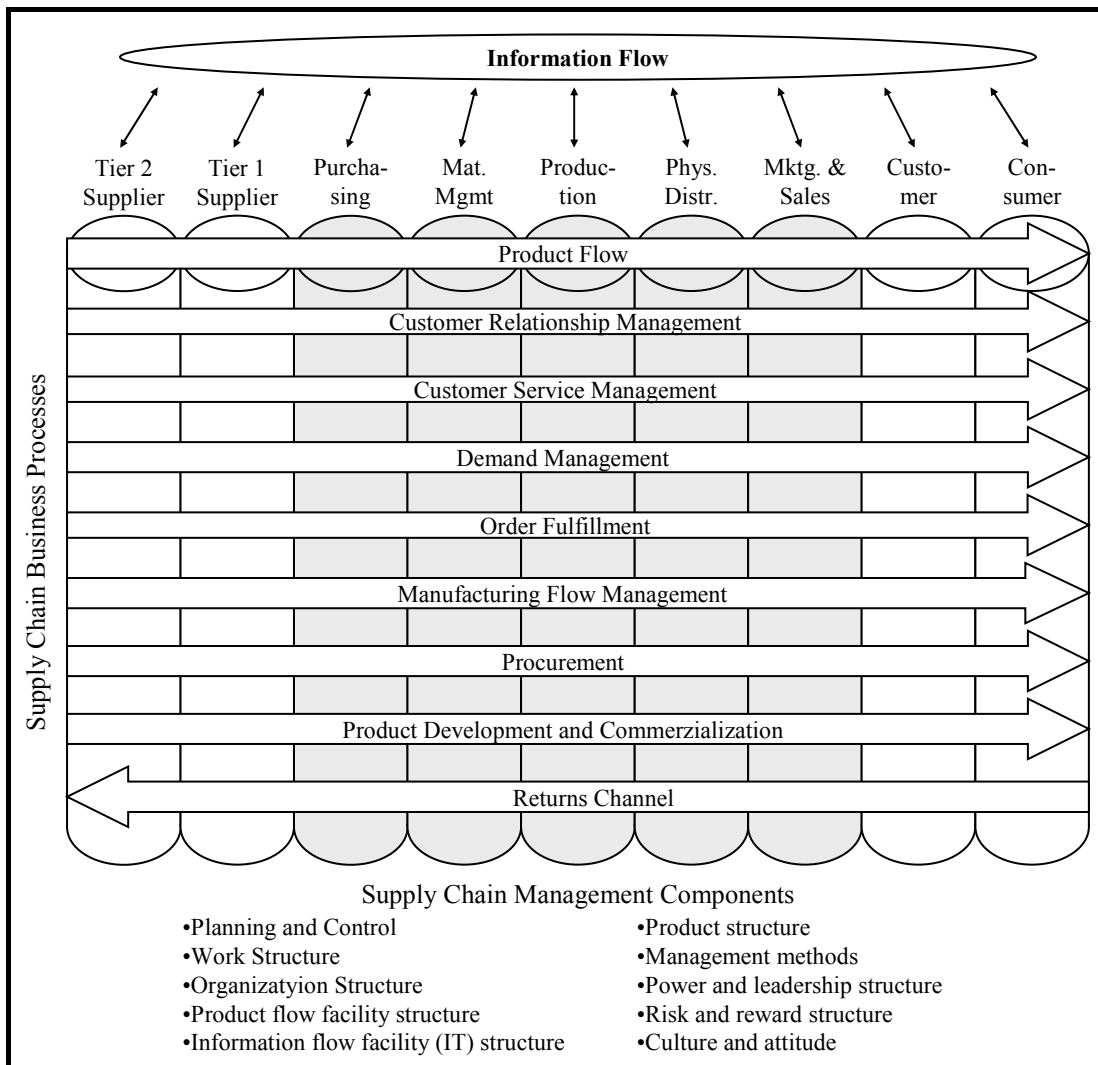

⁴ Source: Figure 2 in Cooper, Lambert, & Pagh (1997), p. 10.

In a later contribution (Lambert, Cooper, & Pagh, 1998) the integration of processes across firm boundaries are described in terms of types of process links: Managed Process Links, Monitored Process Links, Not-managed Process Links, and Non-member Links. Recognizing not all supply chain partners are equally important, the effort on managing the links should be differentiated accordingly. In the 1997 article, the emphasis is on the management component - no less than ten management components are identified based on a literature review. Besides the (by now) “classic” components “Planning and control”, “Work structure”, “Product flow facility structure”, and “Information flow facility structure”, the authors suggest a variety of other management components, such as organizational structure, product structure, power/leadership structure in the supply chain, and the cultural context (see Table 2-1 below).

Table 2-1: Identified Supply Chain Management Components⁵

	Planning and control	Work structure	Organization structure	Product flow facility structure	Information flow facility structure	Product structure	Management methods	Power & leadership structure	Risk & reward structure	Culture & attitude
Houlihan (1985)	✗	✗	✗	✗	✗	✗	✗			✗
Jones & Riley (1985)	✗	✗	✗	✗	✗		✗			✗
Stevens (1989)	✗	✗	✗	✗	✗					✗
Ellram & Cooper (1990)	✗	✗		✗	✗				✗	
Lee & Billington (1992)		✗		✗	✗					
Cooper & Ellram (1993)	✗	✗	✗	✗	✗		✗	✗	✗	✗
Hewitt (1994)	✗	✗	✗	✗	✗				✗	
Scott & Westbrook (1991)		✗		✗	✗	✗				
Towill, Naim & Wikner (1992)	✗	✗		✗	✗	✗				
Hammer (1990)	✗	✗	✗	✗	✗		✗		✗	✗
Andrews & Stalick (1994)	✗	✗	✗		✗		✗	✗	✗	✗
Cooper & Gardner (1993)	✗	✗		✗	✗				✗	✗
Lambert, Emmelhainz & Gardner (1996)	✗	✗			✗		✗		✗	✗

From Push to Pull

At the same time as the “process perspective” (Gripsrud, Jahre, & Persson, 2006) evolved and became “mainstream SCM” concepts like ECR⁶ and Lean Production (Womack, Jones, & Ross, 1990) provoked a shift from forecast-based production towards make-to-order. At least in principle inventory of finished goods was discarded and techniques like Value Stream Analysis (Hines & Rich, 1997) determined the decoupling point for modularization of products, minimizing the overall inventory cost or balancing it with end-customer lead time. Conceptually, activities within the supply chain (or rather: network) are perceived as driven

⁵ Source: Table 2 in Cooper, Lambert, & Pagh (1997), p. 8.

⁶ Efficient Consumer Response - replenishment program for the retailing industry. For more information, please see e.g. www.ecrnet.org.

by end-customer demand instead of the “pre-SCM” concept of forecasting⁷. These developments caused e.g. Christopher (1998) to propose replacing “Supply Chain” with “Demand Network”. The proposed term never really caught on...

Five Schools of Thought

The domain continued to evolve causing Bechtel & Jayaram (1997) to describe SCM in a framework of five schools of thought. From the initial work (called the Chain Awareness School) four separate strands of research were identified: the Linkage/Logistics School, the Information School, the Integration School, and The Future.

The Linkage/Logistics School distinguishes itself from the Chain Awareness School by laying out the linkages internally between functional areas and externally between the focal company and supply chain partners. The Information School emphasizes the flow of information between supply chain members, a flow that is bi-directional and not constrained by organizational boundaries. The Integration/Process School focuses on integrating the supply chains into a system defined as a set of processes. In this school, the idea of local (sub) optimization is abandoned as the ideal is the design of the entire system of processes to benefit all participating supply chain members. The goal is to optimize customer satisfaction through design of processes and solutions and subsequently the removal of redundancies.

The last school of thought in the framework, The Future, describes relationships and IT integration as means to further integrating the end users into the system of fulfillment:

“Traditional supply chain relationships capture sales data, and based on these data place orders with their suppliers, manufacturers, or distributors. New technologies such as EDI and ECR enable customer related information to be sent directly to suppliers, distributors, and manufacturers who can use this information to respond instantaneously to changing inventory levels. This represents the beginning of a SCM revolution which will capture and diffuse customer trends and preferences deep into supply chain member companies.”
(Bechtel & Jayaram, 1997, p. 20).

Albeit not explicitly described in the article, one gets the impression that the five schools are described as a chronology⁸. If so, little agreement on this classification is found in more recent review articles as e.g. Tan (2001) categorize the body of knowledge into: 1. Supplier Base Integration/SCM, and 2. Integrated Logistics/SCM and Croom, Romano, & Giannakis (2000c) into: 1. Strategic Management, 2. Logistics, 3. Marketing, 4. Relationships/partnerships, 5. Best practices, and 6. Organizational behavior. Where Bechtel & Jayaram give the impression of a few competing strands of research pointing towards a coherent body of knowledge, later reviews document the opposite: the research is getting more and more dispersed⁹.

⁷ Naturally forecasting is still critically important as only very few supply chains have access to “excess inputs on stand-by”.

⁸ Actually, the model might suggest that the Linkage/Logistics School has a different object (transportation), whereas the Information and Integration/Process Schools describe a more general trend leading towards The Future.

⁹ In Gibson, Mentzer, & Cook (2005) the multiplicity of definitions of SCM documents the dispersion.

Critical Voices...

This has caused a number of authors (e.g. Larson & Halldorsson, 2002; Fawcett & Magnan, 2002) to question the relevance and/or existence of SCM - others try to map out the theoretical foundation for SCM (e.g. Halldorsson et al., 2004).¹⁰ In a recent article Giannakis, Croom, & Slack (2004) similarly try to describe the key event leading to and the development of SCM. Using three basic dimensions of supply chain decision making they propose a model (see Figure 2-3) describing the development (leading to and) within SCM. The authors define the three dimensions as:

“Synthesis ... describe[s] the strategic decisions related to the structure of supply chains primarily to reflect the importance of the characteristics relating to the construction of supply chains. ...

Issues of synergy are concerned with the manner and form of interactions and relationships across supply chains. ...

The dimension of synchronization is primarily concerned with the management and coordination of resource flows across supply chains.” (pp. 14-15).

The overall domain of SCM is thereby described by its structural characteristics, the relationships and the efficiency of the overall structure. The legacy from OM is present in the references to Operational Research, Inventory Theory, Manufacturing Theory, and The Transformation Model. On the relational side references are made to Open Systems Theory, Social Network Theory, and The Interaction Model (IMP). Claiming a multi-disciplinary and multi-methodological foundation for SCM seems almost an understatement.

Figure 2-3: Chronology of influences on SCM¹¹

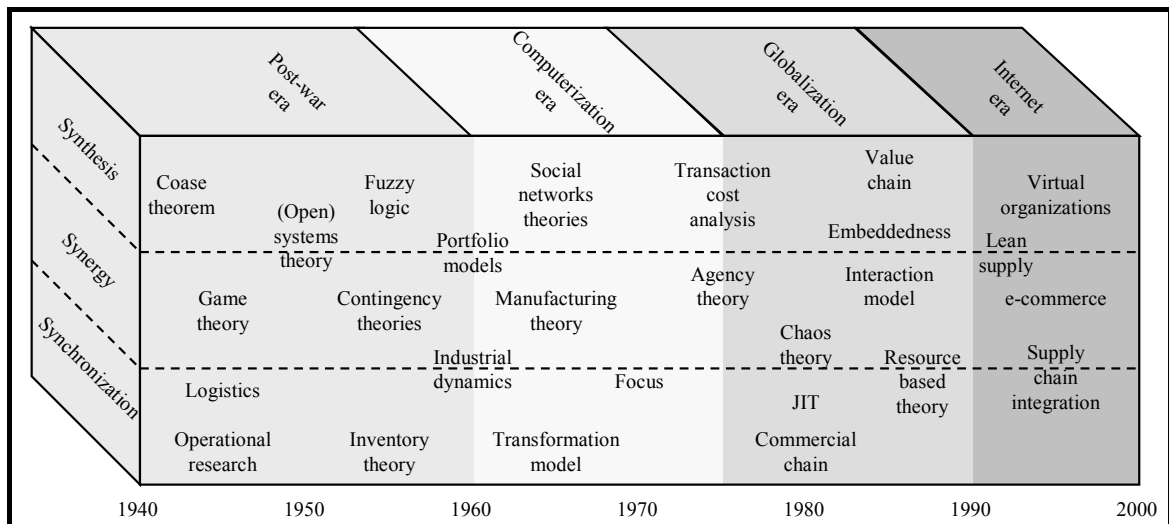

¹⁰ In a recent article Gammelgaard (2004) calls for more methodological diversification in the research within SCM. She claims the Analytical and Systems approaches in Arbnor & Bjerke (1997) framework have been dominant within the domain, and advocates the use of the Actor approach as well.

¹¹ Source: Figure 1.3 in Giannakis, Croom, & Slack (2004), p. 16.

Concerns on SCM Theory

Also in terms of theory concerns are raised. In Burgess, Singh, & Koroglu (Burgess, Singh, & Koroglu, 2006) an extensive literature review on SCM is reported, and the authors comment:

“For the field of SCM, the extent to which theories have been developed appears to be slight. The development of SCM appears to have been largely practitioner-led, with theory following. ... Of all the articles that adopted theoretical perspectives, none proposed an original SCM theory.” (p. 711), and

“It is possible that the current state of theory development in the field could be preventing its evolution towards a more mature status.” (p. 717).

These concerns are supported and extended in Storey et al. (2006):

“If supply chain management is to mature as a discipline there needs to be further progress in clarifying its domain, its central problems, its core components, its theories and its theoretical map.” (p. 755).

Concepts for Improving Business-as-Usual

In the midst of all this diffusion a number of concepts seem to survive over time: Just-in-Time (JIT) (e.g. Schwarz & Weng, 2000), Vendor Managed Inventory (VMI) (e.g. Blatherwick, 1999), and ECR (e.g. Sabath, 1998). Certain principles likewise seem to receive continued attention: Supply Chain Integration (e.g. Bagchi & Skjøtt-Larsen, 2002b; Langabeer & Seifert, 2003; Lee, 2000), Postponement (e.g. Pagh & Cooper, 1998), Mass Customization (e.g. Gilmore & Pine, 1997), and Leanness/Agility/Leagility (e.g. Mason-Jones, Naylor, & Towill, 2000b). Albeit quite different, they all focus on the same: increasing the efficiency of business-as-usual.

2.2 Risk Management

In e.g. Barlow (1993) the evolution of modern risk management is described. In the beginning (the 1960's) risk management was basically insurance buying¹², but as exposures increased the insurance buyer in the finance department was replaced by insurance managers cooperating with the other departments in the company. Following the expansion and diversification of the enterprise, the responsibilities of the insurance manager changed from insurance buying to examining the enterprise for uninsured risks and implementing various types of risk prevention schemes etc. According to Barlow the title “risk manager” was first proposed by Wayne Snider in 1955, the term Risk Management was introduced the following year in an article in *Harvard Business Review* (Gallagher, 1956). In the early days of “risk management”, the management component took the form of insurance buying to minimize the exposures. Focus was on the downside only:

¹² In Englehart (1994) the history of corporate insurance is dated back to at least 1878, where one of the railroad companies created such a function. Corporate insurance functions became popular during the 1930's; the American Management Association initiated an Insurance Division in 1931. By the 1950's the use of a separate function for insurance monitoring was widespread among large corporations.

“...the field of risk management is that of ‘pure risks’, meaning risks offering the possibility of loss or no loss, as contrasted by ‘speculative risks’, which offer the chance of loss or gain and are the domain of entrepreneurs, boards of directors, and CEOs.” (Barlow, 1993, pp. 38-39).

The goal of the risk manager was clearly cost-minimization as:

“...each of the insurable risks to which an organization is exposed should be seen as a cost composed of the interrelated factors of loss prevention, insurance premiums, losses sustained net of indemnities from insurers and third parties, and expense of administration; and secondly, that the objective of risk management should be to minimize the cost of the risks by changing amenable factors as appropriate...” (p. 39).

In Englehart (1994) a similar history of the development of insurance buying into risk management is told. Following an analysis of the use of the term “risk management” in the period 1956 to 1990, Englehart concludes that:

“... the field of risk management is not dying, but rather [that] it is being divided into smaller units for discussion and analysis.” (p. 68).

Soon the responsibility of the risk management department encompassed the management of e.g. credit, interest rate, currency, commodity, equity, and liquidity risks. The commonality between all these types of risks were the reliance on objective measures obtained through ingenious mathematical models. From the simple “Probability times Impact” equation the domain of risk measurement now had evolved into sophisticated models analyzing patterns of events to determine correct values for the risks¹³.

At the same time as the mathematics used to control financial risks got more and more sophisticated the scope of the risks to be managed increased. The new risks presented a real problem to the domain, as the underlying “mechanisms” were less understood or even eluded description. The introduction of these new risks resulted in the division of the domain of risk management into Financial Risk Management (FRM) and Business Risk Management (BRM), the former primarily relying on measures obtained from sophisticated mathematical and statistical models, the latter on intuition and experience. The management of business risks became (at least partly) a responsibility of management whereas the financial risks were firmly rooted in the finance departments.¹⁴

¹³ From the mid-1990’s the concept Value-at-Risk (VaR) has become an “industry standard” using historical data to predict probable impact within a certain time period (Banks & Dunn, 2003). For a critical perspective, see Ju & Pearson (1998).

¹⁴ SCRM is considered a true subset of BRM.

Risk Management Approaches

Evolving through the 1980’s and 1990’s various integrated approaches like Integrated Risk Management (IRM) (e.g. Doherty, 2000) and Organization/Enterprise-Wide Risk Management (ORM/ERM) (e.g. Young & Tipping, 2000; DeLoach, 2000) were introduced, advocating the strategic importance of an integrated approach to the management of business risks¹⁵. In Williams (1996) the new integrated paradigm contrasts the “old paradigm”.

Table 2-2: Re-inventing Risk Management¹⁶

Old Paradigm	New Paradigm
Risk Management applied only to pure risks	Risk Management applied to pure and speculative business risks
Functional approach, limited to the risk management department	Process approach transcending functions and divisions
Operational perspective	Operational and strategic perspective
Risk manager	Risk process manager or risk champion
Senior management support	Senior management support and involvement
Insurance jargon understood by a few	Common risk language understood from the boardroom to the boiler room

Further enhancing the concept of ERM a voluntary organization, The Committee of Sponsoring Organizations of The Treadway Commission (COSO) engaged PricewaterhouseCoopers to develop an “integrated framework for enterprise risk management”. Two reports have been published (PriceWaterhouseCoopers, 2003; PriceWaterhouseCoopers, 2004)¹⁷ providing companies with a framework for process-oriented risk management across the enterprise and a definition of ERM:

“Enterprise risk management is a process, effected by an entity’s board of directors, management and other personnel, applied in strategy setting and across the enterprise, designed to identify potential events that may affect the entity, and manage risks to be within its risk appetite, to provide reasonable assurance regarding the achievement of the entity objectives.”
(PriceWaterhouseCoopers, 2004, p. 3).

The Risk Management Process

The shift from insurance buying to risk management called for a new way of working, a process which is almost universally agreed upon within the domain (e.g. Sadgrove, 1996; Vaughan, 1997), see Figure 2-4 below.

¹⁵ One might say that Risk Management became strategic as Strategic Management might be perceived as the “management of speculative risks” (Williams, 1996). See also Figure 2-4.

¹⁶ Source: Exhibit 1 in Williams (1996), p. 24.

¹⁷ For more information on the COSO/ERM framework, please see Appendices B and K.

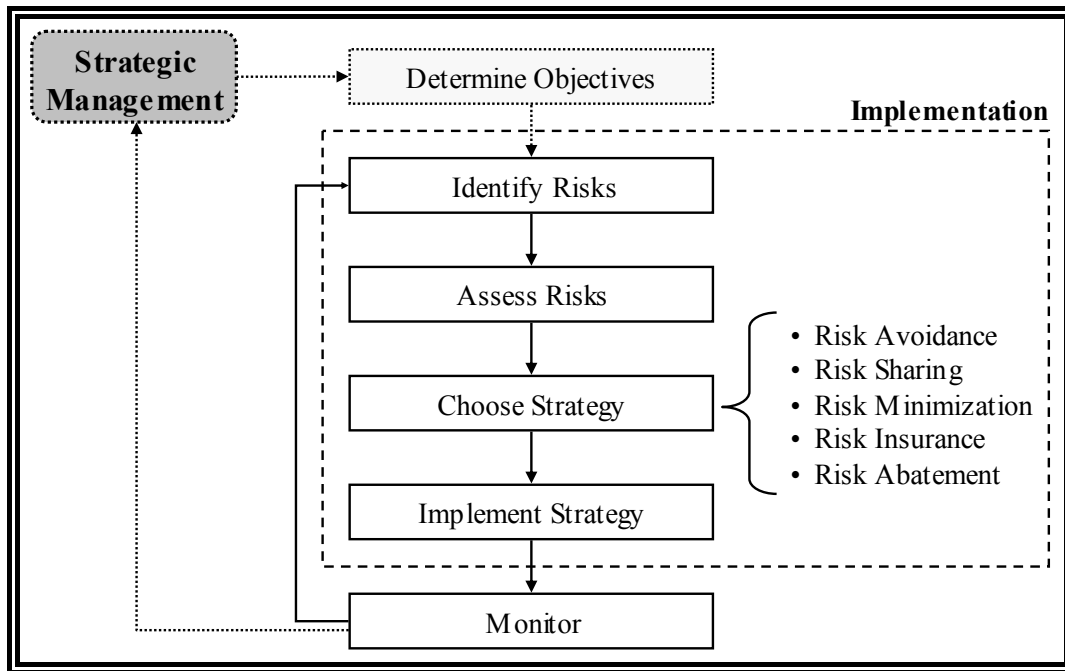
Figure 2-4: The (Business) Risk Management Process

Whether the objectives are set within or outside the risk management process is a disputed issue but the interaction between Strategic and Risk Management is undisputed. The holistic approach implied above seems to fit perfectly with the inter-organizational scope of SCM.

2.3 Corporate Governance¹⁸

Also emerging through the 1990's Corporate Governance describes the good practices identified in leading companies. In USA the Enron scandal and the scandals following that resulted in a dramatic loss of trust in the American stock market. The American government had an urgent need to amend this lack of trust, and to that end the Sarbanes-Oxley Act was passed in July 2002. The Sarbanes-Oxley act lays out certain rules and principles for the companies to follow, and gives the Securities and Exchange Commission (SEC) competence to further specify rules and regulations regarding the trade of securities. The generic principles aim at:

1. creating more transparency regarding the management of the companies,
2. strengthening the internal control and reporting in the companies, and
3. strengthening the control with the companies' external auditing.

All three principles support the need of the actors in the stock markets for a better appreciation of the worth of the companies by creating sounder management principles and a more reliable reporting. Besides the act and the further development by SEC the individual stock exchanges developed their own set of rules for Corporate Governance¹⁹.

¹⁸ This section relies heavily on Chapter 1 in Iversen (2004).

¹⁹ Both NYSE and NASDAQ have published a rule set for Corporate Governance, see NYSE (2003) and Emen (2004), respectively.

In the European Union (EU) a comparison of the Corporate Governance guidelines of the individual member states²⁰ led to the development of a plan of action for the harmonization of rules and principles across all member states. In the plan the Commission, contrary to the practice in the USA, did not recommend the development of a detailed codex for Corporate Governance but focused on:

1. strengthening the requirements on external reporting,
2. enhancing the rights of share holders, and
3. modernization of the work performed by the members of the board.

Furthermore the Commission suggested that the financial statements from companies registered on the stock exchange should contain a section on Corporate Governance initiatives, or an explanation of why Corporate Governance is irrelevant (the “comply or explain” principle). Following the receipt of feedback on the plan of action and suggestions the Commission has started the work on modernizing and harmonizing Corporate Governance across member states. In March 2004 a suggestion concerning the mandatory auditing of registered companies was put forward, suggesting rules for changing responsible accountant much resembling the American rules. More proposals are anticipated.

Danish Initiatives

For unknown reasons Denmark was one of the last countries in Europe to commence working with Corporate Governance²¹. Speculation will have it that perhaps the Nordisk Fjer scandal (resembling the before mentioned Enron scandal) was the catalyst to strengthen the regulations ensuring independence between management of the firm on the one side and the board and auditors on the other. In March 2001 Ole Stavad, the Minister of Economic and Business Affairs of that time, commissioned four highly respected Danish businessmen to further develop the ideas presented in the report from 1999 and draft a guideline for Corporate Governance. Three quarters of a year later the “Nørby commission” published a report containing voluntary guidelines for Corporate Governance in Denmark²². The report focused on seven main areas:

1. The role of the shareholder and the interaction with the management of the company
2. The role of the stakeholders and their importance to the company
3. Openness and transparency
4. The tasks and responsibility of the board
5. The composition of the board
6. The compensation of the board and the directors
7. Risk Management

²⁰ See Weil, Gotshal, & Manges (2002).

²¹ According to Iversen (Iversen, 2004), the first official Danish contribution was the report “Debatoplæg om aktivt ejerskab” (Ministry of Finance, 1999) – a product of a joint collaboration initiated in 1997 between The Ministry of Economic and Business Affairs, The Ministry of Finance, and The Ministry of Taxation. The report can be downloaded from the homepage of the State Employer’s Authority (www.perst.dk).

²² “Nørby-udvalgets rapport om Corporate Governance i Danmark – Anbefalinger for god selskabsledelse i Danmark” (Nørby Johansen et al., 2001).

The report caused quite some debate. Some commentators rejected the proposals in the report as they were perceived being too narrowly defined and restrictive, whereas others considered the proposals being too operational. Nonetheless, the community embraced the report for its intent: to improve the practice of corporate management and to provide a starting off point for further debate. The Copenhagen Stock Exchange immediately after publication recommended companies being traded on the stock exchange to apply the recommendations put forward in the report, a recommendation which was adhered to by more than half of the companies in their financial statements in 2003.

Since the initial report was published the Copenhagen Stock Exchange has been the main driver of Corporate Governance, as two reports have been published so far: “Report on corporate governance in Denmark”²³ (Fondsbørsen, 2003) and an updated version in 2005.

Recommendations on Risk Management

Of special interest here is naturally the content on Risk Management. In the original report the commission under Chapter VII “Risk Management” recommended:

“Effective risk management is a prerequisite for the board to perform the tasks it has been appointed to do. It is therefore crucial the board ensures appropriate systems to the management of risks are present, and further ensures the systems match the requirements of the company.” (translated from Fondsbørsen (2005), p. 58).

The report promoted the focus of the risk management was to support the company in reaching its goals by:

1. making sure strategic and operational goals are known and understood throughout the organization,
2. analyzing threats and opportunities relating to above mentioned goals, and
3. analyzing the core activities of the company to identify risks.

Furthermore it is recommended that the risk management is evaluated at least yearly, with special attention given to insurance, foreign currency, and investment policies. Besides insisting Risk Management is a part of Corporate Governance, the recommendation did little in way of supporting the development of a practice as no tools, methods or frameworks were supplied. In the latest report the section on Risk Management has been revised. Besides the original recommendations, it is now recommended that the Board and the Management when developing the overall business strategy also identify and describe the major risks. Management is furthermore encouraged to develop a plan for risk management for approval by the Board. The plan should include periodic reporting and evaluation of the risks identified, as well as strategies for the management of the risks. Finally the report recommends openness by suggesting a section in the Annual Account for description of the risk management activities.

²³ Translated from: ”Rapport om god selskabsledelse i Danmark – Fondsbørsens komité for god selskabsledelse”.

Risk Management is definitely on the agenda within Corporate Governance, albeit the recommendations still does little in guiding implementation. The recommendations also have a shortcoming in relation to SCM as the view of the company in the reports does not support the notion of supply chains. Nonetheless, the recommendations might have an impact on the external reporting, if not directly on the practice of SCRM.

2.4 Combining SCM & Risk Management

The need for risk management is not a new claim, though. From the earliest contributions to the field, there has been an emphasis on stability and robustness. The aim is to balance resources and

“...that an integrated systems strategy that reduces the level of business vulnerability is developed and implemented.” (Oliver & Webber, 1982, p. 66).

The fragility of the supply chain is duly noted in another early contribution:

“If one activity fails, the chain is disrupted, creating poor performance and destabilizing the workload in other areas, thereby jeopardizing the effectiveness of the supply chain.” (Stevens, 1989, p. 3).

The previously mentioned “Bullwhip Effect” (Forrester, 1961; Lee, Padmanabhan, & Whang, 1997) becomes a life-threatening phenomenon when buffers are low and integration is high. The reduction of inventory, shortening of lead times, and outsourcing of activities leave companies vulnerable not only to these “simple” fluctuations, but to any kind of disruption as redundancy is low. When viewed from a risk management point of view, it becomes apparent that the integration must have a “maximum level”²⁴, that the extreme reliance on external partners is a very dangerous strategy. Conversely, it is understood that fast product development is a necessity to remain competitive (in some markets).

Using chaos theory and perceiving supply chains as complex systems Wilding (1998a) introduces “The Supply Chain Complexity Triangle” (see Figure 2-5 below). The three sources of uncertainty generation are: deterministic chaos, parallel interactions, and demand amplification. The “Forrester effect” is well known, but the impacts of parallel interactions (shifting demand from one supplier to another) were not considered in the SCM domain, albeit definitely within “Systems Dynamics”. The last factor creating uncertainty, the deterministic chaos, is described as resulting from supply chain decision-making and supply chain control systems²⁵. The argument on supply chain decision making basically relies on the “Forrester effect” – aggressive stock adjustment policies will affect all supply chain members. Removing the human component from the system does not help either:

“Increasingly within industry, managerial decision-making rules are being formalised by computer algorithms. A conclusion that can be drawn is that if such algorithms are inappropriately designed, chaotic behaviour can be

²⁴ The “maximum level” might be perceived as a measure for “loss exposure” (e.g. in terms of days of interruption).

²⁵ This is in line with the skepticism towards the ideal of the fully integrated supply chain put forward by New (2004).

generated, thus contributing to the uncertainty experienced in the supply chain.” (p. 602).

Having modeled supply chains and various types of control mechanisms, Wilding continues:

“The main emphasis of the investigation is to quantify how the increasing complexity of the supply chain resulting from increasing the number of echelons and/or channels impacts on the degree of chaos... The investigations demonstrated that warehouse supply chain acted as characteristic chaotic system exhibiting sensitivity to initial conditions, ‘islands of stability’, characteristic patterns, the ‘reductionist view’ was invalidated, and finally, that chaos undermined computer accuracy (Wilding, 1998b).” (p. 603).

Figure 2-5: The Supply Chain Complexity Triangle²⁶

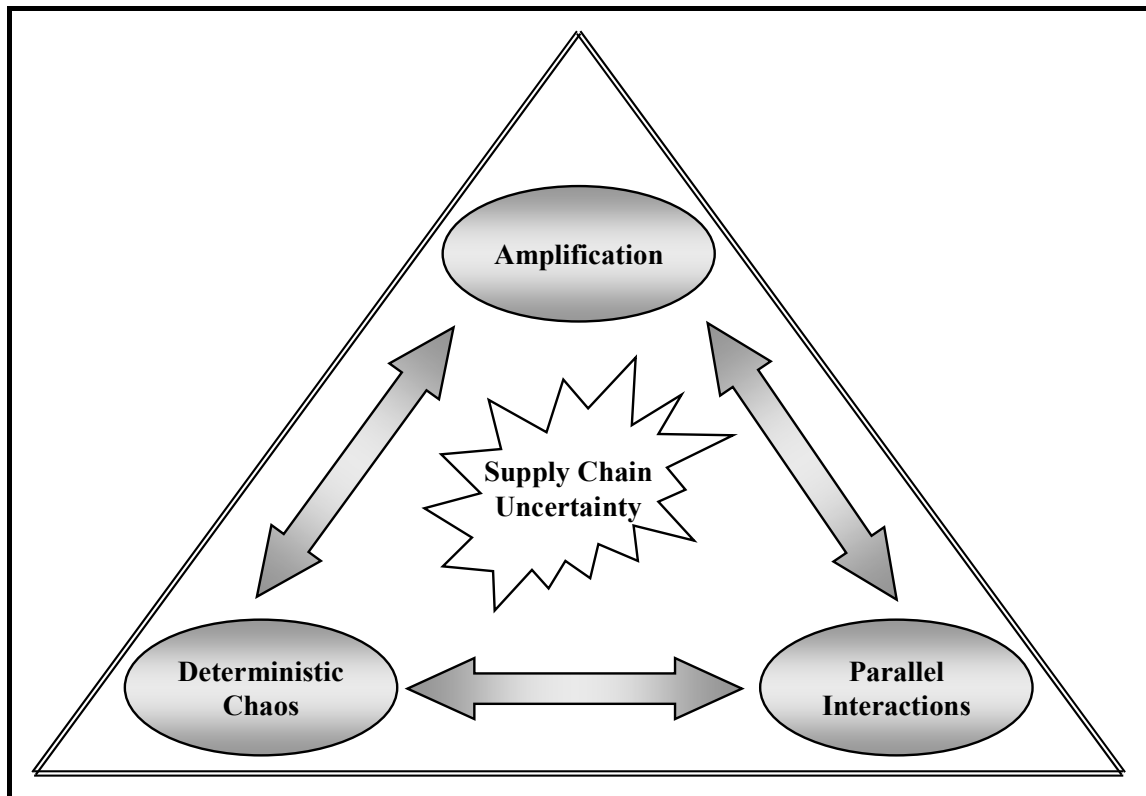

So, on the one hand SCM holds a promise that the closer integration leads to better performance, and on the other is the claim that complex systems generate chaotic behavior. It becomes evident that designing the supply chain is a critically important task. But it is also evident that the objectives of and perspective on the supply chain(s) will influence the “optimal” design.

2.4.1 Choosing a Perspective on SCM

As described previously the origins of SCM are logistics and manufacturing but the focus of SCM has dispersed across almost any type of activity, supporting any rationale or objective (Storey et al., 2006; Burgess, Singh, & Koroglu, 2006). Furthermore the acronym SCM has

²⁶ Source: Figure 1 in Wilding (1998a), p. 600.

been widely used to add a sense of novelty to existing frameworks/concepts. This problem is broadly recognized, e.g. Cooper & Ellram (1993) state:

“To consider supply chain management to be a different approach from other channel relationships, there should be some characteristics that could be used to differentiate it.” (p. 15), and

“Since the original goal of supply chain management is system-wide inventory reduction, this characteristic should exist in all supply chains.” (p. 22).

On choosing a perspective on SCM the author therefore chooses to address personal aversions in the SCM literature, aversions which relate to:

- Type of organization (service vs. manufacturing)
- Innovation (product and process) vs. operation
- Current process models

These aversions are described in more detail below.

Aversion One: Service versus Manufacturing Organizations

To the author the notion of SCM in service organizations does not make much sense. Service organizations resemble manufacturing organizations in that they also need to perform e.g. capacity planning and make sure the internal infrastructure enables employees to perform the needed activities with the right timing, sequence etc. But service organizations do not have an upstream supply chain as their primary input is the knowledge (or at least the presence) of their employees. Obviously, most service organizations have the need for certain physical inputs (e.g. paper for the printers at a car rental agency), but these relate to the enablement of the service, and is not a part of the service as such.

Aversion Two: Innovation versus Operations

The second aversion is the meshing together within the SCM domain of innovation and operations. Intuitively, closer interaction between supply chain partners might lead to better innovative processes and better products, but might just as well lead to the opposite. An extensive European survey performed in 2002 (Bagchi, Skjøtt-Larsen, & Sørensen, 2003) revealed amongst other things that performance was perceived to be decreasing with the length of the relationship. This definitely counters the argument of improved innovation.

On a more conceptual note, the difference in time perspective (innovation versus operations) gives rise to more skepticism as does the issue of participation. The existence of professional product development agencies conflicts with the notion of tight integration as these partners will participate in innovation only, and leave when innovation goals are reached. Figure 2-6 below illustrates the “Innovation Perspective” as understood by the author.

Figure 2-6: The Innovation Perspective

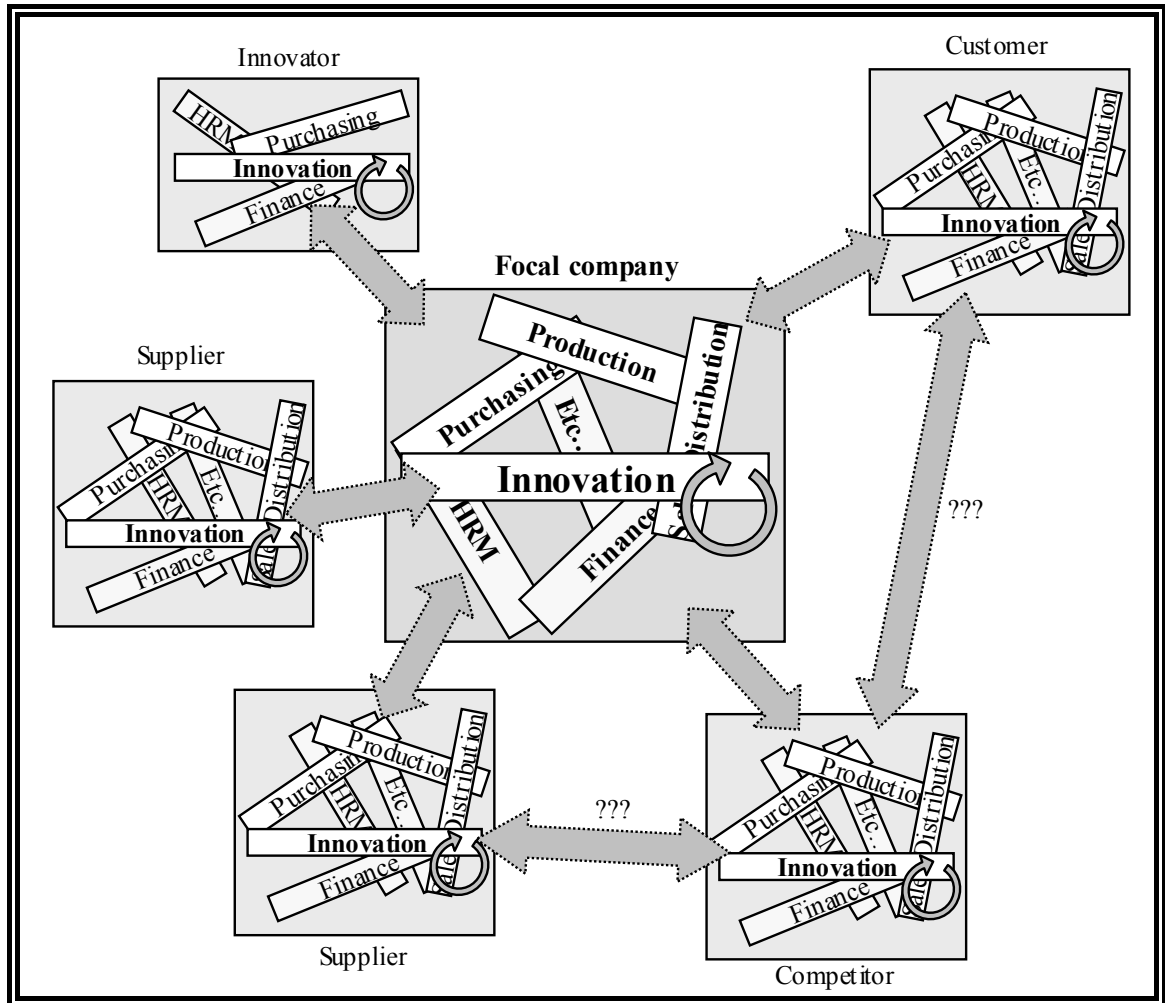

Albeit product innovation is becoming an ongoing task for many companies, it is still beneficial to view innovation (at least when innovating with external parties) as separate projects²⁷. This further complicates the membership issue as certain parties are member in innovation projects for a limited period of time only.

In contrast hereto, the fulfillment perspective presents a more stable constellation of companies participating in the fulfillment of end-customer needs. Borrowing from Porter's Value Chain (see Figure 2-7 below), a distinction is made between primary and secondary (support) activities. Primary activities are the activities directly oriented towards the fulfillment of end-customer needs: Purchasing, Production, and Sales/Distribution.

²⁷ For incentive and risk management (if for no other) reasons. Behavior of external parties may be adjusted through re-negotiation of innovation contracts. External parties may then have a strong incentive to behave non-opportunistic. It may also have a performance perspective.

Figure 2-7: The Generic Value Chain²⁸

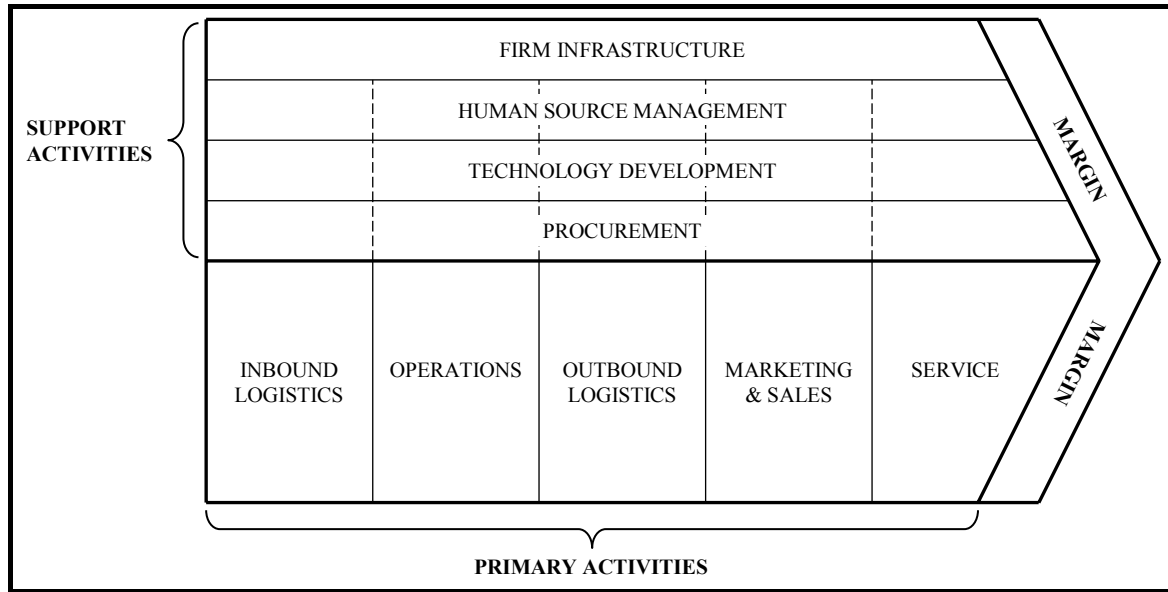

The concept of SCM extends further than the concept of Value Chain, though. The holistic perspective, the ideal of aligned strategies and of appropriate integration of processes across corporate boundaries makes SCM a much more sophisticated framework. The inclusion of external parties both up- and downstream as critical entities in fulfilling end-customer needs differentiates SCM from other concepts, and adds complexity as the before mentioned “membership issue” becomes critically important.

Figure 2-8: The Fulfillment Perspective

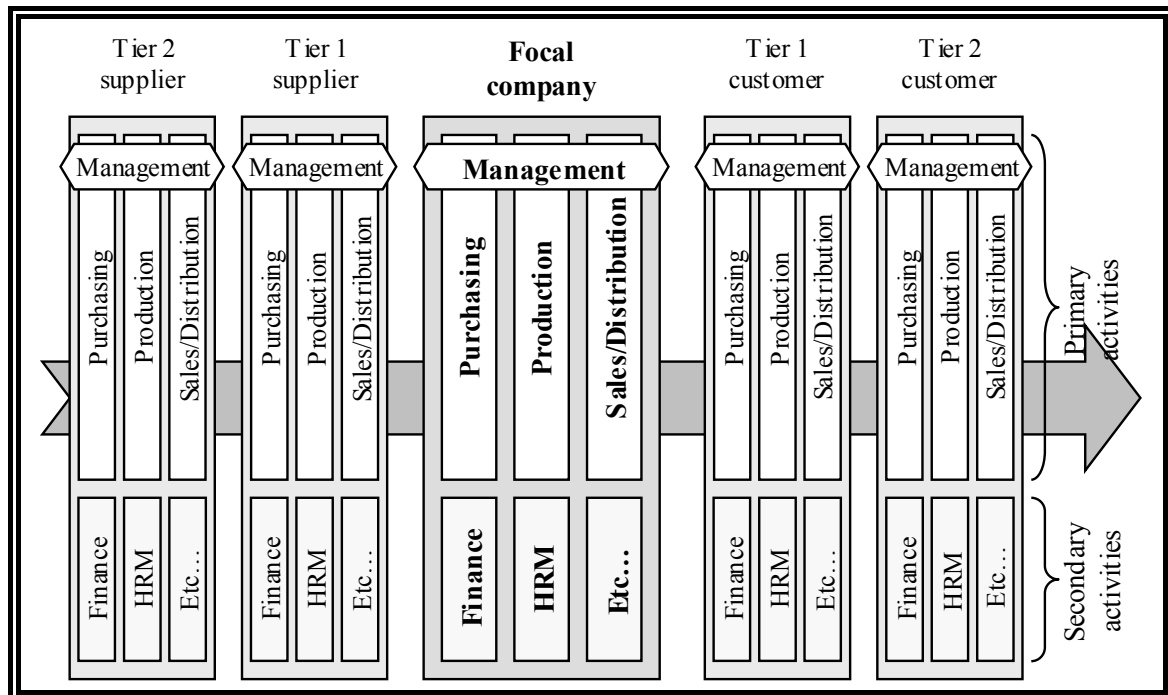

²⁸ Source: Figure 2-2 in Porter (1985), p. 37.

But as a certain degree of stability is to be assumed²⁹, membership is determined through participation in meeting the “meta-objective” of the supply chain as a “fulfillment system”. A graphical illustration of the fulfillment perspective is shown in Figure 2-8 above.

Aversion Three: Current Process Models

The last aversion to be described here is an objection towards the highly influential model put forward in Cooper, Lambert, & Pagh (1997), see Figure 2-2. In this model all processes cross all participating supply chain members, and all functions within each company participate in all processes. To this author the focus on operations clearly illustrates the distinction between primary and secondary activities. Functions like HR and Finance are crucial to the survival of the company but do not participate directly in operations. Research and development is obviously of critical importance but again: does not participate in the fulfillment of end-customer needs.

Figure 2-9: Supply Chain Process Model

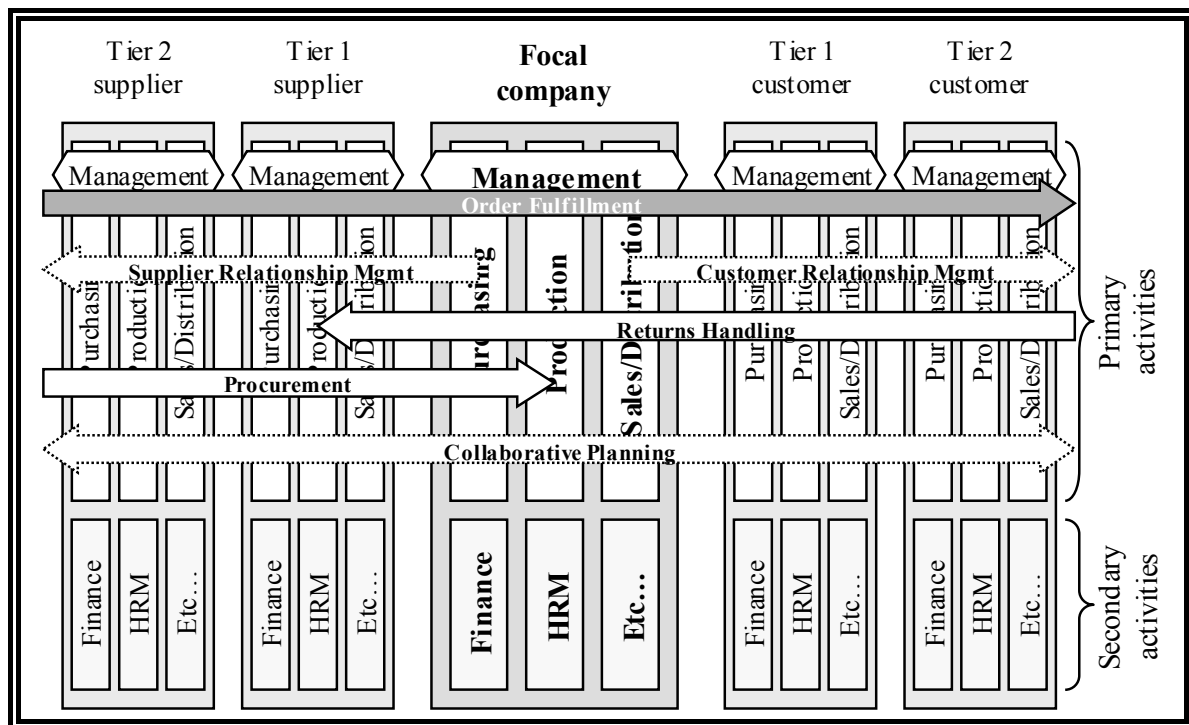

The names of the processes suggested in Figure 2-2 set aside, it seems obvious that processes have different scopes, e.g. that the process “Supplier Relationship Management” points upstream only and the process “Customer Relationship Management” points downstream³⁰. Whether these processes encompass more than the first tier or not will depend on the context, e.g. the power distribution in the supply chain. These processes, and other processes like

²⁹ In some articles the concept of Virtual Enterprise (VE) is considered a form of SCM. This is rejected by the author, primarily due to the temporal nature of the relationships promoted in VE. For a comparison of SCM and VE, see Pires et al. (2001).

³⁰ In the tradition of explaining SCM from the point of view of “the focal company”, relationship management with suppliers will naturally differ from the relationship management with customers albeit the overall goals are identical: to ensure win-win in the long term.

“Collaborative Planning”, “Procurement”, and “Returns Handling” are examples of processes supporting the “meta-process” of “Order Fulfillment” as illustrated in the Supply Chain Process Model depicted in Figure 2-9 above.

Choosing a Perspective

The elaboration over the author’s personal aversions has resulted in this dissertation focusing on manufacturing firms. By choosing the “Fulfillment” perspective the supply chain is perceived as a “long-linked technology” (Thompson, 1967). Interdependence is constituted (in part) by the activity dependency (same author) and the supply chain becomes a system which can be designed. Fulfillment is the “meta-objective” crossing legal boundaries, justifying the holistic approach and the emphasis on win-win to create long-term, stable organizational structures to achieve corporate and shared goals for the entire supply chain. This should in no way be perceived as a rejection of the importance of innovation in process or product, but simply that the “raison d’etre” for SCM is to optimize the fulfillment of end-user demand. Innovation is crucially important to most companies, but is perceived as different from SCM. Finally, recognizing the process orientation is crucial to SCM, the emphasis on fulfillment is supported by the elaboration over the scope and relevance of processes. The “Order Fulfillment” process is therefore perceived as the “meta-process” of SCM, and the principal object for risk management.

2.4.2 Designing for Supply Chain Stability

Ensuring the stability of the “Order Fulfillment” process is thereby the objective when designing the supply chains of a company. For the process to perform satisfactory throughput should be kept at the anticipated level at all times, requiring the minimization of disruptions of the in-flow and of the performance of internal operations. In case disruptions from internal operations are persistent activities may be outsourced; alternatively if activities are performed outside the organization they may be insourced to obtain control.

Using outsourcing to reduce disruptions may be a risky option as it exposes the company to the risk of sudden exits of the outsourcing party. This risk may be mitigated by the use of contracts, but contracts may be useless if size disparities exist, or if the outsourcing party ceases to exist (e.g. bankruptcy or explosion/fire).

Overall, one might say that *ceteris paribus* risks should be avoided or minimized to the degree costs can be justified, and as long as the strategic ambition of the supply chain is not jeopardized. Comparing with a popular OM author’s design model provides interesting insights, see Figure 2-10 below.

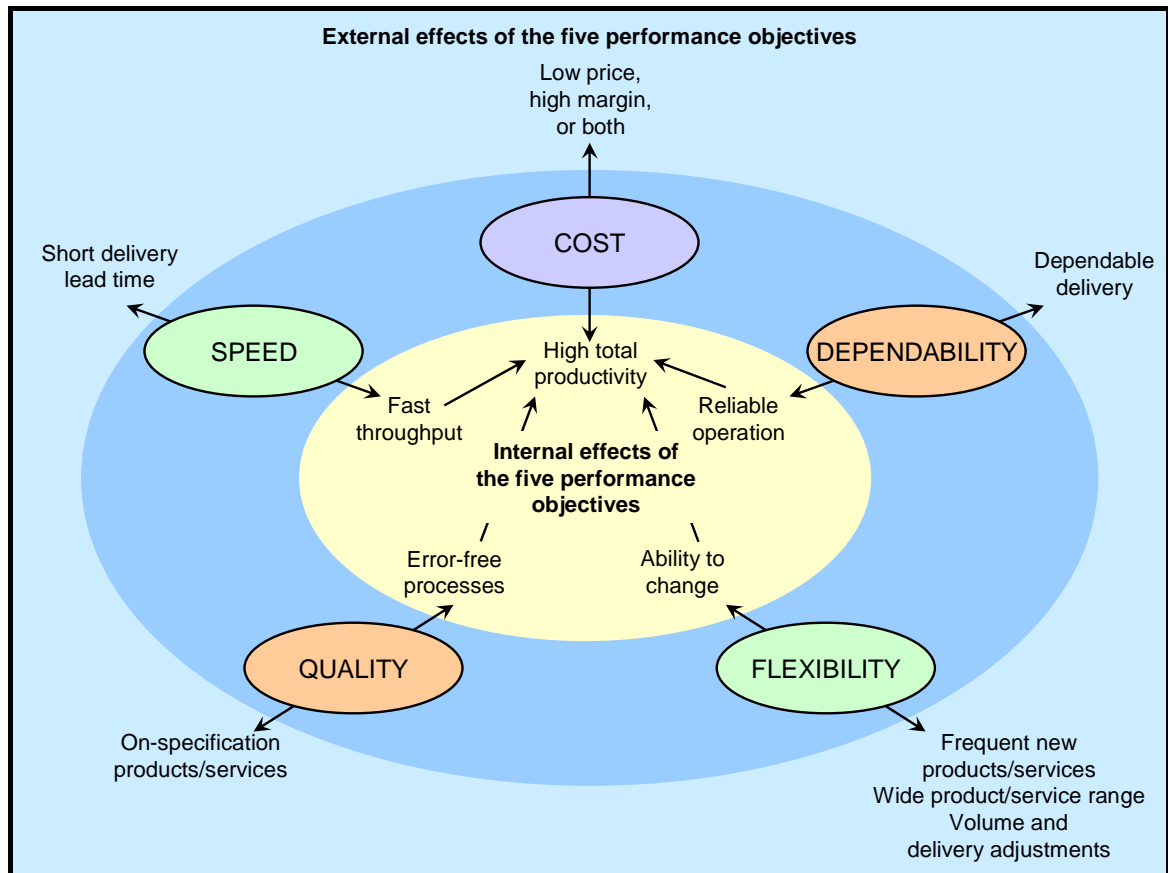
Figure 2-10: Performance objectives...³¹

First and foremost it is evident the risk objective is missing from the model. This may be either a crime of omission, or a distinct choice by the author, but it seems obvious that the risk of failure must be part of the decision when evaluating performance objectives. In other words, risk must be part of this typology of performance objectives, and must even have a special status along with cost.

Another insight is that (production) systems are designed for a multiplicity of goals, of which risk and cost must always be part. It would be hard to imagine a production engineer having a long career at a company if the (production) system was designed to achieve a given goal (e.g. flexibility) but paid no attention to neither risk nor cost. Albeit the former might not be a problem in the short run (as failures are not necessarily evenly distributed over time) the lack of attention paid to the cost objectives will quickly be identified.

Also, it may be intuitively understood that the pursuit of one objective might result in poorer performance on another. E.g. raising the quality of the product over a certain threshold might cause excessive cost increases, or pursuing a strategy of speed might increase risk of failure as buffer (in the shape of time) is removed from the system. A further complexity is naturally experienced when a company services more than one market or supplies more than one product (or in other words: have more than one business model/supply chain).

³¹ Source: Slack, Chambers, & Johnston (2004), p. 57.

Achieving Stability

For these reasons designing supply chains for stability is quite a challenging task – balancing objectives for each supply chain with risk and cost, and obtaining synergies or acceptable compromises across supply chains (in case the company has more supply chains).

The design task in itself might include redistribution of activities, by in- or out-sourcing as mentioned above, or by redesign of products. Also the implementation of various production and distribution concepts (various types of postponement, mass customization, decentralized inventories, the use of TPL's etc.) might prove beneficial in achieving the defined goals. Concurrently with the evaluation of the objectives an analysis of risk and cost must be performed, creating a foundation for decision making supporting the long-term survival of the company.

2.5 Introducing the Supply Chain Risk Matrix

Perceiving supply chains as “long-linked technologies” (Thompson, 1967) supports the use of systems theory. In systems theory the concepts Structure and Process are routinely used to describe the system and its activities. These concepts are also well known and used within SCM (e.g. Gammelgaard, 2004; Holmberg, 2000; New, 1997) and Supply Chain Design (e.g. Korpela, Lehmusvaara, & Tuominen, 2001a; van Hoek & Weken, 1998). Intuitively, this division corresponds to the structural and process aspects of managing risks in the supply chain. The Structure component translates into the risk of managing “the sudden departure of a critical supply chain partner” where as the Process component translates into the risk of a “disruption of the material flow”.

But, from a risk management perspective, also moral hazard (Arrow, 1965) is of critical importance. Managing the risk of an intentional disruption is quite different from managing the un-intentional ditto. In the former case writing up a contract might take care of the problem whereas the latter might include monitoring of operations at the suppliers' sites, and the creation of redundancies in form of e.g. long lead times downstream and various levels of inventory throughout the supply chain. The related term information asymmetry (Arrow, 1963) explains how information availability enables a party to make more informed decisions – like initiating or ending a business relationship. In unison these mechanisms may be grouped under the term intentionality as the critical aspect is whether or not disruptions and exits are a result of a deliberate strategy or the inherent chaos of any business context.

Combining Intent with Systems Theory Components

Combining the systems theory components with intentionality result in the Supply Chain Risk Matrix depicted below in Figure 2-11. In realizing some supply chain partners are non-critical, the identification of supply chain risks will depend on the classification of the supplier and/or customer (critical/non-critical). The management of structural risks is thereby a matter of design, minimizing the impact or likeliness of a departure of a critical supply chain

partner³². On the process side, the design must assure resilience towards disruptions, or minimize the likeliness of the occurrence. The supply chain must be designed, not only to withstand the occurrence of the above mentioned risks, but to meet the defined goals (cost, responsiveness etc.) of each supply chain as well.

Figure 2-11: The Supply Chain Risk Matrix

		Intent	
		No	Yes
Systems Component	Structure	The un-intentional, sudden exit of a critical supply chain partner.	The intentional, sudden exit of a critical supply chain partner.
	Process	The un-intentional, sudden disruption of the material flow.	The intentional, sudden disruption of the material flow.

The Use of the Supply Chain Risk Matrix

The model described above is the principal model in this dissertation as it details the risks under scrutiny. Therefore the model is referenced in most chapters (sometimes supplemented by Figure 2-9) containing analyses, describing e.g. in Chapter 4 how state-of-the-art Supply Chain Design addresses the management of supply chain risks.

In the next three chapters the literature and theory reviews will document the level of support to the model.

³² E.g. choosing to use single-sourcing means accepting a higher impact of the exit of the supplier as no alternatives are readily available. Choosing dual sourcing instead probably means higher prices (due to less volume) but less impact in case one of the suppliers should exit. See e.g. Treleven & Schweikhart (1988) for a risk/benefit analysis of sourcing strategies.

PART II

**LITERATURE AND THEORY
REVIEWS**

Chapter 3 Risk, Vulnerability, and Uncertainty

The purpose of this chapter is to answer the first research question:

Research Question 1: Which are the major themes on Risk and Uncertainty within the SCM literature?

Therefore an extensive literature study on Risk, Vulnerability, and Uncertainty has been performed¹. After briefly describing the research methodology applied the identified articles are described, first using the categories defined and subsequently according to the themes identified. The identified themes are subsequently positioned according to the Supply Chain Risk Framework as illustrated in Figure 3-1 below.

Figure 3-1: Supply Chain Risk Framework

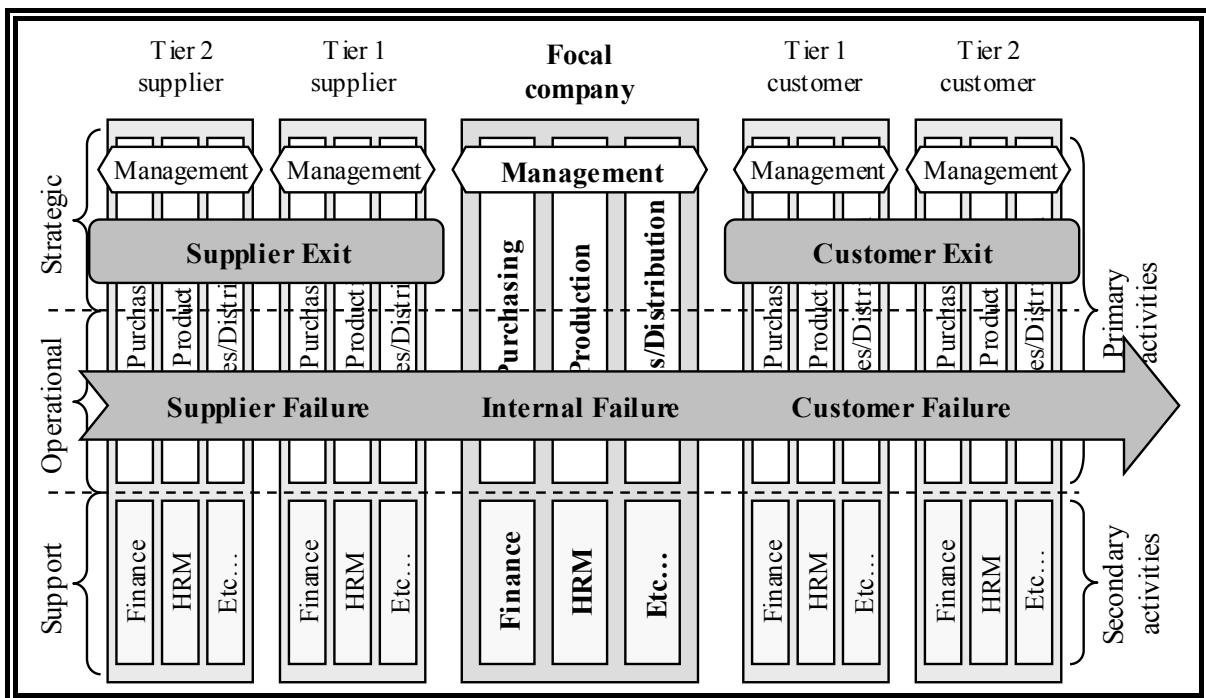

The last step is an analysis of Risk Journals for contributions on SCM.

3.1 Research Methodology

As the intent of the literature study is to describe the use of the terms Risk, Vulnerability, and Uncertainty within SCM the “domain-based” strategy² has been applied. The source for the study (the population) is the list of journals presented in Table 1-1, the volumes investigated

¹ The study was performed in the spring of 2003 and updated in August 2004. Details in Appendix D. See also Sørensen (2004). A comparable study (albeit on SCM in general) is reported in Burgess, Singh, & Koroglu (2006).

² As described in Appendix C.

are listed in Table D-2³. As the intent is to perform an exhaustive study of the journals chosen, the selection criterion is loosely defined as “any article referencing risk, vulnerability, or uncertainty” and instead of using a search engine the journals were read through manually by the author. The resulting gross list is thereby a result of the subjective opinion of the author, only rejecting editorials, book reviews, and interviews. The strategy chosen for the literature study enables and justifies a completeness check which is performed by text searches across the five relevant databases available: ABI/INFORM, Business Source Premier, EMERALD, JSTOR, and ScienceDirect. The criterion applied is for abstracts to contain the phrases “Risk”, “Vulnerability”, or “Uncertainty” AND either “Logistics” or “Supply chain”⁴. The number of relevant hits will determine the “completeness” of the list of relevant journals mentioned above. The parameters for the study are shown in Table D-1.

Subsequent to the identification of the relevant articles, each article is classified according to the following categories:

- Term: Risk, Vulnerability, Uncertainty
- Phase: Risk Identification, Risk Assessment, Risk Management
- Orientation: Upstream, Internal, Downstream, Network
- Level: Strategic, Operational

The categories serve three purposes:

1. to give an idea of the Risk Management contribution,
2. to document the focus of the article, and
3. to show the time perspective and/or structural vs. process/activity implications.

The first two categories support the first purpose where the third and fourth categories support the second and third purposes, respectively. Besides the categories for each article the research method and the theory explicitly referenced is analyzed and documented. Insisting on the explication of theory is justified by the need to document the operationalisation of theory on Risk Management.

The final step in the analysis is to identify themes, defined as a collection of at least three articles focusing on the same problem or phenomenon. As the analysis is performed for each class of articles (SCM/Logistics, OM, and Management) already identified themes may be re-used. After performing the completeness check, the entire collection of identified articles is analyzed creating the final list of themes.

3.2 Results

Reading through the journals on SCM/Logistics resulted in 47 hits, in OM journals 73 articles were found, and in Management journals the result was 56 hits. The completeness check across the five databases resulted in adding another thirteen articles from nine journals to the

³ For the analysis of risk journals, the population is presented in Table 1-2, the volumes investigated are listed in Table E-2.

⁴ Search expression: “(‘logistics’ OR ‘supply chain’) AND (‘vulnerability’ OR ‘uncertainty’ OR ‘risk’)” in the Abstract field.

list. Comparing the high number of articles identified in the original study with the dispersion and low number of articles identified in the completeness check, prompts the conclusion that the study is complete.

3.2.1 Categories: Term & Phase

Only very few (nine) of the 189 articles found reference the term Vulnerability, whereas 76 reference Uncertainty and 104 articles reference Risk. Of the nine articles referencing Vulnerability, six are authored by Göran Svensson (2000, 2001, 2002a, 2002b, 2002c, 2002d) using Marketing Channels theory to measure the vulnerability of in- and out-bound logistics flows. None of the other authors referencing Vulnerability use theory, but Albino & Garavelli (1995) work with vulnerability measurement as well (albeit on JIT production systems). The last two articles (Zaidman, 1994; Watkins & Bazerman, 2003) are similar in the sense that the Vulnerability concept is used to describe risk sources; in the former the marketplace, in the latter a typology of risk sources: psychological, organizational, and political risks.

A large portion of the articles referencing Uncertainty, especially articles from OM journals, are focused on improving internal operations under uncertainty. It is not the intent of these contributions to identify or remove uncertainties, but “merely” to improve techniques to handle variability. A subset of these contributions is the articles dealing with MRP/IT systems. Interestingly, many of the problems described in these articles, e.g. problems on scheduling (Denzler, Boe, & Duplaga, 1987; Ho & Carter, 1994; Lin & Krajewski, 1992; Tang & Grubbström, 2002), dynamic lot sizing (Callarman & Hamrin, 1984), or inventory control (Etienne, 1987; Guide Jr & Srivastava, 2000) are routinely managed in modern ERP systems. In this area the work on managing uncertainty has had an impact.

Even if the terms Risk and Uncertainty may to a certain extent be used interchangeably, there is one distinct difference between the two groups of articles: the articles on Uncertainty do not attempt to assess the uncertainties. Only one article (Koh & Saad, 2003) comes close as the authors attempt to diagnose uncertainties in ERP-controlled shop floors. The article is classified as identifying uncertainties, a combination shared with only two other articles (van der Horst & Beulens, 2002; Wilding, 1998a). These two articles are especially interesting as they reference SCM directly, the former referencing Uncertainty as a driver for re-design, the latter explaining the causes and mechanisms for uncertainty generation in the supply chain.

The other combination, Uncertainty and Management, appear in a limited number of articles as well. The commonality between these articles is clearly SCM, as only one (Collis, 1992) does not reference the concept. The management of uncertainties take different forms as two articles (Martha & Subbakrishna, 2002; Sheffi, 2001) are on disasters/terrorism whereas the remaining four articles (Davis, 1993; Geary, Childerhouse, & Towill, 2002; Lee, 2002; Ottesen & Gronhaug, 2002d) deal with the management of the less dramatic uncertainties: supply, demand, process, and control. Conversely, the contributions on Risk are predominantly concerned with the identification, assessment, and management of risks.

3.2.2 Categories: Orientation & Level

Analyzing the entire population reveals large differences in orientation as the most “popular” orientation is Internal (82), a lot are oriented upstream (62) or downstream (43), and comparatively few (fourteen) are oriented toward the network level⁵.

Performing a similar analysis on Level (strategic/operational) shows the same heterogeneous distribution. Only a third (61) of the articles are oriented toward the strategic level. The “operational” articles show the same pattern. Analyzing the combination of Level and Orientation reveals few surprises: Internally oriented articles are predominantly “operational” whereas Network articles are “strategic”. The portions of the articles that are oriented Up- and/or Down-stream are more or less evenly distributed.

3.2.3 Category: Research Method

A large portion (54) of the articles does not have a distinct research method but are of a conceptual nature. The rest of the articles use either simulation (twelve), describe surveys (20), are case studies (35), or use some sort of mathematical modeling (68).

3.2.4 Category: Explicitly Referencing Theory

Except for previously mentioned author Göran Svensson and his use of Marketing Channels, the use of theory is scarce. Of the 189 articles identified only 36 explicitly reference theory. Besides Marketing Channels, theories referenced with some frequency include Decision theory⁶ (8), Finance theory (3), Agency theory (3), Resource Based Theory (3), and Transaction Cost Economics (3). The absence of explicit theory should not be conceived as an absence of theory in general, though. Especially within the OM journals the explicit reference to theory is very scarce as the published work relies on a paradigm of optimization and efficiency. The paradigm itself defines the playing field within which research is done.

3.3 Themes

The most popular theme, “Improving Operations under Uncertainty”, has already been described as has the theme “Vulnerability in Physical Flows”. Both are considered marginal in relation to SCM, as the former is internally oriented and the latter considers the company as a black box. Another theme already mentioned is “MRP/IT and Uncertainty”. Besides these three themes another eight are identified, describing in total 157 of the 189 articles identified.

It is quite evident certain journals have a distinct focus, as e.g. the theme “Decision Making” is almost exclusively based on the journal *Decision Sciences*. Only one article (Kouvelis & Milner, 2002) from this theme seems to address design decisions in a SCM perspective (supply and demand uncertainty in planning for capacity). The theme “Pricing/Financial Instruments” contains sixteen articles all dealing with the effects of risk on the pricing

⁵ Please note that Upstream, Internal, and Downstream classifications can be used in combination whereas Network can not.

⁶ Decision theory and Finance theory is perceived as aggregate terms, not referencing a distinct theory.

decision or on investments and their valuation. Within this theme one article (Arcelus, Pakkala, & Srinivasan, 2002) stands out as it references pricing decisions and risk sharing in supply chains. Closer investigation reveals the article has limited general relevance as it is oriented towards a very specific context (global co-operation based on e-business under a floating-exchange regime, long-term supply contracts, and risk-sharing clauses).

Introduction of new products is another theme identified. In four articles, various risks in relation to the introduction of new products are described. Two of the articles (Meldrum & Millman, 1991; Polk, Plank, & Reid, 1996) focus on high tech products and one (Hertz & Thomas, 1983) deals with the planning of new product and facilities introduction. The last article belonging to the theme (Bowersox, Stank, & Daugherty, 1999) is on “Lean Launch”, a term describing the use of the pull strategy (and postponement techniques) upon new product introduction instead of the traditional push strategy (and forecast-driven ramp-ups).

Primarily found in the *European Management Journal*, the theme “Risk and Strategy” deals with strategic management of risk and uncertainty. None of the articles deal specifically with SCM but contribute to the general domain of strategic management.

The last four themes identified: “Securing the Supply Chain”, “Supply Management”, “Supply Chain Design”, and “Risk Management in Supply Chains” all have a high degree of relevance as they confront the domain of SCM with the need to manage risks. These themes are therefore described in further detail below, including an analysis of the risk management strategies suggested (if any).

3.3.1 Theme: Securing the Supply Chain

The articles in the theme “Securing the Supply Chain” all deal with extreme events, like terrorism, and all elaborate on finding the “correct” response to this type of events.

In Lee & Wolfe (2003) the use of principles from the quality movement is advocated in the form of risk avoidance/prevention strategies (standardized procedures for inspection, protection of commercial information, and implementation of anti-tampering practices) as well as risk mitigation strategies (tracking & monitoring, supply chain event management (SCEM), flexible sourcing and inventory strategies, and the redesign of product and process). The claim is that appropriate practices will automatically lead to improved security, and that these appropriate practices by and large will pay themselves back in the long run.

The necessity of redesigning supply chains for concurrent security and resilience is stated in Rice & Caniato (2003) as:

“For many companies, the only thing standing between them and a disastrous supply chain disruption is luck. But, as any gambler knows, your luck eventually runs out. In today’s business environment, you need a supply network that has comprehensive security processes and procedures in place and is resilient enough to bounce back from any disruption that does happen. Luck plays no part in the equation.” (p. 23).

Their claim is that security and resilience should be designed into supply chain concurrently, implementing prevention and mitigation procedures to increase the chances of corporate

survival. They propose a list of basic and advanced responses for supply chain security, and an extensive list of supply chain resilience responses by failure mode.

Simchi-Levy, Snyder, & Watson (2002) support the claim that rethinking the supply chain strategies under uncertainty is needed. They offer four strategic approaches for creating robust supply chains: hedge strategies, flexible strategies, collaboration & outsourcing, and What-If Analysis. Their proposition is basically different levels of standardization of plant capabilities enabling easy re-distribution of demand from plant to plant, and implementation of redundancy in buffer inventory, capacity, supplier capabilities etc. The only contingency mentioned is the added cost of using the flexible strategies.

In Martha & Subbakraishna (2002) the balancing of advantages of SCM against the vulnerability created by e.g. the 9/11 attack is advised. The authors suggest a variety of risk management strategies including insurance, reduction, sharing and avoidance. Furthermore, the creation of redundancy in transportation, sourcing and inventory management is encouraged.

In the last article in the theme (Sheffi, 2001) the cost of using dual sourcing for the reduction of the impact of an interruption is illustrated using utility theory. Besides dual sourcing, the explicit use of inventory management to buffer against extreme events is elaborated upon:

“To mitigate the effect of another terrorist attack, manufacturers should keep, in addition, inventory designated ‘Strategic Emergency Stock’. This stock should not be used to buffer day-to-day fluctuations. It should only be used in the case of an extreme disruption. The costs of carrying this extra inventory represent the price of the premium for the insurance it buys.” (p. 3).

The management of supply chain under uncertainty might improve by ensuring shipment visibility, risk pooling, and improved collaboration.

The contributions in this theme are thereby quite conceptual in their attempt to ensure stability and resilience in the supply chain. The generic strategies suggested for the management of the “extreme event” (terrorist attack) are shown below.

Table 3-1: Risk Management Strategies in Theme “Securing the Supply Chain”

Author(s)	-----Risk Management Strategy-----				
	Acceptance	Insurance	Reduction	Sharing	Avoidance
Lee & Wolfe, 2003			✓	(✓)	✓
Martha & Subbakraishna, 2002	✓	✓	✓		✓
Rice & Caniato, 2003			✓		✓
Sheffi, 2001			✓	(✓)	✓
Simchi-Levi, Snyder, & Watson, 2002			✓	✓	✓

As shown in the table above, only Martha & Subbakraishna (2002)⁷ really apply the generic strategies of risk management, the rest of the contributions share an aim at designing the companies and their processes to reduce or avoid the identified risks.

⁷ It is no coincidence though, since Joseph Martha and Sunil Subbakraishna are vice presidents of Mercer Management Consulting, a major player in international consulting on insurance and risk management.

3.3.2 Theme: Supply Management

Differing from “Securing the Supply Chain”, the theme “Supply Management” is more heterogeneous as it contains contributions from the past twenty five years, covering a range of issues.

Early Contributions on Purchasing/Supply Management

In the earliest contribution identified (Wright, 1980), it is advocated purchasing is about risk-taking:

“What is not well recognised, however, especially by the senior non-purchasing managers in the majority of manufacturing organizations, is the need to consider purchasing as a risk-taking function and the need for supply management to be involved in strategic planning.” (p. 47).

The importance of the risk taking part of the above statement is emphasized:

“It is essential that the purchasing function attempts to evaluate the stability of its sources of supply and to assess the supply failure risks that may be present in particular supply channels, especially those providing essential inputs for the company’s mainstream operations.” (pp. 48-49)

and

“...if purchasing is to be effective in providing the correct logistics support then supply risks must be evaluated and appropriate supply strategies must be formulated and become an essential input to corporate planning.” (p. 50).

The author moves on to argue for the involvement of purchasing in corporate strategizing as:

“Corporate strategies and plans are normally expressed in terms of products, markets, customers and competition – the outgoing aspects of the business – but if equilibrium and a state of dynamic stability is to be achieved with respect to both sales and supply markets, then the corporate strategy of a business should include supply strategy in terms of essential inputs, sources and supply channels.” (p. 50).

The development of purchasing capabilities in identification and assessment of supply risks is thereby of critical importance, as is the capability to develop contingency plans and ensure alternative sources of supply. Recognizing that the perceived importance of the company by its suppliers is of critical importance as well, Wright proposes a conceptual Supply Risk Model, combining the ability to assess current and potential suppliers with the company’s standing with the supplier. Wright does not offer frameworks to measure the proposed variables, but insists that continued research is necessary to make any progress beyond the simple point rating systems. He furthermore proposes a generic model for risk assessment and contingency planning, see Figure 3-2. But even if the model seems to follow a simple logic, it does not add much value as it leaves out a detailed description of which risks are relevant, how they are rated, and how alternatives are identified. The model thereby is conceptual almost to the point of irrelevance – but it does offer a point of reference for other contributions within the field.

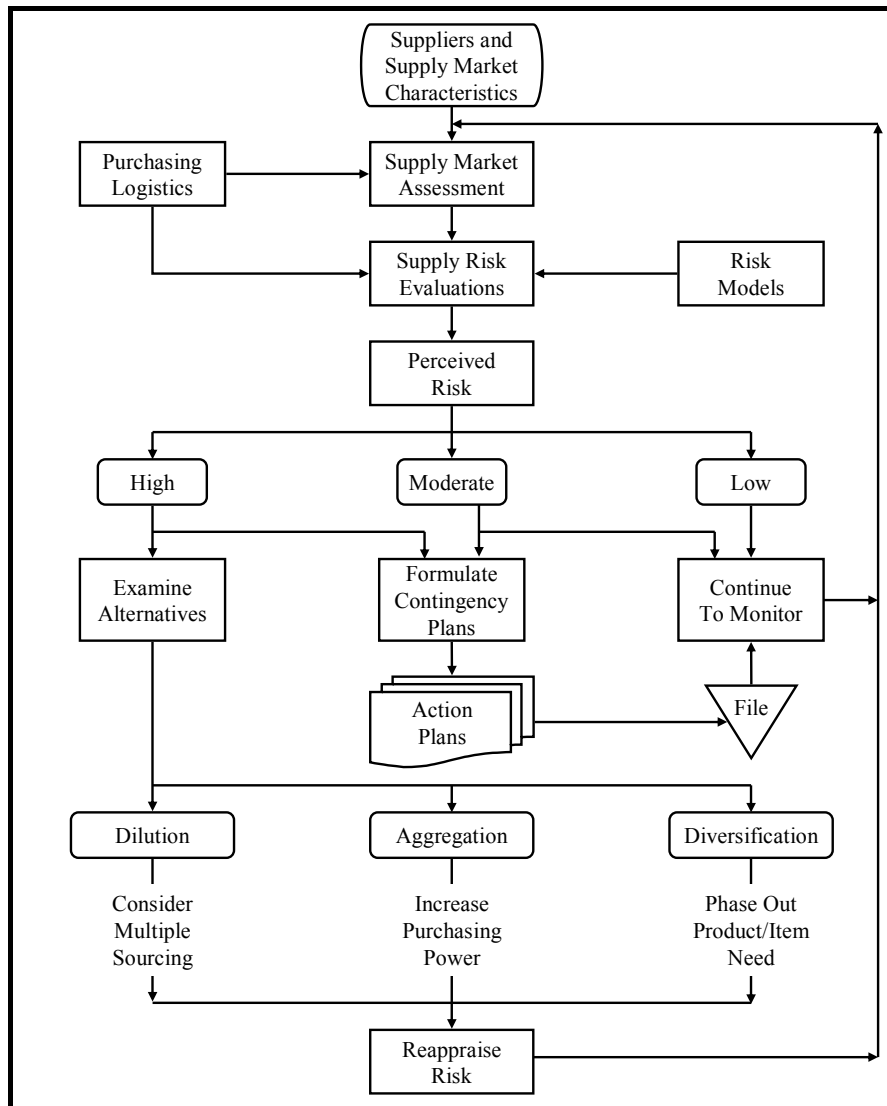
Figure 3-2: Risk Assessment and Contingency Planning⁸

In another early contribution, Treleven & Schweikhart (1988) offer a more nuanced view on supply risk as they perform a risk/benefit analysis of sourcing strategies. Differentiating between single, sole, and multiple⁹ sourcing, they propose the following five categories of risks/benefits: 1) disruption of supply, 2) price escalation, 3) inventory and schedule, 4) technology access, & 5) quality. The first two are cited as the most common arguments for not using single sourcing and are perceived as pure risk categories in the single sourcing strategy, whereas the rest have risks and benefits both for all three sourcing strategies. Interestingly, categories one and three fit quite well with the supply-side structural and process risks, as described in Chapter 2. Access to technology is probably even more relevant today than when the article was written, but the quality discussion seems to have silenced.

⁸ Source: Figure 3 in Wright (1980), p. 57.

⁹ "Single sourcing is broadly defined as fulfillment of all of an organization's needs for a particular purchased item from one vendor by choice. ... If this [single sourcing] is not done by choice, such as when a vendor has a monopoly, it is termed 'sole sourcing'. ... Multiple sourcing refers to a vendee purchasing an identical part from two or more vendors. If only two vendors are used, this is a special case of multiple sourcing called dual sourcing." (Treleven & Schweikhart, 1988, pp. 95-96).

The authors make quite a strong point in analyzing the risks relating to the use of single sourcing arrangements as they insist on either building a trust-based relationship prior to discarding alternative suppliers or performing a thorough analysis of the soundness of the suppliers (the former is preferred). Irrespectively, after entering into a single sourcing arrangement, the risks must be monitored continuously:

“The vendee cannot rely sole on these initial precautionary measures. A contingency plan should be developed which describes the steps to be taken in the event that, despite its precautionary measures, a disruption in supply occurs. ... Developing contingency plans is also a wise step for companies which are vertically integrated since backward vertical integration is tantamount to internal single sourcing.” (p. 98).

Besides the conceptual analysis of risks and benefits relating to the described sourcing strategies and the insistence on the continued monitoring, the authors do not offer anything on the management of the risks.

Likewise referencing strategic sourcing and vertical integration, Walker (1988) uses Transaction Cost Economics (TCE) and Resourced Based Theory (RBT) to describe the strategic risks to be dealt with when determining sourcing strategy and the level of vertical integration. The strategic risks identified are: 1) appropriation risk (the potential for decline in equitable exchange relationships), 2) diffusion risk (the likelihood of a competitor imitating the firm’s distinctive value-creating assets, and 3) product degradation (the chance that important product attributes will be distorted, ignored or impaired in distribution, marketing, or technical service operations). Defining uncertainty in the sourcing relationships by volume uncertainty and technological uncertainty, Walker argues the relationship between uncertainty and vertical integration is quite straight-forward:

“Vertical integration becomes the ultimate option as uncertainty associated with the sourcing relationship rises.” (p. 69).

To Walker, the decision of vertical integration and de-integration depends on a number of contingencies: level and type of uncertainty (volume and/or technological) experienced, value of input, strategic importance, asset specificity, and level of buyer qualification. The qualification of inside and outside sources is especially interesting as it:

“...entails an examination of their [the internal or external suppliers] capabilities to meet specific performance criteria. These may be either operational-level criteria, primarily price based on production costs and controlled for delivery and quality, or strategic criteria, for example, technological leadership, ability to link to other suppliers, and the compatibility of the outside source’s long-range plan with that of the firm.” (p. 70).

The emphasis on the strategic level is thereby apparent as no attention is given to e.g. disruptions in input. The decision model on integration/de-integration is depicted in Figure 3-3 below.

Figure 3-3: Vertical integration decisions associated with combinations of strategic risk and buyer qualification¹⁰

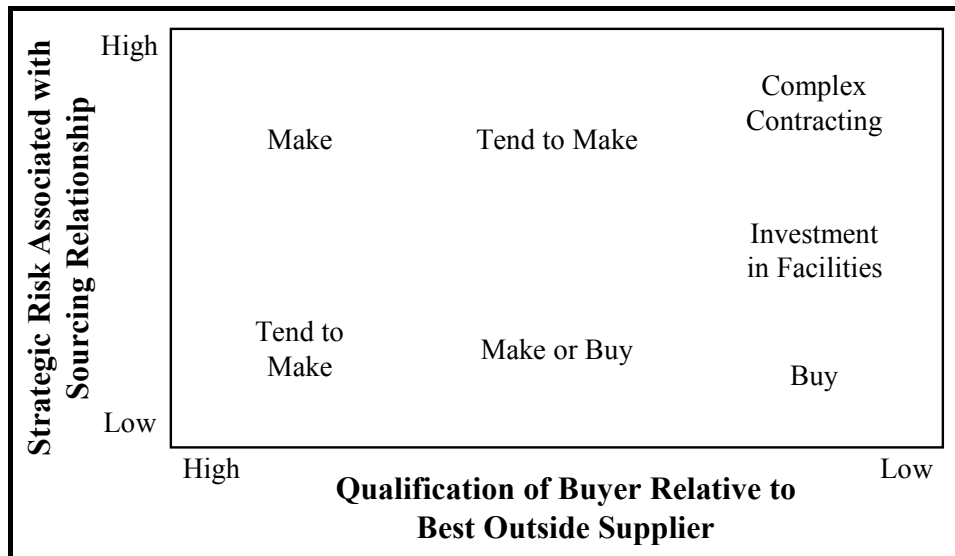

The framework describes the two mechanisms, buyer qualification and strategic sourcing risk, and their impact on the make-buy decision. The lower capabilities and the higher sourcing risk, the more likely a company is to reject the use of external sources.

Taking a more logistically oriented perspective, Hill & Vollmann (1986) also deal with a much more specific situation as they have vendor delivery uncertainty in a JIT environment under scrutiny – the authors suggest in-sourcing the responsibility of inbound logistics from all JIT suppliers. Simply letting the manufacturing firm organize the pick up of required input to the operation will reduce delivery uncertainty. Boronico & Bland (1996) likewise are logistically oriented as they investigate the distribution of seasonal, perishable food products with fixed demand and probabilistic supply. In line with these two contributions, Ottesen & Grønhaug (2002c) investigate how upstream actors cope with uncertain supply to handle customers' demand.

Buying Decisions

In another early contribution (Tullous & Munson, 1991) tradeoffs under uncertainty for industrial purchasers are investigated. The authors define uncertainty as: 1) need uncertainty (ease or difficulty encountered in specifying and measuring product uses and characteristics), 2) market uncertainty (stability of the marketplace and the degree of difficulty encountered in comparing the characteristics of the potential suppliers), and 3) transaction uncertainty (the degree of difficulty encountered in delivering the product to the purchaser), and interviewed eighty companies in the electronics industry to determine the relative importance of widely used selection criteria under varying degrees of uncertainty. On much the same note, Templin & Noffsinger (1994) assess the role of technical and risk evaluation factors in source selection in the US military. In their analysis they describe risk in terms of: 1) technical, 2) past

¹⁰ Source: Figure 1 in Walker (1988), p. 70.

performance, 3) cost and 4) schedule risks, and conclude that low values for these risk indicators correlate strongly with awarding of contract.

Taking the perspective of organizational behavior Henthorne, LaTour, & Williams (1993) investigate the influence of informal members of a buying centre have on the perceived type and level of risk. They use the following categories: 1) performance risk (likelihood of product failure), 2) social risk (risk of purchased product not being approved by important reference group), and 3) economic risk (potential dollars investment loss), and conclude that the opinion of both internal and external informal members influence the perceived risk and thereby the buying behavior. Bunn & Liu (1996) investigate the reverse situation: how customer perceptions of risk have an impact on the buying decision. To them perceived risk is central to the issue of adaptive selling:

“Because a buying decision can be viewed as an instance of risk taking, and because buying behaviours can be thought of as risk handling strategies, we sought to develop a categorization based on the dimensions of perceived risk.”
(p. 441).

Their hypothesis is that current customer classifications does not support adaptive selling, and criticize e.g. Kraljic (1983) for not dealing explicitly with risk. They propose using only two variables (purchase importance and task uncertainty) to describe situational risk, and to set up a 2-by-2 matrix to categorize customer situations¹¹. Subsequently the categorization is tested by means of a survey, after which it is concluded that these four cells represent four distinctly different buying situations. In Westbrook (1996), the last of the three articles identified in *Industrial Marketing Management*, a list of propositions on risk coordinative maneuvers during buyer-seller negotiations are put forward. Westbrook assumes that stakes and risk framing drive the negotiation style, and includes the risk component in the contingency model in the antecedent “risk orientation”. As the model is not tested, it only serves as inspiration for other researchers.

Hunter et al. (2004) likewise propose a matrix for classifying organizational buying decisions into categories with implications for e-business, see Figure 3-4 below. In order to link risk with the benefits of e-business, the authors reference a concept of risk perception as a construct of 1) risk importance (the perceived importance in the buyer’s mind of the potential negative consequences of a poor product choice) and 2) risk probability (the perceived probability of making a poor choice). Combining risk importance and risk probability, their model is much more complex as it uses product characteristics, essentiality of the product, the number of suppliers, supplier capabilities, and ease of specifying the product requirements. For each cell, the generic risks and benefits of performing e-business are outlined.

¹¹ Values Low-Low result in low risk, High-High in high risks, combinations of Low/High in moderate risk.

Figure 3-4: A risk/benefit framework for industrial buying¹²

Risk Importance	High	<p>Strategic Diversification</p> <ul style="list-style-type: none"> • Essential, differentiated products • Many potential suppliers with similar capabilities • Product specifications easy to develop <p style="text-align: right;">LH</p>	<p>Relationship Development</p> <ul style="list-style-type: none"> • Essential, differentiated products • Many potential suppliers with variation in capabilities • Difficult to assess supplier capabilities • Product specifications difficult to develop <p style="text-align: right;">HH</p>
	Low	<p>Disintermediation</p> <ul style="list-style-type: none"> • Non-essential substitutable products • Many potential suppliers with little variation in capabilities • Product specifications easy to develop <p style="text-align: right;">LL</p>	<p>Reintermediation</p> <ul style="list-style-type: none"> • Non-essential substitutable products • Many potential suppliers with variation in capabilities • Product specifications moderately easy to develop <p style="text-align: right;">HL</p>
		Low	High
Risk Probability			

Contemporary Contributions on Supply Management

Lonsdale (1999) uses a terminology different from that of Walker but basically writes on the same subject as he aims at improving the practices of outsourcing through the use of concepts from RBT: resource heterogeneity, ex-post and ex-ante limits to competition, and imperfect mobility. Lonsdale argues the risk to manage is the danger of dependency, a danger emerging in three different ways:

“There are a number of ways in which dependency can emerge: outsourcing into a limited supply market, poor internal alignment, and contractual incompetence in the face of different degrees of asset specificity.” (p. 179).

Where the argument made on outsourcing into a limited supply market is quite obvious, the results of poor internal alignment are less so. The argument made is that choosing suppliers too early in the procurement process will limit the bargaining power of the purchasing department.

¹² Source: Figure 1 in Hunter et al. (2004), p. 148.

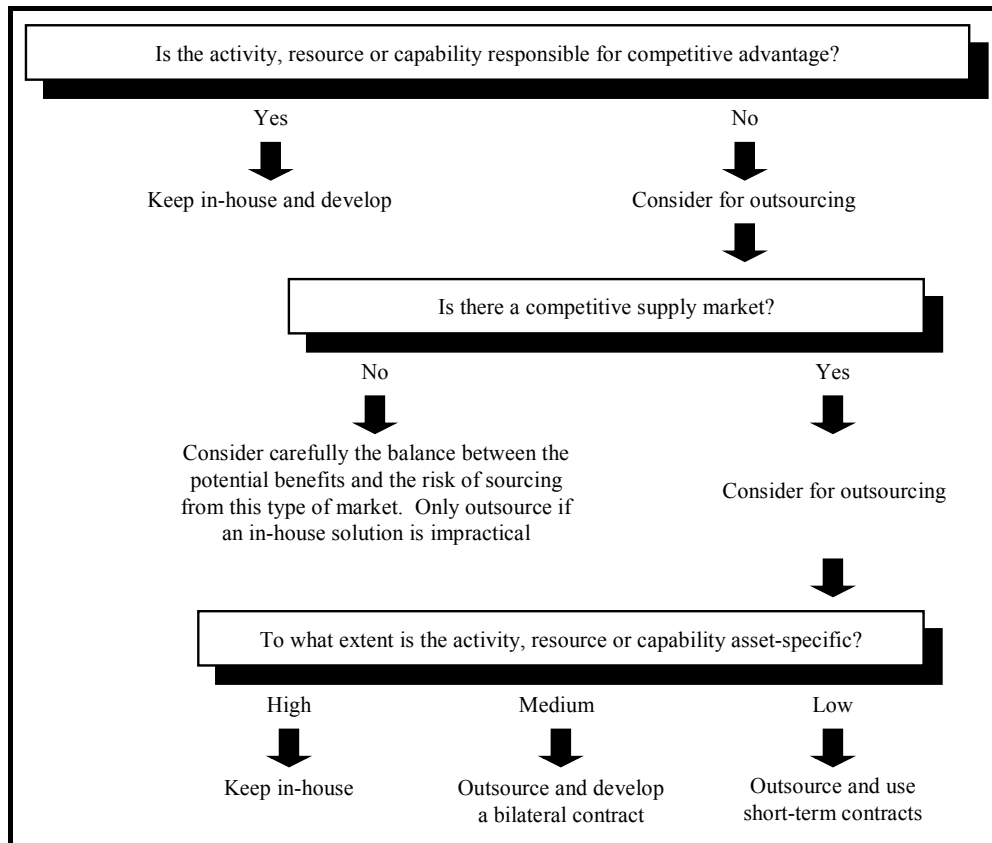
Figure 3-5: A risk management model for outsourcing¹³

The last way in which dependency emerges, the contractual incompetence, is the most sophisticated argument:

“The third way in which dependency on suppliers can arise is the most intriguing. Whilst the firm might be able, pre-contractually, to choose from a competitive supply market, at the re-contracting stage it’s capacity to do so again can be reduced. This is because, in the case of certain transactions, re-accessing that supply market is often constrained by the sunk and switching costs that have been built up during the initial contractual term. To understand why and when supply options might diminish in this way, it is necessary to refer to the work of transaction cost economists, most notably Williamson, and his concept of asset specificity.” (p. 179).

Switching from a single-period analysis to a multi-period thereby changes the rules of the game between supplier and buyer, limiting the value creation potential of outsourcing. Figure 3-5 above illustrates the logic of the model.

More specifically targeting the risk component, George Zsidisin (Zsidisin, Panelli, & Upton, 2000; Zsidisin, 2003a; Zsidisin, 2003b; Zsidisin & Ellram, 2003; Zsidisin et al., 2004) has an interest in exploring the perceptions of supply risks and the management of suppliers using e.g. agency and grounded theory. In Zsidisin, Panelli, & Upton (2000) the current practice of supply risk management is investigated, concluding:

¹³ Source: Figure 1 in Lonsdale (1999), p. 181.

“However, with such sourcing strategies [single sourcing], companies are exposing themselves to increased levels of risk... Because of the imminent threat supply risks may entail, some companies are realizing the importance of assessing risks, contingency planning, and managing supply risk.” (p. 196).

In a later article Zsidisin & Ellram (2003) use Agency Theory to describe (external) risk prevention as Behavior-Based Management and risk reduction as Buffer-Oriented Management¹⁴. Buffering is perceived as the simple response whereas Behavior-Based Management (supplier certification, quality programs, target costing etc.) is perceived as sophisticated. One of the findings of this study is that the extent of implementation of supply risk management is influenced by firm size and percentage of strategic purchases. Another is that even companies having implemented Behavior-Based Management still have buffering in place. In yet another article (Zsidisin et al., 2004) the focus is directed at supply risk assessment techniques, which is researched by means of interviews with a small number of manufacturing firms. They conclude that the formalized practices for identification and assessment is almost absent, but that existing tools for proactive supplier management makes relevant information available.

The importance of proactive supply management is supported in at least two other contributions: Smeltzer & Siferd (1998) and Norrman & Jansson (2004). In the former the connection between proactive supply management and risk management is stated clearly:

“...proactive supply management is qualitatively different from reactive supply management. Also, it is more than integrative procurement management and more than strategic procurement management. Proactive supply management is concerned with a significant additional issue: risk management.” (p. 39).

The claim is that purchasing departments working proactively are able to reduce the inherent risks and improve returns and will add more value than their counterparts working reactively. In the latter article, the development of supply chain risk management (SCRM) practices at Ericsson following the Albuquerque accident (see also Chapter 1) is described. The practices described in the article include risk identification, risk evaluation, and risk management. Figure 3-6 below illustrates how risks identified and measured are linked to the invoicing (or lost invoicing) through the product portfolio. The resulting indicators, BRT and BRI, enable Ericsson to choose the right action based on estimates of impact and cost of action.

¹⁴ With reference to the ‘Probability times Impact’ model, it might be argued that the prevention strategy aims at reducing the probability of the detrimental event, whereas the reduction strategy seeks to minimize the impact.

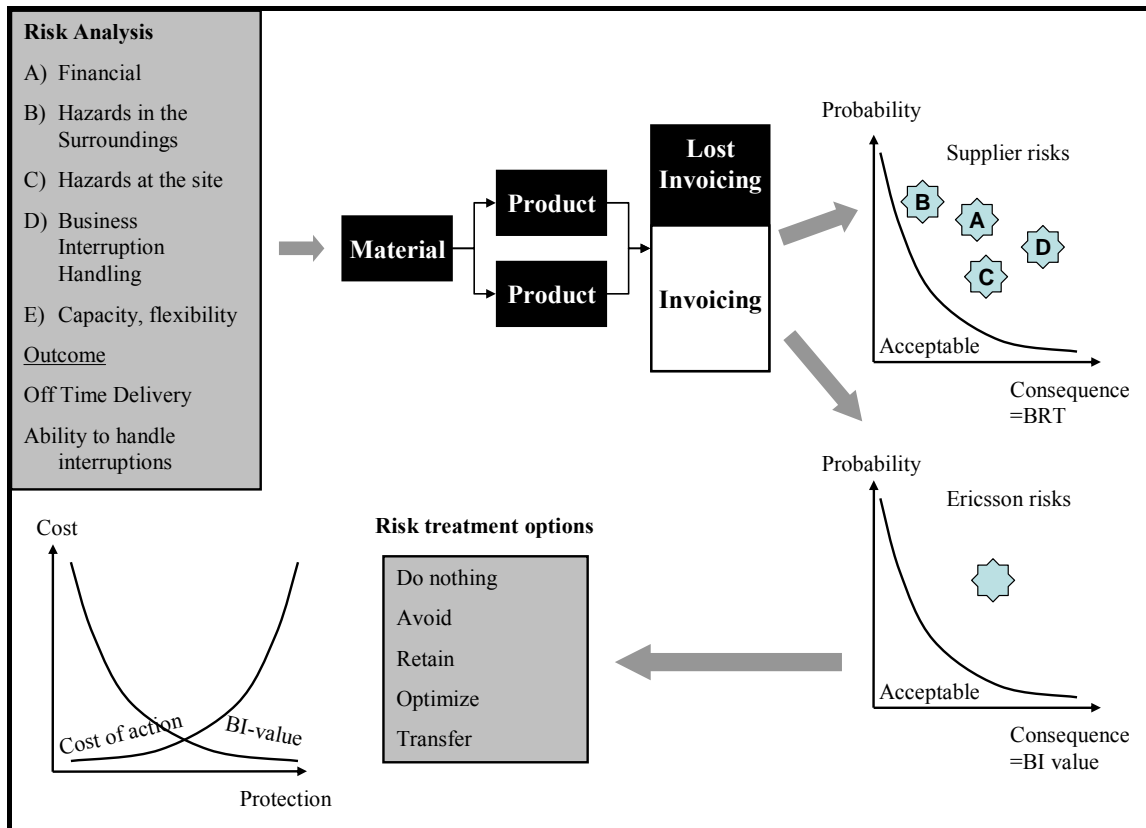
Figure 3-6: Ericsson's approach to Supply Chain Risk Management¹⁵

So, combining the assessment (BI and BRT values) leads to the choice of risk treatment options, constrained by the cost of the option.

In Hallikas et al. (2004) previous work on risk analysis and assessment (Hallikas, Virolainen, & Tuominen, 2002) is extended, as risk management processes in supplier networks are investigated. In the 2002 article a risk definition including: 1) demand related factors and value chain positioning, 2) delivery performance, 3) financial factors, and 4) pricing was used, and tools and methods for the analysis and assessment of these risks were presented, see Figure 3-7 below. The approach to risk management thereby has direct effects on the choice of strategies:

“The assessment of risks is important for two reasons: it helps a company to focus on essential risks, and it has significance for the choice of strategies. ... The primary aim of the model is not to provide an absolute value of risk, but rather to provide support in the decision making process.” (p. 53).

Choosing a proactive approach will enable the companies to react to the root cause instead of the symptom, as the proactive approach will monitor for identified risks. After decomposing the four risks mentioned above based on the collected empirics, it is stated that the definition of a typical network risk is not possible, and that further research is needed.

¹⁵ Source: Figure 13 in Norrman & Jansson (2004), p. 451.

Figure 3-7: Risk assessment framework¹⁶

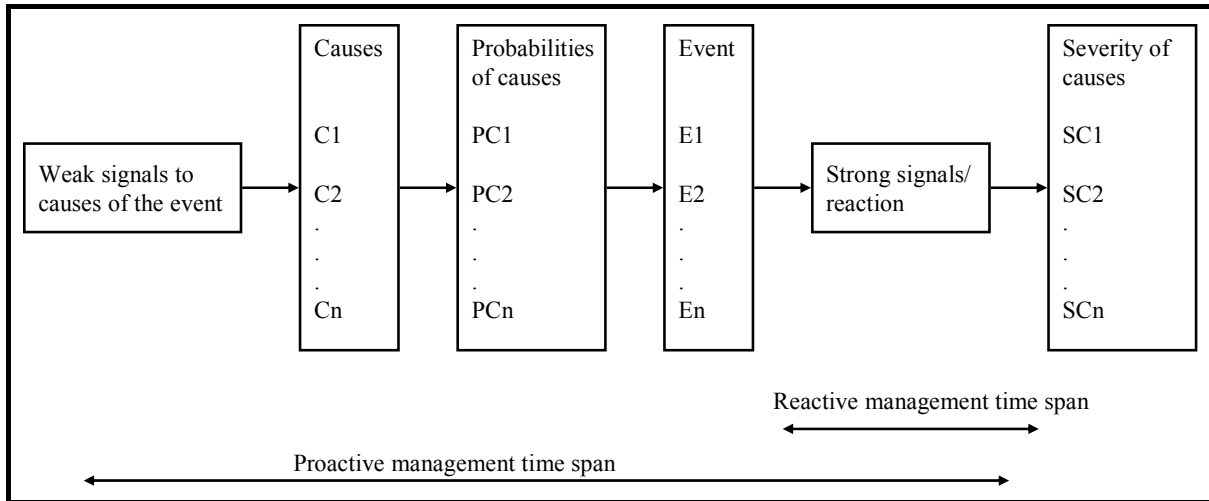

This is addressed in the 2004 article, where the risk definition is altered as the “financial factors” category is replaced by “weaknesses in resources, development and flexibility”. Each of the phases in the generic risk management process (identification, assessment, choice, implementation, and monitoring) is thoroughly described, and integration of risk management processes in network environments is recommended:

“Each enterprise operates at its own risk and should manage risks itself. As the interconnections of the enterprises in the network make them dependent on each other, it can be useful to share partially the risk management process and to develop collaborative means to manage the risks.” (p. 52).

Figure 3-8: Risk management process in network environment¹⁷

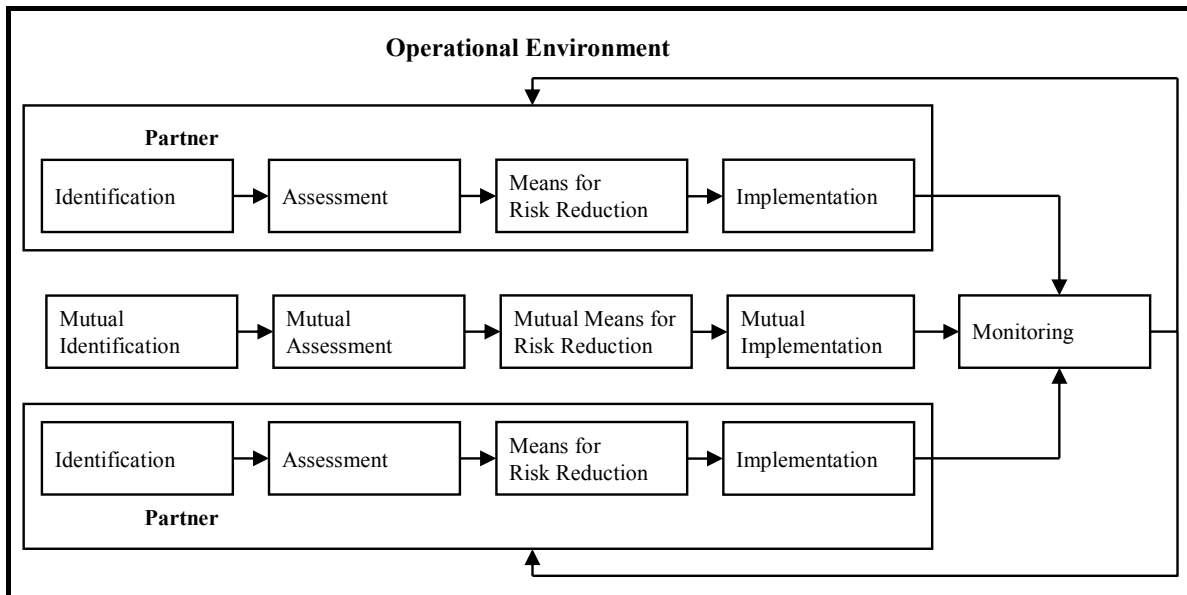

¹⁶ Source: Figure 6 in Hallikas et al. (2002), p. 53.

¹⁷ Source: Figure 2 in Hallikas et al. (2004), p. 55.

It remains unclear exactly how these risk management processes are to interlink, and how emerging risks are to be addressed, but the model has a strong point in its aim at aligning risk management processes and the coordinating of risk management *per se* across the network, see Figure 3-8 above.

This problem is addressed in Sinha, Whitman, & Malzahn (2004), where a generic approach to supplier risk management is presented. The objective of the model is to enable supplier risk management in a consistent way across the multiple supply chains companies participate in. The model contains the usual risk management process steps: identify, assess, plan & implement, monitor (failure mode & effect analysis), and improve. The model differs from other models, though, in the fact that each step is supposed to take the rest of the network into consideration, and that change in one process might influence other processes:

“Today, many opportunities (risks) arise due to changes in business practices. A supply chain network can never be risk free, that is, one cannot eradicate the chance of an undesirable event occurring. As trading partner needs (internal or external) change, the redesigned process (with mitigated risk) must be improved. Therefore, embedding continuous improvements into the redesigned process is required. However, to manage risk effectively, that is monitoring and controlling it, the iterative steps of identifying, assessing, planning solutions, and conducting failure mode and effect analysis should be followed.”
(p. 160).

The model is generic, but applied to the aerospace industry, documenting the risk sources and mechanisms in the supply markets and the regulatory institutions for this industry.

Lastly Harland et al. (2003) review definitions and literature and suggest a generic model for the identification, assessment, and management of supplier network risks. Their model is, as some of the other models presented, generic, but is applied to the risk of trade compliance. As suggested in Hallikas et al. (2004), Harland et al. propose setting the level of analysis at the network level and applying collaborative supply network risk strategies.

So, albeit all interested in improving the management of supply, commonality in risk definition and approaches to risk management is absent. The sophistication of the risk management strategies differ greatly across the identified articles, with Hallikas et al. (2004) and Sinha, Whitman, & Malzahn (2004) being the most developed. Most of the articles reference the reduction and avoidance strategies only, see Table 3-2 below.

Table 3-2: Risk Management Strategies in Theme “Supply Management”

Author(s)	-----Risk Management Strategy-----				
	Acceptance	Insurance	Reduction	Sharing	Avoidance
Hallikas et al., 2004	✓	✓	✓	✓	✓
Harland, Brenchley, & Walker, 2003			✓	✓	✓
Lonsdale, 1999			✓		✓
Norrman & Jansson, 2004	✓		✓		✓
Ottesen & Gronhaug, 2002b	✓				✓
Sinha, Whitman, & Malzahn, 2004	✓	✓	✓	✓	✓
Walker, 1988			✓	(✓)	✓
Wright, 1980	✓		✓		✓
Zsidisin & Ellram, 2003			✓		✓
Zsidisin, Panelli, & Upton, 2000			✓		✓

3.3.3 Theme: Supply Chain Design

The articles on supply chain design are as diverse as the articles in the previous theme, not least in terms of research method.

Modeling

Quite a few of the article identified for this theme use modeling. In Gupta, Gerchak, & Buzacott (1992) the aim of the model is to find the optimal mix of flexible and dedicated manufacturing capacity under uncertain demand, in Agrell, Lindroth, & Norrman (2004) the effect of incentive structures on a three-tier supply chain is investigated using a two-period agency model assuming stochastic demand. The model described in Korpela et al. (2002) resembles the first model as it aims at minimizing the production capacity needed given a sales plan, but differs as it uses a risk profile of the relation between supplier and customer instead of uncertain demand. In Kouvelis & Milner (2002) both supply and demand are uncertain, the question to answer is whether to outsource or adapt capacity.

Vidal & Goetschalkx (2000) investigate the effect of uncertainties on global logistics systems (GLS) by means of mathematical models. Besides pointing out the importance of getting correct and reliable data, they insist that:

“Despite attempts to consider uncertainties in global supply chain models, it appears that no model is capable of managing the uncertainties that characterize a GLS. As a consequence, existing models are useful only if they allow analysts to perform adequate sensitivity analyses in a reasonable computation time.” (p. 103).

After having investigated the effects of various types of uncertainties they conclude:

“A simple model illustrated two important ideas. First, any good strategic configuration of a global supply chain may become inadequate due to inherent uncertainties of the system, such as exchange rate fluctuations, changing demand, supplier reliability, and/or stochastic lead times. Second, MIP models are powerful tools for analysing those variations and re-optimizing the system under the new conditions. ... The integration of several stochastic aspects in MP production–distribution models creates a valuable tool for analyzing different scenarios.” (p. 112).

The mathematical models thereby can not predict the better designs, but may be able to replicate current results given larger and larger portions of reality? Furthermore, the models are unable to determine the relevant types of uncertainties to include in the model, but may be able to evaluate whether each uncertainty has an effect on any of the desired outputs. Their framework is depicted in Figure 3-9 below.

Figure 3-9: The Global Supply Chain Design Process¹⁸

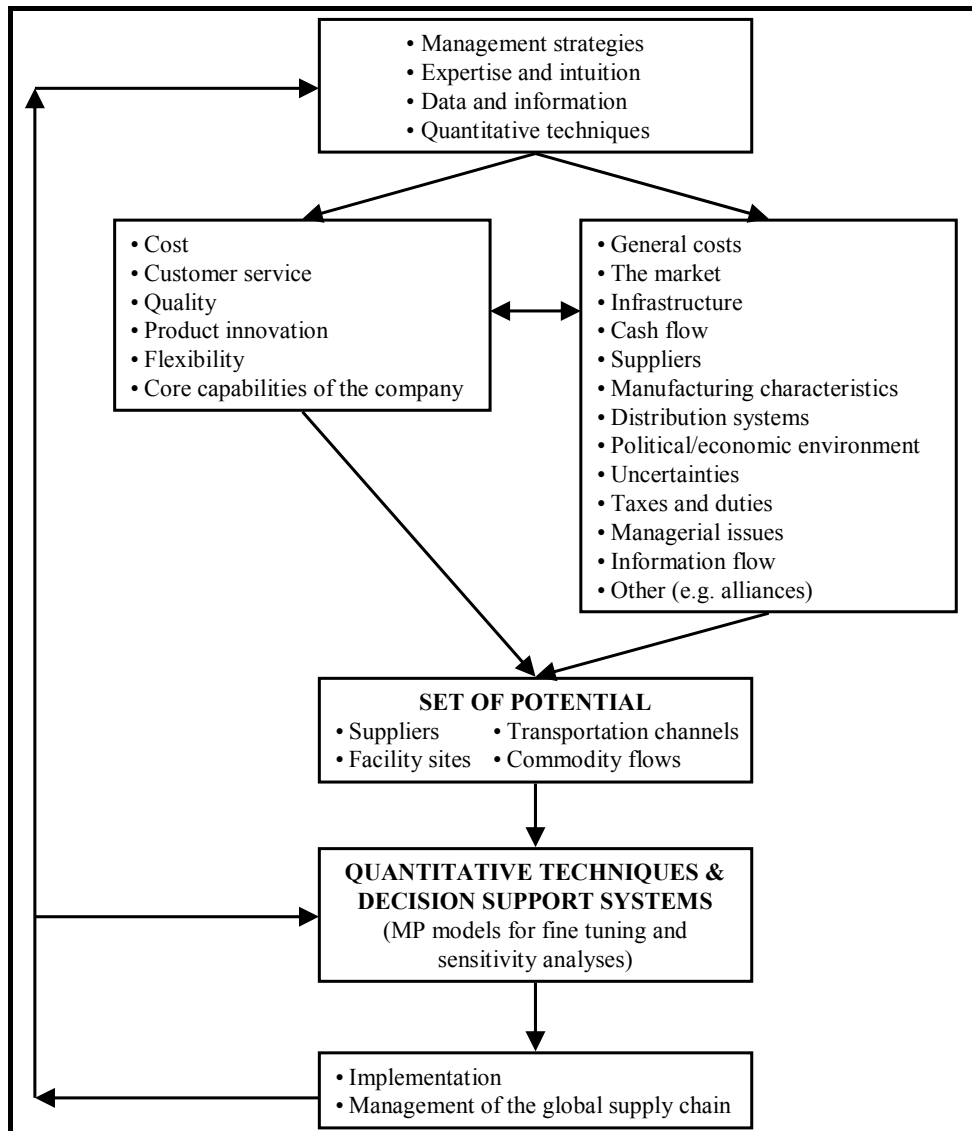

On more or less the same note, Sabri & Beamon (2000) present a multi-objective (efficiency, effectiveness, and flexibility) model assuming production, delivery, and demand uncertainty. The model produces a “supply chain performance vector” describing total costs, volume flexibility, customer service level index, and delivery flexibility index.

¹⁸ Source: Figure 1 in Vidal & Goetschalckx (2000), p. 100.

Case-based Contributions

Another group of articles are the case-based contributions, possibly offering less abstract results than the optimization models. As already described, Lonsdale (1999) investigates the practice of outsourcing critical activities and ex-ante and ex-post dependencies of suppliers using Hewlett-Packard as case. Also using Hewlett-Packard Davis (1993) describes the practices of managing uncertainties in input, production, and demand. Johnson (2001) describes the toy industry and unravels the relevant up- and down-stream risks. In Hauser (2003) the case for using software tools and spreadsheet to identify and assess risks is made.

To Geary, Childerhouse, & Towill (2002) supply chain uncertainty can be described by process, supply, demand, and control uncertainty. They thereby combine the “usual” framework of upstream, internal, and downstream uncertainties with the mitigation mechanisms of visibility and control put forward in Christopher & Lee (2004). With the aim of creating the “seamless supply chain” tighter integration is advocated, reducing uncertainty by creating visibility up- and down-stream. The self-enforcing mechanism described here thereby contradicts the vicious circle depicted in Figure 3-15 below as they claim:

“Thus, the seamless supply chain becomes a self-fulfilling prophecy: Lower uncertainty leads to tighter integration, which reduces uncertainty further, and the cycle continues.” (p. 56).

The level and type of uncertainty is furthermore used in combination with the integration framework put forward by Stevens (1989) to create a model of supply chain maturity, see Figure 3-10 below.

Figure 3-10: Maturity and Uncertainty Levels¹⁹

Stage of Supply Chain Integration	Summary of Associated Supply Chain Characteristics	Relative Uncertainty Quantities			
		Process	Supply	Control	Demand
1. Baseline	Reactive short-term planning. Fire fighting. Large pools of Inventory. Vulnerability to market changes.	4	4	4	4
2. Functional Integration	Emphasis still on cost, not performance. Focus inward and on goods. Reactive toward customer. Some internal trade-offs.	2	4	3	4
3. Internal Integration	All work processes integrated. Planning reaches from customer back to supplier. EDI widely used. Still reacting to customer.	1	2	2	4
4. External Integration	Integration of all suppliers. Focus on customer. Synchronized material flows. SC covers extended enterprise.	1	1	1	1

Identifying the level of maturity from the integration framework, the company can directly observe which types of uncertainty it faces. The authors list the typical uncertainties within each class (process, supply, demand, and control) and describe the effects of the uncertainty

¹⁹ Source: Exhibit 3 in Geary, Childerhouse, and Towill (2002), p. 57. (High numbers indicate a high level of uncertainty, low numbers the opposite).

by “type of supply chain disruption”. To help the typical company achieving better performance by moving to the next level of maturity/integration, a model of the “well-trodden path to remove uncertainties” is presented, see Figure 3-11 below.

Figure 3-11: Removing Uncertainties in a Particular Pattern²⁰

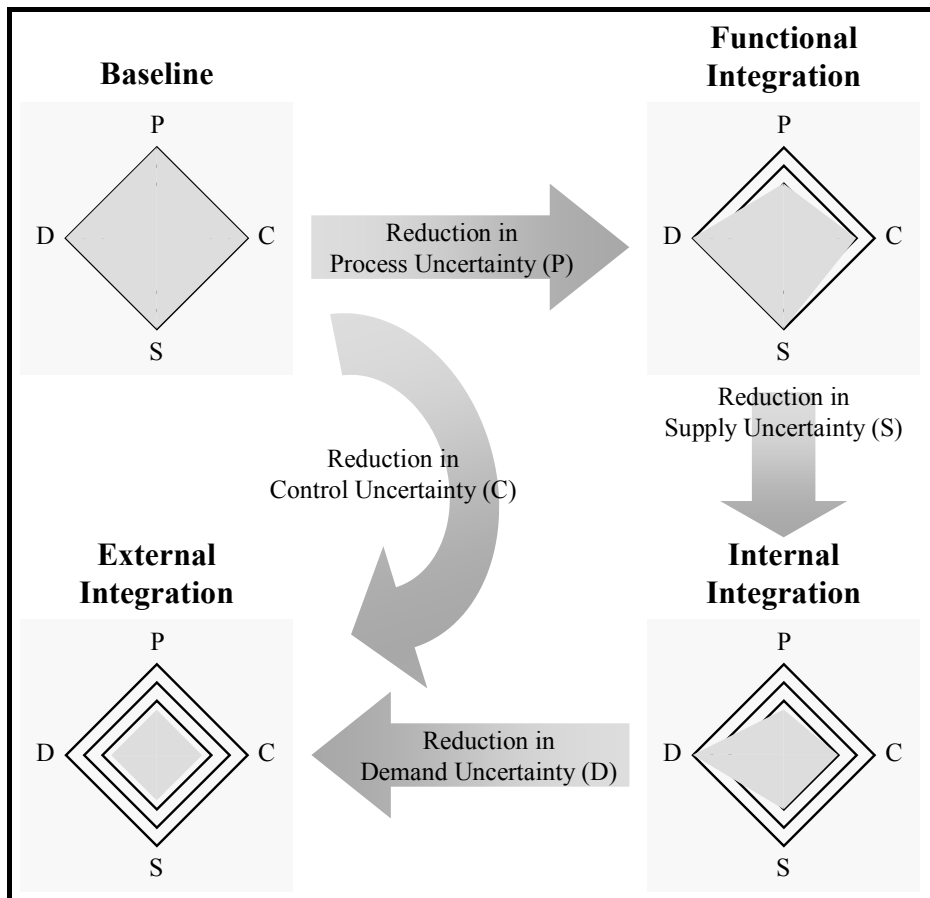

Lee (2002) claims the appropriate management of supply chain(s) is determined by uncertainties in supply and demand both (thereby expanding the framework put forward by Fisher (1997)). As illustrated in Figure 3-12 below the “solutions” proposed for reduction of supply and demand uncertainty thereby aims at 1. decreasing the uniqueness of offerings as innovation in products is avoided and 2. decreasing uncertainty by using stable (known) processes instead of new (evolving) processes (broadly defined).

²⁰ Source: Exhibit 5 in Geary, Childerhouse, & Towill (2002), p. 58.

Figure 3-12: The Uncertainty Reduction Strategies²¹

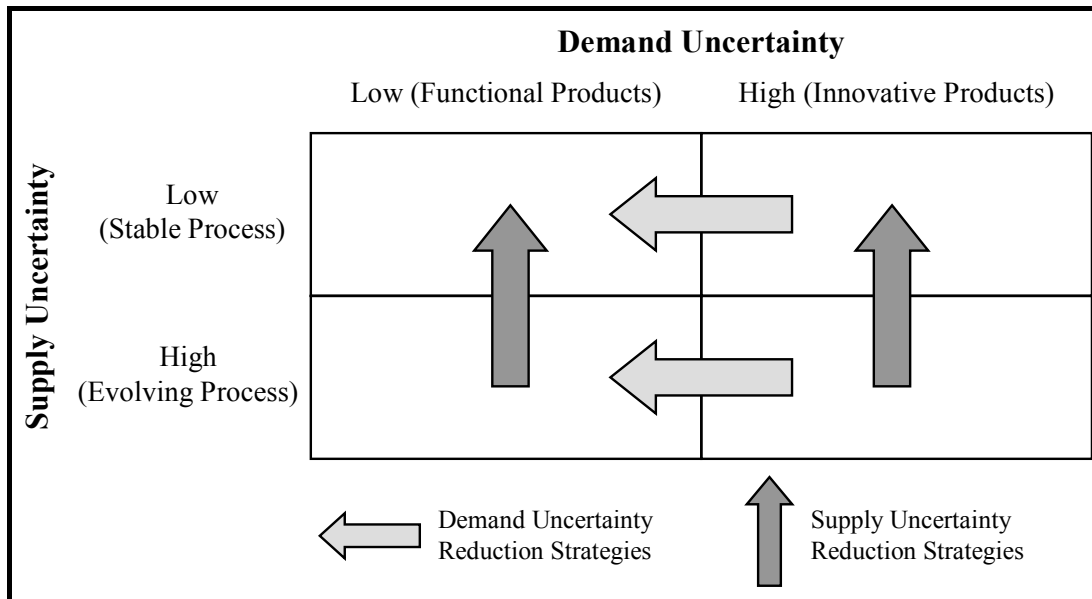

Lee furthermore develops a taxonomy of matched strategies for the management of supply chains by combining supply and demand uncertainties, see Figure 3-13 below.

Figure 3-13: Matched Strategies²²

		Demand Uncertainty	
		Low (Functional Products)	High (Innovative Products)
Supply Uncertainty	Low (Stable Process)	Efficient supply chains	Responsive supply chains
	High (Evolving Process)	Risk-hedging supply chains	Agile supply chains

The principal contribution of the two models described above is thereby the lower left quadrant in the latter, the “Risk-hedging supply chains”, which is to be avoided through “Supply Uncertainty Reduction Strategies”. The three other strategies are well-known within the domain.

Conceptual Articles

The rest of the articles are conceptual in nature, and differ quite a lot from each other. In Rice & Caniato (2003) designing for both security and resilience to withstand e.g. terrorism is

²¹ Source: Figure 4 in Lee (2002), p. 109.

²² Source: Figure 8 in Lee (2002), p. 114.

advocated, whereas the problem of dual/multiple supply chain memberships are pointed out by Sinha, Whitman, & Malzahn (2004):

“... as a supplier provides value to different supply chains, it becomes increasingly risky. Each supply chain has different objectives. A member of a chain may have requirements placed upon them by one supply chain that conflict with requirements of another.” (p. 154).

They propose designing the supply chains to minimize the risks of conflicting goals.

The work by Newman, Hanna, & Maffei (1993) resembles the work of Gupta, Gerchak, & Buzacott (1992) as they propose a dynamic equilibrium model containing internal/external integration, manufacturing flexibility, and buffers (inventory, capacity, and time). In van der Horst & Beulens (2002), the food supply chain is studied and strategies for supply chain redesign based on identified uncertainties are proposed. Analyzing SME’s Ritchie & Brindley (2000) propose the future need to build relationships at speed.

The table below shows the use of the generic risk management in the contributions aiming at the management of the risks. This theme repeats the conclusion from the previous two: risks are to be reduced or avoided.

Table 3-3: Risk Management Strategies in Theme “Supply Chain Design”

Author(s)	-----Risk Management Strategy-----				
	Acceptance	Insurance	Reduction	Sharing	Avoidance
Agrell, Lindroth, & Norrman, 2004			✓		✓
Davis, 1993			✓		✓
Geary, Childerhouse, & Towill, 2002			✓		✓
Grabowski & Roberts, 1999			✓		✓
Hauser, 2003	✓	✓	✓	✓	✓
Johnson, 2001			✓		✓
Lee, 2002			✓	✓	✓
Lonsdale, 1999			✓		✓
Rice & Caniato, 2003			✓		✓
Ritchie & Brindley, 2000			✓		✓
Sinha, Whitman, & Malzahn, 2004	✓	✓	✓	✓	✓

3.3.4 Theme: Risk Management in Supply Chains

Not surprisingly all articles belonging to the theme “Risk Management in Supply Chains” are classified as strategic. The articles are either reporting case studies or are of a conceptual nature, and theory is absent in all but one article (Hallikas et al., 2004 use TCE). All but one article reference Risk, Davis (1993) reference Uncertainty. Albeit quite homogenous when described using the categories the contributions differ quite a lot.

In Grabowski & Roberts (1997) the perspective of complex systems is taken. This clearly differs from a supply chain perspective as the boundaries of the system are not necessarily determined by the commercial objectives of the focal company (as assumed in the supply chain perspective). One of the basic assumptions in complex (or large-scale) systems is that the system as a whole is difficult to comprehend, and decomposition of the system is therefore the norm. Decomposing the system into subsystems to e.g. enable risk mitigation (as is the subject in the article) does not necessarily result in increased clarity:

“In large-scale systems, subsystems are often characterized paradoxically by both autonomy and interdependence.” (p. 154).

In a supply chain perspective the interdependence between subsystems (entities in the chain) is in no way controversial as this may well be the criterion for participation (that is: to become a partner in a supply chain one has to offer dependency to/from other partners?). Autonomy, on the other hand, is less obvious in a SCM perspective, unless perceived as the autonomy in decision making in the entity. Nonetheless, the argument made might be valid for supply chains as well:

“Autonomy and interdependence in large-scale systems make risk mitigation difficult. While risk mitigation measures may well reduce risk in the autonomous subsystems, they may also have little impact (or even increase risk) in the system as a whole. ...Thus, risk mitigation measures for interdependent subsystems must consider the effect on both the subsystems and the overall system.” (p. 154).

Further complicating things, the authors claim that:

“Because of the complexity inherent in large-scale systems, decision making in such systems often has both intended and unintended consequences. Since interactions and influences in large-scale systems can be difficult to discern, the intended results of risk mitigation (i.e. reduced risk) may not occur, and those measures may instead produce unintended consequences.” (pp. 154-155).

Translated into SCM arguments this might result in something like “sub-optimizing on the risk mitigation in any participating entity in the chain, might make the entire chain worse off. Therefore risk management should be communicated and perhaps even integrated”.

Recognizing the multiplicity of risk management alternatives, Hauser (2003) proposes taking a risk perspective when analyzing the supply chains in a company. Working as an advisor on risk management her approach relies on financial models, quantification of the identified risks, and the use of spreadsheets and simulations of adverse events. The overall process of risk management is identical to previous authors, but has an emphasis on the assessment phase and the subsequent monitoring.

Yet another perspective is presented in Link & Marxt (2004) as they deal with projects of cooperation instead of “normal operations”. Perceiving risk as an inherent component in every type of cooperation they propose the integration of “risk and chance management” in the practice of cooperation, and suggest a model, see Figure 3-14 below. Surprisingly, the proposed model does not seem to differ greatly from any other model reviewed, even if the time perspective and the objectives probably will differ from normal operations. The absence of focus on the time perspective and the definition of milestones relating to risk/chance sharing clearly present an opportunity for improvement.

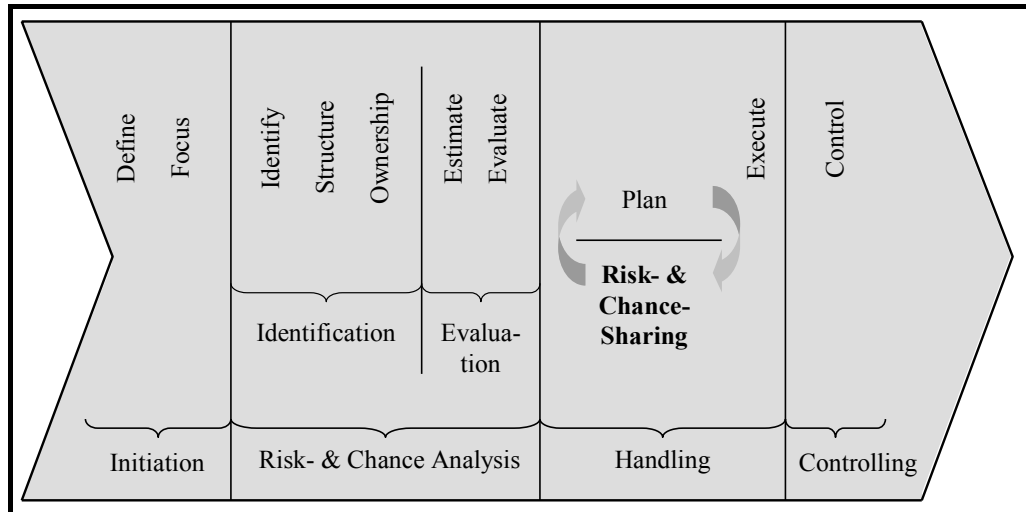
Figure 3-14: Risk and chance management process²³

Norrman & Jansson (2004) take a SCM perspective and agree with other authors (e.g. Christopher & Lee, 2004; Link & Marxt, 2004; Hallikas et al., 2004) that supply chain risks increase due to current business trends such as outsourcing of manufacturing and R&D, globalization of supply chains, reduction of supplier base, more intertwined and integrated processes between companies, and reduced buffers (inventory and lead time) etc. They suggest that:

“... the focus of supply chain risk management (SCRM) is to understand, and try to avoid, the devastating ripple effects that disasters or even minor business disruptions can have in a supply chain.” (p. 435)

and reference an earlier definition of the term SCRM:

“Supply chain risk management is to [collaborate] with partners in a supply chain apply risk management process tools to deal with risks and uncertainties caused by, or impacting on, logistics related activities or resources.” (p. 436).

They emphasize that tools, practices and organizational principles supporting the identification, assessment, prioritization and management of the risks span broader than the focal company:

“SCRM means widening this approach to the chain of suppliers and suppliers’ suppliers. This could be done by visiting suppliers and analyze and assess them, but more proactively to make them implement a SCRM approach themselves, which guarantees a further spread upstream.” (p. 450).

The use of the KPI’s Business Recovery Time (BRT) and Business Interruption Value (BIV) is proposed as measures when implementing SCRM. Not defining the relevant risks, the authors suggest that:

“Current and new logistics principles could be evaluated from a SCRM perspective, and risk management actions must be evaluated from a logistics perspective focusing on cost, time, quality etc.” (p. 454).

²³ Source: Figure 2 in Link & Marxt (2004), p. 73.

In conclusion the integration of Risk in the “logistics triangle” of Cost, Time, and Quality is suggested.

Further elaborating on the supply chain risks, Christopher & Lee (2004) propose that some supply chain risks are generated by the supply chain itself, depending on certain characteristics. They thereby support the notion of uncertainty generation in the supply chain put forward in Wilding (1998a) and propose another concept: the risk spiral. In the risk spiral, the long (lead time in) pipelines lead(s) to a lack of visibility, which in turn leads to a lack of confidence in the supply chain partners and a subsequent build-up of buffers. This in turn increases the time needed for a product to travel through the pipeline further decreasing the visibility etc. Besides the “traditional” risk sources, the author thereby introduce a new category: the decision risks, risks incurring from the participants in the supply chain.

Figure 3-15: The Risk Spiral²⁴

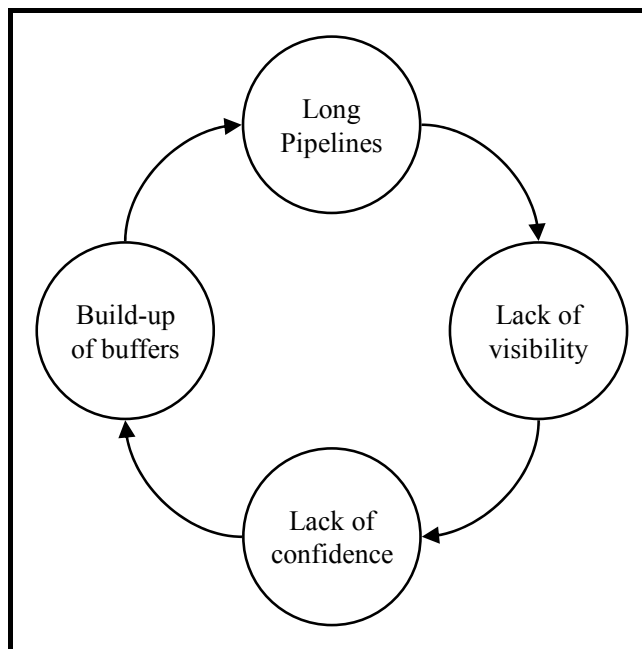

To break this vicious circle an increased confidence in the supply chain is needed. This is done by increasing the visibility (e.g. through information sharing) and the control (e.g. by defining control limits and exceptions procedures).

The problem of interdependence in networks/chain is also under scrutiny in Spekman & Davis (2004) who build the case for even tighter integration between companies as they introduce a new term:

“The notion of the extended enterprise takes supply chain management (SCM) to the next level and focuses on those factors and characteristics that link supply chain members by far more than just workflow and logistics.” (p. 415).

Not easily implemented the authors warn:

²⁴ Source: Figure 1 in Christopher & Lee (2004), p. 390.

“You would think that cross-functional cooperation is easily understood and implemented. However, many if not most managers cannot rise above the typical company reward system that favors individual unit thinking over cross-functional and cross-firm thinking. Metrics that emphasize individual unit profit and loss rarely encourage such joint actions, where win-win thinking rules the day.” (p. 415).

Investigating the risks inherent in supply chain and close cooperation the authors conclude that the management (and acceptance) of risks must be balanced with the traditional measures:

“Cost, delivery and quality can still remain as important considerations, and supply chain members will have to develop processes and mechanisms for developing and nurturing trust among the members of the supply chain as well as acknowledge that they must also take responsibility for the actions of their partners.” (p. 432).

Reporting his experience from Hewlett-Packard Davis (1993) claims effective supply chain management facing short product life cycles, complex corporate joint ventures and increasing requirements from the customers requires the systematic management of supply chain risks. He suggests using modeling to tame the uncertainties and concludes that:

“The value of taking a systems view of the problem cannot be overstated. Organizational barriers introduce tremendous inefficiencies in supply chains. It is critical that all players in the business of getting products to customers consider their role in the objective of satisfying the customer. Strategic decisions on supply chain design can increase customer satisfaction and save money at the same time – the classic win-win situation.” (p. 45).

Reporting on case studies Hallikas, Virolainen et al. (2002) use internal audits and cause-effect mapping to describe the risks in the networks studied. The risks investigated in their study fall in four classes: “Demand related factors and value chain positioning”, “Delivery performance ability”, “Financial factors”, and “Pricing”. In a later article Hallikas et al. (2004) develop the framework further, and suggest a “network version” of the generic risk management process (described above, see Figure 3-8). The authors suggest that the mutual management of risks may follow the implementation of internal risk management practices, and may enable the participating partners to develop their risk management to identify, assess, and manage risks facing the network as a whole.

Presenting a case study from the toy industry, Johnson (2001) categorizes the risks into the classes Demand Risk and Supply Risk. Both classes are further broken down and alternative means of managing the risks are suggested, illustrating the multiplicity of risk sources and risk management opportunities in managing risks, see Table 3-4 below.

Table 3-4: Summary of Risk Management Lessons²⁵

Risk	Alternative Means of Managing Risk
Product Demand	
Seasonal Imbalance	Licensed Products; Alternative Channels; Develop Collector Market
Fad Volatility	Channel Release Strategies for Licensed Products; Shortage Strategies; Collector Markets
New Product Adoption	Match Channel and Product; Product Extensions and Branding; Licensing
Short Product Life	Manage Product Variety with Rolling Mix
Product Supply	
Manufacturing Capacity	Outsourcing Strategy; Combine Off-Setting Seasonal Products
Logistics Capacity	Consolidation; Supplemental Outsourcing; Electronic Supply Chain; Product Diversion; Channel Coordination; Retail Ready Products; Air Freight
Currency Fluctuations	Financial Hedging
Supply Disruptions	Diversify Supply

Further emphasizing the perception that each risk is a separate and distinct event with unique opportunities for management, Johnson perceives the up- and down-stream risk sources as distinctly different. The focus on the down-stream risks distinguishes Johnson from most of the other authors identified, as risks for some reason are perceived as primarily originating from the supply side. But Johnson has a point when he emphasizes the necessity of including the downstream side as well, especially in the toy market characterized by short product life cycles and highly seasonal demand.

In conclusion, all contributions on the management of risks rely on a traditional phase model, including identification, assessment, management and subsequent monitoring. The adaptation of the traditional single-company perspective to a multi-entity environment is under way but has a long way to go, as described in Grabowski & Roberts (1997). The classification of risk sources and mechanisms also seem to be evolving. Most of the identified articles illustrate the importance of acknowledging the perspective taken when dealing with risk management in supply chains/networks.

An overview of the contributions advocating the management of the risks can be seen in Table 3-5 below. As for the other themes, most emphasize the reduction or avoidance of risks. Different from the other themes, almost all contributions in this theme are published within the past few years.

Table 3-5: Risk Management Strategies in Theme “Supply Chain Risk Management”

Author(s)	-----Risk Management Strategy-----				
	Acceptance	Insurance	Reduction	Sharing	Avoidance
Christopher & Lee, 2004			✓		✓
Davis, 1993			✓		✓
Grabowski & Roberts, 1997			✓		✓
Hallikas et al., 2004	✓		✓	✓	✓
Hauser, 2003	✓	✓	✓	✓	✓
Johnson, 2001			✓		✓
Link & Marxt, 2004			✓	✓	✓
Norrman & Jansson, 2004	✓		✓		✓

²⁵ Extract from: Exhibit 8 in Johnson (2001), p. 122.

3.4 Conclusion

It should by now be evident that the use of the terms Risk and Uncertainty has been quite extensive within the SCM domain and that the use of the term Vulnerability has been quite limited. Albeit to a certain degree used interchangeably, the terms Risk and Uncertainty have each had their distinct use: Uncertainty as an assumption for authors aiming at improving various techniques for operations, and Risk implying the possibility of identification, assessment, and management. No commonality on risk definitions, time horizons or other classifying attributes on the terms has been identified.

The themes identified clearly illustrate the wide scope of risk, uncertainty and vulnerability. A lot of the contributions have no direct relevance to SCM, besides emphasizing the uncertainty of e.g. Operations, Decision Making, or the problems concerning New Product Introduction. That risk relates to strategy is directly observable in the seven articles belonging to that theme.

Figure 3-16: Themes Identified

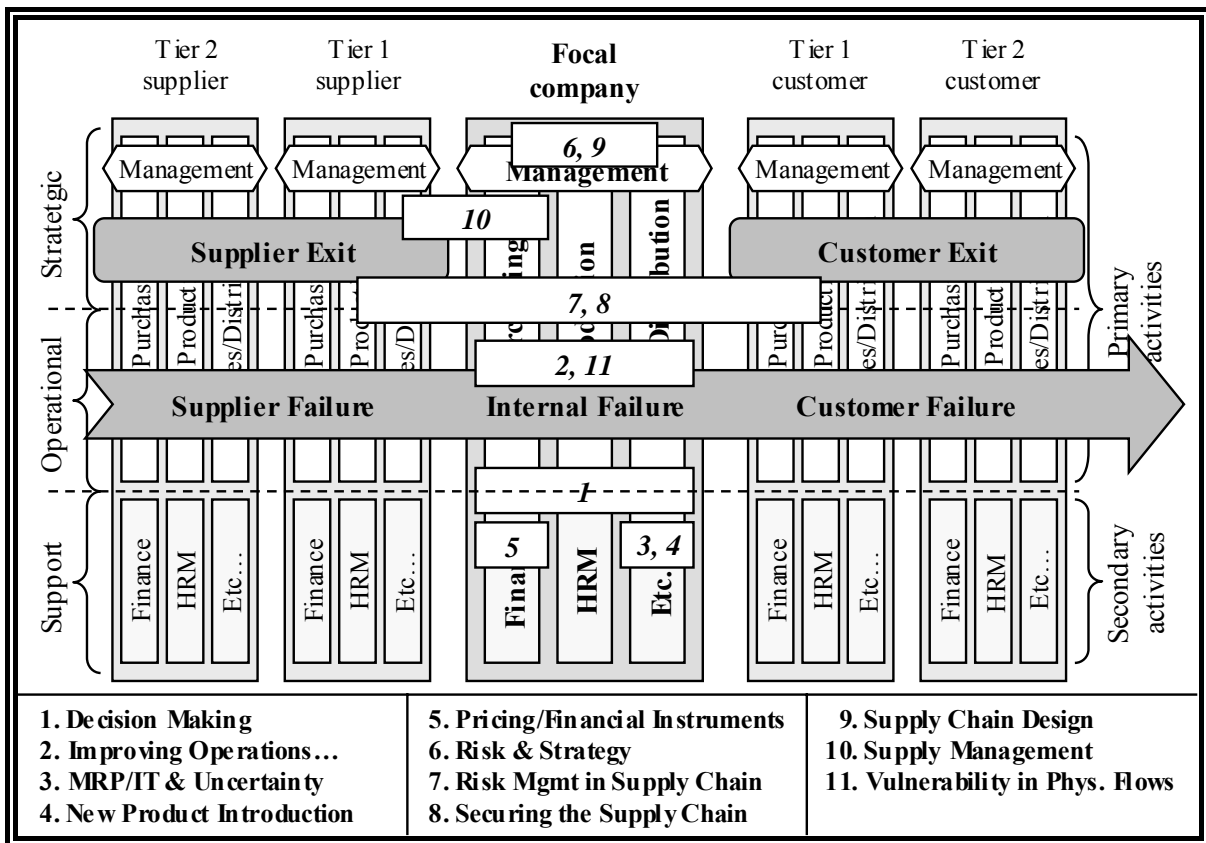

In relation to the SCM perspective a number of relevant themes have been identified. The theme “Securing the Supply Chain” has a limited number of articles, and contains primarily conceptual contributions advocating preparing for terrorist attacks and other shocks. In contrast, quite a lot of articles deal with “Supply Management”. The interest is spread between e.g. perceptions of risk (e.g. Zsidisin, 2003a; Zsidisin, 2003b), management of uncertainty in supply (e.g. Hill & Vollmann, 1986; Ottesen & Gronhaug, 2002a), and risk assessment techniques (e.g. Templin & Noffsinger, 1994; Zsidisin et al., 2004). In the theme

“Risk Management in Supply Chain” various definitions of the term SCRM are presented. The last theme identified, “Supply Chain Design”, shows great variation on the definition of relevant risks as well. Interestingly, the interest for the downstream side is quite limited, except for articles on distribution (e.g. Bartezzaghi & Verganti, 1995; Johansen, 1999; Speh & Wagenheim, 1978; Weng, 1999; Zaidman, 1994) or marketing/demand uncertainty (e.g. Bunn & Liu, 1996; Meldrum & Millman, 1991; Polk, Plank, & Reid, 1996; Westbrook, 1996). Figure 3-16 above illustrates the identified themes against the SCRM framework.

3.5 Epilogue: SCM in the Risk Domain

The last perspective on the intersection of SCM and the terms Risk, Uncertainty and Vulnerability is described in an analysis of articles on Logistics/SCM within the Risk domain. This study uses the same methodology, but performs the completeness check within the selected journals²⁶. As for the main study the volumes are read through manually.

Results

The result from the study is quite meager as only six articles are identified. Published in the journals *Risk Analysis – An International Journal* and *Risk Management* the articles all deal with transportation risk. All articles are at the operational level, all are oriented up- and downstream (but not internally), and none use theory.

Conclusion

It is thereby concluded that the primary source for contribution on Risk, Uncertainty, and Vulnerability within the SCM domain is to be found with that domain – and that the main study unraveled the relevant contributions.

²⁶ This study was performed in parallel with the main study. Details in Appendix E.

Chapter 4 Supply Chain Design

The purpose of this chapter is to answer the second research question:

Research Question 2: How does state-of-the-art supply chain design address the management of supply chain risks?

To this end an extensive literature study on Supply Chain Design has been performed¹. The aim of the literature study is to identify and analyze the articles on Supply Chain Design, and to investigate how and to which degree the management of risk is integrated into the design of supply chains. To aid the description the conceptual model developed in previous chapters is used – categorizing contributions according to orientation and design object, see Figure 4-1 below.

Figure 4-1: Supply Chain Risk Framework

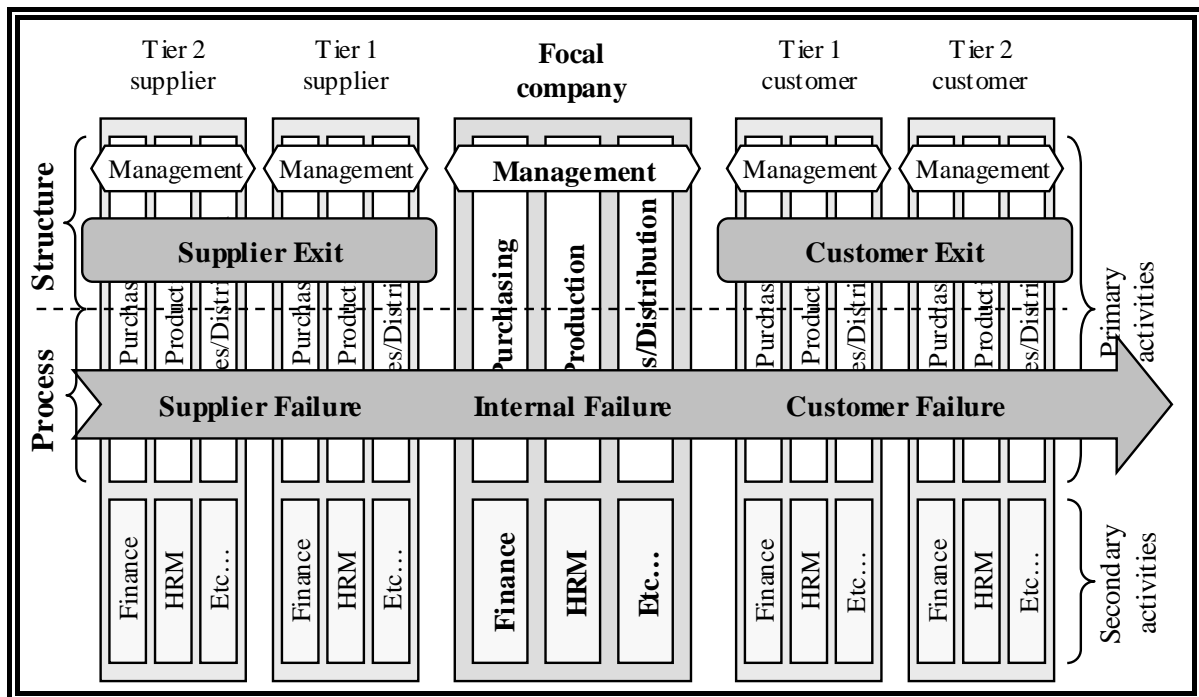

4.1 Research Methodology

As the intent of this literature study is to be able to make firm statements on the state-of-art of Supply Chain Design the “domain-based” strategy has been applied. As for the literature study in the previous chapter, the source (population) for the study is the list of Supply Chain Management, Operations Management, and General Management journals presented in Table 1-1. Instead of repeating the time-consuming task of manually reading through each volume of each journal as done in the study reported in the previous chapter, this study is designed for the use of internet-based search engines. To ensure a wide collection of articles, the search criterion has been set to articles with the Abstract field containing the words “Supply”,

¹ The study was performed in the spring of 2003 and updated in April, 2005. Details in Appendix F.

“Chain”, and “Design”². As this obviously will result in irrelevant articles as well as relevant ones, each article is evaluated for relevance.

The strategy chosen for the literature study enables and justifies a completeness check which is performed by text searches across the five relevant databases: ABI/INFORM, Business Source Premier, EMERALD, JSTOR, and ScienceDirect. The criterion for the completeness check is for the article to have the words “Supply”, “Chain”, and “Design” in the Keyword field³. The number of relevant hits in this search will determine the “completeness” of the literature study. Subsequent to performing the identification of the articles, each article is evaluated according to the following categories:

- Relevance: Addressing Supply Chain Design?
- Design Object: Structure and/or Process
- Orientation: Upstream, Internal, Downstream, and/or Network
- Research Method: Case study, Simulation...
- Explicit Theory: TCE, RBT...

The first category serves the obvious goal of identifying and eliminating irrelevant articles from the list. The next two categories serve the purpose of illustrating the focus and reach of the design ambition of each article. The research method aims at classifying the articles based on the approach to empirics (conceptual articles are classified ‘None’), and the last category aims at classifying according to the explicitly referenced theory. Insisting on the explication of theory is justified by the need to document the operationalization of theory on Supply Chain Design. Subsequently, the articles are analyzed and classified in the categories ‘Subject Area’, ‘Design Objective(s), and ‘Reference to Risk/Uncertainty’.

4.2 Results

The search results in a gross list containing 149 articles, distributed across the journal categories as follows: SCM/Logistics 77, Operations Management 52, and Management journals 20. The completeness check identifies 27 articles, of which fourteen have already been identified, thereby increasing the number of potential contributions to 162.

Proof reading the articles for relevance reveals a wide variation of subjects and methods. Most articles rejected for lack of relevance (for this study) fall into the following categories:

1. methodological frameworks (e.g. Larson & Gammelgaard, 2001; Zografos & Giannouli, 2001),
2. implications of various techniques/methods (e.g. Anumba, Siemieniuch, & Sinclair, 2000; Nynke Faber, de Koster, & van de Velde, 2002), and
3. narrowly defined sub-disciplines/areas (e.g. reverse logistics: Guide Jr & Van Wassenhove, 2002; Walker, 2000).

² Search expression: “‘Supply’ AND ‘Chain’ AND ‘Design’” in the Abstract field.

³ Search expression: “‘Supply’ AND ‘Chain’ AND ‘Design’” in the Keyword field. In databases not supporting keyword searching (ABI/INFORM and JSTOR), search expression is: “‘Supply Chain Design’” in the Abstract field.

Of the total 162 articles 122 are rejected due to lack of relevance. The net list thereby contains a total of 40 articles (SCM: 22, OM: 11, MGMT: 4, & Other: 3). As only three relevant articles (Johnson, 1998 from *Management Review*, Abdinnour-Helm, 1999 from *International Journal of Agile Management Systems*, and Reiner & Trcka, 2003 from *International Journal of Production Economics (IJPE)*) are identified in the completeness check, the list of journals and the search method is considered appropriate for the research topic, and the study is considered complete.

4.2.1 Categories: Design Object & Orientation

The articles are quite evenly distributed across ‘Design Object’ as thirteen of the 40 articles focus on structure, seventeen on process, and the remaining ten articles focus on the concurrent design of process and structure. The other category, ‘Orientation’, displays less homogeneity as seven articles are oriented upstream, 25 are internally oriented, seven are oriented downstream, and 21 are oriented towards the network level (multi-entity)⁴.

4.2.2 Category: Research Method

A large portion (fourteen) of the articles identified (primarily in SCM journals) is of a conceptual nature. Also primarily from SCM journals fifteen articles are reporting case studies, whereas the eight articles using modeling primarily are from OM journals. Lastly, three articles use simulation.

4.2.3 Category: Explicit Theory

Analyzing the identified articles for explicit use or reference to theory reveals that only two theories are referenced: Chaos Theory and Transaction Cost Economics (TCE). The article referencing Chaos Theory (Wilding, 1998b) has already been described in Chapter 1 and will therefore not be further elaborated on here. As for TCE, three articles (Christiaanse & Kumar, 2000; McIvor, 2000; McIvor, 2003) have been identified.

Being interested in outlining general principles for ICT-enabled⁵ redesign of supply chains for improved responsiveness, lower cost, and reduced lead times, Christiaanse & Kumar claim that ICT makes radical supply chain redesign possible. The TCE framework is used to illustrate archetypes of inter organizational structures, and to describe switching and coordination costs⁶. In McIvor (2000) a general framework for the outsourcing decision is presented, in the latter article (McIvor, 2003) a case study using that framework is presented. The use of the theoretical framework of TCE is most explicit in the latter article where the theoretical discussion on e.g. bounded rationality, opportunism, small numbers bargaining etc. is to be found.

⁴ These values are non-exclusive – an article might be oriented upstream and internally both. The sum across the four category values therefore might exceed the number of articles identified.

⁵ ICT - Information & Communications Technology.

⁶ For a more comprehensive discussion on theories, please refer to Chapter 5.

4.2.4 Subject Area and Design Objective(s)

Another way of describing the state-of-art of Supply Chain Design is by analyzing the identified articles by subject area and design objective(s), see Table 4-1 below.

Table 4-1: Further Classification of Articles on Supply Chain Design⁷

No	Author(s)	Risk/Uncertainty	Subject Area	Design Objective(s)
1.	Anderson & Katz, 1998	✓	Supply management	Profitable/sustainable growth
2.	Christopher & Towill, 2002	✓	Leanness/Agility	Responsiveness/Lower cost
4.	Hewitt, 1994	☐	SC re-design	Efficiency/Effectiveness
5.	Payne & Peters, 2004	☐	Matching product and chain	Cost/Performance
6.	van der Horst, van Dijk, & Beulens, 2001	✓	Decoupling	Reduce demand uncertainty
7.	van Hoek & Weken, 1998	☐	Modular production	Responsiveness/Efficiency
8.	Wilding, 1998b	✓	Chaos theory	Removal of uncertainty
9.	Wouters, Sharman, & Wortmann, 1999	☐	Inventory mgmt.	Differentiation/Efficiency
18.	Christiaanse & Kumar, 2000	☐	ICT and SC redesign	Cost/Value/Flexibility
19.	Christopher & Towill, 2001	☐	Agility	Cost
29.	Mason et al., 2002	☐	Outsourcing (electr. mfg.)	Agility
40.	van Hoek, Commandeur, & Vos, 1998	☐	Postponement	Responsiveness
48.	Chandra & Kumar, 2000	☐	Accurate (quick) response	Synchronization of chain
50.	Hammel, Kuettner, & Phelps, 2002	☐	SC re-design	Exploitation of opportunity?
58.	McIvor, 2000	☐	Outsourcing	<u>Strategic</u> Decision Making
59.	McIvor, 2003	✓	Outsourcing	Identify drivers and processes
64.	Towill, 1996	☐	Time compression	Cost/Responsiveness
67.	Zeng, 2003	☐	Global sourcing	Effectiveness (transport/dist.)
70.	Boyson & Corsi, 2001	✓	Real-time supply chain	Reduction of waste (time)
72.	Dershin, 2000	✓	Business process re-eng.	Efficient SC integration
74.	Kopczak, 2001	✓	SC design/Last mile strategy	Differentiation/Efficiency
75.	Martha & Subbakrishna, 2002	✓	Risk management in SCD	Risk (Survival)
83.	Boardman & Clegg, 2001	✓	3D-CE for Prod. Dev.	Faster product introduction
86.	Fowler, 1998	☐	Modelling in Mgmt of Ops	Competitive Advantage
92.	Korpela, Lehmusvaara, & Tuominen, 2001a	☐	Supply Chain Development	Logistics effectiveness
93.	Korpela, Lehmusvaara, & Tuominen, 2001b	☐	SC Design for Cust. Service	Cost/Customer service
94.	Korpela et al., 2002	✓	Allocation of prod. capacity	Risk (Customer service)
96.	Persson & Olhager, 2002	☐	Simulation of supply chain	Cost/Quality/Lead time
104.	Blackhurst, Wu, & O'Grady, 2005	☐	Design decisions	"Fit"/Efficiency
105.	Fine, Golany, & Naseraldin, 2005	☐	3D-CE	"Fit"/Efficiency
109.	Hammel & Kopczak, 1993	☐	Distrib. Res. Planning (DRP)	Availability/Cost
113.	Fine, 2000a	☐	3D-CE	"Fit"/Efficiency
127.	Towill, 1997	☐	Material flow	Order cycle/Variability
137.	Robinson Jr & Satterfield, 1998	☐	Design of distrib. systems	Profit maximization
138.	Swaminathan, Smith, & Sadeh, 1998	✓	SC design	Cost
142.	Ferdows, Lewis, & Machuca, 2004	☐	Quick response	Responsiveness/Cost (inv.)
148.	Lee, Padmanabhan, & Whang, 1997	☐	Bullwhip/Forrester	Cost (inventory)
158.	Johnson, 1998	☐	Bullwhip/Forrester	Cost (inventory)
165.	Abdinnour-Helm, 1999	☐	Distribution	Performance
175.	Reiner & Trcka, 2003	✓	SC design	Performance/Robustness...

⁷ Number corresponds to the list of identified articles in Appendix F.

Grouping by Subject Area

Analyzing the articles for subject area a few groupings quickly emerge. The largest group of articles identified not surprisingly deals with principles for Supply Chain Design. But other groups are identified.

A number of articles deal with the fit between product, process, and supply chain, most notably by Fine (2000b) who introduces the term Three Dimensional Concurrent Engineering (3D-CE). Another group of articles deal with distribution and yet another with outsourcing, see Table 4-2 below.

Table 4-2: Grouping articles on Supply Chain Design by Subject Area⁸

Group	Articles (referenced by number)
Supply Chain Design	4, 18, 50, 72, 92-94, 138, 175
3D-CE	5, 83, 104, 105, 113
Distribution	74, 109, 137, 165
Outsourcing	29, 58, 59
<i>Agility</i>	<i>2, 19</i>
<i>Bullwhip</i>	<i>148, 158</i>
<i>Quick Response</i>	<i>48, 142</i>
<i>Supply Management</i>	<i>1, 67</i>

The last four entries in the table above barely qualify for being a group as only two articles could be identified for each of those subject groups (shown in italics). The articles not referenced in the table above are so different from each other that no commonalities could be found. The degree of dispersion is thereby quite high.

Grouping by Design Objectives

Analyzing the articles for design objectives shows the same pattern. Classifying the articles according to a multi-objective framework as e.g. the one mentioned in Chapter 2 results in a number of categories emerging.

The most “popular” design objective is ‘Cost’ as fourteen of the 40 articles explicitly reference this design objective⁹. The second most popular objective is ‘Performance’ with thirteen articles, followed by ‘Responsiveness’ (five), and ‘Lead Time’ (four)¹⁰. Two articles (Martha & Subbakrishna, 2002; Korpela et al., 2002) even reference ‘Risk’ as design objective. Articles not referencing these “generic” objectives include articles on reducing demand uncertainty (van der Horst, van Dijk, & Beulens, 2001; Wilding, 1998b), synchronization and integration of supply chains (Chandra & Kumar, 2000; Dershin, 2000) and five others on assorted subjects. Table F-7 contains all the details.

More interestingly, most (24) of the articles refer to a single in contrast to multiple objectives (as shown in Figure 2-10). It may be that the ‘Cost’ objective is taken for granted. But, even

⁸ Number corresponds to the list of identified articles in Appendix F.

⁹ Actually, two articles (Anderson & Katz, 1998; Robinson Jr & Satterfield, 1998) reference Profit. They are shown in brackets in the table.

¹⁰ One article (Boardman & Clegg, 2001) refer to the speed of introducing new products (shown in brackets in the table).

if few articles use ‘Risk Management’ or ‘Uncertainty Reduction’ as a design objective, more articles reference Risk and/or Uncertainty.

4.2.5 Reference to Risk/Uncertainty

Besides analyzing first the focus and reach of the contributions within Supply Chain Design and then the subject and design objectives, it is of interest to analyze the roles Risk and Uncertainty play. Analyzing the 40 articles for reference to Risk and Uncertainty is disappointing as only thirteen contributions are identified (see Table 4-1 above). Among these articles almost no commonality exists; three articles deal with uncertainty/volatility of demand - all other deal with some unique aspect of risk/uncertainty.

Demand Uncertainty/Volatility

Furthermore, the three articles on demand uncertainty are quite different from each other. Christopher & Towill (2002) write on agility and leanness and aim at reducing total cost and improving customer responsiveness, whereas Van der Horst, van Dijk, & Beulens (2001) illustrate coping with demand uncertainty in a food supply chain by the use of decoupling points. The last article dealing with demand uncertainty is Reiner & Trcka (2003) who write on supply chain improvements, and aim at increasing the robustness of supply chain through (non-defined) improvements.

Other aspects of Risk/Uncertainty

The residual group of articles referencing other aspects of risk/uncertainty span from Wilding’s (1998b) article on uncertainty generated by the complexity of (tightly integrated) supply chains over Martha & Subbarkrishna’s (2002) piece on the potential effects of terrorism to Boardman & Clegg’s (2001) article on 3D concurrent engineering (3D-CE) to reduce the commercial risks in product development.

In McIvor (2003) an analysis of the risks involved in three cases of outsourcing within the same firm is presented, and the company is cited for concluding that:

“Through outsourcing the company is reducing its level of risk. For example, by gradually outsourcing manufacturing processes it is reducing risk by converting its fixed costs into variable costs. In times of adverse business conditions suppliers will then have to deal with the problem of excess capacity. The company argues that suppliers are better able to cope with demand fluctuations through economies of scale and have more scope for alternative sources for this excess capacity.” (p. 390).

Interestingly, this conclusion is in direct conflict with the argument put forward by the author in a previous article (McIvor, 2000), where reliance on external partners is avoided whenever possible. Also in Anderson & Katz (1998) risk is a part of a framework, business risk is coupled with revenue impact in a portfolio model for purchasing, and defined as:

“The revenue impact/business risk dimension addresses the degree to which a purchase category can influence customers’ perception of value.” (p. 5).

The portfolio model combines ‘Revenue Impact/Business Risk’ with ‘Procurement Complexity’ and suggests strategic sourcing skills for each cell.

The uncertainty referred to in Kopczak (2001) relates to the implementation of the internet-based distribution channel, whereas in Boyson & Corsi (2001) the uncertainty to be tamed stems from the complexity of the “real-time supply chain” spanning the globe. Dershin (2000) claims the lack of awareness and control of supply chain processes is a major risk to companies and advocate the use of the TQM framework to redesign business processes.

In Korpela et al. (2002) a modeling approach is taken to the problem of allocating production capacity to customers with different service requirements, using suppliers with different strategies and with different risks relating to the customer-supplier relationship. The risk element is further broken down into History, Position, Competitors, and Customer’s Business and the three-tier structure is modeled using AHP and mixed integer programming. Also using modeling Swaminathan, Smith, & Sadeh (1998) propose using simulation to analyze the risks and benefits of different supply chain reengineering alternatives before implementation.

Overview

In Figure 4-2 the identified articles are depicted according to Level and Orientation. Numbers correspond with Table 4-1.

Figure 4-2: Articles on Supply Chain Design

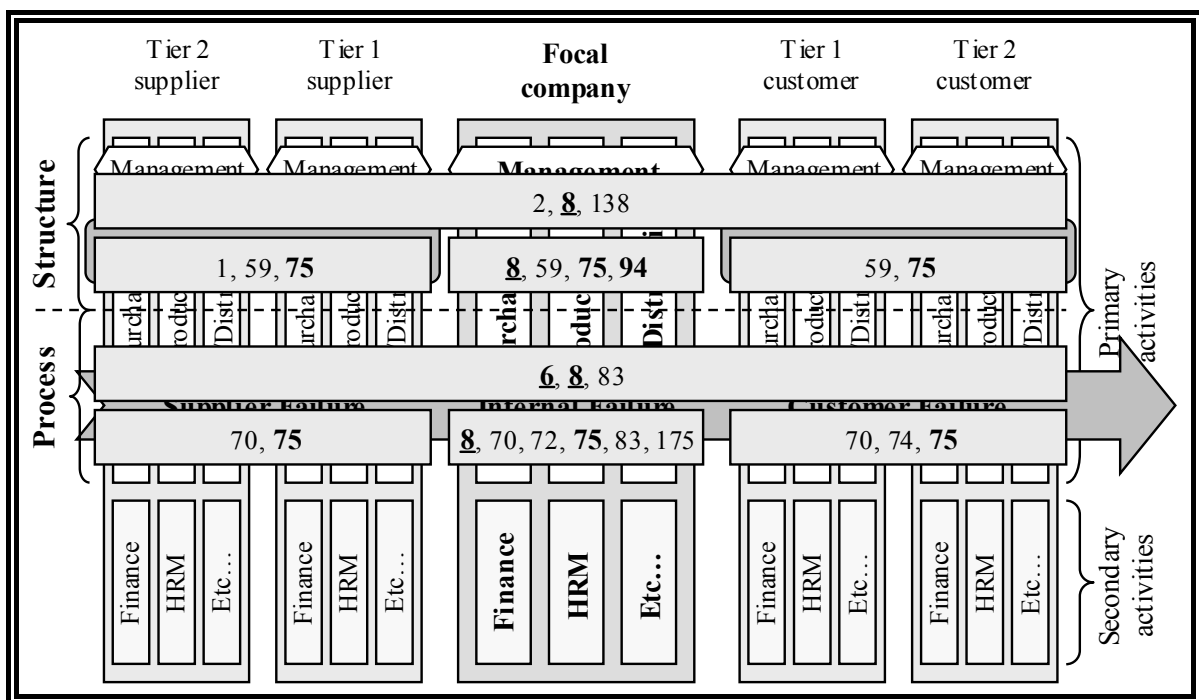

Four of the identified articles are emphasized in the figure above. Number 75 is the article on terrorism (Martha & Subbkrishna, 2002) and number 94 is the one on (internal) production capacity allocation (Korpela et al., 2002). These two articles are the ones having ‘Risk’ as a design objective (marked as bold). Articles numbered 6 and 8 are the case study on the Dutch poultry supply chain (van der Horst, van Dijk, & Beulens, 2001) and Wilding’s (1998b)

article on chaos theory, respectively. The former article aims at removing demand uncertainty, the latter at removing uncertainty in general (both marked as bold and underlined). The rest of the articles depicted in the figure above simply use risk/uncertainty as an assumption about the context/environment.

4.2.6 Conclusion

The analysis of the orientation of the identified articles on supply chain design showed that both the up- and down-stream sides as well as internal operations are covered. A number of articles even take the holistic (network) level when analyzing for supply chain design. Both structure and process are objects for design, and a number of articles have the aim of performing concurrent analysis and design of both. A large proportion of the articles identified are of a conceptual nature. Among the empirically based papers most use case studies, especially the articles from the SCM journals. Conversely, the articles from the OM journals are primarily using modeling, and few use simulation.

Grouping the articles by subject area reveals a wide range of subjects, and analyzing the articles by design objective reveals that relatively few have (explicitly stated) multiple objectives, thereby contradicting the multi-objective model presented in Figure 2-10. Of the 40 articles identified, only two reference 'Risk' as design objective (Martha & Subbakrishna, 2002; Korpela et al., 2002). Another two aim at reducing uncertainty (van der Horst, van Dijk, & Beulens, 2001; Wilding, 1998b).

Most surprisingly, the role played by risk and uncertainty within Supply Chain Design is quite marginal as only thirteen articles referencing the terms can be identified. Even within this select group of articles very little commonality exist. Three articles reference demand uncertainty, whereas little commonality is to be found between the rest. Of all the articles analyzed only one (Martha & Subbakrishna, 2002) actually aims at integrating the process of risk management into SCM when designing supply chains.

4.3 Comparing With Theme 'Supply Chain Design'

As the literature study on Risk and Uncertainty reported in the previous chapter contains a theme called 'Supply Chain Design', it seems appropriate to compare the two studies and to supplement the study on Supply Chain Design with any contributions not already identified. Therefore the articles from the theme 'Supply Chain Design' are listed in Table 4-3 below.

Table 4-3: Extracts from Appendix D¹¹

No	Author(s)	Term RVU	Phase I AM	Orientation U I D N	Level S O	Research Method	Explicit Theory
16.	van der Horst & Beulens, 2002	U	I	U	O	None	None
30.	Vidal & Goetschalkx, 2000	U	- - -	N	O	Math. mod.	None
38.	Lonsdale, 1999	R	AM	U	S	Case study	RBT
39.	Sinha, Whitman, & Malzahn, 2004	R	M	U	S	None	SCOR*
42.	Geary, Childerhouse, & Towill, 2002	U	M	U I D	S	Case study	None
43.	Hauser, 2003	R	I AM	N	S	Case study	None
46.	Rice & Caniato, 2003	R	M	U I D	S	None	None
60.	Newman, Hanna, & Maffei, 1993	U	- - -	I	S	None	None
62.	Agrell, Lindroth, & Norrman, 2004	R	AM	N	S	Math. mod.	Agency
69.	Gupta, Gerchak, & Buzacott, 1992	U	- - -	I	O	Math. mod.	None
77.	Korpela et al., 2002	R	A	D	S	Math. mod.	None
103.	Treleven & Schweikhart, 1988	R	A	U	S	None	None
122.	Johnson, 2001	R	M	U D	S	Case study	None
123.	Lee, 2002	U	M	U D	S	None	None
172.	Davis, 1993	U	M	N	S	Case study	None
181.	Grabowski & Roberts, 1999	R	M	N	S	None	None
182.	Kouvelis & Milner, 2002	U	- - -	U D	S	Math. mod.	None
184.	Ritchie & Brindley, 2000	R	M	U D	S	None	None
185.	Sabri & Beamon, 2000	U	- - -	N	S	Math. mod.	None

The overlap between this study and the literature study reported in previous chapter is surprisingly low as only three articles (Vidal & Goetschalkx, 2000; Sinha, Whitman, & Malzahn, 2004; and Korpela et al., 2002) appear in both studies.

Analyzing for Design Objective

This leaves sixteen articles to be analyzed for design objective.

Table 4-4: Articles Classified According to Design Objective(s)¹²

No	Ref.	Cost (Profit)	Perfor- mance	Respon- siveness	Lead Time	Risk/ Vulnerability	Residual Design Objective(s)
177.	16.	<input type="checkbox"/>	<input type="checkbox"/>	<input type="checkbox"/>	<input type="checkbox"/>	<input type="checkbox"/>	Uncertainty
178.	38.	<input type="checkbox"/>	<input checked="" type="checkbox"/>	<input type="checkbox"/>	<input type="checkbox"/>	<input checked="" type="checkbox"/>	Dependency
179.	42.	<input type="checkbox"/>	<input checked="" type="checkbox"/>	<input type="checkbox"/>	<input type="checkbox"/>	(<input checked="" type="checkbox"/>)	Uncertainty
180.	43.	<input type="checkbox"/>	<input checked="" type="checkbox"/>	<input type="checkbox"/>	<input type="checkbox"/>	<input checked="" type="checkbox"/>	
181.	46.	<input type="checkbox"/>	<input type="checkbox"/>	<input type="checkbox"/>	<input type="checkbox"/>	<input checked="" type="checkbox"/>	Resilience
182.	60.	<input checked="" type="checkbox"/>	<input checked="" type="checkbox"/>	<input checked="" type="checkbox"/>	<input checked="" type="checkbox"/>	<input checked="" type="checkbox"/>	Flexibility
183.	62.	<input type="checkbox"/>	<input checked="" type="checkbox"/>	<input type="checkbox"/>	<input type="checkbox"/>	<input type="checkbox"/>	Investment efficiency
184.	69.	<input checked="" type="checkbox"/>	<input checked="" type="checkbox"/>	<input type="checkbox"/>	<input type="checkbox"/>	<input type="checkbox"/>	Optimal capacity, Flexibility
185.	103.	<input checked="" type="checkbox"/>	(<input checked="" type="checkbox"/>)	<input type="checkbox"/>	<input type="checkbox"/>	<input checked="" type="checkbox"/>	Technology Access, Quality
186.	122.	<input type="checkbox"/>	<input type="checkbox"/>	<input checked="" type="checkbox"/>	<input checked="" type="checkbox"/>	<input type="checkbox"/>	
187.	123.	<input type="checkbox"/>	<input checked="" type="checkbox"/>	<input type="checkbox"/>	<input type="checkbox"/>	<input type="checkbox"/>	“Fit”: Product & Strategy
188.	172.	<input checked="" type="checkbox"/>	<input type="checkbox"/>	<input type="checkbox"/>	<input type="checkbox"/>	<input type="checkbox"/>	Supply chain uncertainty
189.	181.	<input type="checkbox"/>	<input checked="" type="checkbox"/>	<input type="checkbox"/>	<input type="checkbox"/>	<input checked="" type="checkbox"/>	
190.	182.	<input checked="" type="checkbox"/>	<input type="checkbox"/>	<input type="checkbox"/>	<input type="checkbox"/>	<input type="checkbox"/>	Outsource/adapt capacity
191.	184.	<input type="checkbox"/>	<input checked="" type="checkbox"/>	<input type="checkbox"/>	<input type="checkbox"/>	<input type="checkbox"/>	Adaptability (amorphous net)
192.	185.	<input checked="" type="checkbox"/>	<input checked="" type="checkbox"/>	<input type="checkbox"/>	<input type="checkbox"/>	<input type="checkbox"/>	Flexibility

¹¹ Please note that ‘Level’ (Strategic/Operational) does not correspond completely with ‘Design Object’ (Structure/Process).

¹² The ‘Ref.’ field contains reference to the literature study in Chapter 3 and to Table 4-3.

Of these sixteen articles seven address risk or vulnerability directly, as shown in the table above. Including the articles not directly designing for risk management but aiming at reducing uncertainty in some way, the resulting set contains nine articles. Distribution across structure/process and orientation is depicted in Figure 4-3 below (the four articles identified in the original study is included as well).

Figure 4-3: Articles on Supply Chain Design (& Risk/Uncertainty)

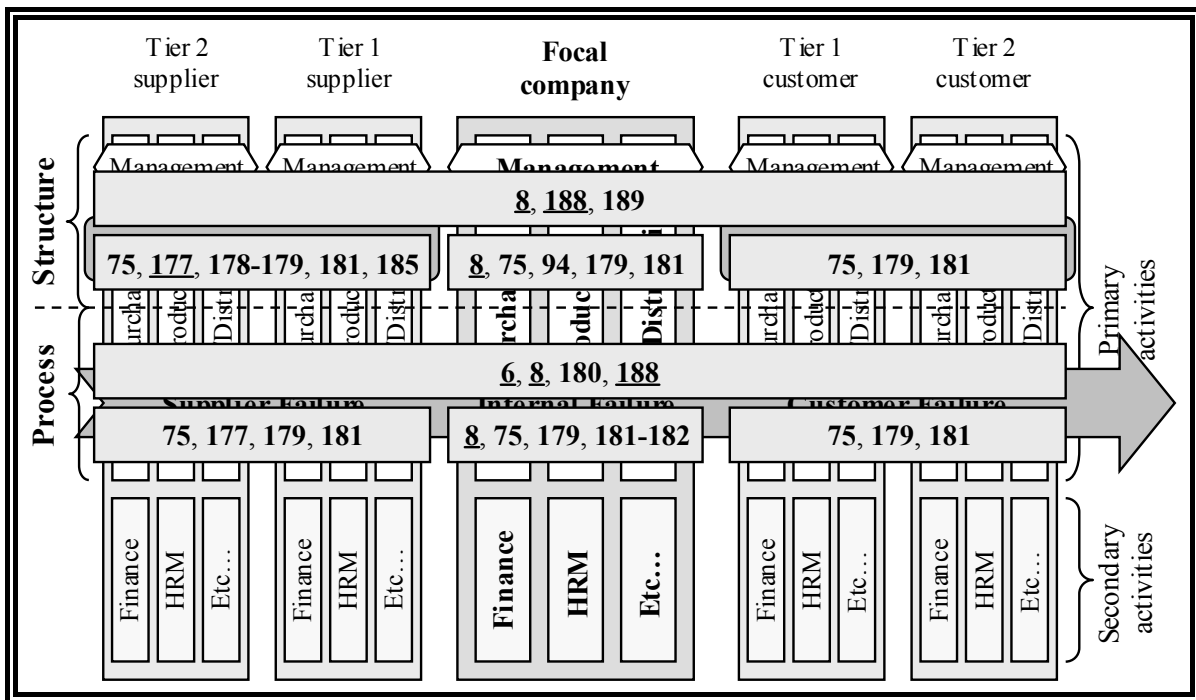

4.3.1 Conclusion

Despite the stringency of the method applied in the search for articles on “Supply Chain Design” the subset of articles from the literature study on “Risk, Uncertainty, and Vulnerability” (the theme on “Supply Chain Design”) actually contribute with more articles on supply chain design for risk management than the original study. Albeit frustrating, this only emphasizes the necessity of performing stringent literature studies, and to try alternate strategies before settling with a population for further analysis.

The combined set depicted in Figure 4-3 above thereby represents the state-of-art of “Supply Chain Design referencing Risk or Uncertainty”.

4.4 Comparing with Classic Articles

In Table 2-1 a list of classic articles on SCM is presented. The overlap between these articles and the results of this study is quite limited as they have only three articles in common (Hewitt, 1994; Lee & Billington, 1992; Towill, Naim, & Wikner, 1992). Encouraging though, is the fact that the classification of these articles are identical in the two studies (neither Lee & Billington (1992) nor Towill, Naim, & Wikner (1992) are considered relevant from a risk perspective).

Risk and Reward Structure

Of special interest is naturally the seven articles referring the category “Risk and Reward Structure”. The earliest of the articles (Ellram & Cooper, 1990) is on Supply Chain Management, partnerships, and third-party relationships (within transportation). Being an early contribution, the authors spend quite some time discussing SCM as well as explaining the role of uncertainty:

“Wherever uncertainty exists along a supply chain, whether it be in terms of product quality, delivery timing, final demand, or the actual amount of the product which will ultimately be received, this uncertainty has traditionally been buffered with inventory.” (p. 2).

The authors state that SCM challenges this traditional approach to managing uncertainty:

“The supply chain management concept focuses attention on holding inventory in the location and quantity that is optimal for the entire supply chain. Clearly, exchanging information for inventory is central to the supply chain management concept.” (p. 3).

They emphasize that strategic partnerships and leadership in the supply chain is crucial:

“Successful supply chain management relies on forming strategic partnerships with trading partners along the supply chain, with one partner playing a key role in coordinating and overseeing the whole supply chain, similar to what is called a channel captain in the marketing literature.” (p. 3).

Before presenting the framework for risks and benefits of entering into supply chain relationships, some risks are discussed, e.g. financial risks when using third parties:

“The risks associated with shifts in the market and in technology can be mitigated to some extent by shifting functions outside the firm. Market entry risks can be reduced by utilizing third parties, focusing on shorter time horizons and smaller investments than required for vertical integration.” (p. 5),

and the economic risk of implementing dedicated IT systems:

“However, integrated information systems are costly and time-consuming to develop. If these costs can be shared by partners in a long-term relationship, the economic risk is reduced.” (p. 5).

The benefits of using third parties are clear:

“Third party benefits accrue from potentially more stable environments and longer term relationships with fewer shippers, thereby reducing the risks of open market uncertainty.” (p. 6).

The relationship between shipper and third party is analyzed and risk and benefits for both parties are outlined under the categories Economic, Managerial, & Strategic. But besides identifying potential sources of risk and reward, the authors do not offer insights into the management of these risks or procedures for the sharing of costs. In a later article Cooper & Ellram (1993) continue the discussion on SCM and the risks of entering into this type of relationships, e.g. on the breadth of the supplier base:

“Traditional systems often involve several suppliers of the same materials or services to increase competition and to obtain more favorable terms of sale. This approach also spreads the risk of shutdown if one supplier becomes suddenly unable to fulfill the contract or order. The supply chain management

approach suggests that the supplier base be reduced so that the firms can be more closely integrated. A reduced supplier base permits closer management and coordination of a few relationships.” (p. 17).

They claim sharing risks and rewards between partners is a prerequisite for SCM:

“...a close relationship requires that channel members be willing to share risks and rewards over the long term. This implies a win-win situation over the life of the supply chain. In traditional systems, channel members are relatively independent, with a short term approach that does not consider counterbalancing of risks and rewards over time.” (p. 17).

They argue that the planning of SCM should ensure a balanced or “fair” sharing of risks and rewards in the long run, and a willingness to “take a hit” in the short. But still there are no specific guidelines as how to perform the sharing, how to measure, or how to implement.

These shortcoming are not addressed in the article by Cooper & Gardner (1993), who continue the discussion on the contingencies for choosing one relationship form over another. Lambert, Emmelhainz & Gardner (1996) present an extensive framework covering a multiplicity of “partnership components” of which “Risk/reward sharing” is of particular interest. They more or less mimic Ellram & Cooper (1990) when they state:

“A partnership is a tailored business relationship based on mutual trust, openness, shared risk and shared rewards that yield a competitive advantage, resulting in business performance greater than would be achieved by the firms individually.” (p. 2).

Figure 4-4: Partnership Component Levels¹³

Partnership Component	Partnership type		
	Low	Medium	High
...			
RISK/REWARD SHARING			
Loss tolerance	• Very low tolerance for loss	• Some tolerance for short-term loss	• High tolerance for short-term loss
Gain commitment	• Limited willingness to help the other party gain	• Willingness to help the other party gain	• Desire to help the other party gain
Commitment to fairness	• Fairness is evaluated by transaction	• Fairness is tracked year to year	• Fairness is measured over life of relationship
...			

The article by Hammer (1990) does not contribute a lot to this discussions besides introducing two case studies (Mutual Benefit Life and Hewlett-Packard). Neither Andrews & Stalick (1994) nor Hewitt (1994) contributes significantly besides insisting design is multi-dimensional:

“A further output which has emerged from these discussions is a very clear consensus concerning the nature of the redesign process itself. This is that true process redesign is only likely to be successful if it is recognized as a multi-dimensional activity, simultaneously and explicitly addressing the work activity dimension, the information flow dimension and the decision/authority dimension.” (Hewitt, 1994, p. 5).

¹³ Source: Table 4 in Lambert, Emmelhainz, & Gardner (1996), p. 17.

The claim made in Cooper, Lambert, & Pagh (1997), that ‘Risk and Reward Structure’ is a well-documented component within the SCM domain is thereby challenged. It seems the articles only contain statements in favor of dividing the gains from the implementation of SCM, but do not offer principles or methods for identifying or managing this division.

4.5 Conclusion

The study on ‘Supply Chain Design’ reveals the state-of-the-art of Supply Chain Design contains contributions oriented both up- and down-stream as well as towards the network as a whole, aiming at designing processes and structures both. Analyzing the contributions for design objective reveals that most models are single objective models, thereby contradicting the discussion in Chapter 2. The objective best represented in ‘Cost’ (14 articles) whereas ‘Risk’ could only be identified in two articles. Another two articles aim at reducing uncertainty.

Comparing with the contributions from the theme ‘Supply Chain Design’ from Chapter 3 reveals a low degree of overlap. Combining the two sets of contributions results in a total of thirteen articles on Supply Chain Design referencing Uncertainty or Risk (see Figure 4-3). This set of contributions address Process and Structure both, and are oriented Internally, Upstream, Downstream as well as towards the Network.

The explicit reference to theory is quite limited – in the study on ‘Supply Chain Design’ only four of the identified articles reference theory (one using Chaos Theory, three using TCE; see Appendix F). As shown in Table 4-3 the theme on ‘Supply Chain Design’ from Chapter 3 adds one article using RBT (Lonsdale, 1999) and one on Agency Theory (Agrell, Lindroth, & Norrman, 2004). The (explicit) theoretical underpinning of the design models identified is thereby quite limited.

Lastly, the “classic articles” referenced in Cooper, Lambert, & Pagh (1997) (see Table 2-1) are investigated in order to identify other relevant contributions on Supply Chain Design, and furthermore to verify the claim for “Risk and Reward Structure”. The overlap is very limited, but at least the articles are classified consistently. The claim on “Risk and Reward Structure” seems to be exaggerated as only suggestions but no concrete models or principles for the fair division of cost advantages are proposed.

Chapter 5 Supply Chain Theories and Risk

The aim of this chapter is to answer the third research question:

Research Question 3: How do the theories most commonly applied within the SCM domain address the management of supply chain risks?

The first step is to identify theories often applied within the SCM domain.

Theories Often Applied Within the SCM Domain?

Acknowledging SCM is a multi-disciplinary domain (e.g. Giannakis, Croom, & Slack, 2004; Gripsrud, Jahre, & Persson, 2006) the list of theories applied within the domain is quite long. Identifying the (most) relevant theories can be performed by reviewing e.g. literature studies and contributions on conceptual frameworks on SCM.

In Giannakis & Croom (2004) the authors claim SCM has:

“... evolved ... through the incorporation of theoretical concepts and research in strategic management, industrial organization, industrial and production economics (transaction costs), inter-organizational relationships, knowledge management and systems theory.” (p. 29)

whereas Gripsrud, Jahre, & Persson (2006) claim systems theory is the dominant theory within business logistics – and transaction cost is the dominant theory within distribution research. In both Croom, Romano, & Giannakis (2000b) and Storey, Emberson, Godsell, & Harrison (2006) extensive lists of theoretical influences are presented¹. In Halldorson, Kotzab, Mikkola, & Skjøtt-Larsen (2004)² three perspectives on the management of supply chains is presented: Transaction Cost Economics and Principal/Agent Theory as the ‘economic perspective’, The Interaction Approach (IMP) as the ‘socio-economic perspective’, and The Resource Based View as the ‘strategic perspective’. Comparing this portfolio of theories to before mentioned contributions and other review articles (e.g. Burgess, Singh, & Koroglu, 2006; Giannakis, Croom, & Slack, 2004) shows a good ‘coverage’: 1. in their “structured literature review” Burgess, Singh, & Koroglu (2006) the four above mentioned frameworks account for 86% of the references, and 2. the previously mentioned literature review by Giannakis & Croom (2004) also supports the finding – even if they identify a wider range of theories³. Finally, the previous two chapters have documented the identified four frameworks as the most relevant in relation to the subject at hand.

¹ Also covered in Giannakis, Croom, & Slack (2004) (see Figure 2-3).

² This work is to a certain degree a continuation of Skjøtt-Larsen (1999).

³ The wider range of theories identified is not surprising as the population of journals investigated span a wider range as well. Excluding articles from e.g. Law, Knowledge Management etc. from the analysis results in a short list of theories and conceptual frameworks identical to the findings from previous chapters.

Answering the Research Question

To answer the research question the theories are described and evaluated one by one. Each description is followed by a brief analysis on how the theory relates to SCM, how relevant articles identified in previous chapters utilize the theory, and how the risks defined in the matrix are addressed.

The chapter closes off by analyzing the overall applicability of the theoretical frameworks in relation to the Supply Chain Risk Management (see Figure 5-1) for intentional and unintentional exits/disruptions both.

Figure 5-1: Supply Chain Risk Framework

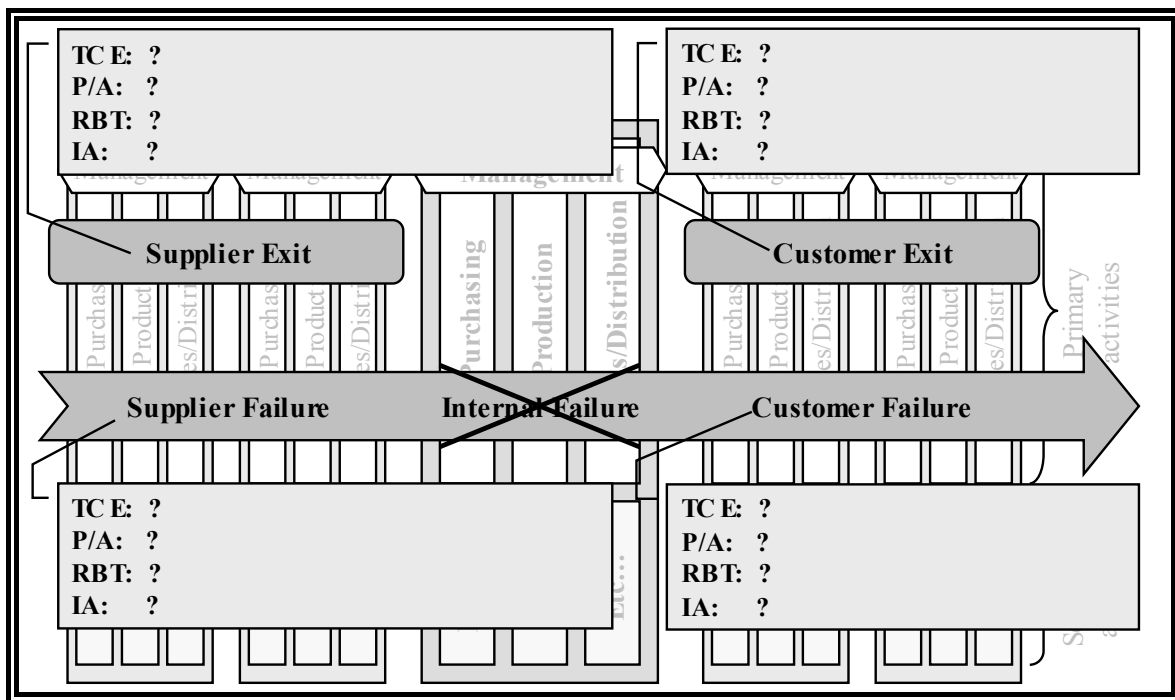

5.1 Transaction Cost Economics (TCE)

The original intention of TCE was to try to explain why firms exist when markets seem much more efficient (Coase, 1937). After being almost completely ignored for fifty years, the issue of industrial organization received renewed interest in the 1970's and 1980's which led to the introduction of a new body of theory and a fundamentally different way of perceiving a company (Coase, 1988). As stated in Williamson (2000)⁴:

“The need was to get beyond the analytically convenient (and sometimes adequate) conception of the firm-as-production function (which is a technological construction) to consider the firm as a governance structure (which is an organizational construction) in which internal structure has economic purpose and effect. More generally, the need was to identify and explicate the properties of alternative modes of governance – spot markets, incomplete contracts, firms, bureaus, etc. – which differ in discrete structural ways. Because each generic mode of governance possesses distinctive strengths and weaknesses, there is a place for each yet each needs to be kept in its place. The logic of discriminating alignment ... applies.” (p. 602).

The basic unit of analysis is the transaction, defined as:

“A transaction occurs when a good or service is transferred across a technologically separable interface.” (Williamson, 1985, p. 1)⁵,

which more than implies a departure from the neo-classical idea of the frictionless economic system. From the offset the propositions put forward by Williamson were at the same time contradicting the predominant perspective on economic activity and based on well defined assumptions:

*“As compared to other approaches to the study of economic organization, transaction cost economics (1) is more microanalytic, (2) is more self-conscious about its behavioral assumptions, (3) introduces and develops asset specificity, (4) relies more on comparative institutional analysis, (5) regards the business firm as a governance structure rather than a production function, and (6) place greater weight on the **ex post** institutions of contract, with special emphasis on private ordering (as compared to court ordering).” (Williamson, 1985, pp. 17-18).⁶*

The use of private ordering (as opposed to legal/court ordering) is a central assumption within TCE:

*“...transaction cost economics maintains that the governance of contractual relations is primarily affected through the institutions of private ordering rather than through legal centralism. Although the importance of **ex ante** incentive alignment is acknowledged, primary attention is focused on the **ex post** institutions of contract.” (Williamson, 1985, p. xii).*

⁴ The description of the transaction cost economics theory is almost exclusively based on the work of Oliver E. Williamson. It should be duly noted that other streams exist (see e.g. Coase, 1988), and that Williamson himself explicates the heritage of earlier economists and organization theorists, see later in this subchapter.

⁵ See also Arrow (1969), p. 48: “transaction costs are the costs of running the economic system.”. In Williamson (1981) the proposition that the transaction is the basic unit of analysis is accredited Commons (1934).

⁶ Previously Williamson (1983) included the use of hostages (to signal credible commitment) as well.

The study of economic organization insists that organization form matters⁷, and that:

“Transaction costs are economized by assigning transactions (which differ in their attributes) to governance structures (the adaptive capabilities and associated costs of which differ) in a discriminating way.” (p. 18).

Human actors are assumed to be bounded rational (“behavior intendedly rational, but only limitedly so”, Simon, 1947, p. xxiv) and opportunistic (defined as “self-interest seeking with guile”)⁸. Markets are assumed to experience failures, and companies are defined as being able to change their governance forms – to change from market to hierarchy or vice-versa based on the characteristics of the transactions they take part in. That the precise definition of assumptions is of critical importance for TCE is clearly stated in Williamson (1985):

*“Planning is necessarily incomplete (because of bounded rationality), promise predictably breaks down (because of opportunism), and the pairwise identity of the parties now matters (because of asset specificity). ... This is the world with which transaction economics is concerned. The organizational imperative that emerges in such circumstances is this: **Organize transactions so as to economize on bounded rationality while simultaneously safeguarding them against the hazards of opportunism.** Such a statement supports a different and larger conception of the economic problem than does the imperative ‘Maximize profits!’.” (p. 32).*

Transaction costs of *ex ante* and *ex post* types are usually distinguished. The first are the costs of drafting, negotiating, and safeguarding an agreement whereas

*“Ex post costs of contracting take several forms. These include (1) the maladaptation costs incurred when transactions drift out of alignment in relation to what Masahiko Aoki refers to as the ‘shift contract curve’, (2) the haggling costs incurred if bilateral efforts are made to correct ex post misalignments, (3) the setup and running costs associated with the governance structures (often not the courts) to which disputes are referred, and (4) the bonding costs of effecting secure commitments.” (p. 21).*⁹

Transaction costs are thereby complex cost structures. The difference between TCE and other related theoretical domains is quite clearly laid out in Williamson (1985) where contract law is used as the explanatory framework. Property rights and agency theory both assume hazards are known and efficiently managed *ex ante*, the future thereby holding no surprises. In contrast, TCE maintains that it is impossible to concentrate all bargaining *ex ante*, instead claiming that “*bargaining is pervasive*” (Williamson, 1985, p. 29).

⁷ For more on organization forms within TCE, please refer to Chapter 11 (“The Modern Corporation”) in Williamson (1985).

⁸ It is furthermore assumed that the parties to the transactions are risk neutral, see Williamson (1985), pp. 388-390.

⁹ Footnote 12 on page 21 of Williamson (1985) states: “The ex post transaction costs are related to, but plainly differ from, what Michael Jensen and William Meckling refer to as agency costs, which they define as the sum of ‘(1) the monitoring expenditures of the principal, (2) the bonding expenditures by the agent, and (3) the residual loss’ (1976, p. 308) – this last being a very expansive category.”

Governance Mechanisms and Structures

The early contributions (e.g. Williamson, 1975) contained only two forms of governance structure: hierarchy and market, but due to continued criticisms the typology was extended to reflect the various forms of cooperation, e.g. franchising, joint ventures, strategic alliances etc. (called “hybrid” forms)^{10, 11}. What remained, though, was the belief that the market form was preferable in terms of costs to other forms, under appropriate conditions. Complexity of organizational form is to be kept as simple as possible as complexity is expected to result in added cost.

The contingencies characterizing transactions are naturally a focal point within TCE:

“... the three critical dimensions for characterizing transactions are (1) uncertainty, (2) frequency with which transactions recur, and (3) the degree to which durable transaction-specific investments are incurred.” (Williamson, 1979, p. 239).¹²

The latter two are apparent in Figure 5-2 below.

Figure 5-2: Efficient Governance¹³

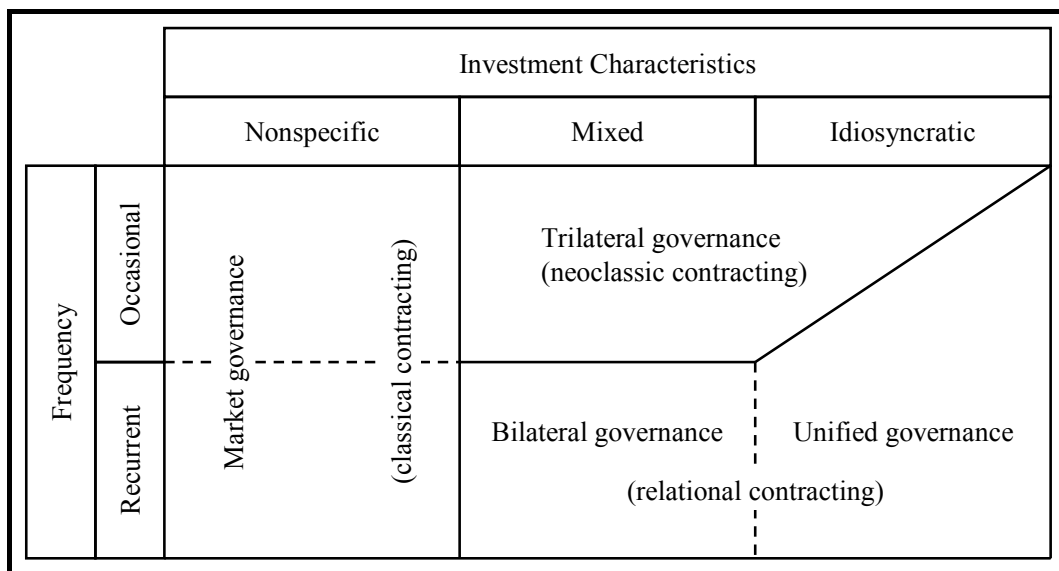

As the goal is to achieve efficient governance the various combinations of investments characteristics (non-specific, mixed, and idiosyncratic) and transaction frequency (one-time¹⁴,

¹⁰ As stated in Williamson (1985): “Whereas I was earlier of the view that transactions of the middle kind were very difficult to organize and hence were unstable ... I am now persuaded that transactions in the middle range are much more common.” (p. 83).

¹¹ As indicated in the first quote from Williamson (2000) the framework has been extended to include bureaus (government institutions) as well.

¹² In Williamson (1991b) a fourth contingency, ease of measurement, is added to the list.

¹³ Source: Figure 3-2 in Williamson (1985), p. 79. This is a modified version of Figure II in Williamson (1979), p. 253.

¹⁴ Early on in Williamson (1985) the frequency “one-time” is dropped as: “...the difference between one-time and occasional transactions is not apparent. Accordingly, only occasional and recurrent frequency distinctions will be maintained.” (p. 72).

occasional, and recurrent) has a corresponding governance mechanism facilitating the specific transactions.

The governance types referenced in the figure above are (naturally) precisely defined.

- Market governance (or classical contracting) applies for transactions where asset specificity is absent. No adaptations are necessary as transactions are standardized, alternative purchase and supply arrangements are (presumably) easy to work out. Even if the market governance is especially efficient when transactions are recurrent, market governance is also appropriate for occasional transactions.
- Bilateral governance (or obligational contracting) is one of the two types of governance structures under the heading “relational contracting”. Relational contracting applies for recurrent transactions only – and bilateral governance applies for transactions in the mixed investment class. Implying the absence of scale economies (which would result in standardization of the transaction thus leading to market governance), bilateral governance is preferable in situations where asset specificity exists but is not completely idiosyncratic. Assuming incomplete contracts one of the challenges inherent in this governance structure is the need for *ex post* adaptations which must take place across a market interface.
- Unified governance (or internal organization) efficiently deals with the problem of *ex post* adaptations as fiat is available under this governance structure. As transactions become more idiosyncratic the incentive for trading weakens, as there is parity between outside suppliers and the buyer on economies of scale. As no cost advantages are to be harvested, the decision point becomes the ease of adaptations.
- Trilateral governance (or neoclassic contracting) is the fourth and last governance structure. Covering the combination of occasional transactions of mixed or high degree of idiosyncrasy, these transactions pose a distinct challenge in terms of governance. Once entered into both principals have strong incentives to complete the transactions. Setup costs are assumed to be non-trivial, and due to the specificity the opportunity costs are most likely to be much lower in alternative use (or for alternative users). But even if both principals have an interest in seeing transactions to completion, the contract is assumed to be incomplete and therefore adaptations are expected. Instead of resorting immediately to litigation (with its transaction-disruptive features), third-party assistance (arbitration) is employed instead.

These governance mechanisms support the previously mentioned governance structures (market, hybrid, and hierarchy) which differ on at least the following attributes: instruments, adaptation, and contract law, see Table 5-1 below.

Table 5-1: Distinguishing Attributes of Market, Hybrid, and Hierarchy Governance Structures¹⁵

Attributes	Governance structure		
	Market	Hybrid	Hierarchy
Distinguishing Attributes of Market, Hybrid, and Hierarchy Governance Structures*			
Instruments			
Incentive intensity	++	+	0
Administrative controls	0	+	++
Performance attributes			
Adaptation (A)	++	+	0
Adaptation (C)	0	+	++
Contract law	++	+	0

* ++ = strong; + = semi-strong; 0 = weak.

Markets and hierarchies are each others opposites on every attribute whereas the hybrid form has all attributes defined as “semi-strong”. The incentives in the markets are perceived as strong, whereas administrative control is impossible. Conversely, hierarchies have strong administrative control but weak incentives.

Also on adaptation the governance structures differ: autonomous adaptation through quantity and price adjustment is the primary mechanism in the market, in the hierarchy adaptation is done through cooperation. Where the market assumes “faceless” transactions, the identity of the parties is very much known in the cooperative adaptation in the hierarchy. In the hybrid form, both types of adaptation are possible as negotiation over price/quantity has a meaning due to the semi-idiosyncratic nature of the transactions, and the cooperative approach is necessary to ensure stability in the semi-dependent exchange relationship.

Also the last attribute, contract law, differs across governance structure as Williamson contradicts the “nexus of contracts” school:

“Describing the firm as a ‘nexus of contracts’ ... suggests that the firm is no different from the market in contractual respects. ... That it has been instructive to view the firm as a nexus of contracts is evident in the numerous insights that this literature has generated. But to regard the corporation only as a nexus of contracts misses much of what is truly distinctive about this mode of governance. ... [B]ilateral adaptation effected through fiat is a distinguishing feature of the internal organization. ... The implicit contract law of internal organization is that of forbearance. Thus, whereas courts routinely grant standing to firms should there be disputes over price, the damages to be ascribed to delays, failures of quality, and the like, courts will refuse to hear disputes between one internal division and another over identical technical issues. Access to courts being denied, the parties must resolve their differences internally. Accordingly, hierarchy is its own court of ultimate appeal.” (Williamson, 1991a, p. 274).

Viewed through the lenses of incentives, adaptation, and contract law, it becomes clear how different these governance structures are – thereby supporting quite different transactions. As

¹⁵ Source: Table 1 in Williamson (1991a), p. 281.

mentioned previously transactions are characterized by asset specificity, frequency, and uncertainty - the former being the most important.

Asset Specificity

As indicated previously the concept of asset specificity is central to TCE:

“Transaction cost economics further maintains that the most critical dimension for describing transactions is the condition of asset specificity. Parties engaged in a trade that is supported by nontrivial investments in transaction-specific assets are effectively operating in a bilateral trading relation with one another. Harmonizing the contractual interface that joins the parties, thereby to effect adaptability and promote continuity, becomes the source of real value.”
(Williamson, 1985, p. 30).

The specificity of assets takes different forms¹⁶:

- Site specificity – determined by the degree of mobility of the asset.
- Physical asset specificity – stems from the specificity of physical attributes of the assets.
- Human asset specificity - refers to the distinctiveness of competence of the individual as gained through job training, “learning by doing” etc.¹⁷
- Dedicated assets – are assets, representing a discrete extension to the capacity of the firm, allocated to a specific buyer.
- Brand specificity – is described by the value of the brand (brand name capital).
- Temporal specificity – describes the timing of delivery requirements and the effects on product value.

Even if asset specificity intuitively seems easy to observe in business life, it is a quite recent addition to the economic dictionary. Prior to the work of Williamson, accounts of the phenomenon of asset specificity were considered unimportant and obscure. The introduction of the concept had severe ramifications for contracting as it contradicts the stability of the market as a governance structure:

“Transactions that are supported by investments made in durable, transaction-specific assets experience ‘lock in’ effects, on which account autonomous trading will commonly be supplanted by unified ownership (vertical integration).” (Williamson, 1985, p. 53).

The ‘lock in’ effect of the asset specificity and the creation of idiosyncrasies in exchange relations are described by the term ‘The Fundamental Transformation’.

The Fundamental Transformation

The ‘lock in’ effect is created through interaction, meaning that even if on the outset there are many qualified bidders, the winner of a contract acquires (transaction) cost advantage through e.g. learning (technical and managerial procedures, labor skills), acquisition of proprietary information etc. TCE does not contradict the *ex ante* situation (that there may exist many

¹⁶ This typology has evolved over time. In Williamson (1983) site, physical, and human asset specificity are referenced and dedicated assets are added to the list, and in Williamson (1991a) all six are listed.

¹⁷ This type of asset specificity was the interest of Marshall (1948) perhaps making it the “original” definition of the concept.

qualified bidders competing for the contract), but insists that this does not necessarily mean that many bidders will prevail *ex post*. Whether or not the ‘lock in’ effect will appear depends on the type of transactions taking place. In case the transactions are supported by transaction-specific assets, the initial winner will acquire an advantage over initial non-winners. If transactions are not supported by specific investments, no advantage is gained and no advantage over non-winners exists. The bidding parity will be upset and remain due to the continued self-enforcement (see e.g. Williamson, 1983).

The ‘lock-in’ effect is often symmetrical, in that the buyer can not turn to other sources of input as the cost of supply from unspecialized capital is presumably great. But even if the departure from the market form might be perceived as a risky endeavor, advantages for both parties can arise through the creation of trust:

“Additional transaction-specific savings can accrue at the interface between supplier and buyer as contracts are successively adapted to unfolding events and as periodic contract renewal agreements are reached. ... Both institutional and personal trust relations evolve. Thus the individuals who are responsible for adapting the interfaces have a personal as well as an organizational stake in what transpires. ... Other things being equal, idiosyncratic exchange relations that feature personal trust will survive greater stress and will display greater adaptability.” (Williamson, 1985, pp. 62-63).

The trust developing between parties thereby constitute a form of safeguarding.

Safeguarding

Safeguarding is thereby linked to asset specificity without which no safeguarding is necessary (since alternatives are easily found and trading relations are costlessly established).

Safeguarding can take various forms:

“The protective safeguards to which I refer normally take on one or more of three forms. The first is to realign incentives, which commonly involves some type of severance payment or penalty for premature termination. A second is to create and employ a specialized governance structure to which to refer and resolve disputes. The use of arbitration, rather than litigation in the courts, is thus characteristic of node C¹⁸ governance. A third is to introduce trading regularities that support and signal continuity intentions. Expanding a trading relation from unilateral to bilateral exchange – through the concerted use, for example, of reciprocity – thereby to effect an equilibration of trading hazards is an example of that last.” (Williamson, 1985, pp. 33-34).

In case of the absence of contractual hazard (ambiguity of common knowledge, weak property rights, undisclosed quality and safety hazards etc.) the appropriate governance structure is the market. Alternatively, if circumstances are more complex (e.g. less degree of transparency), the governance structure is determined by the existence of safeguards. If no safeguards are present the contractual hazards are unchecked, creating a fundamentally unstable constellation. Conversely, if safeguards exist they may take one of two distinct

¹⁸ Figure 5-3 below is a later version of the original schema; the correct reference is therefore nodes C and D.

forms: market safeguards and administrative safeguards. The latter is elsewhere named vertical integration; the former is sometimes called credible commitments.

The contingencies around safeguarding are depicted in Figure 5-3 below.

Figure 5-3: Simple Contracting Schema¹⁹

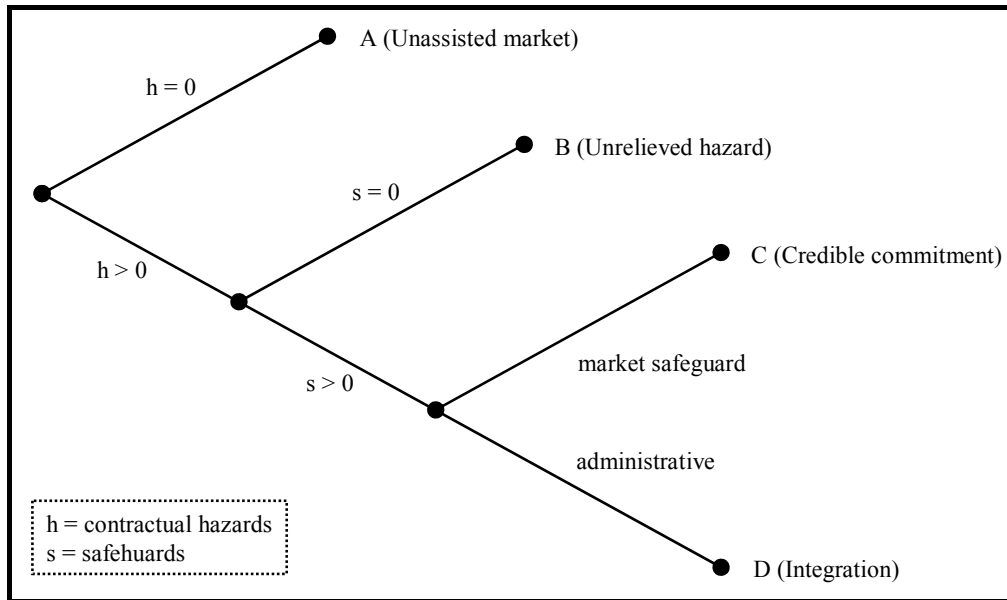

In one of the early contributions Williamson (1971) tried to explain vertical integration in TCE terms, emphasizing the differential incentive and control properties of firms in relation to markets:

“Perhaps the most distinctive advantage of the firm, however, is the wider variety and greater sensitivity of control instruments that are available for enforcing intrafirm in comparison with interfirm activities. Not only does the firm have the constitutional authority and low-cost access to the requisite data which permit it to perform more precise own-performance evaluations (of both contemporaneous and ex post variety) than can a buyer, but its reward and penalty instruments (which include selective use of employment, promotion, remuneration, and internal resource allocation processes) are more refined.” (pp. 113-114).

Alignment is attempted through modification of the organization form by means of contracts, which are considered inherently incomplete due to before mentioned bounded rationality and the complexity of the situation to be covered. As contracts are inherently incomplete the *ex ante* problem is determining to which level the contract should be defined, whereas the *ex post* problem is one of bargaining. The costs of using the judicial system are no longer ignored as private ordering is preferred over court ordering, and maladaptations are considered a natural consequence of the dynamics in economic institutions.

The other alternative, credible commitments (node C in Figure 5-3 above), consists of a number of mechanisms, e.g. various types of hostages, reciprocity in trade, and regulations.

¹⁹ Source: Figure 2 in Williamson (2000), p. 602.

Frequency

An increase in uncertainty will have no effect on the transactions performed in the market as continuity has little value and new trading relations easily can be arranged for both parties. But for transactions performed in the hybrid form, a low frequency will require the use of an arbitrator for conflict resolution. In case of high frequency, both participants will have enough experience and knowledge about the domain to perform the continuous negotiation and adaptation without the use of an arbitrator.

The use of an arbitrator spills over into transactions supported by idiosyncratic and highly idiosyncratic investments. The more idiosyncratic the investment supporting the transactions and the higher the frequency of the transaction the more pressure to implement unified governance. For the recurrent transactions the change will result in a shift from a bilateral trading relationship to vertical integration.

Uncertainty

The last of the contingencies, uncertainty, is also of critical importance in understanding TCE:

“The third dimension, uncertainty, is assumed to be present in sufficient degree to pose an adaptive, sequential decision problem. The occasion to make successive adaptations arises because of the impossibility (or costliness) of enumerating all possible contingencies and/or stipulating appropriate adaptations to them in advance. The effects on economic organization of increases in uncertainty above that threshold level have not, however, been considered.” (Williamson, 1985, p. 79).

For non-specific transactions the increase in uncertainty does not have an effect, but for transactions supported by specific assets uncertainty matters. Even if uncertainty is defined at two levels (1. as behavioral uncertainty stemming from bounded rationality, and 2. as uncertainty due to interaction effects), the link between transaction frequency and uncertainty is undefined, at least initially. The top two arrows in Figure 5-4 below (referring to the occasional transactions category) are therefore only suggestive. The shift from hybrid to market seems pretty straightforward, though, whereas the shift from hybrid to hierarchy may require extraordinary justifications.

For the recurrent transactions increases in uncertainty will make it more imperative to have governance structures with capacity to “work things out” in a cost-effective manner. Especially the transactions with mixed investment attributes pose an interesting problem. Unless the market can assist in governing the transaction it might “flee” towards the polar extremes as uncertainty increases. In case the transaction is critical to the company the shift to hierarchy seems most appropriate²⁰, otherwise the market might be more beneficial²¹.

²⁰ Elsewhere (Williamson, 1971) a similar argument is made on vertical integration as a response to moral hazard: “In consideration of the costs and limitations of input monitoring by outsiders, the buyer may choose to bear the risk and perform the work himself. The buyer thus internalizes, through backward vertical integration, a transaction which, but for uncertainty, would move through the market.” (p. 118).

²¹ As stated in Williamson (1991b): “If, therefore, there are not compensating gains (bilateral or multilateral adaptability advantages), integration is the source of cost without benefit. Firms that mindlessly integrate weaken themselves in relation to nonintegrated rivals. ... Vertical integration is the organization form not

Reductions in uncertainty will have the opposite consequences (e.g. Williamson, 1979, p. 254; Williamson, 1985, pp. 79-80).

Figure 5-4: The impact of uncertainty on governance structure

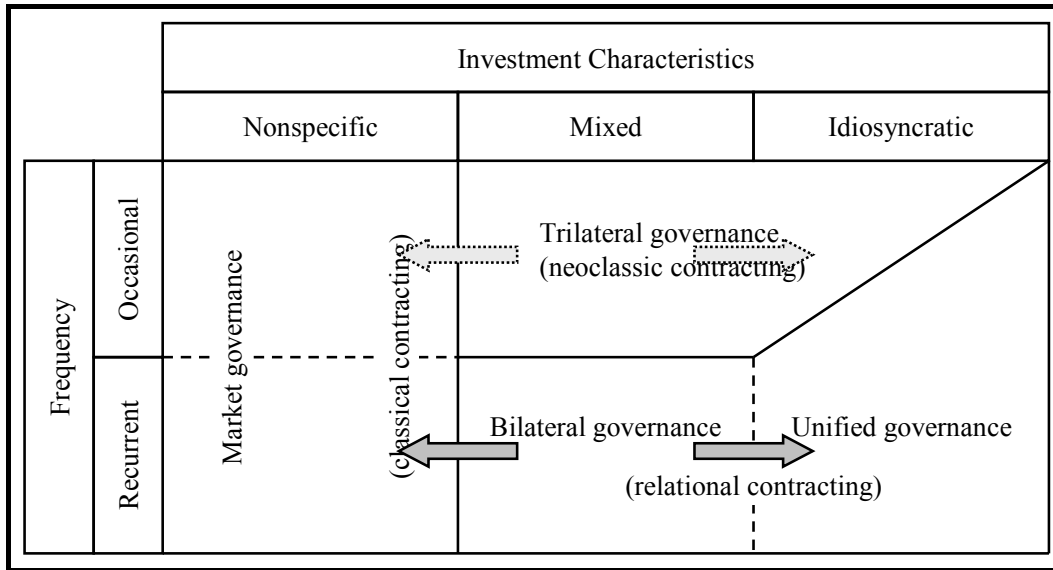

Frequency of Disturbances

The impact of uncertainty is further elaborated upon in a later contribution (Williamson, 1991a) where the frequency of disturbances and asset specificity is combined as depicted in Figure 5-5 below. Resembling the previous argument it is proposed that the increase of frequency or variability of disturbances will have an effect on the appropriateness of governance structures. Relying on negotiations the hybrid form is especially poor at adapting to series of disturbances. Both markets and the hierarchy in contrast are able to handle this situation, the former by switching away from disturbances, the latter by control and fiat.

The higher the frequency of disturbances the less appropriate is the hybrid form. As the frequency of transactions is absent in the figure (and in the text) it is assumed to refer to the category of recurrent transactions, as before. And as before it is not described what might trigger the shift from market to hierarchy or vice versa.

of first but of last resort – to be adopted when all else fails. Try markets, try long-term contracts and other hybrid modes, and revert to hierarchy only for compelling reasons.” (p. 83).

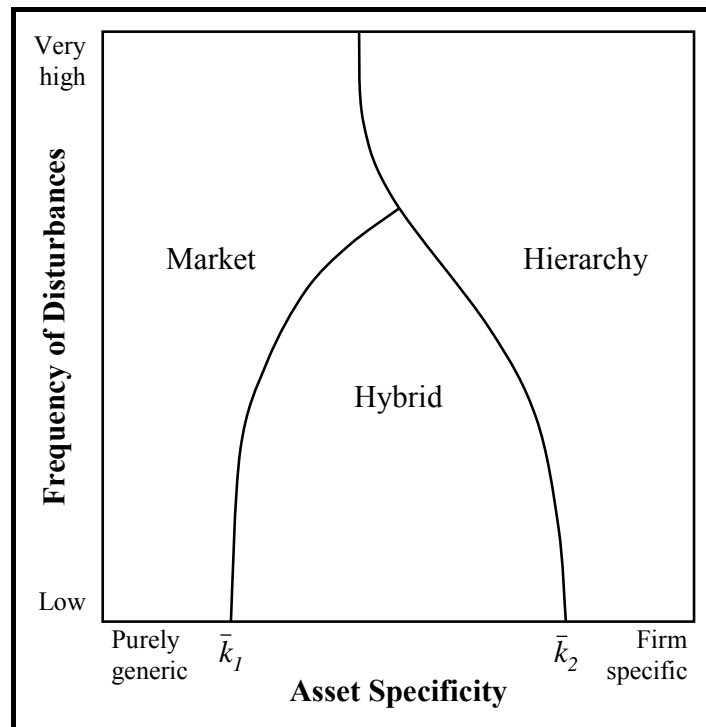
Figure 5-5: Organization form responses to changes in frequency²²

The Heritage of TCE

Albeit Williamson sometimes is referred to as synonymous with TCE a number of prominent researchers have made crucial contributions to the theory. Williamson himself acclaims a number of fellow researchers:

"The following propositions had thus been advanced and, in principle, could have been joined in a concerted study of economic organization as of 1940: (1) Opportunism is a subtle and pervasive condition of human nature with which the study of economic organization must be actively concerned (Knight); (2) the transaction is the basic unit of organizational analysis (Commons); (3) a central purpose of economic organization is to harmonize exchange relations (Commons; Barnard); (4) the study of contract, broadly conceived, is the legal counterpart to, and both stands to benefit from and can help to inform the study of economic organization (Llewellyn); and (5) the study of internal organization and market organization are not disjunct but are usefully joined within a common transaction cost economizing framework (Coase)." (Williamson, 1985, pp. 6-7).

The solid foundation on which TCE is based is no insurance against criticisms.

Criticisms...

As described above the evolution of TCE has been driven by critique. The current emphasis on the hybrid form of governance is a direct result of criticisms as is the number of asset specificity categories (see footnote 16 above). Other criticisms are somewhat less manageable as they attack the basic assumptions.

²² Source: Figure 3 in Williamson (1991a), p. 292. (Slightly modified: descriptions on axis added).

In Dyer (1997) the correlation between transactions costs and relation-specific investments is questioned. Dyer performs a comparative study of the American and Japanese automobile industries, and subsequently suggests differences across safe guards in terms of setup costs and transactions costs over time may explain why some Japanese companies obtaining both high asset specificity and low transactions costs. One of the major innovations in the article is the introduction of differentiated time horizons and the implications on cooperation (propositions 1 and 4). Furthermore the value of the interaction is of relevance, as the total volume of exchange will limit opportunism (proposition 2)²³. Quite reasonable propositions, contrary to the fifth proposition:

“Above some minimum threshold level of trust, additional relation-specific investments serve to increase commitment and the costs of unilateral defection, thereby resulting in lower transaction costs.” (Dyer, 1997, p. 550).

Even if the argument that inter-company trust will reduce the need for safeguards is quite reasonable it lacks a “counter argument”. Following the logic proposed to lower transaction costs it is only a matter of keep co-investing until companies share fates? This argument is clearly not valid as extensive co-investing will act as vertical integration thereby altering the governance structure from hybrid to hierarchy. Albeit a very interesting article at least part of the argumentation must be disregarded as the logic is simply invalid²⁴.

In Ghoshal & Moran (1996) both basic assumptions and normative implications of TCE are criticized²⁵. The major criticisms on assumptions include the definition of opportunism and the usage of social control in hierarchies. Ghoshal and Moran “unpack” opportunism and develop a model (called “The Cycle of Self-fulfilling Prophecy”), see Figure 5-6 below. They claim TCE is “bad for practice” as the expectation of opportunistic behavior restrains users of TCE (managers) to consider other modes of management (than fiat). They therefore propose decomposing opportunism into two components: the attitude and the behavior, and to include more factors: ‘prior conditioning’ (relationship) and ‘feeling for the entity’ (individuals’ assessment of the partner) to facilitate a development of the managerial aspect of the theory. The implication of the new model is a new insight into the relevance of social control, which in Williamson’s model consists of control through fiat only. In the new model, cooperation and adaptation is possible, widening the interpretation of efficiency gains. The authors’ major claim is that, through the widening of the model, TCE might be able to describe a larger

²³ The “cost of information” proposition is not new, though. The more costly information is the higher cost of controlling the exchange.

²⁴ Furthermore (and as stated in the article itself) one should be a bit wary when it comes to the empirical translations performed. The total transaction cost is translated into the cost of the purchasing department. This assumption may be valid for some of the companies analysed but has not been confirmed by all. It would suggest all companies are similarly structured – which is a somewhat bold statement.

²⁵ Also they reference a number of other critics: “TCE has been criticized for many things – for embodying a hidden ideology that distorts more than it illuminates (Perrow, 1986), for ad-hoc theorizing divorced from reality (Simon, 1991), for lacking generality because of ethnocentric bias (Dore, 1983), for ignoring the contextual grounding of human actions, and presenting an undersocialized view of human motivation and an oversocialized view of institutional control (Granovetter)...” (Ghoshal & Moran, 1996, pp. 14-15).

portion of empiric reality, through modifying the strict and limiting assumptions concerning human nature in (Williamson's version of) TCE.

Figure 5-6: Models of Opportunistic Behavior²⁶

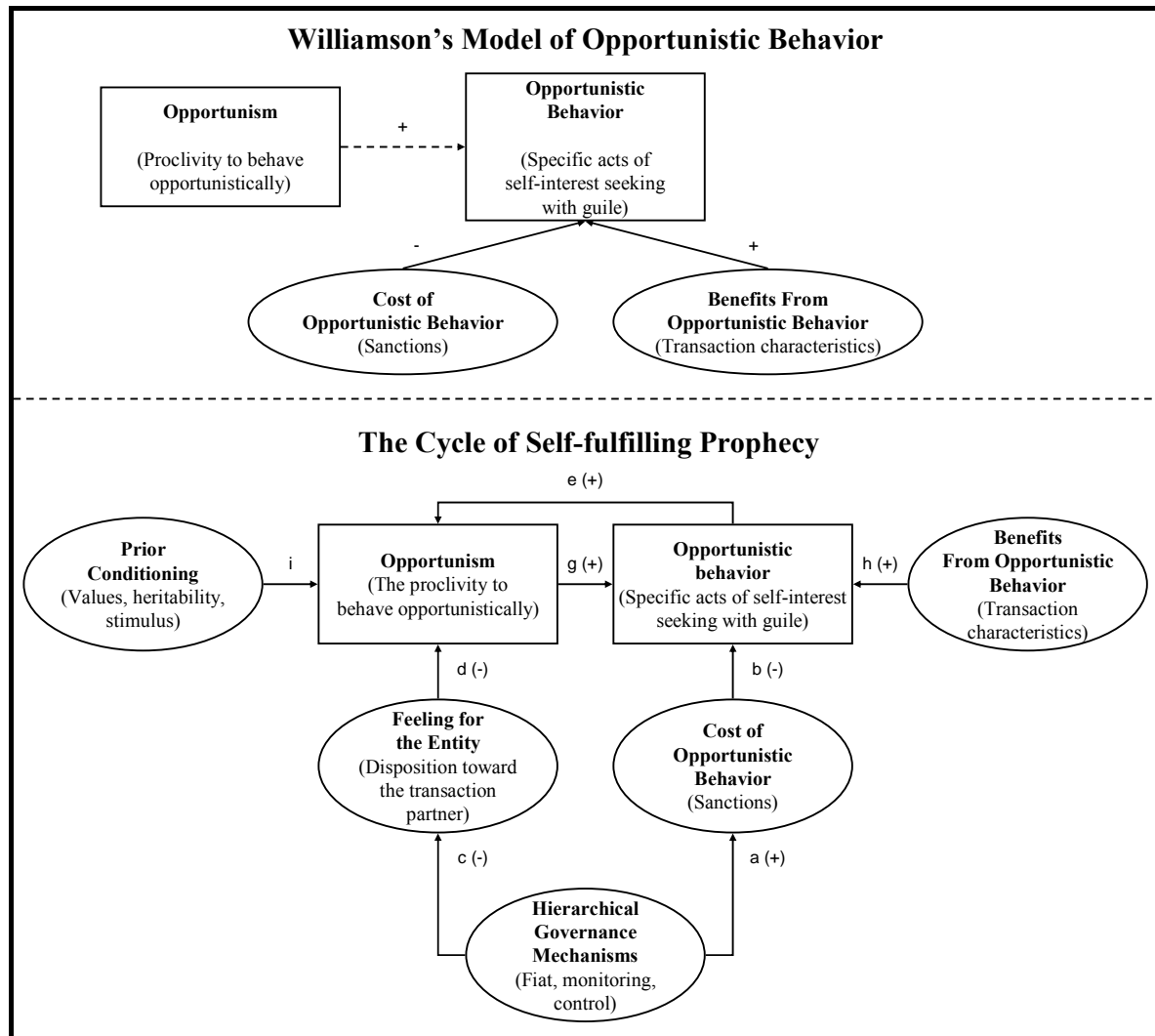

In Johanson & Mattson (1987) the authors compare IA and TCE in respect to the ability to describe and explain inter-organizational relations. Besides repeating some of the criticisms referenced above they reference another objection:

“... Williamson makes unrealistic assumptions about the differences between markets and hierarchies. Opportunism also exists within firms; organizations are not necessarily able to economize on bounded rationality; markets can also be characterized by asymmetrical power relations (controlled by ‘fiat’); etc.” (Johanson & Mattsson, 1987, pp. 42-43).

In other words, the social control proposed by Williamson might not only be counterproductive (as described by Ghoshal & Moran) but might be ineffective. Johanson & Mattson further point out a crucial shortcoming of transaction cost analysis in relation to industrial systems:

²⁶ Source: Figure 1 and 2 in Ghoshal & Moran (1996), p. 19 and 22, respectively.

“The transaction is a dyadic relationship, but the industrial system is made up of many such relations that are more or less interdependent. If we pick just one of those dyads and change the institutional form, e.g. through vertical integration, the other dyads may also be affected. The efficiency of the wider system may very well move in the opposite direction from the efficiency achieved in the original dyad that was changed.” (Johanson & Mattsson, 1987, p. 43).

Also in Noorderhaven (1995) the Interaction Approach is compared to TCE, here with emphasis on the shift between governance structures. In order to provide a “dynamic theory for hybrid governance” TCE is criticized for its static nature:

“Reduced to its essence, TCE is a two-period model: in the first period the relevant decisions with regard to investments and governance structure are made; in the second period the actual transactions follow. TCE is geared to the comparative static analysis of governance structures, and offers little in the way of a theory of gradual change from one governance structure to the other.” (Noorderhaven, 1995, p. 45).

Noorderhaven goes on to describe how the concept of safeguards is the most important difference between the two schools of thought, and describes how the longer time horizon in the Interaction Approach deems the use of safeguards irrelevant. The arguments are based on the “usual criticisms” concerning assumptions on human nature and rationality.

The last criticism to be dealt with here is also quite fundamental. Many critiques have addressed the notion of trust put forward by Williamson, especially in his early work. Even if the early work included the somewhat vague reference to “atmosphere” this was not further developed in subsequent work (Nooteboom, Berger, & Noorderhaven, 1997). Focusing on the protection of self-interest, Williamson insisted trust is irrelevant to the governance of relationships. But others disagree, e.g. Johanson and Mattsson (1987) who propose the perception of trust varies across theoretical frameworks due to different time horizon. After quoting social exchange theory, they comment:

“Single exchanges are ... integral parts of a process in which the parties gradually build up a mutual trust in each other. In supplier-customer relationships, business exchange is an important aspect of this social exchange process, and the gradual buildup is very familiar to businessmen.” (Johanson & Mattsson, 1987, p. 37)

They perceive the buildup of knowledge of exchange partners and the emergence of trust as preconditions to inclusion into industrial network. Williamson (1993) persists this use of the term trust is misleading, and explains his perception as a typology containing: 1. calculative trust, 2. institutional (hyphenated) trust, and 3. personal trust. Only the latter is perceived as real trust, but:

“Williamson posited that trust makes sense only if it goes beyond calculative self-interest. But since he maintained the centrality of calculativeness, there is no room in his view for trust.” (Nooteboom, Berger, & Noorderhaven, 1997, p. 310).

Between these two extremes: 1. trust as a precondition for (business) relationships and 2. trust as irrelevant due to self-interest-seeking Nooteboom, Berger, & Noorderhaven (1997) present an alternative view:

“Trust can only be considered an instrument of governance in a limited sense: it contributes to risk reduction, but it cannot be instituted instantaneously. If trust is not already present, it has to be built by developing bonds or shared norms and values. It can be more an outcome than a precondition of a relation, in which case it provides an improved basis for ongoing cooperation. Shared norms and values should, however, be a criterion for the selection of partners and in that sense can serve as an instrument.” (p. 318).

It seems obvious the notion of risk could be elaborated on, but here it should suffice to emphasize Williamson’s rejection of the notion of trust in relation to governance.

5.1.1 TCE and SCM

From the above description it is evident TCE is relevant to the domain of SCM. It seems appropriate to compare the governance structures (market, hybrid, and hierarchy) with the understanding of SCM put forward in Chapter 2. But before turning to the analysis of the three governance structures a few issues need to be addressed.

Dyads versus Networks

Already mentioned above TCE has the weakness in relation to SCM that it deals with dyads instead of (sub) networks. Comparative analyses of governance structures does not support multi-tier structures and therefore can not describe the causality of failures of 2nd tier suppliers on 1st tier supplier performance. First tier suppliers are liable for failures upstream as interactions in TCE are always only one tier deep. Another shortcoming in this context is the lack of support for the notion of interconnectedness²⁷ also severely damaging the applicability of the results of the before mentioned comparative analyses.

Frequency of Transactions versus SCM

As defined in Chapter 2 the focus of this dissertation is on manufacturing firms. SCM is perceived as primarily concerned with manufacturing and the fulfillment of customer requirements, thereby differentiating itself from the literature emphasizing NPD or/and Innovation as the primary reason for close relationships. The closeness of relationships is thereby justified by the need for stability in the supply chains, not by the need to innovate. As a consequence only the frequent transactions are of relevance. This does not mean, though, that companies being dependent on good relationships with e.g. equipment suppliers should pay less attention to these occasional trading partners. But it means this type of infrastructure decisions is considered outside the domain of SCM. A requirement for a relation to be

²⁷ In Ritter (2000) the concept of interconnectedness is introduced to describe how one relationship in a network might influence one or more other relationships. An example might be the relation between supplier A and the focal company C influencing the relationship between supplier B and focal company C – and perhaps even between suppliers A and B.

considered a SCM relationship is thereby transaction recurrence and open-endedness in time perspective.

Safeguarding versus Trust

These “long-term transactional relationships” are naturally somewhat different from the ideal in classical economics of the “one-off” transactions - not least in terms of trust. The insistence within TCE that (personal) trust is irrelevant contradicts empirical findings from the domain of inter-organizational relations which states trust decreases the needs for safeguarding (e.g. Inkpen & Currall, 2004). In Handfield & Bechtel (2002) it is concluded that trust may result from specific investments (in the form of site and human specific assets) leading to increased supply chain responsiveness. As responsiveness is a more fragile and high-risk configuration the fundamental claim might be that trust is a precondition for implementing high-risk (or rather: high impact) inter-organizational configurations?

This issue is further investigated in Suh & Kwon (2006) where a two-stage model of trust and specific asset investment is put forward. They conclude, quite surprisingly, that the duration of relationship does little in terms of explaining trust in a relationship:

“... our data has proven that the calculative-based trust theory has better explaining power than the knowledge-based trust theory proposing that trust develops over time as one accumulates trust-relevant knowledge through experience with the other person.” (Suh & Kwon, 2006, p. 198).

They emphasize the importance of calculative trust – and the importance of trust when developing supply chain initiatives like CPFR.

But the question is really whether trust should be seen as a precondition or a consequence of specific asset investments. In Inkpen & Currall (2004) the co-evolution of trust, control and learning in joint ventures is analyzed using a two-stage (initial versus evolved conditions) model. They conclude the three phenomena co-evolve, however:

“... because trust cannot be instantaneously created or destroyed, partner firms must balance the inevitable trade-off between trust and control.” (Inkpen & Currall, 2004, p. 596).

They claim trust may be a prerequisite for entering into joint ventures with a partner, but refrain from answering whether high levels of control or high levels of trust will maximize performance in the joint venture or not.

The shortcoming of TCE in relation to trust (if any such exist) might thereby be a question of time horizon or number of scenarios evaluated, not on the basic assumption of opportunism?

One-sidedness & Focus on Cost instead of Value

As pointed out in Zajac & Olsen (1993) TCE has limited relevance to the analysis of inter-organizational strategies for two reasons: 1. the theory is basically one-sided, and 2. the theory is limited to looking at (short term) costs instead of (long-term) value creation.

Altering the decision in TCE from uni-directional to bi-directional when evaluating the appropriateness of governance structure is naturally quite extreme as it contradicts the basic

assumption in the theory. But imagining the two companies negotiating the governance structure based on input from both sides is definitely more in the spirit of SCM. And extending TCE to consider the creation of value as well as costs would enable TCE to explain a larger part of reality²⁸.

Efficiency versus Capabilities Building

Furthermore, as stated in Barney (1999) TCE might have a shortcoming in certain settings where the development or purchase of certain capabilities is too costly. According to Barney TCE simply does not cover the “logic of acquisitions”:

“Thus, when the cost of using hierarchical governance to gain access to capabilities is high, a firm may prefer using non-hierarchical governance for this purpose, even if the threat of opportunism is real. Opportunism is simply part of the cost of gaining access to the special capabilities controlled by another company that cannot be developed internally or accessed through acquisition in a cost-effective way.” (Barney, 1999, p. 143)

In Barney this argument is used in a special setting (high tech industries) but the argument carries weight in other settings as well. The relative size of companies in supply chains gives the argument merit - and continued specialization and adaptations in the chain further emphasizes the problem.

These issues set aside the governance structure and the shifts between them can be evaluated²⁹.

Market Governance

Analyzing TCE for relevance in relation to SCM reveals the market governance structure more or less defines the boundaries of a company’s supply chains. In case transactions are performed in a market partners are “faceless” thereby negating the possibility of integration. The “rules of the game” are dictated by the market and options for e.g. speedy delivery will over time be uniformly accessible to all players. Since no relationship exists between players in such a market no common goals are identified and win-win does not make any sense. So, analyzing the exchange relationships of a firm will enable the mapping out of the (borders of) supply chains using the transaction types as an object for analysis (see e.g. Gardner & Cooper, 2003). The move out of market governance into the hybrid form is described in detail above under the heading “The Fundamental Transformation” but the shift from market to hierarchy is less so. Basically, the move from market to hierarchy conflicts with the overall premise of TCE as hierarchy is the most cost intensive of governance forms. The implied assumption is therefore that the move from market to hierarchy will not happen as hybrid forms such as

²⁸ The “value instead of cost” focus is supported by Dyer (1997).

²⁹ Above mentioned Noorderhaven (1995) analyzes shifts between governance structures, but since assumptions are modified and only the market and hybrid forms are included in the analysis, the contribution is ignored here.

joint ventures, strategic alliances etc. will have to be exhausted first. But, in case of an immediate need for better control, perhaps the shift could be justified. Especially under regimes of high uncertainty, the need for better control might justify the shift from market to hierarchy without first trying the various forms of hybrid governance. Since this situation implies a sudden shift in uncertainty and an immediate need for better control, probably the activities (transactions) are internalized, but not the organization. In other words: the responsibility for performing the transaction is internalized without the take-over of the supplier. The consequence from a SCM perspective of both governance shifts is that a subset of the suppliers previously located in 2nd tier (known or unknown) are now moved up to the 1st tier, resulting in the need to determine which suppliers to keep and which to discard. So, on the one hand the number of players in the extended network has decreased (intuitively resulting in decreasing complexity) the number of first tier suppliers have increased, resulting in increased complexity. And since uncertainty is dependent on the complexity of the network, the result of the described insourcing is ambiguous³⁰.

Hierarchy

In contrast to market governance, performing the transactions internally does not conflict with the concept of SCM. One might argue TCE can be used to analyze and describe the organization of transactions inside organizations but the concepts of market, hybrid, and hierarchy are not easily converted to describe functional versus process-oriented execution or management of activities. Especially the concept of market governance does not translate well, as it implies a high degree of redundancy within organizations including alternative departments to make bids for transactions. Such redundancy will have to be extremely costly. Hierarchical governance therefore does not imply that activities (transactions) are performed in a process oriented fashion, only that they are performed under the direct control (using fiat) of the organization. TCE does not seem to have any distinct contributions on process-oriented execution or management of transactions.

In considering the shift from hierarchy governance³¹ it is of critical importance whether or not a market for the transaction exists? In case the transaction can be performed under market governance TCE suggests doing so in order to minimize costs. In SCM terms this outsourcing can impact the company in two ways, depending on the closeness with suppliers to the activities being outsourced. In case inputs to the activities being outsourced were supplied by “close” suppliers, the consequence is that the supply chain is “broken” as the relationship to the former suppliers is terminated. In that sense, the move from a close relationship to an arms length³² (market based) relationship is “anti-SCM”, at least if analyzed

³⁰ In the (under these circumstances rare) case of vertical integration, internal uncertainty is further increased by the task of merging the two companies.

³¹ It is assumed that the transaction (activity or group of activities) in question is an integral part of the Fulfillment process. The logic for support activities is similar but of less importance as these activities are expected to be performed within the relevant departmental/functional domain.

³² The term arms length contrasts the close relationship in a manner similar to exit versus voice (see Hirschman, 1970). For a more recent contribution see Sako & Helper (1998).

in isolation³³. Complexity is reduced at the cost of integrative features, as no additional suppliers are introduced and only “type A”³⁴ adaptations are possible in the market. Alternatively, if inputs were obtained from a market, there are no changes to the integrative features and complexity is reduced at the cost of increased uncertainty.

In case no option for market governance exists, the transaction will be governed under the umbrella concept of hybrid forms. As described elsewhere this type of governance takes many forms ranging from franchising to joint ventures. The shift from hierarchy to hybrid is less dramatic than the move to the market form as the former two both rely on relational contracting, see Figure 5-2. In this shift complexity (and uncertainty) is expected to increase as an additional player in the supply chain is introduced and control over outcomes decreases. A further disadvantage of this governance structure is the immediate ‘lock-in’ effect resulting from the initial adaptations (especially of type C).

Hybrid

Comparing with the other two governance types the hybrid form is clearly the one most applicable to describe SCM from a TCE perspective. The varying governance types under the umbrella concept of hybrid describes the varying types of cooperative arrangements ascribed SCM, from joint ventures to strategic alliances or other cooperative constellations. TCE is clearly in line with the major part of the (normative) literature on SCM as it relies on the continued renegotiation and adaptation between supply chain partners. Referencing contract law on which TCE rests contracts are renegotiated on a continual basis, creating opportunities for change. In case circumstances have changed the “contract” might be altered, hopefully ensuring stability by creating symmetry in the inter-dependence.

Considering shifts from the hybrid form, uncertainty and frequency of disturbance must be referenced (as described above). In case uncertainty increases added costs incur as increased safeguarding is required to ensure stability. In case of frequent disturbances (even if each disturbance in itself is non-dramatic) the costs of dealing with the disturbances becomes a burden, leading to a shift in governance type. Asset specificity will determine in which direction the shift will be.

The shift towards hierarchy is also a foreseeable consequence of the before mentioned “Fundamental Transformation”. If the number of alternative suppliers have reduced to zero, thereby creating an uncomfortable dependency in the relation between supplier and buyer, strong incentive to insource the transaction occur. This is especially the case if the asymmetry of dependency can not be altered by use of e.g. credible commitments. Limits on the coordinative capacity of the corporation will, as mentioned above, determine the degree to

³³ It should be noted that the reduction of the supplier base often will be performed by a combination of re-design of products, re-specification of requirements, exclusion of redundant suppliers, and letting the more competent supplier act as systems suppliers. The impact on the portfolio of supply chains will therefore vary from case to case.

³⁴ “Type A” adaptations describe the autonomous adaptations in the market by means of price and quantity. “Type C” denotes the coordinative adaptations in hierarchies. As also described previously the hybrid forms enable both types, but not to the same extremes as in markets and hierarchies, respectively.

which the company can expand its activities and continue to insource transactions (see Coase, 1937).

The shift towards market will result from e.g. a deterioration of the assets' specificity, a phenomenon directly observable in the TPL industry in Denmark today³⁵. As most suppliers of TPL have now developed to a certain level of competence, the services are becoming standard, and price competition reoccur. In TCE terminology: suppliers of TPL services have not been good enough at creating unique solutions for their customers, thereby missing the opportunity of self-enforcing the dependency. As soon as this fact becomes apparent to the buyers of these services, the shift towards market governance is imminent.

Governance Structures and SCM

The elaborations above describe an analysis of the relevance of governance structures in relations to SCM. It was concluded that an additional characteristic, the recurrent nature of transactions, to be added to the working definition of SCM. Furthermore it was concluded that transactions performed under market governance defines the boundary of the supply chain. The relevance of governance structures in relation to SCM can thereby be illustrated as in Figure 5-7 below (colored cells denotes relevance).

Figure 5-7: SCM and the Governance Structures

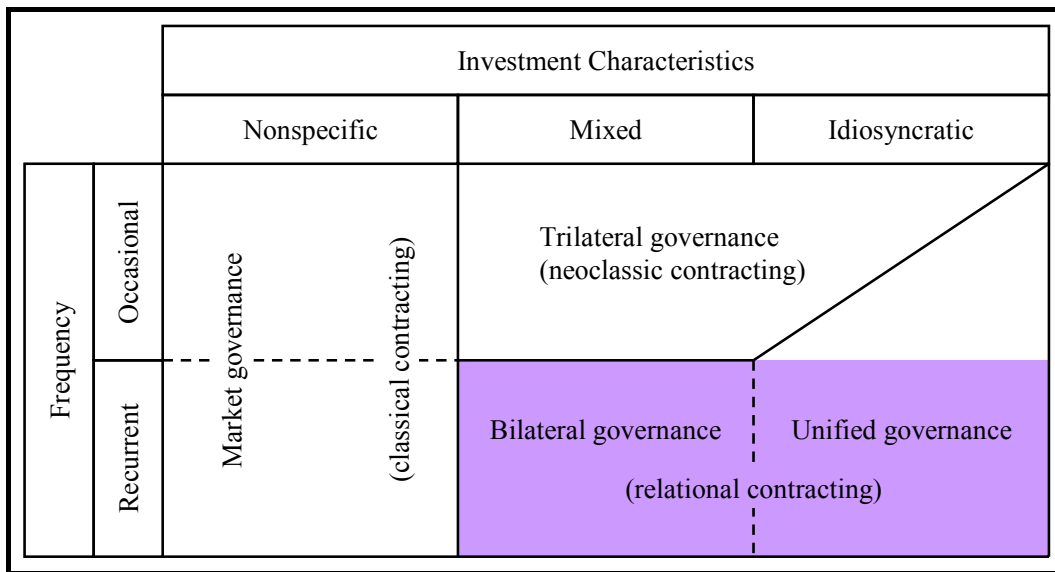

Shifts between Governance Structures

Furthermore the consequences of shifts between governance structures were analyzed to enable a discussion of the management of the defined risks. The results of this analysis are briefly summarized in Figure 5-8 below.

³⁵ As described by leading TPL operators during a seminar at KollleKolle, Denmark on May 26-27th 2005.

Figure 5-8: Shifts in Governance Structure

From	To	Market	Hybrid	Hierarchy
Market		N/A	“The Fundamental Transformation”	In sourcing of activities. In rare cases: vertical integration.
Hybrid		Response to deterioration of asset specificity and/or high uncertainty.	N/A	Response to unacceptable (asymmetric) dependency and/or high uncertainty
Hierarchy		Outsourcing, with loss of integrative features. No (initial) “lock-in”.	Outsourcing, with no loss of integrative features. Immediate “lock-in”.	N/A

Among the most important conclusions is the (somewhat trivial) conclusion that ‘lock-in’ and the presence of integrative features in exchange relationships are mutually exclusive when shifting from hierarchy to either market or hybrid governance.

5.1.2 Contributions Referencing TCE

The use of TCE spans from the most superficial to the very thorough and mind provoking.

In Hallikas et al. (2004) TCE is used to briefly explain the emergence of business networks. This explanation also borrows from RBT, but these explanations do not seem to be integrated into the proposed process for risk management in network environments. TCE is also used quite superficially in Christiaanse & Kumar (2000) when commenting on supply chain design:

“Design of a supply chain involves four design decisions. These decisions are the choice of actors in the supply chain, governance mechanism in the chain, structuring (i.e. sequencing order) of the activities in the chain, and the choice of coordination structures in the chain.” (p.271).

The authors use TCE to discuss governance under varying conditions, especially varying coordination costs versus degree of specialization and economies of scale.

In Walker (1988) the emphasis is on the strategic risks in association with outsourcing. For reasons of convenience the analysis and discussion focus on comparisons of market versus hierarchy albeit the other forms (joint ventures etc.) are acknowledged. In their article complexity is further increased by combining resource based (see Chapter 5.3) with transaction cost arguments. The TCE arguments to a certain degree suffer from the combination with the RBT arguments - it is apparent that the transaction costs are secondary to protecting the company’s assets. The article by Smeltzer & Siferd (1998) also reference another theoretical framework, Resource Dependency Theory. Unfortunately TCE is used in a somewhat limiting fashion, as the argument put forward is to minimize the number of transactions. As described in Chapter 3, the article is concerned with Proactive Supply Management, and the minimization of transaction costs is used to support the implementation of systems suppliers. Furthermore, Resource Dependency Theory is then subsequently used to illustrate the higher risk expected by reducing the supplier base (the article ends by

contradicting its own theoretical findings by referencing a survey performed). Also Logan (2000) uses more theories as TCE, RBT and P/A theory in combination is used to design successful outsourcing relationships in the transportation industry. Logan proposes to use the three theoretical frameworks in succession: 1. use RBV to evaluate the competencies of the provider, 2. to assess transactions costs in relation to specific investments, and 3. to evaluate agency costs and design contracts based on behaviors and outcomes desired. Albeit the article is quite interesting as the outsourcing process is broken down into three distinct decisions each theory is only very briefly reviewed and the theoretical underpinning is quite limited.

In McIvor (2000) the author claims to use TCE as the foundation for outsourcing decisions, but seems to work from an understanding of transaction cost that deviate from the one described above. McIvor describe the rationale for outsourcing as:

“... the company should outsource activities if to carry them out internally would require excessive investment to get the lowest unit price.” (p. 23).

This causes few problems, though, as TCE is not referenced in the model proposed. Quite contrary to the introduction in the article, the model relies heavily on RBT argumentation (more on this later in the chapter). In the follow-up article (McIvor, 2003) the same model is used and findings from research within the telecommunications industry is presented. McIvor describes “key issues motivating the company in the outsourcing process” and quite interestingly reports the following rationale for reduced risk exposure:

“Through outsourcing the company is reducing its level of risk. For example, by gradually outsourcing manufacturing processes it is reducing risk by converting its fixed costs into variable costs. In times of adverse business conditions suppliers will then have to deal with the problem of excess capacity. The company argues that suppliers are better able to cope with demand fluctuations through economies of scale and have more scope for alternative sources for this excess capacity.” (p. 390).

This is quite a statement as the outsourcing of manufacturing processes in the long run will leave the company “empty” – in the extreme case encompassing only brand ownership. Trading fixed costs for variable costs is by no way a panacea for risk mitigation as the focal company creates dependencies and removes itself from the upstream (supply) market.

In Bensaou & Anderson (1999) the arguments are more substantial. The authors:

“... try to better understand why buyers post ‘credible commitments’ in the first place and why such investments are made in some relations and not in others.” (p. 463)

In order to understand the creation of these dependencies, the authors establish eleven hypotheses, and then investigate by means of interviews and surveys. The hypotheses are based on a wide specter of theories: organization theory, industrial organization, institutional theory, and transaction cost economics. Albeit only some of the hypotheses are based on TCE³⁶ the use of the theory is quite detailed and thorough, and some of the non-TCE hypotheses might be quite interesting from a risk perspective (e.g. hypothesis H6: Thinness in

³⁶ See Table 1 in Bensaou & Anderson (1999), p. 465.

Market). So, even if this last contribution was well founded in TCE the general picture is a bit disappointing as TCE is used in a quite superficial fashion.

5.1.3 TCE and the Supply Chain Risks

From the descriptions and analyses above it should be evident that TCE addresses the issue of risk/uncertainty. Albeit the uncertainty aspect in the fundamental model is somewhat diffuse the distinction is made between general uncertainty, the direct effect (uncertainty concerning the outcome of the transactions), and the interaction effect (uncertainty resulting from hybrid or market governance):

”It is sometimes suggested that breach of contract risk affords an additional reason for integration: the small supplier of a critical component whose assets are insufficient to cover a total damage claim leaves the purchaser vulnerable. But this is an argument against small suppliers, not contracting generally; the large, diversified supplier might well have superior risk pooling capability to that of the integrated firm. The risks of contractual incompleteness, however, remain and may discourage purchasing from large, diversified organizations.”
(Williamson, 1971, footnote 4 on page 117).

The relevance of risks and the appropriate response varies with the governance structures, which was to be expected. As described in Figure 5-5 above, higher uncertainty will force transactions from the “SCM-type” governance structure, the hybrid form, into either the hierarchy or the market. Interestingly this introduces a conundrum as integration between exchange partners represents a form of safeguarding transactions supported by assets of medium specificity at the same time as the governance structure is badly suited for just this type of transactions under uncertainty. In case of the absence of uncertainty the transaction will (asset specificity set aside) be performed in the market, representing the lowest degree of uncertainty.

Management of the Supply Chain Risks

This evaluation leads to the following conclusions concerning TCE’s ability to manage the identified supply chain risks:

- **Process Risk:** the management of the process risks seems to be quite well documented as too high frequency of disturbances will lead to a shift in governance structure. Also the uncertainty concept has an impact on the choice of governance structure in case of high uncertainty. Albeit assuming opportunistic behavior the theoretical framework does not relate in any way to the cause of the disturbances, and therefore does not differentiate between intended and non-intended disturbances.
- **Structure Risk:** also the structural risk is, at least to a certain degree, dealt with in TCE. As described above unchecked dependency will lead to the internalization of activities. Or in TCE terms: in case of ‘small numbers bargaining’ and no ‘safeguards’ the governance structures ‘hierarchy’ or ‘market’ are preferential, depending on the degree of uncertainty and asset specificity. But, on the other hand the focus on minimizing the transaction costs will invalidate e.g. practices of dual sourcing as this solution will prove less efficient than the use of a single supplier. In case risk

management should be integrated into TCE at least a cost element holding the risk premium should be included in the portfolio of cost elements.

In conclusion, TCE is able to react to increased frequency in disruption, but is less able to handle the exit of critical suppliers or customers. Furthermore, the framework is not able to differentiate between intended and non-intended events.

The next theory to be investigated is principal-agent theory.

5.2 Principal-agent Theory (P/A)

The game theoretic origins of agency theory can, according to Eisenhardt (1989a), be traced back to the 1960's and early 1970's when economists explored risk sharing among individuals or groups. The core of agency problems is summarized in Fama & Jensen (1983a):

“Agency problems arise because contracts are not costlessly written and enforced. Agency costs include the costs of structuring, monitoring, and bonding a set of contracts among agents with conflicting interests, plus the residual loss incurred because the cost of full enforcements of contracts exceed the benefits.” (p. 327).

Arguing that activities can be performed under a variety of organizational forms and claiming there is competition among organizational forms for survival in any activity, they continue:

“Absent fiat, the form of organization that survives in an activity is the one that delivers the product demanded by customers at the lowest price while still covering costs.” (p. 327).

In Fama & Jensen (1983b) they continue:

“An organization is the nexus of contracts, written and unwritten, among owners of factors of production and customers. ... The central contracts in any organization specify (1) the nature of residual claims and (2) the allocation of the steps in the decision process among agents. These contracts distinguish organizations from each others and explain why specific organizational forms survive.” (p. 302).

An important construct, residual risk is described as:

“The residual risk – the risk of the difference between stochastic inflows of resources and promised payments to agents – is borne by those who contract for the rights to net cash flows. We call these agents the residual claimants or residual risk bearers.” (p. 302).

The continued existence of the company is dependent on making the right decisions:

“Organizational survival involves a balance of the costs of alternative decision systems and systems for allocating residual risk against the benefits.” (p. 307).

Fama & Jensen argue that the control of agency problems is important when decision makers initiating and implementing important decisions are not the major residual claimants. To effectively control the agency problems the four phases in decision making (initiation,

ratification, implementation, and monitoring) is proposed split into two terms: *decision management* (initiation & ratification) and *decision control* (implementation & monitoring) each performed by a separate group of individuals in the organization. The authors then investigate under which circumstances the three terms *residual risk bearing*, *decision management*, and *decision control* should be separated and when it should be performed by the same agent. These fundamental issues constituted a basis for the development of the theoretical framework.

Two Streams of Research and Theory

Agency theory is usually divided into two streams: “positive agency theory” and “principal-agent theory” (Eisenhardt, 1989a). The two streams share common unit of analysis (the contract) and assumptions, but where the former relies more on verbal expositions, the latter is more concerned with mathematical techniques. According to Eisenhardt (1989a):

“...positivist researchers have focused on identifying situations in which the principal and agent are likely to have conflicting goals and then describing the governance mechanisms that limit the agent’s self-serving behaviour.” (p. 59).

The principal-agent researchers are more concerned with a general theory of the agency relationship – and are interested in applying the formal theory to other areas after careful specification of assumptions. However, these two streams should not be perceived as conflicting, but as complementing each other:

“...positivist theory identifies various contract alternatives, and principal-agent theory indicates which contract is the most efficient under varying levels of output uncertainty, risk aversion, information asymmetry, and other variables...” (p. 60)

As the purpose of this subchapter is to create an understanding of the theory, the application oriented “positivist” stream is excluded from the following description and evaluation.

The Basic P/A Models

The basic model has two players, the principal who wants a task done, and an agent who can perform it. The theory is concerned with resolving two problems that occur in agency relationships: the *agency problem* and the *risk sharing problem*. The agency problem arises when there is goal conflict between principal and agent and it is difficult or expensive for the principal to verify the actions of the agent. The risk sharing problem arises when the principal and the agent have different attitudes toward risk. Due to this difference the principal and the agent may prefer different actions. The agency problem is further developed into the *moral hazard problem*, the *adverse selection problem* and the *signaling problem*³⁷:

- The moral hazard problem describes the situation where the principal is unable to verify the agents level of effort, and therefore will have to design a contract to induce the agent

³⁷ Other categorizations have been suggested, see e.g. Schuster (1990).

to select an appropriate (to the principal) level of effort (van Ackere, 1993). The contract type will depend on various parameters such as the risk attitudes of the principal and the agent.

- The adverse selection problem can be perceived as a special case of the moral hazard problem (van Ackere, 1993). The model now contains more agents, each with a different level of ability. In this model, rather than attempting to induce the appropriate level of effort from a specific agent, the principal tries to select an agent with the appropriate level of effort. The design of the contract will thereby aim at getting the right agent to accept the contract.
- Finally, a signaling problem occurs when an agent has private information he wants to convey to the principal.

Since the unit of analysis is the contract between the two parties, the objective of the theory is to identify the most efficient contract, or relationship, between the two parties, given a set of assumptions. The assumptions in the theory are about people (e.g. self-interest & bounded rationality), organizations (e.g. goal conflict among members), and information (e.g. information is a commodity). In its most basic form, the decision to be made is whether the contract is to be based on outcome (commissions, stock options, transfer of property rights, market governance) or behavior (salaries, hierarchical governance). The assumptions are shown in the table below.

Table 5-2: Comparison of assumptions (Agency vs. Organizational perspectives)³⁸

Assumption	Perspective				
	Political	Contingency	Organization Control	Transaction Cost	Agency
Self-interest	X			X	X
Goal conflict	X			X	X
Bounded rationality		X	X	X	X
Information asymmetry		X		X	X
Preeminence of efficiency		X	X	X	X
Risk aversion					X
Information as a commodity					X

Besides outlining the assumptions Eisenhardt (1989a) develops propositions from the literature reviewed. This introduces new variables to the model, e.g. length of relationship, measurability of outcome and task programmability (see Table 5-3 below). Depending on the specific agency problem variables are in- or excluded in the model and used as contingency variables or assumptions/preconditions.

³⁸ Source: Table 2 in Eisenhardt (1989a), p. 63.

Table 5-3: Variables in Agency Models³⁹

Variable	Value	Comment
Contract type (output from the models)	Outcome-based (commissions, stock options, transfer of property rights & market governance)	
	Behavior-based (salaries & hierarchical governance)	
Goal-conflict	Low	
	High	Assumption in the basic agency model
Information asymmetry	Yes	Assumption in the basic agency model
	No	
Relation length	Short	
	Long	
Risk attitude (agent)	Risk averse	Assumption in the basic agency model
	Risk neutral	
	Risk taker	
Risk attitude (principal)	Risk averse	
	Risk neutral	Assumption in the basic agency model
	Risk taker	
Task-programmability	Low	
	High	
Outcome-measurability	Low	
	High	
Outcome uncertainty	Low	
	High	

From this portfolio of variables a number of applications have emerged. According to van Ackere (1993) agency theory has been applied to e.g. accounting, industrial organization, and marketing. In Melnyk, Stewart, & Swink (2004) it is argued that agency theory has been used within OM to study as diverse subjects as decentralized cross-functional decision-making, group technology, international manufacturing, scheduling, and inventory management.

In this context the application to (design of) supply chains is the primary interest.

5.2.1 P/A Theory and SCM

Interestingly, agency theory can be applied internally as well as across company boundaries. In the sub-discipline managerial pay, for instance, the principals are the board of directors and the agent is the manager, but in e.g. adverse selection the agents may be internal as well as external entities. The theory may be used to decide whether to have certain activities performed within an organization or have them outsourced. Also the mode of cooperation can be analyzed or described as the contract type will determine (or assume) access to monitoring. The issue of internal and external integration thereby does not constitute a problem, at least not at an overall level of analysis.

Relating agency theory to SCM does raise some issues, though:

³⁹ Propositions from Eisenhardt (1989a). As described above the variables ‘Goal conflict’, ‘Information asymmetry’, ‘Risk attitude (agent)’, and ‘Risk attitude (principal)’ are assumptions in the basic agency problem model, with the values ‘High’, ‘Yes’, ‘Risk averse’, and ‘Risk neutral’, respectively. ‘Contract type’ is the output from the model

- First and foremost, it is not evident who the principals and the agents are. Intuitively, the first tier supplier is the agent as he is providing components to the final product. But the principal might also have agents located downstream, e.g. in the form of a TPL provider. So, the position in the chain does not in itself dictate the distribution of roles. Considering even more complex situations like mass customization one may imagine a principal-agent model containing multiple agents (own and external) and multiple principals (subsidiary and customer)⁴⁰. From this setup a large number of distinct model configurations can be created by modifying the degree of customization, the contact between the end-customer and the external parties, the stock keeping policies, type of postponement etc.
- Secondly, agency theory is dealing with dyadic relationships, and does not (in its original/basic form) deal with more levels of participants. In the adverse selection model a choice of one agent from a larger number must be made, in the managerial pay scenario multiple principals act as one decision maker. Even if Agrell et al. (2004) introduce a middle-man in their contribution, agency theory does not handle multi-tier models well. In this respect P/A theory resembles TCE.
- Thirdly, as pointed out by van Ackere (1993), the basic principal/agent model is single-period. A number of multi-period models exist but de-composing the models and solving them for optimality quickly becomes very difficult.
- A fourth complaint might be the absence of attention paid to the process orientation so often referred to as the most fundamental prerequisite for effective SCM. The theory does not relate to the concept of processes, but to tasks (or activities) alone. When it comes to the point of the “interface” (or relationship) between principal and agent, the theory uses the contract dichotomy: behavior-based or output-based contract. After each contract renegotiation for another is performed, supposedly describing the “interface” or relationship as shifting from absence to output-based contract to behavior-based contract (sequence of types not relevant).
- Lastly, relating to the dyadic nature of the models, the optimality criteria used is too simple for SCM. The SCM perspective focuses on win-win for the entire chain, whereas agency theory is focused on maximizing for the principal, and satisfying for the agent(s).

The theory might thereby not be able to design entire supply chains, but might give an indication on which type of relationship is optimal with each supplier and customer on a period-by-period basis. The idea of changing the contract from one period to the next does somehow conflict with the idea of integration and relationship-building often associated with SCM. The applicability of the model might improve dramatically in the context of SCM if the cost element is divided into a principal and an agent element, and a mechanism to adjust the distribution of cost is introduced as well.

⁴⁰ And this may be further complicated by including corporate as the principal of the subsidiary, having corporate acting as both agent and principal in the same model. As the focus here is on the example of a (series of) single transaction(s) this issue is not further elaborated on.

5.2.2 Contributions Referencing P/A Theory

Several contributions referencing P/A theory were identified.

As mentioned already the arguments put forward in Logan (2000) are somewhat superficial, albeit the model itself is quite interesting. In Agrell, Lindroth, & Norrman (2004) the authors investigate practice of coordination between players in the telecommunications industry by creating a three-tier P/A model. The parameters for the model are clearly and precisely described, but the extension of the model from a two-person to a three-person model somehow conflicts with (the traditional) P/A models. It remains unclear if the model can be further extended to include whole networks, and if the model then still would have theoretical support from P/A theory.

Table 5-4: Prior Research on Supply Risk⁴¹

PRIOR RESEARCH ON SUPPLY RISK		
Variable	Definition	Reference
Supply Risk Sources		
Inability to handle volume demand changes	Demand fluctuations in quantity and type for a component or service	...
Failures to make delivery requirements	Methods to distribute, handle, and transport inputs	...
Cannot provide competitive pricing	The ability to lower the price for the same good or service	...
Technologically behind competitors	The frequency of new ideas and emerging technology	...
Inability to meet quality requirements	The ability of suppliers to conform to specifications	...
Behavior-based Management		
Supplier certification	Identify suppliers' abilities to meet quality, cost, service, and delivery requirements	...
Implement quality management programs	Implementing programs to improve the abilities and activities of suppliers to satisfy the quality needs of the purchasing firm	...
Develop target costing with suppliers	Setting a planned selling price and subtracting the desired profit, marketing, and distributing costs, leaving the required manufacturing and procurement costs	...
Supplier development	Efforts of the purchasing organization to improve a supplier's performance and/or capabilities	...
Buffer-oriented Management		
Safety stock	Additional stock or items for products, supporting activities, and customer service held internally	...
Using multiple supply sources	Procurement of a good or service from more than one independent source	...
Requiring suppliers to hold inventory	Additional stock or items for products, supporting activities, and customer service held at the suppliers' firm	...

Zsidisin & Ellram (2003) use agency theory to describe the management of supply risk, and propose a dichotomy: Behavior-based Management and Buffer-oriented Management, see Table 5-4 above. The list of risk sources is quite interesting, as most of the risk sources have both a structural and a process risk component. The 'Inability to meet quality requirements' risk source, for example, can be perceived as a process risk as the variation in quality will create the necessity to perform quality assurance on receipt, and will thereby create fluctuations in the flow of input. The structural component is represented in the possibility that the chosen supplier should have been dropped. Similarly, 'Inability to handle volume

⁴¹ Source: Table 1 in Zsidisin & Ellram (2003), p. 17.

demand changes' and 'Failures to make delivery requirements' have both risk components, whereas 'Technologically behind competitors' and 'Cannot provide competitive pricing' are structural risk sources. The dichotomy for the management of these risks demonstrates the difficulty of merging the probability/impact construct with the behavior/buffer construct, and at the same time being true to the contract metaphor (outcome/behavior). Specifically, the third strategy in the Behavior-based Management class, the 'Develop target costing with suppliers' seems more like an outcome type strategy, but does obviously not fall in the 'Buffer-based Management' class. The strategies in the second class, on the other hand, do not fit well with outcome type contract, but rather as mitigation strategies for failing outcome based contracts.

In a later article Zsidisin et al. (2004) use P/A theory to classify supply risk assessment techniques. In the article the authors decompose the basic P/A models put forward in Eisenhardt (1989a) and use the individual variables to classify the techniques in play. Theory is not developed and suggestions are kept at the most overall level.

5.2.3 P/A Theory and Supply Chain Risks

It is imminent risk has a place within agency theory as risk attitudes of principal(s) and agent(s) are variables in the models. The risk component is quite limited though, as it focuses on the contract type proposed by the principal and the risk appetite of principal and agent(s) only. External risk sources are not available in the model albeit their existence is acknowledged (the result of an output based contract is not solely ascribed opportunistic behavior of the agent). Or in other words: uncertainty relating to the output of the activities is a basic assumption in the model, but external factors are not specified.

Management of the Supply Chain Risks

Accepting the dichotomy of output versus behavior based contracts, the ability to manage the supply chain risks can be described as follows:

- **Process Risk:** According to P/A theory a principal chooses to 'sell' the risk of deviations to the agent(s). The added cost could be perceived as an insurance premium relieving the principal of uncertainty for the contracted output over the specified period of time. The principal, based on the cost of obtaining access to the behavior of the agent, can decide if it is worth to monitor the agent. Managing the intentional disruptions of the contract is thereby directly addressed. Unfortunately the non-intentional is less so. From the agent's point of view the burden of uncertainty must be calculated in when accepting an output-based contract, for the principal the only difference between the two contract types is the timing of recognition of an exception. In case of a behavior-based contract the principal will monitor the agent's progress and will (immediately) observe the exception, whereas in the output-based contract the discrepancy between contracted and delivered output is not recognized until contract end. Obviously, the contract will contain clauses stipulating compensation for non-performance, but in many cases the claims can not cover the damages. Therefore, the

difference between the two contract types is the time period mentioned above, and the resulting safety stock needed to ensure stability downstream. The contract type will thereby describe the attitude towards the poorly performing supplier: the behavior-based contract signals inclusion and intent to solve the problem at the source, whereas the output-based contract signals exclusion.

- **Structure Risk:** The structure risks, on the other hand, are not really addressed as contracts are supposed to cover a certain period. Dropping out of a contract midway is not really a concern of the framework, albeit the concept ‘Moral Hazard’ is concerned with non-performance. The intentional exit from a contract might be handled by insisting on a behavior-based contract, but this would basically invalidate the theory, as all contracts with critical supply chain partners thereby would be behavior-based. For the same reasons as above the enforcement of contracts might have limited effects, besides increasing the cost of making a supplier switch.

In conclusion, the usability of P/A theory on the management of the supply chain risks is somewhat limited by a number of issues, both in relation to SCM in general and in terms of risk management. Especially the focusing on periodic renegotiation and the implied shifts between contract types from period to period conflicts with SCM.

Of the two risk categories, the process risks are best supported by P/A as moral hazard is addressed directly, and an option exists in relation to poor performers. The structural risks, on the other hand, do not really fit with the theory, especially not the non-intentional exit of a critical supplier.

The third theory in the analysis, Resource Based Theory, is somewhat different from TCE and P/A.

5.3 Resource Based Theory (RBT)⁴²

The birth of the Resource-Based Theory (RBT) is often attributed empirical problems with the dominant strategic perspective of the 1970’s, the SCP paradigm⁴³. Relying mostly on the external side of the SWOT model, the SCP paradigm was unable to explain the stability of the variation of performance of companies within the same industry (and having the same size). The collapse of the long range planning models paved the way for RBT, turning the focus from almost entirely externally oriented to the internal conditions of the firms as well. In

⁴² The description of Resource-Based Theory takes the articles in the reader by Foss (1997) as a starting point. In this text, the use of the term Resource-Based Theory will be used consistently, albeit some authors use the terms Resource-Based Perspective or View.

⁴³ SCP – Structure, Conduct, Performance. The SCP paradigm implies that the structural characteristics of an industry, particularly the level of concentration of firms and the height of entry barriers, have a significant influence on the ability of firms within an industry to price above the competitive price. Consequently, these structural characteristics can be expected to determine the performance potential of individual firms. Early contributions include Bain (1956) on entry barriers and Caves & Porter (1977) on mobility barriers. For a discussion of Efficiency versus SCP, see e.g. McWilliams & Smart (1993).

terms of the SWOT model, one might say that the SCP paradigm had focused too much on opportunities and threats, neglecting the strengths and weaknesses of the individual firm. With RBT the conception of firms as anonymous entities is discarded as firms are considered fundamentally different.

A Theory Emerging

Some disagreement exists over when RBT was born. Some (e.g. Foss, 1997) say the 1984 articles “A Resource-Based View of the Firm” (Wernerfelt, 1984) and “Towards a Strategic Theory of the Firm” (Rumelt, 1984) started the research stream today recognized as RBT. Others claim it was a few years earlier, in 1982, when the articles “Uncertain Imitability: An Analysis of Interfirm Differences Under Competition” (Lippman & Rumelt, 1982) and “Toward an economic theory of the multiproduct firm” (Teece, 1982) were published. No disagreement, on the other hand, exist on the importance of the seminal work of Edith Penrose (1959), who introduced the concept of the firm as

“...essentially a pool of resources the utilization of which is organized in an administrative framework.” (p. 149).

More or less ignored for a quarter of a century, her work quickly became the starting point for researchers within the emerging field of RBT. The concept of ‘distinctive competence’ put forward by Selznick (1957) also became a central component in the theory, which combined strategic management with economics in e.g. the concept sustainable competitive advantage (SCA). RBT’s conception of SCA is based on the before mentioned resources, or rather on a subset of resources. To achieve SCA the resource has to be rare and difficult to imitate and substitute. If so, the rent generated from the resource will be long-lived (sustainable).

From the basic resource-based approach, the theory development resulted in the development of e.g. the concepts core competencies (Prahalad & Hamel, 1990) and dynamic capabilities (Teece, Pisano, & Shuen, 1997). Terminology quickly became crowded with competing interpretations of terms like capabilities, assets, resources, and competences⁴⁴ and a precision of assumptions and a definition of terminology were needed.

A Common Frame of Reference

After briefly commenting on the multiplicity of research strands and the variation in terminology within RBT, Peteraf (1993) sets off to develop a general model and create a common ground for RBT researchers. She identifies four theoretical conditions for competitive advantage, of which all must be met. The conditions are:

1. Heterogeneity

The resource bundles and capabilities underlying production are assumed to be heterogeneous across firms. Firms with superior resources are able to produce at lower

⁴⁴ Examples are abundant, e.g. Aaker (1989) who deals with assets and skills instead of resources and capabilities.

cost and/or higher quality, and are thereby able to earn rent⁴⁵. Firms with marginal resources will make break-even, whereas firms with inferior resources will not be able to make break-even and will have to leave the market (or go bankrupt).

2. Ex Post Limits to Competition

Assuming the condition of heterogeneity is met, sustained competitive advantage is possible. If the heterogeneity is short-lived, the rents will disappear as competition will drive out the margin e.g. by increasing supply. Factors limiting the ex post competition are imperfect imitability and imperfect substitutability.

Substitutability being one of Porter's (1980) "five forces" is well described in the literature. Imitability, on the other hand, has received far more attention within the research stream. Isolating mechanisms include property rights, quasi-rents from lags and information asymmetries, producer learning, buyer switching and search costs, channel crowding and economies of scale, to name a few (Rumelt, 1984; Rumelt, 1987). In addition to these mechanisms, causal ambiguity (Lippman & Rumelt, 1982) prohibits competitors to imitate the resource. Causal ambiguity stems from the uncertainty regarding the causes of efficiency differences among firms. The condition of heterogeneity is preserved through the lack of knowledge of what to imitate, and the non-recoverable costs of the investigation.

3. Imperfect Mobility

Resources are perfectly immobile if they can not be traded. Examples include resources with ill-defined property rights, or resources which are idiosyncratic to the extent that they have no use outside the firm. Furthermore, resources that are firm specific, and thereby more valuable for the firm than outside is considered imperfect mobile. Co-specialized assets (Teece, 1986) and assets with high switching costs (Montgomery & Wernerfelt, 1988) are other examples of assets with limited mobility. Since the resources are bound to the firm for the use over a long period, they may be the source of sustainable advantage.

4. Ex Ante Limits to Competition

In addition to the previously described conditions, the condition of ex ante limits to competition must be met for a firm to have competitive advantage. By ex ante limits to competition it is meant that prior to establishing a resource position, the firm must assure the limitation of competition. If such a resource position is non-defendable, competition for the position will occur diminishing the rents to be earned. Completing the picture of the superiority of the resource position is the cost of the implementation.

In sum, these four conditions must be met in order for the firm to enjoy sustained above-normal rents.

⁴⁵ Rents can take two forms: Ricardian rents or monopoly rents. The former occur when resources are heterogeneous, whereas the latter is a product of deliberate restriction of output rather than an inherent scarcity of resource supply

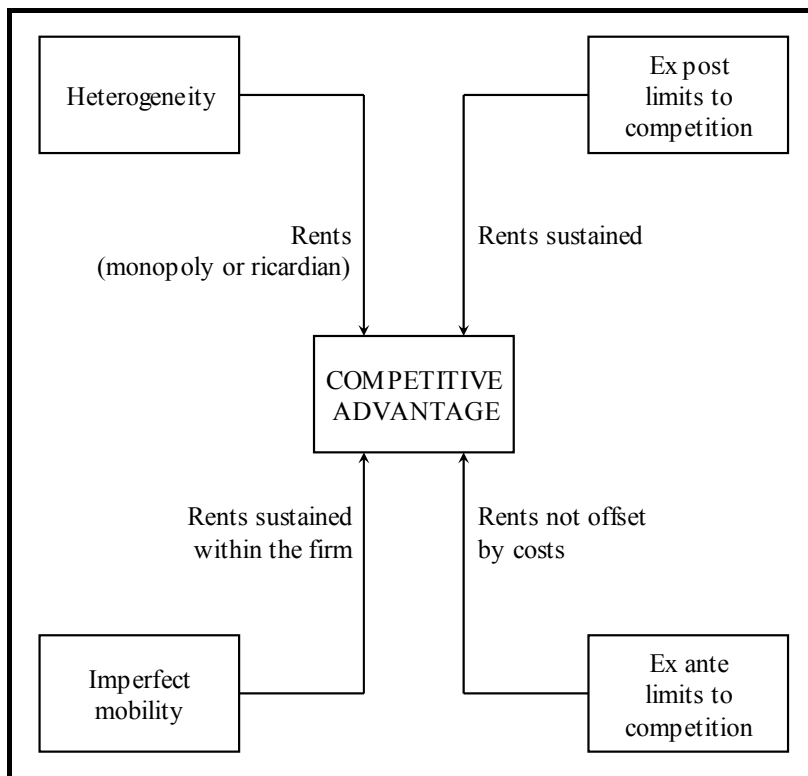
Figure 5-9: The cornerstone of competitive advantage⁴⁶

The creation of Ricardian or monopoly rents are ensured by resource heterogeneity, defended by the ex post limits to competition. The imperfect mobility of resources ensures that valuable factors remain with the firm, and that the rents are shared. Finally, ex ante limits to competition keep costs from offsetting the rents. Figure 5-9 above describes the above mentioned conditions and their impact on rents. This attempts to “clean up” or explain the ambiguity within RBT was not the only one.

Two Schools

According to Schulze (1994) the disagreement on the basic elements in the RBT framework goes deeper than definition. He claims two schools of thought within RBT can be identified, the fundamental difference between them being the type of rent emphasized. The first school, labeled the “Structural School”, emphasizes land and Ricardian rents and is commonly used in the strategy content literature. The other is called the “Process School”, it emphasizes quasi or efficiency rents and is common in the strategy process research (p. 129). He further claims that the schools have fundamental assumptions on RBT in common, see assumptions 1-3 in Table 5-5 below.

⁴⁶ Source: Figure 3 in Peteraf (1993), p. 186.

Table 5-5: Assumptions of the Two Schools of Resource-Based Theory⁴⁷**Common Assumptions**

1. Differences in resource endowments are causally related to differences in product and service attributes (Conner, 1991), and thus to differences in firm performance.
2. The resources needed to conceive, choose, and implement strategies are heterogeneously distributed across a set of competing firms (Barney, 1991, p. 105).
3. Firms are rent-seekers (Rumelt, 1987, p. 143).

The Structural Model adds the following as a general assumption

4. Sustained competitive advantage is feasible if the resources used to achieve that advantage are rare, imperfectly mobile and non-substitutable (Barney, 1991).

The Process Model adds the following as a general assumption

5. Efficiency rents are routinely available to the firm (Schoemaker, 1990).

Assumptions 1-4 underlay the structural model. Assumptions 1-5 underlay the process model.

Assumptions one, two and four fit perfectly with the preconditions for competitive advantage put forward by Peteraf, and referenced earlier in this text, whereas the third and fifth assumptions fit with Peteraf's initial assumptions. The explanation offered by Schulze is thereby an explanation of differentiation as a number of attributes differing across schools are identified, see Table 5-6 below.

Table 5-6: Attributes of the Two Resource-Based Models⁴⁸

	Process Model	Structural Model
Efficiency of Market System	Explicit	Semi-Strong
Analytical Condition	Dynamic	Equilibrium
Type of Rents	Inframarginal, Land, Efficiency and Ricardian	Ricardian and Land
Managerial Role	Create, Upgrade & Replace	Discover, Exploit & Protect
Probability that Managerial Action Has Positive Effects	Serendipity	Luck
Strategic Emphasis	Implementation	Formulation
Analytical Focus	Organizational Processes	Market Processes
	Aaker (1989)	Barney (1991)
Principal Authors	Schoemaker (1990)	Chatterjee (1990)
	Teece, Pisano & Shuen (1992)	Montgomery & Wernerfelt (1991)
	Grant (1991)	Wernerfelt (1984)

But even if these schools (or strands of research as stated in Peteraf (1993)) exist, there's another challenge in understanding RBT: to overcome terminological ambiguity⁴⁹

Ambiguous Terminology

Despite aiming at creating clarity Peteraf is herself contributing to the terminological ambiguity, or so it may seem. Not defining the terms, one gets the impression that capabilities are internal whereas resources may be internal or shared. Further one gets the impression that capabilities support or underlie the resources, and that the resources are

⁴⁷ Source: Table 1 in Schulze (1994), p. 137.

⁴⁸ Source: Table 2 in Schulze (1994), p. 137.

⁴⁹ Terminological disputes are often quite visible, see e.g. footnote 23 on page 516 of Teece, Pisano & Shuen (1997). Another example is the use of resources, capabilities, competencies, and assets in Amit & Schoemaker (1993).

created from capabilities. But, when referencing Prahalad & Hamel on the term “core competencies”, things get really confusing. She writes:

“Prahalad and Hamel (1990) describe how core competencies, particularly those which involve collective learning and are knowledge-based, are enhanced as they are applied. Such resources may provide both the basis and the direction for the growth of the firm.” (pp. 181-182, underlining added)

and further, commenting on Dierickx & Cool’s (1989) paper:

“... is a particularly important piece of work because it focuses precisely on those kinds of resources and capabilities which are of central concern to resource-based theory: nontradeable assets which develop and accumulate within the firm.” (p. 183, underlining added).

In the first instance core competencies are synonymous with resources, in the second assets are categorized as resources **and** capabilities? Obviously, the terminology on RBT in the article is less stringent than the parts on neoclassical concepts. It remains unclear how assets, capabilities and competences relate to each other, and what the characteristics of each class are.

A Hierarchy Proposed

In an earlier article, Grant (1991) develops a model for strategy formulation using RBT. The model in itself is quite straightforward, what is really interesting is the use of the RBT vocabulary and framework. To Grant, resources and capabilities provide the basic direction for the firm’s strategy and are the primary sources of profit (p. 116), but they are not identical (p. 118). A hierarchical structure is clearly introduced when resources are described as contributing to capabilities⁵⁰ leading to competitive advantage. His stance is clear:

“But, on their own, few resources are productive. Productive activity requires the cooperation and coordination of teams of resources. A capability is the capacity for a team of resources to perform some task or activity. While resources are the source of a firm’s capabilities, capabilities are the main source of its competitive advantage.” (p. 119).

To Grant, the capabilities are made up of a number of functional capabilities (p. 121), drawing on any number of resources, and explicitly equates these strategic capabilities with the “core competencies” put forward by Prahalad & Hamel (1990). But a capability need not utilize more than one resource (p. 123), thereby potentially limiting a capability to the activity performed in a single functional capability. So, the difference between simple and strategic capabilities may be in the complexity of the coordination and control mechanisms required. A case for perceiving capabilities as institutionalized routines is made, describing the functional relationship between resources and capabilities as one not pre-determined (p. 122). Whether the coordination and control of the use of resources are the capabilities of the firm remain unclear, as

⁵⁰ In Grant (1991) it is noted that in Snow & Hrebiniak (1980) capabilities are called “distinctive competencies”.

“... the organization’s style, values, traditions, and leadership are critical encouragements to the cooperation and commitment of its members. These can be viewed as intangible resources which are common ingredients of the whole range of a corporation’s organizational routines.” (p. 122).

Apparently ignoring the ambiguity in the definitions of the basic elements of the theory, Grant proposes a hierarchical approach to strategy analysis see below.

Figure 5-10: A Resource-Based Approach to Strategy Analysis: A Practical Framework⁵¹

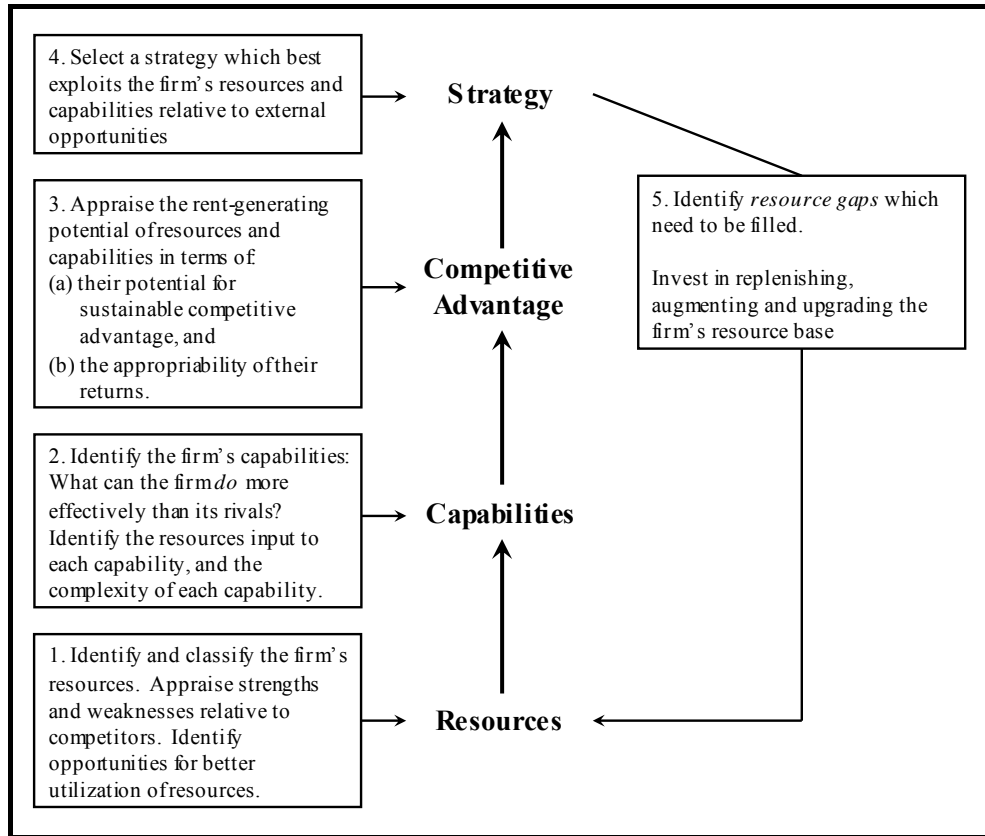

The link between these concepts is clearly one of cause and effect: with the right resources the company has a chance of developing the right capabilities, and from the right capabilities competitive advantage can be achieved. Agreeing with Peteraf (and others) Grant observes that sustainability of the competitive advantage is of critical importance, and like Peteraf he proposes four criteria: durability, transparency, transferability, and replicability. Analyzing the criteria reveal they are identical, albeit slightly differently described, to the criteria proposed by Peteraf⁵². So, even if the terminology is still not uniformly used, a level of agreement on the basics of the theoretical framework seems to have appeared.

Supporting the Hierarchy

The terminology used in Javidan (1998) is coherent with the terminology proposed in e.g. Grant (1991). Similar to Grant, Javidan proposes a model for strategy formulation and gives a

⁵¹ Source: Figure 1 in Grant (1991), p. 115.

⁵² It is worth noticing that Peteraf (1993) does not reference Grant (1991). Working separately and almost simultaneously they have come to the same conclusions.

hierarchy of the concepts within RBT. His emphasis is the multi-SBU, and in order to enable a discussion on the strategy formulation he explains the inter-relatedness of the concepts within RBT. As for other researchers within the field he recognizes the resources as the starting point and the basic object in RBT. He accepts the resource typology (physical, human, and organizational resources) put forward by Barney (1991), and introduces a further distinguishing characteristic: resource tangibility. Resources are heterogeneously distributed across companies, and the so is the ability to leverage them. To Javidan (and as depicted in Figure 5-10 above) the ability to leverage the resources is perceived as the capabilities of the company.

Figure 5-11: Competencies, capabilities and strategic hierarchy⁵³

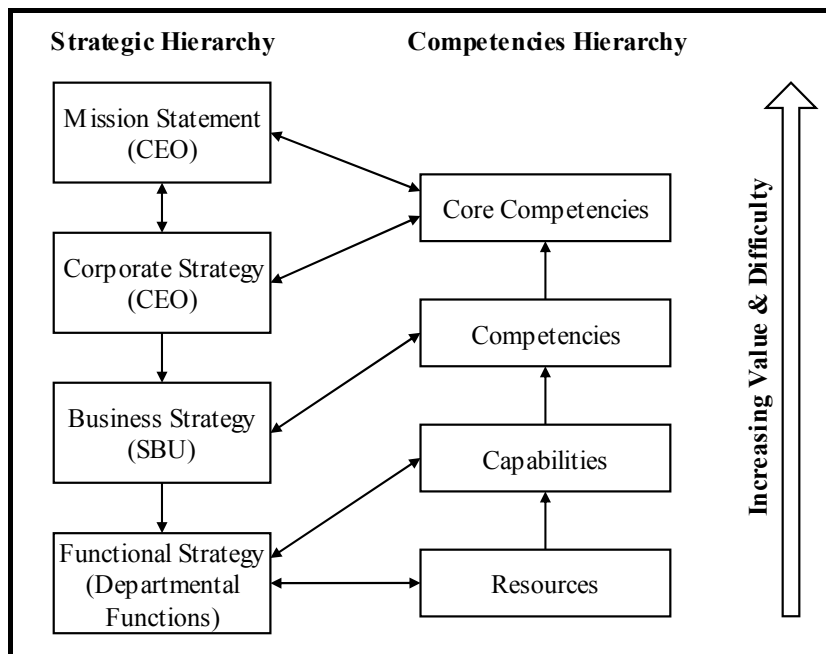

They are the second level in the hierarchy and consist of business processes and routines that manage the resources. A distinguishing feature of the capabilities is that they are functionally based, albeit resources are perceived as shared across the entire company. The third level in the hierarchy is the competency level, which is the coordination and integration across functional boundaries of capabilities. Competencies are considered local to each SBU, whereas the last level, the core competencies, describes interaction of competencies from the corporations multiple SBU's. As such, these definitions do not fit well with the European business world, as many European companies are not of comparable size to the American. The notion of SBU's and it's use as a defining characteristic of e.g. core competencies does not make much sense, as smaller (single SBU) type companies thereby would not have core competencies. Nonetheless, the hierarchy established is considered a useful contribution to the understanding of (the development of) competencies, and the linking of activities, through roles, departments, hierarchical level in the organization and the development of strategy.

⁵³ Source: Figure 2 in Javidan (1998), p. 63.

5.3.1 RBT and SCM

Albeit the theory is primarily oriented towards strategic positioning it does have merits within the SCM domain. Earlier in this manuscript it was described how RBT has been used to describe e.g. the emergence of business networks (Hallikas et al., 2004), motives for outsourcing (Walker, 1988; McIvor, 2000; McIvor, 2003), and a framework to evaluate competencies (Logan, 2000). The applicability of RBT to SCM does require some comments, though.

Pros and Cons

First and foremost the application of the theory must ensure unnecessary dependencies are not created. Williamson addresses this issue when comparing resource dependency and TCE:

“Transaction cost economics employs an efficiency perspective and treats dependency as a (broadly) foreseeable condition. In the degree, therefore, to which asset specificity (which is responsible for bilateral dependency) yields benefits (added revenues and/or production cost savings) that are not more than offset by the added governance costs, added asset specificity is deliberately incurred. Accordingly, farsighted parties purposefully create bilateral dependency and support it with contractual safeguards, but only in the degree to which the associated investments are cost-effective. Because price, asset specificity, and contractual safeguards are all determined simultaneously, calculativeness is the solution to what would otherwise be a problem (unwanted resource dependency).” (Williamson, 1993, p. 461).

This is obviously a consideration for the user of the theory, not the theory itself, albeit it is quite problematic (from an empirical point of view) that this issue is not clearly addressed.

Secondly, the inter-organizational character of resources, as perceived by Peteraf, directly addresses the reality of SCM. The closer integration of businesses in a supply chain is reflected in the co-development of products and processes, and co-dependency. The implementation of mass customization for example, might result in the change of the demand for inputs, thereby shifting the responsibility of designing more generic modules to the suppliers. In many cases, these changes are so dramatic that on the one hand the payoff is intriguing, but on the other they are out of the economic reach of the supplier. Co-developing and strategic partnerships of various kinds are in some instances the cure of this paradox, integrating the supplier closely with the customer.

Lastly, albeit the contributions on outsourcing (or rather: the re-distribution of activities across the supply chain) is of relevance to the domain of SCM there is a problem of measurability. The lack of objective criteria from which to evaluate the value or potential of the resources and capabilities leaves the companies to evaluate their own uniqueness and contribution to their environment. It should come as no surprise if uniqueness is identified and contributions are considered non-trivial. Another shortcoming is the “corporate view” of the company, focusing on core activities and competencies supporting the “mission” of the

company. In a SCM perspective the concept of ‘supply chain’ might improve the understanding of the link between activity and achievement of corporate goals⁵⁴.

Improvements Suggested (for SCM Usage)

Redefining RBT to improve the applicability in a SCM context will therefore have to emphasize the inter-organizational aspects of resources and competencies.

First and foremost the framework must better address non-divisionalized companies. As mentioned earlier, the typology presented by Javidan (1998) is of limited use as it stringently addresses the hierarchies (strategy and competency) from a multi-SBU perspective. This organizational structure is not “natural” to many European companies, which do not have the size of American ditto. Redefining his framework could thereby discard the “Business Strategy (SBU)” step in the strategy hierarchy, and let the competencies relate to corporate strategy, and core competencies to the mission statement. The link from resources to capabilities to competencies to core competencies is thereby intact, but the references to the strategy hierarchy are altered. Altering the reference from corporate strategy to competence instead of core competence, it is emphasized that core competencies relate to the long-term strategic survival of the company.

Figure 5-12: An Inter-organizational RBT Model

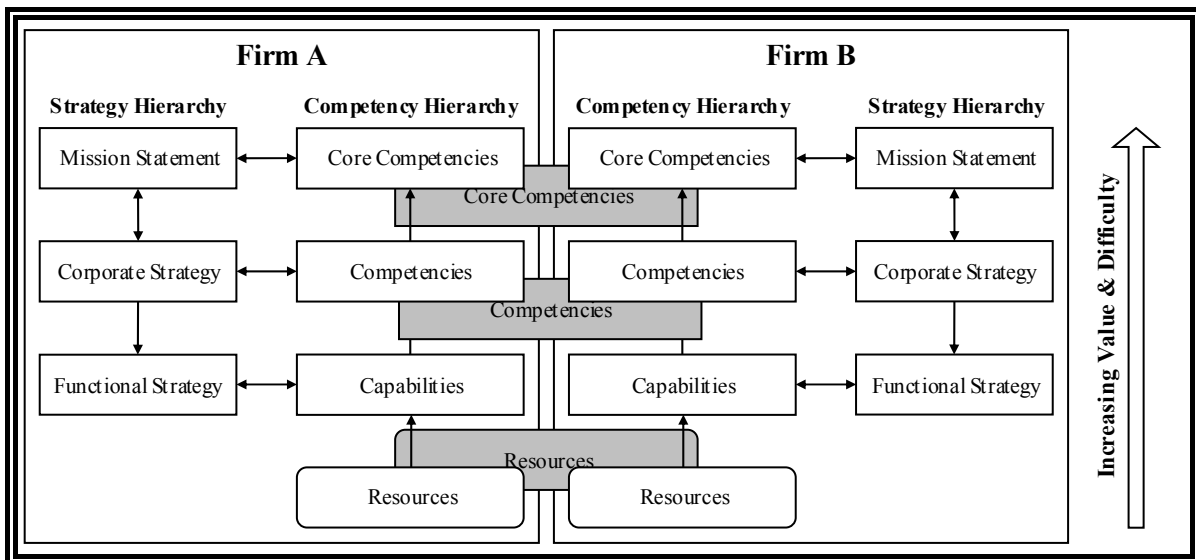

Furthermore the realization that core competencies and resources are not necessarily under the control of any one company, introducing dual ownership or co-development and co-operation must be introduced to the framework as well. These resources might span from the network level (e.g. access to superior supply chain partners due to inclusion in a certain network) to the idiosyncratic (exclusive access to the resources of a close supply chain partner). Core competencies might in a similar fashion be created and sustained through cooperation, and the creation of rare, un-imitatable, and sustainable core competences may be out of the scope of

⁵⁴ This links back to the conceptual discussion on multiple supply chains introduced in Chapter 2.

the individual company (as described above). A graphical representation of this alternative model is presented in Figure 5-12 above.

Lastly the previously mentioned concept Dynamic Capabilities (see e.g. Teece, Pisano, & Shuen, 1997; Eisenhardt & Martin, 2000) might enrich the domain of Supply Chain Design as the sustainability of competitive advantage is discarded, and continuous adaptation is needed in order to stay competitive.

5.3.2 Contributions Referencing RBT

As mentioned above contributions referencing RBT cover quite some ground. Also here the application of the theory describes quite some variation.

In Walker (1988) the primary aim is to protect the company's strategic assets by choosing the optimal sourcing arrangement. In contrast, Logan (2000) uses RBT only to evaluate the competencies of potential transportation partners. Hallikas et al. (2004) briefly mention RBT in combination with TCE when describing the emergence of business networks. The use of RBT is quite limited, though, as only the competency concept is mentioned, whereas no reference to e.g. resources or capabilities supports the arguments.

Demonstrating a deep understanding of RBT Lonsdale (Lonsdale, 1999) develops a "risk management model for outsourcing" (see Figure 3-5). As already described in Chapter 3 Lonsdale addresses dependencies stemming from three sources: outsourcing into a limited supply market, poor internal alignment, and contractual incompetence in the face of different degrees of asset specificity. Albeit the model might easily be extended to include other sources of dependency (e.g. a dependency stemming from width or volume) the contribution demonstrates a consistent use of the RBT framework.

5.3.3 RBT and Supply Chain Risks

When evaluating RBT for ability to manage the supply chain risks, several conclusions quickly emerge. First and foremost, the theoretical framework will have to be applied against a portfolio of supply chains instead of the company as a whole (as mentioned above). Depending on the type of company this change will have varying degrees of difficulty. Analyzing a divisionalized company with units each having one (or few) supply chain(s) will possibly prove less complex than the multi supply chain (but not divisionalized) company. The overlapping of activities might intuitively lead to the "wrong" conclusion that these core activities support a (the?) core competency, when the opposite might be the case: that these activities "taking centre stage" actually restricts the company from developing (new) core competencies. Furthermore it becomes apparent that the theory is not at all oriented towards operational issues. The time perspective is long-term, and the aim is strategic positioning. The framework has an inherent measurement problem as the evaluation of future scenarios will have to be strictly internal (for competitive reasons). Lastly, if risk is addressed at all, it is the somewhat abstract "risk of losing or not developing sustainable competitive advantage". This does in no way support the analysis of types and levels of integration with

critical supply chain partners, as core competencies are almost exclusively perceived as internal to the company.

Management of Supply Chain Risks

Therefore, the following conclusions on the ability to manage the supply chain risks are drawn:

- **Process Risk:** The theory does not enable the management of the process risks, as operational issues are not within focus.
- **Structure Risk:** The structure risks are not addressed except for before mentioned “risk of loosing or not developing sustainable competitive advantage”. In case the considerations put forward by Williamson (1993) as described above was “implemented” the risk of loosing a critical partner would be reduced as the degree of dependency towards external partners would be less.

In conclusion, in order to manage supply chain risks RBT does not really have a contribution.

The last framework to analyze is the Interaction Approach.

5.4 The Interaction Approach (IA)⁵⁵

The Interaction Approach is synonymous with the network perspective developed by the IMP Group (or the Uppsala School), a group of researchers formed in the 1970's. Initiated by researchers from Uppsala, Sweden the group contained members from the universities of Uppsala, Bath, UMIST, ESC Lyon, and Munich. The group developed a dynamic model of buyer-supplier relationships in industrial markets (the Interaction Model) and illustrated its applicability through comparative studies of buyer-supplier relationships within and across a number of European countries (France, Germany, Italy, Sweden, and UK). The second IMP study had more or less the same focus, but moved to investigate the individual relationship in the context of the other relationships a firm may have (Easton, 1992). The main conclusions from these pan-European studies was that buying and selling in industrial markets should not be viewed as a series of independent transactions, but rather as a number of episodes in often long-standing and complex relationships between the buying and selling organizations.

Interaction

A fundamental claim by the IMP Group is that the process of dealing with other companies is not a process of action and reaction - it is one of interaction (Ford, 2000). Relationships are not made up of active sellers and passive buyers, but of active buyers and sellers of which both may initiate interaction. Companies are no longer perceived as distinct legal entities

⁵⁵ The description of the perspective is primarily based on the contribution from the reader on the IMP Group: ”Understanding Business Markets”, Ford (2000). As the articles have not been modified for the reader, references are made to the original publication, where possible.

but as sets of interrelated interactions embedded in networks (Ford, Håkansson, & Johanson, 1986). Another claim is that the “faceless” market is an outdated economic assumption and instead IMP proposes that companies are embedded in heterogeneous networks (Easton, 1992). As stated in Håkansson & Snehota (1989):

“... when [the focal organization] is gravitating towards a set of other active organizations, then analogous environmental conditions can be assumed for the whole set of organizations with which the focal organization is interacting. The organization is then embedded in relationships with identifiable counterparts. This web of relationships can be called a network. One of the salient properties of such a network consists of the interdependencies between the different relationships...” (p. 191).

The network perspective itself is not a normative framework, but has a strictly descriptive and explanatory goal. But, as argued in Easton (1992), taking the focal firm viewpoint the work on exchange relations might have normative implications. These implications are considered external to the industrial network approach, and the work of the IMP Group.

Central to the network perspective are two models: the before mentioned Interaction Model and the ARA model. These two models go a long way in describing the fundamentals of the perspective.

The Interaction Model

The dynamic model of interaction contains four elements: the parties involved, the elements and processes of interaction, the environment within which the interaction takes place, and the atmosphere affecting and affected by the interaction, see Figure 5-13 below.

Figure 5-13: The Interaction Model (overview)⁵⁶

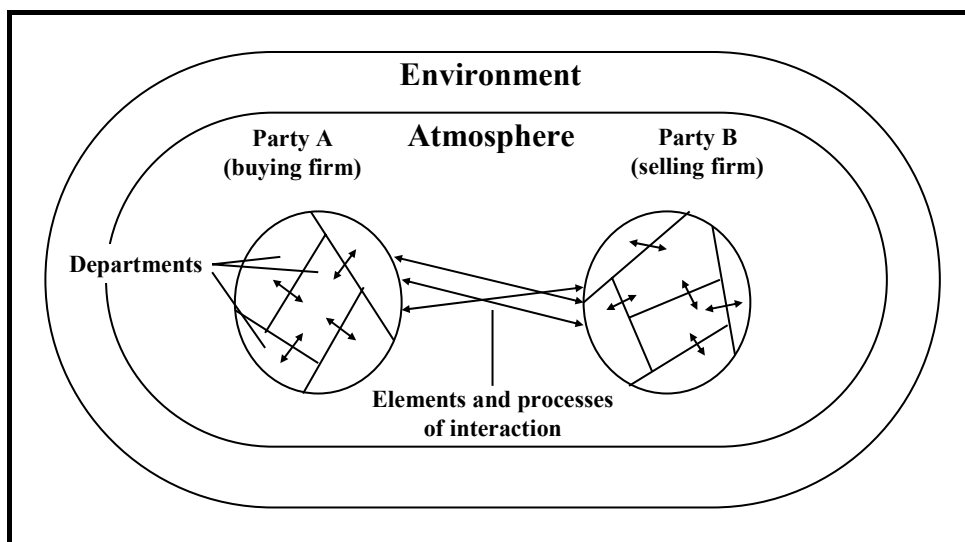

The process of interaction is described using two variables: episodes and relationships. The episodes are basically the individual exchanges, and are further described by four elements: product/service exchange, information exchange, financial exchange, and social exchange.

⁵⁶ Source: Figure 2.1 in IMP Group (1982), p. 15.

These exchanges are critical in the build-up of relationships. The routinization of exchanges over a long period of time leads to clear expectations on both sides. The institutionalization of these roles and responsibilities may be to such an extent they are taken for given. Besides exchanges, adaptations are important in the understanding of the interactions.

These exchanges and adaptations are dependent on the parties: on their positions in the market, on the organizations' ages, sizes and structures, and on the technologies in use. Furthermore, the individuals in the organization and the organization's experiences are factors determining the type of relationship. The wider context within which the interaction must be understood is the environment describing the structural context, and the atmosphere describing the relationship context, see below.

Figure 5-14: The Interaction Model (full)⁵⁷

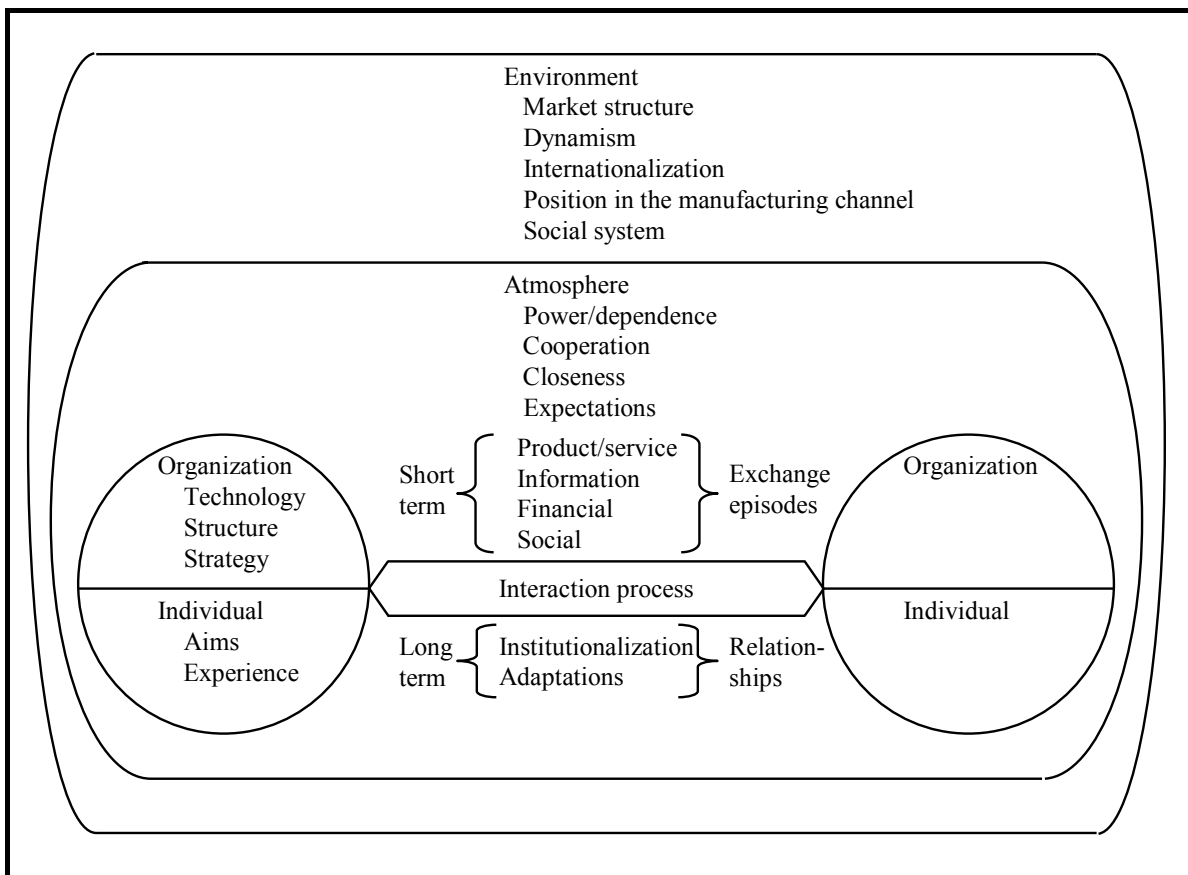

In this framework of personal and company interactions, relationships and exchanges the concept 'company' has a new interpretation:

“... we view companies as sets of interrelated interactions, through which capabilities are developed and employed. Similarly, wider industrial systems are seen as networks of inter-related interactions. In such networks several interdependent companies interact in order to influence and adapt each other's future activities and resources. This implies that the companies have both common and conflicting interests. It may be in the interest of companies which are dependent on each other to develop matching activities and capabilities. To

⁵⁷ Source: Figure 2.2 in IMP Group (1982), p. 24.

that extent they have common interests. On the other hand, which company is to bear the costs of the adaptations and developments necessary for interaction to take place successfully is not predetermined. Thus, all intercompany relations have elements of both mutual and conflicting interest and their relative importance depends on how the companies view each other.” (Ford, Håkansson, & Johanson, 1986, p. 28).

Summarization of the model’s properties is made in Håkansson & Snehota (1989):

“1. Business organizations often operate in a context in which their behaviour is conditioned by a limited number of counterparts, each of which is unique and engaged in pursuing its own goals.

2. In relation to these entities, an organization engages in continuous interactions that constitute a framework for exchange processes. Relationships make it possible to access and exploit the resources of other parties and to link the parties’ activities together.

3. The distinctive capabilities of an organization are developed through its interactions in the relationships that it maintains with other parties. The identity of the organization is thus created through relations with others.

4. Since the other parties to the interaction also operate under similar conditions, an organization’s performance is conditioned by the totality of the network as a context, i.e. even by the interdependencies among third parties.” (p. 192).

Where the Interaction Model explains the exchanges and adaptations between dyads, the ARA model was originally introduced to enable integrated analysis of stability and development in an industry (Håkansson & Johanson, 1992).

The ARA Model

The model contains three variables: actors, resources, and activities. Each variable influence the others in the overall structure of the networks.

Actors control activities and/or resources, and as actors can be defined at various organizational levels (individuals, groups, part of firms, firms, groups of firms) there is inherently confusion over who actually controls which resources. Views on the control of resources will vary, not least due to differential knowledge and the conflicting interests of the goal oriented actors. Conversely, the common interests and the existence of relationships glue the actor network together and ensure stability.

An activity, in turn, occur when

“...one or more actors combine, develop, exchange, or create resources by utilising other resources.” (Håkansson & Johanson, 1992, p. 30).⁵⁸

Two types of activities exist: transformation and transfer activities. The former is always controlled by one actor while the latter may be controlled by one or more actors, eventually linking the actors together through the combined effort. Activities might be looser or tighter coupled, and be more or less frequently repeated. A sequence of often repeated, tightly

⁵⁸ Håkansson & Johanson (1992): ”While stability is generally seen as the opposite to change and development this model views stability as vital for industrial development.” (p. 30).

coupled transformation and transfer activities is called a transaction chain⁵⁹. Such a chain of activities involve more than one actor, and demonstrate the interdependency and need for adaptations in the network. This leads to the creation of routines and informal rules resulting in a form of institutionalization and stability.

The last class of variables, the resources, completes the framework. Resources enable the performance of activities, are controlled by one or more actors, and are heterogeneous in nature. Like the actors and activities, the resources are part of a network of resources. In the network, the resources are linked through the mutual control of resources for transfer of activities, and by the need for the combination of resources, both in transaction chains and in performing activities requiring more than one resource. See Figure 5-15 below.

Figure 5-15: The ARA Model⁶⁰

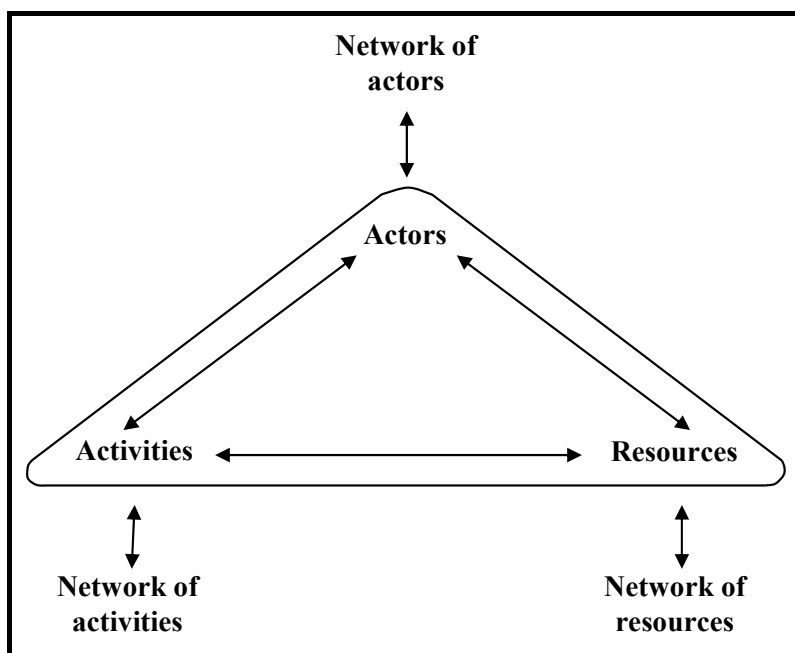

The dependencies in the three layers of the network is further developed in a later contribution (Håkansson & Snehota, 1994), introducing the terms activity links, resource ties, and actor bonds. These are defined as:

“ - Activity links regard technical, administrative, commercial and other activities of a company that can be connected in different ways to those of another company as a relationship develops.

- Resource ties connect various resource elements (technological, material, knowledge resources and other tangibles) of two companies. Resource ties result from how the relationship has developed and represent in itself a resource for a company.

⁵⁹ Thought: is “transaction chain: a sequence of often repeated, tightly coupled transformation and transfer activities” really an alternative definition of “process”? The transaction chain indirectly refers to “the long-linked technology” as described in Thompson (1967).

⁶⁰ Source: Figure 2.1 in Håkansson & Johanson (1992), p. 29.

- Actor bonds connect actors and influence how the two actors perceive each other and form their identities in relation to each other. Bonds become established in interaction and reflect the interaction process.” (pp. 26-27).

In this contribution another point is made, that each relationship has multiple effects: effects on the immediate dyad, on each participating company and on third parties. As each relationship represents a unique combination of resources and thereby a unique learning opportunity for the participants, not only the participating companies but also third parties are influenced through other relationships.

The consequence of this perspective is a more diffuse perception of the boundaries of the firm, as stated in Håkansson & Snehota (1989):

“In comparison with the conventional view of an organization’s boundaries, this approach means on the one hand that some of the resources and activities traditionally considered ‘internal’ can hardly be controlled and influenced by the organization, while a number of what have been considered ‘external’ resources and activities do actually constitute an integral part of the organization itself and are subject to its influence and control.” (pp. 193-194).

And consequently, effectiveness also has to be re-interpreted:

“It is through its relationships with others that the distinctive capabilities of an organization are acquired and developed. It is therefore the activities taking place between the organization and the other parties, rather than activities within the organization itself, which are the determinants of the bargaining position and of the overall effectiveness of the organization in achieving its goals.” (p. 196)

Together, the two models (Interaction Model and ARA Model) present the perspective put forward by the IMP Group.

The last element in the framework is the development of relationships.

Relationships

In Ford (1980) the development of buyer/seller relationships is described in a five (four + one) stage model using the metaphor “marriage”. The four first stages describe the development from being an unknown supplier to being a member of the network, through increased experience, commitment, and adaptations and decreased uncertainty and distance (defined as social, cultural, technological, and geographical distance). In the final stage (stage five) the market has stabilized, and all members are institutionalized into stable relationships. This last stage is only reached under certain circumstances, and is not necessarily attractive, as the institutionalization may limit the organizations possibilities in seeking new suppliers.

Figure 5-16 below illustrates the typology.

Figure 5-16: The Development of Buyer/Seller Relationships in Industrial Markets - Summary⁶¹

1	2	3	4	5
Pre-Relationship Stage	Early Stage	Development Stage	Long-Term Stage	Final Stage
Evaluation of new potential supplier	Negotiation of sample delivery	Contract signed or delivery build up scale deliveries	After several major purchases or large	In long established stable markets
Evaluation initiated by:	Experience:	– Increased	– High	
– particular episode in existing relationship	– Low			
– general evaluation of existing supplier	Uncertainty:	– Reduced	– Minimum development of institutionalisation	Extensive institutionalisation
– efforts of non supplier	– High			
– other information sources	Distance:	– Reduced	– Minimum	
– overall policy decision	– High			
Evaluation conditioned by:	Commitment:	– Actual: Increased	– Actual: Maximum	Business based on industry codes of practice
– experienced with previous supplier	– Actual: Low	– Perceived: Demonstrated by informal adaptations	– Perceived: Reduced	
– uncertainty about potential relationship	Adaptations			
– "distance" from potential supplier	High investment of management time	Increasing formal and informal adaptations	Extensive adaptations	
Commitment – zero !	Few cost-savings	Cost savings increase	Cost savings reduced by institutionalisation	

This model has been challenged by various researchers within the IMP Group. Wilkinson & Young (1994) suggest the metaphor “dancing” instead of “marriage”. They argue dancing is a more appropriate metaphor for at least two reasons: 1. relationships do not necessarily develop into a stable, happy marriage, and 2. one may have many dancing partners, with

⁶¹ Source: Table I in Ford (1980), p. 342.

whom different relationship types are experienced. Hedaa (1993) argues the “marriage” metaphor is

“...a misleading and empirically unlikely ideal type obscuring the more likely wigwag movements of strengthening and weakening forces, maybe even with intermittent disconnections, impacting the dynamics of quality of relationships.” (p. 191),

and goes on to criticize the use of a life-cycle notion of relationships:

“In a turbulent world it is very unlikely that so many influence factors work in concert to support the life-cycle notion of consecutive stages. At any point of time in the life-course of a relationship, opportunities for strengthening of ties, risks for weakening of ties, and threats of exit from the relationship may prevail.” (pp. 191-192).

This is supported by Easton (1992) who argues that the networks themselves do not have a life-cycle, do have stability, but are not static. Relationships are continually changing, partly due to external events, partly due to the exchanges taking place.

5.4.1 IA and SCM

To many (academics) IA is more or less the (epistemological) foundation of SCM. Especially the early work on SCM focused on trust and the value of long-term relationships. The trust based relationships were considered a pre-requisite for SCM and the main device to enable the creation of a stable network, protecting the company from external shocks. In a sense SCM and the network perspective have co-developed from a single-minded focus on the long-term relationships towards more nuanced view on the relationships and their relevance under different circumstances.

The “stickyness” of business markets is convincingly described in Hedaa (1996). The article describes the efforts by sales forces to gain market share, and documents the reluctance of buyers to change suppliers. This empirical work demonstrated another reality than the one modeled in neoclassical economics, where economic optimality is pursued through rational choices. The notion of “stability, not static”, the slow stable development of the network is in strong contrast to the neoclassical decision models. Hedaa (1996) thereby supports the claim that relationships are the corporations’ most important resources, and that relationships should be maintained on a continuous basis as they are both difficult and costly to establish. Paradoxically, the IMP Group does not seem to be interested in investigating the correlation between behavior and the effects on the relationships, or on the consequences of e.g. moral hazard. Their persistent claim that relationships develop slowly over time might make it very difficult to bridge the gap between the descriptive models and normative concepts.

Another shortcoming of the network perspective is the absence of interest in the distribution of activities across the network, an issue of critical importance of any manager in closely integrated networks.

The final objection raised on this context is the lack of managerial tools in general. The managerial view in the network perspective is definitely one of cooperation and adaptation, but does not give any directions as how to achieve the corporations’ objectives. The

management of the network is really a cooperative effort where distinct decisions on common strategy are replaced by continuous adaptations.

5.4.2 Contributions Referencing IA

Perhaps due to a focus on normative statements and the descriptive nature of IA, no contributions in the literature studies are marked as explicitly referencing IA. It is beyond question, though, that the network perspective is a fundamental building block within SCM.

A quick sweep using the search criteria “IMP” in abstract across the relevant (as described in Chapter 1) journals resulted in more than 3000 hits spanning a wide range of subjects, e.g.:

- Tuominen (1999) - investor relationships are investigated in order to better understand the evolving episodes and bonds. The Interaction Approach (IMP) is one of three perspectives used to understand investor relationships, the others being “The Nordic School” and “Relationship Marketing”.
- Johansson & Elg (2002) - the network perspective is used to better understand entry barriers at the firm level, and to enhance Porter’s (1985) view on entry barriers in important aspects. Using the Swedish food industry as an example, the impact of deregulation following the entry into the free market of EU is investigated, and the importance of relationships and their function as entry barriers are described.
- Karlsson (2003) - uses the network perspective to hypothesize on the management of production organizations in networks, the so-called extraprises, by using the fundamentals of the ARA model to frame empirics.
- Benson-Rea & Wilson (2003) - perform an analytical comparison of the entrepreneurship literature and the writings of the IMP Group. They propose a model combining IMP’s evolutionary (emergent) approach with the entrepreneurship’s revolutionary (intentional) approach to learning in networks.
- Skjøtt-Larsen (1999) - analyze Transaction Cost Economics, the Network Perspective and Resource-based Theory as research perspectives on SCM.

The list goes on and on.

5.4.3 IA and Supply Chain Risks

Thorough analysis of the IMP literature reveals an absence of risk management. Instead, uncertainty has a focal position, at least in the early works (e.g. Håkonsson, Johanson, & Wootz, 1976; IMP Group, 1982; & Hedaa, 1993). In Håkonsson, Johanson, & Wootz (1976), three types of uncertainties in the interaction process is identified:

- *need uncertainty* is the buyer’s uncertainty of identifying the exact nature of the need,
- *market uncertainty* is related to the buyers perception of the suppliers’ ability to deliver, and
- *transaction uncertainty*, which is the uncertainty of actually receiving the product or component ordered.

These three uncertainties constitute a framework for influencing the buyer, using two abilities: the *need solving ability* and the *transfer ability*. The former is made up of characteristics of

the products (function, quality etc.) and the services which are rendered in combination with the product. The latter describe the reliability of delivery of the ordered. The organizational design is thereby of critical importance in the interaction process, as the need solving and transfer abilities determine the success or failure of the interactions. As stated in Håkonsson, Johanson, & Wootz (1976):

“By influencing the perceived uncertainty of the buyer in different ways it will be possible for the selling firm to bring about various types of behaviour effects. The perceived uncertainty can be either increased or decreased depending on the contents of the influence tactics.” (p. 324).

In the typology of exchanges (see e.g. Figure 5-14) all elements reference uncertainty, e.g. in the money exchange as currency rate fluctuations or in the social exchange as a remover of uncertainty. Through social exchange trust is created and expectations are adjusted creating a stable and reliable room for exchanges.

Besides the episode level, uncertainty is present in the control element in the atmosphere. As stated in IMP Group (1982),

“Another important reason for the closer connection with a counterpart can be to reduce the uncertainty associated with that input or output by increasing its control over the other company.” (p. 22).

And further on dependency:

“... the level of dependence on one relationship affects the vulnerability of an organization to the exercise of power by its opposite number. ... It is the management of the closeness of the relationship, with its associated power and dependence, which is perhaps a crucial aspect of many industrial marketing and purchasing strategies.” (p. 22),

and goal:

“Summing up this discussion on of the reasons for a close interaction, we can conclude that relationships are established and used in order to gain economic benefits, lower costs, higher profits, and/or improving the organization’s control of some aspect of its environment.” (p. 22).

Introducing three sources of uncertainty (supplier, customer, and competitor) and two new uncertainty types (technical and acceptance uncertainty) Hedaa (1993) extends the original typology by Håkonsson, Johanson, & Wootz (1976) briefly described above. The resulting matrix is depicted in Figure 5-17 below. The uncertainties in the matrix may be matched to the four definitions from the risk matrix. The process risk seems to be covered quite extensively, as e.g. market uncertainties (7, 8, & 9) and transaction uncertainties (13, 14, & 15) seem to translate quite well. The technical uncertainties (4, 5, & 6) might translate into the process risks, albeit the competitor class might be discarded altogether. If the structure component to the risk matrix is dealt with, it must be in the acceptance uncertainty class, for customers (10) and/or suppliers (11). The domain thereby might have a contribution, at least to a classification of risk sources.

Figure 5-17: Types and Sources of Uncertainties in Relationships⁶²

Uncertainties		Customer	Supplier	Competitor		
Type	Source					
Need	what products to choose	1	what products to suggest	2	the solutions offered	3
	Technical	failure of products or application	4	supplier's skills in proper use of products	5	possible better technical solutions offered
Market	variations in demand structure	7	other customers demand occupying capacity	8	changes in marketing strategies	9
	Acceptance	changes in power structure decision making unit	10	supplying special designed products/services	11	getting better access to people in DMU
Transaction	changes in orders or trading terms	13	deviations from delivery schedules	14	increasing reliability in exchange obligations	15

Management of Risks

But when it comes to the management of risks, it becomes a bit more unclear. The mechanisms of inclusion are clear, though: the slow adaptation process and build-up of knowledge and experience leads to trust. With trust comes the possibility of obtaining “full membership” of the network. Network members are expected to follow a set of rules shared by the entire network, so in a sense the “evaluation of the membership application” is a sort of risk management. The question posed by the network is really: “Is this company really trustworthy enough to become a member of our network?” And implicitly to each of the network members: “Do I really want to be burdened by this company’s mistakes and financial problems?”. The problems of each network member may become a problem for all in the network in the same manner as a distinct advantage for one network member is expected to spread to the rest of the network. One might therefore map a network as consisting of four classes of companies:

1. Non-interacting companies. Companies with whom no members have interactions, perhaps even competitors?
2. Interacting non-members. Companies not belonging to the network - either caused by earlier refusal or due to limited lack of relevance. Interaction is characterized by safeguards and controls.

⁶² Source: Figure 4 in Hedaa (1993), p. 200.

3. Trusted members. Companies with whom sufficient experience has been obtained to interact with few safeguards and controls. Perhaps evolving into a “core member”.
4. Core members. Companies very important to the network – by size, history, access to markets, financial status... Core members share fate and rely on each other for the continuation of their company, and interaction is characterized by exceptions management instead of controls and safeguards.

Spelling out the classes it becomes obvious risk management differs greatly depending on the “standing in the network”. Combining the standing of the focal company (down) with the network membership classes (across) a risk management schema might look like Figure 5-18 below. The schema describes the intentions of the various network members, e.g. the Interacting Non-member who aspires for membership, or the Core Member who is cautious about including new members before making sure they pose no threat to the network (and themselves). The schema also demonstrates the absence of risk management between Core Members, and the gradual increase in safe guards and controls (or contracts) as membership lessens.

Figure 5-18: Risk Management Schema for Network Membership Classes

”Seller” ”Buyer”	1. Non-interacting Companies	2. Interacting Non-members	3. Trusted Members	4. Core Members
1. Non-interacting Companies	[Irrelevant]	[Irrelevant]	[Irrelevant]	[Irrelevant]
2. Interacting Non-members	[Monitored]	Business relationship. Safeguards and contracts	Business relationship. If membership desired, contracts are relaxed and interaction intensified.	Business relationship. If membership desired, contracts are relaxed and interaction intensified.
3. Trusted Members	[Monitored]	Business relationship. If partner might add value to the network, interaction is encouraged.	Trust supported by continuous contact. Few safeguards.	Trust supported by continuous contact. Few safeguards.
4. Core Members	[Monitored]	Business relationship. If partner might add value to the network, interaction is encouraged.	Trust supported by continuous contact. Few safeguards.	Trust supported by continuous contact. No safeguards.

The model may seem quite straight forward, but one should understand that a company might/will be interacting with/in more than one network. Empirical investigations show companies obtain memberships in network to varying degrees - from total embeddedness (Core Members) to less so (Interacting Non-members).

Management of Supply Chain Risks

From the description of IA it is evident the management of supply chain risks is not supported. The framework relies on the slow adaptation through interaction, creating an atmosphere of trust and reliance on good intentions. The intentional disruptions and intended exit of a critical supply chain (network) partner is thereby not within scope of IA. For the unintentional risks, the following can be concluded:

- **Process Risk:** Disruptions to the flow of goods in the network are inevitable, but in case of repeated non-performance network partners are expected to offer assistance to solve the problem. Network members are expected to be capable and competent, but circumstances outside the control of the individual members might influence the performance of the member and thereby the entire network. Therefore the network is committed to support the inflicted network members overcoming the difficulties, of whatever nature they might be. The distinct decision of dropping a non-performing network member is not really supported in the framework. Developments within the network are expected to be slow, altering the level of interaction and the controls and safeguards in place. Or alternatively: a non-performing “Core Network Member” might experience a degradation of membership to “Trusted Network Member”
- **Structure Risk:** As mentioned above IA does not relate to the intended exit of a critical partners, but the unintentional (e.g. a bankruptcy) is considered. Network members are expected in the same manner as for disruptions to support the troubled network member. Only in case helping the troubled network member is threatening the entire network member might it be considered not to offer assistance.

In conclusion, IA relies on slow adaptations and the emergence of trust between interacting parties as a precondition for network membership. Intentional disruptions or exits are not considered at all, but non-intentional are dealt with by means of offering assistance in the form of financial, operational or other types of aid. The core texts reviewed do not offer any support to the “strategic management perspective” but insist troubled network members are helped unless the survival of the entire network is at stake.

5.5 Conclusions

From the discussion above the four theoretical frameworks can be mapped against the Supply Chain Risk Framework, as promised at the outset of the chapter. For matters of convenience the intentional risks (intentional disruptions and exits) are mapped separate from the unintentional ditto, and subsequently compared. But first the applicability of the theories to the domain of SCM is briefly summarized.

5.5.1 The Frameworks and SCM

From the analyses and discussions above it became clear that the four frameworks have very different contributions to the domain of SCM.

TCE obviously has strong arguments on the make-buy decision, but has severe shortcomings in terms of e.g. one-sidedness, the dyadic perspective, and the focus on cost instead of value. On the other hand, analyzing TCE it becomes apparent that frequency of transaction is quite important to the understanding of SCM, and that shifts in governance structure can be described, in part using the ‘frequency of disturbance’ argument.

Also P/A theory has severe problems in addressing the SCM domain. Perhaps partly due to the discarding of the “positivist stream” the theory had little relevance as the basic models were difficult to apply. Problems included confusion as to the distribution of roles (who is principal and who is agent), time perspective (single-period versus multi-period/ongoing), inappropriate optimality criteria etc. The contribution of P/A is thereby limited to determining the appropriate contract type in the dyadic relationships to customers and suppliers – leaving out the rest of the context. In case context could be built into the models, and a (better) mechanism to allocate cost advantages could be introduced, the models might be better able to inform the domain.

RBT and its focus on strategic positioning only partly address SCM as the object ‘supply chain’ is applied to RBT with some difficulty. The inter-organizational nature of some resources and core competencies conflict with the basic assumptions of the framework. In relation to the design of supply chain, RBT has been applied a number of times, most often to offer arguments for evaluation of portfolios of resources or competencies. A major problem in that respect, though, is the lack of objective measures, or even a method for measurability. Another serious shortcoming of the theory and its focus on core competencies and sustainable advantages is the lack of attention paid to the creation of unnecessary dependencies when outsourcing activities before ensuring a market for the activities exist.

The last theoretical framework, IA, is probably the most cited framework within SCM. The framework itself is not normative, but using it may have normative implications. IA have little to offer in terms of methods or recommendations for supply chain design, but simply insists companies in networks are interdependent as reciprocal adaptations ensure stability in the network.

These findings are in line with the concerns vented in Chapter 2 (Burgess, Singh, & Koroglu, 2006; Storey et al., 2006).

5.5.2 Intentional Disruptions and Exits

Also in terms of handling the intentional risks, the four frameworks differ greatly.

In TCE opportunistic behavior is assumed. Therefore intentionality is not really that important – focus is on the outcome and not the behavior. As described above TCE explicitly addresses the process risk as ‘Frequency of Disruptions’ and suggests shift to either market or hierarchy to avoid it. The structural risk, the sudden exit of a critical partner, is addressed but only in terms of avoiding bias in dependency. It is thereby through the management of the dependency that TCE tries to manage the intentional exit of a partner. If it hurts the partner economically to exit, he will require a higher benefit of leaving thereby reducing the likelihood.

Also in P/A opportunistic behavior is assumed (see e.g. Table 5-2). To mitigate uncertainty of the contracted activities the principal has a choice of contract type. In case of a behavior-based contract the principal obtains access to the agent, making monitoring possible (at a cost). Conversely, the output-based contract postpones the identification of foul play, as the

principal in this contract type does not have access to the agent. Process risk is thereby addressed through the choice of contract for each supplier and period. Agents with a poor performance in one period might not be considered for a contract in the next. Alternatively, poor performance might be penalized, if defined in the contract. The structural risk, on the other hand, does not really seem to fit the theory as the consequence of applying the theory would result in all contracts (with critical partners) being behavior-based. Therefore contractually defined penalties might be the only means to ensure stability?

Neither RBT nor IA has a contribution to the management of the intentional risks. The former is focused towards strategic positioning of the company, whereas the latter assumes network members behaving opportunistically have been spotted before being included in the network. In RBT the 'value of the competence' will deteriorate with increased frequency of (intended) disruptions, potentially leading to termination of the business relationship. In case RBT is extended to allow inter-organizational resources and core competencies, the creation of such competencies might be perceived as a risk management strategy linking the companies together through shared sustainable competitive advantage.

Figure 5-19: Management of Intentional Supply Chain Risks

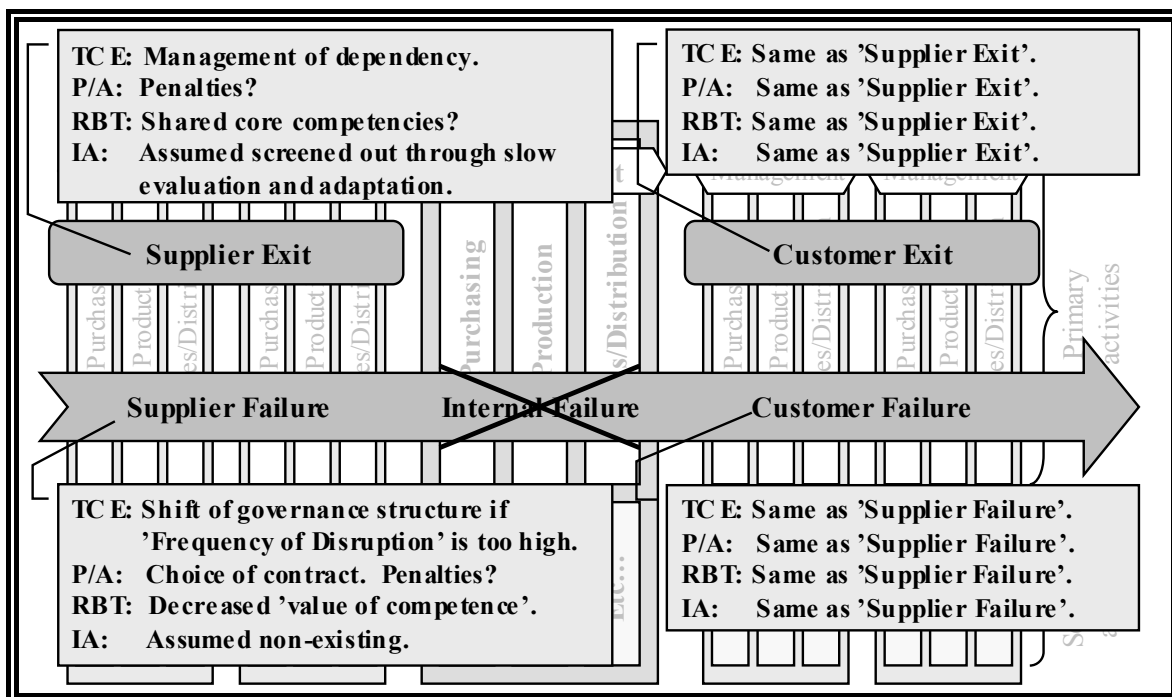

Mapping the ability to manage the intentional supply chain risks results in Figure 5-19 above. As illustrated risks seem to be addressed in the same manner up- and down-stream. IA might in this respect hold a special position as the framework does not discriminate on the position in the value creation process. For P/A this problem is already addressed - as mentioned previously it might be difficult in some instances to determine which company is principal and which is agent. Position in the chain does not predict the role in the P/A models. The same goes for RBT. So, even if the theories might be predominantly used up-stream no restrictions on their application downstream have been found.

Summing up, the management of the intentional sudden exit of a critical supply chain partner is poorly addressed by the four theoretical perspectives. TCE manages this risk alone through manipulating the dependency between focal company and supplier/customer whereas RBT relies on the suggested “SCM extension” (shared core competence) to address the risk. The process risk is directly addressed by TCE and P/A both, the former suggesting a shift towards hierarchy or market, the latter suggesting choosing a contract type matching the requirements and the characteristics of the activities to be performed by the agent.

5.5.3 Unintentional Disruptions and Exits

As mentioned above TCE does not address intentionality – but conclusions differ from the previous section anyway. Managing the dependency between the companies does not mitigate the risk of an involuntary exit as a company gone bankrupt probably is unable to make strategic decisions. In case of e.g. a takeover the dependency argument might remain valid, though, if the buying company is interested in continuing the activities of the taken-over company. The management of the unintended process risk is identical to the intended process risk, as described in the previous section.

The arguments in P/A are more or less similar, except here the mechanism in play is the enforcement of contractual penalties. In case of e.g. a bankruptcy it might be impossible to avoid the exit whereas the buying company in a take-over might be persuaded to delay the exit and honor existing contracts.

As mentioned already RBT in itself does not address these risks explicitly, but following the same line of argumentation as in the previous section the focal company might be willing to help a troubled cooperator if core competencies are shared. As concluded above, the process risks might be managed through communicating the decreased perceived value of the competencies in play.

The risk of unintentional exit of a critical network member is managed in IA by collaboration between the remaining members in the network. In case of a take-over the rest of the network might not be able to mitigate the situation, but in case of e.g. financial troubles the network will expectedly try and mitigate through loans, extended credits etc. Only in the case where the survival of the entire network will be endangered the network members may refuse to aid the troubled company. In case of process risks, disruptions in the flow of materials, network members will offer their assistance. In case the disruptions are not addressed the company might be slowly excluded from the network?

Mapping the ability to manage the unintentional supply chain risks thereby results in Figure 5-20 below.

Figure 5-20: Management of Unintentional Supply Chain Risks

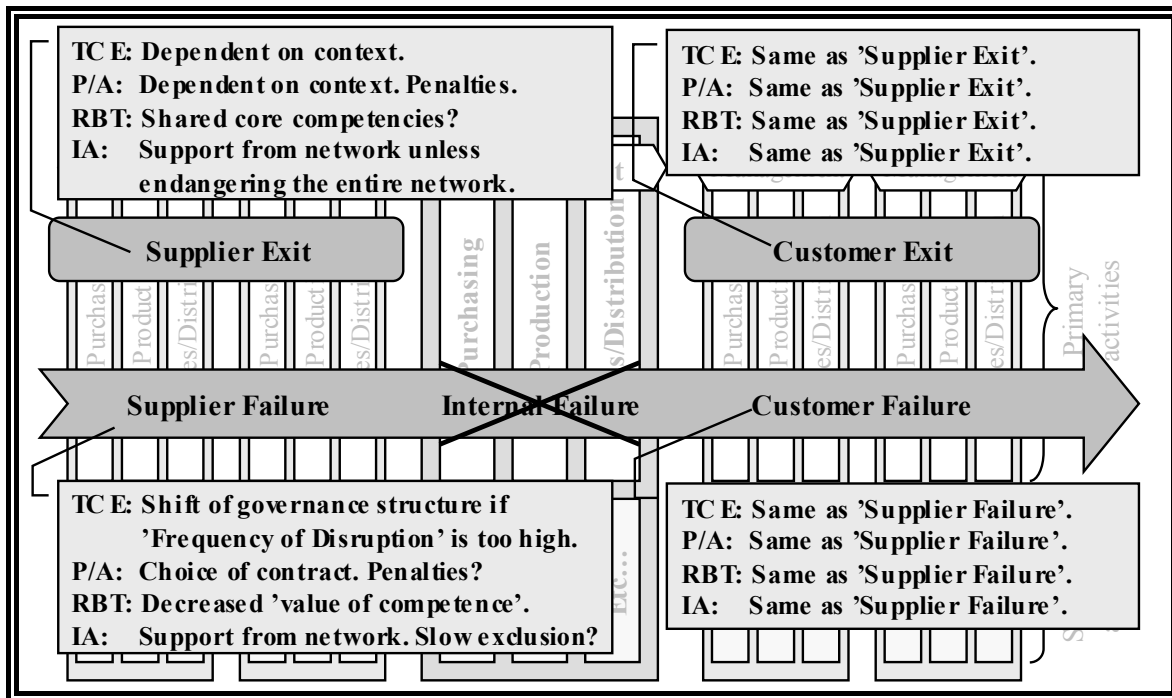

5.5.4 Overall Conclusion

As described in the introduction to the chapter analyses are performed on four theories – on their applicability to SCM, and on their ability to address the management of the supply chain risks.

SCM and the Theories

As concluded in Chapter 5.5.1 the theories predominantly used within the domain address SCM in quite different ways. Each theory is applicable to a certain degree, but each also has shortcomings and is only able to address a fraction of the collection of issues: strategy, design, process orientation, overlapping networks of business partners etc. The general applicability of the theories can therefore rightfully be questioned, leading to the obvious conclusion that the theories address specific problems, not the domain as such. This finding is perfectly in line with Storey et al. (2006):

“Our review of the literature on supply chain management suggests that the field is characterized by idealism and fragmentation. It uses overlapping terminology which is in turn drawn from multi-disciplinary bases. ... Despite recent attempts to map the terrain ... the field remains disparate.” (p. 758).

The conclusion also finds support in Croom, Romano, & Giannakis (2000a):

“One of the most significant findings from our literature analysis has been the relative lack of theoretical work... We would argue that theoretical development is critical to the establishment and development of supply chain management study. ... [However] what is of concern is the lack of a significant body of a priori theory... (p. 75).

A first step to establishing a coherent theoretical base might be a somewhat less ambiguous understanding of the content and scope of SCM?

Risk Management and the Theories

The analyses described in Chapters 5.5.2 and 5.5.3 document the lack of ability to address the identified supply chain risks. Each theory only addresses a part of the matrix, and for most of the theories this is achieved only through the suggested extensions to the theory. It is therefore concluded that the logic of risk management is not really integrated into the theories used within the SCM domain. Also for this reason will it be interesting to learn how these two disciplines interact in the case companies, where risk management is performed, and to which degree of formalization. More on this in the following chapters...

PART III

EMPIRICAL INVESTIGATIONS

Chapter 6 Case Study Design

The purpose of this chapter is to create a basis for answering the last research question by designing the research tools necessary to map out the SCM and SCRM practices in the case companies. In Chapter 1 (and Appendix A) the models describing SCM as starting from within and extending outside the focal company are questioned. Instead, the data collected in the pilot studies indicates SCM develops in the interfaces between companies first. Also it appears that length of relationship has less than expected explanatory power as all companies appear to have long-term relationships¹. Albeit the pilot studies resulted in a redesign of this study the objective has not changed – to understand of how SCM and SCRM is practiced in Danish manufacturing companies. Figure 6-1 below illustrates the overall method.

Figure 6-1: Case Study Method²

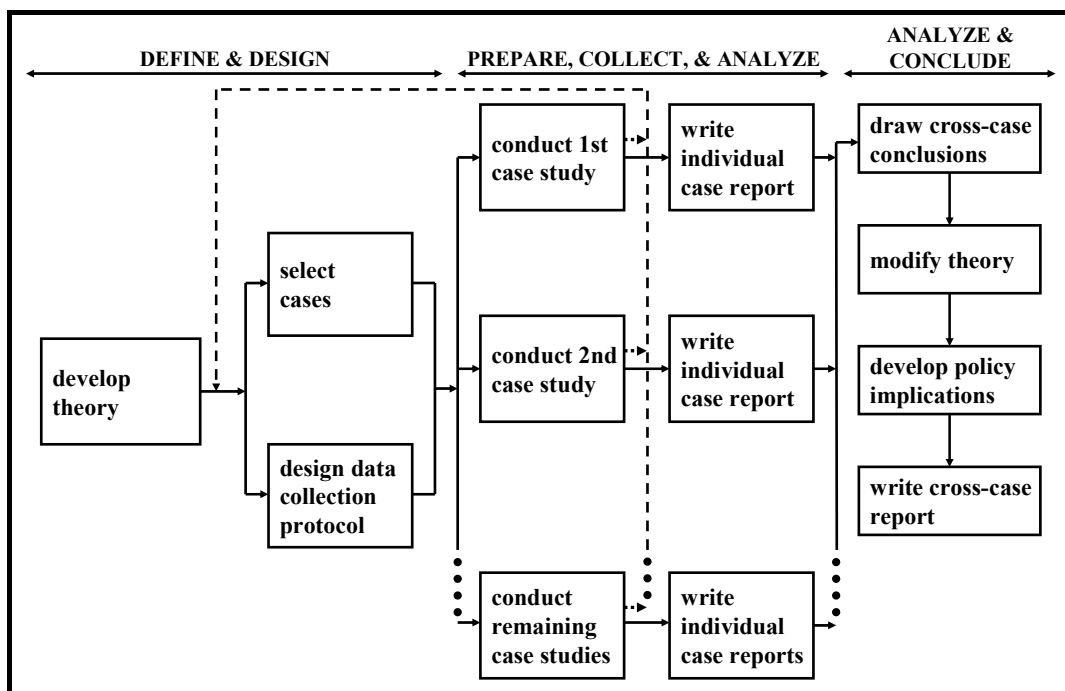

Below the case study design is explained through detailed descriptions of the theory development, case selection, and data collection protocol. The case study reports are documented in Chapter 7; Chapter 8 contains the cross-case report. Policy implications and modifications to theory are described in Chapter 9.

6.1 Theory (Development)

As illustrated in Figure 6-1 above the first step is to develop theory. The figure also illustrates how feedback mechanisms influence at various phases of the research process. In this context

¹ The empirics collected in the pilot studies and reported in Chapter 1 and Appendix A seem to support the notion of 'stickyness' as reported in Hedaa (1996). Inter-organizational relationships are not discarded overnight due to a marginal difference in price (or other attribute), but apparently there is a certain reluctance to terminate relationships.

² Source: Figure 2.5 in Yin (1994), p. 49.

the pilot studies can be perceived as the first iterations over the initial phase of the process as the ‘prevalent theory’ is contradicted. The fact that ‘the path of evolution’ identified differed from the models does not in itself result in a rejection of the constructs of SCM but questions in which order or sequence each construct develops. It may also question whether there is a ‘natural’ path of evolution – or if the domain is better described by a multiplicity of configurations. Nonetheless, in this context the development of theory refers to the development of constructs – not on the creation of new theory *per se*³.

Importance of Theory

In order to investigate the phenomena SCM and SCRM the case study must be carefully designed:

“[The] role of theory development, prior to the conduct of any data collection, is one point of difference between case studies and related methods such as ethnography ... and ‘grounded theory’... For case studies, theory development as part of the design phase is essential, whether the ensuing case study’s purpose is to develop or test theory.” (Yin, 1994, p. 27).

Performing case studies therefore should rely on theory, in the form of propositions, rival explanations, or existing theory. From the outset the design should explicate the research questions and propositions, define the unit of analysis, and explain how to link the findings with propositions (Yin, 1994, pp. 22-26). The role of theory also has an impact on the method of generalization when doing case study research:

“A fatal flaw in doing case studies is to conceive of statistical generalization as the method of generalizing the results of the case. This is because cases are not ‘sampling units’ and should not be chosen for this reason. ... [T]he methods of generalization is ‘analytic generalization’, in which the previously developed theory is used as a template with which to compare the empirical results of the case study. If two or more cases are shown to support the same theory, replication may be claimed. The empirical results may be considered yet more potent if two or more cases support the same theory but does not support an equally plausible rival theory.” (pp. 30-31).

Case study research thereby differs from experiments in terms of control of the context (the environment is not controlled) and experiments and surveys both in terms of generalization (cases do not represent the entire population in a statistical sense).

Theory as Constructs

As the intent is to understand and document the practices of SCM and SCRM in the case companies, each of these complex phenomena is decomposed into a number of constructs, as suggested by Burgess, Singh, and Koroglu (2006):

“Owing to the nature of the field [SCM], a suitable way to present the SCM concepts is to logically group them into ‘constructs’ – higher order abstract variables that are not directly measurable, but provide a more rounded

³ It is important to understand the intention of this study is to test theory, not generate theory. In the context of the proposed method the development of new theory may take the form of hypotheses for subsequent testing.

definition of the concepts... For the SCM field, agreement on a common set of constructs does not appear to exist.” (p. 709).

6.1.1 Constructs for SCM

Taking a step back and approaching the phenomenon at a more abstract level result in the high-level constructs described below. Inspiration is gathered from previously used SCM models, the literature reviews as well as other review articles (e.g. Burgess, Singh, & Koroglu, 2006; Chen & Paulraj, 2004; Gibson, Mentzer, & Cook, 2005; Storey et al., 2006)⁴. The following six high-level constructs are considered appropriate for an exploratory study of this type.

The ‘Supply Chain Organization’

First and foremost it is of interest to investigate how the companies have organized themselves around the entity ‘supply chain’. In case the company has embraced the strategic challenge of relating to supply chains instead of market opportunities, the company will have to concurrently consider the internal organization and the up- and down-stream sides of the company (e.g. Stevens, 1989; Mentzer et al., 2001). The existence of a SCM department may signal a more credible commitment (see Chapter 5.1) to cooperate with external parties – especially if this organizational entity is interacting to obtain shared advantages. An alternative understanding is offered by RBT (see Chapter 5.3) where the consolidation of capabilities may evolve into a core competence. Implementing a SCM department may thereby increase the likelihood of establishing true inter-organizational operations.

Production Philosophy

The mode of operation is also known as the production philosophy, explaining the methods applied to produce the variety of products and overall volume. Contemporary contributions refer to concepts like Leanness or Agility (e.g. Mason-Jones, Naylor, & Towill, 2000a; Mason-Jones, Naylor, & Towill, 2000b; Towill & Christopher, 2002) or Responsiveness (e.g. Holweg, 2005). The underlying (operations-oriented) concepts include e.g. Push/Pull⁵, Modularity⁶, and Postponement strategies⁷. As described in Chapter 2 “pure” Push strategies are considered “pre-SCM” as they rely on long production series of products not “fitted to” the customer. On the other hand the pure “Pull” strategy is considered “modern” as it relies on tight integration with suppliers, information transparency (tradeoff against inventories) and fault-free internal operations and suppliers. Participation in a Pull-type supply chain may be explained using P/A Theory (see Chapter 5.2) with the customer (or down-stream supply chain partner) being the principal and the upstream supply chain being the agent. Also in this

⁴ The development of constructs thereby relies on the “critical review method”.

⁵ For a case study exemplifying this concept, see e.g. Hammel & Kopczak (1993).

⁶ Modularity - the principle of decomposing a product into sub-systems, and designing them independently. See e.g. Baldwin & Clark (1997) or van Hoek & Weken (1998).

⁷ Various types of postponement strategies exist, see e.g. Pagh & Cooper (1998) or van Hoek, Commandeur, & Vos (1998).

instance TCE may supplement the understanding through the perspective of the ‘Hybrid Governance Form’ (again: see Chapter 5.1).

Process Orientation

As documented previously process orientation is focal to SCM (e.g. Cooper, Lambert, & Pagh, 1997; Hewitt, 1994; Lambert, Cooper, & Pagh, 1998) in order to achieve the smoothest operation and shortest lead time possible. In most (early) SCM models processes cross organizational boundaries (e.g. Stevens, 1989; Mentzer et al., 2001) but as discussed in Chapter 2 this proposition may very well be due to an immature understanding of the SCM processes. As illustrated in Figure 2-9 processes have different “lengths” and the logic of their “connectedness” vary from process to process. The “Supplier Relationship Management” does not connect to the supplier’s “Supplier Relationship Management” process but (hopefully) to the “Customer Relationship Process”. The only process “connected” from tier to tier in the supply chain is the “Fulfillment Process”. As process orientation thereby is an inherently company internal aspect (of SCM) the inter-company process integration is described separately (under ‘External Integration’, see below). Process orientation is thereby evaluated from the organizational setup (i.e. use of cross-functional teams) and from the list of processes supplied by interviewees⁸. The removal of functional silos within the company may be understood through TCE (see Chapter 5.1) as an “intra-organizational vertical integration”. Alternatively the process of organizing around a process (instead of a function) may be viewed as a P/A problem (see Chapter 5.2) – having the process owner acting as the principal and the participants being the agents (with their functional references intact).

IT Support

The use of IT is routinely claimed to be a pre-requisite for SCM (e.g. Christopher & Towill, 2001; Mentzer et al., 2001; Schary & Skjøtt-Larsen, 2001) – some even claim the use of IT may promote SCM (e.g. Jayaram, Vickery, & Droge, 2000; Stefansson, 2002). Potentially supporting internal and external integration, the role of IT must be evaluated to understand to which extent the “system” (the supply chain(s)) is automated as SCM requires information to be exchanged in a smooth and timely manner (e.g. Auramo, Kauremaa, & Tanskanen, 2005; Bagchi et al., 2005). In case IT integration is tight (no systems de-coupling) e.g. orders “wash through” the system as a tidal wave, enabling the entire system to act as one (e.g. Boyson & Corsi, 2001; Christiaanse & Kumar, 2000). Coordination across legal boundaries is almost cost-free up to confirmation of transactions – enabling high quality and early information sharing. Within the individual company the use of integrated applications like ERP supports transparency and enables better monitoring and control of processes (e.g. Akkermans et al., 2003; Forza, Romano, & Vinelli, 2000) thus supporting the removal of functional silos (as mentioned above). Both internally within the company and across legal boundaries the

⁸ As process orientation in some companies (see Appendix A) is merely a rephrasing of typical department names, a critical evaluation of the processes is needed.

impact of information transparency may be explained by means of P/A theory (see Chapter 5.2). Enabling online and (more or less) cost free access to information from the agent the monitoring cost of the principal is largely reduced thereby removing a major obstacle for this contract type.

External Integration

As already described above (early) models of SCM relies on external process integration even if evidence of process integration *per se* is scant (e.g. Bask & Juga, 2001). Most agree integration of the physical flow and the information flow are essential to SCM (e.g. Morash & Clinton, 1998; Frohlich & Westbrook, 2001) and case studies document how IT integration speeds up the fulfillment process within various industries (e.g. Ferdows, Lewis, & Machuca, 2004; Towill, Childerhouse, & Disney, 2002; Wilson & Clarke, 1998). Besides process and IT integration “the network effect” is often mentioned as a primary driver for supply chain integration – often using trust-based relationships as the integrative mechanism (e.g. Bagchi et al., 2005; Sahay, 2003). The “traditional” determinant for trust in relationships is “relationship length” – even if evidence compromising this proposition exists.

The concept Collaborative Planning, Forecasting, and Replenishment (CPFR) may enrich the understanding of the integration of supply chains (e.g. Fliedner, 2003; Simatupang & Sridharan, 2005; VICS, 2004). Albeit CPFR is normally considered a concept emerging from a certain practice (like e.g. ECR) it might be used to describe the level of collaboration between supply chain partners. The concept draws on a number of constructs, see Table 6-1 below. The reliance on IT integration is obvious as the information sharing (at least on a continual basis) would be impossible without automation. The second and third dimensions in the table above might be translated into ‘Coordination’ whereas the fourth and fifth are oriented towards alternative goals/outcomes of the collaboration. The last two dimensions do not describe the practice but are the output or explanation of the model proposed.

Table 6-1: Dimensions of different levels of CPFR⁹

Dimensions	Basic CPFR	Developed CPFR	Advanced CPFR
1. Shared information	Sales orders and confirmation Inventory data	Demand data Order planning data Promotion data Production data	Demand data Order planning data Promotion data Production data
2. Degree of discussion	No	Some	Frequently
3. Co-ordination/synchronisation	No	Some	All activities
4. Competence development	No	No	Knowledge
5. Evaluation	No	No	Experiences
6. Type of relationship	Transactional	Information sharing	Mutual learning
7. Theoretical explanation	TCA	Network	Resource- and competence-based

Combining the dimensions as discussed above and introducing a time perspective, the model might be further developed, see Table 6-2 below.

⁹ Source: Table I in Skjøtt-Larsen, Thernøe, & Andresen (2003), p. 537.

Table 6-2: Collaboration Model

Dimension	No CPFR	Basic CPFR	Advanced CPFR
Information Sharing	None	Periodic	Online/Continual
Coordination	None	Periodic	Continual
Alternative Goals	N/A	No (Secondary)	Yes (Primary)

The categories are renamed changing the lowest level to ‘No CPFR’. This category denotes relationships where no information sharing and no coordination take place (and therefore no alternative goals can exist). The next level of collaboration is characterized by periodic (e.g. monthly) exchange of information and coordination between supply chain partners. At this level alternative goals (e.g. competence building, network sharing) is secondary as the focus is on fulfillment (only). The highest level of collaboration in contrast is characterized by alternative goals as companies are tightly integrated through continual information sharing and coordination.

Each of the two suggested constructs (length of relationship and collaboration) may be explained in theoretical terms. The former may be understood through IA, see Chapter 5.4) which relies on the social interaction and resulting adaptation/integration to explain network structures. Trust plays an important role within this framework as it explains the (slow) integration of network members – and the absence of contracts within closely knitted networks. This explanation may be supplemented by P/A theory – as the closeness of the network may enable cost-free monitoring. The latter construct is explained in Table 6-2 above by references to three of the four frameworks reviewed in Chapter 5.

Inter-organizational Management

Borrowing from the before mentioned models by Stevens and Mentzer et al. (and many others) it seems evident the inter-organizational component has to be investigated as well. The extent of the “extraprise” (e.g. Karlsson, 2003; Geary, Childerhouse, & Towill, 2002) might be explained in a number of ways, here it is chosen simply to investigate if/how management and control is performed in union with suppliers and customers. The traditional “stand-alone” production unit will communicate through orders only, whereas the network-oriented company might share production plans, strategic information and perhaps even capacity and employees with participating companies. In a sense this element might also describe “the boundary of the network”.

The Resulting Set

From the categories described above the following list of high-level constructs are derived:

Table 6-3: SCM Constructs

Construct	Description
Supply Chain Organization	Describes how the company has organized around the task of performing SCM.
Production Philosophy	Describes the production philosophy (or philosophies) in place.
Process Orientation	Describes the process (or processes) in place as well as the related organizational set-up (e.g. cross-functional teams etc.).
IT Support	Describes the IT systems supporting the internal and external integration.
External Integration	Describes the (type of) integration with external parties.
Inter-organizational Management	Describes the practice of planning, control and/or management across legal boundaries.

The content of each construct is developed through inducing the empirical data collected from the case companies, thereby creating a multi-level hierarchy (as in Appendix A).

6.1.2 Constructs for SCRM

As for SCM also within SCRM a number of constructs need to be identified to guide the development of the research tool. But in contrast to SCM little knowledge on the management of supply chain risks exists – as documented in the literature reviews in Chapter 3 and Chapter 4. The constructs for SCRM therefore will appear slightly more exploratory and have less theoretical foundation than the SCM constructs.

Risk Management Organization

The investigation of SCRM practices starts out in a manner similar to investigating SCM: by querying for formal organization and/or positions. In e.g. Chopra & Sodhi (2004) the existence of an organization-wide understanding is required for supply chain risks to be managed efficiently. Referencing the Albuquerque incident (see Chapter 1) they claim:

“Like Ericsson smart companies do not want to wait for lightning to strike twice before taking action.” (p. 61).

The proposition to implement formal risk organization is supported by Harland, Brenchley, & Walker (2003) and by Zsidisin et al. (2004) who use formal organization as an indicator for the level of supply risk management. In Rice & Caniato (2003) training and the existence of positions within risk management are perceived as proactive risk management and a prerequisite for safe operation; in van der Horst & Beulens (2002) supply chain organization and governance structures are of primary interest. Finally, as documented in Norrman & Jansson (2004) the mitigation of the Albuquerque incident included development and implementation of an enterprise-wide organization and processes to identify, assess, and manage supply chain risks.

Risk Types and Management Effort

Following the description of the formal organization it seems logical to describe the types of risks managed locally within the investigated part of the organization. Several contributions outlining typologies of (supply chain) risks exist, e.g. Cavinato (2004), Chopra & Sodhi

(2004), and Spekman & Davis (2004). In this context the use of the categories introduced in the Risk Matrix (Structure versus Process Risks¹⁰) seems appropriate.

Naturally the perspectives on how to manage risks differ greatly: in Christopher & Lee (2004) development of confidence through visibility and control in the supply chain is perceived as the primary mechanisms to risk mitigation whereas Chopra & Sodhi (2004) suggest a list of risk mitigation strategies and van der Horst & Beulens (2002) and Geary, Childerhouse, & Towill (2002) suggest managing sources of uncertainty. Both Hauser (2003) and Spekman & Davis (2004) consider SCM an “extended system” and emphasize the importance of “building risk management into SCM”.

Risk Identification and Assessment

Also relevant when unraveling the nature of risk management within operations the characteristics of the sub-processes risk identification and risk assessment might reveal insights into the overall practice (e.g. Chopra & Sodhi, 2004; Lee & Wolfe, 2003). These processes may be directly observable in contrast to e.g. the management process which may be completely embedded in the practice in question¹¹. The investigation of the risk identification and risk assessment is an investigation of the formalization of the risk management practices. Whereas the risk management process might be more or less formal risk identification will lose its justification if not performed periodically or in conjunction with e.g. major investments, restructuring etc. Performing risk identification in a less stringent manner will reduce the relevance of the task as management will react according to a false image of the risk landscape (e.g. Harland, Brenchley, & Walker, 2003; Hauser, 2003). The lack of periodic assessment of the identified risks will similarly distort the picture as prioritization based on outdated information might be detrimental to creating stability (e.g. van der Horst & Beulens, 2002). It might also be relevant to analyze where within the company the risk identification and risk assessment take place – if it is performed close to the risk (within the domain) or from a distance (outside the domain).

Supplier Risk Management

Finally, supplier risk management is investigated as a separate element in the overall risk management analysis¹². Especially the perspective on single versus dual/multiple sourcing is relevant (e.g. Chopra & Sodhi, 2004; Martha & Subbakrishna, 2002) but also flexibility in sourcing arrangements (e.g. Rice & Caniato, 2003; Lee & Wolfe, 2003) is important. The focal element in this analysis is whether or not a segmentation model is used as a structured way of selecting, evaluating, and developing suppliers (see e.g. Kraljic, 1983; Bunn & Liu, 1996; Zsidisin, Panelli, & Upton, 2000; Harland, Brenchley, & Walker, 2003). Using

¹⁰ See Figure 2-11.

¹¹ In case management of a specific risk was addressed by a change to a process, the risk management process is not observable after implementation. In contrast the sub-processes Risk Identification and Risk Assessment will most likely be directly observable.

¹² As mentioned elsewhere the choice was made to focus upstream.

supplier segmentation models thereby might support differentiated management of suppliers potentially enabling a differentiated approach towards supply (chain) risks¹³. Besides segmenting and performing differentiated management of the supplier portfolio, external audits of operations might shed some light over risk mitigation in inter-organizational systems. As each company is victim to the performance of each of its critical suppliers the procedures for supplier auditing is deemed relevant for the analysis of risk management practices (e.g. Zsidisin et al., 2004).

The Resulting Set

From the categories above the following list of high-level constructs is derived:

Table 6-4: SCRM Constructs

Construct	Description
Risk Management Organization	Describes how the company has organized around the task of performing SCRM.
Risk Types and Management Efforts	Describes the types of risks (from the Supply Chain Risk Matrix) acknowledged and the associated management effort.
Risk Identification and Assessment	Describes the sub-practices of risk identification and assessment.
Supplier Risk Management	Describes how supply risks are managed.

6.2 Case Selection

The next step in designing the case study is to select cases:

“When using a multi-case design, a further question you will encounter has to do with the number of cases deemed necessary or sufficient for your study. However, because a sampling logic should not be used, the typical criteria regarding sample size also are irrelevant. Instead, you should think of this decision as a reflection of the number of case replications – both literal and theoretical – that you would like to have in your study.” (Yin, 1994, p. 50).

As no rival theories are defined *per se*, external validity is the main driver for the number of theoretical replications:

“When you are uncertain whether external conditions will produce different case study results, you may want to articulate these relevant conditions more explicitly at the outset of your study and identify a larger number of cases to be included.” (Yin, 1994, p. 50).

External conditions must therefore be explicated to ensure appropriate case selection.

6.2.1 External Conditions (for SCM and SCRM)

Conditions relevant to the practices of SCM and SCRM may include:

1. the size of the company might have an impact on the resources available for staff functions,
2. the number of direct competitors and the history of competition might influence the need to lock in critical suppliers (and customers),

¹³ See Chapter 3.3.2 for a discussion of supply (risk) management.

3. recent accidents might impact resource allocation, increasing the focus on risk management,
4. the complexity of internal processes might increase the awareness of complexity in the environment and thereby impact the risk management practice, and
5. the nature of inputs (simple versus complex, or standard versus unique) might influence the supplier base and thereby the SCM practice, and furthermore the perception of supply risks.

Albeit this list is undoubtedly incomplete it introduces too many variables. The first examples are justified by an assumption of larger companies having more resources available (e.g. Chopra & Sodhi, 2004) and might have a longer time horizon on investments in processes and technologies. whereas the fourth and fifth are based on an assumption of higher levels of complexity require more risk management (e.g. Harland, Brenchley, & Walker, 2003; Ottesen & Gronhaug, 2002e; Perrow, 1984). From a SCM perspective the fourth argument might be relevant due to the need for precision of internal processes when dealing with unique/complex inputs (here it is assumed complexity in input leads to segmentation of supply market – basically the specialization argument, see Gripsrud, Jahre, & Persson (2006)). The last example points towards ‘internal SCM’, assuming internal integration support complexity in processes (e.g. Storey et al., 2006; Simatupang & Sridharan, 2005). The second and third examples do not combine SCM with SCRM and may thereby be removed from the list. External conditions (subjectively chosen) for this study are thereby:

- External Condition 1: Size of Company.**
- External Condition 2: Complexity of Processes.**
- External Condition 3: Complexity of Inputs.**

Recruiting SCM Companies

Furthermore it is deemed critically important to include “Best in Class Supply Chain Management” companies in the convenience sampling as to ensure variation across the case companies. A corresponding variation across SCRM practices would have been preferable, but none such mechanism could be identified. Therefore only a fourth (and not a fifth) condition is added to the list above:

- External Condition 4: SCM Award Winning Company.**

Due to the use of analytical generalization (in contrast to statistical generalization, see above) each external condition is evaluated separately. For each external condition the convenience sample should contain at least 2-3 cases to allow for variation within each group. Weighing

this argument against the level of existing knowledge and the effort needed for each case (e.g. Eisenhardt, 1989b; Dyer & Wilkins, 1991) a convenience sample size of ten case companies is considered sufficient.

6.2.2 Case Selection Method

The convenience sampling must be performed in a manner ensuring above mentioned criteria are met. As only two ('Size' and 'SCM Award') of the four external conditions are readily available "from outside the company" the classification process is split in two, see Figure 6-2 below.

Figure 6-2: (An Iterative) Case Selection Method

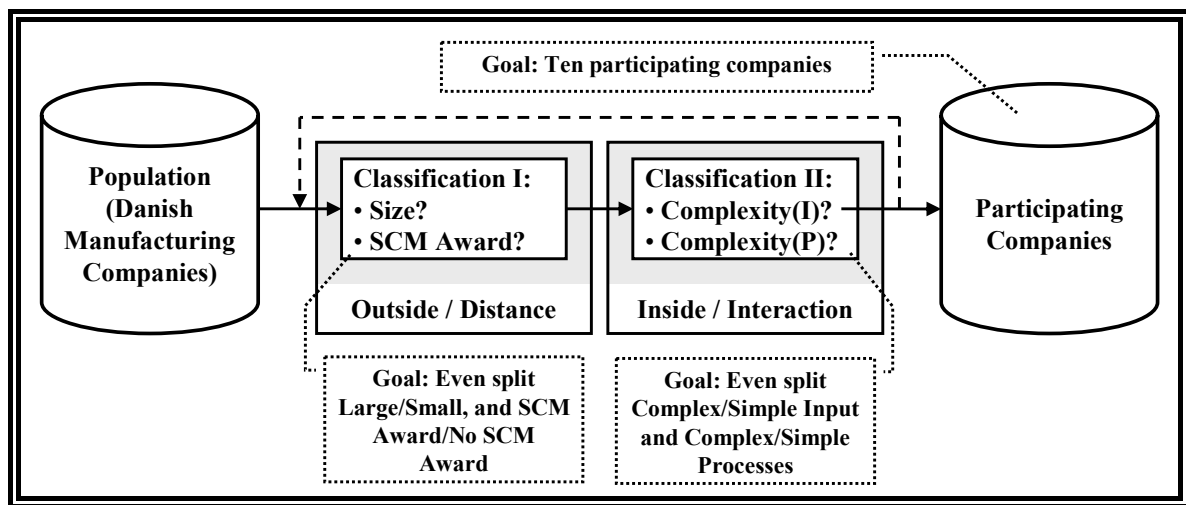

As shown in the figure above the case selection method is thereby iterative as the second evaluation needs to be performed before another company can be included. Companies are therefore included one at a time.

Case Selection Process

In order to meet the fourth external condition half the companies were picked from the lists of award winning companies, winning either The Danish Logistics Award or The Post Denmark Logistics Award. The former is depicted in Table 6-5 below, the latter in Table 6-6 (participating companies are highlighted).

Table 6-5: The Danish Logistics Award¹⁴

Year	Company
2005	Vest-Wood A/S
2004	Netto A/S
2003	Oticon A/S
2002	LK A/S
2001	Grundfos A/S
2000	Arla Foods A/S
1999	Carlsberg A/S
1998	Olicom A/S
1997	Coloplast A/S
1996	Bang & Olufsen A/S
1995	Voss-Atlas A/S
1994	Herning Galvanisering A/S

Table 6-6: The Post Denmark Supply Chain Award¹⁵

Year	Large Company	Small or Medium-sized Company
2005	Fritz Hansen A/S	Bolia.com
2004	LINAK A/S (manufacturing)	Skagenfood A/S
	Sanistål A/S (trading company)	
2003	Gate Gourmet Scandinavia (manufacturing)	Dekra Automotive Services A/S (trading)
	Coop Denmark A/S (trading)	

For each of the companies the remaining three external conditions are determined according to the following guidelines.

Criteria for Size

Albeit revenue is the standard measure for size¹⁶ the SCM context calls for a more structural argument for size. The following variables are used to determine size:

- Number of Local HQ's (Hubs)
- Number of Subsidiaries / Sales Offices
- Number of Distributors / Representatives

Table 6-7 below contains the result of the classification for size.¹⁷

¹⁴ Source: www.logistikkonferencen.dk.

¹⁵ Source: www.supplychainprisen.dk.

¹⁶ The definition of SME used within EU uses number of employees and either turnover or balance sheet total. For more info, please see Szabo (1998).

¹⁷ The reason for the two groups (large and small) not being equal in size (six large and four small companies) is due to the need to "balance" according to the other two variables, and due to delayed confirmation of participation from another two case companies (who ended up declining the invitation to participate).

Table 6-7: Classification for Size¹⁸

Company	No of local HQ / hub ?	No of subs / sales offices ?	No of distributors / representatives ?	Other ?	Size
Bang & Olufsen	2	30	20	Prod., Show Rooms	Large
Brüel & Kjær	8	48	77	Service Centers	Large
Coloplast	3	26	49	Production	Large
Dyrup	0	8	15	Production	Large
Fritz Hansen	0	7	400	Show Rooms	Small
Linak	1	26	7	Production	Large
Novozymes	0	18	0	Production	Large
Oticon	1	15	72	Production	Small
RIEGENS	(1)	2	0	Production	Small
SDC Group	0	5	0	Production	Small

Criteria for Complexity

As mentioned previously the inclusion of companies were based on a preliminary evaluation of complexity in input and processes. As both of these criteria need a more thorough analysis access to the company is a pre-requisite for classification. Upon obtaining access to the case company evaluating inputs and processes for complexity should be possible. But since no generally acceptable constructs for measuring complexity in neither input nor process was identified, the classification is left to the subjective choice of the researcher.

6.2.3 Learning Points

One of the first learning point was the (in hindsight) obvious fact that complexity in process might vary greatly across supply chains. And since a company might (and certainly many do) participate/have multiple supply chains, the model needs to distinguish between supply chains. Pondering the criteria for determining whether there are three or four supply chains (or business models) in a company reveal that the case studies challenge the classification. As described in Gardner & Cooper (2003) the exercise of mapping a number of supply chains might result in numerous iterations ultimately leading to either despair or a simpler model than desired. A second learning point was that complexity in process might not be that easily described ('Simple' or 'Complex'). In several companies the process performed by the technology is deeply complex and relies on extreme precision. In these cases, complexity is embedded in the manufacturing process, whereas the process as understood in a SCM context (see Chapter 8.1.2 for a thorough discussion of the term process) is simplified as a direct result.

Classifying the Case Companies

For each supply chain the complexity of input and process were evaluated, see Table 6-8 below.

¹⁸ Analysing the companies by turnover and number of employees would place Brüel & Kjær in the group of smaller companies. The rest of the companies would not change classification.

Table 6-8: External Conditions per Supply Chain

Company	Size	Supply Chain(s)	Input	Process	SCM Award
Bang & Olufsen	Large	All	Complex	Simple	Yes
Brüel & Kjær	Large	'Project Sales' & 'Customer Project'	Complex	Complex	No
		All Other	Complex	Simple	
Coloplast	Large	All	Simple	Simple	Yes
Dyrup	Large	All ¹⁹	Simple	Simple	No
Fritz Hansen	Small	All ²⁰	Simple	Simple	Yes
LINAK	Large	All	Simple	Simple	Yes
Novozymes	Large	All ²¹	Simple	Complex (embedded)	No
Oticon	Small	All	Complex	Complex (embedded)	Yes
RIEGENS	Small	'Project'	Simple	Complex	No
		All Other	Simple	Simple	
SDC DANDISC	Small	All	Simple	Complex (embedded)	No

In order to obtain one set of external conditions per case company the above listed values are manipulated in the following ways:

1. The 'Process' construct is split into two constructs 'Process' and 'Manufacturing Process', the latter describing the complexity of the manufacturing process. As a result, both constructs can hold the values 'Simple' and 'Complex'.
2. For each company having more than one supply chain, the most "advanced" value is kept. For Brüel & Kjær, for instance, the company ends up with the values 'Large', 'Complex', 'Complex', and 'Simple' (for the external conditions 'Size', 'Input', 'Process', and 'Manufacturing Process', respectively).

Table 6-9 below holds the resulting set of external conditions per company.

Table 6-9: External Conditions per Company

Company	Size	Input	Process	Mfg. Process	SCM Award
Bang & Olufsen	Large	Complex	Simple	Simple	Yes
Brüel & Kjær	Large	Complex	Complex	Simple	No
Coloplast	Large	Simple	Simple	Simple	Yes
Dyrup	Large	Simple	Simple	Simple	No
Fritz Hansen	Small	Simple	Simple	Simple	Yes
LINAK	Large	Simple	Simple	Simple	Yes
Novozymes	Large	Simple	Complex	Complex	No
Oticon	Small	Complex	Complex	Complex	Yes
RIEGENS	Small	Simple	Complex	Simple	No
SDC DANDISC	Small	Simple	Complex	Complex	No

Participation

Even if most invited companies accepted the invitation almost all had concerns. First of all the workload for the companies is non-trivial. Insisting on interviewing key personnel was a

¹⁹ Actually another supply chain exists but since it's quite marginal it's left out.

²⁰ The production of very expensive (primarily wooden) products is best described as crafts-based production. The other two supply chains differ in distribution solution alone.

²¹ The two supply chains are identical in respect to external conditions.

cause for discussion in several of the companies. A second (and perhaps the most critical) concern was the subject of the research project: some companies were reluctant (to say the least) to share information on their risk management practices²². Once recruited to the study, though, each company appeared to be quite committed.

6.3 Design of Data Collection Protocol

As illustrated in Figure 6-1 the next step is to design the data collection protocol. For studies of exploratory nature the use of semi-structured interviews is uncontroversial; to that end a questionnaire containing mostly open-ended questions is developed. The purpose of the questionnaire is to enable an understanding of each case company on the defined constructs as well as collect other background information. A part of the questionnaires is thereby directly linked to the high-level constructs described in Chapter 6.1.

The Questionnaire(s)

Following the obligatory test of the questionnaire it becomes apparent the questionnaire needs to be further developed. The exploratory nature of the study combined with complexity of the phenomena under investigation and the inter-organizational nature of SCM calls for empirical triangulation (Yin, 1994, p. 92). Within each company the persons responsible for SCM and Purchasing (respectively) are chosen as interviewees²³. The original questionnaire is kept more or less unchanged (see Interview Guide I in Appendix G.1), and two more questionnaires are developed: one oriented towards the more detailed issues within Purchasing (Interview Guide II – Appendix G.2) and another focusing on the appropriateness of the SCM and SCRM practices (Interview Guide III – Appendix G.3). Interview Guide I is used with both SCM and Purchasing staff, but the interview within Purchasing is further supported by Interview Guide II. The last interview guide is used with both groups²⁴.

Two Rounds of Interviews

Due to the sensitivity of the research subject it was a priority to try and establish a “safe environment” for the interviewees by e.g. motivating them to share their experiences of “near misses” or discuss commonly known cases and drawing parallels to the case company. In the initial stage of the data collection therefore only Interview Guides I and II were used – and at the slightest hint of conflict or uneasiness the interviewer would change topic (within the frame of the interview guide). Following each of the initial interviews the researcher would place a telephone call to clarify some detail thereby offering another opportunity to strengthen the relationship between researcher and interviewee. Also this would constitute an opportunity to clarify any information shortages resulting from the above mentioned process. Only later in the project once a relationship was established the interviewee would be more

²² When presented the subject of the research project and the preliminary interview plan three potential companies declined.

²³ In a few of the case companies a larger group of employees have participated in the study. A complete list of interviewees and interviews is presented in Appendix H.

²⁴ See Appendix G for details.

directly confronted with “tough questions” (Interview Guide III). Table 6-10 below shows how the interview guides were applied during the two rounds of interviews.

Table 6-10: Application of Interview Guides²⁵

Round	Interview Guide	SCM Interviewee	Purchasing Interviewee
1	I: SCM & SCRM Practices	Yes	Yes
	II: Supply Risk Management		(Yes)
	III: Appropriateness of Current Practices		
2	I: SCM & SCRM Practices	(Yes)	(Yes)
	II: Supply Risk Management		Yes
	III: Appropriateness of Current Practices	Yes	Yes

Validating the Information

Before interviews are conducted background information is collected by the use of various sources: trade journals, media databases (e.g. Info-media), company databases (e.g. Amadeus), annual accounts, and published case studies on the selected companies (e.g. Bernhard, 1988; Helbo, Jakobsen, & Gammelgaard, 2004). In order to ensure validity whenever possible “proof” of statements from the interviewees is sought – in the form of organization charts, process documentation, external reviews etc. Also the two sources of information (SCM and Purchasing staff) are validated against each other and against alternative sources of information available. In case of discrepancies, focused attention is given to those issues during the second round of interviews.

6.4 Documenting the Cases

The last step before the cross-case analysis is to write up the case study reports. Again referring to the exploratory nature of this study the case reports are aiming at creating an understanding of the company as each company is perceived as a unique entity with unique attributes and explanations. The case reports may therefore differ from each other, both in length and structure, but will all contain the following information: an outline of the company history, a description of the range of products or the technology central to the company, recent developments as well as a view of the financial situation. Furthermore each case naturally describes the current SCM and SCRM practices.

²⁵ Not in all companies this quite time consuming procedure could be adhered to. Please refer to Appendix H for a complete list of interviews.

Chapter 7 Case Studies

The purpose of this chapter is to describe the case studies. Each case study will contain a (brief) explanation of the company's history and an overview of the main financial key figures. This introduction is followed by a more thorough description of the practices within SCM and SCRM. The descriptions of the practices vary from case to case but the description of the SCM practice contains a description of the underlying production philosophy (where possible) and a graphical representation (a SCM Diagram) of the supply chain(s) identified¹.

Sources of Information

The major sources of information are naturally the interviewees within each case company. The historical element in the description of the companies in this chapter is based on information supplied by the companies themselves, Bernhard (1988), and an analysis of the business periodical "Børsens Nyhedsmagasin". For some of the case companies information on the purchasing practice is derived from Helbo, Jakobsen, & Gammelgaard (2004). Specific issues are investigated using the media database INFOMEDIA². Financial data is from Amadeus³ (updated 2006-07-16).

¹ The SCM Diagrams focus on the structural aspect i.e. the participants in the chain. This is naturally a trade-off against other parameters like product types or demand patterns (to name a few) – but a necessary one as complexity makes it impossible to include all relevant factors.

² For more, please refer to www.infomedia.dk.

³ For more, please refer to amadeus.bvdep.com.

7.1 **Bang & Olufsen A/S**

The company's founders Peter Boas Bang and Svend Andreas Grøn Olufsen met during their studies in the early 1920's at Århus' Electro Technical School, and quickly realized that they shared a common interest in radio technology. A few years after their studies, the two engineers met up again and after some initial experiments the company Bang & Olufsen a/s was founded on November 17th, 1925.

Growth & Crisis

Up to the Second World War the company grew steadily. The German occupation and the restrictions on imports were constraining the company, but these inconveniences were incomparable to the bombing and destruction of the factory on February 14-15th, 1945. Construction drawings and models had been moved to safekeeping in private homes, and construction of a new factory started the following day. After the war sales increased rapidly as restrictions gradually were removed. During the 1950s the product portfolio grew to contain televisions, microphones and gramophones. Following the debate on joining the Common Market, Bang & Olufsen decided to direct its attention toward the European market. At the same time, the product designs received massive criticism which ultimately led to the company's renowned cooperation with famous designers. During the 1960's the wide spread net of agents established previously was reduced, replacing agents by subsidiaries. The internationalization was supported by e.g. "The Seven CIC's" (Corporate Identity Components) describing the company's goals and personality. The 1970's saw the introduction of "The Beocenter Group", an initiative aiming at creating a dedicated, voluntary chain of specialty shops, more closely cooperating with Bang & Olufsen. In return for their loyalty and agreement to following certain design and layout instructions, the shops obtained a number of benefits. Amongst other dramatic changes, the customer focus was changed from the exclusive clique of Hi-Fi enthusiasts to all music lovers – a new and far larger target group. During the 1980's competition from Asia threatened the company through declining loyalty from the distribution network and falling revenue (Groes, 1991). The company reacted too slowly to the crisis and the funds ran out. In the end, new funds had to be raised through a strategic alliance with Philips. Those funds quickly ran out as well.

New Management

In May 1991, the Board installed a new management team headed by Anders Knutsen. The first priority was to cut costs, and to do it quickly (Vestergård, 1992b). The plan "Break Point 1993" aimed at re-vitalizing B&O and securing its independence – and it was efficient. To minimize costs and increase flexibility stock keeping at the subsidiaries was eliminated, the production paradigm was changed from make-to-stock to make-to-order and the distribution strategy was changed to direct distribution. Staff was cut in the subsidiaries, central staff functions re-created, and a number of executives were laid off. Already in 1993 the company was making money, and the surplus was doubled the following year (Højbo, 1996). Further efficiencies were obtained through focused outsourcing. This extensive restructuring of the

logistics system earned the company the Danish Logistics Award in 1996⁴. By 1997 the company had consolidated its earnings and was able to buy back the 25% of the shares sold to Philips in 1991, and by 1999 the company decided to focus on USA as the next big market for its products (Evert, 1999).

Financial Status

When Anders Knutsen in 2001 chose to resign as CEO, he handed over a company in good shape to his successor. The financial results in the last 2-3 years of his leadership were not as impressive as the first years at B&O, but this was primarily due to very large but essential investments (Bundgaard, 2001). When looking at the turnover, profit and number of employees for the past five years, it seems the turbulence has subsided, see Table 7-1 below.

Table 7-1: Financial Profile – Bang & Olufsen A/S⁵

End Date	Turnover	Profit Before Tax	No. of Employees
2005-05-31	3.742.200	387.100	2.311
2004-05-31	3.612.700	340.500	2.717
2003-05-31	3.974.200	290.100	2.803
2002-05-31	4.212.000	225.600	2.908
2001-05-31	3.810.000	224.100	2.780
2000-05-31	3.722.400	316.800	2.783

Outsourcing Electronics

Following a series of organizational changes Bang & Olufsen sent out a press release on March 18, 2004, explaining how the electronics factory in Skive had been sold to Flextronics⁶, a supplier for more than 10 years. Ownership to buildings and equipment was to be completed by the end of the month at the same time as the employees were formally being transferred to their new employer. Bang & Olufsen had decided it was no longer in the electronics manufacturing industry, and had therefore decided to let others manage these activities⁷. In the press release John Bennett-Therkildsen (Director, Operations - Bang & Olufsen) explains:

“In today’s competitive global marketplace, we see the need to work closely with a company like Flextronics because we believe that by using their world-class EMS [electronic manufacturing services] capabilities, they will be able to help us fulfill our objective in strengthening the profitability and agility of our company, and in addition, we believe that this is a great way of ensuring long-term survival of the electronics factory in Skive. For these reasons, transferring the factory to Flextronics makes obvious strategic sense.”

⁴ For more info, please see www.logistikkonferencen.dk.

⁵ Figures in thousands DKK.

⁶ For more info, please see www.flextronics.com.

⁷ The activities taken over by Flextronics represent approx. 65% of the value of electronics components used by Bang & Olufsen. Another 15-20% is supplied by a long term partner in Malaysia. The remaining 10-15% is supplied by various suppliers, as special competencies/technologies are required.

As part of the overall transaction the two companies entered into a five-year manufacturing agreement with projected annual value of DKK 510 million. To Flextronics, taking over the factory in Skive is quite an opportunity. In the press release Mike McNamara (Chief Operating Officer – Flextronics) is quoted:

“We believe this long term agreement makes both strategic and financial sense as it builds on a long-standing relationship between the two companies. ... Additionally, this provides Flextronics with a potential opportunity to expand our business relationship by increasing our service offering to Bang & Olufsen and other Danish companies. From a financial standpoint, it makes sense because we receive a long-term manufacturing agreement with all of the required contractual protections for acquiring a facility from a customer while providing us with our required return on invested capital and an operating margin in excess of our expected EMS average because of the complexity of the product build.”

The uniqueness of the competencies at the factory is well recognized, in the press release Peter Thostrup (Executive Vice President - Bang & Olufsen) states:

“It is, of course, an important decision to transfer a factory like Skive. The factory possesses unique competencies as well as dedicated employees who have served Bang & Olufsen for many years. However, we believe the partnership with Flextronics will provide the factory with the best possible opportunities to retain and enhance its competitiveness.”

The outsourcing of this vital part of the manufacturing process is thereby done with the full recognition of the magnitude of change. The core competence of the company is no longer the manufacture of cutting edge products, Steen B. Jørgensen (Director, Logistics - Bang & Olufsen):

“We are no longer a manufacturing firm, in the old sense of the word. Our core competence is treatment of aluminum surfaces – a competence which is unchallenged in the world. ... In reality, for a long period of time we were in a market where we could not compete, we produce in way too small batch sizes to ever obtain economies of scale.”

More or less at the same time as the transfer of the electronics factory, a part of the assembly of mechanical parts was moved to a newly created factory in Slovakia.

Product Portfolio

Where the operations thereby have been simplified, the product portfolio has been extended. Today the product range covers music systems, televisions, loudspeakers, as well as telephones and IT-related products (e.g. BeoPlayer™ and BeoLink PC2™). Furthermore Bang & Olufsen has diversified into related business areas like ICEpower⁸ (design and manufacture of amplification and modulation components) and unrelated like Bang & Olufsen Medicom⁹ (compliance devices like tablet dispensers, inhalers, injection systems etc.) (Erhardtson, 2000). Furthermore existing products are being applied in new contexts as Bang & Olufsen recently entered the luxury yacht installation business, and entered into

⁸ For more info, please see www.icepower.bang-olufsen.com.

⁹ For more info, please see www.medicom.bang-olufsen.com.

partnerships with car manufacturers like Ferrari and Audi. The latter example actually draws on the competence of the related diversification as ICEpower technology is used in producing the components for the audio solution for the Audi A8.

Organization

Figure 7-1: Organization Chart – Bang & Olufsen Group¹⁰

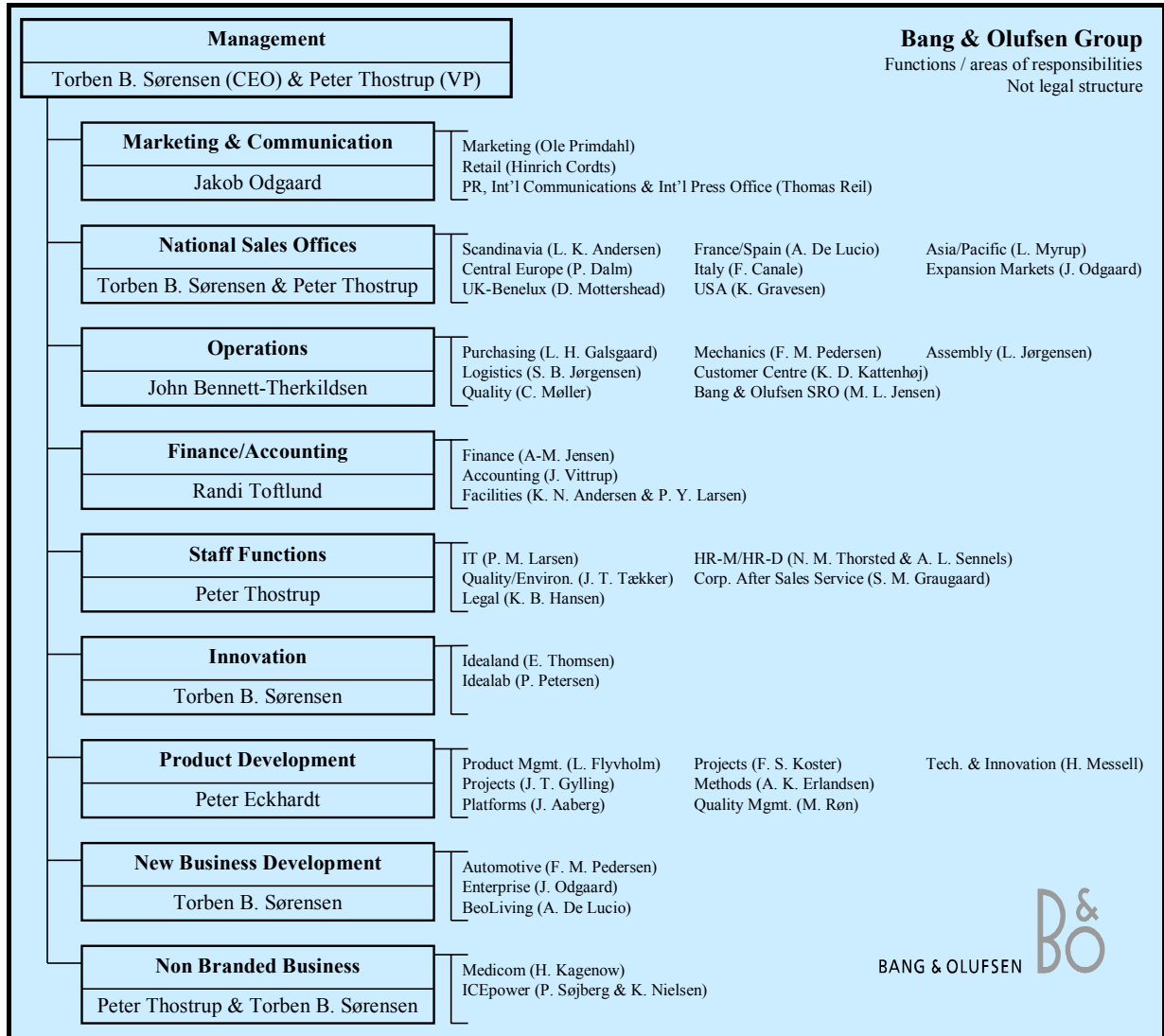

Still based in Struer, the organization shows a strong commitment to innovation as the company has not only a department for Product Development, but also for Innovation, and New Business Development, the latter two being under the direct management of Torben B. Sørensen (CEO) (see Figure 7-1 above).



Purchasing, Logistics, Assembly, Customer Service etc. are co-located under Operations, whereas Sales is placed under National Sales Offices and Marketing is co-organized with Communication. The Slovak plant is placed under Operations.

¹⁰ Source: Peter S. Hune, Bang & Olufsen.

Supplier Management

With the reconfiguration of the company and the outsourcing of activities came a need to radically reduce the supplier base.

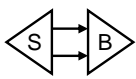
Figure 7-2: Bang & Olufsen's Supplier Segmentation Model¹¹

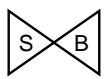
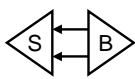
KEY SUPPLIER	SYSTEM SUPPLIER
<p><u>Product characteristics:</u></p> <ul style="list-style-type: none"> – Technologically complex products with complex interfaces (OEM products) – Technological development can not easily be influenced <p><u>Market characteristics:</u></p> <ul style="list-style-type: none"> – Market-driven component development and price – Concentrated market with few established players <p><u>Supplier characteristics:</u></p> <ul style="list-style-type: none"> – Large companies and few alternatives – B&O is a very small customer <p><u>Competence characteristics:</u></p> <ul style="list-style-type: none"> – Supply interface – Technological competence – Absorption competence 	<p><u>Product characteristics:</u></p> <ul style="list-style-type: none"> – B&O specified items – Complex supply (in terms of production or management) <p><u>Market characteristics:</u></p> <ul style="list-style-type: none"> – Development is driven by B&O's requirements. Ideally by several similar customers – Few/no alternative suppliers when the supplier is chosen for a task <p><u>Supplier characteristics:</u></p> <ul style="list-style-type: none"> – B&O accounts for a large proportion of the supplier's turnover – Typically relatively small companies <p><u>Competence characteristics:</u></p> <ul style="list-style-type: none"> – Integrative interface – Relationship competence – Joint development competence 
STANDARD SUPPLIER	CAPACITY SUPPLIER
<p><u>Product characteristics:</u></p> <ul style="list-style-type: none"> – Technological products but with simple interfaces – Highly standardised products and services – Low engineer input and expertise required <p><u>Market characteristics:</u></p> <ul style="list-style-type: none"> – Stiff competition on the market – Several suppliers able to supply <p><u>Supplier characteristics:</u></p> <ul style="list-style-type: none"> – Low switching costs – Low negotiation power <p><u>Competence characteristics:</u></p> <ul style="list-style-type: none"> – Simple interface – Production competence – Flexibility competence 	<p><u>Product characteristics:</u></p> <ul style="list-style-type: none"> – Standard process with well-defined interfaces – B&O-specified items where the process is market-driven <p><u>Market characteristics:</u></p> <ul style="list-style-type: none"> – The price is determined by cost – B&O often accounts for a small proportion of the supplier's turnover <p><u>Supplier characteristics:</u></p> <ul style="list-style-type: none"> – Large or small companies, but several suppliers – Low negotiation power – High dependence on B&O <p><u>Competence characteristics:</u></p> <ul style="list-style-type: none"> – Transfer interface – Flexibility competence – Know-how transfer competence – Transfer of process know-how 

When interviewed in 2004 Klaus K. Knudsen (Director, Purchasing) explained:

“Earlier suppliers were often selected by developers based on either a need for a very specific component, or due to the product developers preferences, he might have worked with the supplier in a previous job. There were no incentives to reduce the supplier base, so it just kept growing. ... At the time I

¹¹ Source: Bang & Olufsen. See also Møller (2003).

started in this job, the purchasing department had lost control over the supplier portfolio, and we needed to get an overview.”¹²

A supplier segmentation model was put in place in 2001, categorizing the suppliers based on the investments made by the supplier and Bang & Olufsen, see Figure 7-2 above. The horizontal axis in the model represents the suppliers' investment, the vertical B&O's investment. Standard suppliers are thereby suppliers of commodities where neither the supplier nor B&O make specific investments. Conversely, System suppliers deliver B&O specified complex components or sub-systems based on investments on both parties. Besides the investment categories, each cell has a number of distinct characteristics on Product, Market, Supplier, and Competence¹³. Each supplier belong to one of the categories in the model above – and for each supplier the four stakeholders Supply, Quality, Cost, and Technology¹⁴ must work together to ensure an optimal sourcing solution.

Before the segmentation model the purchasing department perceived almost all suppliers as either Key or System suppliers, but the analysis revealed the opposite was the case. Most suppliers were either Standard or Capacity suppliers, and it was realized that resources had been spent on building and sustaining relationships with the wrong suppliers. Having fewer than expected Systems or Key suppliers in the portfolio was a pleasant surprise, though, Klaus K. Knudsen comments:

“When relying on an external partner you trade off control for cost. ... We have had Systems suppliers for many years, so we are used to living with the uncertainty. Within the last couple of years, we’ve ‘survived’ two fires at our suppliers, and one bankruptcy – you really validate if procedures are in place when these things happen.”

Relying on e.g. Philips for components for a number of important products does not seem to constitute a problem:

“We rely on Philips to supply these critical components, but there’s no alternative. We might choose another supplier but then we probably would have to redesign our product. But when we look for components for a new product we obviously try to avoid introducing new sole/single suppliers to the supplier base. We try to minimize the number of suppliers in the top two cells of the model”.

The model was subsequently modified several times, and is today the fundamental framework for supplier management at Bang & Olufsen.

¹² According to Helbo, Jakobsen, & Gammelgaard (2004) Bang & Olufsen in 1993 had 1000 suppliers of direct inputs. Today the company has less than 300.

¹³ Confronted with the possibility that the characteristics of a supplier “not fitting” the model, Klaus Knudsen comments that it is quite rare the characteristics point towards more than one cell. In his experience the product characteristics leads to the Market, Supplier, and Competence characteristics, at least in the medium to long run.

¹⁴ The four stakeholders translate into the following departments: Supply = Logistics (Operations), Quality = Quality (Operations), Cost = Purchasing (Operations), and Technology = Technology & Innovation (Product Development), see Figure 7-1.

Sourcing Strategy

When describing the sourcing strategy, Peter S. Hune (Senior Manager, Purchasing) makes direct reference to the segmentation model:

“We believe we should always have a readily accessible alternative source for input from Standard and Capacity suppliers. When we are dealing with Key and System suppliers we are often dealing with either single or sole sourcing, and in this area we are currently changing attitude. Whereas we earlier were reluctant to change supplier we are now working on altering our procedures to perform a thorough performance evaluation and supplier selection prior to putting any product in production. By doing so, we hope to reduce dependency to one supplier – and to not put ‘all our eggs in one basket’.”

Continued Outsourcing

Albeit the intent is to minimize the number of supplier in the top two cells of the segmentation model, the current trend is to outsource more and more complex tasks/components, unavoidably creating further dependencies. The shift is primarily taking place from the Capacity supplier segment to the System supplier segment, outsourcing B&O specific items. The intent of this continued outsourcing is to simplify internal operations as System suppliers are expected to manage their own supply chains, Peter S. Hune:

“By shifting from Capacity suppliers to System suppliers we end up with less inventory as System suppliers are expected to manage their own supply chain. ... We really have no choice but to outsource more, as the number of variants is increasing.”

Peter S. Hune goes on to explain how the spare parts guarantee varies from product group to product group, and how the burden of keeping stock for the spare parts guarantee is shifted to the supplier when possible. He foresees further outsourcing changing the current status of the supplier base (18 Key suppliers, 17 System suppliers, 115 Standard suppliers, and 132 Capacity suppliers). So, relying on single or sole suppliers are more or less “the rules of the game” to Bang & Olufsen, putting pressure on the Purchasing department to ensure stability in input at the same time as cost must be kept under control.

Inventory Management

One way of dealing with these uncertainties is of course to build inventory, but as input gets more and more complex the value of the inventory increases dramatically. Therefore the use of inventory as a means to handle uncertainty is less of an option for Bang & Olufsen than for other companies¹⁵. If Bang & Olufsen for instance had the possibility to implement modularity in their products to any extent, the inventory costs might be more reasonable. But since this is not an option, Bang & Olufsen more and more often asks the suppliers to hold this stock.

¹⁵ The use of inventory as a means of insurance has a special meaning at Bang & Olufsen as they offer a 12 years spare parts guarantee. Previously when a product was taken out of the product portfolio, spare parts were bought from suppliers and stored in special containers. Today, Bang & Olufsen has differentiated the spare parts guarantee by product class, and tries to persuade suppliers to hold this inventory.

Supplier Evaluation

To ensure this inventory is managed in a reasonably manner, and to ensure stable production, potential suppliers are visited and evaluated according to a framework (see Figure 7-3 below).

Figure 7-3: Bang & Olufsen’s Basic Risk Assessment Questions¹⁶

<p>Risk Assessment of suppliers</p> <p>Questions:</p> <ol style="list-style-type: none"> 1. Does the company have a Risk Management function with delegated responsibility? 2. Does the company have a Risk Report? <p><u>Production area</u></p> <ol style="list-style-type: none"> 3. Are the production areas divided into independent fire sections? 4. Has an automatic fire alarm with transmission to the fire brigade been installed? 5. Has an automatic fire ventilation been installed in the roof? 6. Is there a doubling of important production equipment? 7. Are identical production lines (or lines which can be readjusted) placed in several independent fire sections or on other addresses? 8. Are the tools that are not in use placed in an independent fire section? 9. Are there any external production possibilities or another producer with whom an agreement has been made about mutual assistance in case of loss of production capacity? <p><u>Stocks</u></p> <ol style="list-style-type: none"> 10. Does the stocks constitute any independent fire sections? 11. Has an automatic fire alarm with transmission to the fire brigade been installed? 12. Has an automatic water sprinkling system with alarm transmission to the fire brigade been installed? 13. Has an automatic fire ventilation been installed in the roof? 14. Have the stock been physically secured against theft and with alarm to a protection agency? 15. Has the company carried out a corresponding analysis of its own suppliers, and what was the result of the analysis? <p><u>Consequence of stop in business operation</u></p> <ol style="list-style-type: none"> 16. If the worst thinkable damage occurs in your company, including failure of any possible precautionary measures, how long time will it take before you are capable of supplying to the full extent? 17. Has a minimum stock been build up? If yes, how long time will it cover? Where is the storehouse situated in proportion to the production area? Has this been included in your answer to item 16? <p>03.06.02/PDA</p>

The framework was developed by Kim B. Hansen (Legal Council):

“The framework is the result of years of work, albeit it is still a ‘work in progress’. The intent is to map out the problem areas, primarily in inventory management and production. ... Actually the framework was developed for

¹⁶ Source: Bang & Olufsen.

use in our own plants as this was my primary responsibility earlier, but it obviously has relevance for dealing with suppliers as well.”

When interviewed in 2004, Klaus K. Knudsen and Peter S. Hune explained how the risk assessment has relevance in supplier management:

“The questionnaire is used to identify problem areas, and to assess the severity of the problems. At this time we have not integrated this tool in the segmentation model, but we routinely visit the suppliers. The original questionnaire was developed further to include e.g. questions on the suppliers practice on Risk Management.”

When interviewed in 2005, Peter S. Hune explains how the framework is used primarily upon supplier selection:

“The yearly evaluation is basically a desk job – we do not have to go and visit the suppliers. But for some of the most critical supplier we go anyway, and in that case we naturally use the framework as a tool...”

Albeit not used systematically in the purchasing department the questionnaire does add value when discussing potential for improvement with suppliers.

Measuring Severity

The measure of severity is the same internally as externally, days of interruption, but besides the benefit of knowing the risk exposure and using that to direct attention and enforce changes, there's another, more directly measurable impact of performing the supplier certifications, Kim B. Hansen:

“When we visit critical suppliers, we often go together with representatives from our insurance company. The consequence of implementing corrective measures and negotiating changes to routines at the suppliers' is a reduction in insurance premium – the 'safer' suppliers we have and the better we know them, the lower the cost of insurance.”

Identifying the critical suppliers is therefore an important task, which is done in a procedure containing several steps:

1. First the product portfolio is analyzed to find the products contributing most to turnover.
2. Then suppliers to these products are identified, and the inputs are analyzed to create a list of non-commodity items.
3. From this list each supplier is evaluated to find out time required to redesign the finished product or to find an alternative solution.
4. Finally an impact value is put on each supplier and the suppliers are ranked, creating a prioritized list of suppliers (and critical items).

Having identified the critical suppliers, the before mentioned questionnaire (shown above in Figure 7-3) can be applied.

Being a Small Customer

But not all suppliers volunteer their participation in these assessment schemes, Klaus K. Knudsen comments:

“We are in the unpleasant situation that in certain segments we are dramatically smaller than our suppliers. E.g. when we buy components from Philips, we are forced to try to remain an attractive customer. The easy answer is obviously to give Philips access to our technology, but the challenge in our work is to persuade them to go along with our assessments etc. ... Most of the times the larger suppliers do not want to spend time on being certified by us, so we rely on larger companies having sound processes.”

The paradox is that Bang & Olufsen actually buys systems (in contrast to components) when they at the same time try to remain an attractive customer by giving the appearance of being innovative itself. Peer S. Hune is convinced the innovativeness of the company helps retaining the larger suppliers:

“Often with the smaller suppliers they are quite dependent on Bang & Olufsen for revenue, but for the larger suppliers I can see two reasons: 1. It is beneficial to have Bang & Olufsen on one’s list of reference customers, and 2. Bang & Olufsen helps the suppliers develop through the high technical and quality demands we place on our suppliers. ... The suppliers do not always see the second benefit, but they definitely see it in retrospect.”

Questioned on the risk of exposing too much of the core competencies of a company when working closely with suppliers, Peter S. Hune responds:

“We in the purchasing department are very aware of not exposing the ‘DNA of the company’ – and we are quite aware some of our high tech suppliers do the same.”

To Steen B. Jørgensen working closely with suppliers is a precondition when designing the company’s supply chains.

SCM Practice

As activities are outsourced the company becomes more and more dependent on external partners for critical input. Predictability internally as well as externally becomes of utmost importance as inventories are transferred from the sales companies to the suppliers. The increasing use of System and Key suppliers increase the need to integrate, and therefore suppliers’ IT systems are integrated with Bang & Olufsen’s, and plans and forecasts are shared. Through web-enabled applications suppliers can keep track of changes to forecasts and actual orders, and can plan accordingly. In a similar manner, the B1 stores are integrated, and given access to Track & Trace information on customer orders.

According to Steen B. Jørgensen also the characteristics of the products enhance the importance of logistics performance when supplying end-products to B1 stores or directly to the end-consumer:

“Our business setting is very vulnerable in the sense our products are ‘life style products’ which mean the customer doesn’t really need them... The customers pay a high price, and if performance does not match their expectations, they will not come back. ... The B1 stores are independently owned, and they need to make money. Therefore poor logistics performance would be devastating for our business model – if we [SCM/Logistics] do not perform well, we might loose the business.”

Changing the distribution and inventory management philosophy was thereby a bold move taking the sensitivity of the market into consideration.

Figure 7-4: Bang & Olufsen – Supply Chain Concept¹⁷

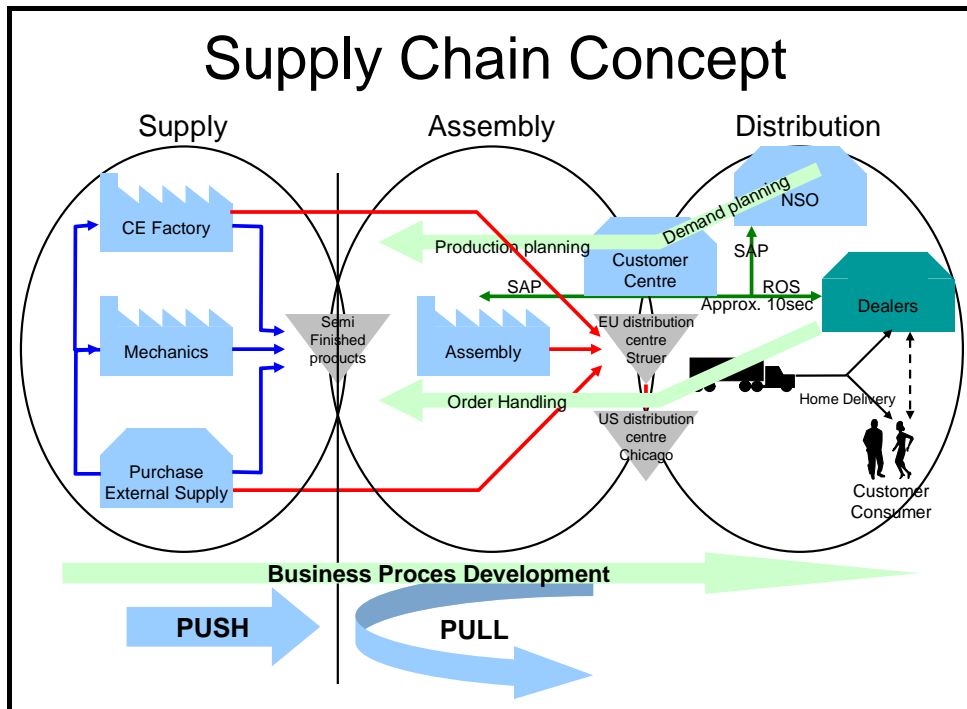

As illustrated in Figure 7-4 above the Supply Chain Concept implemented combines push and pull strategies. ‘Supply’ consisting of the factories is responsible for the (large batch size) production of semi-finished products, whereas ‘Assembly’ is responsible for taking the product from the “anonymous” decoupling point stage to end product as specified in the customer orders. Only few products are delivered directly from external suppliers or the CE factory to the distribution nodes. The last portion of the conceptual organization is the ‘Distribution’ part, responsible for delivering end-products to customers or sales outlets. All distribution is processed through the two distribution centers covering Europe (and Asia) and USA, respectively. In Asia, Bang & Olufsen is experimenting with creating Master Dealers, a notion describing a local agent holding the right to sell Bang & Olufsen products in the designated region for an agreed period of time.

Inventory is thereby kept in the central warehouse in Struer, in the Chicago warehouse, at selected sales companies outside Europe and USA and at Master Dealers in Asia. Only at the central warehouse does manufacturing postponement take place, further strengthening the effect of the risk pooling¹⁸.

¹⁷ Source: Steen B. Jørgensen, Bang & Olufsen.

¹⁸ Risk Pooling - the principle of aggregating independent and unrelated fluctuations (in demand) to reduce overall variation. In inventory management the term described the principle of centralizing the inventory at fewer sites, thereby minimizing the safety stock needed for a certain service level. For more, see e.g. Hill (2005) or Stevenson (2005).

The concept also contains three processes, which are quite different from each other. The Planning process is split between Demand Planning (performed by the sales companies and verified by the customer centre) and Production Planning (performed at Operations in Struer alone). The second process, Order Handling, is initiated in the outlets and processed by Operations, either pulling the product from inventory or initiating the customization of a semi-finished product (depending on price and volume of the end-product). The last process, Business Process Development, is oriented towards the continual development of the operation in itself.

Supply Chain Diagram

An alternative way of depicting the companies' supply chains is demonstrated in Figure 7-5.

Figure 7-5: Supply Chain Diagram – Bang & Olufsen¹⁹

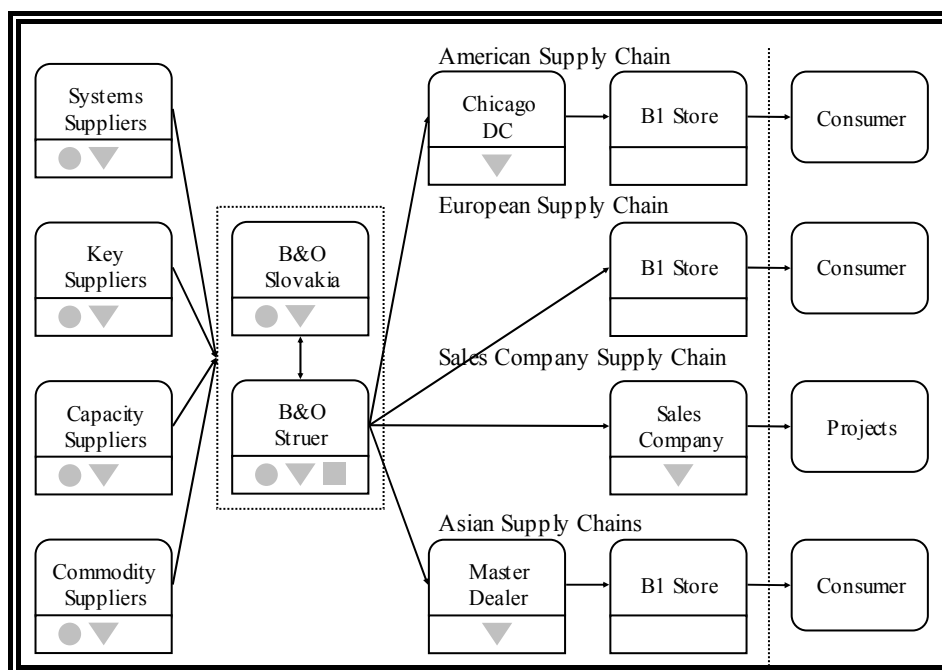

Applying the method briefly described in the introduction leads to a Supply Chain Diagram containing four supply chains: American, European, Sales Company, and Asian.

The American supply chain differs from the European supply chain by utilizing a third party distribution centre in Chicago. In Europe, all distribution is direct from Struer to the B1 stores or in some instances directly to the consumer. Only in countries with limited dealer coverage and/or problematic distribution may sales company hold inventory. Lastly, the Asian Master Dealers are allowed stock keeping, albeit it is primarily at their own risk and expense. The input-side is decoupled from the downstream side as no distinct correlation between suppliers and customers or products can be identified. Where ever possible suppliers are asked to stock their input to Bang & Olufsen at the latest stage of production. This

¹⁹ In this model, the circle denotes Operation/Production, the triangle denotes Inventory, and the square denotes Postponement/Customization. This typology is used throughout this chapter.

business model is obviously quite fragile as pressures from customers and dependencies on suppliers are both high.

SCRM Practice in Logistics?

As described earlier Steen B. Jørgensen fully embraces the current trend of outsourcing, from outsourcing of the warehouse management in the USA to the sales of the electronics manufacture plant to Flextronics. He emphasizes that the IC industry itself is a risk-ridden industry in the sense that no surplus capacity exist. The capital intensiveness of the industry requires a very high utilization rate to ensure a reasonable return on investment, therefore no excess capacity exist. In that respect, Bang & Olufsen is a hostage of the IC industry as are all companies requiring IC's in their products. So, even if he recognizes the strategic nature of the activities and the threats to the company, he insists that further outsourcing is beneficial to the company. This is naturally "hollowing out" the company, in the sense fewer and fewer activities are performed in-house. But this is also considered an inevitable consequence of global competition, Steen B. Jørgensen:

"When ever a competence is profitable it must be kept in-house, if possible. ... But most often, the volumes we require are too small... We have to outsource the activities we performed previous, simply due to global competition and scale economies. ... This does not mean we have lost control, altogether. In molding, for instance, we make sure we own the tools..."

Coordinating with suppliers and making sure quality is acceptable thereby becomes critically important – and is enhanced by Bang & Olufsen's decision to accept working with sole suppliers. Steen B. Jørgensen believes that this practice results in increasing risk but that:

"...the implementation of first tier suppliers requires a lot of resources from both parties to create the appropriate relationships, thereby creating an exit barrier. ... We have no formal risk management organization; risk management is part of everybody's job!"

To him the most critical risk is the risk of deteriorating logistics performance, disappointing the end-customers. To mitigate this risk a system for ordering and shipment monitoring is available to all B1 stores across the world, enabling them to control their orders are being processed as expected. Furthermore stringent forecasting procedures support the production planning and inventory management when in- and out-phasing products. Even if these (and a long list of other) risks are identified and acknowledged, no formal SCRM is taking place. KPI's²⁰ are continuously monitored and responses are described, but the environment or the internal operation is not analyzed for other risk sources/mechanisms.

SCRM in Purchasing?

The purchasing organization, in contrast, subscribe to a much more formalized approach to SCRM. As described above the segmentation model could be used in the continued

²⁰ KPI - Key Performance Indicator. At Bang & Olufsen the KPI's 'Delivery Precision' and 'Quality' in their most generic forms are collected and monitored.

evaluation of suppliers. At present it is only used (stringently) at supplier selection, and when dealing with the five-ten most critical suppliers.

As described in Figure 7-3 the suppliers are requested to supply information on organization and reporting in relation to risk management, the production, the stock keeping practices, and the estimated consequences of an interruption. Upon acceptance and inclusion in the supplier portfolio, the suppliers' performance is collected and used in the periodic evaluations.

SCRM in Legal?

Besides the management of (supply chain) risks performed by the purchasing and logistics departments described above, risk management takes place in the staff function 'Legal' as well. The risk management task is here split between the two groups, one group oriented towards facilities management, the other towards operational (or business) risks. The head of the latter of the two group, Kim B. Hansen was the original architect of the risk questionnaire (see Figure 7-3 for the current version used with the suppliers).

Kim B. Hansen explains how the model has evolved:

“Previously I was responsible for the operational risk management at the plants, but after the implementation of Klaus’ model [for supplier base segmentation] the tools I developed have been modified to support the management of supply risks. ... The purchasing department uses my model, and so do I, but we use it differently.”

As described above Kim B. Hansen uses a method of ranking the most critical suppliers to the most important products, whereas Purchasing uses the model mostly at supplier selection. Responding to a question on the distribution of contracts across the supplier portfolio, Kim B. Hansen explains that quite recently they (the 'Legal' function) has started looking at this as well, as to minimize the impact of a supplier exit. Besides selecting the best performing supplier it will soon also be of relevance how dependent Bang & Olufsen already is of the supplier. The goal is not to remove risk taking in the company – Kim B. Hansen insists risk taking is critically important to Bang & Olufsen:

“Uniqueness is a must for a company like Bang & Olufsen, without uniqueness we’re dead for sure. When we develop new products we make sure the designer are not restrained by current knowledge or procedures – they are de-coupled from the technical organization. ... If we used our engineers to do product design, you can be sure we would get great products – but they would not be [as] innovative.”

Uniqueness is therefore a prerequisite for successful innovation – and the organization must be ready to handle it.

Summing Up...

As described above Bang & Olufsen has undergone dramatic changes during the past 15 years. The company has changed its distribution and inventory management strategies, and has outsourced large parts of the previously manufacturing oriented company. The Bang &

Olufsen of today is deeply dependent on its suppliers to provide not only inputs but also competencies critical to the products in Bang & Olufsen's portfolio.

The increasing number of variants of products has led Bang & Olufsen to ask suppliers to hold inventory, at least for the fastest moving products. Production for most products is performed against a continuously updated forecast, replenishing the few warehouses left. More expensive or slow moving products are produced to order. Overall, the redundancy in the business model, both in terms of quantity and time, has decreased resulting in an increased pressure to operate with a high degree of precision and predictability.

The practice of SCRM is spread over multiple functional areas. As Logistics defined the major risk as 'poor logistics performance' their use of KPI's can be regarded as risk management of the process risks. In Purchasing this information is used when dealing with suppliers, e.g. at the periodic meetings. The segmentation model described in Figure 7-2 form a basis for differentiating the management of suppliers, but for some reason the model is only used when selecting new suppliers. In Legal the model has a similar impact albeit the approach is somewhat different. Here the model is used to pinpoint relevant suppliers for further analysis, as described above. Risk Management in general is not integrated as Financial Risk Management is performed separate from the management of business risks.

7.2 Brüel & Kjær Sound and Vibration Measurement a/s²¹

The founders of the company, Per Brüel and Viggo Kjær got to know each other during their studies 1932-1938 at the Polytechnical University of Denmark where they both studied to become engineers. The two men agreed to jointly start a company designing and manufacturing acoustical measurement equipment. The mandatory military service and the start of WW2 meant delays to their plans, but as they intended to get some experience before starting their own company the delay was not critical. Per Brüel went to Sweden where he studied and taught, first in Stockholm and subsequently in Gothenburg. Viggo Kjær got a job in the radio industry. Both had ample opportunities to do research.

The first equipment was designed and manufactured as early as 1942, in the basements of their respective addresses. After the war the small-scale production in Sweden was moved to Denmark where export to the Nordic countries was now possible. During the 1950's the company developed measurement microphones of high quality as well as calibration equipment. Exports continued to increase and Brüel & Kjær became synonymous with high quality vibration measurement equipment.

The company continued its stable growth, and developed products in a steady flow. Approx. 15-17 percent of the turnover was re-invested in product development, which was perceived as crucial for the continued growth of the company. The 1960's saw an increased focus on airport noise, a market Brüel & Kjær addressed with specific products. The digitalization of the 1970's resulted in even more accurate new equipment and the redesign of selected products. The next decade saw the introduction of products of increased technical complexity, such as equipment to real time and continued analysis of noise. The decade also saw the first products for sound measurement for the automobile industry.

Economic Crisis

By the early 1990's the company experienced its most severe crisis (Laursen & Vestergård, 1991b). Sales had been declining for some years and major investments in product development were failing. The management was unable to intervene as the two founders could not agree on at least two strategic decisions: the strategy for the alternation of generations and whether or not to accept the infusion of foreign capital. Kjær wanted the heirs, his daughter and Brüel's son, to take over as managing directors, but Brüel disagreed. He believed that they did not have sufficient experience and insight to ensure the continued survival of the company. Furthermore Brüel wanted to bring in foreign capital and new competencies, Kjær wanted to resolve the problems internally. The outcome of the struggle was first the demotion of Brüel (Laursen, 1991; Laursen & Vestergård, 1991c)²² followed by the take over by the major investors (Laursen & Vestergård, 1991a). Few months later Kjær was fired, a new CEO was hired and the following year the company was sold to financial

²¹ Description supplemented with material from www.bksv.com.

²² Brüel later founded a new company, Brüel Acoustics, continuing his life-long interest in acoustics (Vestergård, 1994).

investors (Vestergård, 1992a). The crisis led to extensive outsourcing following the dogma of the time: “convert fixed expenses to variable ditto”. At that time approx. 80% of product value was created internally but this was to change. Manufacturing was outsourced wherever possible leaving only items without alternative manufacturing options, e.g. the production of a special thin gold foil for high precision microphones.

The company has since been re-structured and a number of activities have been sold off. The former pride of the company, the manufacture of the products, is now completely outsourced leaving only simple assembly and testing to be performed at the site at Nærum, Denmark. Product development is still a major activity, though, but the focus has narrowed. The organization is depicted in Figure 7-6 below.

Figure 7-6: Organization Chart – Brüel & Kjær²³

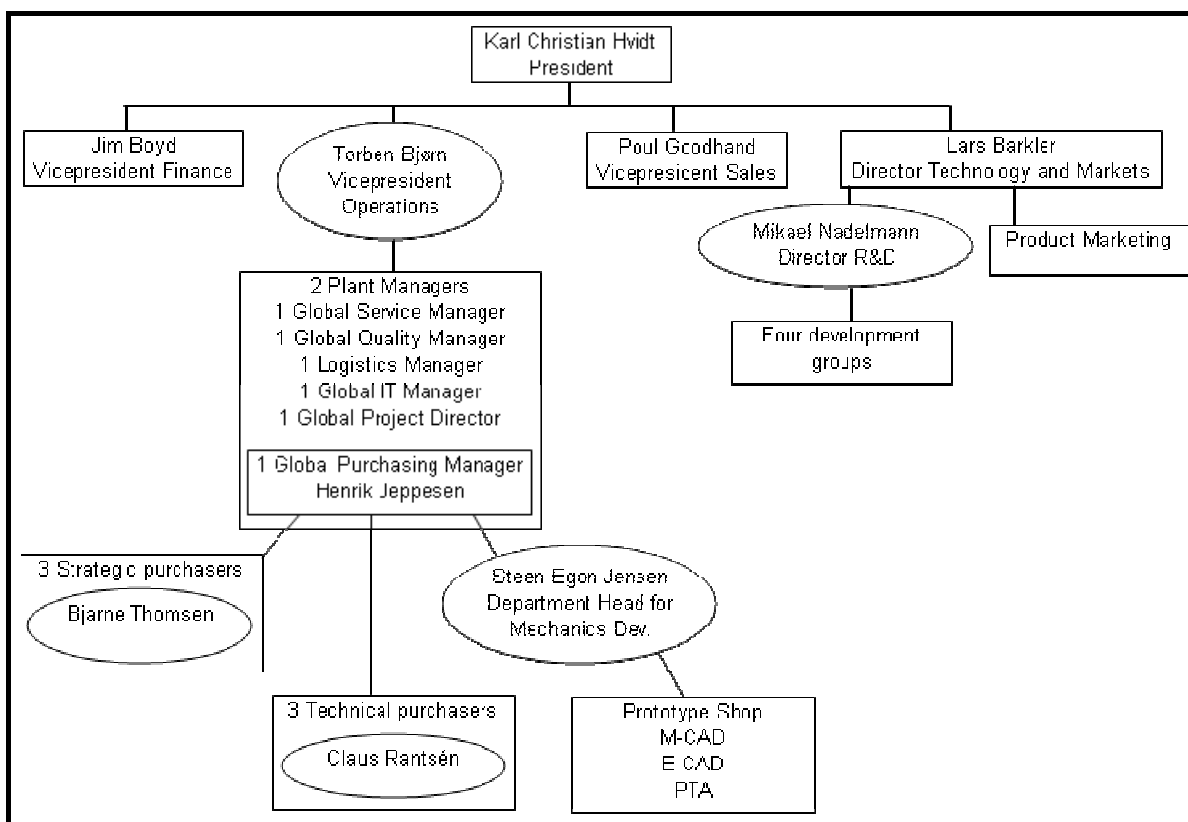

As illustrated above the company has a traditional functional structure, emphasizing technical/domain expertise over intra-organizational cooperation. The requirements for technical competencies obtained from external parties are visible in the split in the purchasing department between the strategic and technical purchasers, and in the existence of the quality department.

Financial Status

The outsourcing naturally meant a substantial reduction in the number of employees, a number that has remained relatively stable in recent years. The profit before tax, on the other

²³ Source: Henrik Jeppesen, Brüel & Kjær. Emphasis is on purchasing/operations.

hand still shows dramatic swings, as documented in Table 7-2 below. Apparently not even the dramatic reduction of activities (through outsourcing) and the portfolio of alliances have enabled the company to generate stable results. Turnover is increasing at a steady rate, but costs are fluctuating.

Table 7-2: Financial Profile – Brüel & Kjær Sound & Vibration Measurement A/S

End Date	Turnover	Profit Before Tax	No. of Employees
2004-12-31	673.158	80.087	477
2003-12-31	642.020	33.342	476
2002-12-31	613.214	-16.156	485
2001-12-31	653.942	-69.755	537
2000-12-31	687.223	81.119	514
1999-12-31	543.411	38.030	494
1998-12-31	527.772	72.065	549

Alliances

At the same time as the company outsourced activities, it entered into partnerships to strengthen its competitive position through a wider and deeper product portfolio, and a better international coverage in terms of sales companies and representatives.

One such partnership, and probably the most important one, was the 1999 alliance with ENDEVCO. ENDEVCO's expertise in shock and vibration measurement combined with Brüel & Kjær's acoustic proficiency and product marketing/distribution network gave customers a single-source supplier that they could depend upon for quality products, on-time delivery, and outstanding technical support.

To obtain access to software for laser scanning and structural analysis Brüel & Kjær joined forces with Maul-Theet Systeme in 2002. The partnership gives Maul-Theet access to the world wide Brüel & Kjær sales organization, and obliges Brüel & Kjær to develop Maul-Theet as the European competence centre within their niche. Maul-Theet was an obvious partner as the company was already known to Brüel & Kjær through the 1999 agreement to distribute the VPI+ generation of laser scanning vibrometers developed jointly by Ometron and Maul-Theet. Also in 2002, Brüel & Kjær teamed up with DMGR and Stapelfeldt in the "Prediction Partnership", a partnership aiming at creating the world's foremost solutions within environmental noise prediction software.

A number of similar partnerships exist with Acoustics Engineering (Dutch company developing acoustics software and equipment), Listen Inc. (Boston based company who developed SoundCheck™ - an electro acoustic production line testing system for loudspeakers, microphones, hearing aids, telephones and other acoustic transducers), ODEON (a spin-off from The Technical University of Denmark who developed the software ODEON, a software system for professional modeling of acoustics in auditoria, concert halls, theatres and other large rooms, as well as prediction of noise in the industrial environment), SoundShip (a Danish company designing and producing inexpensive, attractively designed sound level indicators), and TIRA (a German company manufacturing various types of

vibration test equipment). In 2004 an estimated 30% of revenue was generated from “alliance products” – either final products or components used in the final assembly.

Production (Assembly & Test)

The majority of sold products are standard, enabling batch production and stock keeping. At Brüel & Kjær production of standard products is performed against an aggregated forecast which is updated weekly. Based on an annual sales forecast, a seasonality index and an expected distribution across the product portfolio, production orders are generated and carried out. To minimize the likelihood of shortages the MRP procedures takes a safety stock (and thereby lead times of all dependent requirements) into consideration when generating work orders. But since the company is engaged in custom designs and project sales as well, production also takes the form of prototype production and production against firmed orders as well. In case project orders have long lead times, the requirements will just merge with the “normal requirements”, but in case lead times are comparably short, it will place a demand on supplier for quick and precise delivery of the requested sub-assemblies and components. In case the requested components have a high consumption rate, inventory is most likely available at Brüel & Kjær, but in case the components/subassemblies are either non-standard or only rarely used inventory is most likely not to contain any/enough quantity to fulfill the project order. Brüel & Kjær therefore has to depend heavily on their suppliers in order to participate in this type of sales. Prototype production often follows its own logic and may be characterized by short lead times or not, it varies by case.

Products at the Cutting Edge

Being a producer of complex products at the cutting edge Brüel & Kjær prior to the crisis and subsequent outsourcing had excessive capital tied up in inventory. The gospel of the R&D department was that if the company wanted products at the cutting edge, the developers needed freedom to design the products without interference from purchasing or finance. The enthusiasm for creating the best products led to “overkill” in design where even simpler components were designed in-house instead of using standard components. This practice naturally led to inventory build-up, both due to the uniqueness of the components for each product, and due to batch sizing when purchasing components from external suppliers. The argument on cutting edge products and uniqueness in components is accepted by Henrik Jeppesen (Global Purchasing Manager):

“If you want to design products that give the company a competitive advantage, and stays in the market for an acceptable period of time, you probably have to accept to use a certain amount of unique components. We [purchasing] just don’t agree with the R&D department on how many unique designs are needed.”

Quoting several examples of over-design, he continues:

“You have to draw a line in the sand, and convince people that this is an acceptable level of complexity or uniqueness or whatever. We all agree that we

need product complexity, but we need to handle it in a reasonable fashion. To me, Design For Manufacture²⁴ is such a method.”

Advocating the implementation of Design For Manufacturing (DFM), Henrik Jeppesen explains how the re-design of products might lead to lower cost and less complexity:

“Due to regulations like RoHS²⁵ and WEEE²⁶ we have to re-design a number of products in the near future. When doing so, we will look for commonalities and make sure we only accept unique components where applicable. ... Component portfolio will be minimized perhaps enabling scale economies.”

This also poses an opportunity for supplier base reduction.

Supplier Segmentation

Irrespective of the ongoing top management attention the supplier base is not segmented properly, according to Henrik Jeppesen, who perceives the current framework as quite rudimentary. The suppliers are categorized into a simple typology of: 1. Strategic, 2. Tactical, and 3. Other, but the framework has limited explanatory power.

The group of strategic suppliers consists of suppliers of “critical components to critical products”. The criticality of end product is determined by the revenue contribution or innovativeness/novelty of the product, whereas the criticality of the component is determined by an appreciation of whether the component can be supplied from another source. Henrik Jeppesen comments:

“It is difficult to trust this classification when you know how subjective it is. What started out as a critical component or competence might not be so any longer – but we check too infrequently to have a real overview.”

The same objection could be made to the two other categories, since a common competence/input might have become scarce or supplied by a single supplier without Brüel & Kjør realizing it. What remains a fact is that supplier selection is based almost solely on technical competency²⁷.

Improving Supplier Management

The first logical step in improving the relevance of the supplier segmentation model is to ensure correct classification. But Henrik Jeppesen insists future practice should go even further:

“What is really interesting is whether the supplier is interested in developing the relationship with Brüel & Kjør, e.g. by participating in joint product development. We need to reduce the supplier base and suppliers not willing to

²⁴ DFM – Design For Manufacture, see e.g. Whitney (1988).

²⁵ RoHS – Restriction of Hazardous Substances. Described in the Directive 2002/95/EC of the European Parliament and of the Council of 27 January 2003, see europa.eu.int/eur-lex.

²⁶ WEEE – Waste Electrical and Electronic Equipment. Described in the Directive 2002/96/EC of the European Parliament and of the Council of 27 January 2003, see europa.eu.int/eur-lex.

²⁷ Previously it was almost a requirement that the supplier should be based in Nørum. Undoubtedly, at some stage Nørum was the “silicon valley” of acoustical measurement technology, but no more...

increase the value they add will probably be phased out or change classification [become a capacity supplier].”

To Henrik Jeppesen the current model for segmenting and managing suppliers falls short due to the absence of a continued evaluation of the suppliers, and in its lack of differentiation of procedures for evaluation. Another problem is the ignorance towards the strategic choice that new products must not use components for which there is only one supplier. In other words: the company has recognized the problem of supplier dependency, but has failed to implement the corrective measures. On the process level, current practices are somewhat generic as all suppliers are evaluated for delivery precision and quality (broadly defined). Furthermore, due to the complexity of the end product and of the purchased components, all components are quality checked. Luckily, not too often do quality problems arise, and when it does the problem is sometimes in the design of the product. Quality problems are meticulously registered along with the corrective measures taken. This enables the engineers and product developers to improve designs in the future and enables matching the capabilities of each supplier with requirements in the various components.

To Henrik Jeppesen, the reduction of the supplier base is a step in the right direction:

“We currently have 300 suppliers, and that is quite few compared to the early 1990’s where we sourced IC’s and a wide range of electronic components. Now we source entire components instead. Still the 300 suppliers are way too many to manage – if you want to cooperate. Therefore the further reduction will prove beneficial to Brüel & Kjør.”

Currently a process of evaluating the suppliers is being performed - during the first half of 2005 two local suppliers have been replaced.

IT Integration

For a high tech company, Brüel & Kjør has a relatively low level of IT usage. Production and planning is performed at headquarters using a customized Oracle application. Sales orders and forecasts (and certain types of customer information) is sent from the sales companies, who perform Customer Relationship Management (CRM) and simple Order Management in a customized Siebel application. Besides the integration between headquarters and the sales companies, little integration exists.

Henrik Jeppesen describes the planned implementation of EDI:

“Currently we are aiming at implementing EDI. ... We expect that two of our suppliers will have the competence to participate at this stage. The next step is to implement VMI, but this is somewhere down the line...”

It is hoped that in the future suppliers will be better equipped to participate in e.g. IT projects - that the suppliers will mature beyond the products they participate in producing. In general, though, Brüel & Kjør has very technically competent suppliers, even if they are not in the forefront of IT and process management practices.

Supply Chain Design for Vulnerability?

During the first interview at Brüel & Kjær in 2003 Ole Bjørn (Strategic Purchasing Director) described how the outsourcing in 1992 resulted in the company being left very vulnerable. The extensive use of outsourcing naturally induced risks onto the company:

“Following the outsourcing enforced on Brüel & Kjær by its creditors we have been in a terrible situation as we operate at the mercy of our suppliers. We have no means of mitigating the risks of disruptions, except for the input we have to buy in bulk. At several instances suppliers have stepped in and helped us when a critical supplier has failed. We have no real explanation for their behavior.”

Elaborating over this issue Henrik Jeppesen offers an explanation:

“Recent interviews with the 30 largest suppliers have shed some light over these incidents. First and foremost our suppliers perceive our brand name to be of value for them. Being a supplier to Brüel & Kjær sort of certifies them as technically competent and reliable. Secondly, being a supplier to Brüel & Kjær they get access to the latest technologies and thereby stay at the cutting edge in their field.”

If this is true, then perhaps Brüel & Kjær operates under less risk than previously assumed? The company at least was able to cope with the discontinuation of one of their strategic partners, ENDEVCO. Henrik Jeppesen explains how the planned cooperation failed due to lack of commercial success:

“The alliance was entered into before I started with Brüel & Kjær ... but it was apparent the commercial value of the alliance was less than expected. The fit between their products and our distribution network simply proved inappropriate, for reasons probably only partially understood. Some have claimed the ENDEVCO products sold in the network required more competence and service than what was possible – others have disagreed. ... Perhaps their technical competence was lower than initially assumed?”.

Dropping these products and phasing in own products must have been quite a task, but apparently this was dealt with rather smoothly:

“As far as I know the transition took place over a period of time, and was quite undramatic. ... For the most part the ‘distanglement’ did not require any structural changes, and resembled a simple exchange of suppliers. ... We still carry some of their end products and buy few of their components for our end-products, but most of the components we required are sourced elsewhere or produced by us.”

Albeit surprisingly resilient in terms of exit from strategic alliance, certain activities need to be audited for stability and accuracy, namely the inbound quality inspection.

The Criticality of Inbound Quality Inspection

With the 1992 outsourcing, both process and structural risks increased for Brüel & Kjær: the process risk increased since the input became more complex and inventories were cut reducing the buffering capability. On the structural side, as more competencies were outsourced, the company lost direct control over critical process and technologies. Even if the

company already before the forced outsourcing had relied on external competencies, the company now placed its fate in the hands of its suppliers.

Interestingly, the increased risk and thereby the criticality of risk management did not have any organizational consequences in terms of positions or departments created for the integrated management of risks. But certain functions have been altered to fit this new reality, e.g. input control, which is now seen as one of the most critical functions in the company. Henrik Jeppesen states:

“Paradoxically, the positions in quality control are often considered less attractive, even if the activity is of critical importance to the company. ... Due to the comparable high cost of input and the following value adding during assembly, it is critically important to accept only fault-free components. But the jobs in quality control are still considered low prestige.”

Being a supplier of world class products, the company naturally can not accept failures in any of their products. Therefore the outsourcing has had a contra-intentional effect: quality management have had to keep a high level of competency in the technologies outsourced. Confronted with this paradox, Henrik Jeppesen reciprocates:

“We are quite aware of this issue – but there is no way around it. If you want to outsource the production of complex components and you want a failure rate of zero, you need to be very good at quality control. This means that you have to be very good at the technologies and possibly of the manufacturing processes you have outsourced. Of course we are more vulnerable now than before, but we have perhaps 2 people employed now where we previously had 40 or 50 [within a certain technology].”

Since the insourcing of these technologies is not an option, the current practice of extensive inbound quality inspection is critically important and non-dispensable.

SCM Practice

As shown in Figure 7-6 the company does not as yet have a department for or positions within SCM, but as one of the current strategic objectives of the company is cost and supplier base reductions, Henrik Jeppesen foresees the implementation of a SCM department:

“So far, the company has survived on long-term relationships with very loyal suppliers and customer, but little has been done to further integrate these critical partners. ... Management has defined the strategic goals: to lower cost and to decrease the number of suppliers. ... Within the next years I predict organizational changes to support this process.”

Purchasing is under dramatic change as well. The purchasing departments in the European sales companies are being closed as purchasing is being centralized at Headquarters in Nærum. Furthermore the distribution in Europe is being changed to direct shipments from Nærum, where possible²⁸. The European sales companies are thereby quite dramatically reduced in size and responsibility. For the US and Asia these alterations are not possible at this moment, though, thereby creating a distinct difference between the European sales company supply chain and the supply chains for the other regions.

²⁸ This is quite similar to the changes taking place at Bang & Olufsen in the 1990's, see Chapter 7.1.

Besides sales companies, Brüel & Kjær sell their products through agents in markets that can not support the presence of a sales company²⁹. Sale in this channel is normally based on direct orders, thereby resembling the new European setup. Agents do normally not hold inventory and are only rarely involved in the customization and installation of products.

Figure 7-7: Supply Chain Diagram – Brüel & Kjær

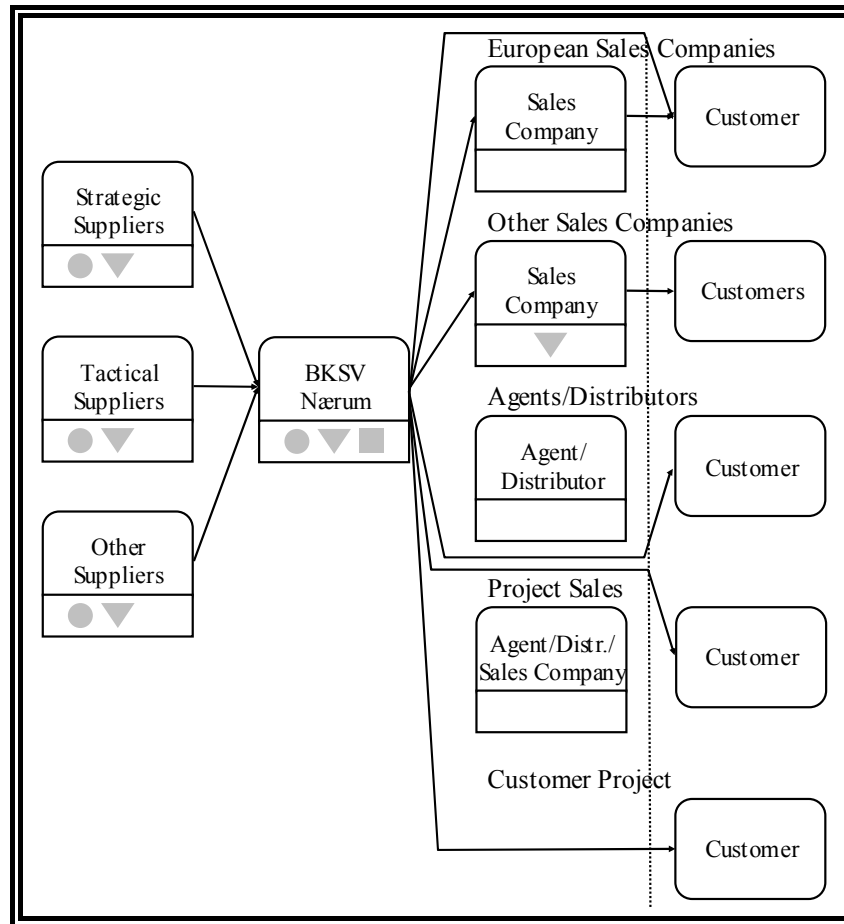

The last supply chain depicted in Figure 7-7 above is ‘Customer Projects’, a department solely running development projects for customers. The projects range from automobile design, over engine sound design to developing measurement equipment for test of hearing aids, sound meters etc.

SCRM Practice

As for SCM, SCRM is not observable in the organization chart either. Prior to the 1992 outsourcing most activities were performed in-house, thereby giving control to local management at every level. Dependency of other companies was *ceteris paribus* much lower at that time as critical competencies were situated in-house. Keeping safety stock went a long way in ensuring stability and buffered from external shocks of both the input and output side of the company. The risk response for some reason did not change: still inventory was used

²⁹ Actually, the centralization of purchasing and change to distribution might change the cost structures enough to justify extending the network of sales companies.

as the only means of risk management. As a direct result of the outsourcing, the inventory now changed from consisting of raw materials, WIP, and finished products to containing much less raw materials and as few WIP and finished goods as possible. Inventory was reduced in the sales companies as risk pooling advantages were reaped by shipping directly from headquarters (central warehouse) whenever possible.

Probing further into the practices of the use of safety stock reveals that the practice varies greatly from product area to product area. Henrik Jeppesen explains:

“The use of safety stocks is not based on general principles, but is primarily driven by the different people responsible for the various products. ... Therefore, in certain areas we are holding excessive safety stock, whereas other products are not covered at all. ... We have performed our risk management [safety stock keeping] in a haphazard non-coordinated way.”

Henrik Jeppesen goes on to describe how suppliers are supposed to hold approx. one third of the safety stock quantity calculated by Brüel & Kjær:

“I believe we actually have only two or three suppliers who hold safety stock for us, but in principle all suppliers could be asked to do this. ... It’s only the really critical components we monitor this closely. ... Assembly, for instance, could be moved tomorrow.”

As safety stock calculations are based on the time it takes to put an alternative into operation and since the use of sole/single sourcing is quite common safety stock (where calculated at all) can be quite excessive. Henrik Jeppesen has no explanation as to why dual/multiple sourcing is not current practice, but emphasizes that:

“The general rule is that no new product is to contain components or other types of input, for which there is only one source. ... Furthermore, all new products must be specified according to international standards to guarantee the possibility to move production from one supplier to another.”

Henrik Jeppesen ponders:

“Many of the initiatives started before I was employed 9 months ago are really sound, but for some reason they are so unevenly implemented. ... This really complicates things...”

The Way Forward

As Henrik Jeppesen sees it, the company must be driven by innovation, by the desire to and interest in designing the best products. But to ensure there’s a market for the manufacturing of the products, he emphasizes that the design output must meet international standards for documentation, and that the designs are not super-optimized towards a certain supplier’s technological capabilities. He furthermore emphasizes that SCRM is important, but that it is innovation and not risk management that should drive the redesign of the company’s processes and products!

Summing Up...

The case study above has many characteristics in common with the previous case study. Both companies were dramatically altered 10-15 years ago due to financial problems. In both cases the solution was a dramatic outsourcing, freeing up finances to save the companies. In both companies the initial outsourcing has led to more outsourcing – and thereby dependencies towards external parties. But as identical the early history is, the more dramatic is the difference in terms of management of the uncertainties introduced. At Brüel & Kjær the former Strategic Purchasing Director, Ole Bjørn explained at the very first interview that the current situation of intense dependency of suppliers was deeply unsatisfactory. But, as he explained it, there were (and was) no way out of that dilemma. At Bang & Olufsen the viewpoint is somewhat different as “hollowing out” of the company is perceived as inevitable. Brüel & Kjær’s strategic response is also dramatically different from Bang & Olufsen. Where Bang & Olufsen has used knowledge of “core technologies” to diversify into related industries (luxury boating, luxury cars), Brüel & Kjær has chosen to use their sales company network to enter into alliances with producers of related (but not competing) products and get a better ROI of their network. Also in terms of SCRM the two companies could not be more different: Bang & Olufsen has really taken the challenge to obtain control over their suppliers, whereas Brüel & Kjær apparently has no positions and no procedures for operational risk management, and no strategic management relating to the management of the structural risks.

7.3 Coloplast A/S

The history of Coloplast starts in 1954 when Nurse Elise Sørensen conceived the idea for the first attachable, disposable ostomy bag. After being turned down by a number of potential manufacturers, Elise Sørensen finally persuaded the owner and manager of Dansk Plastik Emballage, Aage Louis-Hansen, to produce a relatively small batch. The immediate success caused the bag to be put in production and Coloplast A/S was subsequently established in 1957. Output volumes increased rapidly and by the end of the fifties two thirds of the produced Coloplast ostomy bags were exported through distributors. Following a number of years of continued growth Coloplast A/S was registered at the Copenhagen Stock Exchange in 1983. Since then the company has grown further and has expanded its network of subsidiaries, distributors, and representatives across the world. By the late 1990's a number of mergers and acquisitions added to the product portfolio and enhanced Coloplast's position on the international market for its products. Table 7-3 below gives more detail.

Table 7-3: Milestones – Coloplast A/S³⁰

Year	Description
1954	Visiting nurse Elise Sørensen pays a visit to plastics manufacturer Louis-Hansen. She shares with him her idea for a disposable plastic bag for ostomists. Elise's sister has had ostomy surgery and is very uncomfortable with the devices available. At first, Aage Louis-Hansen lets down her proposal; but his wife Johanne, who has nursing experience, favours the idea.
1957	Aage Louis-Hansen and his team at Dansk Plastic Emballage in Copenhagen suburb Gentofte are tremendously busy manufacturing the new disposable ostomy bags. One in two bags is exported. In September, a statutory meeting is held and Dansk Coloplast A/S is founded.
1961	Dansk Coloplast moves from the factory in Gentofte to new premises in Espergærde.
1966	The factory at Thisted, Jutland, begins operations.
1970	Over the next 25 years, with Folmer Halskov at the wheel, Coloplast was to scale up sales hundredfold.
1978	Sales subsidiaries are established in France and Great Britain.
1983	Ostomy Products Division is complemented by a new division for the business areas Continence Care, Wound Care and Skin Care.
1983	Coloplast's share is admitted for listing on the Copenhagen Stock Exchange.
1985	Folmer Halskov initiated the wording of Coloplast's first Mission. In 1985, few Danish companies have committed their mission to paper.
1987	Continence and wound care products are manufactured at the plant in Kokkedal.
1989	Coloplast sets an objective of achieving a turnover of three thousand million by year 2000. This landmark was achieved before schedule in 1998/99.
1991	The Humlebæk factory begins operations.
1992	A new product division for breast care is established. Mastectomy, as the new product area was initially called, spent its first years in business as foster child with the Ostomy Products Division (from 1990).
1994	Coloplast acquires Amoena Corporation, USA. At the same time, Coloplast acquires one third of the shares of Amoena GmbH. The remaining shares are acquired on 1 October 1996.
1995	After 25 years at the wheel, Folmer Halskov hands over to Sten Scheibye in February 1995. Coloplast acquires Sween Corporation. This acquisition adds the business of skin care to the portfolio.
1996	Coloplast starts ostomy production in China and textiles production in Costa Rica.
1997	Coloplast wins the <i>Danish Logistics Award</i> .
1998	Coloplast acquires shares in the German Home Supply + Care Group and in American Sterling Medical Inc.
1999	Coloplast exceeds the three billion turnover mark. A new objective is set to achieve 6bn in 2005.

³⁰ Source: www.coloplast.com.

Table 7-3 (cont'd)

Year	Description
2001	New sites become operative in Mørdrup and Kvistgård. Coloplast acquires SSL International plc's continence business. Later that same year, the remaining shares of Sterling Medical, USA, and the majority of the shares of the HSC Group, Germany, are acquired.
2002	Coloplast divests its consumer products business. In May, agreement is reached with American pharmaceuticals company Johnson & Johnson, for them to take over Coloplast Consumer Products A/S. Factory in Hungary begins operations.
2003	Coloplast announces its new objectives for 2008: revenue exceeding DKK 9bn and a profit margin of 18%. The company is restructured into five business areas: Ostomy, Continence Care, Wound Care, Breast Care, and Skin Health.
2005	Coloplast adapts matrix organization form to better support the international markets. Skin Health and Wound Care are combined into Wound & Skin Care (and Breast Care is kept out of the matrix organization).

Coloplast continues to grow and win market shares within most business areas, at the same time as new products are introduced at a steady pace. Turnover and number of employees are increasing, both due to organic growth as well as mergers and acquisitions as described above. Table 7-4 below contains financial details.

Table 7-4: Financial Profile – Coloplast A/S

End Date	Turnover	Profit Before Tax	No. of Employees
2005-09-30	6.528.000	885.000	6.159
2004-09-30	6.069.000	899.000	6.085
2003-09-30	5.669.000	878.000	5.774
2002-09-30	5.624.000	1.238.000	5.285
2001-09-30	4.069.000	624.000	4.115
2000-09-30	3.603.000	478.000	3.778
1999-09-30	3.065.000	452.000	3.721

Product Portfolio

From the first simple ostomy bag the company has extended its product portfolio, primarily evolving from the adhesives technology, but also aiming at creating a complete product portfolio for key customer groups. The adhesives in use are of the hydrocolloid class, pressure sensitive adhesives in which small particles of absorbing particles are homogeneously imbedded. The hydrocolloid adhesives are specialized skin adhesives having the ability to absorb moisture, to transmit excess moisture and to stabilize and cushion the skin. The knowledge of this type of adhesives is a very important core competence as it is intensively and continuously researched and used in a large share of the products. In 2003 this development led the company to restructure into the following five business areas:

- Ostomy products for people whose intestinal outlet has been surgically rerouted through the abdominal wall.
- Continence care products for people with bladder control problems.
- Wound dressings for chronic wounds.
- Skin care products for prevention and treatment.

- Breast forms and special textiles (swimwear and lingerie) for women after breast surgery (are marketed under the AMOENA brand³¹).

The first two business areas belong to the ‘Chronic Care Division’ whereas the latter three are Strategic Business Units (SBUs). Distribution of revenue and operating profit is described in Table 7-5 below.

Table 7-5: Revenue by Business Activities³²

Business Area	Share of Revenue	Business Area Class	Share of Operating Profit
Breast Care	7.4 %	SBU's	7.5 %
Skin Health	4.6 %		
Wound Care	12.2 %		
Ostomy	39.4 %	Chronic Care	92.5 %
Continance Care	23.6 %		

The company was restructured again in 2005, more on this below.

Markets

Coloplast operates in a truly global market. The entire market relies on reimbursement from social security schemes as only a small portion of current patients would otherwise be able to afford Coloplast's products. The special characteristic of this type of products is that the choice of product is heavily influenced by the caretaking personnel and that shifting from one product to another is very unlikely (unless of course the current product fails repeatedly). So, to enable sales the nurses and medical doctors are encouraged in various ways to suggest the use of Coloplast's products.³³

Table 7-6: Market Share³⁴

Business Area	Share of Market	
	Coloplast	Competitors
Ostomy	28 %	72 %
Continance Care	46 %	54 %
Wound Care	16 %	84 %
Skin Health	4 %	96 %
Breast Care	45 %	55 %

Coloplast is an important player in at least three of the five business areas, see Table 7-6 above. The company has not been able to penetrate the markets in Wound Care and Skin Health business areas, primarily due to the distribution methods (more on this below).

As indicated in the history of the company (see Table 7-3 above) exports was an important distribution channel from the start, but it was not until 1978 sales subsidiaries were opened.

³¹ Please refer to www.coloplast.com and www.amoena.com for more information.

³² Figures from Coloplast (2004), p. 11.

³³ The ethical issues concerning the relationship between Coloplast and the caretaking personnel has been a “hot” issue a number of times. As recent as on June 8th 2005, this issue was once again in the media as the practice of hiring caretaking personnel as consultants in Norwegian hospitals was questioned (Dahlager, 2005).

³⁴ Figures from Coloplast (2004), pp. 12-19.

Albeit exporting to countries outside Europe has taken place since the 1950’s, the European market continues to be the most important (perhaps also for income per capita reasons?). The distribution of revenue across geographical markets is shown in Table 7-7 below.

Table 7-7: Revenue by Market³⁵

Geographic Market	Distribution of Revenue
Europe	81 % (hereof 2 % in Denmark)
The Americas	13 %
Rest of the World	6 %

Organization

Also the network of subsidiaries, distributors, and local hubs has evolved over the years. The distribution network covers all continents, and also production has been dispersed. Currently production takes place in Denmark, China, Costa Rica, Germany, Hungary, and USA. Subsidiaries exist in 29 countries, three of which operate as local hubs – and an additional 49 countries are being served through distributors or representatives. In the USA, Germany and the UK Coloplast owns distribution companies delivering products and services direct to end users. Following the restructuring in 2005 the company is now structured as a matrix, combining business area and geographical region, see Figure 7-8 below.

Figure 7-8: Coloplast Group Structure³⁶

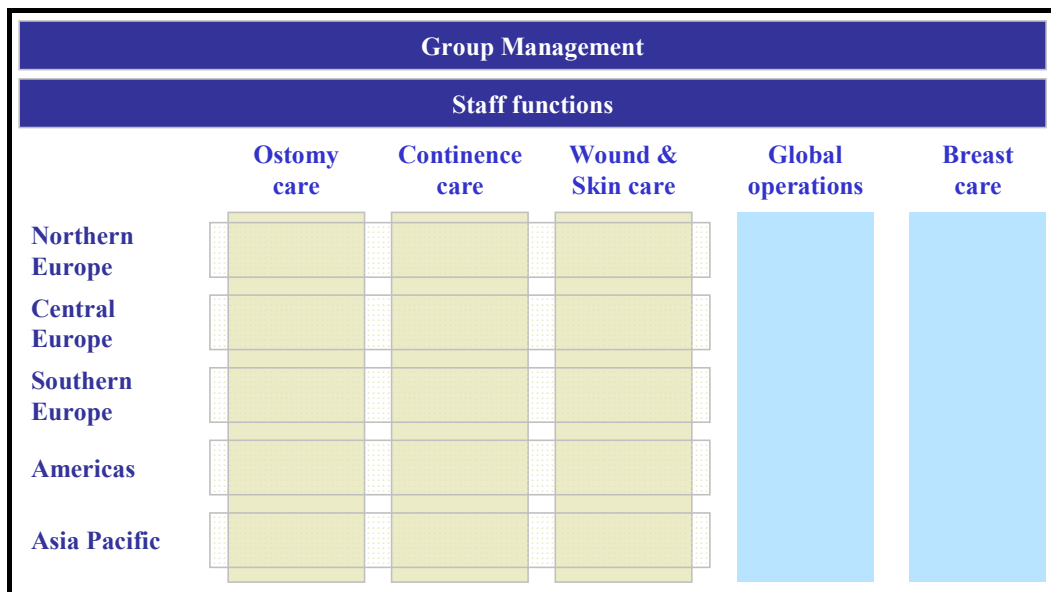

Operations are “truly global” as each operational function has global responsibility, supported by Staff functions and Group Management. Breast Care is perceived as separate from the other divisions mentioned above, and Wound Care and Skin Health have been combined in Wound & Skin Care.

³⁵ Figures from Coloplast (2004), p. 20.

³⁶ Source: www.coloplast.com.

SCM Organization

The restructuring naturally impacted the SCM organization which is a part of ‘Global Operations’. In the current structure each of the three “core” divisions has distinct management with direct reference to Johnny Nielsen (VP, Supply Chain Management). Besides these logistics managers (and a fourth, responsible for Consumables) the SCM organization entails Supply Chain Operations, Logistics Coordination, and Logistics Development, see Figure 7-9 below.

Figure 7-9: Coloplast SCM Organization³⁷

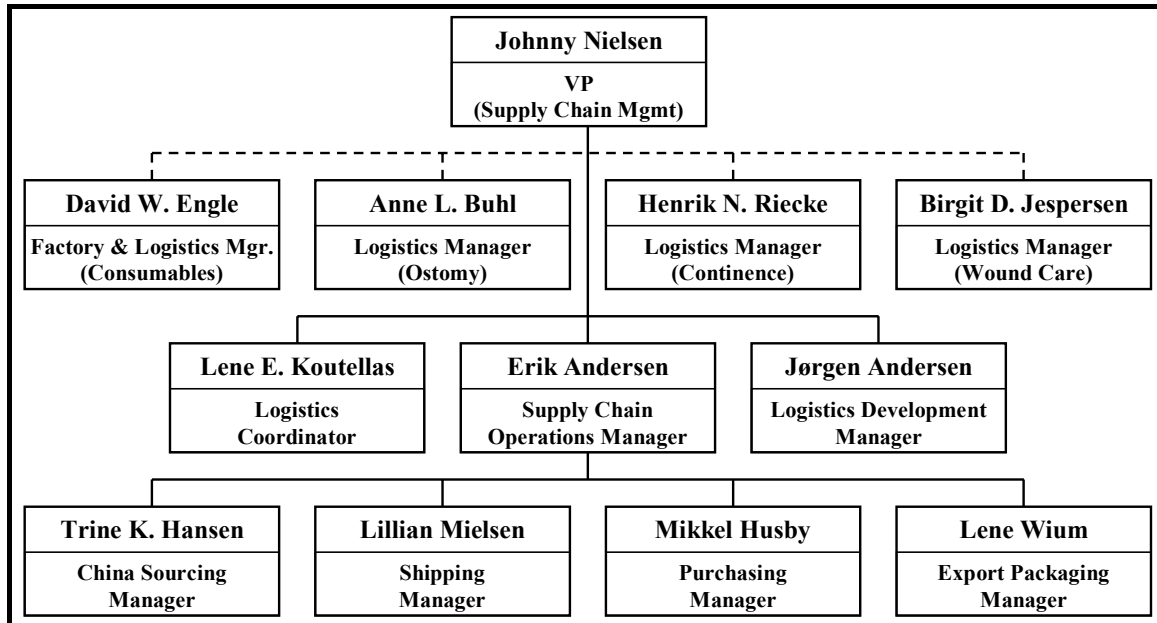

The implementation of SCM at Coloplast is thereby based on formal organization³⁸. Obviously not apparent in the figure above is the fundamental process underlying the SCM concept: the Order Fulfillment process. The focus on fulfilling customer requirements has a long history at Coloplast, developing from the Closed Loop Distribution model through every iteration of the business model. This focus is shared across business units and the process is monitored according to standard KPI's and reported periodically to all relevant decision makers. Using such a stringent model has its benefits:

“We have had reporting for many years, naturally, but since we started using our KPI hierarchy we seem to be better able to pinpoint problem areas. ... But we are not done yet – the model is evolving, supporting new goals...” (Johnny Nielsen)

Currently the KPI hierarchy has four levels and approx. 15 distinct measures, and is split at the top into the two ‘branches’ Delivery Performance and SCM Costs.

³⁷ Based on material supplied by Johnny Nielsen, Coloplast.

³⁸ Coloplast has for many years been a frontrunner within logistics in Denmark. Prior to implementing a SCM organisation the logistics department managed a replenishment concept called Closed Loop Distribution.

SCM and the Value of a Relationship

The view on inter-organizational relationships is somewhat divergent from the common gospel. In the initial interview Johnny Nielsen commented:

“As I see it there’s no value in a relationship in itself. ... I fully realize I contradict the prevalent dogma but must insist the value of relationships is overrated. ... The reality of the matter, for us, is that if the supplier does not lower the unit price after recovering the development costs, the order is given to a supplier who can produce at a reasonable cost.”

Johnny Nielsen insists innovativeness is very important, but that cost does have first priority:

“If the supplier does not understand the mechanics of the industry, we are not going to have a long business relationship. ... Basically, we should kick out all suppliers every two-three years – that’s the easiest way to get a real price reduction.”

Perhaps due to the nature of their products and their supply market, relationships are of less value for Coloplast than for other companies?

The Importance of Quality

Undoubtedly an important innovation in 1954, the ostomy bag in today’s world of high-tech products seems almost comically simple. The product is basically a plastic bag with an integrated hose. But comparing with competing (and cheaper) products, the Coloplast products stand out as e.g. the surface of before mentioned ostomy bag is produced using a certain technique to minimize irritation of the skin. The basic product is quite simple, but the total product is somewhat more sophisticated as it may include e.g. coatings or skin care products for increased comfort. Besides comfort, product quality is of critical importance due to the nature of the product. The production technology applied and processes implemented must ensure product failures are kept at the absolute minimum.

Apparently quality problems are rare, Johnny Nielsen comments:

“It is no problem to find suppliers producing to the high quality standards required. The production technology is well known, and the products we acquire are not the most sophisticated, from a production technology perspective. ... But since we have to make sure the supplier can produce to the quality standard, we have to spend quite some time monitoring their operation and testing the result before we feel we can rely on their competence.”

The worst imaginable situation to Johnny Nielsen is the situation where a full batch of a product is defective in some way, and that the batch has already reached the users:

“Just imagine the loss of confidence we would experience if such a situation occurred. Our major concern is threefold: product quality, product quality, product quality. ... Also delivery performance is important...”

It is therefore important that products are not designed in a way which introduces failures. So even if the technologies and production processes involved with the (basic) product, a lot of work is put into testing and verifying the manufacturability of the product.

Purchasing offers a different perspective on the sourcing requirements, Roland V. Pedersen (Purchasing Manager):

“In general the input we require is getting more and more complex as both we and supplier develop e.g. coatings for catheters. More and more inputs are protected by patents, and it is a constant challenge for us to evaluate if we need to buy patents from suppliers. ... From a product development perspective our supply segment resembles the pharmaceutical industry more and more.”

Purchasing and Logistics agree on the “goal” of this continuous development: to reward the innovative supplier and at the same time ensure the innovative product is made available in the “standard” supply market within a reasonable timeframe.

Supplier Segmentation

As hinted above not all suppliers are expected to participate in innovation, the supplier base is segmented into two classes:

- Innovative supplier who either initiate innovation themselves or agree to participate in projects set up by Coloplast. This type of supplier will normally be compensated for successful innovations, above the cost of the innovation.
- Standard (or capacity) suppliers who are able to produce in a high quality according to specifications. They may work for Coloplast for a long period of time, but should not expect any special treatment as they are intended to be fully replaceable.

Few suppliers fall outside this simple typology, e.g. Dow Chemicals and BASF who are much larger than Coloplast. With both these companies Coloplast have experienced problems during negotiations, Roland V. Pedersen explains:

“BASF used to produce a unique glue substance which was used with the uridom products, but decided to discontinue this production. We tried to persuade BASF to change their minds, but no luck. We then tried to buy the patent, but still: no luck. They had absolutely no arguments when declining our requests. ... It was probably just a policy decision...”

Johnny Nielsen describes another situation:

“When negotiating with Dow Chemicals we have encountered certain problems in terms of price negotiation. They [Dow] know we depend on their product, and rightfully feel quite confident we will not spend money and resources on developing an alternative product, taking the remaining patent period of their product into consideration. ... The fact that our demand has increased by 50% per year for the last years does not have any impact – they are really not interested in wasting any resources in accommodating us. ... This product must be quite profitable for them – but it is simply not their segment.”

Coloplast (unlike e.g. Bang & Olufsen as described previously) is not able to persuade or influence their large suppliers to accommodate their requirements.

Supply Chains

Combining the supplier categories with production units and distribution channels described above result in Figure 7-10 below.

Figure 7-10: Supply Chain Diagram – Coloplast

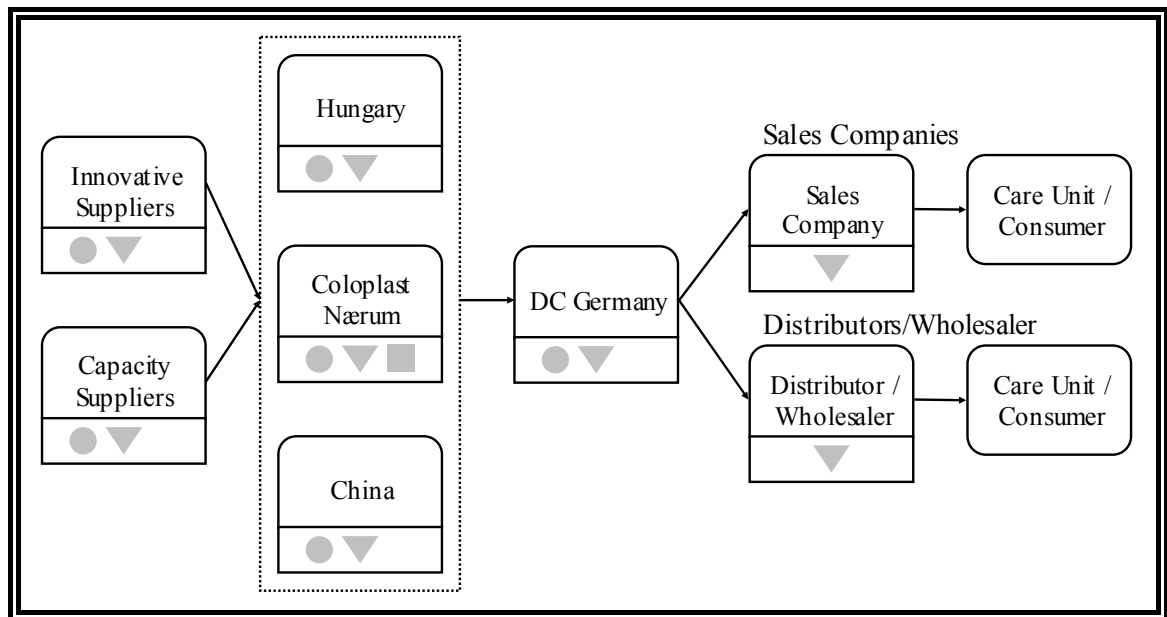

Supplier Management

Even if Coloplast has its challenge in influencing BASF and Dow Chemicals it has been quite successful in shaping the supply base, though. Like many other companies Coloplast over the last five years have reduced their supplier portfolio considerably. Following the trend of “competence-thinking” the weaker suppliers have been weeded out and their business shifted to better performing ones. This has strengthened the input-side of Coloplast to its current level of competence, enabling Coloplast to further develop the methods and procedures for interacting with suppliers. The downside of this supplier concentration is recognized by the VP (SCM):

“Of course, reducing the supplier portfolio leads to the risk of placing all ones eggs in one basket. We try to ensure suppliers are solid, well-run companies with no liabilities. ... Suppliers are evaluated in a continuous basis.” (Johnny Nielsen).

Verifying the solidity of the suppliers is an integrated part of the standard procedure for the purchasing department:

“Upon performing our annual evaluations with our most important suppliers we obtain financial keys figures – and these are used actively during the evaluation. ... Of course we are more thorough when evaluating new suppliers than suppliers we know, but key figures are included in the annual evaluations for all major suppliers.” (Roland V. Petersen).

Implied in the above quote is the fact that suppliers once accepted will be given more lenience in terms of evaluating e.g. financial figures than suppliers not yet worked with - creating a “stickyness” in the network. Roland V. Petersen comments:

“In principle I agree with Johnny [Nielsen] – we should get rid of suppliers periodically in order to cut costs. But this is just not practical as we are not very good at implementing new suppliers. It may take as long as 1 – 1½ year to

get the supplier up and running – and we do not even have very sophisticated systems.”

Johnny Nielsen agrees:

“Basically, we have not looked at that process for perhaps 10 years. We have no KPI's for it. ... If we were able to do this better we could get 20-30% cost reductions when negotiating frame agreements instead of the annual 2%.”

IT Integration

To further lowering unit costs, a current project is aiming at increasing the purchased volume managed through VMI from 60 to 80%. The technical solution is quite unsophisticated as the application simply informs the supplier and the purchaser responsible within Coloplast when inventory level for the relevant item number drop under the agreed minimum level. Furthermore the supplier have access to the current inventory level, and can use this information (together with the forecasts) to plan his production and replenishment of the consignment inventory at Coloplast.

SCRM Practice?

Albeit both interviewees consider Risk Management to be of utmost importance no formal organization or positions exist. Both refer to e.g. the production manager for questions on risk management in the plant, and to corporate finance for issues regarding e.g. currency risks, but none of the interviewees have any knowledge on routines and procedures crossing departmental boundaries. Within Logistics Risk Management translated into performing periodical (yearly) analyses of delivery precision and inventory levels. The analyses take their starting point with the strategic products (here: high volume products and new product with high potential) and contain calculation of business impact of changing inventory level and/or handling method (VMI versus non-VMI). In Purchasing the management of risks is somewhat more complex, or at least inter-organizational, as risk management takes two forms: an impact calculation and a process evaluation, both considered integral elements in supplier management. Consequences of supplier failures are routinely calculated for strategic suppliers, and same suppliers are evaluated in terms of factory safety and fire prevention as described in the Danish legislation. Furthermore financial figures are evaluated, as described above.

The company is thereby characterized by a very fragmented and functionally oriented approach to risk management. When questioned on the most critical risks for the company as a whole, both respond with either very overall risks or risks central to their role/responsibility only. The only risks the two departments seem to share are not even considered risks, but oversights in the development of the supplier management practice: the process to integrate new suppliers (as described above) and the process of updating product documentation as innovations occur and products are enhanced³⁹:

³⁹ Which are structural and process risks, respectively. Fits perfectly with the Supply Chain Risk Matrix.

“In many cases the product specification on file does not match the components produced or purchased as innovations are implemented in the products on a continuous basis. When documentation then is neglected it becomes very difficult to switch suppliers as documentation is out of synch with the factual requirements.” (Roland V. Petersen),

and

“Accepting innovations from a supplier will definitely influence the dependence in the favor of him [the supplier] and enforce more dependability if we are not able to make a credible threat [of switching to an alternative supplier]. ... By accepting innovations we are in fact being trapped – if we are not careful.” (Johnny Nielsen).

Innovation and continuous improvements thereby have the dual effects of improving competitiveness and increasing lock-in.

Summing Up...

Coloplast has a long history of quite advanced logistics solutions, supporting their extended network of distributors and sales companies. In contrast their SCRM practice seems to be quite basic and functionally oriented. Albeit their process orientation seems to be deeply rooted at least within the operations part of the company, the process is not supported by SCRM across departmental boundaries (and beyond). Only exception is the supplier audit taking place annually with strategic suppliers, evaluating both performance and the suppliers' sites/processes.

7.4 Dyrup a/s

Dyrup a/s is one of the prestigious older Danish companies, established as early as 1928 by Dyrup, Monberg and Thorsen. Since then the company has undergone some major changes, these are briefly described in Table 7-8 below.

Table 7-8: Milestones – Dyrup A/S⁴⁰

Year	Description
1920's	S. Dyrup & Co. A/S was founded in 1928 by Sigurd Dyrup, Axel Monberg and Ejnar Thorsen.
1930's	Dyrup supplies the anti-corrosion paint 'Stålhud' (Steelskin) for the Little Belt Bridge and the Storstrøm Bridge. Enamel paints are marketed.
1940's	Production and administration are brought together on a 120,000 m ² site in Gladsaxe. In 1947 Tintas Dyrup in Portugal is established in collaboration with Højgaard & Schultz.
1950's	The first plastic paint is introduced on the Danish market. The wood care product BONDEX is launched. Dyrup starts making printing inks. This activity is divested in 1996. A new factory is opened in Naples, Italy.
1960's	Dyrup is in charge of the construction of factories in Egypt, Angola and Iran. All factories have been sold off, although the factory in Egypt still works under license from Dyrup.
1970's	Dyrup establishes its own plant in Gladsaxe for production of emulsions for plastic paints. Dyrup assists in the establishment of a paint and varnish factory in Saudi Arabia.
1980's	Together with its French agent, Tollens, Dyrup acquires a paint and varnish factory in the USA. Dyrup sells its shareholding in 1992. A new business concept is launched in Denmark. A number of independent paint retailers join the concept. Dyrup acquires a 50% stake in a paint wholesaler in Odense, Denmark, which becomes the basis for the establishment of a range of paint centers in Denmark with sales to the professional market.
1990's	Dyrup introduces a completely solvent-free paint. Dyrup acquires several production facilities, e.g. Xylochimie S.A. in France and GORI all-wood international in Denmark. In 1992 and 1994, respectively, Dyrup Deutschland takes over distribution of BONDEX and GORI in Germany. Dyrup establishes a company in Poland, which commences paint production in 1996.
2000	The sale and distribution of Dupont auto varnishes is discontinued. Dyrup implements a new market strategy as a basis for future growth and increased earnings. The work on the creation of a single unified corporate image that makes Dyrup stand out as one company with one corporate culture commences.
2001	New varnish production is established in Lodz in Poland. The varnish production in Mennecy in France is moved to Lodz. The remaining production is relocated to Albi in France or outsourced, and the Mennecy factory is closed down in December. A new Dyrup Tinting system with new eco-friendly colorants is introduced.
2002	124 New Shop-in-Shops are implemented around Europe, a great takeoff for the new in-store concept that inspires and guides consumers in the process of choosing colors for their homes. GORI, Dyrup's oldest brand, celebrates its centenary. The French headquarters are moved to new modern facilities in Malmaison outside Paris. With the re-launch of the corporate web site (www.dyrup.com) the first step in the direction of a new online presence is taken.
2003	Dyrup celebrates its 75th anniversary by hosting a wide range of activities in all subsidiaries, for employees and customers both. The company enhances its presence in France by adding the application areas Paint to the palette. The implementation of the new Brand Strategy is initiated. Dyrup is awarded the Copenhagen Municipality Environmental Award 2003.

As described above the company has undergone quite a lot of change and is undertaking quite a number of initiatives. But considering the changes taking place, the overall financial indicators have remained surprisingly stable over the past years. As shown in Table 7-9 below only PBT has fluctuated – in 2001 and 2004.

⁴⁰ Source: www.dyrup.dk.

Table 7-9: Financial Profile – Dyrup A/S

End Date	Turnover	Profit Before Tax	No. of Employees
2004-12-31	1.668.200	82.100	1.107
2003-12-31	1.724.100	115.200	1.152
2002-12-31	1.722.300	116.200	1.178
2001-12-31	1.670.400	63.600	1.212
2000-12-31	1.642.200	110.200	1.222
1999-12-31	1.594.700	103.700	1.220
1998-12-31	1.527.400	107.300	1.212

Markets

As described in Table 7-8 above the markets have changed over time. Today the largest markets are France (440 mill. DKK) followed by Denmark (390 mill. DKK), Germany (245 mill. DKK) and Portugal (245 mill. DKK). Other countries contribute with 355 mill. DKK⁴¹. Products are sold through three channels:

- DIY (primarily through large international chains). In Denmark Dyrup’s products are sold through SILVAN, in France through Castorama, and in Germany through GOBI and Bauhaus.
- Professional Users (wholesalers, builders’ merchants, and outlets owned by Dyrup⁴²).
- Industrial Customers (mostly manufacturers of e.g. windows and doors).

The former two represent 42% each, leaving 16% of revenue for the Industrial Customers. The DIY is growing, but may be threatened by the concentration in the segment. Working with the large international chains has the benefit of reaching a large share of the DIY market, but prices are challenged continuously. Partly addressing the price problem a “second generation” shop-in-shop concept is being rolled out, enabling the end-customer to obtain advice and guidance in using the products. Industrial Customers are serviced by Dyrup itself and is categorized into two groups: sawmills requiring impregnation products and wooden product manufacturers requiring surface products.

Product & Production Process

The generic product can be broken down into four components: binders, pigments, solvent/water, and additives. The production process differs between the two product technologies: water-based and solvent-based. For the water-based products, the production process itself is quite simple as it consists of a simple mixing process. For the solvent based production the process is somewhat more complex as the mixing has to be performed at certain temperatures and pressures. Both production processes in themselves do not take long (4-6 hours), but the intense sampling and testing procedures required to ensure a consistent high quality of the products, extends the production process to take 48-72 hours for water-based and 24-48 for solvent-based products. Besides the production process and the sampling and testing the facility (tanks, pipes etc.) has to be flushed and cleansed regularly.

⁴¹ Source: Dyrup (2005).

⁴² Dyrup owns 14 outlets in Denmark and 7 in Portugal.

Product Portfolio

The product portfolio consists of two main areas: wood care products and paint. The latter is often divided further into water-based and solvent-based paints. In part due to regulations and legislation⁴³ the solvent-based paint products are being replaced by the more environmentally friendly water-based alternative⁴⁴. This is to a certain extent being countered by customer preference, Henrik D. Nielsen (Supply Chain Director) explains:

“Paint is most often water-based whereas wood care products are solvent-based. This is primarily due to customer preferences as customers expect the ‘solvent smell’ in wood care products and expensive paint. We even have competitors who add the ‘solvent smell’ to their water-based products in order to persuade the product to buy product. ... With the advanced components we have at our disposal today only very few ‘standard’ products really need to be solvent-based.”

Besides these two product categories the company sells various types of special paints and accessories, and even occasionally produces products for special applications such as coatings for acid tanks.

Brands

Primarily due to takeovers the company previously has supported a (large) number of brands. But due to a more focused brand strategy the company today tends to invest in fewer brands in order to obtain better awareness and higher recognition levels of the company’s products. A number of smaller brands have therefore been removed from the portfolio leaving only Dyrup, Bondex, Gori and Xylophene as the major brands accounting for approx. 80% of total revenue. Bondex and Gori are intended as international brands, focusing on the DIY and Professional Users segments, respectively. The Dyrup⁴⁵ and Xylophene brands are major brands in Denmark/Portugal and France, respectively, supplementing the Gori and Bondex brands. Besides these four major brands sales in smaller markets is supported by local brands where these have high recognition levels.

Competition

Even if Dyrup has quite an extensive reach internationally as well as breadth in product portfolio, they are not the leaders within their industry. Comparing to e.g. AKZO Nobel, ICI or La Farche Dyrup seems quite small, but in reality they are midsize. In terms of competitive position Dyrup is at a disadvantage compared to these large companies, Henrik D. Nielsen comments:

⁴³ E.g. the VIC directive (exhaust of gasses).

⁴⁴ In 2002 Dyrup invested in a company developing a method to treat wooden components with an environmentally friendly solvent free wood care product. Unfortunately the company went into bankruptcy in the fall of 2003. Dyrup lost a considerable investment but was not deterred - they insists on trying again as soon as an appropriate partner appear.

⁴⁵ In Denmark the most popular brand is GORI, but the brand is under attack by Flügger - as illustrated by the press releases and the following retractions from Flügger (Munch, 2006; Ritzau, 2006).

“They [the large competitors] have the advantage of controlling the entire supply chain. We are being pressured by e.g. the retail chains all the time. ... Even Flügger, who is present in the Nordic countries only, is in a better position in terms of controlling the supply chain.”

Nis Petersen (Corporate Purchase Officer) further elaborates:

“The large retail chains are really powerful. Sales currently is split between 40% special offers, 30% discounted sales, and 30% normal price. This really hurts us, but at the moment there’s nothing we can do about it. ... The large retail chains insist on private labeling, but that’s stealing your money. ... To survive in this market we need strong brands ensuring a high and stable price. The shop-in-shop concept, for instance, is helping us strengthen our brands.”

In the other distribution channels the competition is a bit more relaxed and margins are comfortable high. Overall most of the competition is from smaller local companies.

The Network

As described above in Table 7-8 the company has sales companies across Europe (see Figure 7-11 below).

Figure 7-11: Dyrup’s Group Structure⁴⁶

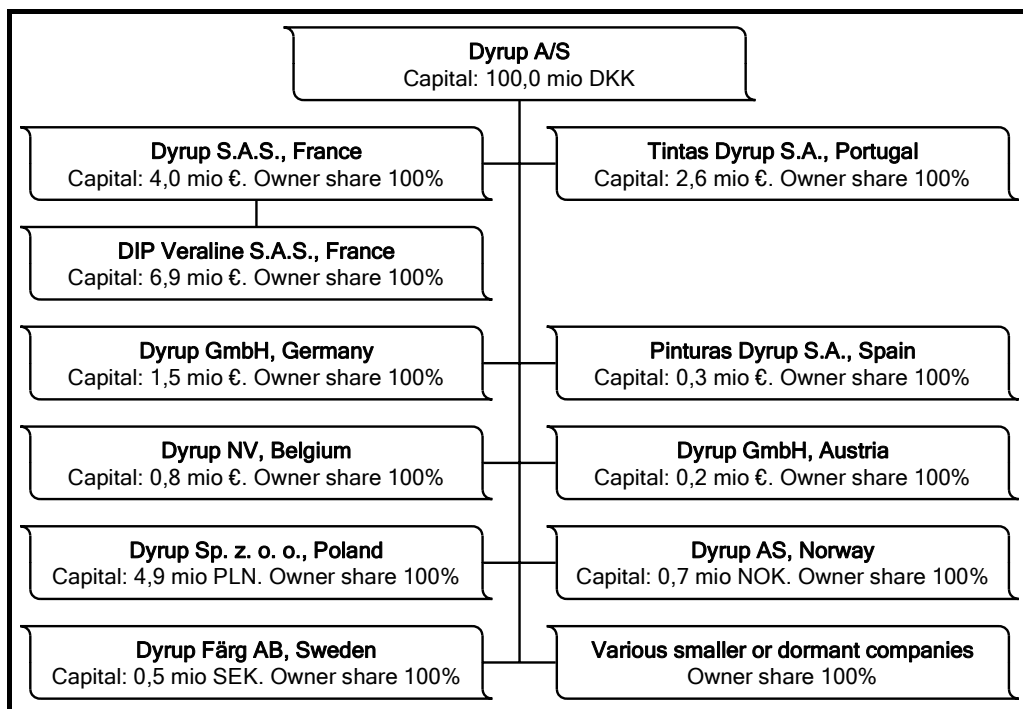

Besides sales companies the company has licensing agreements in Saudi Arabia and Egypt, and distributors in Ireland, UK, Italy, Switzerland, Greece, Hungary, Czech Republic, Estonia, Latvia, and Lithuania.

⁴⁶ Source: Dyrup (2004), p. 29.

Production

During the past years the company has chosen to consolidate production facilities. In Denmark the production in Kolding was consolidated with the existing production at Søborg, in France all production taking place in three sites was closed and consolidated at a new site. This leaves only five production sites: one plant in Denmark (Søborg) and four in Europe: Poland (Lodz), France (Albi), Spain (Barcelona), and Portugal (Lissabon). At the sites in Spain and Portugal only water based products are produced whereas the production in Lodz is half water based and half solvent based products⁴⁷ and the production in Albi is almost entirely solvent-based. In Denmark both solvent and water-based products are manufactured. Besides the types of products produced at each site, also the degree of exporting varies greatly. At the sites in Poland and Denmark more than 50% of the production is exported, whereas production in France, Portugal, and Spain are almost entirely for their local markets.

Local Recipes

Only to a very limited degree can production be moved from one factory to another, Henrik D. Nielsen:

“First and foremost the production sites differ in terms of technology. ... Second, a large part of the production is based on input from local suppliers – and due to variations from supplier to supplier we are too dependent on these smaller local suppliers. ... We have to develop new recipes if we want to move production – and that’s quite costly.”

Dyrup thereby misses out on basic scale opportunities and advantages arising from running a multi-site operation. Whereas postponement might help flattening out demand peaks in other companies it would not work at Dyrup, primarily due to the integral nature of the production process⁴⁸ and the bulkiness of the product. For slow-movers the problem might be further emphasized by the issue of durability as minimum batch size is approx. 6.000 liters.

The irony of it all is that the problem (to a certain degree) is self-inflicted, Henrik D. Nielsen:

“The main reason for this problem was negligence when performing the acquisitions during the 1990’s. When taking over these sites we probably should have analyzed the supplier portfolio - and made sure the production technology was aligned where possible. But growth was more important at that stage...”

Size is not the only problem, though, in relation to the supply base.

Supply Base

Dyrup shares fate with many other Danish companies in the sense their suppliers are much larger than themselves. To Henrik D. Nielsen this is quite frustrating:

⁴⁷ Most of the solvent-based production was moved from Denmark to Poland when production was consolidated in Søborg.

⁴⁸ The production process does not have any “natural” decoupling points. Furthermore, as the product is filled into consumer-oriented packaging (buckets) the brand is included in the production process.

“Among our fifty largest suppliers we are able to influence two! ... I have never previously experienced such a degree of dependency on suppliers. ... Of course we can not influence suppliers like BASF or Beyer, even our supplier of packaging material is much larger than us – we account for 4% of their revenue. ... In a sense we are only operating at their mercy.”

Nis Petersen comments further:

“We are unable to influence BASF who owns the patent. They are very aware of the market situation – they slowly lower the price in order to keep competition out of the coming market. ... Beyer does not accept any negotiation on price; they are simply reaping the diminishing market...”

But not only the larger suppliers are causing problems, Nis Petersen:

“In principle we only have unique suppliers – once the recipe is accepted we are locked in. ... The wave of acquisitions during the 1990’s made the portfolio grow quite a bit – and since then we have done little to optimize the portfolio. ... Current changes in legislation create an opportunity to weed out redundant suppliers by re-designing a select set of recipes.”

Redundancy is not the only problem, Nis Petersen:

“We have certain additives which are input to some 250 products. We have to start monitoring those inputs quite closely – and adjust our inventory management accordingly. ... Inventory management principles should reflect the relationship between importance, cost, retention level, and replenishment time for alternative. ... The risk you take is inversely proportional with the inventory levels.”

As risk apparently correlation (inversely) with inventory levels and the number of suppliers of any given input might affect the availability, supplier management must be critically important?

Supplier Management

Nis Petersen explains how the suppliers are managed without the use of models:

“We really don’t need model to tell us how to manage our suppliers – we just need common sense. ... We are in market with reasonably high margins, there’s no incentive to take any chances to gain one or two %. ... We are very pragmatic; we make sure our suppliers understand how important they are to us.”

The supply market does offer some challenges, though. Due to specialization in e.g. production of binders the market consists of very few players causing problems for Dyrup:

“The binders we used were all produced by one company which was traded among venture funds. ... This shortsighted perspective led to a lack of investments and in the end the company went bankrupt. ... A current example is Sigmil Color – we might be interested in acquiring the wood care division to protect our market position. We ourselves contribute to the conflicting rationales: competency versus ROI.” (Nis Petersen)

Suppliers may be treated according to their importance but this is not structured in models or documented in any way. This does not prove to be a problem, though:

“We haven’t experienced a crisis we have not been able to successfully deal with!” (Nis Petersen)

A reactive approach to supplier management seems to be working well?

Dyrup's Supply Chains

Even if the supply base is not formally segmented it is essential to distinguish between local and global suppliers, as the latter support production from common recipes (as contrasted by local recipes). On the downstream side three supply chains are recognized: Sales Companies, Distributors, and Industrial Customers. Combining this information enables the mapping of Dyrup's supply chains – see Figure 7-12 below.

Figure 7-12: Supply Chain Diagram – Dyrup

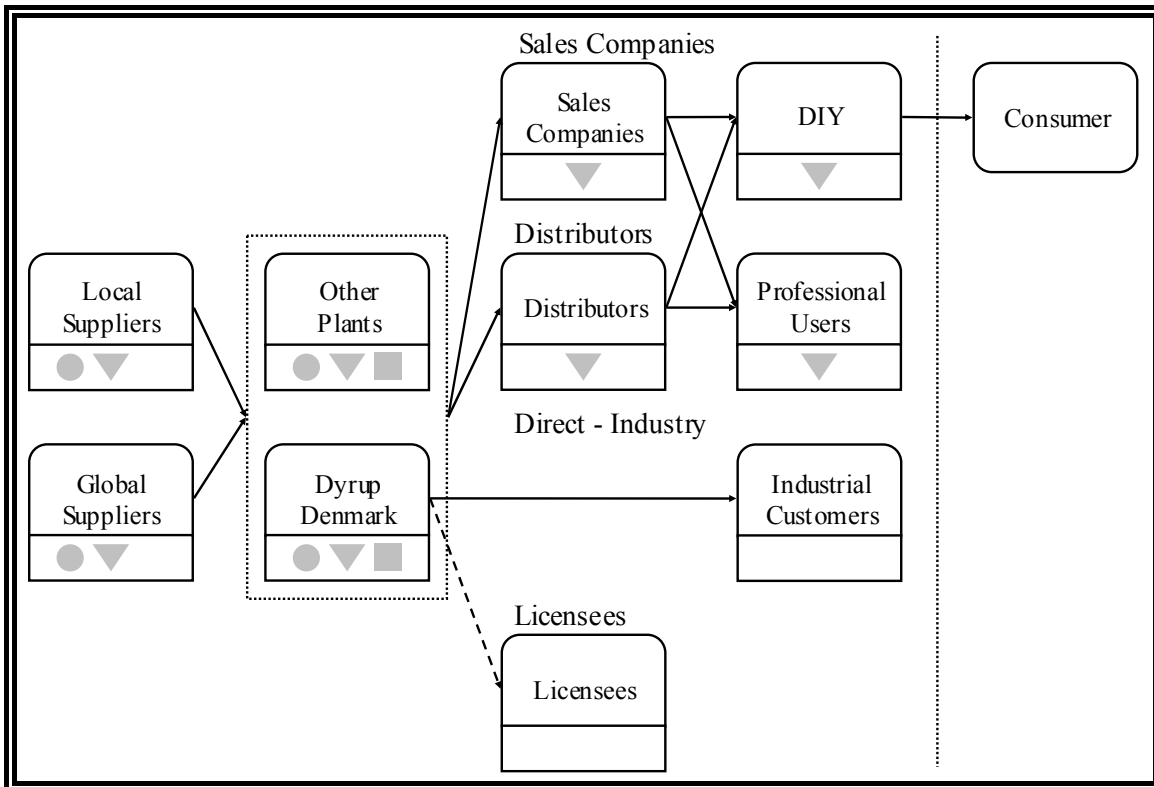

Besides before mentioned supply chains Dyrup also have the ‘Licensee’ business.⁴⁹

Supply Chain Practice

Besides the reduction of the supply base a number of initiatives are being undertaken within the SCM domain. The most dramatic is the implementation of a central SCM department, and the insourcing of production planning and procurement. Only sales and marketing (and required support functions) are retained in the sales companies – both being coordinated from HQ. Coordination of production will also be performed from HQ as will the initiative to outsource non-core activities. Currently all distribution is outsourced, and in France even warehousing is handled by an external party. Figure 7-13 below depicts the organization.

⁴⁹ Depicted in the above model by a dashed line as it is not a real supply chain – the entire operation is handled autonomously.

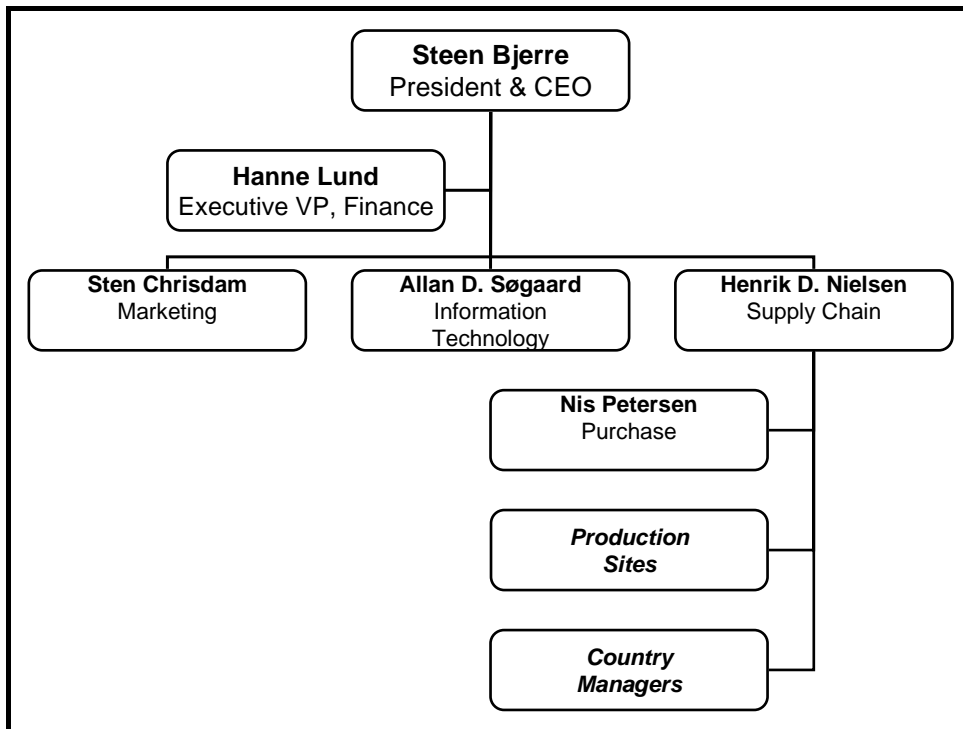
Figure 7-13: Organization Chart – Dyrup⁵⁰

Logistical integration is absent and EDI is only used to a very limited extent. The level of integration is perceived as unsatisfactory, Henrik D. Nielsen:

“We intend to improve within this area, but have certain issues we have to address first. ... After aligning our own operations we might start working more closely with suppliers, but we probably need IT to support this... We need to first simplify and standardize before we can integrate...”

Forecasts are received from the larger customers but these are almost worthless as they are rather imprecise. As a consequence all production is against forecasts – which are only rarely updated as a result of a customer forecast. Campaigns are “built into” the forecasts so even the ramp-up of e.g. new products is driven by forecast. Besides the campaigns also the “natural” demand pattern for the products results in very large inventories – an issue found very difficult to amend, Henrik D. Nielsen:

“The easiest way to reduce inventory is to remove brands or product categories or to trim the portfolio within each brand – but all these approaches are deemed invalid as it would hurt our competitive position. Furthermore, for most products the marketplace contains a competing product so we are stuck. We simply have to keep all these SKU’s in stock.”

It is hoped the centralization of production planning will result in decreasing inventory levels across all sites.

IT Usage

The use of IT is quite limited. The system in place is an old-fashioned, silo/module oriented application BPCS, offering little in terms of interdepartmental reporting and process support.

⁵⁰ Source: Henrik D. Nielsen, Dyrup and www.dyrup.com.

The application has been targeted for replacement by an ERP system a number of times, but so far the investment has been postponed. To enable better reporting a web-based reporting tool has been put in place, supporting marketing, production, and procurement alike.

“The Bucket Incident”

So, even if the SCM practice seem quite simple as each production basically was an autonomous entity with a single well-known production technology and a rather limited number of long-term suppliers, challenges existed.

At the initial interview with Dyrup Finn Aa. Andreassen (Logistics Manager)⁵¹ described some of the problems he was currently struggling with. Some time earlier, a supplier of packaging material (pre-printed buckets) had let Dyrup know that they had decided to discontinue the production of the buckets. In an act of good faith they gave Dyrup a warning of 1½ years to prepare for the switch of supplier, and agreed to let Dyrup place bulk orders just before discontinuation to extend the “switch-over period”. The bucket was not considered unique as size, material, and shape were more or less standard - but the bucket had product information, company logo etc. printed on the side. After a thorough search in the market for a replacement supplier for buckets with print on the side, the company was quite stunned to learn that no suppliers of such products existed within a reasonable distance to the production sites. Some suppliers of buckets existed, of course, and since they promised they would be able to produce buckets with print in an acceptable quality, a supplier was chosen and test production soon after began. It quite quickly became apparent that the printing of product information and the logo’s etc. was somewhat more complex than first assumed as text and logo was smurred. The issues were resolved in the end but it took the company more than two years to have an acceptable solution in place⁵².

Another Example...

Another example is the case of the French company producing acids for driers (component in paint and wood care products). The company was the sole supplier of this component and was located in a small city in rural France. The outbreak of Legionnaire’s Disease coinciding with the election for local government resulted in a bit of a panic and all industrial production was temporarily shut down. Following a very long (and politically motivated?) investigation it was decided to revoke the license to produce the driers. Luckily Dyrup had stocked up on this component and was able to get by until a new supplier could be identified

⁵¹ The majority of interviews on SCM related issues were performed with Henrik D. Nielsen as Finn Aa. Andreassen left the company in late 2003.

⁵² Quite interestingly Finn Aa. Andreassen, Henrik D. Nielsen, and Nis Petersen all had different recollections of the circumstances around Metropack. The former described the case as a planned discontinuation of a product, the second described it as a bankruptcy, and the latter described the root cause as not being a logistical problem, but a problem of resistance against change...

SCRM Practice?

Only quite recently has Risk Management received any attention. During the initial interview with Henrik D. Nielsen in 2004 he described the current practice:

“The approach to risk management has traditionally been very reactive – incidents were the sole source to improvement. E.g. the strike in 1998 resulted in the creation of a contingency plan for production and distribution. ... Currently we have no risk management personnel within logistics/SCM but a position referencing Top Management was filled December last year [2003]. So far we have seen no concrete results...”

He goes on to describe how the cost of insurance (Loss of Production) is not a trigger for this initiative and explain how the board has insisted on focusing on risk management as a result of the decision to centralize all production in Denmark at the site in Søborg. Nis Petersen disagrees:

“We have identified only one driver for Risk Management: insurance. Besides this issue we really do only have to fear shortage of inputs. ... We do not have to fear e.g. bankruptcies amongst our suppliers - BASF and Beyer are both very solid companies. ... For the rest of it – it is really a matter of adjusting inventory management principles and inventory levels according to usage and the supply situation...”

Nis Petersen thereby seems to have opinions directly contradicting the opinions put forward by Henrik D. Nielsen – and ends the interview with a warning⁵³:

“The more lean a company gets, the more it relies on very few people. This should really be taken into consideration when implementing such changes [centralization of production in Søborg]...”

When re-interviewing Henrik D. Nielsen in 2005 the Risk Management practice is still absent:

“We still have seen very few results [from the Risk Management initiative] besides from achieving lower insurance premiums. A short list of risks has been documented and we have to report certain key figures periodically. But we have no proactive Risk Management practice in place. ... We have contingency plans in place, though – and can react pretty effectively to e.g. a fire.”

Working with Risk Management at Dyrup has had its advantages:

“It has enabled us a clearer picture of our IT situation – and in the longer run I believe it will enable us to look further ahead when setting goals and developing strategies...” (Henrik D. Nielsen)

Summing Up...

Dyrup is presently changing their SCM practice in order to cut cost and improve customer service. The nature of the product limits the extent to which production can be optimized as

⁵³ Nis Petersen also describes how the management incentives schemes are increasing risk and cost. Management allegedly is measured on inventory levels as by end of year. Therefore production is idle in November and December – and operates double shifts in January and February.

e.g. production postponement is probably unrealistic due to transportation costs. Inputs may be standardized, though; a level of standardization of production equipment will enable standardization of recipes enabling shifting of production from one plant to another.

On SCRM little is currently being done. Results from the Risk Management initiative are still absent – and there are no indications focus will be on the supply chain risks.

7.5 Fritz Hansen a/s

Fritz Hansen, the founder of the company, registered as a master cabinetmaker on October 24th, 1872 in Copenhagen. He initially specialized as a manufacturer of furniture parts such as chair legs, balusters and iron frames. In 1915, after many experiments, the first Danish chair in steam bentwood was launched at Fritz Hansen's new factory in Allerød north of Copenhagen. It was an immediate success, and in the next decades many pieces of functional furniture in steam bentwood followed. In the mid 1920's Fritz Hansen started a productive teamwork with leading furniture architects and designers. This teamwork is directly observable in the product portfolio which is made up of famous designs of classic and contemporary Danish and foreign designers such as Arne Jacobsen, Piet Hein, Poul Kjærholm, Hans Sandgren Jacobsen, and Kasper Salto. Over the years Fritz Hansen a/s has built up a comprehensive collection of furniture designs from the solid wood classics of the 1930's to completely new stacking chairs and advanced office chairs – all based on a minimalist and functional design philosophy.

A Crisis Emerges

During the 1990's the company experienced serious difficulties. Sales dropped and the costs were increasing and in 1998 a new managing director (Jacob Holm) was appointed. Problems were addressed promptly:

- The sales problem was addressed by investments of approx. DKK 100 million in the foreign markets Japan and USA and by strengthening the effort in southern Europe. The select group of local representatives was supported by the setup of show rooms and the appointment of two new sales executives to cover USA/Canada and UK, respectively.
- The cost problem was addressed by means of outsourcing and downsizing. Questioning the acclaimed core competences of the then traditional manufacturing oriented company had surprising results as it was realized upholstery no longer was a core competence. Except for upholstery of high quality leather items, there were no (quality) problems in outsourcing this competence. Other parts of the company (e.g. the smithy) were outsourced as well, but more importantly: the focus of the company was changed from being manufacturing oriented to sales and marketing oriented.

Alongside these changes the plant at Vassingrød (FCA) was established. Being a highly automated (process-oriented) and specialized manufacturing plant it represents an investment of DKK 200 million. The decision to build the plant was taken prior to the above described changes and based on an anticipation of steady growth in the sales of the Series 7 products⁵⁴, chairs manufactured using an updated version of the steam bending technology which started the company. The plant was opened in 2002, and after some initial problems it is now operating to specification. Unfortunately, the demand for those products has turned out to be quite a lot lower than expected. The plant is therefore only operating in one daily shift instead

⁵⁴ For more info, see www.fritzhanzen.com.

of the expected two or three daily shifts. This production still accounts for approx. 40% of total turnover⁵⁵. The outsourcing of activities led to the initiation of the LEAN project in 2001, and more dramatic changes to the “old” manufacturing plant (FCL), co-located with headquarters in Allerød.

LEAN Manufacturing

Following the successful outsourcing of most of the manufacturing activities (and the shift in procurement from raw material to components) the next step for Fritz Hansen a/s was to minimize inventory costs by implementing LEAN Manufacturing. This meant getting rid of all WIP inventory and to change the production philosophy from product- to process-orientation⁵⁶, from batch-production based on forecasts to production against firm orders.

Figure 7-14: Goals for Fritz Hansen's LEAN project⁵⁷

Goals for the LEAN project:

- Shipping Precision $\geq 96\%$
- Claims $\leq 2.5\%$
- Cost of Goods Sold – yearly decrease of 2%
- Order Cycle changed from 15 weeks to less than 5 weeks.

Stock keeping of finished goods was abandoned and the layout of the factory was changed as a single-string conveyor system was installed. Work stations were designed for the initiation of the production order, for the kitting operation, and for the assembly, quality assurance, and packaging operations. Planning and production systems were integrated, and barcode scanners were installed. Distribution was outsourced to two TPL's: Windum for local distribution and Leman for the rest of the world. As both operate warehouses consolidation of orders and sometimes larger projects is done at their site by means of interim warehousing.

Outsourcing the Production of Tabletops

Considered a core competence the production of tabletops (at the plant FCB) was outsourced at a somewhat slower pace. At first production of standard tabletops was outsourced to a trusted supplier. After a period of time the supplier was trusted to produce even the special tabletops for customer orders, and finally the supplier was offered to buy the machines and tools, in turn for guaranteed turnover with Fritz Hansen a/s. All tabletops are now purchased from this supplier who generates approx. 25% of his turnover from orders with Fritz Hansen.

⁵⁵ The FCA plant is of marginal interest to this study (except for the fact it represents a distinctively different business model) and is therefore only referenced when necessary.

⁵⁶ For a description of these OM concepts, refer to e.g. Hill (2005) or Stevenson (2005).

⁵⁷ Source: Henrik Holm, Fritz Hansen a/s.

Early Problems

It was decided initially to do a partial implementation of the lean principles to get some experience before implementing them across the product portfolio. A few of the top selling products were selected and the suppliers of the main component (e.g. seats) were approached and introduced to the ideas of lean manufacturing. All were quite excited about the idea and of the opportunity of being more closely integrated with Fritz Hansen.

It quickly became obvious that the suppliers had made promises they could or would not keep. Henrik Holm (Logistics Manager) commented during an interview in 2004:

“We really made an effort in explaining the principles, but they may not have understood the consequences... We have worked with some of these suppliers for years and years, but they still decided not to accommodate our wishes... We have been able to work with some of these suppliers, and have them minimize their order sizes to e.g. one order per week, instead of one order per month – and that’s still an improvement...”

Besides identifying Supply Partners the other suppliers had to be managed better as well as the inventories were cut dramatically. At the start of the Lean project the inventory was at a staggering DKK 70 million – cutting the inventory level had consequences for the throughput of the assembly plant. Marianne Thompson (Supply Chain Planner):

“We realized that we had to update all the BOM’s⁵⁸ as we kept running out of items for the assembly operations. It was quite a lot of work...”

The updating of master data had the desired effect: the dependent requirements were now correct, but the problem with lack of delivery precision became a bigger and bigger problem for the Supply Chain Planners. Marianne Thompson:

“For some reason we still experience halting the assembly line due to a shortage... It’s strange we are not able to solve this problem...”

Rudi Kjeldsen (Supply Chain Planner) offers an explanation:

“...every time we investigate [the shortage] we conclude it is down to the delivery precision of the supplier. We have done our jobs – but the supplier fails to deliver on time, or lets us know too late that he can not meet the deadline.”

When a shortage occurs, the result is a pile-up of semi-finished products in production areas. The production does not come to a complete halt though, as people can be asked to perform other activities, such as assist in the assembly operations not performed using the conveyor system. Alternatively personnel can be transferred to the packaging area, or be asked to perform a general clean-up or perform a cycle count on a section of the assembly line inventory. Solving the problem of poor delivery performance is made difficult by several factors, Bo Rasmussen (Factory Manager) explains:

“Some of the suppliers are so much larger than Fritz Hansen that it is quite difficult to put pressure on them. We had one incident where we tried to put

⁵⁸ Bill-of-Material – a production document containing the specification of input required for the manufacture of the top level item. Used by planning systems such as MRP to identify “dependent requirements” i.e. inputs to the production. For more info, please refer to e.g. Hill (2005) or Stevenson (2005).

pressure on a supplier to increase quality and delivery precision. Unfortunately, all they said was: 'Fine, you can pick up your moulds later today'. That called for some fine diplomacy, but we managed to save the relationship and get a better service."

Supply Management

Apparently this 'lock-in' situation is not uncommon at Fritz Hansen, Bo Rasmussen:

"We really do not have that many commodity suppliers. Most of the input we get is unique... In principle we might have alternative suppliers for all aluminum items, for instance, but a tool still cost approx. DKK 500.000".

The Supply Chain Planners agree that some products might be "over-designed" as even non-visible bolts for a couple of products have to be made special. Apparently over-design of products is a bit of a company joke, as the supply chain planners comment keeping a deadline is unheard of in the product development department. Marianne Thompson:

"It has no consequence for the product developers to miss a deadline, even if it has severe impacts on our [the Supply Chain Planner's] jobs. ... We struggle to meet the final deadline, but it's become increasingly difficult with R&D's overrun of deadlines..."

One way of simplifying the job is to use systems suppliers, as this will minimize the supplier portfolio and ensure high availability of a wider range of input. Even after discussing the risks of integrating with a systems supplier, Rudi Kjeldsen insists:

"But, if we choose to work with e.g. Sanistål⁵⁹, we are able to finance their overhead by the discounts they get from being a bigger customer. ... All other things being equal, the improved delivery precision must improve our own operations."

Freeing up time is essential to the Supply Chain Planners:

"The way we divide the work between us does have its disadvantages⁶⁰.... As we are responsible for a range of finished products we never have the time to fully understand all the markets we are in... We do not have the time to investigate what is going on within e.g. small-items plastic molding."

And further that it does not have any appeal to re-structure the supplier base:

"There's no reward in analyzing the supplier base... We have discussed it a number of times, and still it is not being done..."

Certain improvement with supplier management has taken place, though:

"Earlier we did not have a say on the choice of suppliers for new products, the product developers were doing that themselves, and we were being told when it was too late to change anything. Now, at least we are involved in the process, and the product developers have to have strong arguments to introduce new suppliers. Earlier, whenever we got a new product developer he or she would bring along a whole set of suppliers he was used to working with."

⁵⁹ Danish wholesaler within HVAC, steel and other metals, tools, machinery, and technical products. For more info, please refer to www.sanistaal.dk.

⁶⁰ Supply Chain Planners are each responsible for a part of the product portfolio.

So, implementing LEAN meant dramatic changes and was a catalyst for discussing more overall, strategic issues. Diplomacy was also needed internally within Fritz Hansen.

Production in Denmark?

During these changes discussions on the rationale behind the production/logistics setup took place. It was no longer evident that products actually had to flow through the plants in Denmark. In case the component, e.g. the seat of a lounge chair, was manufactured outside of Denmark, and all that remained to be done was to fasten the foot of the furniture, this might just as well be done at the supplier's site?

Bo Rasmussen and Marianne Thompson recall:

“It was especially the people from Sales & Marketing who worried over the impact of losing the ‘Made in Denmark’ tag. Even in the Japanese markets they do not want to see ‘Made in Hong Kong’ - even if the quality is the same.”

Jacob Pedersen (Supply Chain Coordinator) supplements:

“...it really does not make sense to perform the assembly here, it might just as well be done by the manufacturer, or by the TPL... We polish the product and pack it for distribution – adding that Fritz Hansen feeling...”

The marketing people had their way and instead of outsourcing the entire operation, the plant was changed into an assembly operation.

LEAN Today

Since the initial round of interviews in 2004 the implementation of LEAN has progressed quite successfully. The goals for the project have been reached and as many as 5-8 suppliers are now certified Supply Partners. They are all trained in the LEAN principles and their IT systems are integrated with Fritz Hansen's forecasting system. Surprisingly, the company does not want to convert all suppliers to Supply Partners, Henrik Holm explains:

“Not everybody can become a Supply Partner. It depends on the market the supplier is in. ... If the inputs delivered are standard, there is no reason to enter into a partnership. ... As a supplier you will need to be able to participate in product development, and are most likely involved in more than one critical product already.”

Being a Supply Partner is thereby a special privilege for the select few, who in return are expected to be in the forefront of their field and willing to participate in joint product development⁶¹.

The push-principle is fully implemented as only interim inventory exist at the distributors warehouses. All orders are produced against firmed customer orders, and orders are shipped either to the selling partner or directly to the project site or to the end consumer. The only manufacturing remaining in Allerød is the production of slow movers, certain leather items,

⁶¹ The supplier base is thereby in reality only segmented into Supply Partners and Others. Before LEAN the company had A, B, and C suppliers but introducing Supply Partners has collided so fundamentally with the previous typology that it has lost meaning. Currently, Henrik Holm is working on redefining the A, B, and C classes.

production of the very expensive pieces, and of all-wood furniture. All fast-movers are assembly-only freeing up space and capacity for production of before mentioned items.

LEAN Impacting Product Development

Product development has also been influenced by the implementation of LEAN. The customer orientation implied has had very direct consequences for the design methodology, Thomas Touborg (Supply Chain Director) explains:

“At some stage we inquired the sales and marketing about introduction of the new products, and they jumped at the chance to change the practice. They asked for (and got) a more market oriented approach to new product introduction. ... Currently, we have two introduction periods: October 1st and April 1st.”

Thomas Touborg explains how previously the designers had more or less free hands to continue developing on products:

“Of course they had deadlines, but when they realized they could not meet a deadline, it was just changed. ... They had no incentive to stick to the plans made and agreed upon, and they obviously were more interested in designing a beautiful product than making sure the logistics and production issues were resolved...”

Now, product developers must have all specifications ready and to hand over one year before the products launch date. Deadlines can not be moved, and it is considered critical if deadlines are not met. This has resulted in product development routinely setting up alternative plans when encountering problems in designing the products. Late changes are only accepted if functioning solutions exist already, and major changes to a design will require the project plan to be altered making sure at least one solution will be available at the hand-over date⁶². Furthermore suppliers play a much more central role in product development now than before, as they participate from start till end.

Due to the criticality of taking logistics and production issues under consideration when designing products, parts of product development is now part of the SCM department, see Figure 7-15 below.

Customers, Partners & Competitors

Sales is more or less evenly divided between project and consumer sales, but all sales is processed through a partner. The network covering the world consists of approx. 400 partners (hereof 70-80 in Denmark). Currently the company is focusing on strengthening the consumer sales through more aggressive marketing.

The partners are not franchisees in a system like McDonald's but are all independent furniture retailers, marketing a wide range of products. Partners are expected to maintain a certain standard and to present the products of Fritz Hansen in a certain way, and are offered help e.g. in decorating their shops. The partners are the only outlet for Fritz Hansen's products and

⁶² One might say that processes and routines in product development have been changed to include management of the risk of not meeting the deadline?

partners are therefore expected to be able to carry out sales to end consumers, architects or facilities managers, and government purchasers.

Paradoxically, the company does not perceive itself as competing with other furniture manufacturing companies. Thomas Touborg:

“Our primary competitor is AUDI, or so we like to say. ... If handed 100.000 DKK, some people would like to refurbish their kitchen, some would like to trade the old Passat in for a new Audi, and still others would prefer to buy something for their living room. ... We would like the consumer to pay attention to the Fritz Hansen brand instead of noticing the products.”

In a way the product portfolio is both a blessing and a curse as (at least some of) the products are so well known they basically sell themselves. The Fritz Hansen brand thereby gets buried under the brand names of their products.

The Organization’s Structure

As illustrated below in Figure 7-15 the company has a traditional functional structure. Not so common though, is the fact that SCM has replaced Logistics, Purchasing, and Production, implying a process orientation in fulfilling customer needs. And as described above, the SCM department encompasses Development & Quality as well.

The sales department has the responsibility of managing the Fritz Hansen brand as well as managing the before mentioned 400 partners. To ensure a proper contact between HQ and partners, the department is structured around markets, ensuring knowledge of the local context when interacting with partners.

Somewhat surprising the IT function is placed under the responsibility of the Finance department, a constellation that went “out of fashion” many years ago. For many companies, the Finance department was the first place where IT was put into use, and therefore IT was often placed under the responsibility of the head of Finance. But since then the accounting task has become more or less standard (at least from an IT perspective), lessening the necessity of having IT close to Finance. Often modern companies find it more beneficial to have the IT department being integrated into the market oriented departments, e.g. Purchasing or Sales, or in the SCM department⁶³.

⁶³ The author has worked with the IT field for more than 15 years. The comments are based on his general knowledge of the field.

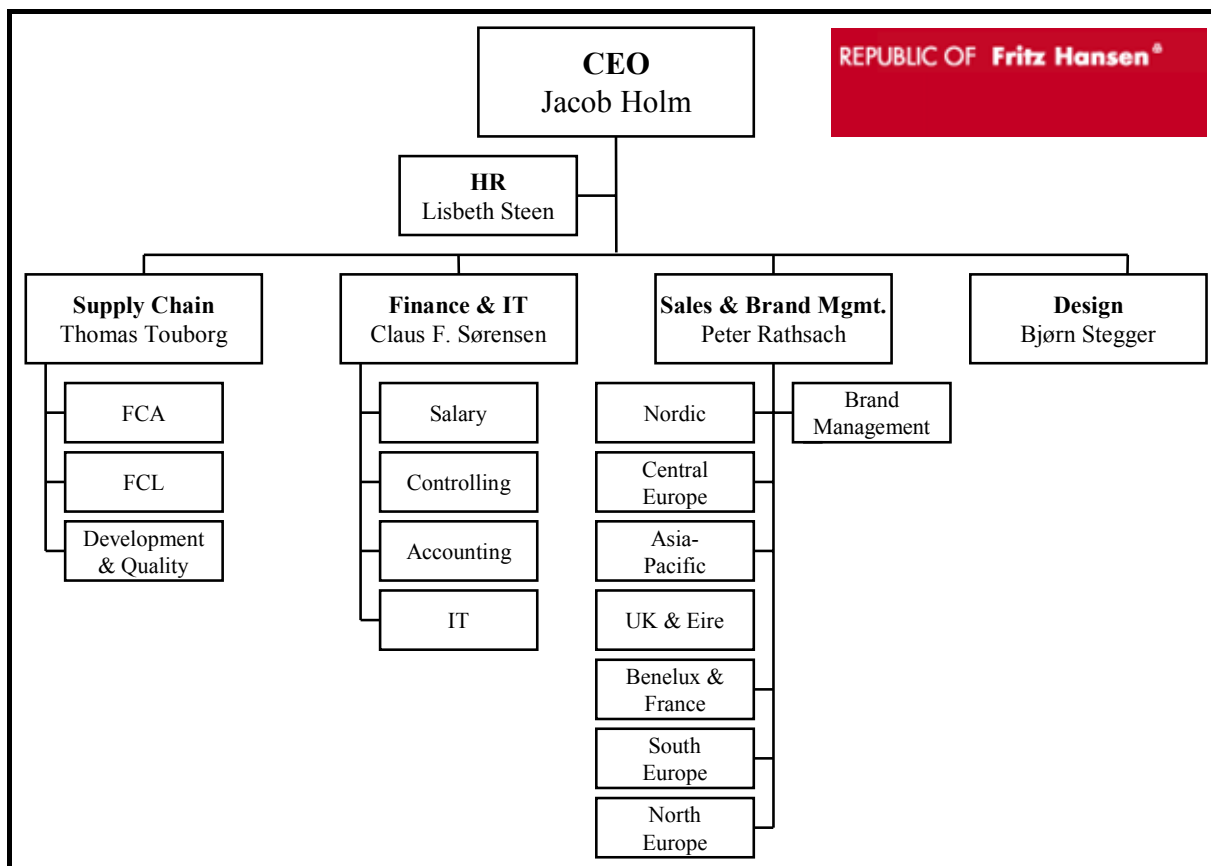
Figure 7-15: Organization Chart – Fritz Hansen⁶⁴

Product Portfolio

As described previously the product portfolio contains a lot of designs from the 1930's onwards by famous Danish and foreign designers. Even if some of the products are considered "classics" the product portfolio needs to be updated continuously. This is achieved in the following three ways:

1. young, upcoming designers send designs to Fritz Hansen,
2. designs already in production at other furniture manufacturers are bought, and
3. Fritz Hansen decides to supplement the portfolio by inviting known designers to participate in developing new products.

For all products put in production a royalty fee is paid out to the accredited designers, in return for which Fritz Hansen has the right (and obligation) to produce and market the products, normally for a period of 70-80 years⁶⁵.

Financial Status

In the five year period since the turn-around was initiated the turnover has fluctuated between DKK 344 million (1999) and DKK 425 million (2001 and 2002) of which approx. 70 % are

⁶⁴ Source: Thomas Touborg, Fritz Hansen a/s.

⁶⁵ Obviously, contracts are somewhat more sophisticated than indicated here. Normally Fritz Hansen would be obliged to advertise for the product in specified countries using specified channels of communication. In case of declining or otherwise disappointing sales, the designer (or the heirs) has a right to revoke the contract, and go to some other furniture manufacturer.

generated from exports. The number of employees has decreased steadily from 331 (1999) to the current approx. 220.

Table 7-10: Financial Profile – Fritz Hansen a/s

End Date	Turnover	Profit Before Tax	No. of Employees
2005-06-30	395.775	19.792	204
2004-06-30	351.885	17.361	204
2003-06-30	378.991	12.413	235
2002-06-30	425.854	9.303	279
2001-06-30	425.202	26.327	311
2000-06-30	365.423	23.410	304

SCRM Practice?

As illustrated in Figure 7-15 above, there is no department for (Supply Chain) Risk Management. But as described above a number of changes in processes as well as organization structure is directed at managing identified risks. The company naturally manages the traditional risks: the risk of a customer not paying the bill, the risk of a fire in the factory, the risk of fraudulent behavior in finance etc. These routines are in place, but Fritz Hansen has definitely gone further in trying to ensure the stability of its operations. Thomas Touborg explains the developments taking place right now:

“Of course we have insurance covering the destruction of the factory. But the insurance will only cover the direct costs, not the loss of market share. ... We estimate the consequence of an absence from the market of 18 months [estimated time to rebuild the factory] will cost us 50% of our market. ... We therefore are working on creating small-scale exemplary supply chains.”

He continues to explain how the critical products are going to have a back-up supply chain, preferably by existing suppliers. In case of an accident, the supplier will be asked to ramp up their production capacity, to enable Fritz Hansen to supply to the most important customers.

So even if the company is quite sophisticated in terms of risk managing their supply chains, there are still things to take a closer look at, e.g. the dependency of suppliers. Henrik Holm describes how the practice has changed:

“After your last visit, we have changed our view on who we want partnerships with. As we discussed it may be a waste of resources to build and maintain a partnership with a supplier in a perfect market – there are no advantages! ... What is really troubling is the fact that we have created some of this dependency ourselves!”

Whether they like it or not Fritz Hansen is dependent on a number of suppliers, and like other companies described they have chosen to hold meetings regularly with the most important ones. Before each meeting the latest financial statements are analyzed to see if the company is making enough money, Henrik Holm:

“From the financial statements we calculate a couple of KPI’s – this gives us an idea of their financial state, if they are making money or not. ... In case they are not making money, we either try to help or are cautious on making commitments.”

Thomas Touborg:

“We intend to have a dialogue with all our critical suppliers, and make sure we are perceived as a good customer. If they do not consider us an attractive or important customer, we’d better find a means to mitigate that.”

Summing up, the risk management practice at Fritz Hansen is somewhat fragmented. But some of the practices under way is quite sophisticated, e.g. the creation of ‘redundancy supply chains’ and the risk management implemented in the integrated product development.

SCM Practice

Considering LEAN a sort of SCM, Figure 7-16 below illustrates the supply chains identified at Fritz Hansen.

Figure 7-16: Supply Chain Diagram – Fritz Hansen⁶⁶

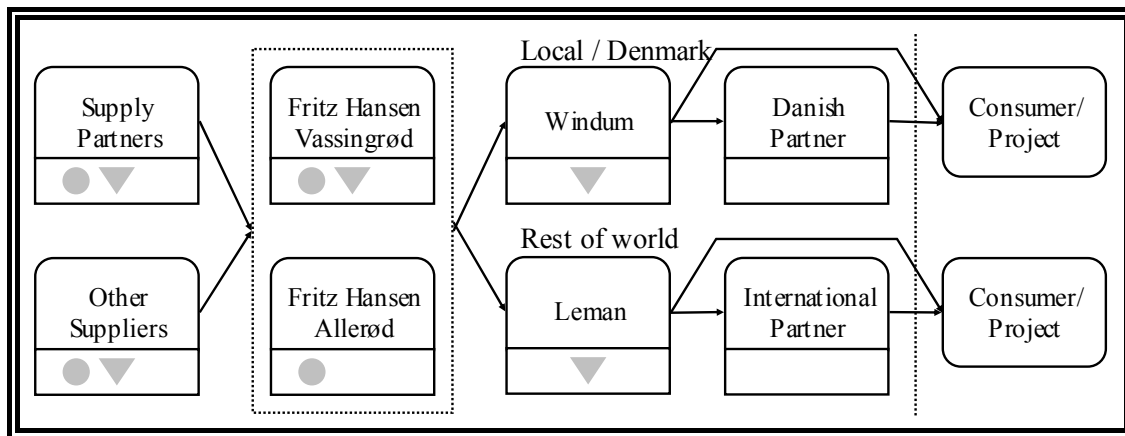

As the A/B/C typology for suppliers is currently under revision, the supply side is depicted as consisting of Supply Partners and Other Suppliers only. With the re-introduction of the A/B/C (or some other?) typology, the supply chain diagram will have to be changed.

As described, the changes to production philosophy, inventory management practice and supplier management has not occurred out of the blue, but has been supported by formal organization (see Figure 7-16 above). Details of the SCM department are depicted in Figure 7-17 below.

⁶⁶ Actually the two sites have two distribution channels each, but it seems irrelevant to draw four supply chains. Alternatively, the production taking place in Allerød is actually split into assembly (for the majority of products) and crafts-based production (for the very expensive wood products). Therefore a third supply chain might be included in the figure.

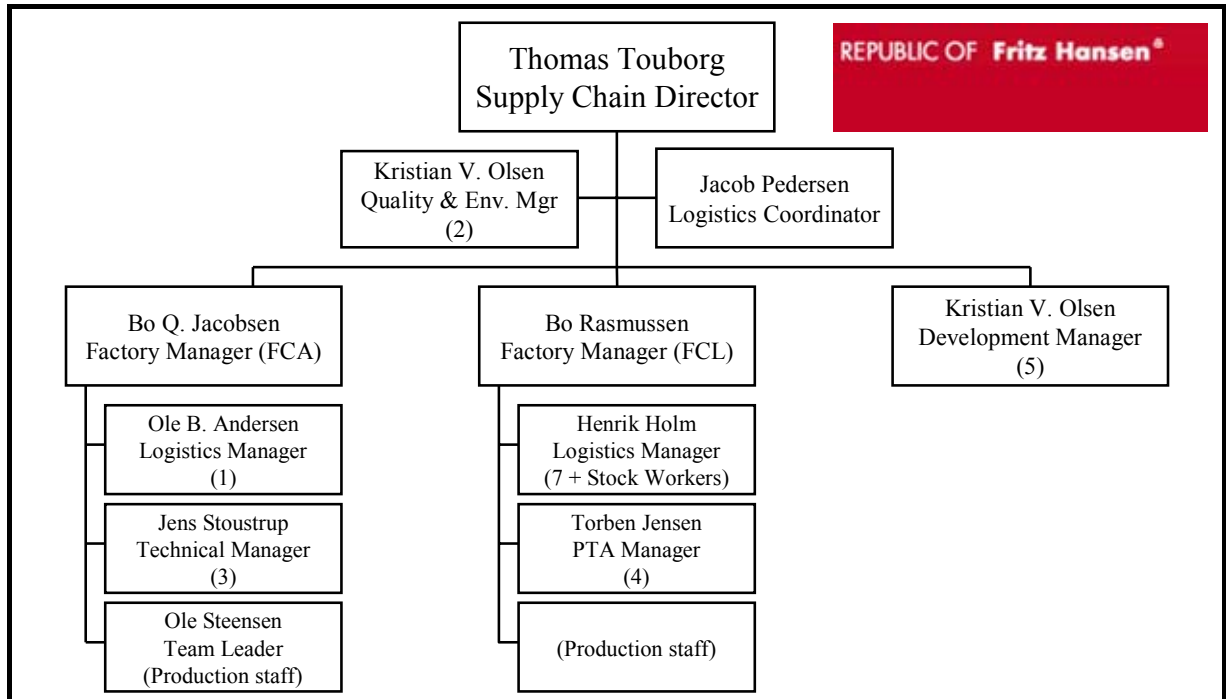
Figure 7-17: Organization Chart (SCM) – Fritz Hansen⁶⁷

The two manufacturing unit (FCA and FCL) are quite different as FCA is cost minimizing by producing few products on a highly specialized and automated setup. The other unit (FCL) which has implemented LEAN has digressed to low-tech assembly and a flexible setup supporting “batch sizes of one”. The quality and development functions are available to both, as is access to the logistical setups with distributors and the partner network.

From the first interviews in 2004 to the last performed in August 2005, the company has been able to successfully turn around the operations at FCL to support the ideal of zero inventory, shorter order cycles, lower costs and higher precision in outbound shipments. KPI’s collected to support the continued improvements include Cost, Flexibility, Shipping Performance, Total Order Cycle, and Quality⁶⁸.

The system relies on IT support, which is provided by a modified MOVEX application in concert with a “home grown” application giving customers and suppliers access to relevant information. Customers can see their orders and have access to “Track & Trace” functionality whereas suppliers have access to their performance evaluations and outstanding orders.

Still Just Work in Progress...

A lot of work still lies ahead as the supplier base has to be re-structured to support the Supply Partners and the product portfolio needs to be analyzed for critical products needing supply chain redundancy. Henrik Holm and Thomas Touborg concur:

“Albeit the progress we have made, we still have our work cut out for us: we need to ensure stability through making sure our suppliers consider us an

⁶⁷ Source: Thomas Touborg, Fritz Hansen a/s. Numbers in brackets denotes number of direct subordinates.

⁶⁸ The KPI’s all have precise translations in the system, e.g. Cost is really Total (or Landed) Cost and Quality is measured as number of claims against number of deliveries.

attractive customer. Furthermore we need to investigate if we are dependent on the right suppliers?”

Summing Up...

Also Fritz Hansen has undergone dramatic changes, and also for Fritz Hansen the catalyst was financial problems. The analysis of the value of perceived core competencies revealed that the world had changed, and that the company needed to alter the business model. Not much could be done in relation to the FCA plant (the highly specialized plant producing chairs based on the bent wood technology), but the production at the FCL plant could be altered. The solution chosen to address their problems was somewhat more conceptual than the previous case studies, as they chose to implement LEAN Manufacturing (albeit modified during the implementation). At the most overall level this solution implemented resembles the changes implemented at Bang & Olufsen: inventories are removed, and distribution is changed to direct shipment. But since the inventory keeping of finished products is (almost) completely abolished, Fritz Hansen's solution is more extreme than the others described.

Obviously this business model results in a “lock-in”, at least in the short run. Selected suppliers are educated to participate in the JIT operation, systems are integrated, and distribution solutions are designed. The operation is altered from a manufacturing operation to simpler assembly, retaining only manufacturing of the very expensive products and slow movers. After the inevitable start-up problems the final assembly performed at the FCL plant is now proceeding with acceptable results.

Again the level of formal risk management and SCRM is surprisingly low – especially due to the insights into the problems and challenges of running a LEAN operation acknowledged by both Thomas Touborg and Henrik Holm. As operations will break down if only one of the suppliers exit the network, Fritz Hansen is in continuous contact with the supply partners – ensuring problems are solved as quickly as possible.

7.6 LINAK A/S

Much has happened since Christian Jensen, the grandfather of LINAK's present Director and Owner, established the company in 1907. At that time the company manufactured flat belt pulleys, V-belt pulleys and grinding mills for preparation of corn and forges to technical schools - something quite different from the state-of-the art products which are manufactured at LINAK today. In 1976 as a newly graduated mechanical engineer Bent Jensen, the present CEO and owner of LINAK, took over the company, Chr. Jensen and Sons, after his father. Bent Jensen was not overly enthusiastic about becoming the owner of the family company with 7 employees. He would have preferred to go abroad to work, but his father succeeded in persuading him to stay at home. Bent Jensen gave himself 5 years to develop a new product and used the time to also rationalize the existing production before he in 1979 got the right idea - the linear actuator.

The Linear Actuator

An actuator is a unit which converts the operating voltage from the control box into a (linear) movement. It consists of three principal elements: motor, gear, and a spindle. To control the length and speed of movement the product comes with a control box and a control. The “original” invention was the linear actuator, but since then rotary actuators have been added to the product portfolio along with twin actuators, various types of built-in actuators and a wide range of accessories. The possible application of the actuators are many as lifting capacities range from 200 N – 10.000 N, furthermore some actuators are built for high temperatures or other harsh conditions. The portfolio consists of more than 10.000 different articles including customized combinations and various accessories. Supplying components for use in other companies’ products classifies LINAK as an original equipment manufacturer (OEM). With an actuator representing as much as 30-40% of the cost price of the end product, LINAK has to ensure the competence marketed through the components is cutting edge.

Milestones

Since LINAK began manufacturing linear actuators in 1980 the company has grown rapidly. The expansions in Denmark and abroad have resulted in LINAK being the world leader in designing and manufacturing electric actuator systems. The LINAK of today is quite far removed from the smithy started by Christian Jensen in 1907. The development from local smithy to international company has not been without dramatic changes. Important milestones in the company’s development are listed in Table 7-11 below.

Table 7-11: Milestones – LINAK A/S⁶⁹

Year	Description
1907	The company is founded by the grand father of current owner/CEO.
1976	Bent Jensen takes over the company.
1979	Bent Jensen invents the linear actuator.
1980	The linear actuator is put in production.
1984	The company changes its name to LINAK A/S. (LI Near AK tuator)
1985	LINAK opens its first sales office abroad, in Sweden.
1986	An electronics department is added to the organization. In the years to come the electronic controls become a more and more important component in the products, and intense development is performed within the electronics field.
1989	A separate company for sales in Denmark was created. LINAK Denmark A/S is situated in Silkeborg. Actuation systems for hospital and care usage are introduced.
1990	LINAK opens its first subsidiary abroad, in Great Britain. The company is situated in Smethwick, West Midlands. Since then LINAK has opened one or two subsidiaries each year all over the world.
1992	The company is awarded “The Golden Anvil” by a regional newspaper, JydskeVestkysten. This award is the first of many awards won in the following years.
1995	The company receives the “Mads Clausen Award of Honour” ⁷⁰ .
1998	The DESKLINE system is developed. The company receives “The Award of Honour” from The Danish Society of Polio and Accident Victims.
1999	A factory producing the CARELINE and HOMELINE products for the US markets is opened in Louisville, Kentucky. LINAK is awarded “Entrepreneur of the Year” by the accounting and consultancy firm Ernst & Young.
2000	LINAK is awarded “The Mark of Honour of King Frederik the 9th for meritorious effort for Danish exports” by His Royal Highness Prince Henrik of Denmark and is awarded “Workplace of the Year 2000” by the General Workers Union in Denmark.
2001	The company reached an annual turnover of 1 billion DKK. The daily financial paper “Børsen” awards LINAK “Gazelle Company 2001”. The BPR project “Efficient Organization” is initiated.
2002	A new round (!) factory is opened - all production of DESKLINE products is moved to this unit. The DESKLINE division is a reality.
2004	LINAK is awarded Post Denmark’s “Supply Chain Award”. A new class of products, TwinDrives, is introduced in the HOMELINE division.
2005	As the first Danish company, LINAK obtains approval to export to China. ⁷¹

As described in Table 7-11 above LINAK has followed the traditional path for internationalization found in so many Danish companies. With the opening of the first sales office in Sweden in 1985 and the first subsidiary in Great Britain in 1990, LINAK started the dramatic expansion of the geographical coverage.

Business Process Reengineering

After a long period of constant expansion and increase in turnover (and a more or less constant cost rate) in 2000 costs were increasing. LINAK was under increasing pressure from low cost producers in Eastern Europe and the Far East, and managerial intervention was needed. Management developed and analyzed a number of scenarios – hereunder moving parts of the production to Hungary. The analysis showed that approx. 20% of the cost price was salary, and after adding increased transportation cost etc. it was estimated that savings in





⁶⁹ Source: www.linak.dk and www.linak.com.

⁷⁰ Mads Clausen is the CEO of Danfoss, another prominent Danish company.

⁷¹ By January 1st 2005 a new law was put in effect making it possible for companies to obtain approval to export goods to China. Up till then only locally produced products could be marketed. LINAK was the first Danish company to obtain this approval, and number 41 in the world! LINAK has plans to start production in China within the next three to five years.

the range 5-6% could be achieved. After discussing the situation with employees and the labor unions, it was decided to try and fight back instead of simply outsourcing the cost problem. After a preliminary analysis it was decided to initiate a project, the Business Process Reengineering project, to alter the cost structures by changing the way production and sourcing was carried out. In the project no less than eight separate sub-projects were identified, the two most radical were to redesign the company's processes and to organize around four product divisions: CARELINE/MEDLINE, TECHLINE, DESKLINE, and HOMELINE (see Table 7-12 below).

Table 7-12: LINAK's Product Divisions⁷²

Business Area	Description	
CARELINE / MEDLINE	The MEDLINE & CARELINE Division provides products for use in hospital and health care applications, thereby giving comfort for both patient and caregiver. Products are applied to e.g. hospital beds and dental chairs.	
TECHLINE	The TECHLINE Division is focused on providing products for use in industrial equipment like machinery & workspace, building & construction, and mobile equipment.	
DESKLINE	Due to the DESKLINE system people can sit or stand comfortably at their office or workplace as the DESKLINE system makes it possible for manufacturers of desks and other pieces of office equipment to install sophisticated motorized systems that provide optimum ergonomics and adjustable desk applications. The key is to improve ergonomics at work by enabling the workplace to be adjusted to each individual, instead of making him or her adjust to the workplace.	
HOMELINE	By means of LINAK HOMELINE system, it is possible to enjoy the pleasures of comfortable and adjustable pieces of furniture at home. Moreover, the high force capacity makes it possible to incorporate HOMELINE actuators in chairs, beds, recliners, couches, massage chairs or other pieces of furniture used in private homes for comfort purposes. However, the number of applications of the HOMELINE system in the home is endless.	

Each product division was to have its own cost and profit centre structure giving each a degree of autonomy and responsibility for profitability. Besides the product divisions two “feeder units” (Electronics and Spindle Production) should supply the product divisions with control boxes and spindles, respectively. As an extra spin on the setup the product divisions are not obliged to buy in-house, making sure the “feeder units” can compete on market terms.

⁷² Source: www.linak.com.

Albeit DESKLINE represented less than 20% of the turnover, it was the first product division to completely separate its activities from the rest. As early as 2002 all activities relating to DESKLINE in 2002 was moved to the facilities, a new round factory. The cooperative intentions of the changes were “built-in” as the building contained few walls, and all desks were placed adjacent to the production to allow all employees to understand the job content of their colleagues (thereby killing off the normal rumors of inefficiencies and slackness of other departments). The same is planned for the other product divisions but is currently on hold due to discussions on cost/revenue allocation principles.

LEAN - From PUSH to PULL

Following the initial results from the BPR project it was decided to implement LEAN Manufacturing. The rationale behind the decision was not only to lower cost of e.g. inventory, but also to use the concept to make LINAK better able to handle the demands from the marketplace: shorter lead times, smaller batch sizes etc. To achieve this goal the production was split into assembly and component production. The production philosophy was changed from a PUSH concept supported by the extensive use of MRP-systems to a customer oriented PULL system. The order cycle was changed from 6-8 weeks to 3 weeks and the production cycle was changed accordingly from 3 weeks to 1 week⁷³. The change from PUSH to PULL was facilitated by the implementation of a Kanban system⁷⁴ which has even been extended to include a number of the suppliers.

Morten S. Raahede (Logistics Manager) describes the outcome of the LEAN project:

“The employees most probably knew productivity was too low – and they accepted the need to improve radically. ... It took us only three month to reduce the cost price by 50% - and this was achieved by simple process changes and changes to the production planning. ... The good thing is that people are really proud of the improvements they have taken part in.”

This quick win was somewhat countered by the need to invest in e.g. better IT systems but the productivity improvement has been secured – the current turnover by employee of 1.2 mill. DKK and a lowered cost for components add up to an overall improvement of 40% in the period 2002-2005.

Network

The network is continuously expanding; currently (mid-2006) the company has 25 subsidiaries and 9 distributors. Especially with the last couple of years the expansion has been quite dramatic – in the 2004 annual accounts the company had only 15 subsidiaries (see Figure 7-18 below). Production takes place at two sites: Nordborg (DK) and Louisville

⁷³ Order Cycle - the minimum time needed to fulfil an order – the time from the order is placed to the earliest possible delivery time. The production cycle is the time from the production order is initiated till the order is completed (ready for shipment). The production cycle is thereby a part of the order cycle. For more on these issues, please refer to e.g. Hill (2005) or Stevenson (2005).

⁷⁴ Kanban - a simple control system, often used in concert with Just in Time (JIT). For a description of the concept, please see e.g. Hill (2005) or Stevenson (2005).

(USA). The latter produces for the American market only⁷⁵ whereas 90% of the production in the former is exported.

Figure 7-18: Legal Structure – LINAK⁷⁶

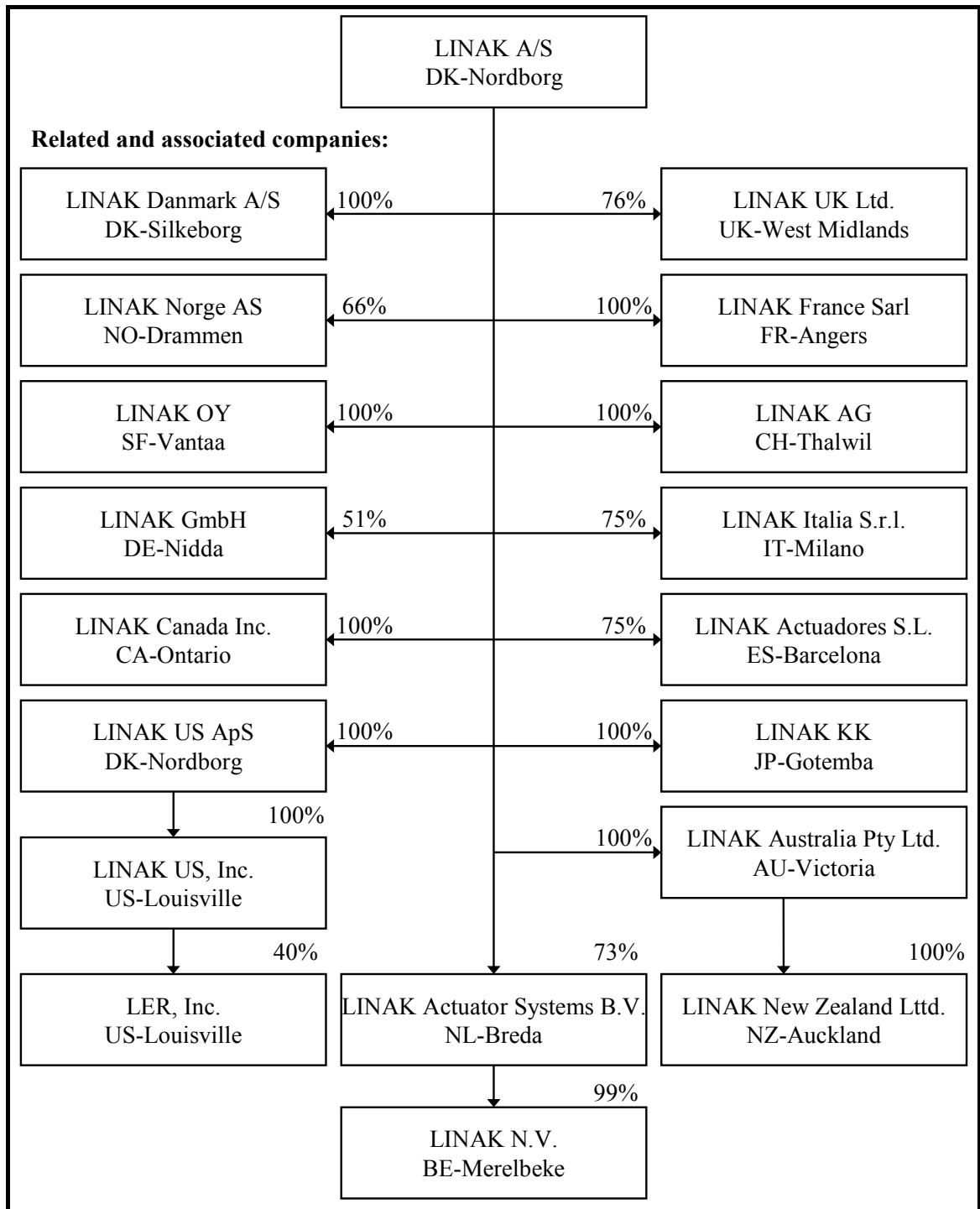

⁷⁵ Currently manufacturing competencies are at a lower level in the US than Denmark. Therefore only relatively simple products are manufactured at the US plant. A few high-volume products are being redesigned to enable manufacture at Louisville.

⁷⁶ Source: LINAK (2004), p. 5.

LINAK Today

The strategy developed back in 2000 was a successful one. The negative financial development was stopped – and the company has been able to continue the aggressive expansion. In Table 7-13 below the financial key figures for the last years are listed.

Table 7-13: Financial Profile – LINAK A/S

End Date	Turnover	Profit Before Tax	No. of Employees
2005-06-30	1.476.121	210.821	1.275
2004-06-30	1.315.542	152.015	1.185
2003-06-30	1.142.107	94.908	1.142
2002-06-30	1.141.411	136.377	1.105
2001-06-30	1.015.611	131.980	1.005
2000-06-30	780.352	100.305	823

Both turnover and number of employees have increased steadily with no fluctuations. PBT has increased with a rate higher than turnover, with one major fluctuation (2003). Especially the development within the last two years holds promise of future results.

Markets

The market in general is growing but the situations differ across geography. In Asia and USA the market is increasing whereas Europe is stagnating. The most important countries in terms of turnover are USA (22%), Germany (14 %), Denmark (12 %), Sweden (10%), UK (also 10%), and France (8%). Turnover across product divisions also displays heterogeneity as DESKLINE accounts for 18%, MEDLINE/CARELINE accounts for 70%, TECHLINE for 9%, and HOMELINE for 3% of turnover.

Also market position differs across product divisions, ranging from market leader (MEDLINE/CARELINE) to new entrant (HOMELINE). The customer portfolio in the MEDLINE/CARELINE consists of five very large internal companies and a number of medium size national companies producing equipment (primarily beds) for hospitals. A very little share of products is sold to smaller producers. LINAK is also the largest supplier within the DESKLINE segment where the typical customer is a medium size producer of office furniture. These products are primarily sold in Europe but the sales in USA is growing. In contrast, LINAK is a small player in the two other segments, TECHLINE and HOMELINE. They differ greatly, though, as quantity sold in TECHLINE is low and level of modification high, whereas HOMELINE is precisely the opposite.

Competition

The competition similarly differs across product divisions. Only the largest (and most professional) companies are able to service the largest segment, MEDLINE/CARELINE, due to the high standards of quality defined by customers and regulatory bodies in countries across the world. In other segments regulatory requirements are less strict giving access to smaller competitors.

Overall the three largest competitors are Okin, Dewert, and SKF/Magnetic – their revenue ranging from 350 to 600 mill. DKK⁷⁷. The rest of the competitors are either specialized in a sub-segment or oriented towards a national/regional market. In USA a few very large competitors supply actuators within the TECHLINE segment.

The biggest threat in terms of competition is the threat from “copy cats” in China, companies specializing in copying existing designs and manufacturing them at very low prices. LINAK has tried to have a few of these companies prosecuted but this has turned out to be very difficult and very expensive. So far no effective way of dealing with this issue has been found.

Customers

As is the case for many suppliers to OEM’s the customer portfolio is dominated by few customers. At LINAK the four largest customers account for 40-45% of the largest segment (MEDLINE/CARELINE) representing approx. 28-32% of total turnover. To a certain extent this problem is diminishing as LINAK has entered growing markets which are commercially unrelated to the MEDLINE/CARELINE segment. If these markets develop as expected the dependency of these four customers thereby will diminish, but until then they are critically important to LINAK. To address this issue LINAK has developed the “Brick Wall Strategy” aiming at integrating closely with important customers to keep competitors at distance and decreasing the probability of losing the business.

Production Setup

The production setup is definitely geared for expansion. As previously mentioned an actuator consists of the following components: motor, gear, spindle, control box and control – but not all these components are produced at LINAK. All motors and gears are purchased from a few very large producers whereas spindles are to a large extent produced in-house. This production is performed on fully automated equipment, just requiring the dimensions of the spindles and enough input (steel bars) to complete the order. Another component mostly produced in-house is the control box. To stay as independent as possible from the IC-marked, the company has decided to keep the production of control boxes in-house as well. Currently product developments are creating more generic control boxes for use with a bigger portion of the actuator mechanics ensuring the number of control boxes to be produced is minimized. Morten S. Raahede explains:

“We are fully aware our production is by no means cost optimal, but it ensures stability. ... We are not dependent on the very unstable IC industry, and that’s a necessity when lead times are short and product development is ongoing. ... The current challenge is to build more generic control boxes. ... Then we can even build-up a small safety stock to ensure continued delivery of end-products in times of shortage.”

⁷⁷ Source: Morten S. Raahede, LINAK. For more information on these companies, please refer to www.okin.de, www.dewert.de, and www.magnetic.skf.com, respectively.

Where components are produced in-house the scheduling resembles when acquiring inputs from external parties: in as small batches as possible. Small inventories (called supermarkets) de-couple the (small) batch production in the feeder units from the assembly units – and everything except the ‘main component’ passes through the supermarkets. Large batches (and large quantities purchased) are placed in “normal” inventory and the supermarkets are replenished from here.

Assembly

With the implementation of LEAN came the introduction of U-cells, assembly/production cells shaped like the letter U. These production cells are characterized by high flexibility and adaptability to the production of smaller batches of actuators. Each cell is manned by one or more persons, carrying out either all the operations or only a part of the operations needed to complete the component. Due to continuous rotation between tasks each employee is able to perform all functions in the cells and therefore it is quite simple to switch between small and large batches by simply adding or removing personnel in a cell.

The production cells (U-cells) are serviced by a so-called “water spider” who has the responsibility to keep production going at the designated cells. This means making sure there’s enough input to the cell to communicate with e.g. engineers if there is a problem in the production.

Requirements across Product Divisions

The demands placed on LINAK across the four product divisions vary greatly. The demands placed on LINAK with regards to the CARELINE/MEDLINE product division are primarily demands for high quality and a high number of variants. Conversely within DESKLINE the number of variants is quite low, but competition is fierce. In the HOMELINE division the demands are primarily for low prices. In the TECHLINE division, batches are often smaller as components are applied to expensive machinery, and there’s neither price competition nor demands for short lead times. For all but TECHLINE there is a demand for short lead times and high delivery precision.

Currently, the CARELINE/MEDLINE is the most important division, but LINAK has high expectations for the DESKLINE and TECHLINE. In the HOMELINE division a new class of products, TwinDrives, was introduced in 2004 and expectations are high here as well.

Sourcing

To support the production in meeting these requirements the sourcing strategy defines how input is secured. At LINAK the sourcing policy dictates outsourcing and a reduction of the supplier base in order to support the further development of the logistics system:

“If we are supposed to lower inventory and decrease lead and throughput times we need to work more intensely with our suppliers. Since this work is quite time consuming we need to reduce the number of suppliers. ... Luckily we have now agreed to systematically reduce the supply base.” (Morten S. Raahede)

So far the supplier base has been reduced from approx. 200 suppliers to 122 (end 2005). Within some areas the reduction has been quite radical, e.g. electronics where currently two suppliers (backed up by one more) supply all electronics components. Other areas are a bit more complex, e.g. the molded parts where tools might cost as much as 1 mill. DKK and be developed for specific equipment (owned by the supplier). In this case it will take longer to decrease the supplier base.

Another aspect making it difficult to drop suppliers is the company's position in the community, Morten S. Raahede explains:

“When I first started here most of the suppliers were ‘old buddies’ of the owner or even the owner’s father. They have developed their business over many years in parallel with LINAK, and they expect it to stay like that. ... We’ve been told that it’s OK to drop an ‘old buddy’ if he continues to perform badly after many warnings – but it has to be done with great care.”

The new sourcing policy is not well received at Purchasing:

“We do have a policy but this is just a piece of paper – reality is somewhat different. ... When trying to source an item we end up with the usual suppliers as they are the only ones we know who are able to follow our procedures, and know how we work. ... The negative side of working so stringently with suppliers is that you limit the market. In Purchasing we would like to have 3-4 suppliers per input, but the sourcing policy does not allow this.” (Paul Frees, Purchasing Director)

The high demands placed on the suppliers in terms of quality, documentation and adherence to protocol (processes) thereby limit the competition. This mechanism is further enforced by the increasing time pressures (Time-to-Market).

So, on one hand apparently volume goes to the 'usual suspects' in the supplier base and on the other hand Purchasing would like to have more alternatives. Apparently too few suppliers have the required competences? It seems the quarrel between Logistics and Purchasing is about the core issue, the suppliers' competency level; and the disagreement is about the approach to address this issue.

Both agree the issue stems from the customers' influence on product development.

Product Development

Being an OEM requires LINAK to have engineers and designers working on adapting existing products into customers' designs, or on designing new products⁷⁸. At LINAK approx. 40 designers and engineers in Denmark and USA are constantly working to do just that. Morten S. Raahede comments:

“When analyzing the product portfolio it is apparent we have focused on fulfilling the customer requirements by creating new variants. We have spoiled the customers by abiding them every time. ... In some markets creation of new

⁷⁸ Approx. 70% of the resources spent within R&D is spent on customer projects applying the actuation technology to the customers' designs. The last 30% is spent on technology projects - designing new products or developing new application areas.

variants was probably used as a competitive mechanism. ... We have to reduce the number of variants – or at least try to implement postponement... ”

To Paul Frees the breadth of the product portfolio⁷⁹ is a natural result of being an OEM's:

“In our market we have to develop the product the customers demand. That's the name of the game. ... Most of our products are customer-specific – this is simply the reality of it. ... As a consequence probably 95% of our inputs are specific to us – perhaps even to the product...”

Recently the product development process was altered to include both Purchasing and Logistics – with the aim of reducing the number of unique inputs:

“Our job is to tell Product Development where the required competences are available in our supplier portfolio. ... As the lifetime of products are shortening and product development is speeding up we need this information readily available.” (Paul Frees)

Logistics have a different perspective:

“Products need to be designed for manufacture and components need to be reused across products. Furthermore products need to be prepared for postponement. ... We have been allowed to initiate a project on a ‘product configurator’ and newly designed products need to support this initiative.”

Purchasing and Logistics thereby have their work cut out for them.

Supplier Selection & Evaluation

Following the reduction of the supplier base a stringent procedure for evaluating the supplier before inclusion in the portfolio has been put in place. As the focus is on continuous reduction of the supplier base only very rarely are new suppliers admitted. Existing supplier are being evaluated – both as a part of an annual evaluation and also in an attempt to map out competencies:

“We are working on a model describing the competencies of our suppliers. It will not contain any classes as such but a qualitative indication of their competency level. ... The matrix could show current volume on the one axis and their competency level on the other.” (Paul Frees)

The size of the task at hand is fully realized, Paul Frees:

“It is not going to be easy to measure the competency – and to describe it to the other stakeholders, but we might try and use some of the categories from the annual evaluation form: quality, precision etc and then add special abilities...”

As for the annual evaluation tools have been developed and the process is well in place:

“The annual evaluation combines hard facts with subjective evaluations. We intend to measure their impact on us – and the value they bring. ... We have defined threshold each suppliers needs to perform above – if this is not the case Purchasing will investigate.” (Morten S. Raahede)

The metrics used are depicted in Figure 7-19 below.

⁷⁹ As much as 80% of the orders are for customer-specific products.

Figure 7-19: Supplier Performance Metrics – LINAK⁸⁰

Metrics		Excellent (5)	Good (4)	Average (3)	Not acceptable (2)	Critical (1)
Performance Measure	Unit					
Overall annual cost reduction	%	> 5	4-5	2-4	< 2	0
Payment terms	Days	> 60	46-60	45	30-44	<30
To ability to develop and improve services	Subjective					
Delivery & Quality Agreement			Yes		No	
Audit result from LINAK audit	Score (%)	> 90	75-90	55-74	31-54	< 31
Environmental management system		ISO 14001	Plan. ISO	Env. aware	No plan	Public order
Drop out in production	PPM	< 50	51-500	401-3.000	3.001-10.000	> 10.000
Problem solving regarding quality issues	Subjective					
Communication regarding quality issues	Subjective					
Delivery performance	% delivered	> 99	98-99	92-97	85-91	< 85
Delivery time	Days	1	2-10	11-15	16-20	> 20
Communication regarding logistics	Subjective					

Resulting classification	
Score	Supplier class
52-59	A - supplier
52-51	A – supplier
31-41	B – supplier
21-30	C – supplier
13-20	C supplier

Purchasing would like to have a credible threat e.g. to insource the activity in case the supplier does not perform satisfactorily over a period of time:

“In principle most of the inputs could be produced in-house but we are not allowed to insource any activities. The policy clearly states all non-core activities are to be outsourced, irrespective of the efficiency of the supply market.” (Paul Frees)

⁸⁰ Source: Morten S. Raahede, LINAK.

A consequence of the sourcing policy is thereby that unique inputs are outsourced and it is up to Purchasing to ensure stable supply from the market as inhouse competencies are not maintained.

SCM Practice

Even if the company does not have a SCM department or any positions referencing SCM their practices on LEAN and their organizational design earned the company the Post Denmark Supply Chain Award in 2004. Besides cutting costs the implementation of LEAN also had the consequence of forcing the company to re-think their processes and the way they do business across their network. Figure 7-20 below depicts LINAK's supply chains.

Figure 7-20: Supply Chain Diagram – LINAK

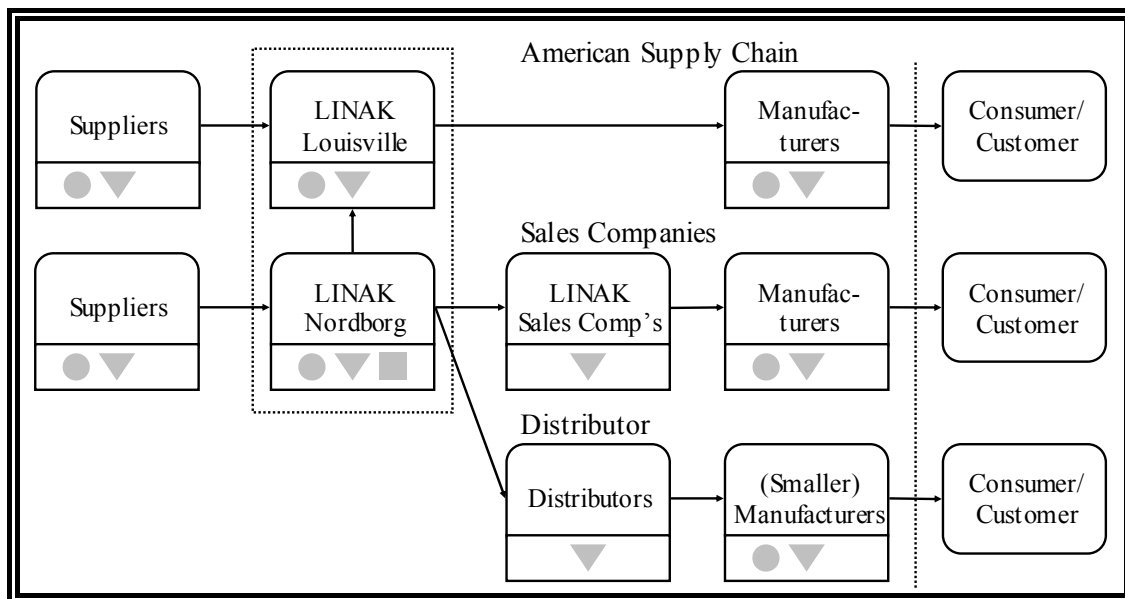

Even if relationships with suppliers and customers are long-term the level of integration is quite limited. Albeit the company has implemented an ERP system (Axapta) to support the LEAN processes the company does not exchange EDI documents. A web-portal enables the sales companies to place orders but no external customers are allowed access.

Cooperation with suppliers is influenced by the effort to reduce the supplier base – only the most competent (logistically and in terms of product quality etc.) are retained. The electronics suppliers are the most advanced as they more or less run LINAK's inventory of these components. LINAK simply forward the demand forecast for the following week to the supplier who then use this information to replenish the inventory⁸¹. For molded parts deliveries are made daily as these parts are relatively cheap and bulky making the storage cost – item cost ratio unfavorable. Few of the suppliers are allowed to produce the items in batch according to confirmed forecasts but delivery is made against request only. Integration with suppliers is thereby driven by the LEAN implementation:

⁸¹ LINAK can intervene and have deliveries from day to day.

“We are getting more closely integrated with suppliers – and we are reaping the benefits. ... But this integration is not due to a strategic approach to supplier management – it has developed from the interaction between Logistics and the suppliers in making the LEAN processes work...”

The goals set up for the LEAN implementation are being met – but there are still challenges...

Challenges in Logistics

According to Morten S. Raahede the approaching deadline for the implementation of the ROHS and WEE directives constitute the major challenge within Logistics. The breadth of the product portfolio and the current practice of modifying any product and storing it locally (at sales company level) make the task almost unmanageable:

“We have to verify our products meet the requirements [of ROHS and WEEE] – and in many instances we have to redesign the product. The task at hand is enormous. ... On the other hand, it gives us an opportunity to reduce the number of variants.” (Morten S. Raahede)

The sales company stock of products which have only one customer is naturally a problem in itself, but having to analyze each and every product for compliance with the directives prompts Morten S. Raahede to propose radical changes:

“We should take this opportunity to weed out any unwanted variants, centralize the warehousing, and implement postponement. The ‘product configurator’ will enable us to develop customizable products to a higher degree than today...”

These changes will most likely trigger a reaction from the customers – therefore the most important customers⁸² have been interviewed on the issue. So far a solution of direct delivery from Nordborg and safety stock at the customers’ sites is being discussed. If this is implemented the cost reduction will be substantial. Opportunities for reusing existing designs might also arise as lower cost prices might encourage other customer to accept minor redesigns in their end product.

Reducing the number of variants does not only have to do with the physical dimensions or shape of a component, in the case of the generic control box it has to do with functionality. Unfortunately this initiative was unsuccessful:

“Product development ran amok – to cost was way too high and it took too long. ... Apparently they felt a need to design everything themselves, even the power supply. ... If they had been able to carry out their task our work would have been reduced substantially – now we’re back to square one...”

So, even if the solution is identified (and in principle quite simple) the implementation sometimes turns out to be somewhat more problematic...

SCRM Practice?

The company does not have a risk management practice – except for the supplier management described above:

⁸² The six largest customers (each representing a turnover of min. 30 mill. DKK per year) have assigned a Key Account Manager.

“We currently have a supplier who is experiencing financial problems. Purchasing naturally keeps a close eye on this – and we are ready to step in if needed. Besides from this instance we really do not know how ‘dangerous’ each supplier is to us – we don’t know the impact of a supplier failure.”
(Morten S. Raahede)

Purchasing concurs:

“We really do not have a problem – we’ve never experienced a production stop due to a supplier going bankrupt. ... Nobody knows what the risk is, really. ... So we have to safeguard against it instead – implementing redundancy like we do with the Chinese suppliers.”

No forum for a more strategic approach to risk management exists. In the production, naturally risk management does exist, e.g. in the form of fire extinguishers and exception management in relation to the production and assembly processes. But at LINAK as for most other companies the risk management is “built” into the manufacturing practice – and is based on regulatory standards. A pro-active approach to SCRM is absent.

Summing Up...

LINAK has accomplished to implement a lot of changes within the last five years – in terms of implementation of LEAN, ideas on process improvements, and on integration with key supply chain partners. They have been able to control their costs and work with the union to retain production in Denmark. Opportunities still exist in aligning processes and integrating with the (larger) customers.

7.7 Novozymes a/s

The Danish pharmaceutical companies Nordisk Gentofte A/S and Novo Industri A/S, established in 1921 and 1925 respectively, were merged in 1989 into Danish Novo Nordisk A/S. Eleven years later the increased worldwide demand for enzymes justified the creation of a separate organization, and in November 2000 Novozymes a/s was established by way of a de-merger from Novo Nordisk A/S. The history of the company is briefly described in Table 7-14 below.

Table 7-14: Milestones – Novozymes a/s⁸³

Year	Description
1925	Novo Industry A/S is established.
1939	Thorvald Petersen, one of the founders of Novo, was worried that WW2 would cut off supply of pancreat glands, which was used to produce the enzyme trypsin. Research for alternative methods of extracting the enzyme for leather softening was initiated.
1941	More or less by accident, the enzyme extraction process was discovered. The new enzyme was named Trypsin Novo.
1952	Novo develops its first fermented enzyme Thermozyme, enabling large-scale production of enzymes for industrial use. The enzyme is used for starch removal.
1961	Dr. Hallas Møller takes over as CEO.
1962	The company enters the detergent industry as it is approached by Carlsberg to reproduce an enzyme used in their production. Researchers discover the enzyme is good at removing obstinate blood and sweat. The resulting product, Alcalase, is incorporated in Bio-tex.
1963	Alcalase is marketed, creating one of the landmarks in the development of detergents. The product removes all types of protein-based stains such as grass, blood, egg, and perspiration.
1965	The company enters the alcohol industry by the introduction of Amyloglucosidase Novo, an enzyme which breaks down starch into glucose.
1967	Novozyymes opens a new enzyme factory in Copenhagen, Denmark. Novozyymes buys Schweizerische Ferment AG (SFAG) and establishes a sales office in Mainz, Germany.
1969	The world's largest enzyme production factory in Kalundborg, Denmark starts production. At the same time sales plummets due to the speculation by the influential Ralph Nader on the health implications of handling and potentially also using detergents containing enzymes. Employees were laid off, and financial disaster was lurking.
1971	Following a complaint by Ralph Nader to the American Food and Drugs Administration (FDA), it was concluded that the use of enzymes in detergents is safe, and that they should play a bigger role in the future. Sales soon rose again.
1972	The cost-efficient detergent enzyme Savinase (a.k.a. The White Tornado) is launched.
1973	The enzyme Termamyl is launched. It is intended for automatic dishwashing, and is especially good at removing starch-based stains, as pasta, potato, gravy, chocolate, and baby food.
1979	Novozyymes opens an enzyme factory in Franklinton in North Carolina, USA.
1981	Mads Øvlisen takes over as CEO from Dr. Hallas Møller.
1982	As a result of 15 years of research, dust-free enzymes in the form of granulate is marketed.
1984	The first enzyme for industrial use produced by genetically modified organisms (GMOs), Maltogenase, is launched.
1987	An detergent enzyme, Celluzyme, that makes fabric maintain its colours longer is launched.
1988	An enzyme for removing fat and another for treatment of denim is launched.
1989	Novo Industry merges with the pharmaceutical company Nordisk Gentofte A/S, creating Danish Novo Nordisk A/S. An enzyme factory in Curitiba, Brasil is opened.
1990	Interested in the biotech industry, the company buys California-based Entotech. The company is used as a research unit.

⁸³ Source: www.novozymes.com and Thomas Videbæk, Novozymes.

Table 7-14 (cont'd)

Year	Description
1992	More enzymes are introduced, but more importantly: the cloning system <i>Expression Cloning</i> is developed. It enables the quick and safe transfer of useful enzymes identified in other organisms into a growth media. Also this year the Environmental Committee was established dealing with environmental and sustainability issues.
1994	Novozymes publishes Denmark's (and one of the world's) first environmental report.
1995	A joint venture in China is established.
1996-1998	More enzymes are introduced for bleaching, fat-removal, and for washing clothes at lower temperature. Earliest initiatives relating to SCM.
1998	An enzyme manufacturing plant is opened in Tianjin, China.
1999	The company implements Triple Bottom Line.
2000	Novozymes was established as an independent company following a demerger from Novo Nordisk. Steen Riisgaard becomes president and CEO of the new company. The SC Organization is created.
2001	Following the demerger a new strategy is launched: to expand outside the enzyme industry. Initially this means the introduction of industrial microorganisms. Novozymes buys Sybron Biochemicals in Virginia, USA - now Novozymes Biologicals.
2002	The acquisition of US based George A. Jeffreys and Interbio strengthens Novozymes' position within industrial microorganisms. The two companies were integrated into Novozymes Biologicals. Novozymes acquires the activities of BioGaia Fermentation, Sweden - now Novozymes Biopharma. The acquisition marks Novozymes' first step into the pharmaceutical field.
2003	The biological solution are further strengthened by the acquisition of Semco Bioscience and Roots. Both companies becomes part of Novozymes in Salem, USA.
2004	Innovation never stops: a new stain fighter, Stainzyme, is introduced. It removes difficult stains in cold water, and retains the colours of the fabric.

Today Novozymes is the world's leading manufacturer of enzymes and micro organisms with an overall market share of approx. 40%. Headquartered in Bagsværd, Denmark, the company employs approx. 3.900 people worldwide, hereof approx. 2.100 in Denmark. Turnover has been increasing steadily and exceeded DKK six billion in 2004, see Table 7-15 below.

Table 7-15: Financial Profile – Novozymes A/S

End Date	Turnover	Profit Before Tax	No. of Employees
2005-12-31	6.281.000	1.150.000	4.023
2004-12-31	6.024.000	1.081.000	3.928
2003-12-31	5.803.000	1.015.000	3.814
2002-12-31	5.642.000	900.000	3.629
2001-12-31	5.271.000	871.000	3.349
2000-12-31	5.033.000	705.000	3.204

The Product

The core product, the enzyme, is actually proteins that are found in every living organism: man, animals, plants and micro-organisms. They are part of the all vital biological processes in cells and have the function of de-composing organic material into its most basic components. Enzymes have been used in the industry for more than 60 years, speeding up various biological processes by acting as a very potent catalyst. The most popular application areas for enzymes are detergent, textile, and food & feed, but enzymes are also used in many other areas. One of the most positive aspects of using enzymes is the reduction of water, energy, and raw materials consumption when applied within an industrial setting. Furthermore by being bio-degradable replacing traditional synthetic chemicals with enzymes helps protect the environment.

The Production Process

The production of enzymes for industrial use is quite simple, at least at the conceptual level. Most of the inputs to the manufacturing process are quite basic as main ingredients are commodities like corn, soy, starch etc. And in principle the production process is quite basic as well, but in practice it requires an extremely complicated and well run production facility. The entire process is automated and controlled by IT systems only requiring intervention in case of exceptions.

The process consists of three parts:

1. Fermentation:

Following inoculation in a flask the fermentation process is initiated in the plant. On a base of various natural ingredients such as potato starch, water, sugar, etc., the micro-organism now forms the basis for the fermentation process that produces the required enzyme on a large scale.

2. Recovery:

After fermentation the enzyme is separated from the residual substances.

3. Granulation:

The third and final step at the site is granulation. Here the enzymes are sealed in a wax coating. Following the production process the enzymes are packed into boxes (40 kg), drums (200 kg), or “big bags” (1000 kg).

Of the three phases in the production fermentation is the most difficult part. Even under the best of conditions the fermentation can be unsuccessful resulting in the loss of the entire batch. Also the recovery phase shows a degree of variation. In total the production cycle may well have an average of 10 weeks, but may vary from 8-12 – and still be considered within control. This places production planning in a tight spot:

“It’s all about keeping production up and running. ... It really is pointless to optimise on these automated processes – the real money is on the process itself. If we could ensure more stability or even shortening the production process that would make a difference... Currently we are further enforcing the use of standard inputs – perhaps this will lead to more stability...” (Thomas Videbæk, VP, Supply Chain Operations)

Besides the standard products⁸⁴ Novozymes also customizes products (blends) for the individual customers or even develops special products (granulates). In both cases the customer lead time is between one and five days – whereas production cycle is approx. 10 weeks. Therefore Novozymes has a fair amount of money tied up in inventoried produce.

Product Portfolio

The product portfolio is split into two business areas, micro organisms and industrial enzymes, the former representing a mere 5% of revenue⁸⁵. The industrial enzymes can be

⁸⁴ Approx. 2/3 of sales is standard products, the rest is customized produce.

⁸⁵ The micro organisms are only included in the introduction part of the case study as this part of the business is managed in a more or less separate organisation.

further divided into food (24%), feed (12%), detergents (34%), and other technical enzymes (25%). Micro organisms are used for various purposes such as aqua culture production, cleansing of waste water, and as a component in cleaning products. The food enzymes are used within the baking, brewing, alcohol, juice, and wine industries, as well as other food categories including the dairy sector and the food oil industries. The feed enzymes are primarily sold in Latin America and Asia where the enzymes are used to e.g. enhance the extraction of proteins in the production of animal feed material. Enzymes are used in all modern detergents, a market experiencing a high degree of innovation and a relative high rate of new product introductions. The last category, other technical enzymes encompass many application areas, such as fuel ethanol production, pharmaceutical production, leather treatment, and the textile industry. The product portfolio consists of 600+ products which are created from the 75-100 semi-finished crude components from bulk production. These 600+ products are input to thousands of customer products – and due to their criticality to Novozymes they are protected by a multiplicity of patents⁸⁶. Each of these basic recipes are expected to be relevant for up to 30 years have an expected validity and when required Novozymes customizes or even develops special products for its customers.

Sourcing

In terms of sourcing Novozymes is in a unique situation as the de-merger described earlier was only partial: a considerable portion of the sourcing is performed through the parent company, more specifically through the department Novo Nordisk Service Partner (NNSP). For reasons of scale economy the supply of non-critical items are managed through NNSP, a practice not without consequences for Novozymes:

“The items supplied through NNSP are supposed to be non-critical, but a recent analysis showed a share of the items is semi-critical. Since we do not have a choice to source these items ourselves we are in a tight spot as we are responsible for ensuring supply.” (Ken Friis, Purchasing)

Besides the ‘inconvenience’ of lack of control the practice of indirect procurement has had negative impacts when being audited (supplier certification):

“We had one incident in relation to the required [manufacturer’s] certification. We are very thorough when it comes to adhering to standards and regulations – but we received a less than perfect score because we were not in direct control over the pest control which was outsourced by NNSP. ... The problem was quickly remedied – but the rating stood...” (Ken Friis)

Even if most of the inputs purchased are very basic single sourcing does take place. It is not a strategic choice per se but a result of long term relationships with a number of suppliers. Single sourcing is not considered a problem:

“We have no problem with using single sourcing. BASF for instance is the sole supplier of a certain input to our products, but since they produce it a several

⁸⁶ As each “basic recipe” has an expected lifetime of 30 years, patents are not able to protect the innovation for the full period of usage.

plants in Germany we are pretty well covered in terms of ensuring the supply. We also buffer, just in case...” (Ken Friis)

As mentioned the majority of inputs are basic agricultural products and since the current supply meets demand at an acceptable price, in the long run the specialization in the agricultural industry might threaten the profits generated at Novozymes. Already there are alternatives to the basic inputs:

“If we wanted we could save some money short-term by buying inputs designed specifically for our production, but we have chosen not to. We believe as much value adding as possible should be performed within our company – and choosing the most basic input ensures competition in the market place.” (Ken Friis)

In principle Novozymes could establish their own production of agricultural products but have chosen not to – for reason of core competence. Sourcing is global, and Purchasing is becoming part of the global organization:

“When we source from third world countries we use the Triple Bottom Line⁸⁷. We are very serious about of corporate social responsibility and work from very stringent ethical guidelines” (Ken Friis)

Overall sourcing for the production is perceived as rather standard with the clear objective of ensuring supply at the lowest possible cost.

Markets & Competitors

Novozymes stands out from its competitors by spanning all four product areas. Even so the company is the global market leader within both business areas, see Table 7-16 below.

Table 7-16: Market situation for Novozymes a/s⁸⁸

	Enzymes			Microorganisms
	Technical	Food	Feed	
Market share	50 %	35 %	45 %	50 %
Competitors	Genencor	DSM, Danisco, AB Enzymes	BASF, Danisco	A number of smaller companies

At the aggregated level Novozymes is estimated to hold a 44% share of the global market for enzymes, and 50% for micro organisms (as illustrated above). The main competitors within enzymes are DSM (5%), Genencor (18%), and BASF (5%). The most important markets for Novozymes are Europe, North America, and Asia.

The Organization

As illustrated in Figure 7-21 below the Board of Directors at Novozymes consists of the CEO, two Vice Presidents and four Executive Vice Presidents. SCM is not present at this level but

⁸⁷ Triple Bottom Line – usually means expanding the traditional company reporting framework to take into account not just financial outcomes but also environmental and social performance. For more, see Elkington (1998).

⁸⁸ Source: Thomas Videbæk, Novozymes a/s. See also Novozymes (2005), p. 11.

at the level below where responsibility is delegated from the four Executive Vice Presidents to the twelve Vice Presidents⁸⁹. SCM has reference to Peder Holk Nielsen, Executive Vice President for Sales and Marketing.

Figure 7-21: Organization Chart – Novozymes

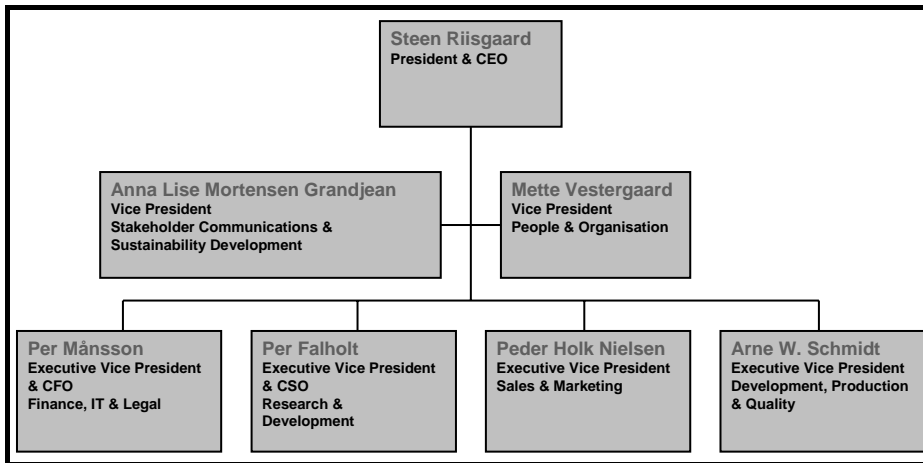

The Network

Besides HQ in Bagsværd Novozymes have two other sites in Denmark and subsidiaries in thirty other countries. Production takes place at all three sites in Denmark (Bagsværd, Fuglebakken, and Kalundborg) and at sites in Brazil, China, Sweden, and USA. The plants in Kalundborg, North Carolina, and China are all large-scale multi-purpose plants, whereas the plant at Fuglebakken produces in small batches only. Much simpler facilities in Mexico and India perform blending and packaging operations of semi-finished produce from the “full functionality” sites. Both these sites operate to fulfill local demand only. Besides the warehouses at the production sites, warehousing is also performed in Singapore and at two sites in Eastern Europe. Research and development is performed at multiple sites in Denmark, Japan, China, and USA.

SCM Practice

The company has worked with SCM since 1996 with the creation of the Supply Chain Organization at Novo Nordisk. The first goal was to implement centralized warehouse management which was achieved during a project in 1997 – 1998. The de-merger in 2000 resulted in the creation of the Novozymes Supply Chain Organization, which still encompasses the downstream side of the business only. Neither Bulk Production nor Purchasing is part of the Supply Chain organization. When the SC organization takes over the product it has gone through the first two phases (Fermentation and Recovery) but has not yet been granulated. Based on the customer requirements the SC organization granulates the produce, and packs and distributes it. Some customers use the product within their own production whereas others use Novozymes’ products in the end product. In the case of the

⁸⁹ Besides these twelve VP’s located at HQ each of the sites across the world might have one or more VP’s.

former Novozymes performs consultancy-type support as they try and optimize the customers' production processes. These two types of customers are depicted in the diagram below.

Figure 7-22: Supply Chain Diagram – Novozymes

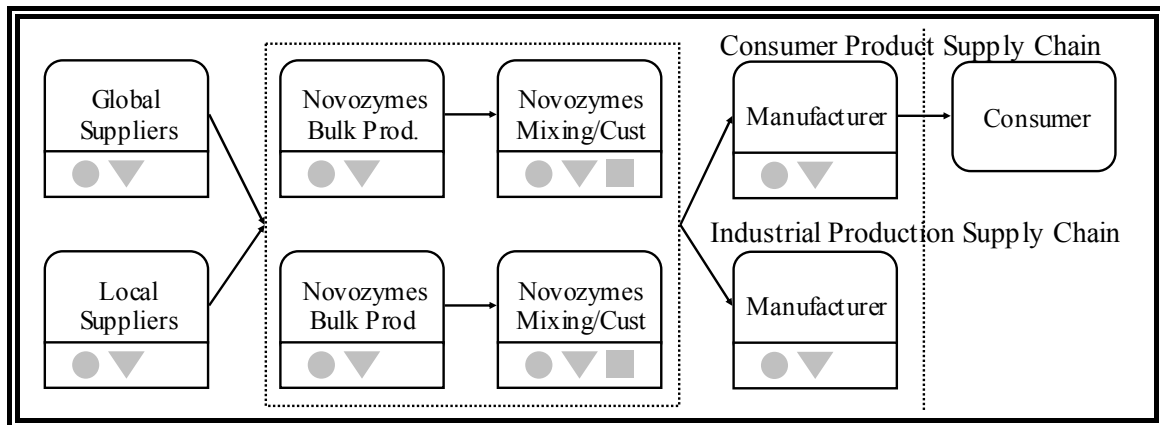

Besides aiding the customers in optimizing their production Novozymes tries to integrate logistically with their customers by means of VMI and other types of IT and process integration. Following an update of their SAP system Novozymes now offer their customers collaborative planning and forecasting in their APO⁹⁰ application. The company has ambitions within this area:

“Today almost all production is against forecasts, but we would like to change that as inventory costs are very high. ... We have started mixing granulates against orders instead of against forecasts. Inventories have been cut dramatically due to this process change. ... This type of postponement of course requires a very low variation in output – if we have to perform continuous control the process wouldn’t work.” (Thomas Videbæk)

By implementing this type of postponement⁹¹ the company has to be very certain their forecasts on the basic components is accurate:

“It is very important for the SC Organization to give precise forecasts to the Bulk Production. We are very good at the aggregated level – and at the level we keep stock.” (Thomas Videbæk)

Besides forecasting Novozymes also offers easy integration through the use of Business Content, an open interface supported by the SAP application. Alternatively the customers can use a web application to monitor the progress of e.g. their orders.

For the larger customers Novozymes even offers to partake in research and development activities ranging from developing a new mix from existing components to developing a new

⁹⁰ APO – Advanced Planning and Optimizing. Planning module in SAP for multi-site planning and optimization of production and distribution. For more, please see www.sap.dk.

⁹¹ The SC Organization is being measured on a number of KPI’s, e.g. inventory value, days of sale, delivery reliability, throughput etc. The KPI ‘Master Plan Schedule Adherence’ monitors SCO’s forecast for Bulk Production.

enzyme⁹². Novozymes thereby distinguishes itself from the rest of the industry as it is the only company with resources to perform projects of this scale (and number).

Major Risks

The overarching risk source for Novozymes relates to the core of its technology: the genetic modification. Even if the technology has been used for a long period of time it is still perceived as dangerous:

“We have to be very cautious when communicating about GMO’s – in Europe this is really a hot topic. ... That is why we do not address Food & Feed in Europe, in the US and in Asia it is not a problem at all. Europe is not ready for GMO products within Food & Feed.” (Thomas Videbæk)

Ken Friis concurs:

“There is the theoretical risk of breach of containment when doing R&D – that the wind might spread genetically modified seeds. So we have to be very careful when performing these projects – we work with NGO’s all over the world. Europe is not ready for these types of products, at all...”

Both interviewees agree sourcing is not really problematic:

“The inputs we need in the SC Organization is basically packaging material and the outputs from Bulk Production. Sourcing from our perspective is really simple.” (Thomas Videbæk)

Ken Friis does not see sourcing as a critical risk:

“We do not have a problem with single sourcing as these few companies are very large and stable corporations, like BASF. For each of these products we have confirmed the supplier has redundancy in their operation... For the rest of the input, it’s really very basic inputs which are bought in a market”.

But the suppliers are monitored on a continuous basis, as is the markets.

SCRM Practice?

So, even if only few risks are identified risk management is needed, as described above. Currently risk management is performed by two separate entities: financial risk management and insurance contracting takes place under ‘Legal’ at corporate level, whereas the commercially oriented issues are dealt with by ‘Issues Management’ under ‘Corporate Communications’. The latter is a forum where issues like acquisitions, child labor, and new customers are dealt with. The Committee is cross-departmental in order to ensure all perspectives are covered before implementing new procedures across the entire company:

“Whenever we want to alter the way we do business or alter e.g. the use of suppliers we let the committee evaluate the initiative. Currently e.g. all new customers have to be evaluated. One of the most important assets for Novozymes is the brand name – we are really careful about the way we communicate and operate in the global economy.” (Thomas Videbæk)

Ken Friis comments:

⁹² The

“We have to make sure our products are not being used to criminal or unethical ends. Above all else we have to protect our brand... In that respect, Risk Management is one of the most important things we do...”

Summing Up...

From a risk perspective Novozymes is in a unique situation as the operational risks appear trivial. Inputs are simple, suppliers are plenty, and unique inputs are few (and acquired from large, stable companies). Their entire business is threatened by public opinion as the company is very aware – unfortunately the company is much too small to influence the agenda on a global or even European scale. The relevance of a well run logistical system is therefore quite important as this minimizes the probability of major accidents at customers’ sites. Choosing their customer carefully and working with the operations people at the customers’ sites is thereby not only a matter of offering a value adding service to the customer – it might also be perceived as a type of risk management. Perceiving the inter-organization integration through this lens describes the integration of SCM and Risk Management of both process and structure...

7.8 Oticon a/s⁹³

Following the coronation of crown princess Alexandra in London in 1902 Hans Demant, a then manufacturer and marketer of bicycles in Odense, traveled to London to obtain a hearing aid as the one used by the queen. The apparatus, called the Akoulallion, was purchased to help his hearing impaired wife Camilla overcome her handicap. Hans Demant was soon contacted by others interested in buying a hearing aid - and that was the start of what was to become Oticon a/s. The company has developed dramatically over the years, Table 7-17 below shows some of the major milestones.

Table 7-17: Milestones – Oticon a/s⁹⁴

Year	Description
1904	Oticon is founded in Odense on June 8 th , 1904, by Hans Demant, who is then a representative for General Acoustics. Hans Demant obtains the agency for Acousticon's hearing aids. After a couple of years the company is relocated to Copenhagen.
1910	Following the death of Hans Demant, his son William takes over the company. In the following years William Demant obtains the agency for Acousticon products for the Nordic countries.
1920s	The company opens up to foreign markets as sales offices in Oslo, Stockholm, Helsinki, and St. Petersburg are established. Production facilities are expanded, and the products are registered with the Danish Patent Office.
1930s	The product portfolio now consists of hearing aids, church hearing aids, and hospital systems (incl. patient radio receivers). Following the import restrictions enforced in the early 1930s, Oticon starts light manufacturing and assembly of the imported products.
1940	Due to the Second World War importing goods from the USA is impossible. Oticon therefore expands its assembly operation into production of hearing aids by copying the Acousticon product. The 'Danish version' of the product is named 'Acousticus'.
1944	Oticon opens its first subsidiary, in Sweden.
1946	The first real Oticon hearing aid, Oticon model TA, is introduced.
1952	The Danish competitor Danavox wins the government contract for 1.500 hearing aids, forcing Oticon to focus on exports to make up for lost sales.
1953	The introduction of the transistor meant much smaller hearing aids. Oticon's model T3 was one of the first hearing aids in Europe to use the transistor technology.
1956	Due to disagreement between William Demant, factory manager Christian Tøpholm, and export manager Erik Westerman, the latter two leave the company to establish Denmark's third manufacturer of hearing aids, Widex.
1957	William Demant and wife Ida Emilie transfer their Oticon shares to a fund, which is later becomes known as the Oticon Fund. Ida Emilie Demant dies.
1960s	Oticon continues to grow. The company relocates to Klædemålet, where the production area exceeds 3.000 m ² .
1963	The three Danish manufacturers of hearing aids establish OTWIDAN, an organization to manage bidding and development for the government contracts.
1964	In 1964 Oticon Nederlands B.V. is established and during the following three years the subsidiaries Oticon Inc. (USA), Oticon AS (Norway), Oticon S.A. (Schweiz) and Oticon GmbH (Germany) are established.
1970s	The factory in Thisted is opened, and the former Rolls-Royce factories in Scotland are taken over. Subsidiaries in Italy, Japan, England, Scotland, France, and New Zealand are established as well as the Danish sales company Oticon Danmark A/S and an independent company for managing exports: Oticon Export A/S.
1977	A new independent research unit, Eriksholm, is established. Oticon is now the world's largest manufacturer of hearing aids.
1979	Oticon celebrates its 75 th anniversary. William Demant dies, aged 91.

⁹³ The description is supplemented with information from Oticon Fonden (2004) and Hald & Hedegaard (2004).

⁹⁴ Source: www.oticon.dk.

Table 7-17 (cont'd)

Year	Description
1980s	During the 1980s Oticon undergoes dramatic changes. Deficit reaches 46 mill. DKK in 1987, and a new management is brought in. Oticon Holding is established. The company changes from perceiving itself as a high tech company to an audiological oriented company.
1985	Due to unsatisfactory results the management of the company is taken over by Palle Rasmussen, who has been accountant for the company and a member of the board for years.
1987	Lack of innovation has led the company to have “too few products”. Misreading the potential in the ITE technology gives the American competitor Starkey an advantage. The “gang of four” who has led the company since the 1960s agree to part ways with Oticon.
1988	Lars Kolind is employed as CEO to perform a turn around of the company.
1990s	Some of the most radical changes in the company’s history take place in the 1990s. The company relocates to it’s new corporate headquarters located on Strandvejen in Copenhagen. Oticon becomes internally renowned as the ‘spaghetti organization’.
1991	Oticon introduces the world’s first fully automated hearing aid, MultiFocus. This hearing aid is the first not to have a volume control. Project “330” is initiated, aiming at improving productivity with 30% over a period of three years.
1992	Niels Jacobsen, Lars Kolind’s co-CEO, succeeds in stopping the cash drain, which has been plaguing the company since the mid-1980’s. In the years to come capital is accumulated, enabling takeovers of related businesses.
1995	Oticon Holding – later known as William Demant Holding – is registered at the Copenhagen Stock Exchange. The Swiss company Ascom Audisys (today Bernafon) is taken over. This is the first of a series of 30-40 acquisition made in the following years. German Siemens and American Starkey are market leaders. The production of amplifiers for the hearing aid is placed in a separate sister company, DanHybrid A/S ⁹⁵ . The intent is to commercialize the competences within amplification (in miniature).
1996	Another revolutionizing introduction is made with the product DigiFocus – a fully digital hearing aid with a new audiological rationale called ‘Adaptive Speech Alignment’.
1997	Lars Kolind resigns as CEO, and Niels Jacobsen takes over full responsibility. Oticon adds ‘Personal Communication’ to its business area with the acquisition of Phonic Ear, a specialist within FM and wireless technologies.
1998	A long-term supplier of electronics components is merged with DanHybrid, creating the company DancoTech A/S. The new company supplies all hybrids for the William Demant Group.
1999	Oticon changes from being a niche to full-line supplier of quality hearing aids. Hearing aids Ergo and Swift are introduced to cover low and medium price segments. Swiss Phonax launches an aggressive attack on its largest competitors Widex and Oticon. The business area ‘Personal Communication’ is strengthened with the acquisition of the Danish company Danacom which manufactures headsets.
2000	Innovation continues with the introduction of the worlds (till date) most advanced hearing aid, Adapto. The magazine Forbes places Oticon amongst the top 20 best companies in its class. The business area ‘Diagnostics’ is added with the acquisition of the company InterAcoustics. English distributor Hidden Hearing is acquired, giving better access to the English, Irish, Portugese and Greek markets. Also in the USA market position is improved through acquisition of the distributors AVADA and AHAA.
2001	Innovation continues with the introduction of the worlds (till date) most advanced hearing aid, Adapto. At DancoTech the production of standard electronics components is dropped, as it focuses solely on the production of micro electronics.
2002	Oticon, in cooperation with GN Resound and Widex, helps establish Centre for Applied Hearing Research (CAHR) ⁹⁶ at the Danish Technical University (DTU).
2003	William Demant Holding A/S wins the prestigious award <i>European Company of the Year</i> – an award previously given to i.e. Nokia, BMW and Hugo Boss. Oticon wins the <i>Danish Logistics Award</i> ⁹⁷ .
2004	Oticon introduces the hearing aid Syncro, the world’s first hearing aid using Artificial Intelligence (AI).

⁹⁵ For more into, please see www.dancotech.dk.

⁹⁶ For more info, please see www.dtu.dk/centre/cahr.aspx.

⁹⁷ For more info, please see www.logistikkonferencen.dk.

The lack of innovation thereby was close to causing the company to succumb but the corrective measures taken up through the 1990s and in the beginning of the new millennium changed the fate of the company and made it prosper.

Mergers and Acquisitions

Up till 1995 the company expanded solely through organic growth, but the acquisition of the Swiss competitor Bernafon started a wave of mergers and acquisitions. Smaller companies within the hearing aid industry was acquired in order to obtain market share or to gain access to markets, companies in related industries were acquired to obtain synergy.

Whereas Bernafon remained a more or less independent under the control of William Demant Holding, other companies seized to exist as they were merged into existing companies. The brand name Bernafon is maintained due to differences in products and segments addressed: Oticon focuses on the high-end segment, Bernafon on the middle segment.

The major companies in the new business areas ‘Diagnostics’ and ‘Personal Communication’ likewise remained relatively independent, but all companies share support functions/services like Finance, IT, and Logistics⁹⁸. Figure 7-23 below illustrates.

Figure 7-23: Overall Structure of William Demant Holding⁹⁹

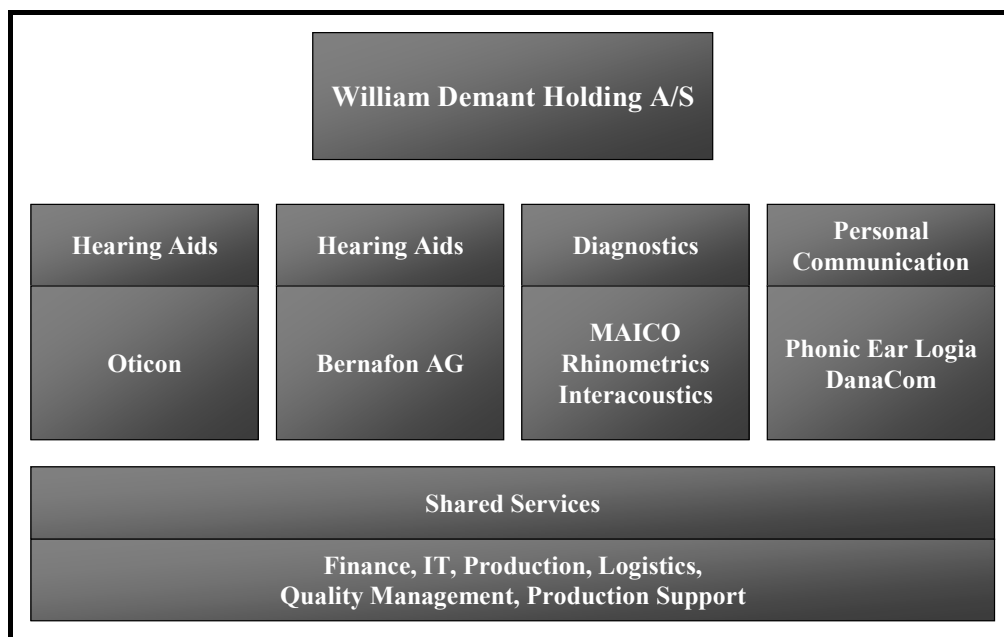

Since the turnaround the company has experienced only progress in turnover, profit and number of employees, see Table 7-18 below.

⁹⁸ This case study focuses on Oticon a/s and will only reference the other business areas where necessary.

⁹⁹ Source: Figure 1 in Hald & Hedegaard (2004), p. 98 (translated).

Table 7-18: Financial Profile – Oticon A/S

End Date	Turnover	Profit Before Tax	No. of Employees
2004-12-31	1.944.738	700.239	1.082
2003-12-31	1.606.020	558.681	994
2002-12-31	1.497.519	514.589	908
2001-12-31	1.433.089	434.277	892
2000-12-31	1.197.231	342.874	795
1999-12-31	898.251	207.017	755
1998-12-31	750.881	143.491	690

The Market & The Network

The market Oticon operates in has changed dramatically over the past decade or so. From consisting of more than 100 manufacturers, today the market consists of approx. 30 manufactures with more than 85% of the market is in the hands of six players¹⁰⁰ (Oticon is currently among the top three). Demand for hearing aids in recent years has stagnated, but since less than 10% of people in need of a hearing aid actually owns or has access to one, potential is enormous. Oticon does not sell directly to the end-users though, but to the hearing clinics. This customer base in principle is not restricted by geography, but due to e.g. levels of wealth and cultural aspects currently customers are primarily from Europe and North America. Therefore acquisitions have focused on creating an efficient distribution network on these continents (e.g. the acquisition of the distributors AVADA and AHAA in the USA). The network had been expanding rapidly for some years, and by 2001 the organization in Thisted was overburdened.

Outsourcing of Logistics

Supporting the network of sales companies and distributors with more and more frequent shipments was becoming quite some task, and in 2001 Oticon decided to outsource the in- and outbound logistics for the hearing aids business units (Oticon and Bernafon). The chosen outsourcing partners was Wilson Logistics Group, but before entering into this agreement, five of the most prominent TPL providers represented in Denmark were invited to Oticon to present their visions, competencies and proposals for solutions.

Several of the companies were potential candidates for the contract, one of the important reasons for choosing Wilson Logistics was that Wilson had Scandinavian staffs in most local offices, thereby facilitating easy communication. Another reason was that Oticon due to the scale of Wilson's operation got a high priority as a key customer¹⁰¹. This means that the personnel in various airports and destinations are giving Oticon's shipments high attention

¹⁰⁰ Three of the six are Danish: GN Resound, Widex, and Oticon. The other three are Siemens, Phonak, and Starkey.

¹⁰¹ Oticon has tried to use Deutsche Post, but changed again after two months because of a perceived lack of focus from Deutsche Post.

and priority, reducing disruption in distribution whenever possible. The TPL contract runs for 4 year with yearly renegotiations of rates and other conditions¹⁰².

Both parties have adapted processes and routines to support the cooperation: Oticon has ensured uniformity in requirements across product ranges and destinations Wilson has established an Oticon Help Desk, which is answering all inquiries from Oticon's customers.

Furthermore, Oticon informs Wilson about campaigns, product introductions etc., so that Wilson can allocate specific resources to take care of shipments with high priority, and ensure space in aircrafts.

Organizing Logistics

At the time the transportation was outsourced to Wilson responsibility for logistics was placed in three groups: Inbound Transports, Logistics, and Outbound Transports¹⁰³. But as a consequence of the outsourcing these groups were initially merged into one group called Purchasing, and subsequently split into the three teams: Purchasing/Procurement, Supply Chain Planning, and Logistics.

Supply Chain Planning has the responsibility to create the master schedule, whereas Logistics schedule orders from this plan. Purchasing/Procurement is responsible for ensuring supply, for quality management, and for managing the supplier base. The Logistics team is responsible for initiating delivery, which is done through the ERP system. Wilson receives information of any outgoing deliveries, and expedites these transport orders according to the following rules:

- Direct deliveries, where the order are transferred from the sales subsidiaries directly through the ERP-system to the Miniload software. These orders are picked and dispatched the same day with a delivery service of 24 hours within EU.
- Daily shipments to the large subsidiaries with an order cycle time of two days.
- Weekly shipments to Oticon's middle-sized subsidiaries overseas.
- Several weekly shipments to the largest subsidiaries.

Products

As described in Table 7-17 above new products are introduced at a steady pace. Oticon introduces two-three types of hearing aids per year. It also introduces a new generation of hearing aids approx. every three years, all with five years of service coverage. Each product adds new features or enhances features of existing products, the generic hearing aids can be described by its main components: microphones, loudspeakers, integrated circuits, hybrids, and shells, see Figure 7-24 below.

¹⁰² Initially the agreement covered only the hearing aids business units (Oticon and Bernafon), but has subsequently been extended to cover other units as well. As the agreement is based on an open-books principle and a "cost plus" pricing scheme, it is in the interest of William Demant Holding to have as many as possible of its businesses using Wilson Logistics.

¹⁰³ As a reminiscence of the "spaghetti organization" the company does not have any organizational charts. Interestingly, the organization is still structured in formal entities, but is not documented.

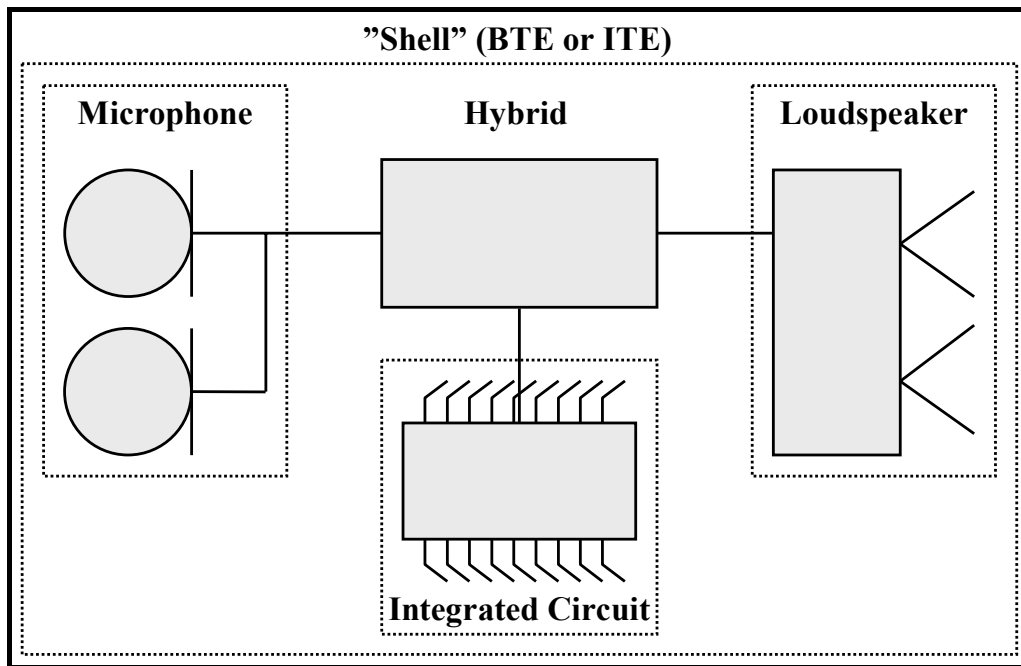
Figure 7-24: Generic Product for Oticon¹⁰⁴

Oticon currently has more than 110 product families, with each family having some 50 different hearing aids. It currently has about 32,000 item numbers, of which about 18,000 item numbers are in stock. Of these 18,000 items approx. two thirds are purchased. All item master data is stored in a centralized ERP (MSG-PRO) system, which tracks and traces the critical components at the receiving dock as well as the correct usage of the components. Virtually all products are bar coded.

The product portfolio consists of two distinct groups: hearing aids placed behind the ear (Behind-The-Ear, BTE) and hearing aids placed in the ear (In-The-Ear, ITE). Albeit the former is sometimes referred to as the “old” technology the market for this category of hearing aids is still enormous.

Production

Contradicting the company’s self image as “a maker of customized solutions rather than a producer of components”, the company has production of components, sub-assemblies, and finished products in Australia, Poland, Scotland, and Denmark.

The distribution of activities across the production sites has changed dramatically within the last two years, as the current dogma is to produce the more complex products (along with small batches) at Thisted in Denmark. The production of standard components/products in large quantities has been transferred to Brisbane (Australia) and to a lesser degree to Krakow (Poland) and Hamilton (Scotland). The production in Krakow is primarily sub-assemblies, whereas the production in Scotland has been extended to include BTE as well as ITE production. The output from the production in Krakow is distributed to the other manufacturing units as output from Krakow is input to the production performed at the other

¹⁰⁴ Source: Sketch supplied by Oticon.

sites. As mentioned in Table 7-17 above, all production of hybrids is performed at the sister company DancoTech whereas the integrated circuits are supplied by Knowles and Sonion. Besides these units a large number of ITE laboratories service the various regions across the world.

Product Development

At Oticon the product development is integrated in the sense that besides R&D, both purchasing and production is represented on the projects. The group works together as a team, and has regular meetings with suppliers and in-house engineers. Projects naturally differ according to content, but two indicators have become very important:

- Time-to-market (due to shorter product life cycles) and
- Time-to-volume (to obtain economies of scale).

Oticon does not participate in joint product development with competitors. However, often a supplier is shared with the competitor(s), so in order to gain some control of the innovative technological content of its components, Oticon pays for tooling of new components (at the supplier's site). Oticon has full ownership of the tooling and has purchasing agreements when joint product development projects take place with suppliers.

Oticon aims to stay as independent as possible, but due to the requirements placed upon e.g. integrated circuits, only one or perhaps two suppliers in the world can produce components for the latest products, at the required quality. The long-term cooperation with Cicorel has these characteristics. What might be referred to as “diseconomies of innovation”¹⁰⁵ does apply for Oticon who has only exemplary production for this class of input.

Process Strategy / Layout

The production philosophy at Oticon is Mass Customization¹⁰⁶. By producing in batch to obtain economies of scale and a subsequent customization for the individual customer, the determination of the decoupling point is critical. For some types of products, a value stream analysis would be required to determine this point, at Oticon this analysis is restricted by the customization possibilities of the products. In logistics terms the concept of Mass Customization implemented at Oticon is thereby a combination of a push and a pull principle, see Figure 7-25 below.

¹⁰⁵ Diseconomies of Innovation - the phenomenon that companies are forced to outsource critical activities due to the resources required to maintain competencies and/or technology to perform the activities in a cost efficient manner. Please note: this is but a suggestion, no other “formal” term was found describing the phenomenon.

¹⁰⁶ Mass Customization – an operations concept from the automobile industry giving customers the choice of customizing their end product at no added cost (the flexibility is built into the process). For a thorough description of the concept, please see Pine II (1993).

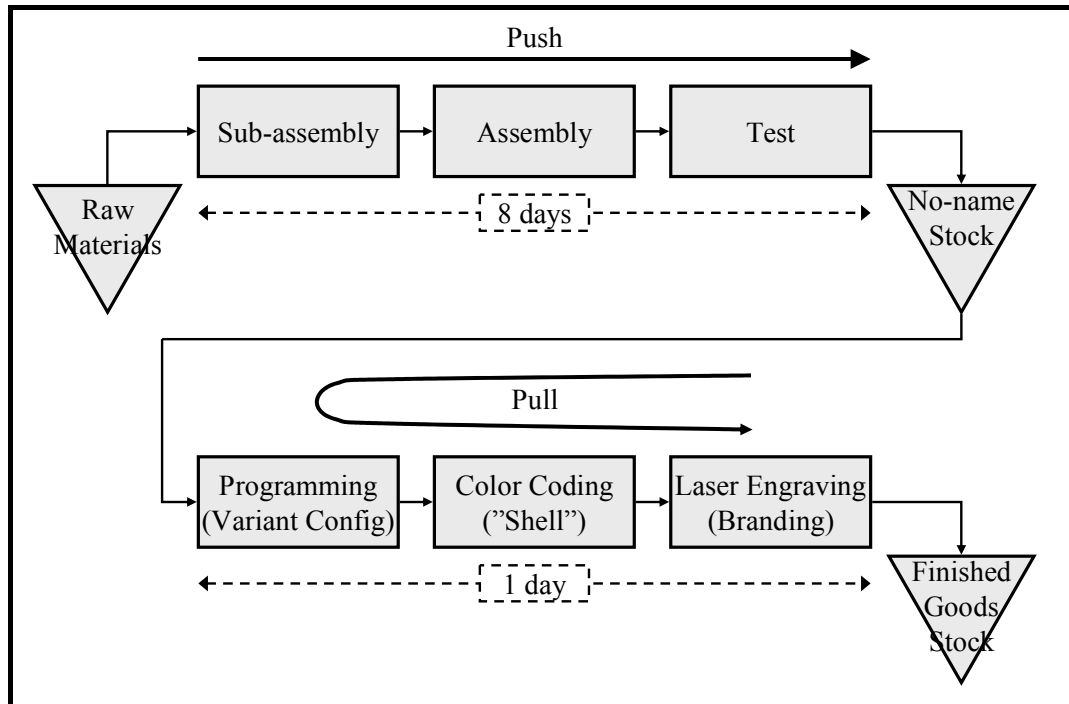
Figure 7-25: Oticon's Generic Production Process (BTE)¹⁰⁷

The decoupling point and the “push side” of the production processes differ between the BTE and ITE technologies. For both types of hearing aids, the customization is based on the choice of product (type, brand etc.) and of the electronic profile obtained from the hearing test performed at the outlet.

For BTE type hearing aids, the customization takes place when the product is programmed and the color is determined (“shells” exist in a number of colors). Basically, the pre-assembled hearing aid can “become many products” depending on the programming and branding taking place. The process is described in Figure 7-25 above.

For the ITE type hearing aids the process is slightly different as the hearing aid is made to fit the customer’s ear. At the hearing clinic, the technician makes a “model” of the ear, either using computer-based laser technology (SLA) or by means of a plastic material. Depending on the technology in use, the model of the ear is either e-mailed or snail-mailed to the associated ITE laboratory, where the shell is produced. Following the production of the shell the forwarded electronics (the assembled hybrid) is mounted in the shell, the hybrid is programmed, possibly laser engraved, and finally shipped to the hearing clinic.

Economy of scale is guaranteed through batch production in the push part of the process, whereas customer satisfaction and differentiation is obtained in the pull part of the process. Obviously value of semi-finished goods inventory must be balanced with capacity planning in production, to ensure total cost is minimized.

¹⁰⁷ Source: Figure 4 in Hald & Hedegaard (2004), p. 105 (translated).

A prerequisite for this production philosophy is modularization, ensuring the re-use of generic components in many end products. This reduces the number of components thereby lowering the cost of production as well as inventory. The trade-off as in increased costs for quality management on these generic components, and probably a higher development cost per component as well.

Performance Measurement

Besides the above mentioned indicators, Oticon is measuring a number of logistics key performance indicators (KPI's). Where possible KPI's are based on 18 months of data, and are updated once a month. There are a total of 72 measurements or indicators for the supply chain management. Collecting this information leads to the rating of each supplier, which is also performed once a month. An evaluation report is sent to the each supplier, creating a shared basis for discussing performance and incentives for improvement, where appropriate.

Supplier Selection & Management

Also during supplier selection stringent procedures are in place¹⁰⁸, as e.g. each supplier is visited by purchasing and technical (production) staff to ensure the supplier will be able to produce to the required high standard. Furthermore their financial data is evaluated to ensure the management of the company is competent and that the financial situation of the company will not jeopardize stability in supply. In case the supplier passes these tests, Oticon sets goals for the supplier which are subsequently communicated during a personal meeting. Marianne K. Borum (Purchasing Manager) comments:

“We do not do all these things to scare the supplier to perform well – we actually do collect the KPI's and evaluate the suppliers as described. ... We really have the intent of helping the suppliers in case of e.g. quality problems – we'd rather help an existing supplier to perform better than select a new one. ... Conversely, we've had a number of instances where we have not been able to help the supplier, or the supplier has declined our offer of assistance. The supplier then seizes to work with Oticon.”

But naturally not all suppliers are equally important to Oticon; the customer base of approx. 250 suppliers is therefore segmented. Currently the segmentation model contains the following categories:

1. Critical suppliers,
2. Non-critical suppliers, and
3. Trivial suppliers.

There are 15 critical suppliers, supplying components such as integrated circuits, EMC, customized, and unique components. Oticon has close cooperation and partnership with these suppliers because they usually handle designs that are dedicated to Oticon. Several of them are sole source suppliers. An example is the collaboration between William Demant and US-

¹⁰⁸ Marianne K. Borum explains how the quality system contains documents describing procedures and routines for e.g. supplier selection. The system itself is quite unstructured as documents are placed in various locations on Oticon's intranet and shared disk drives. A part of the material is contained in e-mail communication between members of the management group.

based Starkey about a small FM receiver to be clicked on the hearing aids to improve the hearing at conferences etc., where FM compatible microphones are installed.

Further complicating the management of the suppliers is 1. the heterogeneity of the supply base (approx. 20 suppliers account for 70% of the purchasing volume), and 2. the fact that Oticon is a small company in a niche market relying on very large suppliers. Neither of these circumstances are a result of a deliberate choice by Oticon, but simply characteristics of their context.

Whereas the former can not be mitigated, the latter complicating fact is countered by the attractiveness of Oticon. Marianne K. Borum:

“Even if we are a small company in the electronics industry, our suppliers consider us an attractive customer as they get access to innovation when working for us. ... We are a source of inspiration to them, and we push their capability by insisting on our high quality standard.”

So, even if Oticon is a minor player in several of their suppliers’ industries they are quite successful in making the suppliers accept the contractual terms, the continued evaluation and monitoring, and (in many instances) to hold inventory for Oticon.

Sourcing Strategy

The sourcing strategy will therefore inevitably accept the reliance on sole suppliers. Marianne K. Borum:

“The strategy is not formally written down, but we all know it. ... Being in the market we are in, we have to accept that fact that sometimes there is only one supplier for a certain input. In such a case we try to make them hold inventory for us. ... But we prefer having more than one source for the input. Take Knowles and Sonion for example. Even if we decide to give a contract for an item to Knowles, we at the same time let Sonion know that there is a market for the item. We have experienced ending up in a monopolistic situation with Knowles, we try to avoid that in the future. ... But using sole or single suppliers is an inevitable situation for us – we simple can not produce every unique item ourselves.”

The use of single or sole suppliers is perceived as an unchangeable characteristic of the business, as engineers continue to design even more complex, smaller, and sophisticated products at the cutting edge.

IT Solutions

As mentioned above, Oticon has integrated its processes by means of implementing an ERP system some years back. External integration is in place by means of exchange of EDI documents, and Vendor Managed Inventory (VMI). The purpose of VMI is to aid critical suppliers with their forecasting and production planning. The VMI solution gives suppliers automatic notification when the inventory level gets below a certain quantity, calculated from weekly demand figures. Currently, there are about 12 suppliers using VMI, representing approx. 80% of the purchasing value. To ensure suppliers understand the criticality of using

the information made available by the VMI solution, suppliers are educated benefits and correct use of VMI (e.g., for production planning and preventing bullwhip effect).

On the downstream side, a web-enabled application is available to customers. Approx. 50% of all orders are placed in this system, and transferred to the ERP system by means of an application called VIDELITY.

SCM Practice

Performing SCM is considered a core competence at Oticon. Peter Finnerup (VP, Logistics):

“We are all about SCM; it’s the most important function in the company. If we can not keep our promises to our customers, we’re dead. ... Lead times are getting shorter all the time – we have to meet the customers’ expectations, and to make sure we do it every time.”

To meet the customers’ expectations, the logistics system has been redesigned several times, as described above. The three teams (Purchasing/Procurement, Logistics, and Supply Chain Planning) support each other to ensure as smooth and efficient a flow as possible. The complexity in the flow of each hearing aid is not considered a problem, Marianne K. Borum:

“I believe one of the things characterizing Oticon is our ability to adapt to new demand or requirements. ... We have the will to keep on improving the way we do things – and we are getting better at predicting changes in our environment. ... We adjust the organization on a continual basis.”

Inquiring about the level of integration with suppliers and the supplier with who to integrate, Peter Finnerup comments:

“We have chosen to work with certain suppliers - that supports our strategy. ... When we design hearing aids, the print for the hybrid is so small only one or two factories in the world can produce them. And even they sometimes have problems meeting our quality standards. ... When we design the prints so small, we’re overstepping the boundary from technology to art – once the production is up and running, it can not be transferred, not even to another factory with the exact same equipment.”

Having minimized inventory and chosen to support shorter and shorter lead times, the need for on-site support when problems occur has forced the decision to co-locate the Logistics/SCM teams with the production in Thisted. Differentiating between subsidiaries and distributors, the supply chain mapping of Oticon might look like Figure 7-26 below.

Not shown in the diagram is the TPL supplier Wilson Logistics, who in-sourced all transportation as described earlier. Wilson was initially chosen over Deutsche Post as it was critically important to Oticon to be a large and important customer, but when Wilson was taken over by TNT, Oticon paradoxically chose to stay with their current setup. The decision was justified by Oticon by having their logistics manager Carsten Hedegaard represent the customer perspective in the realignment of processes and services between TNT and Wilson in the months before the actual takeover. Following this exercise TNT and Oticon decided to continue the partnership, and Oticon subsequently transferred its courier shipments from DHL to TNT (see e.g. Mikkola & Skjøtt-Larsen, 2006).

Figure 7-26: Supply Chain Diagram – Oticon a/s (BTE)

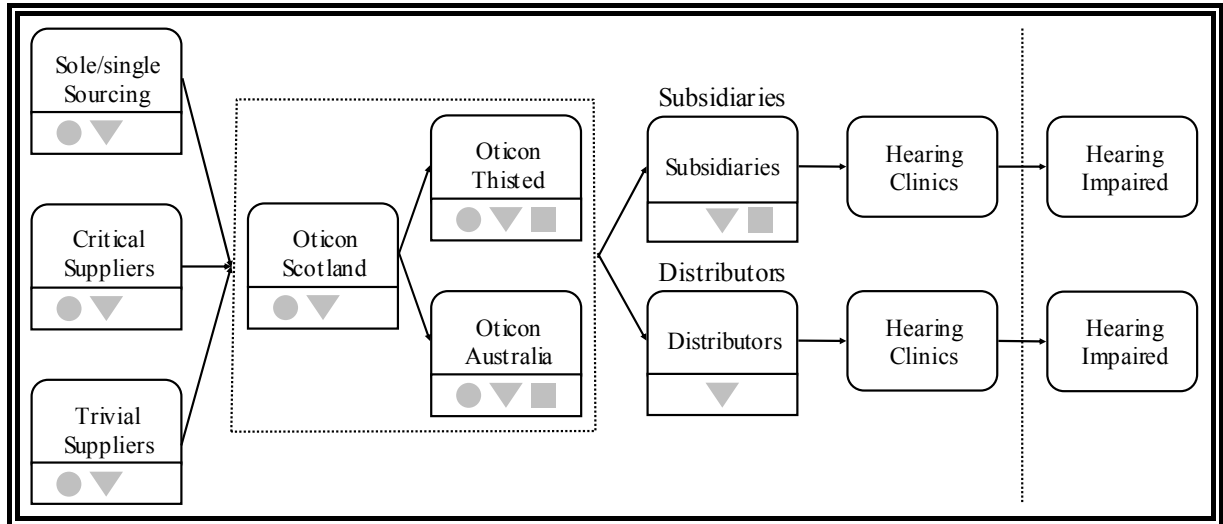

SCRM Practice?

One might expect that the complexity and the competitive pressures in their market had caused Oticon to implement structured and formal risk management (SCRM) for their operations, but Peter Finnerup stated at the initial interview:

“We have no risk management in our area [SCM/Logistics]. We do not need to create another administrative hierarchy - it’s all about having the right processes and doing your job right. ... If we had risk management we would need to document what we do – instead of just doing it.”¹⁰⁹

Later interviews have documented that risk management actually does take place, even if no formal organization exist. Especially in respect to supplier selection and evaluation, the company has quite stringent procedures as described above. The finance department performs a risk analysis of suppliers by evaluating the financial reporting, and the suppliers are frequently visited by Oticon’s auditors. And interestingly, the company’s auditors have interviewed selected employees on the subject of Risk Management, Marianne K. Borum:

“Actually, quite recently I was interviewed by our auditors concerning our procedures for Risk Management, but I’m unsure if this was initiated by the auditors themselves or if Top Management had requested the investigation.”

So, summing up, the risk management practice is strictly informal as no organization nor positions exist. In case an initiative is taken from Top Management, it is not communicated, and currently there is no link between the traditional financial risk management activities, and the informal SCRM practice focusing on safeguarding the extended enterprise. Furthermore the sourcing strategy does not aim at decreasing the risk by e.g. in-sourcing unique activities.

¹⁰⁹ At a later stage, Peter Finnerup modified this statement, hinting that of course Risk Management was performed by all employees as an integral element of the job.

Summing Up...

Also Oticon has undergone dramatic changes during the last years. The growth has placed heavy demands on the company, but Oticon has been able to deal with them. Perhaps the “organic” organizational type with no organizational charts and a team orientation has enabled the company to quickly adapt to changes. For Oticon as for other companies in the study the selection and cooperation with suppliers is of vital importance, as the technologies behind the product has become too expensive to maintain for Oticon itself.

A consequence of the autonomous nature of the organization is a lack of control and a drift in procedures and routines, internally as well as with suppliers and customers. As in the case of Wilson even trivial tasks become unique as the companies adapt to each other. In conclusion: what appears to one of the major strengths of Oticon, its culture of autonomy and absence of hierarchy and formal roles, can also be perceived as its Achilles heel as it may result in unnecessary dependencies.

7.9 RIEGENS a/s

From humble beginnings, RIEGENS have emerged as a successful leader within the European lighting industry. Founded in 1956 the philosophy of the company was to develop technically evolved products and manufacture them to the highest quality standards. The current owner and CEO, Frank Skovsager, bought the company in 1970, and relocated the company in 1976 to its current location in Egestubben, Odense.

In the beginning all sales was domestic, primarily through the two large wholesalers Solar and Louis Poulsen. These two players dominated the Danish market and RIEGENS was therefore quite dependent on them. Conversely, especially Louis Poulsen quickly became dependent on RIEGENS, as they allowed RIEGENS to produce products sold under the Louis Poulsen name. Export took off in the late 1970's and early 1980's – at first through Louis Poulsen, but later through a Swedish/Finnish wholesaler Elektroskandia as well. In the UK the products were sold through a number of smaller manufacturers of related products complementing the product portfolio of both parties.

Up through the 1980's and the 1990's the support of the export sales varied, in periods supported by sales offices and direct sales efforts, at other times supported by before mentioned wholesalers only. The increased domestic and export sales enabled the development of the manufacturing facilities by investing heavily in technology. The company further strengthened its' position in the market by taking out a patent on a central element in all overhead lighting cabinets: the reflector. Besides producing for use in RIEGENS' own products, the reflectors became a steady source of income as the patent protected the competence.

International Ambitions

The continued growth also allowed for an attempt to establish international manufacturing in Turkey. The joint venture which was set up in 2001 intended at producing RIEGENS' standard cabinets for the Turkish construction industry, but due to unexpected stagnation in construction combined with an increased rate of inflation the joint venture was terminated in 2004.

The 2002 acquisition of IBL Specification, a former trading partner who got into financial troubles, was more successful. The company, located in Braintree, UK, resembled RIEGENS as it produced its own line of standard products and participated in projects ranging from supermarket stores to the prestigious Petronas Towers development in Malaysia. The company which employed more than 100 people and was a well established supplier to the British lighting market was renamed RIEGENS LIGHTING Inc. and was fairly quickly integrated in the RIEGENS group. Getting access to the UK market through the original sales force from IBL was only one of the advantages of the acquisition, capacity utilization another. Having similar manufacturing setups, it was fairly easy to begin utilizing non-allocated capacity by posting production orders across from Denmark. And if the production is slightly

less efficient at Braintree, the lower labor cost (approx. 30% lower) more than offsets the added transportation cost.

Following this success, RIEGENS has embarked on another joint venture, this time in Slovakia. In order to stay competitive, the company has decided to start production there, Claus Jensen (VP, Sales) comments:

“The joint venture in Slovakia is perceived as low risk, since we co-establish us with companies we know [from Denmark]. Slovakia is perceived as being closer to Denmark [than the Far East]. The idea is to produce some of the low-cost items there, and ship them directly to the customers.”

Production thereby takes place at four sites: at Egestubben, at Braintree (UK), in Slovakia, and at Næsby Maskinfabrik (also located in Odense). The latter is a small machining shop which was acquired in the 1980’s. The production at Næsby Maskinfabrik is part non-related finished products and part semi-finished products. Næsby Maskinfabrik A/S is connected with the RIEGENS companies through MS Invest Odense A/S¹¹⁰.

Figure 7-27: RIEGENS Group Structure¹¹¹

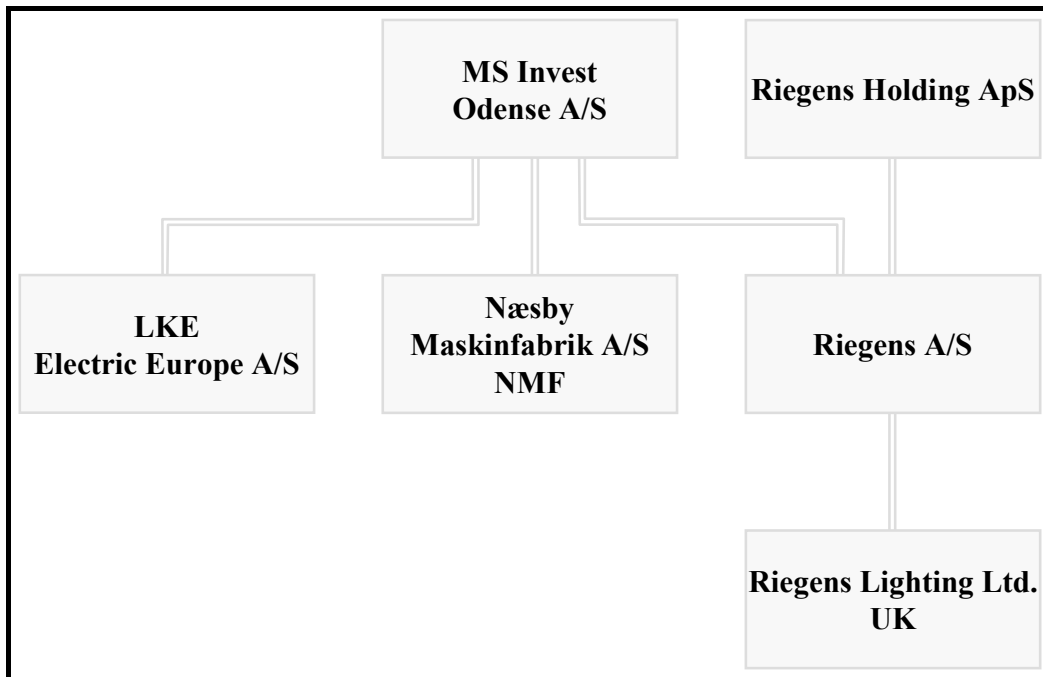

Organization

Viewing the organization chart of RIEGENS a/s it becomes apparent that the company is a traditional entrepreneurial manufacturing company. The company is functionally oriented with a number of department heads, responsible for their respective functional areas.

¹¹⁰ MS Invest Odense A/S is owned by Majbritt Skovsager, the daughter of Frank Skovsager. She is active in RIEGENS A/S as Head of Sales Support. LKE Electric Europe A/S imports electric components, and is owned by Frank Skovsager and Kaare Wagner, a member of the board of RIEGENS A/S.

¹¹¹ Source: www.riegens.dk.

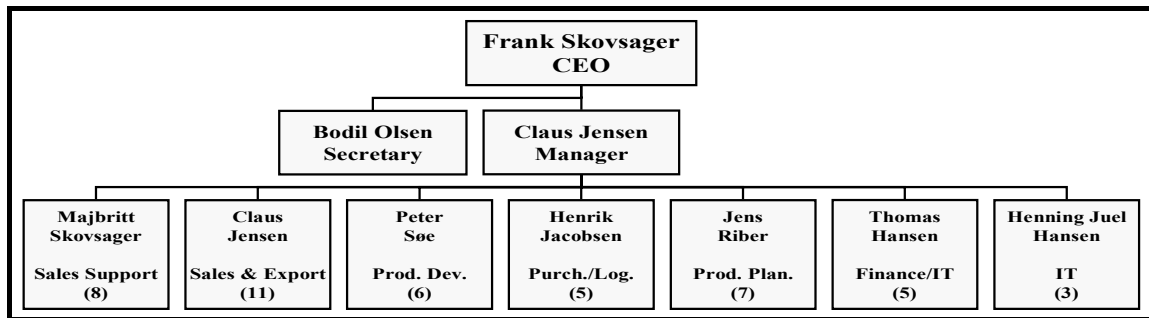
Figure 7-28: Organization Chart – RIEGENS¹¹²

It is apparent that neither SCM nor Risk Management is formalized in the organization chart. The international ambitions are only detectable in the Sales & Export department where part of the personnel is dedicated large customers (Key Account Management), and others are responsible for a certain country. Not shown in Figure 7-28 above, the purchase of IBL also meant a substantial increase in sales force as twenty people are servicing customer in the UK. Adding the sales people in Denmark, the two representatives in Sweden and the three in Norway, the creation of a professional sales organization is no longer an insurmountable task. There are no current plans for doing so, but the dependency of Louis Poulsen is lessening as sales management competencies builds up.

Product Portfolio

The product portfolio is split into three: 1. standard cabinets for overhead lighting, 2. unique lighting solutions for e.g. corporate headquarters, and 3. high quality products for interior industrial lighting. Each of these three sections of the product portfolio is directed towards a distinct market, a distinctiveness that is directly observable in the physical layout of the production in Egestubben.

The production of standard cabinets takes place in a separate building, which was built specially for this purpose¹¹³. The aim is to produce with as low cost as possible. For this type of products, RIEGENS' strategy is to offer a product which is of a superior quality compared with the competitors' offerings, but at comparable (albeit slightly higher) price. The competing products all come from China, but RIEGENS still clings on to a share of this market.

The production of the unique products, which is performed on a project basis, is also located in a separate building. In this building prototypes are developed and manufactured, and even the final products (except in rare cases) are produced here. This type of production is crafts based and rely solely on the competencies of the skilled designers and craftsmen.

The last group of products is the standard items, often grouped in product lines by design. Some of these products are designed by the product development departments at RIEGENS,

¹¹² Source: RIEGENS.

¹¹³ And as of July 1st, 2005 these products are produced in Slovakia as well.

some are designs bought from external designers, and others have originated from some type of cooperation with either customers or architects/entrepreneurs.

Production is quite standard as no postponement or modularization has been implemented. Projects are obviously made to order, and so are the standard cabinets, whereas the portfolio products are made for stock (and occasionally against large orders).

Customer Base

The customer base has changed quite a bit over the past years. Solar, formerly an important customer, is no longer doing business with RIEGENS, and Louis Poulsen who accounted for 65% of total turnover in 2002 no longer dominate the customer portfolio. With RIEGENS LIGHTING accounting for one third of turnover from a wide range of customers, the customer portfolio is now much better balanced. Now Louis Poulsen “only” accounts for another third of the total, Elektroskandia for 20% and the rest distributed over projects and small customers.

The reduction in dependency has not changed the contractual relationship between RIEGENS and Louis Poulsen. It is still based on a rolling five year contract which is re-negotiated every two-three years. The contract is obviously only a fragment of the long-term relationship, but both parties insist on documenting the agreement. The agreement with Elektroskandia is likewise documented by means of contracts. As relationships with both companies are long term, and since both companies are well established in the market periodic financial checks are not performed, but the well-being of the companies is closely followed through various contacts in the companies.

Financial Profile

Despite the turmoil following the UK takeover and the Turkish joint venture, the company had continued its stable operations. The number of employees has fluctuated around 200, the operation in Braintree having a further approx. 100 people employed. As the company had always had a policy of disclosing as little information as possible, only profit before tax is available.

Table 7-19: Financial Profile – RIEGENS a/s¹¹⁴

End Date	Turnover	Profit Before Tax	No. of Employees
2005-12-31	177.503	2.263	214
2004-12-31	159.453	4.025	194
2003-12-31	n.a.	996	184
2002-12-31	152.380	1.855	212
2001-12-31	n.a.	6.001	224
2000-12-31	n.a.	9.174	196
1999-12-31	n.a.	6.369	192
1998-12-31	n.a.	7.120	179

¹¹⁴ No data available on RIEGENS LIGHTING INC., UK.

Modes of Production

Not observable from the figures above, the trend in the project market is shifting towards short lead times. Producing (and designing) to order this constitutes a real threat to the project sales, but so far revenue is increasing and capacity is sufficient. The production of standard cabinets are also performed against firm orders, as RIEGENS does not have warehousing capacity for this rather bulky, low revenue type product. Orders are placed far in advance and are delivered in containers. The standard/portfolio products are produced to stock (and occasionally against large orders).

In contrast to many other companies, RIEGENS have never had the need to outsource production, except for the use of capacity suppliers. The core processes in the production are quite basic and easily accessible in the market, many of the activities performed in-house can be outsourced with relative ease.

Supplier Management

The approach to supplier management has changed quite a bit over the past four years. Henrik Jacobsen (Purchasing Director) describes the practice in place when he joined the company in 2001 as:

“The R&D department was free to use any supplier they liked. ... The entire supplier base was unstructured, and there were no deliberate strategies or procedures for supplier management.”

He was quite aware of the task ahead:

“We needed to do a proper analysis of the entire product specification database to weed out unnecessary suppliers. Given the time, we might re-design products for better use of standard components. ... Current procedures are only tolerated due to a lack of resources...”

The fix to the problem was a concentration of the supplier base, initially by working closely with the two largest suppliers, OSRAM and Philips:

“We have chosen to work with two strategic suppliers, OSRAM and Philips, as they cover approx. 90 % of the items we need.”

Surprisingly, RIEGENS does not share fate with B&O in terms of being a small customer at a much larger supplier, as the purchase volume makes RIEGENS a pretty important customer. Henrik Jacobsen:

“We really do not have problems getting the attention of OSRAM or Philips, we are the eighth largest customer within electronics components in Europe.”

These two critical, strategic suppliers were not monitored:

“We do not perceive using strategic suppliers as risky. Both Philips and OSRAM are very big and well established companies... Furthermore they are direct competitors as approx. 80% of the items we buy from them can be supplied by them both. ... From time to time we move business from OSRAM to Philips or vice versa, depending on their performance and prices. This gives them an incentive to perform well.”

As for evaluating the financial results of suppliers, Henrik Jacobsen was confident that:

“...monitoring the financial results of supplier by e.g. subscribing to some credit information company does not make any sense. Normally information about troubles in a company would be received too late for the information to be useful. Instead we keep in contact with our suppliers and get the information we need through e.g. having frequent meetings at their sites.”

Instead of periodic evaluation, RIEGENS had chosen to keep in continuous contact with the most critical suppliers. Formal meetings were held 2-4 times per year, covering a wide range of subjects within purchasing and product development.

Expanding the ‘Select Few’

Interviewing Henrik Jacobsen in 2005, the sourcing strategies have evolved further:

“We now have a setup of 6-8 ‘lead suppliers’ as we call them. ... They represent a total of 70% of all input [to the production] ... After analyzing the inputs we require we have evaluated our suppliers and selected a ‘lead supplier’ for each category. .. The real advantage of this supplier concentration is on logistics. The selected suppliers are reliable, delivering on time, and in the right quantity and quality. In principle we have redundancy as we have a number of alternative suppliers...”

They still evaluate the suppliers through continuous contact and 2-4 meetings per year, and have extended the sourcing to China and Slovakia, as described above. The 6-8 select suppliers forward a copy of their financial statement, but the skepticism towards this type of reporting has not changed. Henrik Jacobsen insists:

“This type of external fiscal reporting has limited value as it will most often be outdated when it is made available to us. We really need to know what is going on right now, at the suppliers. ... Listening to the grape wine is better than reading their financial statements, but even better is having direct contact [with the supplier].”

Besides evaluating the soundness of the supplier companies, the performance of each supplier is evaluated on delivery precision and quality. Only very rarely do quality problems emerge, and they are most often quickly resolved. Delivery precision is likewise of minor concern. Only on project sales can delivery precision be problematic, due to the shortening of lead times and uniqueness of input.

The Use of Information Technology

As for IT integration, RIEGENS operates at a very low level. Internal systems are based on an outdated technology, as modules in the system are not integrated in the same manner as any modern ERP system. External integration is almost absent as it was realized that the benefits were marginal. Henrik Jacobsen explains:

“We realized that the advantage was in invoicing, not in order management. So we’ve stopped the implementation of EDI with our suppliers – only one of them has a setup.”

In contrast to other companies, RIEGENS does not share e.g. production plans with suppliers or participate in any other kind of ‘Open Books Policies’:

“More and more revenue is generated from project sales. And since lead times are decreasing it does not make any sense to share production planning information, at least not for this part of the production.”

The company thereby has no IT support for internal integration – and apparently does not support its external relationships by means of IT?

SCM Practice

Apparently each member within the RIEGENS family is an autonomous unit - at least it is not identifiable in the organization chart where the responsibility for coordinating with e.g. Braintree is placed. So, internal coordination is either not present or strictly informal?

According to Henrik Jacobsen it is not a problem that SCM is not apparent in the organization chart:

“I believe all companies perform SCM, at least to a certain extent. ... Some companies try to work with the concept theoretically. ... We are more pragmatic – we cooperate with both suppliers and customers as we’ve always done. We try to understand our suppliers’ sourcing problems and try to help them. And we work closely with customers to understand how we better can fulfill their needs. We work in both directions in the supply chain. ... But we do not have the need to use the term SCM...”

The company has certain practices which encompasses more departments, has long-term relationships with customers and suppliers, and tries to accommodate the partners with which it has integrated relationships. Describing the company in terms of supply chains is thereby no problem, see Figure 7-29 below.

Figure 7-29: Supply Chain Diagram – RIEGENS

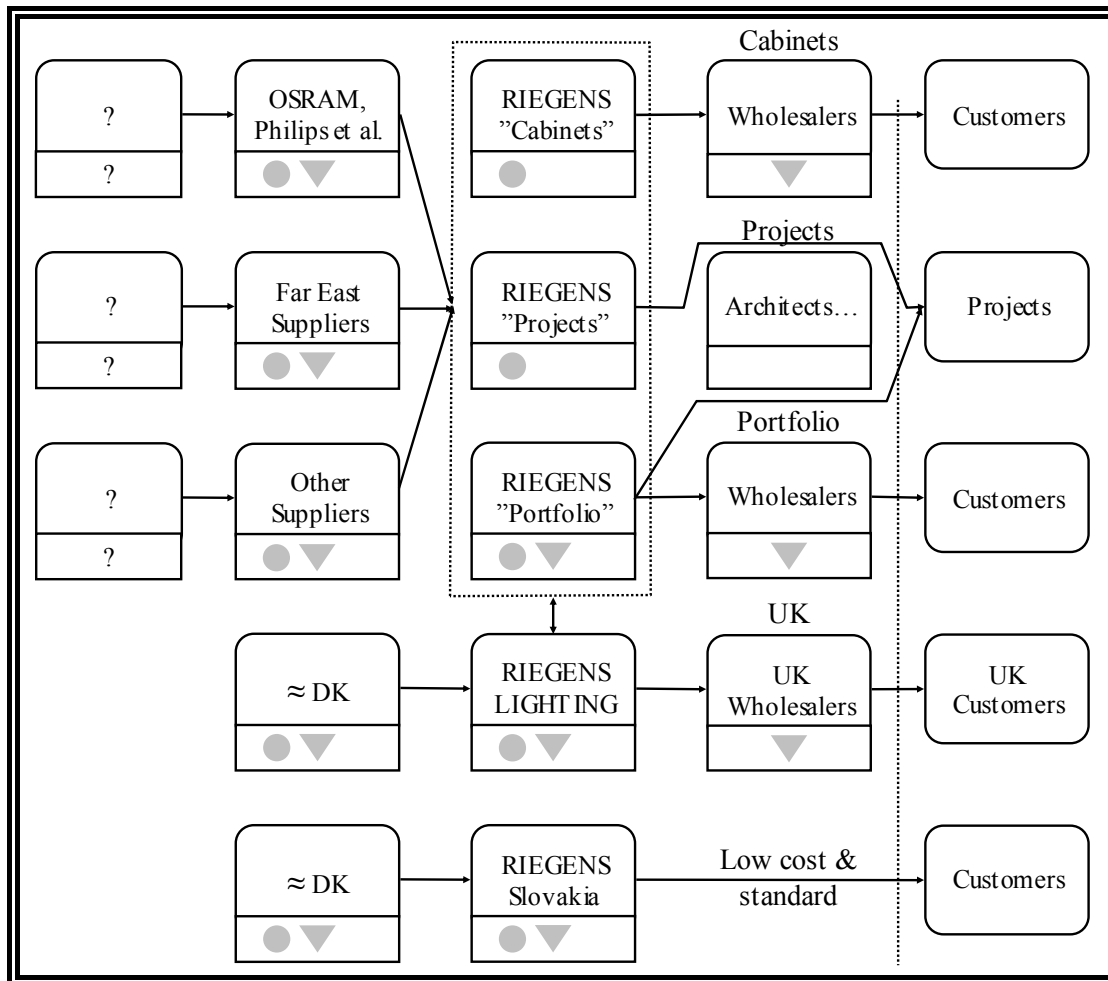

SCRM Practice?

In RIEGENS risk management is reduced to the practices of individuals, as no department and no position for the management of the company’s risks exist. When querying the interviewees about risk management they both concur that risk management is of critical importance. Claus Jensen explains how risk management is used when evaluating (investment) alternatives:

“I my opinion we did all the right things when we worked on the project in Turkey. We had no chance of foreseeing the downturn in the Turkish construction segment. ... We did not perform stringent risk management routines, but we talked about a lot of scenarios, and the outcome was far from the worst case scenario. ... Of course it is a shame that the project was stopped, but that’s the way it is.”

Conversely, Henrik Jakobsen perceives risk management as an embedded element in supplier management as the ongoing evaluation aims at identifying weaknesses in the supply system:

“Albeit we only rarely experience delivery or quality problems we continue to collect the data. That’s just the way it’s done.”

He also elaborates over the generic problem of dependency:

“That is really tricky – determining how close a relationship should be. It’s at the core of buying. ... The closer a relationship is, the more difficult it is to

dissolve. ... In reality, relationships display a degree of inertia - we seem to stick with what we know, even if we are not completely satisfied.”

And over the practice of having close relationships with suppliers and customers:

“You might say that having frequent meetings with suppliers is a form of risk management as it is the best forewarning of problems ahead. ... The trouble of it all is that close relationships are not easily dissolved.”

The paradox is thereby described: the closer the relationship, the more critical the need to perform risk management (SCRM). In this instance the risk management takes the form of close interaction, further enforcing the closeness of the relationship.

Summing Up...

Different from most of the other companies in the study, the focal operation has not changed much over the past years. Instead RIEGENS have “experimented” with foreign ventures – with mixed results. The failing of the Turkish joint venture did not deter the company from investing in Slovakia, and from further developing the operation at Braintree.

The company claims not having implemented SCM (or rather: “most companies probably relate to SCM in one way or another”), but if the operation at Næsby is observed without interaction, one would undoubtedly come to the conclusion that RIEGENS have worked with SCM, and for long. The structuring of the company according to the product portfolio, the long relationships with suppliers and customers, and the degree of collaboration (primarily on projects, though) would suggest so.

SCRM, on the other hand, is somewhat less sophisticated as no structures, procedures or routines for the identification, assessment and monitoring exist.

7.10 SDC DANDISC A/S

Operating in a market driven by technology, the history of SDC DANDISC is closely linked to the development within IT and media technology, see Table 7-20 below.

Table 7-20: Milestones – SDC DANDISC A/S¹¹⁵

Year	Description
1940s	In the 1940s, data was mostly stored on <i>punched cards</i> and <i>punched paper tape</i> . The punched cards and tapes are the distant relatives of the modern CD and DVD disks, which use small ‘punched’ pits to store information.
1951	UNIVAC 1 (universal automatic computer), which is also the first computer to use <i>magnetic tape</i> for storage.
1956	In 1956 IBM introduced the RAMAC (random access method of accounting and control) - the first commercial hard disk drive.
1961	The first hard disk drive with the air-bearing slider was introduced, advancing hard disk drive technology towards much higher recording densities and reliability.
1962	The laser diode was invented (also in IBM) becoming the fundamental technology for read-write optical storage devices.
1963	IBM introduced the first storage unit with removable disks (IBM 1311), effectively ending the era of the punched-cards.
1967	The next major achievement came in 1967 the form of <i>digital audio</i> demonstrated by NHK (Japan Broadcasting Corporation). From this point in time, high-quality audio technology became <i>digital</i> . A mix of sound and picture eventually gave birth to a new - non-mechanical (like the gramophone) and non-magnetic (like the tape) technology - the <i>compact disk</i> , or CD.
1970	The portable storage was born with the invention of the <i>floppy disk</i> .
1977	Three Japanese companies - Sony, Mitsubishi, and Hitachi, demonstrated their <i>optical</i> digital audio disk (DAD) systems which used large disk, about 30 cm in diameter (like the LP records).
1979	The VHS (originally Vertical Helical Scan, later changed to Video Home System) format is introduced in Europe.
1982	The CD (Compact Disc) media is introduced.
1985	The “High Sierra Group” meeting leads to the introduction of the CD-ROM format.
1987	A 1-gigabit-per-square-inch <i>magneto-optical</i> recording with a blue-wavelength gas laser was demonstrated. A few years later, in , the same recording density barrier was broken for magnetic recording with the help of the first <i>magneto resistive (MR) head</i> . The company SDC is founded. At this time only the VHS format is replicated. DANDISC was created at the same time focusing on replication of CD’s. In the following years SDC takes over smaller VHS facilities in Denmark, and establishes good contacts to the film industry.
1995	The DVD (Digital Versatile Discs) format is introduced. The organization “DVD Forum” is founded ¹¹⁶ .
1996	The two companies SDC and DANDISC merge. The new company replicates both CD and VHS formats.
1997	SDC buys the company CD Plant Group which has plants in Sweden, England and Switzerland. CD is thereby the dominant business area within SDC.
1998	The first DVD-ROM drives became available for the computer users. The Digital Millennium Copyright Act (DMCA) was signed into law by President Clinton on October 28, 1998. The legislation implements two 1996 World Intellectual Property Organization (WIPO) treaties: the WIPO Copyright Treaty and the WIPO Performances and Phonograms Treaty. The DMCA has significant impact on how the data is distributed, copied, and stored.
1999	The Munich based company Videoprint is taken over. After the motion picture industry spent years negotiating the encryption standard for digital video discs (DVD), a small group of Norwegian hackers released a program, called DeCSS, which can break the encryption on almost any DVD disk.
2000	SDC centralizes its production of CD’s and DVD’s in fewer facilities to enable better utilization of production capacity and to increase flexibility.
2003	SDC continues to develop its services and new formats (Babydisc, Lotto-CD etc.) are introduced. SDC’s strategy is to become the leading innovative media partner.

¹¹⁵ Source: www.sdc-group.dk & www.usbyte.com (edited together, material on SDC in bold).

¹¹⁶ For more information, see www.dvdforum.org.

As hinted in the table above, SDC DANDISC is a replicator of CD's, DVD's and VHS tapes. The company describes their value chain as illustrated in Figure 7-30 below.

Figure 7-30: SDC VALUE CHAIN¹¹⁷



Based on the customer's input and requirements SDC can help the customer perform editing, premastering, or mastering of the material before the media is reproduced. Various types of supplementary material (inlays, booklets etc.) can be printed and packed with the data bearing media, which can be shipped to the customer or directly to the customers' customers.

The operation in itself is more or less identical to all other players in the market, including the two largest competitors DCM Digital Communication Media AB and TOCANO A/S.

Reproduction & Mastering

Two distinctly different processes exist for the reproduction of discs: duplication and replication. When duplicating discs the starting point is an existing disc from where an "image" is read and subsequently burned onto another disc. The process is suitable for low quantity or when fast delivery is key. In all other circumstances replication is preferred.

When replicating discs the starting point is the information, not necessarily in disc format. Depending on the type of information, e.g. music, films, games, financial reporting etc. editing, mastering and/or programming may be required. Once the material is completed and approved a target (or a glass master) is produced, enabling the molding and further production of the discs. The processes for replication of CD's and DVD's in principle are the same, but the technical formats differ as well as the number of layers in each disc.

The technique for the reproduction of VHS tapes is similar to the duplication process described as an existing tape is the starting point. A VHS tape (the master) is loaded into a machine which then records the content onto a number of other tapes.

So, depending on the reproduction process the mastering must take different forms. The input differs as well: for VHS input include cassettes and so-called pancake (the magnetic tape onto which the information is stored), for duplicated discs the input is a standard "no-name" disc, and for replication the inputs are granulate, silver, glue, and lacquer.

The Replication Process

Replicating CD and DVD is basically a sophisticated form of plastic molding with a couple of other processes embedded. The process varies over the media type, for CD's the production steps are as follows:

1. Granulate is heated and sprayed into a mould.
2. The disc is covered by a thin layer of silver.

¹¹⁷ Source: www.sdc-group.dk.

3. The disc is covered in lacquer.

The process in its entirety is performed on one machine in one fully automated, continuous process taking a total production time per disc of approx. 2½ seconds. Input is simple: granulate, silver, glue, and lacquer, output is semi-finished discs. Subsequent to the replication process, the discs are printed upon using one of two techniques. The production of e.g. inlays or covers is done by an independent “in-house” printing operation¹¹⁸, having integrated their processes with SDC to ensure minimal processing time¹¹⁹.

For DVD-5’s (single layer DVD’s) the production is more complex as a transparent disc is glued onto the metal surface before the lacquer is applied. For double-layered DVD discs (the so-called DVD-9’s) the production process is even more complicated (or rather the machines producing the discs are) as yet another layer of disc with metal coating is placed between the first metal coating and the transparent disc. Printing and packaging is identical across media type.

Besides above mentioned services SDC offers copy protection products for both CD and DVD formats as well as distribution & logistics. SDC thereby “goes full circle” from the raw material to the delivery of the finished product.

Organization

As illustrated in Table 7-20 above, the technology has evolved quite rapidly. Even if SDC entered the market as late as 1987, they are currently supporting three generations of technology (VHS, CD & DVD) plus additional variants. The speed of technological change has forced SDC and the rest of the players in this market to continuously adapt technology, structure and scale in order to survive in the very competitive industry.

The transition from new-comer to the largest media replicator in Scandinavia has been a turbulent one. To obtain market share, cost advantages, and competences the company has performed a number of merger and acquisitions over the years.

But the reverse has also taken place. Following the down turn in the VHS market, the VHS replication plant in Brabrand, Århus was shut down in 2004 when all VHS duplication was centralized in Täby, Sweden. The activities in Finland were sold off in the same year, to the then managing director, Ilkka Immonen.

Also in 2004, the activities in the UK were “sold off” to the software company Thamesdown Software Fulfilment, at the same time obtaining 25% of the shares in the parent company (which was renamed Thamesdown SDC Limited).

¹¹⁸ Actually, the printing operation is a tenant at the Saksøbing plant, but operates independently as they print e.g. books and brochures for other customers.

¹¹⁹ Processes are to be kept as rational as possible, keeping total turnaround times to a minimum. Customers requiring extremely short turnaround times (< 24 hours) the company has a service offering called Quick Service. Using this service a customer can have a smaller number of units duplicated (in contrast to replicated) at a marked up price.

The merger between SDC and the second largest replicator in Scandinavia DCM Digital Communications Media AB was almost a reality, but didn't go through due to unsuccessful price negotiations¹²⁰.

This series of adaptation to the extremely competitive and price sensitive market, resulted in SDC having locations in four countries¹²¹:

- Denmark: Copenhagen (headquarters) & Sakskøbing (CD/DVD replication),
- Germany: Munich & Leipzig (both sales),
- Norway: Oslo (sales), and
- Sweden: Borås, Göteborg, Malmö, & Stockholm (sales) & Täby (VHS duplication).

At all sales offices Quick Service (duplication of smaller batches of CD's and DVD's) is available.

This continued adaptation has resulted in a steady decline in turnover and moderate swings in profit, see Table 7-21 below. As a result of an increased degree of automation the number of employees has declined steadily during recent years.

Table 7-21: Financial Profile – SDC DANDISC A/S

End Date	Turnover	Profit Before Tax	No. of Employees
2004-12-31	519.634	15.837	426
2003-12-31	552.022	32.610	471
2002-12-31	598.156	-16.096	504
2001-12-31	635.228	-38.094	560
2000-12-31	705.735	-19.375	620
1999-12-31	687.944	25.207	639
1998-12-31	687.967	-2.472	698

Customer Base

Until recently the customer base was quite heterogeneous as the German media conglomerate Technicolor accounted for approx. 50% of the turnover on CD/DVD replication. Technicolor used SDC as a capacity supplier and distributor in the Nordic countries, primarily for products from the American movie industry. Technicolor had been a customer for quite some time, and the cooperation was fault and problem free. This caused Jesper Boysen (CEO) in 2004 to explicate his confidence in a continued business relationship:

“We have a long-term relationship with Technicolor. They are tough negotiators and they know we need their business. ... They know what they want to pay for our services, but they also know they can not themselves distribute their products in Scandinavia. They've tried that before, and that did not go well at all.”

¹²⁰ As late as July 2005 the acquisition of Digital Communication Media AB was completed. This gives SDC a clear advantage as DCM has a good position within the audio industry, complementing SDC's position within games and movies. The last local competitor, TOCANO, is after the merger but a marginal player in the Scandinavian market.

¹²¹ SDC still cooperates with the sales office in Finland as well as the UK organization.

This judgment turned out to be incorrect, since Technicolor in 2004 chose to start moving production of DVD's and CD's to Poland. Apparently the competence for distribution in Scandinavia was no longer needed? The annual contract was renewed for 2005 only, with a set limit as usual, but fair warning was given that the contract would expire without renewal by the end of 2005.

Paradoxically the contact persons at operational level at Technicolor were quite discouraged by the strategic decision to no longer use SDC. So much so that they decided to build inventory with the products planned for production at SDC, resulting in the contract limit being reached in May of 2005. The loss of Technicolor obviously constituted a major problem as high utilization is needed to ensure survival in the industry¹²².

SDC still produces and distributes VHS products for Technicolor, but the turnover is marginal. No other customer dominates the customer base, but a few of the remaining customer are relatively larger than the rest. These customers include e.g. the Danish film companies and magazine publishers Bonniers and Gyldendal. For this group of customers relationships are long-term, but as Ernest Fuller (Production Manager) states:

“In this industry nothing is ‘safe’ – competition is intense, and has changed from local, to Scandinavian, to European. This means that we are now competing with e.g. the Swedish company PolyVox, and the German companies ODS, SinRam etc. On the other hand we’re extending our sales organization to address their customer base as well.”

So far, SDC has been successful in penetrating selected European markets.

Investing in Technology

Jesper Boysen explains the mechanisms of strategizing within the media replication industry:

“When running a company in this industry, it all about ‘reading the curves’. In the mid 1990’s a series of badly timed investments almost drove the company into bankruptcy. ... You may have an interest in a certain customer segment, and that’s fine, but by the end of the day it’s all about scale. You need high utilization to be profitable – all the time.”

He continues to explain the criticality of determining when to invest in new technology and how to set prices. As the life time of a media technology is decreasing and the cost of machinery for duplication/replication is increasing, it is a matter of accumulating enough capital to invest in the next generation of technology. Timing the entrance into new technology and setting prices is therefore of critical importance.

As illustrated in Figure 7-31 below it is a continuous struggle to minimize cost and increase revenue, just to stay in the market. Henrik Frandsen (Purchasing Manager) explains how the company is determined on surviving by being more efficient than its competitors:

“We have no strategy department. ... We do what we can to trim the organization and processes to cut costs and add value to our customers. ...

¹²² Perhaps this was the decisive factor in the purchase of DCM in July 2005. With the purchase the customer base was increased, ensuring sufficient scale and an attractive balance across movie and games/music customers.

The margin is extremely low - we're only making money as long as we have high utilization."

Investing in new technology is obviously critical importance, but so is the exit of old technology. Despite the recent transfer of the VHS production from Brabrand to Täby, SDC DANDISC is following the development in the VHS market quite closely, to ensure optimal timing of the exit, Ernest Fuller:

"As the VHS market is steadily becoming more and more uninteresting, we constantly monitor [the activities in Täby]. ... We are ready to shut down [the VHS production] when it is no longer profitable."

The decreasing life span of technologies and the increased importance of timing when entering into and exiting from a technology is illustrated in Figure 7-31 below.

Figure 7-31: Business Cycle for the Media Industry

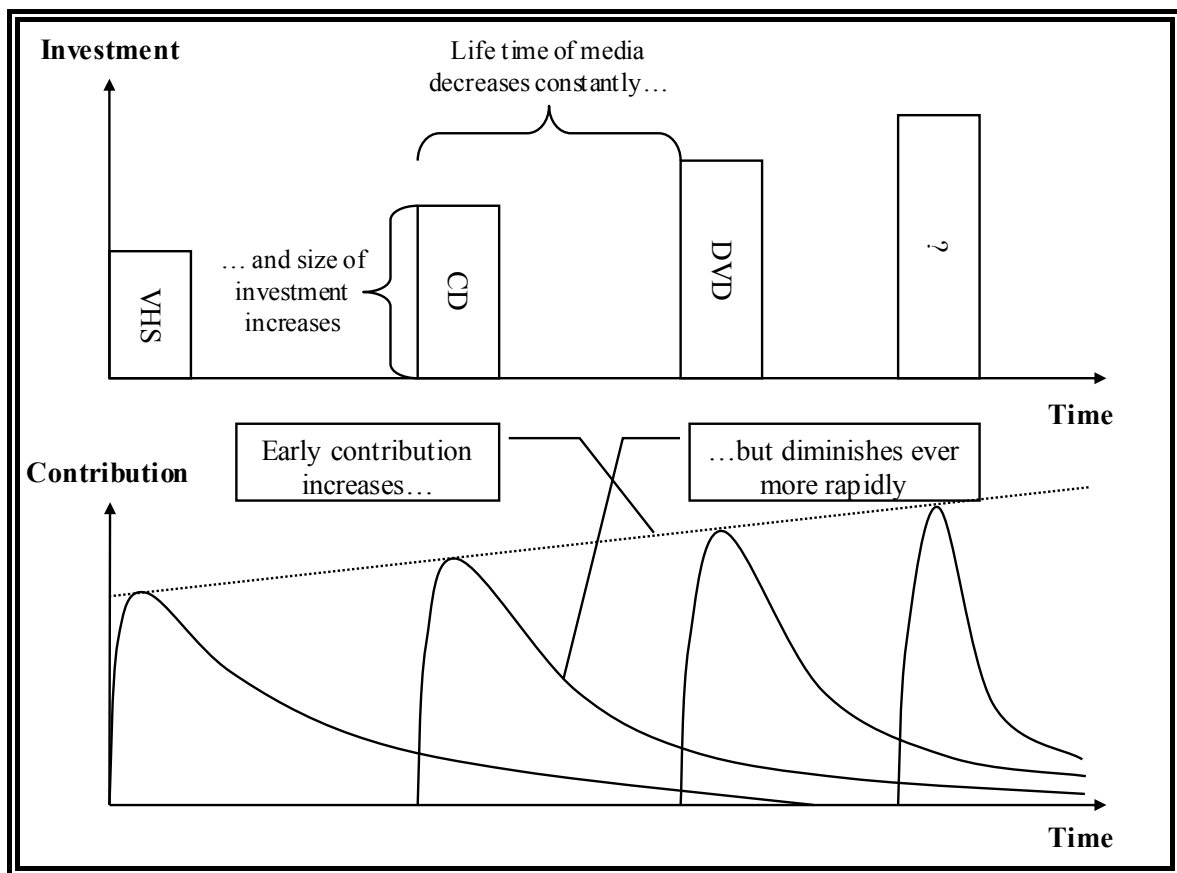

Also specific to the replication industry the cost-price gap creates ample opportunities for fraudulent replication, a problem addressed by the independent industry organization IFPI.

IFPI

The entire industry is under the supervision of International Federation of the Phonographic Industry (IFPI)¹²³, an organization controlling if the non-authorized replication takes place. Normally, the ownership structure of a replication right might be very complicated. Movies

¹²³ For more information, please see www.ifpi.com.

for instance, might be the property of Nordisk Film, which may have sold off the right for replication for e.g. a five year period. As bundling may increase the value of each right, it may be in the interest of the replication right owner to “rent out” the replication right for e.g. 2 years for a specific market. The replication right structure may thereby be very complicated and quite difficult to unravel. It is therefore the current practice in the industry that the replicators themselves do not verify if the replication right is actually the property of the customer, but lets the customer sign a contract stating that the customer takes full responsibility if property rights have been violated.

Henrik Frandsen reports one instance where IFPI made inspection:

“Some time ago we actually had a case where the replicated material was violating property rights. The customer was a Russian living in Sweden who ordered the replication of a larger portion of classical music. He presented us with a contract documenting the property rights, and he subsequently signed one of our standard contracts. Some time later IFPI recognized that the property rights were violated, but luckily we had all paperwork in place and did not get fined.”

Referencing situation where competitors were fined, Henrik Frandsen explains why following the process for ensuring liability is minimized (if not avoided) is critical. Adhering to processes for all orders is thereby not only a means to reduce turnaround times - it is also risk management.

Supplier Management

As described above input to the production is both relatively simple and the number of items purchased is very limited. None of the primary inputs are scarce, and there are multiple suppliers for all items. Granulate, for instance, is currently bought from Bayer but previously GE supplied this input. Ole Holm (Purchasing Assistant) explains current practice:

“Currently we buy granulate on three month contracts. Every time the contract is about to expire we investigate prices, and from that analysis another three month contract is offered. Bayer currently has the best products, but there are other equivalent products.”

Albeit many alternatives exist, some input are marginally better performing, Ole Holm states:

“Apparently, the product Bayer has at the moment is the best product for our machines. The people in the production will object if we choose another brand.”

Inputs are thereby substitutable, but since it takes time to adjust and calibrate the machines, the price difference must have a certain size for the shift in input to make sense. The company has not integrated with any suppliers of input to the production, neither socially, process wise or by the use of IT.

The only risk element in relation to input is the oil price. Ernest Fuller explains:

“Even if most if not all of our input is pretty standard, the price depends on the price of oil. ... We therefore negotiate prices every quarter. ... We have no means of influencing the market, we are way too small, but at least it [the fixed price] gives us a sort of stability.”

Also ensuring stability is the fixed conversion rate between the Danish Krone and the Euro, as most trade is done in Euro. The imports from China is decreasing with the downturn of the VHS market, thereby simplifying the logistical setup.

SCM Practice

The company does not perform SCM but has a truly process oriented company as described above. The company's various setups can be illustrated as below.

Figure 7-32: Supply Chain Diagram – SDC DANDISC A/S

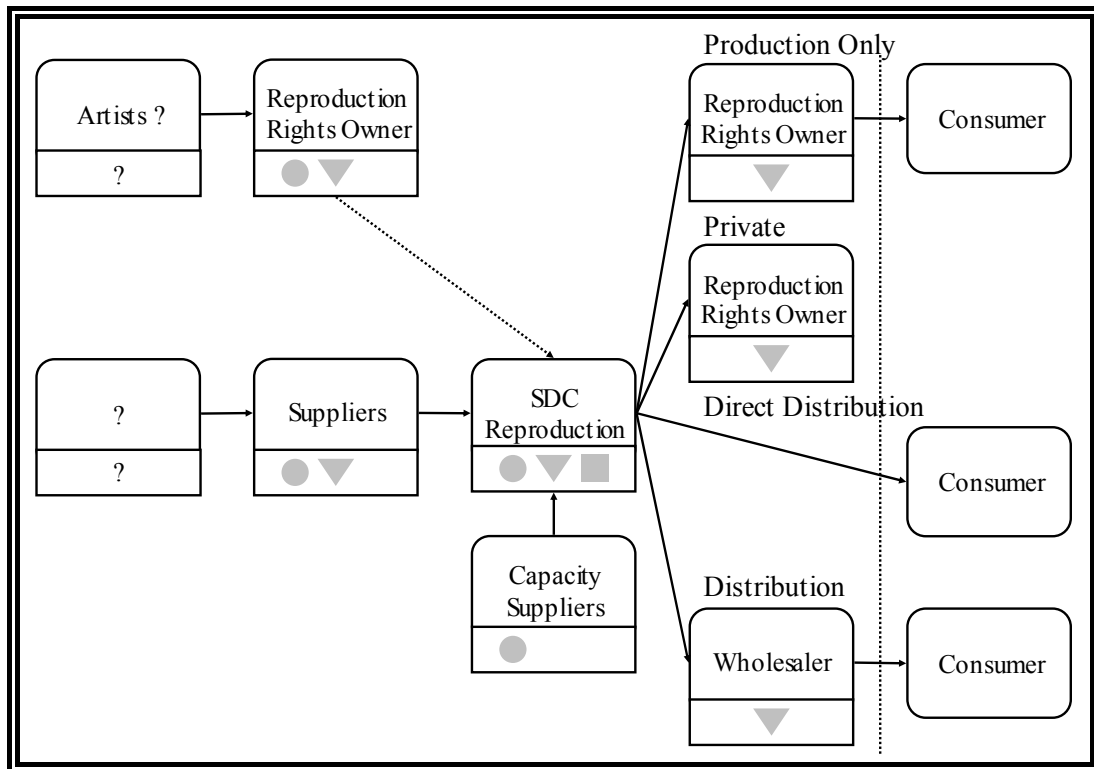

Unlike most of the companies in the study, SDC DANDISC claims not having implemented SCM. Albeit being the most clearly process-oriented company in the study, the company insists on not using SCM, and explains the process orientation as a means to minimize lead times, not to facilitate cross-functional integration. The company thereby shows some of the “classic” signs of SCM without having done anything to implement it.

The supply chain depicted in Figure 7-32 above thereby is a bit illusory – but hopefully brings an understanding of the operation of the company across. The first supply chain, ‘Production Only’ describes the traditional operations task. The supply chain ‘Distribution’ only differs from this supply in shipping address (and perhaps in ordering method), the supply chain ‘Direct Distribution’ describes a more complex setup as the customers of the Reproduction Rights Owner (who is the customer of SDC DANDISC) is made known to SDC DANDISC. The last supply chain, ‘Private’, is radically different from the others; first and foremost in order size and frequency, and also in use of the product. Orders are most likely quite small and infrequent, as the materials are often used for e.g. the financial statements or support materials for e.g. tender material.

Besides the production of which 90-95% is finalized within 24 hours of receiving the order, the company offers the use of a customer buffer inventory. The inventory is integrated with production planning and has its own small inventory management module, by which the customer can have access to the inventory information for their goods.

The buffer inventory system is physically located at the plant in Saks København, and is supposed to support back-catalogue items as well as new releases. The intent is a win-win situation where SDC DANDISC is allowed to produce in larger quantities, and the customer can have their items shipped very quickly as only packaging and distribution is needed. A further advantage for the customers is the possibility of postponement as the disc alone can be put in stock, postponing the country specific packaging. So far the offering has been less popular than expected, but the system works as designed and the few customers using it are content.

SCRM Practice?

Not surprisingly to Jesper Boysen the major risk facing SDC is ‘misreading the curves’ – making the wrong investment or missing the timing of an investment. The risk is illustrated above (see Figure 7-31), but apparently has no formal response except the ‘gut feel’ of the CEO and trusted employees.

To Henrik Frandsen the major risk has to do with contamination of material. The worst conceivable scenario is readily described:

“Just imagine the effect of having material from a ‘blue movie’ put on a Walt Disney disc. Especially in the US such an incident will enable the consumer to sue Walt Disney for a tremendous amount of money. To ensure this does not happen, certain customers will require their media replicators to not reproduce certain types of material. ... We do not reproduce adult material at all – if we did we could not work for Technicolor [who deals with the major Hollywood studios].”

Measures taken to handle this risk are therefore pretty dramatic as the entire adult entertainment segment (which is very lucrative, according to Henrik Frandsen) is avoided. For other types of material, planning methods ensure that a sequence of production orders will be sequenced according to rating, minimizing the damage of mixing discs and packaging.

But the risk most visible to the visitor at the plant in Saks København is the risk of disclosing non-released material. The plant itself is surrounded by a tall spiked fence and outside normal operating hours the area is secured by movement sensors and security guards with dogs patrolling the area. Visitors and employees alike are all subject to physical controls upon leaving the facility ensuring the confidential or otherwise non-released information is kept on-site. Not visible to the naked eye safety measures go even further as all e-mail traffic is monitored as well.

To production manager Ernest Fuller risk management is primarily oriented internally. He considers risk management a focal element of his job, ensuring predictability and stability in the production. He describes how SDC DANDISC currently is negotiating with other

replicators to stand by in case of problems in production¹²⁴. He furthermore explains where risk management is taking place in the organization:

“Formally we have no risk management function, but risk management takes place in various parts of the organization. When managing customers, especially new ones, we perform credit checks. In case the check is not satisfactory, we ask the customer to pay in advance or upon shipment. ... In relation to the supplier, there is really not a lot to be done as we are so much smaller than our suppliers. ... And finally, currency risk is minimal as almost all transactions are done in either Danish crowns or Euro. There’s really not that much to be done.”

Commenting on current practices of production and the risk management, Ernest Fuller emphasizes again that he (and the rest of management at SDC DANDISC) really is focused on Risk Management albeit not formalized.

Summing Up...

Insisting, like RIEGENS, on not performing SCM the company is the most process oriented company in the study. The process and the decision points are described in considerable detail on the company website, describing lead times, alternative delivery processes etc.

The production technology at first glance appears complex but soon one realizes complexity is handled by highly sophisticated machines – employee interference in the replication/duplication process is minimal. Inputs (direct input, that is) are trivial as multiple suppliers of the very few input needed exists, and contracts are negotiated on a quarterly basis.

The use of the highly specialized and sophisticated equipment is both the “curse and blessing” of the industry, where the well run company makes investments with appropriate timing, and other succumbs. As illustrated in Figure 7-31 poor timing might severely damage the company – and a lot of effort goes into safeguarding the investment decision is accurate.

SCRM takes second (or third) place but remain important (as documented by the loss of the largest customer) but not formalized, documented, or audited.

¹²⁴ Which may be perceived as a structural response to either a process or structural incident.

Chapter 8 Cross-case Analysis

The purpose of this chapter is to answer the fourth and last research question:

Research Question 4: How do the case companies perform SCM and SCRМ?

First the SCM and subsequently the SCRМ constructs are analyzed for all participating case companies. Thereafter the overall results from the two practices are compared. Finally the results are validated by means of empirical triangulations.

8.1 Evaluating SCM Practices by Constructs

The practices described in the previous chapter span a wide range in terms of organization, complexity, external pressures, competencies, strategies employed etc. Each case has its unique characteristics which will be explicated in the analysis below.

8.1.1 Construct ‘Supply Chain Organization’

As described in the case studies in previous chapter most of the case companies (seven of the ten) perceive themselves as performing SCM, albeit in quite different ways and apparently to attain different goals. Some consider the close interaction with suppliers as being SCM, whereas others refer to e.g. the implementation of LEAN Manufacturing. Only few companies have “SCM terminology” implemented in their organization charts and most still reference typical functional departments like Purchasing, Production, and Distribution.

An exception is Coloplast where ‘Supply Chain Management’ is clearly represented in the formal organization charts (see e.g. Figure 7-9). The SCM department is responsible for sourcing and manufacturing, and distribution to the sales companies. The customer contact is thereby not included in the SCM concept in place at Coloplast.

Another exception is Fritz Hansen who has ‘Supply Chain’ as one of four major departments (see Figure 7-15). As illustrated in Figure 7-17 the SCM department is responsible for production (both plants), and for ‘Development’ and ‘Quality’. As the ‘Sales & Brand Management’ department is responsible for project sales and support of international and national representatives, ‘Supply Chain’ does not support the sales/marketing aspect of the operation but remains in control over Sourcing, Production, and Distribution.

In contrast, Oticon does not have an organization chart at all, but describes their SCM organization by three ‘teams’: Purchasing/Procurement, Logistics, and Supply Chain Planning. The teams have the overall responsibility for the Mass Customization production philosophy implemented. They are responsible for the push portion of the process, to keep up inventory levels on modular components and for ensuring process lead times are adhered to when customizing the end customer’s product.

Shifts in Organizational Level

Looking beyond the snapshots as described in the organization charts, a few companies reveal similar dynamics. At Dyrup the shift between SCM as a staff function supporting autonomous plants and SCM as a strategic function coordinating activities is quite distinct. The organizational change mentioned in the case study makes Henrik D. Nielsen overall responsible for sourcing, operations, and distribution world-wide. A similar change took place recently at Coloplast, where Johnny Nielsen was made responsible for all operations and distribution (to the sales companies).

Companies Not Working With SCM

Of the ten case companies, three companies (Brüel & Kjær, RIEGENS and SDC DANDISC) claim not working with SCM. Each offers a distinct explanation:

- At Brüel & Kjær the lack of SCM is attributed the quite diffuse organizational development taking place. Henrik Jeppesen describes the practices in place across departments as being primarily determined by the idiosyncrasies of powerful individuals instead of an overall design of the company.
- At RIEGENS Henrik Jakobsen perceives SCM as a generic concept, not a distinct set of principles. He insists RIEGENS has done nothing to implement SCM, but “probably most companies relate to SCM in one way or another”.
- At SDC DANDISC the concept is rejected as they perceive themselves as a traditional manufacturing unit (albeit CEO Jesper Boysen insists the company is a service company).

It is therefore quite interesting that RIEGENS has the most customer/market-oriented organization as it has distinct organization for Portfolio items (which are produced against inventory levels), Standard items (low cost overhead cabinets) which are produced against large orders on an almost continuous basis, and Project items which are uniquely designed for each order and therefore made-to-order. Similarly interesting is the effect of the tight deadlines enforcing close internal integration at SDC DANDISC. This integration is not defined from an appreciation of improved performance or the benefits of cooperation, but for a need to accommodate the requirements in the market. And even if processes are communicated externally, internal organization is still strictly functional.

Companies Working With SCM

All in all the companies' implementation of SCM differ greatly and only four companies (Coloplast, Dyrup, Fritz Hansen, & Novozymes) have implemented what one might call 'Formal SCM' – and at Dyrup the organization is still very young. It seems that SCM develops from the bottom up, matures, and subsequently “takes over” the overall responsibility of the original 'sponsor department'. The only exception seems to be Novozymes, where the implementation of SCM was 'top down' - after careful and thorough analysis. A summary of these two constructs along with the evaluation of formalization of SCM is presented in Table 8-1 below.

Table 8-1: Summary of ‘Supply Chain Organization’¹

Company	SCM?	SCM Organization	Formal SCM
Bang & Olufsen	Yes	A formal SCM organization as such does not exist, but the SQCT stakeholders (Supply, Quality, Cost, and Technology) are obliged to cooperate to create optimal sourcing solutions for all products. The ‘Supply Chain Concept’ mentioned in Chapter Seven encompassing most departments at Bang & Olufsen Operations a/s (see Figure 7-4) is thereby not a strictly formal structure.	No
Brüel & Kjør	No	No, but it may be implemented in the near future. The intended implementation will/may include Design For Manufacture (DFM) – a technique aiming at ensuring “easy” manufacturing and assembly. Exactly how this corresponds to SCM and which organizational consequences it will have is unclear.	No
Coloplast	Yes	As described in e.g. Figure 7-9 SCM is directly identifiable in the formal organization chart. Johnny Nielsen was recently made responsible for the global supply chains – and the development is ongoing. Currently, the largest challenge is the migration from local warehousing to the central warehouse in Germany, and the transition from production against forecast to order production.	Yes
Dyrup	Yes	Currently plants are operating as traditional manufacturing stand-alone operations, with local management and autonomy. Recent (October 2005) changes will affect this drastically as it has been decided to implement a centralized SCM organization with responsibility for both production and procurement. The intent is to speed up a much needed update of the logistical systems and to ensure better usage of capacity across plants.	(Yes)
Fritz Hansen	Yes, LEAN	An SCM organization is in place, encompassing production at the two factories as well as Purchasing, Quality, and Development Management. The two plants operate quite differently, though. (The chair production plant is left out of the rest of the analysis).	Yes
LINAK	Yes, LEAN	No SCM organization exists, Logistics is situated under Production. The feeder units (Electronics and Spindles) operate on market terms, offering its output to the divisions.	No
Novozymes	Yes	Supply Chain Operations is directed downstream. SCO receives produce from bulk production, creates the customized end-product and distributes to customers.	Yes
Oticon	Yes	Albeit the company does not use organization chart it is evident the ‘Teams’ structure support the Fulfillment meta-process. The entire operation is designed for quick order fulfillment, relying to a certain extent on external parties.	No
RIEGENS	No	Paradoxically, the company is organized around the three distinct types of products: Standard (low cost) overhead cabinets, portfolio products, and projects. Furthermore both customer and supplier basis are quite stable.	No
SDC DANDISC	No	Each function: Production Preparation, Production, and Distribution operate under very strict deadlines, ensuring a quick turn-around. But there’s no real adaptation or integration between the departments, except for production planning.	No

SCM - An Alternative Organizational Entity

It seems that in some companies (Bang & Olufsen, LINAK, and Oticon) the SCM operation is organized not as a formal entity but as a more or less formalized structure outside of or in addition to the formal system. E.g. in Bang & Olufsen, logisticians have worked with SCM

¹ The ‘SCM?’ column describes the self-perception by the interviewees, i.e. whether they believe their company performs SCM.

for many years, but this has still not resulted in the formation of a SCM department or a VP position within the domain. Nonetheless it is evident that companies do work with SCM even if no formal organization or positions exist referencing the domain. At LINAK the company is undergoing structural changes as the implementation of product divisions is still incomplete², at Oticon the absence of a SCM department might be expected as the level of formalization is kept at an absolute minimum.

Matching the Fulfillment Meta-process

Besides understanding whether a formal or informal SCM organization exists at the case companies, it seems relevant to analyze to which extent the area of responsibility matches the “Fulfillment Meta-process” described in Chapter 2. The analysis obviously is only relevant for the companies working with SCM - therefore the companies rejecting SCM are excluded from the analysis documented in Table 8-2 below.

Table 8-2: Coverage of the Fulfillment Meta-process

Company	SCM?	Formal SCM?	Sourcing	Production	Distribution
Bang & Olufsen	Yes	No	Yes	Yes	Yes
Brüel & Kjør	No	No	N/A	N/A	N/A
Coloplast	Yes	Yes	Yes	Yes	(Yes)
Dyrup	Yes	(Yes)	(Yes)	(Yes)	(Yes)
Fritz Hansen	Yes	Yes	Yes	Yes	Yes
LINAK	Yes	No	No	Yes	Yes
Novozymes	Yes	Yes	No	(Yes)	Yes
Oticon	Yes	No	Yes	Yes	Yes
RIEGENS	No	No	N/A	N/A	N/A
SDC DANDISC	No	No	N/A	N/A	N/A

Actually at most of the companies the SCM practice covers the meta-process quite well. But since the analysis above focus on the main operation (HQ) alone it might be misleading. In case it is extended to show the entire scope of the fulfillment system, the picture would be less rosy.

As described above SCM at Coloplast ends at the sales company level, in reality de-coupling the “within ownership network” supply chain at the sales company inventory³. Other examples include Brüel & Kjør, Dyrup, and LINAK. For the B-2-C supply chains (e.g. Bang & Olufsen’s Sales Company & European supply chains, both Fritz Hansen’s supply chains, and the fitting process in Oticon’s supply chains) this decoupling obviously does not occur.

Sales/Marketing and SCM Organization

As mentioned in a number of the cases the sales/marketing function is decoupled from the SCM implementation, especially for the multinational companies. At Bang & Olufsen, for instance, the Supply Chain Concept ensures delivery to end-consumers, dealers, and

² Unfortunately the primary contact at LINAK, Morten S. Raahede, left the company by late 2005, before this issue could be investigated further.

³ Actually the inventory is being centralized at the new central distribution hub. This might lead to changes to the scope of the SCM practice and the “length” of the processes.

warehouses, but does not contain any of the sales/marketing activities. Coloplast is identical in this respect as their SCM concept ends at the sales company level. In contrast all companies performing customer project (Brüel & Kjær, LINAK, and Novozymes⁴) are interacting directly with the customers. In all three examples the interaction is direct, not by proxy as at e.g. RIEGENS⁵. It seems evident the “project type” supply chains thereby differ from “normal operations” (the long-linked technology) in terms of customer/consumer participation – and in support of sales/marketing. In “normal operations” sales/marketing is perceived as separate from the fulfillment system (SCM).

8.1.2 Construct ‘Process Orientation’

As briefly referenced in Chapter 1 and described in detail in Appendix A, companies’ definition of processes does not “fit” well with the literature. In the literature the processes are expected to cross functional silos, and perhaps even extend beyond the boundaries of the company. In the pilot studies a number of the participating companies claimed to work process oriented, but the analysis revealed that processes in some instances simply were a restatement of typical department names. This was one of the major criticisms of the existing models - it is therefore of critical importance to understand how the case companies understand process-orientation, whether they find it relevant to implement, and if already implemented the names and content of the processes.

The level of implementation of processes and the understanding of the term ‘process’ span a wide range:

- At Bang & Olufsen the four processes mentioned are quite different from each other as one is periodic and tactical (Planning: Demand and Production), one is continuous and operational (Order Handling) and one is (presumably) aperiodic and tactical (Business Process Development). The notion of process referenced in the ‘Supply Chain Concept’ is thereby quite abstract. One might make the distinction between the overall (strategic?) concept of Business Process (see e.g. Hammer & Champy, 1993; Hammer, 1996) and the process concept inherent in the SCM domain (see e.g. Davenport, 1993).
- Also at Novozymes the notion of process is somewhat ambiguous as Thomas Videbæk identifies at least three different types of processes: the manufacturing process, the customer service process, and the supply chain planning process. Here the process typology is extended with the production process introducing activities not performed by human actors.

Less ambiguity might be expected when implementing a process-based production philosophy like LEAN Manufacturing, but at Fritz Hansen, Henrik Holm is not really sure how process orientation actually fit with the LEAN concept:

“Well, at the core of the LEAN concept is an idea of process and the unhindered flow of materials, but when we talk about processes we often talk

⁴ Also RIEGENS and SDC DANDISC perform customer projects, but they do not perform SCM.

⁵ At RIEGENS customer projects are often managed by e.g. architects or construction companies. In many of these projects, RIEGENS have limited access to the end-user of the facility under construction.

about inter-organizational processes. When we deal with our Supply Partners, we try to make the way we work, the processes, fit together. Therefore talking about processes and LEAN is somewhat difficult, but I guess we have just one process, then: fulfillment.”

At LINAK, also using LEAN, the setup is more complicated as separate entities produce certain product categories, and few entities operate as feeder plants. In both cases the processes are non-distinguishable from the production process.

At Brüel & Kjær, Dyrup, RIEGENS, and SDC DANDISC process orientation is absent. Table 8-3 below summarizes the findings.

Table 8-3: Summary of ‘Process Orientation’

Company	Process Orientation	Process(es)
Bang & Olufsen	The ‘Supply Chain Concept’ contains three (four) processes, but they are fundamentally different from each other. It seems quite unlikely these processes are linked into the work performed in the organization besides at the most overall, abstract level.	Demand Planning (Sales Org’s & Customer Centre), Production Planning (Operations in Struer), Order Handling (Dealers & Logistics), and Business Process Development (all?).
Brüel & Kjær	No, the company is a traditional manufacturing firm, even if manufacturing has been outsourced. In the project department the work is of a more iterative character.	N/A
Coloplast	Yes, the company aims at altering the current practice of “soft ownership” to “hard ownership” by ensuring both competence and responsibility at Process Owner level.	Processes are not named, but start and end at customer order entry in the sales companies. Is translated into: Order Fulfillment. Demand forecasts are processed at HQ after inputs from the sales companies.
Dyrup	No. The company is a traditional manufacturing firm, with a distinct separation between e.g. production and sales.	None currently, but processes might be implemented as the SCM organization matures...
Fritz Hansen	Yes, the ‘standard operation’ is based on a well defined process, but it is perceived as LEAN instead of a process as such. Manufacture of special/ expensive products is not process oriented.	Fulfillment?
LINAK	Yes, as defined by the LEAN implementation.	Fulfillment?
Novozymes	Yes, but in various ways as described above.	Customer Service, Fulfillment, and SC Planning.
Oticon	Yes, the ‘Teams’ structure may indicate process orientation.	Processes identical to area of responsibility within each team?
RIEGENS	The company has done nothing to implement process orientation.	N/A
SDC DANDISC	No. Process communicated externally, but not used as an organizational unit internally.	N/A

A Typology of Process Interpretations

Building from the above described interpretations a typology of processes emerges:

1. Business Process (as understood by e.g. Hammer & Champy (1993)),

2. Manufacturing Process (e.g. the part of the fulfillment process solely relating to operations)⁶,
3. SCM Process (processes combining human and non-human actors in processes spanning across functional silos, and perhaps even extending beyond the legal boundary of the company), and
4. Department Process (like the SCM process, but embedded within a functional silo and with no or little coordination with other processes).

Evaluating the identified processes and classifying according to this typology results in a more nuanced picture of the interpretation and implementation of processes at the case companies, see below.

Table 8-4: Categorization of Processes

Company	Process Orientation?	Process Type(s)			
		Bus. Process	Manufact.	SCM	Department
Bang & Olufsen	Yes	Demand Planning, Business Process Development	Production Planning	Order Handling	
Brüel & Kjaer	No	N/A	N/A	N/A	N/A
Coloplast	Yes	Demand Planning		Order Fulfillment	
Dyrup	No	N/A	N/A	N/A	N/A
Fritz Hansen	(Yes)		Order Fulfillment?		
LINAK	(Yes)		Order Fulfillment?		
Novozymes	Yes	SC Planning		Fulfillment	Customer Service
Oticon	(Yes)			Inbound Transports, Logistics, Outbound Transports? ⁷	
RIEGENS	No	N/A	N/A	N/A	N/A
SDC DANDISC	No	N/A	N/A	N/A	N/A

First and foremost it must be recognized that a more stringent and detailed analysis of each process, e.g. through direct observation, would have revealed more insights into the internal logic of the processes⁸. It might also have revealed that more processes exist, or that the mentioned processes exist only through the perception of the interviewees. Where possible

⁶ Please note the difference between the ‘Manufacturing Process’ as defined in Chapter 6.2.3 and this construct. The former is a measure imposed by the author as a result of an evaluation of the external conditions, whereas the latter is introduced through the process definitions put forward by the case companies.

⁷ The three teams names listed are perceived as SCM processes as the responsibility of each team spans more than one traditional silo, or spans across the boundary of the company. It is recognized, though, that this is a somewhat bold decision.

⁸ Various tools for analyzing and describing processes exist, see e.g. Hines & Rich (1997).

the processes identified by one interviewee are controlled against at least one more interviewee, but still: more processes might exist.

Nonetheless, evaluating the processes as mapped out in Table 8-4 above reveals the case companies differ from the companies participating in the pilot studies, as only one example of a ‘Silo’ process is identified (‘Customer Service’ at Novozymes). Furthermore it becomes apparent that companies categorized as process oriented all have examples of processes from the ‘SCM’ category. Not even the three companies (Fritz Hansen, LINAK, and Oticon) perceived as partially process oriented have silo processes, but have their processes categorized as either ‘Manufacturing’ (the LEAN companies Fritz Hansen and LINAK) or ‘SCM’ (Oticon).

Even if all companies undoubtedly perform planning and forecasting of various kinds only three companies (Bang & Olufsen, Coloplast, and Novozymes) mention this activity in relation to processes. At Bang & Olufsen the planning takes two forms: Demand Planning and Production Planning. The latter is perceived as a strictly operational activity, and the process is therefore placed in the ‘Manufacturing’ class. Demand Planning at Bang & Olufsen is placed in the same class as ‘Demand Planning’ at Coloplast and ‘SC Planning’ at Novozymes: the ‘Business Process’ class. As a concluding comment it should be mentioned that placing the planning activity/process in the management apex of the conceptual process framework (see e.g. Figure 2-9) was considered, thereby strengthening the explanations offered in this area. But as described above it was decided to perceive the planning activity/process as part of the process framework itself.

Process Communication

Another aspect is the extent to which the processes have been communicated. In Bang & Olufsen, for instance, the SCM Concept is explained in terms of process, replacing formal organization with (knowledge of) processes. Within most of the case companies the processes are communicated internally enabling the creation of a process mentality – primarily within Purchasing and Logistics/SCM. But two companies stand out: Oticon (due to their slightly confusing organizational structure) and SDC DANDISC who claim not having processes internally but communicate the manufacturing process on their website (see www.sdc-group.dk and Figure 7-30). In the former case it is somewhat unclear how exactly communication within the company is organized; in the latter the interviewees clearly contradict the information published⁹. In any case communicating the process design (including de-coupling points, interfaces, decision points etc.) enables suppliers and customers to better interact with the company reaping benefits of optimization.

⁹ Again the tight internal integration necessitated by the critically short lead times imposed by major customers lead to a somewhat counter-intuitive constellation of constructs. The “nature” of this company is different from the other more traditional manufacturing companies.

8.1.3 Construct ‘Production Philosophy’

Adapting the processes to accommodate the customers is focal to SCM as is having the appropriate variety of products for the customers to choose from, a delivery system which ensures precision, and acceptable lead times. The traditional solution was to stock-keep the entire product portfolio, but as customer requirements are getting more and more diversified stock keeping is no longer an option as it would tie up too much capital. The production philosophy therefore should answer the question of how to produce, how to stock, and how to make sure lead times are acceptable to the customers. Certain production philosophies are thereby perceived as “less SCM” than others. Mass Production, for instance, is perceived as a strictly Push-type technology whereas e.g. Just-In-Time is perceived as “true” SCM, as it is a Pull-type production philosophy putting the customer in center.

Production Philosophy versus Supply Chain

As described in Chapter 8.1 several of the companies operate more than one supply chain. Intuitively one might perceive a production philosophy as describing the operation at a (one) entity thereby implying either: 1. a company’s supply chains are each associated or linked to distinct entities (plants or parts of plants), or 2. an entity can only have one production philosophy in place. Both imply that the portion of a supply chain being managed by a company can not be mixed, but this is obviously incorrect, as this would invalidate e.g. production postponement¹⁰. Therefore production philosophies and supply chains are both part of the design, even if supply chains might be a more illusive concept to define and describe¹¹. The case companies illustrate a number of combinations of supply chains and production philosophies:

- SDC DANDISC describe the simplest combination of production philosophy and supply chains as only one supply chain and one production philosophy (Pull / Make-to-order) is identified. It should be noted, though, that SDC DANDISC tries to implement logistical postponement for the back-catalogue items, but so far with little success.
- At Coloplast also only one supply chain could be identified – ranging from first tier suppliers to the sales companies. But as the warehousing project proceeds it is the ambition of the company to implement make-to-order production for the largest wholesalers. Coloplast will thereby introduce another philosophy, probably using the inventory as a leveling device for the production against wholesalers’ orders. Currently no make-to-order production is taking place.
- Fritz Hansen is quite similar to SDC DANDISC, but due to the two distribution solutions in place (domestic/export), two almost identical supply chains have been identified both using/supporting the LEAN Manufacturing production philosophy.

¹⁰ Implementing production postponement will decrease the overall level of inventory as Finished Goods Inventory will disappear (or be grossly diminished). This is done by decoupling the production process into a Push and a Pull part, the former generating WIP inventory to balance lead time with inventory (and production) cost.

¹¹ Further complicating the issue, it must be recognized that production philosophy might be a criteria used when mapping and analyzing the supply chain(s) within a company.

Furthermore a supply chain for the production and delivery of expensive, wooden designer furniture is identified, based on crafts-based production. Except for the (now internationally synchronized¹²) introduction of new products all production is performed against customer orders.

- Also having implemented LEAN, albeit in a somewhat more complex manner, LINA K is slowly moving towards production against customer orders only. In the past almost all OEM customers had their own products designed, produced, and keeping stock at the most convenient LINA K sales company. This practice is slowly being altered as LINA K aims to enhance its LEAN Manufacturing principles by insisting on more modular products (thereby making production postponement a real option, not only at the most basic component level). One of the current challenges to the LEAN principles is the size of orders, which make production resemble Mass Production.
- The setup at RIEGENS is a bit more complex from a SCM perspective as two of three supply chains (standard cabinets and portfolio items) share production philosophy and the third supply chain is based on make-to-order (crafts-based) production of unique items.

From the description above it should be evident the combination of supply chain and production philosophy is less than straight-forward. Even in this small sample of companies few similarities are identified as a wide range of contextual variables result in differences in the motivation for the production philosophies in place. Furthermore the above mentioned examples illustrate how the definition (or perception) of the supply chains and/or scope for SCM at the company has an impact on the analysis. Including the suppliers in the analysis of e.g. LINA K and Fritz Hansen will demonstrate the extent of the LEAN principles by illustrating the de-coupling (by means of either long-term capacity commitments or inventory) between the companies in the supply chain.

Looking for Push and Pull

Analyzing the case companies for components of Push and Pull (or rather: looking for the de-coupling) within the SCM scope in each company might reveal insights into the choice of production philosophies. Or in other words: perhaps decoupling the production within the company is the “natural” or “popular” choice of the companies using SCM as opposed to the traditional manufacturing firms?

The initial step in the analysis is to focus on the companies having either Push or Pull philosophies implemented as it does not require the inclusion of the entity supply chain in the analysis. Only two companies fall in the ‘Push Only’ category, namely Coloplast¹³ and

¹² As mentioned in the case study introduction of new products internationally is performed twice a year. To support the marketing in the high number of outlets and showrooms across the world, bulk orders are placed to ensure availability in the early market.

¹³ Classifying Coloplast as a ‘Push Only’ may surprise some as Coloplast in Logistics circles in Denmark is renowned for e.g. their Closed Loop Distribution. Dissecting this concept reveals a centralized inventory replenished through annual forecasts with periodic adjustments. Only at sales company level does the

Dyrup. The two companies seem quite similar (they have the same characteristics, see Table 6-9), and both perceive themselves as performing SCM. The evaluation presented in Table 8-1 concurs, even if Dyrup is only partly formalized (organizational changes are presently under way) in their implementation of SCM. Quite paradoxically both ‘Push Only’ companies are ‘SCM companies’.

Identifying the ‘Pull Only’ category companies does not add clarity. Again only two companies are identified: Fritz Hansen and SDC DANDISC. The former is broadly recognized within the SCM domain as a frontrunner, the latter is an almost unknown producer in a niche market, itself denying working with SCM. Of the four companies categorized according to Push / Pull components so far, only one (Fritz Hansen) seems to fit expectation.

The six remaining companies have both Push and Pull components in their production philosophies. Table 8-5 below contains a summary of the knowledge on production philosophies in the case companies.

Table 8-5: Summary of ‘Production Philosophy’

Company	Production Philosophy	Push	Pull
Bang & Olufsen	Mixed: The majority of products are produced against forecasts. These products may be postponed (production postponement) supporting a wide array of variants of each product. Expensive/special products are produced to order.	Yes	Yes
Brüel & Kjør	Mixed: Projects are performed in cooperation with the customers, whereas standard products are produced against forecast/inventory levels/firmed orders.	Yes	Yes
Coloplast	Batch production – against forecasts only. Plans for production against orders for large customers/wholesalers are under way.	Yes	No
Dyrup	Almost solely batch production – against forecasts and inventory levels. Dyrup on very rare occasions may produce a special product for a customer, if the customer is important enough for the company.	Yes	(No)
Fritz Hansen	LEAN for standard products (and crafts based production of the expensive wood products).	No	Yes
LINAK	Primarily production against firmed orders (LEAN). Previously the company produced a broad portfolio of customer designed actuators. This practice is slowly being altered.	Yes	Yes
Novozymes	Bulk production against forecasts created at SCO. Production of end-products mostly against forecasts, but production against orders is an ambition.	Yes	Yes
Oticon	Production against forecasts and inventory levels.	Yes	Yes
RIEGENS	Mixed: standard (low cost) overhead cabinet are produced against firmed orders, projects are naturally made-to-order, whereas portfolio products are produced against forecast/inventory level.	Yes	Yes
SDC DANDISC	Pull – very short lead times. Tries to market logistical postponement in the form of forward production and inventorying of customers products.	(No)	Yes

concept look like a Pull system as local inventory may be quite low (as it is being replenished from the central inventory).

Occasional Transactions versus Ongoing Business

Drawing on one of the conclusions from Chapter 5 – that SCM is really only applicable in relation to recurrent (as opposed to occasional) transactions it seems evident the projects needs to be separated from the rest when evaluating Push and Pull activities¹⁴.

Since the methodology applied when mapping the supply chains used frequency of transaction as a distinction (see Chapter Seven) “project” type supply chains are described separate from the “recurrent transactions” type supply chains for each company. Exclusion of “project type” supply chains is thereby quite straight forward. The subsequent repetition of the above documented evaluation of the supply chains result in a somewhat more detailed view of the production philosophies, see Table 8-6 below.

Table 8-6: Production Philosophies for Recurrent Transactions

Company	Supply Chain(s) Excluded?	Push	Pull	Internal Decoupling
Bang & Olufsen	No	Yes	Yes	Popular products only
Brüel & Kjær	Yes	Yes	No	No
Coloplast	No	Yes	No	No
Dyrup	No	Yes	No	No
Fritz Hansen	No	No	Yes	No
LINAK	No	Yes	Yes	Feeder Units/Component Mfg. versus Assembly
Novozymes	No	Yes	Yes	Splits Bulk Production and Mixing
Oticon	No	Yes	Yes	Brands and Color of the Shell
RIEGENS	Yes	Yes	No	No
SDC DANDISC	No	(No)	Yes	No

Excluding the occasional transactions (the projects) from the analysis of Push / Pull results in two companies (Brüel & Kjær and RIEGENS) falling into the “Push Only” category. For these two companies the Pull orientation only related to projects which in both cases represent a substantial part of the overall business. Probably sharing capacity and equipment, and definitely sharing competences both companies have two sets of business models “built in”. Surprisingly, this configuration seems to be stable, even if intuitively the inherent logics (revenue generation, time allocation, scheduling etc.) conflict.

A consequence of the new analysis is that the group of ‘Push Only’ companies now consists of two ‘SCM companies’ and two ‘non-SCM’. In this sample the implementation of SCM apparently does not correlate with the Push / Pull dichotomy. An analysis of the group of companies having both Push and Pull might shed some insights.

¹⁴ Projects are different from standard operations in many ways. In relation to Push / Pull perhaps the most obvious difference is the scheduling paradigm in use: for projects scheduling is performed by calculating backwards from a deadline, whereas standard operations are scheduled to minimize lead time variations. For more on scheduling, see e.g. Slack, Chambers, & Johnston (2004).

Investigating Decoupling

For the remaining four companies having both Pull and Push decoupling must be performed internally within the company¹⁵. Looking closer at the four companies reveals the rationales for the internal decoupling vary greatly:

- At Bang & Olufsen decoupling is performed as semi-finished products are produced to inventory, postponing e.g. choice of color. For a few products (e.g. telephones) this customization is pushed all the way into the B1 stores, but Bang & Olufsen prefer the customization to be performed as part of a standard process under strict quality control.
- The LEAN setup at LINAK has the decoupling built in as they use “supermarkets” with purchased as well as produced items at various component levels. In contrast, Fritz Hansen purchases all items and thereby does not decouple in any way but simply has to manage their “supermarket” inventory.
- At Novozymes the decoupling takes place in the interface between the bulk production (not using SCM) and the mixing and distribution operation (called SCO). Novozymes thereby illustrate an interesting case where the choice of scope for the SCM organization apparently was influenced by the production philosophy?
- Finally, at Oticon decoupling is performed to obtain economies of scale in the production of the electronics, postponing the branding of the finished product and the encapsulation in the shell (choice of color).

Choice of decoupling point thereby illustrates diversity instead of commonality across the case companies, enhancing the argument that the implementation of SCM is very dependent on the context.

8.1.4 Construct ‘IT Support’

The increased time pressure, shortened lead times along with added complexity in production methods makes the use of IT a necessity as described previously. Evolving from stand-alone applications solving e.g. planning problems, performing network analysis, or enhancing inventory management software has been “process-enabled” as modern ERP systems cover all essential business activities.

In this context it is therefore of interest to understand how software is being used to support the smooth and efficient flow of goods in order to meet the requirements of the end-consumer. Using IT to e.g. automate the ordering process or to ensure distribution details is forwarded the end-consumer in a timely and efficient manner may increase the end-consumers’ trust in the supply chain thereby possibly leading to more revenue and better profitability. Also the use of IT might provide more features to the end-consumer, like Online Customization of the product or track-and-trace functionality allowing the customer (and shipper) to monitor the movement of goods from source to destination.

¹⁵ Determining whether or not decoupling takes place in the interface between the companies requires a more thorough analysis of customer and suppliers.

IT offerings

Besides offering predictability and more functionality to the customer, IT also supports the operation itself. All modern software packages (ERP systems) distinguish themselves from the traditional stand-alone applications by offering a higher degree of integration between modules, thereby e.g. allowing Operations to faster recognize changes in demand or Finance to continuously monitor costs in production. Where “old-fashioned” applications are characterized by periodic cross-module batch updating (if at all) modern applications update all relevant modules online, and keep document trails of all transactions.

Table 8-7: Summary of ‘IT Support’

Company	IT Support	ERP
Bang & Olufsen	The company implemented SAP some years ago – and stand-alone systems have been shut down ever since as more and more functionality is transferred to the SAP platform. The BI stores are supported by a web application called ROS (Retail Ordering System), whereas suppliers might be integrated by means of EDI. A web-based application for the suppliers is being implemented to support the coming implementation of VMI.	Yes
Brüel & Kjær	At Brüel & Kjær the IT support is done by various applications: Oracle for core operations and Siebel in decentralized implementations at the sales companies. Information on customers is transmitted from the Siebel applications to the central systems, and orders are transmitted as well. Neither suppliers nor customers are supported by IT, but an implementation of EDI is under way.	Yes
Coloplast	The core system is an ERP system called Enterprise OneWorld ¹⁶ . Furthermore the company uses Lotus Notes for various applications. As a large portion of the required input is supplied by means of VMI, the suppliers have access to the inventory levels of their designated items through a web application.	Yes
Dyrup	An old, outdated system which is in dire need of replacement. On top of the core system a reporting application collects and reports on various KPI's (all plants).	No
Fritz Hansen	Internal operations are supported by a customized implementation of MOVEX, and a “home grown” application gives suppliers and customers access to relevant information.	Yes
LINAK	The ERP system AXAPTA support production, planning, order management, finance etc.	Yes
Novozymes	Bulk production as well as order management, planning, and distribution is supported by a SAP system. The SAP system is modified to ease external IT integration, with both SAP and non-SAP systems. Customers may use the “Customer Centre” to track and trace their orders.	Yes
Oticon	A few years ago an ERP system (MSGPRO) was implemented. EDI documents are exchanged with the majority of suppliers. Furthermore a web application enables customers top place orders, which are subsequently transferred to the core system and converted by means of VIDELITY software.	Yes
RIEGENS	Production and planning is supported by LIMES, an old system developed and maintained by a software house in Copenhagen. The system does support the exchange of EDI documents. The operation in Braintree (UK) uses a modified version of Baan, called the “MK System”. The switch-over to the LIMES system is planned for 2006. Administrative functions, product development and internal communications are done in a customized Lotus Notes application.	No
SDC DANDISC	Production planning and control as well as master data maintenance and invoicing are performed in a small semi-integrated system. The inventory management for the postponement solution is performed in an identical albeit separate installation. The customer front-end is supported by a web-enabled application which interfaces with the core system.	No

¹⁶ Enterprise OneWorld was first acquired by PeopleSoft which subsequently was acquired by Oracle.

And precisely this characteristic of modern ERP systems appeals to the SCM domain as this type of application helps bridge the inherent information gap existing (to a certain degree) in all complex systems. Therefore it is of relevance to understand the use of IT in order to explain e.g. organizational safe guards, types of relationships etc. Table 8-7 above summarizes the use of IT in the case companies.

ERP Systems?

As shown in the table above most companies (seven of ten) has at least one ERP system implemented. Surprisingly there seem to be no dominant system among the seven companies as only two companies use the same system (Bang & Olufsen and Novozymes both use SAP). The companies not using ERP systems are primarily small companies (RIEGENS and SDC DANDISC) but other small companies do (Fritz Hansen uses MOVEX and Oticon uses MSGPRO). At Dyrup Henrik D. Nielsen explains the absence of an ERP system by more pressing investments in the pipeline:

“We have planned to upgrade our IT systems a number of times, but each time the investment has been postponed due to its size, and due to other pressing issues requiring financing ... we are fully aware we need to address this issue...”

If this is a general tendency explaining the absence of ERP systems in the two small companies might thereby be as straight forward as a combination of turnover/PBT and ownership structure, as RIEGENS and SDC DANDISC represent the least turnover/PBT and neither are owned by investment companies.

ERP instead of Processes?

It may be postulated the use of ERP systems have removed the need to implement process-orientation in companies as the ERP system is built to support the integration of activities across functions. As most users of ERP systems have experienced the effect of transparency is enormous. Lead times and precision in performance becomes visible to other users of the system, and if included in reporting procedures becomes a highly possible target for monitoring. Furthermore it becomes increasingly difficult to “pass the bucket” to other departments participating in the process, as all transactions have full document trail.

It may therefore be hypothesized that the activities do not need to be supported by formal, cross-functional processes since each process is split into distinct activities with clear identification of roles and responsibilities, in most cases with identifiable deadlines/expected processing times.

When implementing the earliest ERP systems the organization was required to adopt a predefined set of processes, but with the revised versions of the systems the extensive use of work flow technology¹⁷ has enabled companies to differentiate their processes and to mould them to their liking. E.g. an order may trigger a work flow where step one is a check for order

¹⁷ Work flow technology is an event driven technology, where events trigger a chain of activities and decision points, coupled with communication tools and roles linked to individuals, as maintained in the application.

value. In case the value exceeds a certain value the order is passed to a manager who has to accept the order before it is processed. Alternatively if the order value is below the limit it is effectuated immediately. Linking all this information with a business reporting system (most often built into the ERP system) enables reporting on e.g. processing time, number of stock-outs, identification of the warehouse employee picking the goods, dispatch mode and time, and timing of invoicing runs.

From all this information reports may be created pinpointing problem areas as they appear.

For all these reasons, ERP systems make a difference – and companies using ERP systems may work from a different baseline than companies not having ERP systems.

Testing the Hypothesis

Testing the hypothesis is performed rather easily by combining previous results, see Table 8-8 below. Combining the findings on ERP implementation with the category ‘Process Orientation?’ as shown in Table 8-4 gives no support to the hypothesis of ERP systems acting as replacement for process-orientation. In most cases (nine of ten) process orientation and ERP implementation goes hand in hand. Only at Brüel & Kjør this is not the case, as they use Oracle and Siebel applications but have done little in terms of process orientation. Analyzing at this level thereby does not support the hypothesis.

Table 8-8: SCM, Process Orientation, and ERP¹⁸

Company	SCM?	Formal SCM	Process Orientation?	Process Type(s)				ERP
				Bus	Man	SCM	Silo	
Bang & Olufsen	Yes	No	Yes	Yes	Yes	Yes		Yes
Brüel & Kjør	No	No	No	N/A	N/A	N/A	N/A	Yes
Coloplast	Yes	Yes	Yes	Yes		Yes	Yes	Yes
Dyrup	Yes	(Yes)	No	N/A	N/A	N/A	N/A	No
Fritz Hansen	Yes	Yes	(Yes)		Yes?			Yes
LINAK	Yes	No	(Yes)		Yes?			Yes
Novozymes	Yes	Yes	Yes	Yes		Yes	Yes	Yes
Oticon	Yes	No	(Yes)			Yes?		Yes
RIEGENS	No	No	No	N/A	N/A	N/A	N/A	No
SDC DANDISC	No	No	No	N/A	N/A	N/A	N/A	No

But taking a closer look at the process types identified at each case company reveals a possible correlation between working with SCM, process types, and the use of ERP systems.

ERP as a Prerequisite for SCM?

Analyzing the six companies having process orientation reveals all these companies have process types ‘Manufacturing’ and/or ‘SCM’¹⁹, and they have all implemented ERP systems. The correlation between SCM, process orientation, and the use of ERP systems might thereby be the following: ERP systems are required in order to manage the complexity of (tightly)

¹⁸ Columns ‘SCM?’ and ‘Formal SCM’ are from Table 8-1, columns ‘Process Orientation?’ and ‘Process Type’ are from Table 8-4. Finally, the column ‘ERP’ is taken from Table 8-7.

¹⁹ Using the process type in the analysis is important as ‘Business Process’ might be perceived as a strictly strategic entity and ‘Silo’ is simply a redressing of typical functionally isolated activities.

integrated processes in the inter-organizational system (SCM). Whether this is the case or not can not be determined here, but certain evidence exists, Steen B. Jørgensen comments:

“It does not make sense to talk about SCM without the use of IT systems. The system [SAP] we have in place support our processes and make sure we coordinate activities across the internal supply chain. ... This includes production, assembly, and distribution as well as planning and forecasting.”

At LINAK Morten S. Raahede concurs:

“We really depend on our IT system to make the LEAN Manufacturing work. ... It glues together the concept; it would make no sense to go back to the old [stand-alone] systems.”

At Oticon the relation between the organization structure and the ERP system is somewhat less straightforward. But the importance of the ERP system as a tool to achieve the strategic goals of the company is similar to the other two companies, Marianne B. Korsholm comments:

“We rely heavily on our integrated system as it holds all information on suppliers, customer and products. ... Without the [IT] system we would not be able to operate in the way we do today, it actually supports our teams quite well.”

The use of IT internally within each company thereby seems quite important in relation to SCM, but it seems relevant to also analyze the use of IT in the interface between companies.

IT in the Up- and Downstream Interfaces

As described in Table 8-7 above most companies use IT to support the interface to customer and suppliers. The functionality vary a lot, though, as some companies offer functionality to suppliers and customers both (e.g. Oticon), and others do not integrate outside the extended company (e.g. LINAK). The type of functionality also varies, from the receiver driven (e.g. Track and Trace functionality) to the interacting (e.g. exchange of EDI documents or other types of integration of systems).

Classes of Functionality

Three classes of functionality are recognized in the empirical data:

- Static – making information available on a “self-service” basis.
- Push – making information available, and forwards it to the relevant party.
- Interaction – functionality enabling interaction between parties.²⁰

In terms of integration the three categories are quite different. The first category describes the manual interface where employees in the one party must manually look for the published information. The second category enables a level of automation as information is created for a distinct receiver and forwarded automatically. In the last category feedback is guaranteed as the systems are integrated.

²⁰ The typology Static/Push/Interaction is a further development of a dichotomy presented in previous work on website functionality (Sørensen & Holst, 2003).

Table 8-9: IT Support for Interfaces

Company	IT Offering	Up/Down	Type
	A web-based application is being implemented to support the coming implementation of VMI.	Up	Static
Bang & Olufsen	Suppliers' systems are integrated with Bang & Olufsen's systems, and forecasts and plans are shared.	Up	Dynamic
	B1 stores use the web application Retail Ordering System (ROS) for placing and tracking customer orders.	Down*	Dynamic
Brüel & Kjær	EDI is being implemented with two of the suppliers.	Up	Dynamic
	Siebel is used for CRM and Order Management in the sales companies. Integrates with the core system (Oracle).	Down*	Dynamic
Coloplast	As a large portion of the required input is supplied by means of VMI, the suppliers have access to the inventory levels of their designated items through a web application.	Up	Static
	Whenever the inventory level drops below the agreed level an e-mail notification is sent to the designated supplier.	Up	Push
	Sales companies are integrated into the core system, Enterprise OneWorld.	Down*	Dynamic
Dyrup	An application collects sales and production data from all production units and sales companies and enables reporting and evaluation.	Down*	Static
Fritz Hansen	Suppliers have access to inventory levels and outstanding orders, as well as their performance evaluations through a web-enabled application.	Up	Static
	Track and Trace – through a web-enabled application.	Down	Static
LINAK	Integration with US Production and sales companies.	Down*	Dynamic
	Forecasts shared with Bulk Production through the SAP system.	Up*	Dynamic
	Plants abroad are integrated in the SAP environment.		
Novozymes	Overall (aggregated) production planning is performed centrally.	Down*	Dynamic
	Customers may integrate their systems with Novozymes' SAP system and have orders etc. updated "automatically".	Down	Dynamic
	The "Customer Centre" enables Track and Trace.	Down	Static
Oticon	EDI supporting VMI with the twelve largest suppliers (approx. 80% of total volume).	Up	Dynamic
	A web application enables customers to place orders.	Down	Dynamic
RIEGENS	EDI with two suppliers.	Up	Dynamic
SDC DANDISC	Web-enabled application for managing inputs and orders from customers.	Down	Dynamic

Analyzing the case companies according to this typology reveals that the Push category is quite rare (only identified at Coloplast). The Static category is identified six times (at five different companies) whereas Dynamic is identified thirteen times (at eight companies). This would imply a close integration with external parties if not for one thing: in six of the identified instances the external party belongs to the company (is owned fully or partly). Focusing on the focal company (typically the HQ) and thereby investigating the interface between HQ and subsidiaries instead of analyzing the entire "company network" and the interface to the outer network probably results in a distorted picture. Excluding the "within ownership" interfaces and repeating the analysis quickly confirms this hypothesis of less integration with "true" external parties: one Push, five Static, and only seven Dynamic. Within ownership IT integration is tighter. Findings on IT support of interfaces are listed in Table 8-9 above ("within ownership" interfaces are marked '*').

Coupling of IT Systems

The IT support of external parties is less sophisticated than might be expected, especially if the “within ownership” interfaces are excluded. Analyzing the ten case companies to identify the coupled IT systems (enabling the seamless supply chain) results in Table 8-10. As shown below most (six) of the cases are undetermined as information on the relevant interface is unavailable (for the reasons described above). Among the remaining four companies only (Oticon) has coupled IT systems both up- and downstream. The other three other operate an “IT-broken” supply chain.

Table 8-10: Coupling of IT Systems

Company	Upstream	Downstream	Two-Directional IT Coupling
Bang & Olufsen	Coupled	Coupled*	Yes*
Brüel & Kjør	Coupled	Coupled*	Yes*
Coloplast	Decoupled (Push)	Coupled*	No
Dyrup	Decoupled	Decoupled*	No
Fritz Hansen	Decoupled	Decoupled	No
LINAK	Decoupled	Coupled*	No
Novozymes	Coupled*	Coupled	Yes*
Oticon	Coupled	Coupled	Yes
RIEGENS	Coupled	Decoupled	No
SDC DANDISC	Decoupled	Coupled	No

8.1.5 Construct ‘External Integration’

Besides IT integration, companies in supply chains can be integrated in various ways e.g. process and social integration (e.g. Bagchi & Skjøtt-Larsen, 2002a; Bagchi et al., 2005). Especially the latter type of integration is often explained by length of relationship.

Length of Relationship

As referenced in Chapter 1 the length of relationship might in itself not represent an explanation as apparently most (all?) companies have long-term relationships with customers and suppliers. But similarly to the description above of the use of ERP systems, long relationships might be a pre-requisite for close cooperation.

Table 8-11 below describes how long-term relationships dominate the relationship map. Especially upstream this is the case - with only few exceptions: Novozymes and SDC DANDISC. In both cases the companies purchase input of the lowest level of sophistication possible and therefore treat their trivial suppliers as players in a (perfect) market:

“Almost all our inputs are very basic agricultural products which are bought on market-like terms. There is no value in entering into partnerships with these suppliers as no advantages can be reaped. ... At some stage the agricultural sector might decide to produce more specialized products but so far the supply of generic products is sufficient.” (Ken Friis, Novozymes)

At SDC DANDISC the considerations are similar:

“The few types of input we require are all supplied by a number of large suppliers – and in a generic quality. We might choose to use a more specialized granulate, for instance, but then we would depend on that supplier.”

... So far, we have chosen to stay as independent as possible thereby enabling price competition – which is critically necessary due to the low contribution margin in our industry.” (Henrik Frandsen, SDC DANDISC)

At Coloplast they have long-term relationships with most suppliers, but would like to have a more balanced approach:

“A small group of our supplier have a misperception of their value-adding – they are really capacity suppliers but expect to be treated as competence suppliers. ... We really should improve our supplier evaluation process – currently it may take as much as 1-1½ years to replace a supplier. ... The way we manage each supplier should match the value-adding.” (Roland V. Pedersen, Coloplast)

Besides these exceptions all companies use capacity suppliers for non-vital input.

Table 8-11: Summary of ‘Relationship Length’

Company	Upstream	Downstream
Bang & Olufsen ²¹	Primarily long-term relationships.	Local dealers are being replaced by B1 stores (franchisees), and Store-in-Store concepts. Master Dealers in Asia are relatively new, focus on contracts.
Brüel & Kjær	Primarily long-term relationships.	Long-term for standard components. Repeat sales to project partners. Shared outlets with ENDEVCO are being dismantled.
Coloplast	Primarily long-term relationships. Desire for more market orientation.	Long-term relationships with institutional customers. Others: mixed.
Dyrup	Primarily long-term relationships.	Long-term relationships with industrial customers. Others: mixed.
Fritz Hansen	Primarily long-term relationships.	Long-term relationships with partners. Few institutional customers (hotels etc.).
LINAK	Long-term relationships.	Long-term relationships.
Novozymes	Market orientation for most inputs (agricultural products)	Long-term relationships. Novozymes aids in improving customers’ production.
Oticon	Long-term relationships.	Access to market obtained through purchase of outlet chains. Others: mixed.
RIEGENS	Long-term relationships.	Long-term with dominant customers. Ongoing contact with key players in the project market.
SDC DANDISC	Long history but no close integration. Contracts are renegotiated every quarter. Relationship with equipment suppliers.	The dominant customer was lost during the research project. Others are mixed.

Downstream Relationships

On the downstream side, the length of relationship displays a higher degree of variation. This may be due to the type of customer (B2B versus B2C), the ownership structure (independent customers versus co-owned distributors versus fully owned sales companies) or it may be due to the conditions under which the multiplicity of distributions channels operate.

For a few of the companies the dominance of individual customers seems to have posed a problem, as illustrated in e.g. RIEGENS and SDC DANDISC. In the case of RIEGENS the

²¹ The diversified businesses are not included in the analysis – as mentioned previously.

dominant customer is retained but the dominance is reduced whereas at SDC DANDISC the customer was lost (possibly resulting in accepting the proposed merger with DCM).

Also at Bang & Olufsen the relationships downstream are altered as independent, local dealers are being replaced by franchisees and store-in-store concepts. At Oticon attempts at penetrate local markets are made through the purchase of existing chains (hearing clinics).

The current trend towards project sales also seem to have an influence on the downstream relationships, as “project facilitators” are becoming increasingly important for many companies. At Brüel & Kjær and RIEGENS keeping in touch with this type of external partners is quite important.

CPFR

In order to determine the level of CPFR three dimensions are evaluated for each case company (see Table 6-2). The first category ‘Information Sharing’ is derived from the information in Table 8-9 whereas the latter two are based on evaluations of the case material. The evaluation is split in up- and downstream as the level of CPFR might differ.

As shown in Table 8-12 below the majority of companies have either periodic or continual information sharing both up- and downstream. This should come as no surprise as Table 8-9 documents the availability of static and dynamic functionality in the interfaces in both directions. Evaluating the coordination is somewhat more challenging as coordination mechanisms are embedded in the business practices up- and downstream and not readily observable. When evaluating each case company for coordination mechanisms the researcher looked for e.g. periodic meeting, evaluations, cross-placement of employees and joint activities such as collaborative planning or other types of ongoing contact at the operational level. Interestingly it appears coordination is dependent on orientation as eight case companies do not coordinate with customers whereas all coordinate (at some level) with suppliers. Only LINAK and Novozymes coordinate downstream. Also the last of the three dimensions show diversity across the case companies. For the majority (six) of the companies no alternative goals are identified but for the remaining four companies two alternative goals are identified: ‘Access to outsourced technology’ and ‘Product development’. As documented in the case reports both Bang & Olufsen and Brüel & Kjær are highly dependent on their suppliers to sustain a competitive advantage in their market as a direct consequence of the “forced” outsourcing of their core competencies. Both these companies have ended up in a “diseconomy of innovation” – the situation where a critically important technology is outsourced due to increasing cost of maintaining an adequate level of competence and rate of development. Both companies therefore try to remain attractive customers to these critically important suppliers.

Table 8-12: Summary of ‘Collaboration’

Company		Information Sharing ²²	Coordination	Alternative Goals	CPFR Level
Bang & Olufsen	Up	Continual	Continual	Access to outsourced technology	Advanced
	Down	Continual*	None	None	None
Brüel & Kjær	Up	Continual	Continual	Access to outsourced technology	Advanced
	Down	Periodic	None	Product development	Basic (projects)
Coloplast	Up	(Continual)	Periodic	None	Basic
	Down	Continual*	None	None	None
Dyrup	Up	No	Periodic	None	None
	Down	(Periodic)	None	None	None
Fritz Hansen	Up	(Continual)	Continual	None	Basic
	Down	No	None	None	None
LINA K	Up	No	Periodic	None	None
	Down	Continual*	Periodic	None	Basic
Novozymes	Up	Periodic*	(Periodic)	None	Basic ²³
	Down	Continual	Periodic	Product development	Basic
Oticon	Up	Continual	Continual	Product development	Advanced
	Down	Continual	No	None	None
RIEGENS	Up	Continual	Periodic	None	Basic
	Down	Periodic	None	Product development	Basic (projects)
SDC DANDISC	Up	No	Periodic	None	None
	Down	Continual	No	None	None

Combining these three dimensions lead to the result presented in the table above: two companies does not collaborate at all, three companies have advanced CPFR with either up- or downstream partners and the rest cooperate at a moderate level either up- or downstream (or both). Interestingly two of the companies (Brüel & Kjær and RIEGENS) develop products in collaboration with customers in a separate supply chain (customer projects) whereas Oticon cooperate with suppliers and Novozymes develop new products (enzymes/mixes) as part of the strategy to lock-in customers. In a sense both Novozymes and Oticon encapsulates the product development within their “normal operation” whereas products developed with customers at Brüel & Kjær and RIEGENS must be “transferred” or redesigned to fit within the existing product portfolio.

8.1.6 Construct ‘Inter-organizational Management’

The ideal of inter-organizational management extending beyond the individual company is central to the concept of SCM. Therefore each interviewee was queried for whether or not their company takes part in inter-organizational management. None of the interviewees initially responded positively to the question but in most cases the question triggered quite interesting discussions on what management is, and then on what management might look like across the supply chain. Table 8-13 below contains a brief summary on inter-organizational management for all case companies.

²² The mark (*) denotes “within ownership” as in Table 8-9.

²³ Coordination with suppliers of agricultural products is absent (perfect market?).

Table 8-13: Summary of ‘Inter-organizational Management’

Company	Inter-org. Mgmt. ?	Management Practice
Bang & Olufsen	No	As described the logistics management is all performed from HQ, as distribution was changed some years back. Changes developed at HQ, spread to sales companies.
Brüel & Kjør	No	Fragmented practices across product categories. Management does not extend the ownership boundary.
Coloplast	No	SCM is being centralized under a stronger management. Management of external parties does not take place. SCM “ends at” sales companies.
Dyrup	No	Only recently has Dyrup taken the initiative to centralize the management of their plants. No attempts on managing suppliers or customers exist.
Fritz Hansen	No	At Fritz Hansen the identified Supply Partners are supported by means of education and assistance in managing their own supply chains. But they are not managed as such.
LINAK	No	Inventories are reduced and portfolio reduced as postponement is being implemented. Management does not extend the network. Centralization underway. External parties are not managed in any way.
Novozymes	No	Novozymes aims at adding value to their large customers by helping them manage their inventory in an efficient way, and by assisting in altering the patterns of consumption.
Oticon	No	Sales companies are managed, of course, and close cooperation with the ITE laboratories is a necessity. Management does not extend to e.g. suppliers, albeit coordination is tight.
RIEGENS	No	Within ownership. Besides coordinating the operation in Braintree (UK) and Slovakia the company manages its external partners primarily through capacity planning. As for other companies participating in project-like activities, the management of these activities is somewhat different from the “standard” operation.
SDC DANDISC	No	Within ownership. Management does not extend outside legal boundaries of the firm. Within ownership capacity is being managed through shifting back-catalogue orders between production units.

These findings are in line with Storey et al. (2006) reporting from a study encompassing six supply chains and a total of 72 companies:

“Management of the supply chain was analogous to a relay race, with responsibility being passed from one company of actors to another...” (p. 763).

Emerging Sub-constructs

Most interviewees agreed inter-organizational management has to do with the orchestration of resources across supply chain – an issue to a certain extent covered already. It seemed a few elements of management are missing, though, namely strategizing, intervention, and learning/knowledge sharing.

In this context strategizing translates into joint or collaborative strategizing setting goals for the entire chain – and using “supply chain” as the focal entity for strategic analysis and implementation²⁴. But even if companies have not come this far strategizing collaboratively definitely demonstrates inter-organizational commitment. As for intervention, granting the “right to intervene” to another legal entity (outside of ownership) denotes a very strong trust and belief in the other company – or a very strong dependency. In both cases operational

²⁴ In Tamas (2000) it is reported how strategies in most cases do not match the goals set for the companies’ supply chains.

issues are addressed with prior negotiation potentially leading to “network management” where the most competent entity has the right to intervene. The last sub-construct is somewhat related to the former as it describes the routines in place to i.e. spread knowledge on good practices or of formal education between supply chain partners.

Collaborative Strategizing

Albeit collaborative strategizing as concept was instantly recognized all but one company immediately rejected it as current practice. At Fritz Hansen uncertainty prevailed as to whether their current developments could be perceived as collaborative strategizing:

“We rely heavily on our Supplier Partners but since we are driving the implementation of LEAN we are probably not performing collaborative strategizing. ... The initiative was ours – and we had to persuade our suppliers to participate.” (Henrik Holm, Fritz Hansen)

A few of the companies elaborated over the strategic nature of (joint) product development:

“We’re probably not doing collaborative strategizing but we rely on our major suppliers when we develop products.” (Klaus K. Knudsen, Bang & Olufsen)

and

“A very important part of our business is to develop specific solutions for our customers. This is part of our strategy. ... Our strategy is to collaborate, but the strategy is not developed collaboratively, and is separate from the goals and strategies of our customers.” (Henrik Jeppesen, Brüel & Kjær).

At other companies the interviewees elaborate over the difference between within ownership and outside ownership entities, e.g. Morten S. Raahede (LINAK):

“When talking about collaborative strategizing we have it – between HQ and the sales companies. ... But this is dramatically different from collaboration between truly independent companies. ... We do not develop strategies with suppliers or customers – but we inform suppliers of our intentions in terms of required input.”

Most companies agreed with especially the last bit of above quote – most communicate capacity forecasts in one form or the other.

Intervention

As for the second sub-construct the answers are even more homogeneous. All reply negatively to the question of intervention²⁵ – a few interviewees offer a different angle:

“Intervention is needed when quality drops below agreed thresholds. When this happens we reject the shipment and, if necessary, work with the supplier to fix the problem.” (Marianne K. Borum, Oticon)

Henrik Jeppesen (Brüel & Kjær) concurs:

²⁵ Also this finding is in line with Storey et al. (2006): “In consequence of the typically constrained scope of intervention the notion of ‘seamless end-to-end pipeline management’ was far beyond actual practice – and indeed some distance even beyond aspirations.” (pp. 765-766).

“We rely on high quality in all inputs – therefore we need thorough quality inspection of all inputs. ... In case of systematic errors we work with the supplier to solve the issue.”

Intervention as understood in relation to management of an activity is thereby absent from the case companies, whereas a collaborative approach to problem solving between focal company and supplier might be quite common, especially on projects²⁶. At Brüel & Kjær, for instance, projects are routinely led by joint management - when developing e.g. test equipment for Volvo cars staff from Brüel & Kjær and Volvo jointly defines and executes the project. At RIEGENS, working on a design project normally would mean close interaction with customer and entrepreneur – and project management might be placed at any of the three stakeholders.

Learning / Knowledge Sharing

In contrast to the first two sub-constructs, the last one splits the case companies into two groups: the companies who share knowledge or performs training programs for their supply chain partners, and the companies who do not. The companies who share knowledge do so for more than one reason. Companies like Bang & Olufsen and Brüel & Kjær do so in order to obtain access to outsourced technology whereas Oticon (and Brüel & Kjær) do so to develop better products (see Table 8-12)²⁷. Fritz Hansn has developed a complete training program on LEAN for their designated Supply Chain Partners in order to have the LEAN implementation succeed. Novozymes share their knowledge on production and the use of enzymes to help their customers optimize their production. The sharing of knowledge is thereby a multifaceted construct. Table 8-14 above summarizes the three sub-constructs.

Table 8-14: Summary of Sub-constructs for ‘Inter-org. Mgmt.’

Company	Collaborative Strategizing	Intervention	Learning / Knowledge Sharing
Bang & Olufsen	No	No	Yes
Brüel & Kjær	No	No	Yes
Coloplast	No	No	No
Dyrup	No	No	No
Fritz Hansen	No	No	Yes
LINAK	No	No	No
Novozymes	No	No	Yes
Oticon	No	No	Yes
RIEGENS	No	No	No
SDC DANDISC	No	No	No

8.1.7 Developing 2nd Level Constructs

From these elaborations a number of sub-constructs have evolved.

²⁶ As mentioned previously projects are perceived as distinctive different from supply chain. Reference may be made to Stabell & Fjeldstad (1998): projects are “value shops” whereas continuously operated supply chain are “value chains”.

²⁷ RIEGENS resembles Brüel & Kjær in terms of customer projects except for the “innovation content” – in the case of RIEGENS the innovation is primarily design. RIEGENS is thereby not considered a knowledge sharing company.

The construct ‘Supply Chain Organization’ was described by two sub-constructs: ‘Formal organization’ and ‘Match with Fulfillment Meta-process’. The evaluation of the production philosophies in place resulted in a description according to Push versus Pull and the related construct of (control over) internal decoupling. For this evaluation to make sense the “one-off” supply chain were disregarded. Describing the level of process implementation was performed by first identifying the types of processes in place (if any) and thereafter by evaluating the “range” within which these processes were communicated.

The use of integrated systems (ERP) and the level of IT systems integration described the level of IT support of the process-oriented company. External integration (besides IT integration) is described by ‘Length of Relationship’ and ‘Level of CPFR’. Finally, management of the supply chain is described in terms of ‘Collaborative Strategizing’, ‘Intervention’ in participating company’s operation, and ‘Learning/knowledge Sharing’ in the network. The resulting construct hierarchy is shown in Table 8-15 below.

Table 8-15: The ‘Supply Chain Management Practice’ Construct

Level 0 (Result)	Level 1 (Construct)	Level 2 (Sub-construct)
Supply Chain Management Practice ←	Supply Chain Organization	← 1. Formal Organization 2. Match with Fulfillment Meta-process
	AND	
	Production Philosophy	← 1. Push / Pull 2. Decoupling
	AND	
	Process Orientation	← 1. Process Type(s) 2. Process Communication
	AND	
	IT Support	← 1. Integrated System / ERP 2. Coupling of IT Systems
AND		
	External Integration	← 1. Length of Relationship 2. Level of CPFR
	AND	
	Inter-organizational Management	← 1. Collaborative Strategizing 2. Intervention 3. Learning / Knowledge Sharing

In contrast to the first use of these construct hierarchies (see Appendix A) it became apparent the use of dichotomies in the evaluation were inadequate as a number of construct were typological in nature. A five-point Likert scale is used instead, codified specifically for each construct. Evaluation of dichotomies is done by using common values for yes (4) and no (2).

The codified constructs and the meaning of the values are shown in Table 8-16 below.

Table 8-16: Coding of 2nd Level SCM Constructs

2 nd Level SCM Construct	Coding for Value		
	1	3	5
Formal organization	None	Concept	Formal org. entity
Match with Meta-Process	None	Some coverage	Full coverage
Process Type(s)	No processes	No SCM processes	Only SCM processes
Process Communication	No communication	Within organization	Outside organization
Coupling of IT systems	No coupling	Coupling	Two-directional coupling across ownership
Length of Relationship	Only short	Long in one direction	Long in both directions
Level of CPFR ²⁸	None	Basic	Advanced

From this coding schema it is now possible to rate each second level SCM construct for each company in the study.

8.1.8 Evaluating SCM Practices

Applying above listed coding scheme to the constructs results in a collection of ratings as depicted in Table 8-17 below. Sub-constructs are rolled up into the higher level construct by simple summations.

Table 8-17: Ratings for SCM Constructs

	Bang & Olufsen	Brüel & Kjaer	Coloplast	Dyrup	Fritz Hansen	LINAK	Novozymes	Oticon	RIEGENS	SDC DANDISC
External Conditions										
Size	L	L	L	L	S	L	L	S	S	S
Input	C	C	S	S	S	S	S	C	S	S
Process	S	C	S	S	S	S	C	C	C	C
Mfg. Process	S	S	S	S	S	S	C	C	S	C
SCM Award	Y	N	Y	N	Y	Y	N	Y	N	N
Level 1 Constructs										
Level 2 Constructs										
SCM?	Y	N	Y	Y	Y	Y	Y	Y	N	N
Supply Chain Organization	8	2	9	9	10	5	8	8	2	2
1. Formal Organization	3	1	5	5	5	2	5	3	1	1
2. Match with Fulfillment Meta-process	5	1	4	4	5	3	3	5	1	1
Production Philosophy	8	4	4	4	6	6	8	8	4	6
1. Push/Pull ²⁹	4	2	2	2	4	4	4	4	2	4
2. Decoupling	4	2	2	2	2	2	4	4	2	2
Process Orientation?	Y	N	Y	N	(Y)	(Y)	Y	(Y)	N	N
Process Orientation	7	2	7	2	6	6	7	7	2	6
1. Process Type(s)	4	1	4	1	3	3	4	4	1	1
2. Process Communication	3	1	3	1	3	3	3	3?	1	5

²⁸ Points = average of up- and down-stream.

²⁹ Recurrent transactions only! Scale: 2 = no pull, 4 = pull.

Table 8-17 (cont'd)

	Bang & Olufsen	Brüel & Kjær	Coloplast	Dyrrup	Fritz Hansen	LINAK	Novozymes	Oticon	RIEGENS	SDC DANDISC
Level 1 Constructs										
Level 2 Constructs										
IT Support	8	8	6	3	5	6	8	9	5	5
1. Integrated System / ERP	4	4	4	2	4	4	4	4	2	2
2. Coupling of IT Systems	4	4	2	1	1	2	4	5	3	3
External Integration	7	8	6	5	6	7	6	7	8	5
1. Length of Relationship	4	4	4	4	4	5	3	4	5	4
2. Level of CPFR	3	4	2	1	2	2	3	3	3	1
Inter-organizational Management?	N	N	N	N	N	N	N	N	N	N
Inter-organizational Management	8	8	6	6	8	6	8	8	6	6
1. Collaborative Strategizing	2	2	2	2	2	2	2	2	2	2
2. Intervention	2	2	2	2	2	2	2	2	2	2
3. Learning/Knowledge Sharing	4	4	2	2	4	2	4	4	2	2

As each of the 1st level constructs are perceived as independent and of equal importance the rate for each 1st level construct is translated into a score between zero and one by calculating the position between the minimum and maximum score. The scores are depicted in Table 8-18 below.

Table 8-18: Scores for SCM Constructs (Level 1)

	Bang & Olufsen	Brüel & Kjær	Coloplast	Dyrrup	Fritz Hansen	LINAK	Novozymes	Oticon	RIEGENS	SDC DANDISC
External Conditions										
Size	L	L	L	L	S	L	L	S	S	S
Input	C	C	S	S	S	S	S	C	S	S
Process	S	C	S	S	S	S	C	C	C	C
Mfg. Process	S	S	S	S	S	S	C	C	S	C
SCM Award	Y	N	Y	N	Y	Y	N	Y	N	N
Level 1 Constructs										
Supply Chain Organization	0,75	0,00	0,88	0,88	1,00	0,38	0,75	0,75	0,00	0,00
Production Philosophy	1,00	0,33	0,33	0,33	0,33	0,33	1,00	1,00	0,33	0,67
Process Orientation	0,63	0,00	0,63	0,00	0,50	0,50	0,63	0,63	0,00	0,50
IT Support	0,83	0,83	0,50	0,00	0,33	0,50	0,83	1,00	0,33	0,33
External Integration	0,63	0,75	0,50	0,38	0,50	0,63	0,50	0,63	0,75	0,38
Inter-organizational Management	0,33	0,33	0,00	0,00	0,33	0,00	0,33	0,33	0,00	0,00
Total Score	0,70	0,37	0,47	0,27	0,50	0,39	0,67	0,72	0,24	0,31

As shown in the table above the scores range between 24 and 72%. The scores are split in two groups: the top consisting of Bang & Olufsen, Novozymes, and Oticon scoring approx.

70% and the rest of the group (rather evenly) distributed between 24 and 50%. In Figure 8-1 below the ‘SCM Total Score’ is mapped out against the first three (four) of the four (five) external conditions.

Figure 8-1: SCM Total Score vs. External Conditions

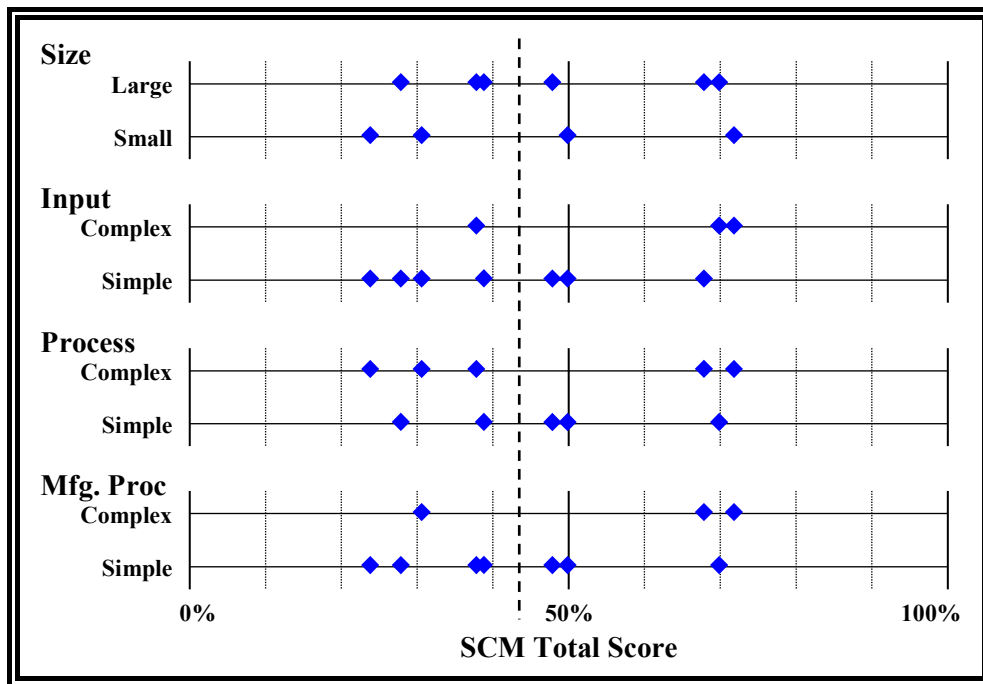

As illustrated in the figure above no clear pattern emerges. Splitting the companies at the 50% mark does not result in a clear picture of the difference between the two groups as both values in each dichotomy is represented in each of the eight sub-groups. Larger companies do not seem to be more sophisticated in terms of SCM than smaller ones, and process complexity does not seem to have an impact either.

A few indications can be found, though: companies having ‘less SCM’ tend to take simple inputs and have simple manufacturing processes. No other indications can be identified. Splitting the case companies to create to equally sized groups (indicated with the dotted line) does not result in clearer indications.³⁰

Most SCM in SCM Companies?

As mentioned in Chapter 6 half the companies in the study had won an award for their SCM practice. Mapping ‘SCM Total Score’ against ‘SCM Award’ results in Figure 8-2 below.

³⁰ As demonstrated working with complex constructs necessitates a measure for explanatory power at each level. In this context – an explanatory study with very intuitive constructs and a low number of cases – chasing this issue further is deemed futile. For more on the analyses please see Chapter I.1 in Appendix I.

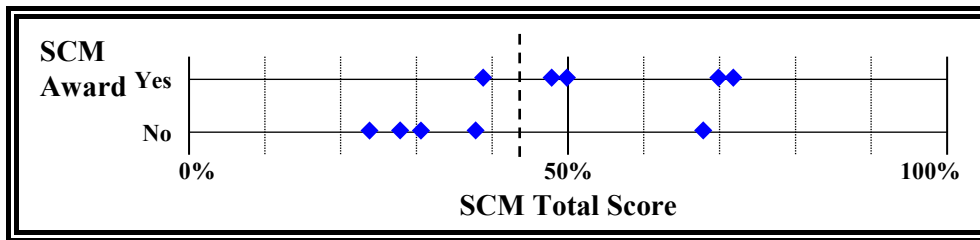
Figure 8-2: SCM Total Score vs. SCM Award

As can be seen above winning an SCM award seems to be predictive of the ‘SCM Total Score’ construct. Only one company (Novozymes) seems to break the pattern as they score high on ‘Level of SCM’ but have not won an SCM award. On the other hand, as far as the author knows, Novozymes have never entered these competitions³¹.

Level 1 Constructs vs. External Conditions

Repeating the simple descriptive statistical exercise as illustrated above on the level 1 SCM constructs results in very few additional insights: ‘IT Support’ seems to increase with complexity of ‘Process’ and ‘Production Philosophy’ (Pull and Internal Decoupling) increase with complexity of ‘Manufacturing Process’. The former insight may be described by the need for increased IT support for complex processes; the latter is quite natural (or actual: predictable) as the complexity of manufacturing process is more or less defined by the emergent sub-constructs. Quite interestingly ‘SCM Organization’ does not seem to be influenced by the company having won a SCM award or not.

Conclusion

Overall the external conditions put forward prior to the case selection seem to “predict” the identified SCM practices quite poorly. The practices themselves differ quite a lot – as illustrated in the SCM diagrams and represented in the ratings and scores above.

These findings thereby support the critics of SCM as they claim the SCM concept (and the entire empirical domain for that matter) is weakened by competing definitions. An alternative explanation is naturally that the constructs put forward does not fully reflect the practices investigated – and that better constructs and revised external conditions will improve the explanatory power. As the nature of the study performed is strictly exploratory findings are fully acceptable, though.

8.2 Evaluating SCRM Practices by Constructs

The exercise described in Chapter 8.1 is repeated for the SCRM practices.

8.2.1 Construct ‘Risk Management Organization’

Interviewing SCM and Purchasing professionals on SCRM practices within their respective domains revealed a low level of awareness of the risk management. Most of the interviewees

³¹ This is confirmed by professor Tage Skjøtt-Larsen who has participated in the evaluation of all applications.

initially stated risk management had nothing to do with their domain and that these questions should be directed to the finance department or the CEO. The only company which during the initial interviews claimed to be performing risk management within SCM and Purchasing was Bang & Olufsen:

“It has taken a couple of years to implement the current supplier segmentation model. ... The categories have worked quite well – especially the ‘level of investment’. The other category ‘degree of specificity’ translates quite well into risk exposure and by looking into the model we get a picture of the risk landscape... We now aim at quite stringently apply risk measures to the model...” (Peter S. Hune, Bang & Olufsen)

In contrast three of the companies (Oticon, RIEGENS, & SDC DANDISC) claimed not performing any kind of risk management at all (besides regulatory and financial risk management) at all. Especially the initial interview at Oticon was quite dramatic as Peter Finnerup claimed:

“We have no risk management function, because we do not need one. We have good processes instead.”

This bold statement was later retracted:

“Of course we have risk management, but it is a part of the roles and responsibilities across the company. We have no formal organization for risk management.”

Half the case companies report having neither positions nor organizational entities for risk management (except for financial risk management performed within the finance department). None of the companies report having positions within SCM or Purchasing or have positions elsewhere in the organization specifically for managing the risks relevant for SCM and/or Purchasing. Interestingly, both Coloplast and Dyrup report having a person employed to implement Risk Management but so far interviewees do not see a strong relationship between this initiative and the supply chain risks. At Brüel & Kjær it is reported that a department at holding company level performs internal audits. At Novozymes the Issues Management Committee deals with risk management in the form of e.g. customer approval and market penetration strategies. Table 8-19 below summarizes.

Table 8-19: Summary of ‘Risk Management Organization’³²

Company	Risk Mgmt?	Risk Management Organization
Bang & Olufsen	Yes	Positions exist within the staff functions ‘Legal’ and ‘Corporate Finance’. Within Operations no risk management organization or positions exist.
Brüel & Kjær	(Yes)	No formal organization within Brüel & Kjær A/S, but at holding company level a department for internal auditing exists. This department ensures procedures and policies are adhered to.
Coloplast	(Yes)	No formal organization exists, but one person in Corporate Strategy (Peter Kofoed) is working with risk management, collecting information on identified risks from all parts of the company.
Dyrup	(Yes)	Yes, one person (Anders B. Sørensen) is employed to implement risk management. The initiative has changed character from project to staff function (albeit not yet a separate unit).
Fritz Hansen	(Yes)	No formal organization for risk management exists.
LINAK	No	No formal organization for risk management exists.
Novozymes	(Yes)	Yes, one person in the Legal department works with insurance issues and product liability. Furthermore Issues Management (under Corporate Communications) defines policies and procedures.
Oticon	No	No formal organization for risk management exists.
RIEGENS	No	No formal organization for risk management exists.
SDC DANDISC	No	No formal organization for risk management exists.

8.2.2 Construct ‘Risk Types and Management Effort’

Having described the organization around risk management it will be interesting to understand if this has an effect on the types of risks being managed. A few risks seem to be quite standard: the use of single/sole suppliers and the risk of disruptions in the material flow (quantity, time and/or quality).

Single/sole Suppliers

As documented in the case studies most (seven) of the companies have to rely on sole and/or single suppliers. For some of the companies (e.g. Bang & Olufsen and Brüel & Kjær) this was triggered by outsourcing following an economic downturn. For others the reliance on single/sole suppliers is a result of the development within the supplier’s specific market. Irrespective of the explanation this dependency naturally represents a threat to the company – and none of the companies have any real possibility of insourcing the activities³³. One way of mitigating the dependency is by e.g. offering the supplier access to innovation or let the supplier “piggy-back” on a brand. In both cases these mitigation mechanisms might be short-lived and need continuous monitoring.

A few companies mention “self-inflicted” risks:

- At Bang & Olufsen the relative power of the Master Dealers is an issue. Therefore contracts are designed to manage this risk.
- At Coloplast poor documentation leads to “lock-in” of certain suppliers as an alternative is not available.

³² The ‘Risk Mgmt?’ column describes the self-perception by the interviewees, i.e. whether they believe their company performs (formal) risk management. Financial risk management is excluded from the responses.

³³ The phenomenon is coined “Diseconomies of Innovation” earlier in this manuscript.

- At Novozymes the constellation with NNSP constituted a risk factor – as documented. This issue was (partly) resolved by the detachment from Novo Nordisk.

This leaves Coloplast as the only company with unresolved structural risks of which it could be in control. Apparently this is not considered important enough to be addressed even if a cleanup and the implementation of new processes for documentation seem quite straightforward³⁴.

Disruption of the Material Flow

The other frequently mentioned risk is the risk of disruptions in the material flow. Within this category the variant most often cited is oriented towards the supply side but a number of companies mention risks oriented internally or downstream:

- At Bang & Olufsen there are concerns about delivery precision towards the B1 stores as not to disappoint the end-customers. Furthermore a concern about the credit limits for the B1 stores impacting the customer is raised.
- At Dyrup the management incentive scheme actually stresses the production setup as it generates bullwhips – without the ‘help’ of the surroundings.
- At Fritz Hansen they share Bang & Olufsen’s concerns about delivery precision – and for the same reasons. Furthermore they are concerned about the fragility of their setup – and intend to create a redundancy supply chain (including suppliers’ capacity) which can be activated quickly in case of e.g. fire or other types of damage to current facilities.
- At Novozymes and SDC DANDISC there are concerns about the production process. In the former the concern is about control of the bulk production, whereas the latter company is concerned about contamination of the replicated material – and of security breaches.

Only two risks are not addressed, both of them “self-inflicted”: the credit limits at the B1 stores at Bang & Olufsen and the management scheme in place at Dyrup. In the former case one might argue a credit limit always will have a potential detrimental effect on customer service, in the latter case there is no excuse - the company has chosen to organize in a way causing stress to the fulfillment system. Therefore only Dyrup is punished in terms of rating.

The major structure and process risks identified are presented in Table 8-20 below.

³⁴ For this reason the company receives a rating of 3 in the ‘Structure Risk’ construct.

Table 8-20: Summary of ‘Risk Types and Management Effort’

Company	Structure Risk	Process Risk
Bang & Olufsen	<ul style="list-style-type: none"> - Master Dealers must not become too powerful in their region. They are monitored closely. - The use of unique suppliers is inevitable but they must be monitored closely. Mitigated by giving access to innovations. 	<ul style="list-style-type: none"> - Delivery performance towards especially the B1 stores is a priority. - Suppliers are evaluated according to on-time deliveries. - Credit limits at B1 stores might generate poor customer satisfaction.
Brüel & Kjør ³⁵	<ul style="list-style-type: none"> - Single and sole sourcing due to outsourcing and high speed of innovation. Mitigated by giving access to innovations. 	<ul style="list-style-type: none"> - Suppliers’ delivery performance & quality.
Coloplast	<ul style="list-style-type: none"> - Single and sole sourcing due to patenting and customer preferences. - Poor product specifications leading to inertia and “lock-in” in the supply base. - Access to institutional customers. - Product quality. 	<ul style="list-style-type: none"> - Suppliers’ delivery performance & quality.
Dyrup	<ul style="list-style-type: none"> - Single and sole sourcing is inevitable due to specialization and “recipe lock-in”. 	<ul style="list-style-type: none"> - Suppliers’ delivery performance. - Forecasts quality (large customers). - Management incentive scheme.
Fritz Hansen	<ul style="list-style-type: none"> - Single sourcing & use of JIT. Tight integration and high complexity increase impact of exit. 	<ul style="list-style-type: none"> - Suppliers’ delivery performance & quality. - Resilience towards fire etc. - Own delivery performance and quality.
LINAK	<ul style="list-style-type: none"> - Replacing local with World-class suppliers. 	<ul style="list-style-type: none"> - Suppliers’ delivery performance & quality. Actively used.
Novozymes ³⁶	<ul style="list-style-type: none"> - Single sourcing. Dual sourcing is preferred but e.g. BASF is considered “safe”. - The brand is vulnerable – customers are therefore thoroughly evaluated before business relationship is established. The technology must not be compromised. - Indirect purchasing through NNSP. 	<ul style="list-style-type: none"> - Variation in own production. - Quality breach in input.
Oticon	<ul style="list-style-type: none"> - Sole sourcing. Dual sourcing is preferred but when it can not be avoided sole sourcing is countered by giving access to innovation. 	<ul style="list-style-type: none"> - Suppliers’ delivery performance & quality. Actively used.
RIEGENS	<ul style="list-style-type: none"> - The two largest suppliers are used interchangeably to avoid dependency. - The three largest customers account for 2/3 of turnover. Managed through long-term contracts and continuous contact. 	<ul style="list-style-type: none"> - Suppliers’ delivery performance & quality. Rarely used.
SDC DANDISC ³⁷	<ul style="list-style-type: none"> - The dominant customer Technicolor was lost as their sourcing was shifted to Poland. The one-year rolling contract was fulfilled by May. 	<ul style="list-style-type: none"> - Contamination of the duplicated material. The manufacturing process is enforced. - Security is strictly enforced.

³⁵ Albeit business risks are managed locally, reporting is performed in a structured process requiring the individual business units to report a status each quarter. Management of risks is performed as an integral part of general management at each level and unit.

³⁶ The major risk for Novozymes, the environment’s fear of GMO, is a market risk (does not fit the dichotomy).

³⁷ The major risk for SDC DANDISC, the timing of investments in technology, is a market risk (does not fit the dichotomy).

Formal versus Informal Risk Management

The investigation of risk management within the interviewed parts of the organizations revealed the formalization was a poor predictor for the practice. Risk management is taking place in all companies and only in few companies have risks been identified which are not managed albeit they could be. Of course the list of risks is endless – but focusing on the risk definitions in the Risk Matrix (see Figure 2-11) limits the list somewhat. It seems it is “good manners” to ensure the process risks are managed, on the structure side there seems to be a tendency to accept placing the fate of the company in the hands of suppliers (and customers).

Coordination

One last aspect of the SCRM practice needs to be addressed, the issue of coordination. As described above during the initial round of interviews almost all the companies denied performing risk management, but in the course of the interaction between researcher and research object a different understanding emerged. From rejecting the idea of risk management the companies started to “find” practices which in some way or another managed (or mitigated, insured against etc) a certain risk. It was therefore necessary to perform a “reality check” in these emerging practices.

In order to do so the interviewees were asked if their risk management practices were coordinated – between SCM/Logistics and Purchasing. If so, this would indicate a higher “level” of SCRM whereas the opposite would support the notion of the company as silo-based with separate logics, routines, and goals.

After some deliberations only four companies claimed their practices were integrated, that efforts were coordinated and perception of critical risks were aligned across SCM/Logistics and Purchasing. This naturally led to the mapping of critical risks and a comparison for each of the four companies.

Analyzing using the Risk Matrix

As shown in Appendix I the four companies are Bang & Olufsen, Coloplast, Novozymes, and SDC DANDISC³⁸. Mapping the risks by use of the Risk Matrix it quickly becomes obvious all companies might have coordinated their risk management even if they might not agree on the level of risk management applied.

At Bang & Olufsen the cell ‘Downstream Process Risks’ contains risks from both SCM/Logistics and Purchasing, at Coloplast the cells ‘Upstream Process Risks’ and ‘Upstream Structure Risks’ contain risks from both departments. At Novozymes the cells ‘Upstream Process Risks’, ‘Upstream Structure Risks’, and ‘Market Risks’ are of interest, at SDC DANDISC the cells ‘Internal Process Risk’, ‘Downstream Structure Risks’, and ‘Market Risks’ are relevant for further scrutiny.

³⁸ For SDC DANDISC only some of the interviewees claim risk management was performed and even coordinated across the company. For sake of completeness the company is included in the analysis.

Analyzing each identified cell for duplicate risk definitions across the two interview groups reveals little commonality:

- Analyzing the three downstream process risks identified at Bang & Olufsen: ‘B1 Stores depend on speedy and precise delivery’ (P2), ‘Ramp-up generates uncertainty...’ (S3), and ‘Credit limits for sales offices negatively affects customer satisfaction...’ (S4) reveals the risks are completely different – no coordination can be identified.
- The same is concluded for the upstream process risks at Coloplast: ‘Limited access to knowledge of suppliers’ (P2), ‘Quality Failure: Input’ (S1), ‘Suppliers product specifications are too poor’ (S5), and ‘Shortage of input’ (S6) whereas the upstream structure risks show a degree of commonality. The Purchasing department describes the risk of losing a critical supplier by risks ‘All eggs in one basket – reduction of supplier base’ (P1), ‘Single sourcing’ (P3), and ‘Lockin by suppliers’ (P4); SCM/Logistics use the risk ‘Loss of unique supplier’ (S3). The two departments disagree on whether this is a monitored or a non-managed risks – but none claim the risk is managed.
- At Novozymes the upstream process risks ‘Delivery precision...’ (P6) and ‘Quality breaches’ (S4) show no similarities but upstream structure risks ‘Single sourcing’ (P7) and ‘Supplier dependency’ (S1) are somewhat similar even if the former describes the practice of single sourcing and mitigation by integration (e.g. BASF) and the latter describes another strategy addressing the same problem: insisting on the use of standardized inputs. Within the last set of risks identified (‘Market Risks’) the two risks ‘GMO’ (P3) and ‘GMO’ (S3) are obviously identical.
- At SDC DANDISC the internal process risks are not similar and the market risks only have similarities through the notion of the development of new technologies.

It must therefore be concluded that the integration of risk management across SCM/Logistics and Purchasing is somewhat absent as only Novozymes seems to have a degree of coordination (the only risk they truly agree upon is the fear of their core technology becoming “unpopular” in their major markets).

8.2.3 Construct ‘Risk Identification and Assessment’

The risk management sub-processes under scrutiny are risk identification and risk assessment, as described previously.

Risk Identification

Investigating the (formal) risk identification process reveals an almost complete absence in the case companies. Only at two companies (Novozymes and RIEGENS) practices have been identified.

At RIEGENS risk management was used in conjunction with e.g. the investment in Turkey:

“I my opinion we did all the right things when we worked on the project in Turkey. We had no chance of foreseeing the downturn in the Turkish construction segment. ... We did not perform stringent risk management routines, but we talked about a lot of scenarios, and the outcome was far from the worst case scenario. ... Of course it is a shame that the project

[production in Turkey] was stopped, but that's the way it is.” (Claus Jensen, RIEGENS)³⁹

The absence of periodic risk identification is explained by the daily operations at RIEGENS being non-risky as there's redundancy for most of the inputs, and the large customers all being stable, long-term business partners.

At Novozymes apparently no formal procedures dictates how, when, or by whom risk scans should be performed but if identified risks must be forwarded the Issues Management Committee for evaluation. A number of risks are defined already, e.g. the public debate on GMO, the use of the technology for criminal or unethical ends etc. The Committee itself might perform risk identification as part of its responsibilities but unfortunately this could not be verified. At the rest of the case companies this activity apparently is not formalized (or non-existent).

Table 8-21: Summary of ‘Risk Identification and Assessment’

Company	Risk Identification	Risk Assessment
Bang & Olufsen	- None. (Perhaps at Corporate?)	- Performed periodically – on structure and process risks both (e.g. Days of Interruption).
Brüel & Kjør	- None/autonomous.	- Autonomous. Calculation of safety stock (based on time to find replacement).
Coloplast	- None. (Perhaps at Corporate?)	- None. Deviations in delivery performance and SCM costs are picked up by the KPI framework.
Dyrup	- None. (Perhaps at parent company?)	- None.
Fritz Hansen	- None.	- Evaluation of financial key figures for critical suppliers.
LINAK	- None.	- None.
Novozymes	- No formal procedures – but identified risks forwarded Issues Management Committee. - Issues Management Committee may identify risks.	- Issues Management develops guidelines for the entire company (e.g. the market / product matrix, CSR and customer evaluation) and has the authority to overrule local decision.
Oticon	- None.	- None.
RIEGENS	- Scenarios developed before investing in Turkey and UK.	- None (besides investment scenarios).
SDC DANDISC	- None. (Perhaps at Board Level?)	- The oil price is evaluated when renewing contracts for input.

Risk Assessment

Assessment of risks seems to follow quite a different pattern as the risk assessment process was identified at five of the ten case companies. The practices span from the somewhat stringent methods to the more relaxed:

- Bang & Olufsen has by far the most stringent method is in place – e.g. ‘Days of Interruption’ is used to describe vulnerability in the material flow. Somewhat less ambitious Fritz Hansen rely on financial key figures when performing periodic meeting

³⁹ More or less the same procedure was applied for the investments in UK and Eastern Europe.

with important suppliers. Even simpler SDC DANDISC forecast the oil price for the next quarter when renewing contracts for input.

- At Novozymes the risk assessment apparently is partly decoupled from the domain as the Issues Management Committee alone may determine if a new customer can be accepted. Other risks are managed locally through the use of standard guidelines.
- At Brüel & Kjær an autonomous practice of calculating the level of safety stock needed is performed aperiodically for some of the product groups.

The rest of the companies have no (formal) risk assessment process.

8.2.4 Construct ‘Supplier Risk Management’

The last top level constructs is described by two second level constructs: ‘Supplier Segmentation’ and ‘Supplier Audits’ – as described previously.

Supplier Segmentation

Quite surprisingly not all companies address the management of the suppliers by categorisation. At Novozymes and SDC DANDISC the reason is straight forward: the supply base is so limited a categorisation is not needed. This argument applies for neither Dyrup nor LINAK. At Dyrup the centralisation of the production planning might lead to segmentation due to standardisation of recipes and subsequent consolidation of purchases; at LINAK the current efforts at monitoring the supplier might similarly lead to segmentation of the supply base. The segmentation present in the remaining six companies spans a wide range from the very stringent and well defined segmentation model in place at Bang & Olufsen to the somewhat diffuse practice described at Brüel & Kjær. An overview of the supplier segmentation in place is presented in Table 8-22 below.

Table 8-22: Summary of ‘Supplier Segmentation’

Company	Supplier Segmentation
Bang & Olufsen	Yes. The model is being enhanced to address risks directly.
Brüel & Kjær	Yes. Suppliers are segmented into Strategic, Tactical, and Other. The model is updated too infrequently to add any real value.
Coloplast	The supply base is segmented into Innovative and Standard suppliers.
Dyrup	No formal segmentation model exists albeit the inputs are in very different market situations.
Fritz Hansen	Yes. Supply Partners and Others.
LINAK	No formal segmentation model exists – but one might be underway. Buffering is performed to ensure continued (LEAN) operation.
Novozymes	No formal segmentation model exists. Few sole suppliers (e.g. BASF).
Oticon	Yes. Critical, non-critical, and trivial suppliers. Procedures graduate the level of interaction.
RIEGENS	Yes. Two strategic suppliers are dealt with in a manner different from the rest. The ‘Lead Supplier’ concept might create another category. Currently division is defined by size only – procedures are not documented.
SDC DANDISC	The supply base is not segmented as suppliers are few and all long-term business partners.

Surprisingly apparently most companies do not perceive segmentation of the supply base as a priority. And at the ones who have segmentation in place the criteria used are unclear.

It seems odd so little emphasis has been placed on addressing the supply base in a stringent and methodical manner but this finding is not unique. In Zsidisin et al. (2004) a study of purchasing practices in American firms is reported and subsequently it is concluded that tools are available but apparently tradition does not dictate the use of them.

Supplier Auditing

Also the practices on performing supplier audits differ across the companies.

At Bang & Olufsen, Coloplast, Fritz Hansen and Oticon audits are performed routinely; at e.g. Brüel & Kjær supplier audits are performed as a reaction against quality problems only. A few of the companies do not perform audits at all. It seems maturity of the practices on supplier auditing more or less mirrors the practice on supplier segmentation. The practices of supplier audits are summarized in Table 8-23 below.

Table 8-23: Summary of ‘Supplier Audits’

Company	Supplier Audits.
Bang & Olufsen	Audits performed – especially with new suppliers. Suppliers’ plants audited periodically.
Brüel & Kjær	Only as reaction against continued quality problems with sole/single supplier. Happens very seldom.
Coloplast	Audits performed – especially with new suppliers. Suppliers’ plants audited periodically.
Dyrup	Audits are not performed.
Fritz Hansen	Supply Partners are audited periodically - entire operation as well as processes. Education on LEAN is made available to all Supply Partners.
LINAK	New suppliers are thoroughly evaluated – but audits are not performed.
Novozymes	Audits are not performed – at least not in any systematic fashion.
Oticon	Before accepting a new (critical) supplier an audit is performed by production and financial staff ensuring stable and competent operation and long-term survival. Financial performance of suppliers is verified periodically.
RIEGENS	Audits are not performed – not even financial overviews.
SDC DANDISC	No. Inputs are more or less standard, and are bought in bulk. A thorough evaluation is performed when purchasing new production equipment.

Supplier Management More Mature

From this rather superficial investigation it seems the purchasing practices in general are more mature than the other areas investigated within risk management. Risk management itself has little place within supplier management which seems strange but perhaps the work undertaken at Bang & Olufsen might generate a new “best practice” for other Danish manufacturing companies to aim for?

8.2.5 Developing 2nd Level Constructs

The construct ‘Risk Management Organization’ evolved into two sub-constructs: ‘Formal organization’ and ‘Risk Management Positions’ whereas the construct ‘Management of Risks’ (quite predictably) reference the two risk types in the Risk Matrix: Structure Risk and Process Risk. Furthermore the level of coordination between the two functional areas SCM/Logistics and Purchasing is investigated. The next construct covers the sub-processes risk identification and risk assessment thereby “going full circle” on the generic risk management model depicted in Figure 2-4 (except for risk monitoring). The last construct, ‘Supplier Risk

Management’ gives more detail on the management of the upstream risks by describing the formal segmentation of the supply base and the practices on supplier audits.

The resulting construct hierarchy is shown in Table 8-24 below.

Table 8-24: The ‘Supply Chain Risk Management’ Construct

Level 0 (Result)	Level 1 (Construct)	Level 2 (Sub-construct)
Supply Chain Risk Management Practice ←	Risk Management Organization AND	← 1. Formal Organization 2. Risk Management Positions
	Risk Types and Management Efforts AND	← 1. Structure Risks 2. Process Risks 3. Coordination of Risks
	Risk Identification and Assessment AND	← 1. Risk Identification 2. Risk Assessment
	Supplier Risk Management	← 1. Supplier Segmentation 2. Supplier Auditing

Similarly to the SCM constructs each second level construct is codified, see Table 8-25 below.

Table 8-25: Coding of 2nd Level SCRM Constructs

2 nd Level SCRM Construct	Coding for Value		
	1	3	5
Formal Organization	None	Part of Staff Function	Separate Entity
Risk Management Positions	None	Business Risk Management	Supply Chain Risk Management
Structure Risk	Not acknowledged	Acknowledged	Managed
Process Risk	Not acknowledged	Acknowledged	Managed
Coordination of Risks	None	Partial Overlap	Full Overlap
Risk Identification	None	Outside Domain or Aperiodic	Within Domain and Periodic
Risk Assessment	None	Outside Domain or Aperiodic	Within Domain and Periodic
Supplier Segmentation	None	Unclear Criteria	Clear Criteria
Supplier Auditing	None	Occasional	Periodic

From this coding schema it is now possible to rate each second level SCRM construct for each company in the study.

8.2.6 Evaluating SCRM Practices

Repeating the exercise from Section 8.1.8 by applying the developed coding schema to the SCRM constructs results in the ratings depicted in Table 8-26 below. As before sub-constructs are rolled up into the higher level construct by simple summations.

Table 8-26: Ratings for SCRM Constructs

	Bang & Olufsen	Brüel & Kjær	Coloplast	Dyrup	Fritz Hansen	LINAK	Novozymes	Oticon	RIEGENS	SDC DANDISC
External Conditions										
Size	L	L	L	L	S	L	L	S	S	S
Input	C	C	S	S	S	S	S	C	S	S
Process	S	C	S	S	S	S	C	C	C	C
Mfg. Process	S	S	S	S	S	S	C	C	S	C
SCM Award	Y	N	Y	N	Y	Y	N	Y	N	N
Level 1 Constructs										
Level 2 Constructs										
Risk Management?	Y	(Y)	(Y)	(Y)	(Y)	N	(Y)	N	N	N
Risk Management Organization	6	6	6	6	2	2	6	2	2	2
1. Formal Organization	3	3	3	3	1	1	3	1	1	1
2. Risk Management Positions	3	3	3	3	1	1	3	1	1	1
Risk Types and Management Efforts	11	9	9	9	11	9	13	11	10	9
1. Structure Risks	5	3	3	4	5	3	5	5	5	3
2. Process Risks	5	5	5	4	5	5	5	5	4	5
3. Coordination of Risks	1	1	1	1	1	1	(3)	1	1	1
Risk Identification and Assessment	6	4	2	2	6	2	6	2	4	6
1. Risk Identification	1	1	1	1	1	1	(2)	1	3	1
2. Risk Assessment	5	3	1	1	5	1	4	1	1	(5)
Supplier Risk Management	10	6	8	2	10	4	3	10	4	2
1. Supplier Segmentation	5	3	3	1	5	1	1	5	3	1
2. Supplier Audits	5	3	5	1	5	3	2	5	1	1

Also as before scores are calculated for 1st level constructs by determining the position between minimum and maximum rating for each constructs. The scores are depicted in Table 8-27 below.

Table 8-27: Scores for SCRM Constructs

	Bang & Olufsen	Brüel & Kjær	Coloplast	Dyrup	Fritz Hansen	LINAK	Novozymes	Oticon	RIEGENS	SDC DANDISC
External Conditions										
Size	L	L	L	L	S	L	L	S	S	S
Input	C	C	S	S	S	S	S	C	S	S
Process	S	C	S	S	S	S	C	C	C	C
Mfg. Process	S	S	S	S	S	S	C	C	S	C
SCM Award	Y	N	Y	N	Y	Y	N	Y	N	N
Level 1 Constructs										
Risk Management Organization	0,50	0,50	0,50	0,50	0,00	0,00	0,50	0,00	0,00	0,00
Risk Types and Management Efforts	0,67	0,50	0,50	0,50	0,67	0,50	0,83	0,67	0,58	0,50
Risk Identification and Assessment	0,50	0,25	0,00	0,00	0,50	0,00	0,50	0,00	0,25	0,50
Supplier Risk Management	1,00	0,50	0,75	0,00	1,00	0,25	0,13	1,00	0,25	0,00
Total Score	0,67	0,44	0,44	0,25	0,54	0,19	0,49	0,42	0,27	0,25

As shown in the table above the scores range between 19 and 67%. The scores are split in three groups: Bang & Olufsen scoring the 67%, the middle group consisting of Brüel & Kjær, Coloplast, Fritz Hansen, Novozymes, and Oticon scoring between 42 and 54%, and the remainder scoring between 19 and 27%. In Figure 8-3 below the ‘SCRM Total Score’ is mapped out against the first three (four) of the four (five) external conditions.

Figure 8-3: SCRM Total Score vs. External Conditions

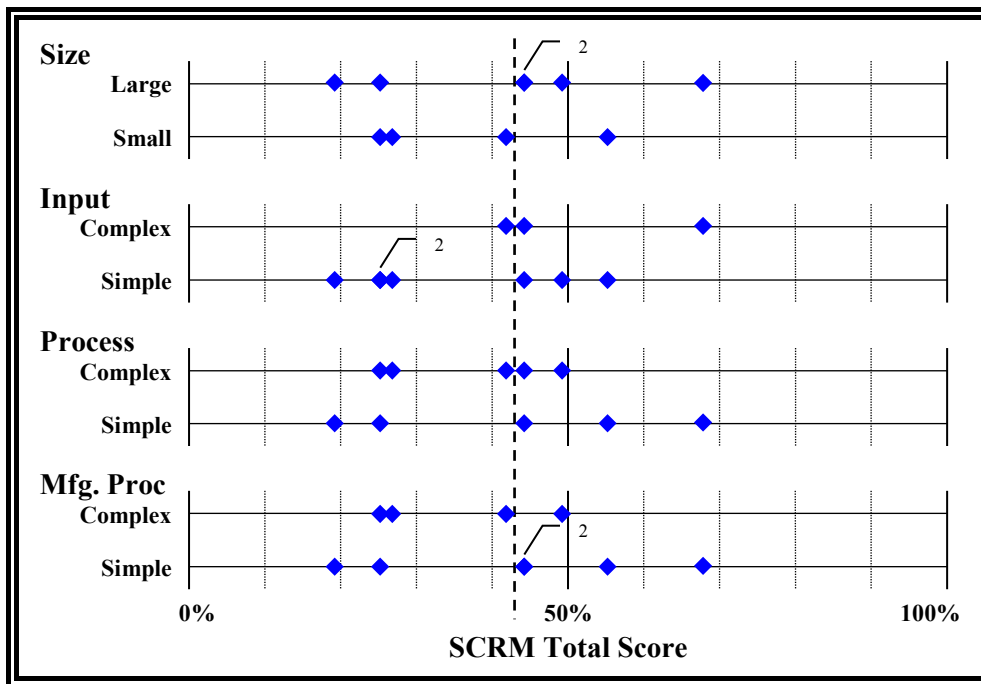

As for the analysis on the SCM practices no clear pattern emerges from combining the ‘SCRM Total Score’ with the (first four) external conditions (see Figure 8-3 above). Splitting the companies in two even-sized groups does not result in a clearer picture. None of the external conditions seem to have an impact on the overall SCRM score.

Level 1 Constructs vs. External Conditions

Repeating the simple exercise as illustrated above on the level 1 SCRM constructs results in a single additional insights: ‘Risk Management Organization’ seems to increase with ‘Size’. For the immature practices of SCRM perhaps the “resources argument” put forward in Chapter 6 is correct. If this is the case then the SCRM practices differ from the SCM ditto as the SCRM practices then to a higher degree rely on formalization.

Conclusion

Overall the SCRM practices seem to be quite immature as they are mostly implied/informal – and the practices are (with few exceptions) reactive instead of proactive. There seem to be a very low level of coordination of structure and process risks – and procedures for risk identification and assessment seem to be almost absent. In relation to supplier risk management a certain level of audits are performed; on the other hand the segmentation of suppliers is somewhat less rigorous than expected.

8.3 SCM versus SCRM Practices

Even if the practices do not reflect to hypothesized relationships with the external conditions there is still yet another relation which needs to be unravelled: namely the relationship implicitly stated Chapter 1 “More SCM -> More (Supply Chain) Risk Management” (see Figure 1-1).⁴⁰

Mapping the Scores

Mapping out the total scores against each other results in Figure 8-4 below.

⁴⁰ The implied relation to Perrow’s model is naturally that: the more SCM the less redundancy in the system, or perhaps even: the more SCM the larger the system.

Figure 8-4: SCM Total Score vs. SCRM Total Score

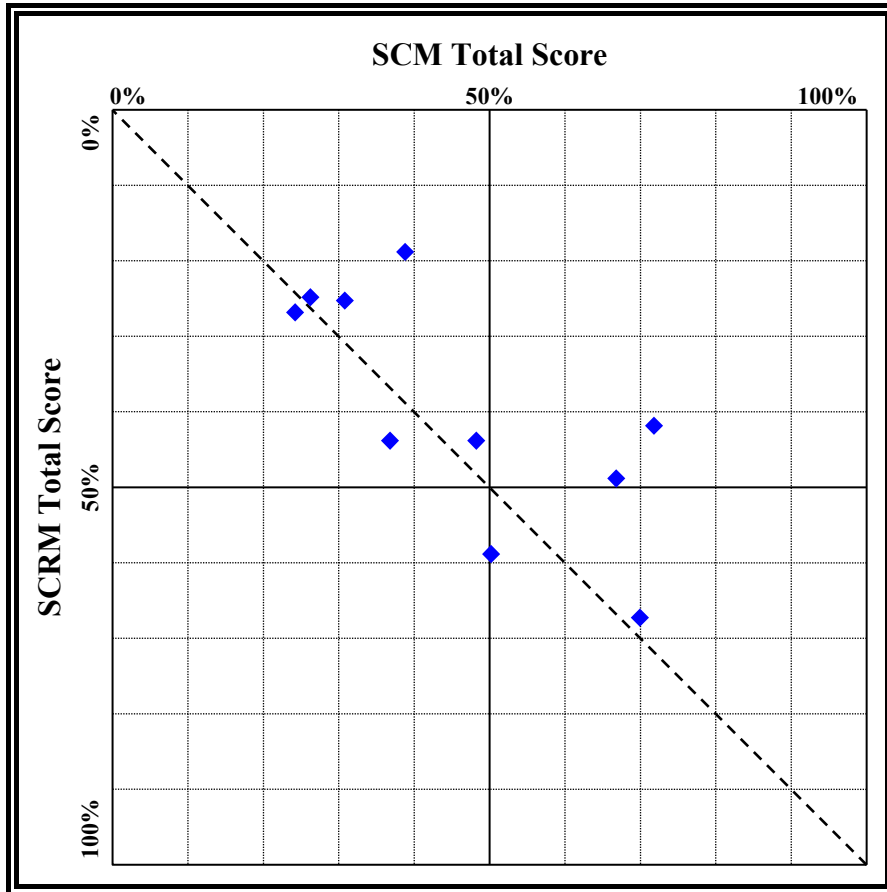

The dotted line in the figure above illustrates the “perfect balance” where the two scores are equal. It is thereby easy to see that three companies score higher on SCRM than on SCM whereas the remaining seven score opposite. It is also quite easily identified that a few companies seem to be quite low (comparative) on SCRM as the distance between the point and the dotted line is quite high.

Superimposing a classification based on the distance from the dotted line onto the figure above enables a quick categorisation of the companies, see Figure 8-5 below.

Figure 8-5: SCM Total Score vs. SCRM Total Score (II)

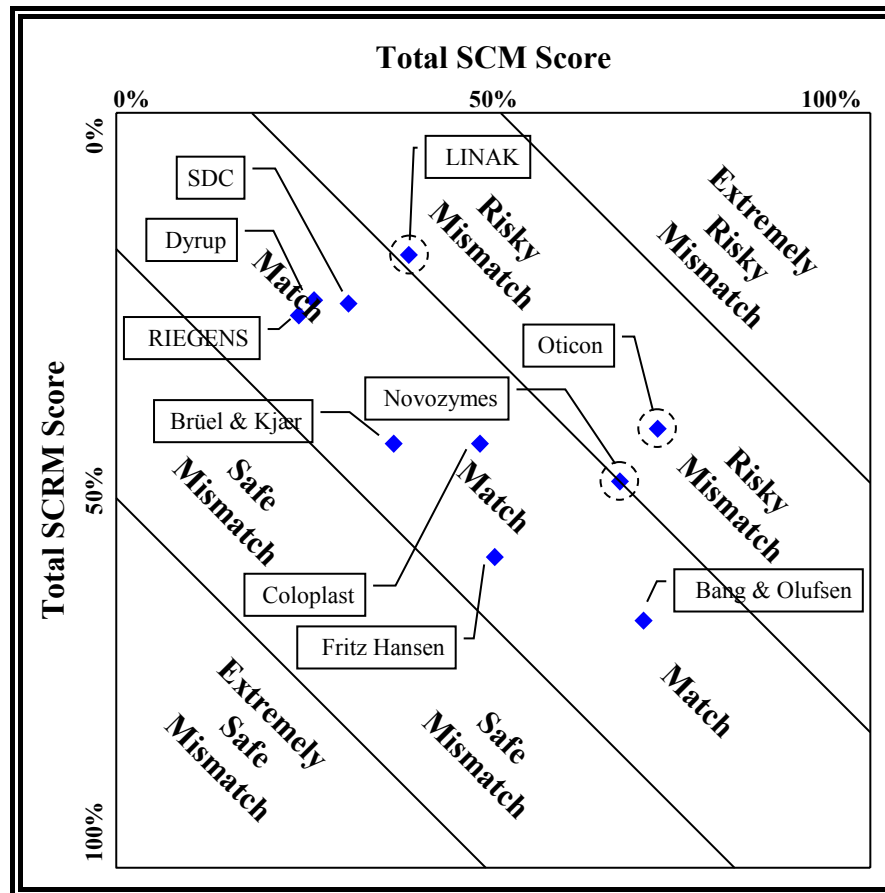

Two companies (LINAK and Oticon) are categorized as having a ‘Risky Mismatch’ between the SCM and SCRM practices and another (Novozymes) is on the border between ‘Match’ and ‘Risky Mismatch’. The remaining seven are categorized as ‘Match’.

8.3.1 Appropriateness

But even if a level of correlation is identified it does not necessarily mean the practices are considered appropriate.

SCM Practices

When querying the interviewees on the appropriateness of their SCM practice most companies describe their practice as continually evolving, e.g.:

“We have worked focused with logistics and SCM for many years – and the concepts in use seems to evolve over time.” (Johnny Nielsen, Coloplast),

“We change all the time – we focus more on the global market today than previously. The factory at Vassingrød would probably not have been built if the decision had to be taken today... Both demand and sourcing is more global today...” (Henrik Holm, Fritz Hansen),

and

“... it’s quite difficult to say if our SCM practice is appropriate or not – we are somewhere between entrepreneurial and professional ...” (Henrik Jakobsen, RIEGENS)⁴¹.

Coloplast and Fritz Hansen are thereby adapting to a changing environment whereas RIEGENS might be developing their SCM practice? At both Brüel & Kjær and Coloplast the question of SCM appropriateness is difficult to answer as there’s no uniform concept:

“Our practices vary greatly across the organization. Apparently no common practice exists – therefore local practices are heavily influenced by current or former department heads. ... We are currently working on creating some sort of standardization...” (Henrik Jeppesen, Brüel & Kjær)

and

“We believe it’s time to standardize our SCM practices through centralization. Our current practice is thereby not appropriate – but the issue is being addressed. ... The appropriate type or degree of SCM must be determined by the customers and the market in general – we believe SCM is part of the overall strategy...” (Henrik D. Nielsen, Coloplast).

The only company who replied positively to the question of appropriateness of their SCM practice was Novozymes. Thomas Videbæk explained:

“We are probably a bit more academic than most companies – and we have a very structured approach to these issues [organizational and process design]. We decided how we wanted to SC Organization to operate, performed thorough analyses, made a decision, and implemented. We have made minor adjustments to the original design but nothing major... We are about ready for the next phase – to include the bulk production in the SC Organization.”

The classification of Novozymes as “very SCM” is thereby no coincidence as current practice was implemented as designed – in contrast to all other cases where current practice is a consequence of an evolutionary process...

Supply Chain Risk Management Practice

The SCRMP practices are even more diverse. In some companies it seems quite difficult to identify the SCRMP practice: as mentioned previously Peter Finnerup (VP, Logistics, Oticon) quite dramatically rejected the existence of a SCRMP practice and subsequently retracted the rejection. The retraction was subsequently contradicted:

“I really can’t say if our practice [on supply chain risk management] is appropriate – it’s built into the supplier management practice, I guess. We evaluate the capabilities of each supplier and prioritize on that basis...” (Marianne K. Borum, Oticon)

At other companies SCRMP (except for compliance with regulations) is virtually non-existing:

“We do not work with [supply chain] risk management as a separate discipline – it is not formalized. But we work with e.g. internal processes to ensure health and safety – and we have contracts for capacity to help us out during demand peaks...” (Ernest Fuller, SDC DANDISC),

⁴¹ Perhaps due to being a recent hire Henrik Jakobsen does not reject working with SCM. He thereby contradicts long-term employees at RIEGENS...

and

“Our operation is so simple we do not need this type of [supply chain] risk management. There are no real risks of this type...” (Jesper Boysen, SDC DANDISC).

Besides buffering against demand peaks (due to the short deadlines imposed on the company) SDC DANDISC sees no reason to manage the risk of exits of critical supply chain partners⁴².

Similarly at Dyrup SCRM does not play a large role:

“Our [supply chain] risk management practice is largely non-existent. I believe we need to focus on [supply chain] risk management – perhaps develop scenarios. Besides risk management relating to facilities I believe we need to address our customers with a risk focus as well – our current practice is the result of having smaller autonomous units. ... The only reason we work on [supply chain] risk management today – besides regulatory risks – is the opportunity to decrease risk premiums...” (Henrik D. Nielsen, Dyrup).

In contrast to the practice at Dyrup scenario building is used actively at RIEGENS, albeit not on “normal operations”:

“We’re running a very stable operations, therefore spending a lot of money on risk management of normal operations would be a waste. Whenever we have a larger project [e.g. Turkey, Slovakia, UK] we spend quite some time in unraveling sources of uncertainty etc.” (Claus Jensen, RIEGENS)⁴³

Confronted with the failure of the Turkish project, Claus Jensen does not flinch:

“I my opinion we did all the right things when we worked on the project in Turkey. We had no chance of foreseeing the downturn in the Turkish construction segment. ... We did not perform stringent risk management routines, but we talked about a lot of scenarios, and the outcome was far from the worst case scenario. ... Of course it is a shame that the project was stopped, but that’s the way it is.”

The failure thereby did not lead to an improvement of their practice – as it was considered appropriate. Quite surprisingly only a few companies confessed the development of a level of SCRM was triggered by adverse events:

“When the warehouse at Coloplast Denmark burned to the ground it took only four days before operations were back to normal. It triggered the development of business continuity plans... You have to balance the resources you spend on risk management – we probably spend most of ours on risks with critically high impact. I believe our Business Risk Management implementation is quite appropriate – a lot of people have contributed...” (Johnny Nielsen, Coloplast)

and

“Following the long-drawn implementation of the new supplier [of buckets] it was decided to analyze the entire portfolio of suppliers – but it was never completed. Quite quickly other problems required immediate attention thereby pushing the portfolio analysis in the background.” (Finn Aa. Andreassen, Dyrup)

⁴² Unfortunately the dominant customer chose not to extend the contract – as described in the case study.

⁴³ It should be noted the mentioned stability is achieved through the continued balancing of dependability – and a stringent use of contracts with the major customers.

Even quite straight forward problems are thereby not being addressed due to simple horizon conflicts?

Integrated Practices

In a few of the companies the potential of an integrated approach is voiced – at Brüel & Kjær the management of exit risks is to be designed into their product design procedures:

“Also in relation to sourcing new products we have a challenge ahead of us as we are not supposed to introduce new products relying on sole sourcing – but we still are not fully integrated into the product design process.” (Henrik Jeppesen, Brüel & Kjær)

Dependency towards a single supplier is thereby avoided as is the impact of an exit. At Fritz Hansen the failure (or exit) of a supplier might (due to the special characteristics of the market they operate in) threaten the long-term survival of the company. They are therefore investigating the possibility of developing one or more “back-up supply chains” – ready to start operating at a very short notice.

But it is Steen B. Jørgensen (Bang & Olufsen) who fully grasps the potential of the integrated approach. Confronted with the idea of redesigning the supply chain for minimization of risks, Steen B. Jørgen after a few seconds of hesitation comments:

“Redesigning our supply chain for minimization of risks operates at the tactical level, I guess. Multiple opportunities for supply chain redesign exist, but the starting point must be to redesign the products, to eliminate unnecessary dependencies. ... Taking this argument [the design] to the extreme customers as well as suppliers must be evaluated before being accepted as supply chain partners. ... Product development and supply chain design must be performed in a continuous, concurrent process – to ensure ‘fit’....”

and continues:

“To redesign the supply chain processes products are the starting point. Therefore R&D must interact with Purchasing to identify appropriate sources for solutions. Conversely, Purchasing should focus their attention on ensuring availability of the competencies needed by R&D. These processes should be coordinated on a continuous basis to ensure product and supplier portfolios are ‘in synch’.”

Viewed in this perspective the stringent method in place at Bang & Olufsen suddenly seems even more important as it creates a basis for this next level of supply chain management:

“Whenever this becomes necessary we are probably in a better situation than most [due to the supplier management methodology in place]. Within the next couple of years we probably have plenty of work to do in modifying our concepts according to the increased outsourcing. This may alter the situation in ways we can not predict...” (Steen B. Jørgensen, Bang & Olufsen)

Determining Appropriateness...

... thereby apparently is not so straight forward. Even the best companies can identify short comings and even the simplest practices are considered appropriate.

8.4 Conclusions

The aim of this chapter was to answer the last research question – how the case companies perform SCM and SCRM.

Practices and External Conditions

The case studies and the analyses above fully document the idiosyncratic nature of the SCM practices and the immaturity of the SCRM practices. Each SCM practice seems to differ from the others – perhaps due to the breadth and complexity of the practices investigated.

The external conditions only to a very limited nature “predicted” the practices of each case study – but the assumed relationship between SCM and SCRM seems to exist for the companies investigated.

Appropriateness

The confusion arising from the attempt to describe a “shared” understanding of the appropriate match between SCM and SCRM practices documents the lack of institutionalization of SCRM and the lack of a “reference practice”. Some of the companies with sophisticated SCM practices perceive their (relatively) advanced SCRM practices as inappropriate whereas companies with little or no SCM practices perceive their (near) absence of SCRM as appropriate. The easy answer is naturally that non-SCM companies do not need SCRM.

Revisiting the Scale on Risk Management

Recalling the difference between the two domains in terms of conceptual understanding prior to developing the construct hierarchies (and associated scales) it may be speculated the scores on SCRM need to be calibrated. Assuming the “theoretical best practice” implied by the constructs and scales within SCRM represents a score of 50% instead of the 100% used in the model the correlation between SCM and Risk Management does not change – but the classification of the companies does. In Figure 8-6 below the new scores are used to map the two practices against each other.

As shown a simple recalibration of the scores – which may make sense according to the assumption above – more than half the companies are now categorized as ‘Risky Mismatch’ and one (Oticon) is very close to the ‘Extreme Risky Mismatch’ class.

Figure 8-6: SCM Total Score vs. SCRM Total Score (III)

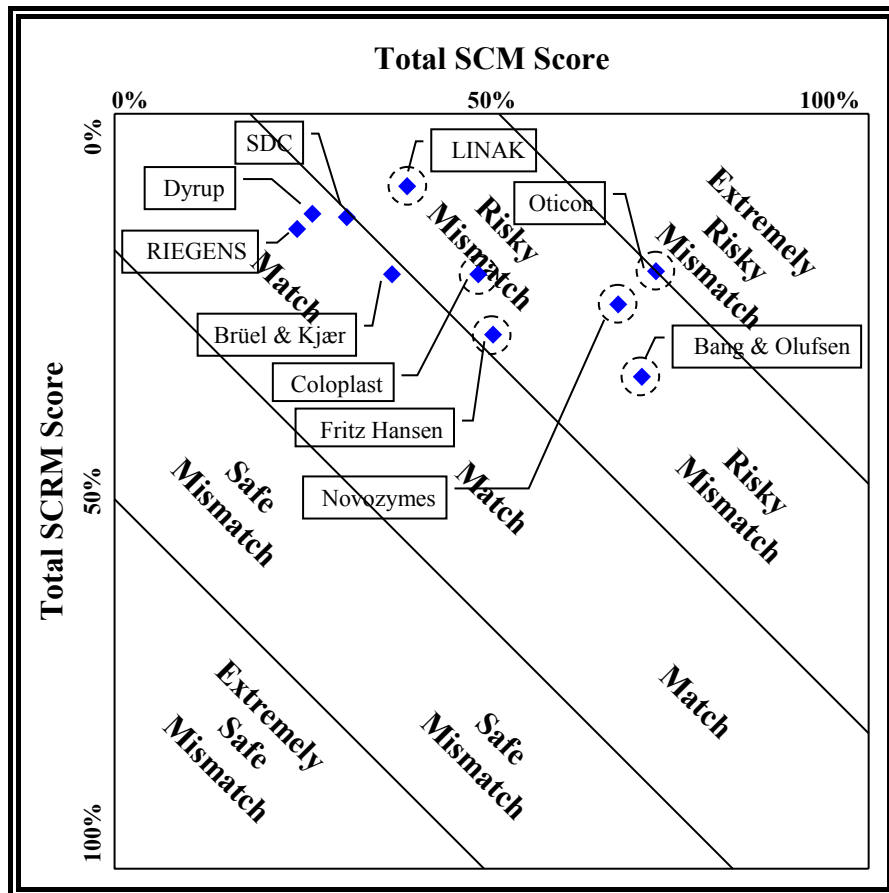

Whether the model above depicts a truer picture of reality than the previous version (Figure 8-5) is difficult to answer – it may be appropriate to further triangulate the findings...

8.5 Epilogue...

Continuing the practices of triangulation introduced in Chapter 3 the conclusions above are challenged by investigating other data sources on SCM and SCRM. In this instance Annual Accounts may include relevant information, as may the testaments of personnel from outside SCM and Purchasing. In the following these triangulations are described and the chapter is concluded by a discussion of the combined findings.

8.5.1 Triangulation I: External Reporting

In order to perform the first triangulation the latest available Annual Accounts from the case companies are collected. With reference to the discussions in Chapter Two the analysis will identify reporting on SCM and Corporate Governance and subsequently on Business and Financial Risk Management.

Construct 'External Reporting on SCM'

In three of the annual accounts indirect reference is made to the SCM term⁴⁴. At Bang & Olufsen the reference is made when emphasizing the importance of having close relationships with suppliers (not least in relation to the development of new products). Also at Brüel & Kjør the practice of having close relationships with suppliers is praised whereas at Novozymes the close relationships are sought after on the downstream side.

Only at Dyrup the annual accounts explicitly references the term 'supply chain':

“A well-functioning and efficient supply chain is essential for Dyrup to continue in the right direction and to remain competitive. The optimal transport structure, streamlined production processes and effective planning routines are all elements that have a major impact on costs and efficiency in the supply chain...” (Dyrup, 2005, p. 9)

Interestingly the external reporting on SCM does not match the score on SCM (see Table 8-18). Dyrup, for instance, received the second lowest score on SCM (0,27) – and Oticon receiving the highest SCM score (0,72) does not refer to SCM at all. Irrespective of the match between the external reporting and the SCM score obtained it is very interesting to observe how SCM is reaching a strategic importance justifying a place in the external reporting.

Construct 'External Reporting on Corporate Governance'

The case companies do slightly better on Corporate Governance as half the companies refer to the framework⁴⁵. Three of these five companies (Coloplast, Novozymes, and Oticon) furthermore make reference to Risk Management (in general terms) as an integral element of Corporate Governance. Coloplast and Oticon have even published report on their homepages on Corporate Governance and/or Risk Management (Coloplast, 2005a; Coloplast, 2005b; and William Demant Holding, 2003).

The reference made in the annual account for Bang & Olufsen quite narrowly focus on two issues: the use of multiple share types and incentives for members of the management and the boards. At SDC DANDISC the reference is very brief:

“SDC DanDisc follows the part of the recommendations from the Nørby report which is relevant for the company.” (SDC DanDisc, 2005, p. 15, translated).

Construct 'External Reporting on Business Risk Management'

In six of the ten annual accounts references to business risks and their management are identified⁴⁶. For Brüel & Kjør and Novozymes the most critical risk to be managed relates to their respective core technologies, whereas the other companies refer to e.g. customer specific inventory (LINAK), volatility of market (Dyrup), and dependency on key personnel (SDC DANDISC). Only three companies (Coloplast, Dyrup, and Novozymes) hints how their risk management is performed.

⁴⁴ More details in Chapter K.1 in Appendix K.

⁴⁵ More details in Chapter K.2 in Appendix K.

⁴⁶ References to "the general trend" are disregarded as they will apply to all companies. More details in Chapter K.3 in Appendix K.

Comparing the external reporting on Business Risk Management with the SCRM score (see Table 8-27) results in the same conclusion as for SCM: little or no correlation. The two highest scores (Bang & Olufsen and Fritz Hansen) have no content on Business Risk Management in their external reporting whereas the three lowest scores (LINAK, SDC DANDISC, and Dyrup) all have content. Average SCRM score for companies with no content is 0,475 whereas the average score for companies with content is 0,343.

Construct ‘External Reporting on Financial Risk Management’

All annual accounts contain some level of description of the Financial Risk Management⁴⁷. This is not surprising as the Accounts Act stipulates all relevant contingencies (hereunder risks) must be described. The ‘classical four’ financial risk categories are: Currency, Interest, Credit, and Liquidity Risks – as is evident in the investigated material.

So...

Comparing the findings across all four categories does not seem to reveal much besides the description of Corporate Governance in some instances contains a description of Business Risk Management. Corporate Governance does not seem to trigger the introduction of SCM into the external reporting – which is not surprising as SCM and Corporate Governance do not seem to connect in any way (see Chapter 2). All four categories are combined in Table 8-28 below.

Table 8-28: Summary of ‘External Reporting’

Company	SCM	Corporate Governance	Business Risk Management	Financial Risk Management
Bang & Olufsen	(Yes)	Yes	No	Yes
Brüel & Kjør	(Yes)	No	(Yes)	Yes
Coloplast	No	Yes	Yes	Yes
Dyrup	Yes	No	Yes	Yes
Fritz Hansen	No	No	No	Yes
LINAK	No	No	(Yes)	Yes
Novozymes	(Yes)	Yes	Yes	Yes
Oticon	No	Yes	(Yes)	Yes
RIEGENS	No	No	No	Yes
SDC DANDISC	No	(Yes)	(Yes)	Yes

Triangulating with the external reporting does thereby not seem to spread any more light on Supply Chain Risk Management. Optimism is called for, though, as SCM has made its way to the external reporting – perhaps indicating a shift towards Supply Chain Strategizing?

⁴⁷ More details in Chapter K.4 in Appendix K.

8.5.2 Triangulation II: Financial Department / Staff Perspective

As mentioned previously the second triangulation is performed by means of interview with personnel from finance (or other relevant staff function). The “staff function perspective” on risk management are described below⁴⁸, followed by a discussion of the findings.

Bang & Olufsen

At Bang & Olufsen their supplier management model (see Figure 7-2) combines financial checks with compliance on operational issues and design of the supplier base. Their practice thereby is rather advanced albeit it is unclear if risk management at corporate level addresses these issues. According to Kim B. Hansen (Legal Council) there is little or no redundancy on risk management as:

“Risk management is performed at various places, e.g. supplier risks at purchasing, operational risks at facilities management, and financial and legal risks at Finance and Legal, respectively. At each place in the organization a unique risk category is addressed...”

Palle Dalgaard (Legal Council) confirms⁴⁹ the financial risk management does not take supply chains into consideration:

“The information published in the Annual Accounts [p. 55] is accurate and precisely describes the scope of the financial risk management.”

Supply chain risk management is thereby limited to the practice encapsulated in the supplier segmentation model.

Brüel & Kjør

In contrast to Bang & Olufsen the risk management practice at Brüel & Kjør is designed by a parent company:

“Currency and interest risks are not addressed as they are pooled at our parent company. ... Our parent company specifies the guidelines for quarterly reporting which contains a wide range of elements...” (Claus T. Madsen, Controller)

Credit risks are managed at company level – but no risk management department or positions exist for financial or business risk management. Risk management of inter-organizational issues is limited to a financial analysis of suppliers, an activity performed very rarely. Risk management of the supply chain is not supported...

Coloplast

As described in the case study Coloplast has employed a person to work on Risk Management. He explains his area of responsibility as follows:

“I was employed to implement ERM throughout the organization. I am responsible for all reporting and development. ... The management of the specific risks is the responsibility of the respective manager – risks are to be

⁴⁸ At Novozymes the relevant person was identified but attempts at getting an interview were futile.

⁴⁹ Several attempts at contacting Randi Toftlund (Director, Finance & Accounting) were unsuccessful.

managed where they occur. ... Also, as I am employed at Corporate there's quite a distance to e.g. Operations...” (Peter Kofoed, Risk Manager)

The current setup does not give a lot of support to the managers as:

“I do not offer a method as such – my job is to document the risks already identified and follow up on the periodic reporting. I can not help the managers identify or assess risks within their respective areas... ERM is restricted to giving top management periodic reporting on identified risks.”

He further explains how financial risk management fits into the framework:

“Corporate Finance works from the same method: they have a number of risks identified and they deliver periodic report to me. Financial risks thereby are no different from any other types of risks...”

According to Peter Kofoed ERM creates value at Coloplast:

“ERM ensures identified risks are addressed: once a risk is identified the respective manager will have to follow up through the periodic reporting. Once identified a risks therefore will be managed until removed or minimized...”

In Peter Kofoed's opinion Coloplast probably has the second-best practice within ERM, only surpassed by Novo Nordisk.

Dyrup

Also at Dyrup a person is employed to do Risk Management – and again ERM is being implemented. Anders Busk (Risk Manager) explains their current practice:

“We have not worked with Business Risk Management but are currently implementing ERM. We do not focus on financial risks as they are all scored pretty low. ... We focus on operational and strategic risks – and on insurable risks...”

He has worked with Risk Management at Dyrup for approx. two years and has within this timeframe performed a risk analysis of the entire company encompassing financial, strategic, and hazard risks. The exercise has been strictly internal since:

“Before venturing into the portfolio of customer and suppliers we want to have our own house in order. We may at a later stage include these stakeholders but currently we are working on developing systems and processes supporting our internal risk management... We also need a green light from the Board before taking risk management further...”

In may therefore take some time before Dyrup addresses the supply chain risks...

Fritz Hansen A/S

According to Morten H. Larsen (Head of Accounting) the financial risks management practice at Fritz Hansen a/s is somewhat under-developed:

“Fritz Hansen a/s is focused on operations and sales, and functions like cash management and risk management is not really developed yet. They may be developed in the future if the need arise, but currently the financial risks are quite minimal. ... But actually I have been asked to create a cash management function.”

He continues to describe a single instance when he helped Operations by assessing the financial data on a potential supplier. He also offers an explanation of the minimal attention given to financial risk management:

“Our owner is Skandinavisk Holding⁵⁰, so there’s cash enough at our disposal. We therefore probably buy less insurance than other companies as our mother company can easily help us out in case of an accident or other types of adverse events.”

Financial risk management at Fritz Hansen is thereby rather standard as policies and reporting standards are handed down from the parent company. Supply chain risk management is absent except for the practices already described in the case study.

LINAK A/S

The practice in place at LINAK is also quite basic:

“We have no dedicated personnel - financial risk management is an integral element in the controller job. ... We have no advanced frameworks implemented, we do not even use the tools our bank tries to sell us.” (Carsten Borchert, Director)

Management of the four classic categories is also pretty standard: the currency risk (primarily USD) is accepted, interest risk is managed by buying short bonds, credit risk is handled through insuring all debtors above a certain threshold, and liquidity risk is of no relevance.

The only risk ranging outside the Finance department is the inventory:

“We have an interest in the inventory level as it represents a very large sum. ... We have been working closely with Morten Raahede on the centralization of inventories. We have to find a balance between adapting products for specific customers, reducing inventory, and keeping up delivery precision...”

Carsten Borchert ends the interview by commenting on the positive impact of management ownership on Risk Management and Controlling in general.

Oticon A/S

At Oticon financial risk management does not have a distinct organizational entity, but takes place at various places in the organization:

“The overall financial risk management is reported to Top Management who also dictate procedures and policies. ... The typical risk categories credit, exchange rate, and interest rate risk management is performed by controllers, but other types of risk management take place as well.” (Svend Thomsen, Finance Manager).

The implementation of risk management was initially driven by IT security issues and raising insurance costs as well as pressure from the company’s auditors, but now also internal pressures exist, Svend Thomsen:

“We experience an increased interest in risk management from various part of the company. There’s a growing understanding of the value of having dual perspectives of ‘troublesome’ issues: the operational perspective as well as the

⁵⁰ For more information, please see www.st.dk.

perspective of the staff function. ... Currently we are 5-6 people in total, across the company, who work (part time) on risk management, but this might change.”

No position or role for the management of Logistics/Supply Chain Management risks exists, though, and no stringent methods have been implemented to evaluate this type of risks.

RIEGENS A/S

Financial risk management is performed solely by Finance Manager Thomas Hansen:

”Even if we have had projects which have terminated unsatisfactory, the core business is actually quite stable. ... The most important [financial] risk category is currency risk, but this is managed through loans, and through matching purchases with outstanding payments. We have even used options. ... Credit risks are quite minimal as the vast majority of revenue come from long-term business partners – only on projects it may be necessary to ask for either a bank guarantee or a down payment.”

The management of financial risks is thereby performed in the most traditional fashion – by a staff function defining policies and credit limits. The company has no integrated frameworks or systems to report risk exposure, and Thomas Hansen insist there’s no need for it:

“When we talked about acquiring the operation in Braintree we talked about requirements in terms of organizational structures, redundant position and such, but we decided to handle risk management from here. The stability of the business limits the requirements on monitoring of e.g. market development, and the financial exposure is relatively limited.”

Having procedures in place is important though when participating in projects, as lead times are getting shorter and shorter.

SDC DANDISC A/S

Following the merger between DCM and SDC DANDISC Torben Nordquist has taken over the position as CEO in the company renamed Dicientia. He explains the current practice for financial risk management:

”Our company does not differ from any other company our size: we have no separate staff function or department for risk management, but rely on the professionalism of the individuals in the finance department. Our controllers handle the standard tasks within interest rate and currency risks. ... The longer term or more strategic risks are dealt with at board and management level.” (Torben Nordquist, CEO)

He further describes how the company has insurance for loss of operation, and ponders whether this has to be re-evaluated when the merging of operations of the two companies has been completed. He furthermore comments that no procedures for identification of risks are in place – risk management is triggered by events internally or externally.

In Summary...

Quite surprisingly several companies have integrated risk management frameworks implemented. At both Coloplast and Dyrup apparently the reporting required by the ERM implementations is not perceived as Risk Management per se – but as management reporting?

Several of the companies (Brüel & Kjær, Dyrup, and Fritz Hansen) had their (financial) risk management practice dictated from the parent company, limiting the autonomy and setting standards for reporting (and thereby measurements).

The companies also differed in terms of dispersion (or recognition) of the risk management activities. At Bang & Olufsen risk management is performed at Legal, in Purchasing, and at Corporate Finance; at Coloplast apparently risk management is part of all managers job; and at Oticon their “spaghetti organization” contains 5-6 people working on risk management part time. In the other companies risk management is part of the controllers’ jobs – and perhaps the job of the Head of Accounting. Most likely this result is primarily driven by the perception of risk management in the minds of the interviewees... Nonetheless practices of stringent, methodical risk identification, assessment, and management were not found outside the practices of financial risk management in the controlling functions.

No practices of Supply Chain Risk Management were identified – and only to a very limited extent was cross-departmental risk management described. It seems that Financial and Business Risk Management follows the split in Porters split between support and core?

8.5.3 Conclusion

The two triangulations resulted in different findings: the former identified SCM in the external reporting whereas the latter revealed the existence of ERM implementations in two of the case companies. The latter finding explicated the difficulty in distinguishing between risk management and (strategic) management as no practices of Supply Chain Risk Management were identified.

PART IV

CONTRIBUTIONS, CONCLUSIONS, CONCERNS...

Chapter 9 Contributions, Conclusions, Concerns...

This chapter summarizes the contributions and conclusions and elaborates over concerns in relation to basic assumptions, methods, and the empirical foundation. The chapter closes off with suggestions for future research.

9.1 Contributions and Conclusions

Contributions and conclusions are summarized below in chronological order.

9.1.1 The Pilot Studies

As described in Chapter 1 and Appendix A the assumption in Steven's (1989) model - integration starts from within, leading to SCM – is rejected after performing two pilot studies. This leads to the first conclusion:

Conclusion P-1: SCM does not evolve as predicted in Stevens' model.

During the pilot studies it is also clearly stated that Supply Chain Risk Management is relevant and even critically important to the domain, leading to the second conclusion:

Conclusion P-2: Supply Chain Risk Management is important to the Logistics/SCM domain.

These conclusions in combination result in a redesign of the study.

9.1.2 The Conceptualization

Before doing so SCM and SCRM are conceptualized in Chapter 2. It is described how risk management has evolved beyond the calculations of probability and impact of adverse events to a somewhat qualitative practice focusing on pure and speculative risks both. Subsequently the SCM domain is described. After venting three aversions (more on them later) two perspectives are derived, and a choice is made:

Contribution C-1: SCM might be perceived as a fulfillment system (or a long-linked technology)¹.

Following this choice the most relevant risks to manage are derived – matching the risks with the characteristics of the fulfillment system. In line with existing literature the risks derived both relate to the operation of the system: the disruption in the flow and the sudden exit of a critical supply chain partner. Furthermore distinction is made between the intentional and non-intentional disruption and exit.

¹ See Thompson (1967) or Stabell & Fjeldstad (1998).

Contribution C-2: The Risk Matrix defines the risks relevant to the SCM context: process and structure.

This leads to the claim that supply chain design must embrace risk management similarly to cost minimization, and that other objectives may be relevant. Furthermore it is postulated that any one company may manage a multitude of supply chains.

Contribution C-3: Designing Structure and Process within SCM must relate to cost and risk (and possibly other objectives as well) for each supply chain the company participates in.

These contributions are naturally very subjective and even normative – and possibly impacts the conclusions made in the remainder of the manuscript. But without these guiding clarifications the task of investigating the SCRM practice might be impossible. The integration of SCM and SCRM by means of the Risk Matrix facilitates an understanding of the link between the short-term optimization of the fulfillment system and the long-term safeguarding of the company.

9.1.3 The Literature Studies

The next step is to answer the first two research questions:

1. What are the major themes on Risk and Uncertainty within the SCM literature?
2. How does state-of-the-art Supply Chain Design address the management of supply chain risks?

In both cases the research question is answered by means of an extensive literature study. Analyzing thirty journals from the Logistics, Operations Management, and (General) Management domains answers to the two questions are sought using the literature study method described in Appendix C².

Literature Study on Risk, Vulnerability, and Uncertainty

The literature study on Risk, Vulnerability, and Uncertainty identified 189 contributions of which nine referenced Vulnerability, 76 referenced Uncertainty, and the remaining 104 referenced Risk. Analyzing the contributions according to a number of categories clearly documents the variation across the 189 articles:

- The analysis according to phase in the risk process (Identification, Assessment, Management) reveals that contributions on Uncertainty seldom addresses the Assessment and Management phases. Conversely the contributions on Risk address all three phases.
- Relatively few articles are oriented towards the network level (fourteen), most are internally oriented (84), whereas 62 are oriented upstream and 43 downstream. Most of

² The method described in Appendix C might be perceived as a contribution as well albeit it is somewhat disconnected from the subject at hand.

the articles oriented internally are OM articles dealing with incorporating uncertainty into various decision models.

- Approx. 40% of the articles are oriented towards the strategic level. Of the fourteen articles addressing the network ten are of a strategic nature.
- A variety of research methods are identified: mathematical modeling (68), case studies (35), surveys (20), or simulation (12). The remainder (54) is of conceptual nature.
- Only a minor fraction (36) of the articles makes explicit reference to theory.

Based on these findings a first conclusion is made:

Conclusion LI-1: The literature on Risk, Uncertainty, and Vulnerability within the SCM domain is predominantly non-theoretical and only very few articles address the network level.

Analyzing the identified article for commonalities reveals a number of themes. The most relevant themes (in this context) are:

1. Securing the Supply Chain,
2. Supply Management,
3. Supply Chain Design, and
4. Risk Management in the Supply Chain.

The first theme contains only recent contributions which are primarily focusing on extreme events like terrorism. The second and third themes are broader, both in terms of focus and on the timeframe from which the articles are identified. Risk and Uncertainty are two terms considered focal to securing inputs and in the design of supply chains.

The last theme address directly the issue of this dissertation: the management of supply chain risks. Unfortunately theory is almost absent in this collection of articles as only one article (Hallikas et al., 2004) makes explicit reference to theory. In contrast both Supply Management and Supply Chain Design contains a number of theoretically founded articles.

Analyzing the contributions belonging to these four themes for the strategy implied for managing the implied risks showed an overrepresentation for the strategies risk reduction and risk avoidance. Few mentioned risk acceptance, insurance, and risk sharing – and only four articles (Hauser, 2003; Hallikas et al., 2004; Martha & Subbkrishna, 2002; Sinha, Whitman, & Malzahn, 2004) mention at least four of the five proposed strategies. Of these four articles only the former two operate at the network level.

From these findings another conclusion is made:

Conclusion LI-2: The literature on Risk, Uncertainty, and Vulnerability within the SCM domain does not fully embrace Supply Chain Risk Management as contributions are scarce and fragmented.

Performing the reverse analysis – trying to identify Logistics/SCM articles within the Risk Management domain – have very meager results as only six articles are identified, all dealing with transportation risks. It is therefore concluded that:

Conclusion L1-3: The literature on Risk, Uncertainty, and Vulnerability within the SCM domain is not complemented by contributions from the Risk Management domain.

Literature Study on Supply Chain Design

In the second study the exercise is repeated this time identifying all contributions on Supply Chain Design. This time the search is performed “automatically” using key word searches to increase efficiency. Contributions are first evaluated for relevance and thereafter classified in a manner similar to the first study.

The search results in a gross list containing 149 articles and adding the articles from the completeness check the list increased the total to 162. Rejecting articles due to lack of relevance results in a net list containing only 40 articles. Analyzing the contributions according to a number of categories again documents variation:

- Only ten of the 40 articles aim at designing process and structure concurrently. The remainder is quite evenly split between structure only and process only. Showing less homogeneity the category ‘Orientation’ reveals 25 articles focus on internal design whereas seven focus on upstream and seven on downstream design problems. More than half the articles (21) aim at the network level when designing structure (6), process (8), or both (7).
- The vast majority of the relevant articles are either conceptual (14) or report case studies (15). Eight use modeling and the last three use simulation.
- The explicit use of theoretical frameworks is identified in only four articles – and only two theories are identified: TCE and Chaos Theory.

Based on these findings a first conclusion on this literature study is made:

Conclusion L2-1: The literature on Supply Chain Design addresses both ‘systems components’ Structure and Process. A fair share of the articles focuses on the network level – and a few of these address Process and Structure both. The articles are predominantly conceptual or report case studies – and the explicit use of theory is almost absent.

Following a grouping by subject area the articles are analyzed for design objective(s), and reference to risk and/or uncertainty. It is concluded that:

Conclusion L2-2: Less than half (sixteen) of the relevant contributions on Supply Chain Design address more than one design objective. The most popular objective is ‘Cost’ (fourteen), followed by ‘Performance’ (thirteen), ‘Responsiveness (five), and ‘Lead Time’ (four). Only two articles reference ‘Risk’ as a design objective – an additional two aim at reducing uncertainty.

and

Conclusion L2-3: The role played by risk and uncertainty within Supply Chain Design is surprisingly low as only thirteen articles reference either term. Three of these articles address demand uncertainty; very little commonality can be found between the remaining ten.

Comparing the study with the theme ‘Supply Chain Design’ in the first literature study reveals a surprisingly low degree of overlap as only three articles are found in both studies³. Performing the above analyses on this sub-set reveals that all but one have more than one design objective, and that seven of the articles address risk or uncertainty directly and another two aim at reducing uncertainty in some way.

Overall it is concluded that:

Conclusion L2-4: The thirteen articles on Supply Chain Design (which also reference Risk or Uncertainty) cover both systems components (Structure and Process) as well as all relevant orientations (Up- and Downstream, Internal and Network level) despite the low number.

The final check has two steps: first a simple comparison of the identified articles against the “classic articles” mentioned in Table 2-1 to verify if all relevant articles are identified; and subsequently an analysis of the articles mentioned in that table. It is concluded that:

Conclusion L2-5: The original claim made in Cooper, Lambert, and Pagh (1997) that ‘Risk and Reward Structure’ is challenged as 1. the overlap between the ‘classical’ articles listed under ‘Risk and Reward Structure’ and the list of articles on Supply Chain Design is very limited, and 2. the ‘classical’ articles do not seem to address Risk and/or Uncertainty to an acceptable extent but focus on the sharing of benefits.

The next step is to investigate how the theories most often applied within the SCM domain address the management of the supply chain risks.

9.1.4 The Review of the SCM Theories

The review clearly documents how different the theories are in terms of addressing the SCM domain and the management of the supply chain risks.

Addressing the SCM Domain

All of the theories have shortcomings in addressing the SCM domain:

³ It may thereby be claimed that no literature study should be considered complete before performing a very broad completeness check. Alternatively it may be postulated that every literature study should be subject to a verification by senior researchers ensuring “all relevant” contributions are represented. Here it is simply concluded that the search strategy may have been too narrow – in spite of the large number of hits...

- TCE can only handle dyads (in contrast to more complex network constellations) and focuses on cost instead of value,
- P/A theory has shortcomings when it comes to distribution of roles (principal and agent), time perspective, and the optimality criteria,
- RBT has problems in addressing the notion of ‘supply chains’ (even if both resources and core competencies may stem from the combination of company and cooperators/environment) and a lack of objective measures, and
- IA does not have any normative recommendations as to how supply chain should be designed, but merely insists networks evolve over time creating dependencies between companies as a result of successful exchanges and gradual adaptations.

A number of contributions identified combine e.g. RBT and TCE when contributing on Outsourcing (McIvor, 2000), Strategic Sourcing/Vertical Integration (Walker, 1988), or Supplier Management (Bensaou & Anderson, 1999; Smeltzer & Siferd, 1998).

In conclusion:

Conclusion T-1: The perspectives offered by the four theories differ greatly – and neither of the theories in isolation handles the design of Structure and Process in a multi-entity context well.

The study thereby echoes Croom, Romano, & Giannakis (2000d), Storey et al. (2006), and Burgess, Singh, & Koroglu (2006): the domain seems to be in dire need of coherent theory (or meta-theory)? Suggestions to address the shortcomings are offered:

Contribution T-1: Enhancements to the theoretical frameworks are suggested for improving their applicability for designing supply chains.

Managing the Supply Chain Risks

Also in terms of managing the supply chain risks (exit and disruption) the frameworks differ greatly:

- In TCE the notions ‘Frequency of Disruption’ and ‘Fundamental Transformation’ are important in understanding the management of supply chain risks. In case of unsatisfactory high frequency of disruptions a shift in governance mechanisms might mitigate the process risk. The structure risk is managed through the balancing the (inter)dependencies – in case of an unintentional exit it will make a difference if the cause was e.g. bankruptcy or a hostile takeover.
- In P/A theory the risk management mechanism available is choice of contract and design of penalty for breach of contract. The structural risk is not really addressed as contracts are supposed to cover the entire period – applying the theory would result in all contracts being behavior-based.
- Resource Based Theory does not address neither process nor structure risks directly. Indirectly RBT might appreciate the importance of ensuring stability in the operation as

the value of the competence might be negatively influenced in case disruptions are frequent. On the structural level shared competencies might provide the incentive to ensure critical partners do not drop the relationship.

- In the Interaction Approach the intentional disruptions and exits from the network are assumed non-existing. Opportunistic external partners are supposed to be denied access as a measure to safeguard the entire network. Once member of the network a poor performer is supported by the other members. In case of an unintentional exit (e.g. bankruptcy or incident at a factory) only failures endangering the entire network are ignored. Membership of a network is perceived as a quite resilient risk management measure.

The frameworks are similar in the fashion only that no discrimination between up- and down-stream partners seems to exist. In conclusion:

Conclusion T-2: None of the four theoretical frameworks support the management of all four supply chain risks, even if the suggested enhancements improve their applicability. The distinction between intentional and unintentional incidents is not easily managed in the theories in general.

9.1.5 The Empirical Investigations

The third part of the dissertation investigates the SCM and SCRM practices.

The SCM Practices

The SCM practices investigated span a wide range as each practice seem to be “made to fit” the context of each company. In terms of formalization most companies have an “informal” SCM organization. SCM processes are not that well defined as most companies either have no processes or refer to functional areas as process names. The use of integrated IT systems (ERP) is quite high but only few of the companies have integrated their applications with external parties. Even if almost all companies report having long history with external parties collaborative planning exists at a very moderate level only. Inter-organizational management (management across the supply chain) is absent less some level of learning/knowledge sharing. It is concluded:

Conclusion E-1: The SCM practices investigated span a wide range as each practice seem to be “made to fit” the context of each company. The SCM practices are perceived as continually evolving rather than following an overall plan.

Case selection is guided by external conditions which are mapped out against total scores and the scores for each 1st level construct:

Conclusion E-2: *The external conditions do not seem to “predict” the overall SCM practices well – except for ‘SCM Award’. The 1st level constructs ‘IT Support’ and ‘Production Philosophy’ are described by complexity of ‘Process’ and ‘Manufacturing Process’, respectively.*

The SCRM Practices

Overall the SCRM practices seem to be quite immature as they are mostly implied/informal – and the practices are (with few exceptions) reactive instead of proactive. There seem to be a very low level of coordination of structure and process risks – and procedures for risk identification and assessment seem to be almost absent. In relation to supplier risk management a certain level of audits are performed; on the other hand the segmentation of suppliers is somewhat less rigorous than expected.

Conclusion E-3: *The SCRM practices investigated seem to be quite immature. Practices are (with few exceptions) reactive instead of proactive.*

Also the SCRM practices are mapped against the external conditions:

Conclusion E-4: *The external conditions do not seem to “predict” the overall SCRM practices well. The 1st level construct ‘Risk Management Organization’ is described by ‘Size’.*

SCM versus SCRM

Following the investigation of the SCM and SCRM practices the relationship implied by Perrow (see Figure 1-1) between the two is investigated:

Conclusion E-5: *The relationship between SCM and SCRM practices implied by Perrow seems to be supported.*

Superimposing a categorization onto the model classifies the practices:

Conclusion E-6: *Most practices are classified as ‘Safe’ – only three (LINAK, Novozymes, and Oticon) are classified as ‘Risky’.*

Later questions as to the validity of the SCRM scale result in a reclassification of the practices:

Conclusion E-7: *When adjusting the SCRM scale most practices (six) are classified as ‘Risky’ with Oticon being close to ‘Extremely Risky’.*

This may be a more accurate classification albeit it naturally is very subjective.

Appropriateness of Practices

Querying the interviewees for appropriateness of their practices revealed the companies were split in two groups: companies with low or none SCRM claiming appropriateness of their practice and companies with some SCRM and SCM practice in place. Except for Novozymes the latter group of companies was quite hesitant to claim appropriateness as practices (especially SCM) were perceived as evolving with no determined “end-goal”. This led to the conclusions:

Contribution E-8: With the exception of Novozymes appropriateness is only claimed where a practice is absent (or nearly absent). In all other instances practices are perceived as evolving – and since no “industry-standard” exists appropriateness is not claimed.

At Novozymes appropriateness is claimed measuring planned implementation of SCM with the actual practice. Their claim is thereby in this sense different from the rest of the case companies?

Triangulations

In line with the method applied consequently from the first pilot study onwards triangulations are performed on this part of the study as well. Two triangulations are performed: first the annual accounts for the case companies are analyzed, and thereafter an alternative perspective on risk management is obtained.

The first triangulation, the analysis of the annual accounts, do little in terms of validating the findings on the correlations between the SCM and Risk Management practices but documents the appearance of SCM in the external reporting. As hypothesized in the analysis this may indicate a start to Supply Chain Strategizing?

The second triangulation sheds a bit more light over the subject as several practices of ERM (Enterprise Risk Management) were identified. The interviewed personnel either ignore the existence of this practice, consider it irrelevant in relation to the study, or perhaps the researcher inadvertently has discouraged the interviewees to share insights on this practice. Whatever the reason for omission these findings are quite intriguing as they demonstrate a higher level of risk awareness than documented in the main study. On the other hand it raises questions on communication and on the most appropriate approach to ERM?

A Final Sanity Check

As a final sanity check the interview round with consultancies is repeated in order to get an understanding of the development of the market for consultancy on Business Risk Management⁴. Since the original study consultancies have become more interested in sharing their experience (albeit not in detail). In the first round three of ten consultancies gave an interview, in the second all ten participates. In the timeframe between the two rounds of

⁴ For details, please see Appendix M.

inquiries either the practice of collaborating with research institutions has changed or the subject has attracted more (commercial) interest.

Also in terms of actually working with Business Risk Management a radical shift has taken place as half the companies report working on some risk management framework⁵. PwC is still the market leader (or so it seems) as they are responsible for the continued development of the COSO framework (as also reporting in Appendix B). AT Kearney reports working on a framework for “Excellence in Risk Management”, COWI works on a “Risk and Opportunities Check”, and Ernst & Young reports working on a “Risk Universe” – a concept allegedly comparable to the COSO framework. Only Marsh Consulting reports working on a framework combining SCM and Risk Management. Unfortunately contact was never made with the responsible person at Marsh...

Commercial demand for Business Risk Management has increased – and consultancies are spending considerable resources in developing frameworks to address the commercial demand...

Contribution E-9: Commercial interest in Business Risk Management has risen over the last couple of years – and consultancies are addressing this demand through the development of various frameworks. Only one consultancy focuses on developing a framework combining SCM and Risk Management.

9.1.6 Policy Implications / Modification to Theory

Adhering to the method depicted in Figure 6-1 the cross-case analysis is followed by modification to theory and/or policy implications.

External Conditions

As documented above the theory (as defined through the external conditions) only to a very limited extent has been able to “predict” the outcome of the cross-case analysis. Only ‘SCM Award’ (quite foreseeable) seems to influence the SCM practice – none of the others seems to. For the SCRM practices the external condition ‘Size’ seems to predict the level of formalization of the risk management organization.

Constructs

An alternative explanation is naturally that the constructs for SCM and SCRM are incorrect. Even taking the sampling method applied into consideration the lack of process orientation is striking – and so is the lack of inter-organizational management. For SCRM the overall finding is that the practice is almost absent (but emerging?).

⁵ For a summary, please see Table M-2 in Appendix M.

Modifications to Theory

It is evident almost all the external conditions should be thoroughly revised as they relate so poorly to the cases investigated. The relative low rate of implementation of process orientation and near absence of inter-organizational management constitutes justification for alternative theory. It should be investigated if practices of SCM actually rely on cross-department (inter-organizational) processes and if shared management is still desired. The rest of the findings are too diverse to pose alternative theory, but it seems evident more insight into the practices of SCM and SCRM is needed.

9.2 Concerns...

Upon completing the study certain concerns have arisen.

9.2.1 Concerns on Assumptions

As documented in Chapter 1 and Chapter 2 the study relies on a number of assumptions, and two of those have become issues of concern.

More SCM -> More Risk

One of the fundamental assumptions is “more SCM leads to more Risk” (or rather: higher impact of a failure). As documented in Chapter 7 the SCM practices which are in place in some of the case companies differ greatly and therefore require a (high) number of constructs to be adequately described. This constitutes an opportunity, upon establishing the validity and completeness of such a SCM construct hierarchy (see also Chen & Paulraj, 2004), to map out how each of these construct impact the risk situation of a company. Understanding the risk impact of the various mechanisms will enable a more structured development of the SCM and SCRM practices.

Aversion Two: Innovation versus Operations

Aversion one and three did not seem to cause any problems during the study but aversion two became problematic during the analysis as innovation revealed itself as a risk mitigation mechanism. The study contains examples of companies using innovation to attract the attention of the much larger suppliers of whom they are dependent.

As documented in the Bang & Olufsen and Brüel & Kjør cases innovation is quite important in maintaining relationships with much larger suppliers. The opposite situation is documented in e.g. the Coloplast case study where Coloplast is unable to influence BASF. Another aspect of innovation in relation to SCM is the impact on customer relationships. Innovating with customers gives ample opportunity to lock-in customers – and to use customers’ knowledge and experiences in adapting specific solution into the generic offerings. It therefore becomes a bit problematic to persist innovation is separate from SCM.

9.2.2 Concerns on Literature Reviews

Despite the considerable efforts gone into the literature reviews documented in Chapter 3 and Chapter 4 (and Appendices D, E, and F) the comparison of theme ‘Supply Chain Design’ from Chapter 3 and the net result of the study on ‘Supply Chain Design’ illustrates how illusory the concept of completeness is. A concern is naturally that critically important contributions are not included – and the claim of “completeness” is invalid.

9.2.3 Concerns on Empirical Research Design

Also on the empirical research design a few concerns have arisen.

Stuck in the Middle

The most important concern in relation to the empirical research design is the diversity across practices compared to the number of case companies. The case collection method ensures a certain breadth according to the chosen external conditions but analysing the empirical findings results in few and vague conclusions. So on the one hand the case selection method ensures breadth, on the other hand it weakens the strength of the conclusions as diversity was broader than expected.

In retrospect it seems more appropriate to either focus on few in-depth case studies or a higher number of less thorough case studies – but this finding is naturally influenced by the diversity of the practices investigated. In case clear configurations had emerged from the analysis perhaps this concern would not have emerged.

Interviews versus Participation

Related to the previous concern is the investigation method. Even if a substantial effort went into creating a trusting relationship between interviewer and interviewees it is obvious problems occurred during the interviews. In some cases it was problematic to continue the discussion on supplier management after identifying the current practice on supplier segmentation⁶. In most companies interviewees were quite generous with their time, though.

Another problem was the inability to unravel the biases experienced: in one company three interviewees all had distinctly different recollections of the exit of a critical supplier. Researching “from a distance” as is the case with the interview method (Yin, 1994) left the researcher to subjectively qualify one explanation over others.

Lastly the subject in itself emphasized the necessity of establishing a trusting relationship between interviewer and interviewees. Expanding the population of interviewees in the second empirical triangulation might thereby have been an unwise decision.

⁶ The lack of stringency in segmenting the supplier base was quite surprising to the researcher (but in line with e.g. Zsidisin et al. (2004)). This may have discouraged the Purchasing personnel in a few of the case companies from contributing further in the study.

Researching a Moving Target

Also the duration of the study caused some problems as the SCM and/or SCRM practice in some of the case companies have developed during the data collection. This concern is further emphasized by the time delay between the final data collection and the publication of the research. In at least three of the case companies the SCM practice has developed quite a bit since the last interview – and presumably the SCRM practice might have done the same...

9.3 Future Research

In line with above described concerns the author considers the following issues important for future research.

Construct Hierarchies

In order to improve the validity and quality of research into SCM practices a better conceptual understanding of the empirical domain is needed (e.g. Burgess, Singh, & Koroglu, 2006; Gripsrud, Jahre, & Persson, 2006). Further research on the constructs and measurements of SCM will benefit the entire domain as it will enable a more operational definition of SCM. Allowing for the relative immaturity of the SCRM practice the construct hierarchy put forward should be developed further, e.g. by comparing with existing frameworks (e.g. COSO, Corporate Governance, IFRS etc.) and subsequently confronting the resulting hierarchy with empirical data. As mentioned previously an analysis of the risk mechanisms relating to each SCM sub-construct will aid in developing a conceptual model of Supply Chain Risk Management – extending beyond the Supply Chain Risk Matrix put forward in this manuscript.

The Relevance of Contracts

One of the classical risk mitigation mechanisms, the contract, has not been included in this study as the first three companies contacted emphasized their disinterest in sharing this information. In several of the case studies a certain level of information has been revealed, though, indicating in certain companies the portfolio of contracts may not cover the entire supplier base and scope of operation. Even if some researchers consider contract irrelevant in long-term B-2-B relationships (as the formal contracts in reality are non-enforceable) it will prove critically relevant to understand which options in terms of formal contracts are applicable when managing the supply chain risks. Especially in terms of establishing a balanced dependency the contracts may offer options not found elsewhere by introducing e.g. lump sum payments, formalize consignment inventory etc.

Quantifying the Risks and Benefits

Building on above it may improve the understanding of risks and benefits if these are quantified as in Norrman & Jansson (2004). The use of Business Interruption Value (BIV) may prove a lasting concept within Supply Chain Design.

Diseconomies of Innovation

As documented in Chapter 7 several of the companies have been forced to outsource strategically important activities – either due to financial problems or due to an increase in the cost of maintaining a lead within that specific technology (or discipline). For both Brüel & Kjør and Bang & Olufsen this has placed the company in a situation where being at the cutting edge is crucial in remaining an attractive customer. The increased speed and cost of innovation thereby increases the relevance of managing supply chain risks.

As many Danish companies have the challenge of being dependent on suppliers many times bigger than themselves it is critically important to better understand the process of outsourcing cutting edge technology (or processes or products) – to avoid unnecessary dependencies and costly risk mitigation strategies...

Bibliography

- Aaker, D. A. (1989), "Managing Assets and Skills: The Key To a Sustainable Competitive Advantage", *California Management Review*, vol. 31, no. 2, pp. 91-106.
- Abdinnour-Helm, S. (1999), "Network design in supply chain management", *International Journal of Agile Management Systems*, vol. 1, no. 2, pp. 99-106.
- Agrell, P. J., Lindroth, R., & Norrman, A. (2004), "Risk, information and incentives in telecom supply chains", *International Journal of Production Economics*, vol. 90, no. 1, pp. 1-16.
- Akkermans, H. A., Bogerd, P., Yücesan, E., & Van Wassenhove, L. N. (2003), "The impact of ERP on supply chain management: Exploratory findings from a European Delphi study", *European Journal of Operational Research*, vol. 146, no. 2, pp. 284-301.
- Albino, V. & Garavelli, A. C. (1995), "A methodology for the vulnerability analysis of just-in-time production systems", *International Journal of Production Economics*, vol. 41, no. 1-3, pp. 71-80.
- Amit, R. & Schoemaker, P. J. H. (1993), "Strategic Assets and Organisational Rent", *Strategic Management Journal*, vol. 14, no. 1, pp. 33-46.
- Anderson, M. G. & Katz, P. B. (1998), "Strategic sourcing", *International Journal of Logistics Management*, vol. 9, no. 1, pp. 1-13.
- Andrews, D. C. & Stalick, S. K. (1994), *Business Reengineering: The Survival Guide*, 1. edn, Yourdon Press, Englewood Cliffs, NJ.
- Anumba, C. J., Siemieniuch, C. E., & Sinclair, M. A. (2000), "Supply chain implications of concurrent engineering", *International Journal of Physical Distribution & Logistics Management*, vol. 30, no. 7, pp. 566-597.
- Arbnor, I. & Bjerke, B. (1997), *Methodology for Creating Business Knowledge*, 2. edn, SAGE Publications, Thousand Oaks (CA), London and New Delhi.
- Arcelus, F. J., Pakkala, T. P. M., & Srinivasan, G. (2002), "A purchasing framework for B2B pricing decisions and risk-sharing in supply chains", *Decision Sciences*, vol. 33, no. 4, pp. 645-666.
- Arrow, K. J. (1963), "Uncertainty and the Welfare Economics of Medical Care", *American Economic Review*, vol. 53, no. 5, pp. 941-973.
- Arrow, K. J. (1965), *Aspects of the Theory of Risk-Bearing*, Yrjo Johnssonin Saatio, Helsinki.
- Arrow, K. J. (1969), "The Organization of Economic Activity: Issues Pertinent to the Choice of Market versus Nonmarket Allocation", in *The Analysis and Evaluation of Public Expenditures: The PPB System*, Joint Economic Committee, Washington, D.C., pp. 47-64.
- Auramo, J., Kauremaa, J., & Tanskanen, K. (2005), "Benefits of IT in supply chain management: an explorative study of progressive companies", *International Journal of Physical Distribution & Logistics Management*, vol. 35, no. 2, pp. 82-100.
- Bagchi, P. K., Chun, B., Skjøtt-Larsen, T., & Sørensen, L. B. (2005), "Supply chain integration: a European survey", *International Journal of Logistics Management*, vol. 16, no. 2, pp. 275-294.
- Bagchi, P. K. & Skjøtt-Larsen, T. (2002a), "Integration of Information Technology and Organizations in a Supply Chain", *International Journal of Logistics Management*, vol. 14, no. 1, pp. 89-108.
- Bagchi, P. K. & Skjøtt-Larsen, T. (2002b), "Organizational Integration in Supply Chains: A Contingency Approach", *Global Journal of Flexible Systems Management*, vol. 3, no. 1, pp. 1-10.
- Bagchi, P. K., Skjøtt-Larsen, T., & Sørensen, L. B. (2003), "Organizational Integration in Supply Chains", in *Proceedings of NOFOMA 2003*, J. Juga, ed., Oulu, Finland, pp. 11-25.
- Bain, J. S. (1956), *Barriers to New Competition: Their Character and Consequences in Manufacturing Industries*, Harvard University Press, Cambridge.
- Baldwin, C. Y. & Clark, K. B. (1997), "Managing in the Age of Modularity", *Harvard Business Review*, vol. 75, no. 5, pp. 84-93.

- Banks, E. & Dunn, R. (2003), *Practical Risk Management*, John Wiley & Sons, Chichester, West Sussex.
- Barlow, D. (1993), "The Evolution of Risk Management", *Risk Management*, vol. 40, no. 4, pp. 38-45.
- Barney, J. (1991), "Firm resources and sustained competitive advantage", *Journal of Management*, vol. 77, no. 1, pp. 99-119.
- Barney, J. B. (1999), "How a Firm's Capabilities Affect Boundary Decisions", *Sloan Management Review*, vol. 40, no. 3, pp. 137-145.
- Bartezzaghi, E. & Verganti, R. (1995), "Managing demand uncertainty through order overplanning", *International Journal of Production Economics*, vol. 40, no. 2-3, pp. 107-120.
- Bask, A. H. & Juga, J. (2001), "Semi-integrated Supply Chains: Towards the New Era of Supply Chain Management", *International Journal of Logistics: Research and Applications*, vol. 4, no. 2, pp. 137-152.
- Bechtel, C. & Jayaram, J. (1997), "Supply Chain Management: A Strategic Perspective", *International Journal of Logistics Management*, vol. 8, no. 1, pp. 15-34.
- Bell, J. (1993), *Doing Your Research Project - A Guide for First-Time Researchers in Education and Social Science*, 2. edn, Open University Press, Buckingham.
- Bensaou, M. & Anderson, E. (1999), "Buyer-Supplier Relations in Industrial Markets: When Do Buyers Risk Making Idiosyncratic Investments?", *Organization Science*, vol. 10, no. 4, pp. 460-481.
- Benson-Rea, M. & Wilson, H. (2003), "Networks, Learning and the Lifecycle", *European Management Journal*, vol. 21, no. 5, pp. 588-597.
- Bernhard, B. (1988), *The origin of Denmark's large companies (Sådan skabtes Danmarks store virksomheder)*, Erhvervs-Bladets Forlag, Copenhagen.
- Blackhurst, J., Wu, T., & O'Grady, P. (2005), "PCDM: a decision support modeling methodology for supply chain, product and process design decisions", *Journal of Operations Management*, vol. 23, no. 3-4, pp. 325-343.
- Blatherwick, A. (1999), "Vendor-managed inventory: fashion fad or important supply chain strategy?", *Supply Chain Management: An International Journal*, vol. 3, no. 1, pp. 10-11.
- Boardman, J. T. & Clegg, B. T. (2001), "Structured engagement in the extended enterprise", *International Journal of Operations & Production Management*, vol. 21, no. 5/6, pp. 795-811.
- Boronico, J. S. & Bland, D. J. (1996), "Customer service: the distribution of seasonal food products under risk", *International Journal of Physical Distribution & Logistics Management*, vol. 26, no. 1, pp. 25-39.
- Bowersox, D. J., Stank, T. P., & Daugherty, P. J. (1999), "Lean Launch: Managing Product Introduction Risk Through Response-Based Logistics", *Journal of Product Innovation Management*, vol. 16, no. 6, pp. 557-568.
- Boyson, S. & Corsi, T. (2001), "The Real-Time Supply Chain", *Supply Chain Management Review*, vol. 5, no. 1, pp. 44-50.
- Bundgaard, M. (2001), "Knutsen er en helt", *Børsens Nyhedsmagasin*, vol. 17, no. 15, p. 72.
- Bunn, M. D. & Liu, B. S.-C. (1996), "Situational Risk in Organizational Buying: A Basis for Adaptive Selling", *Industrial Marketing Management*, vol. 25, no. 6, pp. 439-452.
- Burgess, K., Singh, P. J., & Koroglu, R. (2006), "Supply chain management: a structured literature review and implications for future research", *International Journal of Physical Distribution & Logistics Management*, vol. 26, no. 7, pp. 703-729.
- Callarman, T. E. & Hamrin, R. S. (1984), "A Comparison of Dynamic Lot Sizing Rules for Use in a Single Stage MRP System with Demand Uncertainty", *International Journal of Operations & Production Management*, vol. 4, no. 2, pp. 39-48.
- Carroll, J. S. (2004), "Redundancy as a Design Principle and an Operating Principle", *Risk Analysis*, vol. 24, no. 4, pp. 955-957.

- Caves, R. & Porter, M. E. (1977), "From entry barriers to mobility barriers: conjectural decisions and contrived deterrence to new competition", *Quarterly Journal of Economics*, vol. 91, no. 2, pp. 241-261.
- Cavinato, J. L. (2004), "Supply chain logistics risks - from the back room to the board room", *International Journal of Physical Distribution & Logistics Management*, vol. 34, no. 5, pp. 383-387.
- Chandra, C. & Kumar, S. (2000), "An application of a system analysis methodology to manage logistics in a textile supply chain", *Supply Chain Management: An International Journal*, vol. 5, no. 5, pp. 234-245.
- Chen, I. J. & Paulraj, A. (2004), "Towards a theory of supply chain management: the constructs and measurements", *Journal of Operations Management*, vol. 22, no. 3, pp. 119-150.
- Chopra, S. & Sodhi, M. S. (2004), "Managing Risk To Avoid Supply-Chain Breakdown", *Sloan Management Review*, vol. 46, no. 1, pp. 52-61.
- Christiaanse, E. & Kumar, K. (2000), "ICT-enabled coordination of dynamic supply webs", *International Journal of Physical Distribution & Logistics Management*, vol. 30, no. 3, pp. 268-285.
- Christopher, M. (1992), *Logistics - the strategic issues*, Chapman & Hall, London.
- Christopher, M. (1998), *Logistics and Supply Chain Management: Strategies for reducing cost and improving service*, Pitman Publishing, London.
- Christopher, M. & Lee, H. L. (2004), "Mitigating supply chain risk through improved confidence", *International Journal of Physical Distribution & Logistics Management*, vol. 34, no. 5, pp. 388-396.
- Christopher, M. & Towill, D. R. (2001), "An integrated model for the design of the agile supply chains", *International Journal of Physical Distribution & Logistics Management*, vol. 31, no. 4, pp. 235-246.
- Christopher, M. & Towill, D. R. (2002), "Developing market specific supply chain strategies", *International Journal of Logistics Management*, vol. 13, no. 1, pp. 1-14.
- Coase, R. H. (1937), "The Nature of the Firm", *Economica*, vol. 4, no. 16, pp. 386-405.
- Coase, R. H. (1988), "The Nature of the Firm: Influence", *Journal of Law, Economics, and Organizations*, vol. 4, no. 1, pp. 33-47.
- Collis, D. (1992), "The Strategic Management of Uncertainty", *European Management Journal*, vol. 10, no. 2, pp. 125-135.
- Coloplast (2004), *Coloplast - Annual Report 2003/04*, Coloplast, Humlebæk, Denmark.
- Coloplast (2005a), www.coloplast.com, "Corporate Governance", accessed 2005-10-31a.
- Coloplast (2005b), www.coloplast.com, "Managing business risk", accessed 2005-10-30b.
- Commons, J. R. (1934), *Institutional Economics*, University of Wisconsin Press, Madison.
- Conner, K. R. (1991), "A historical comparison of resource-based theory and five schools of thought within industrial organization economics: Do we have a new theory of the firm?", *Journal of Management*, vol. 17, no. 1, pp. 155-171.
- Cooper, M. C., Lambert, M. D., & Pagh, J. D. (1997), "Supply Chain Management: More Than a New Name for Logistics", *International Journal of Logistics Management*, vol. 8, no. 1, pp. 1-14.
- Cooper, M. C. & Ellram, L. M. (1993), "Characteristics of Supply Chain Management and the Implications for Purchasing and Logistics Strategy", *International Journal of Logistics Management*, vol. 4, no. 2, pp. 13-24.
- Cooper, M. C. & Gardner, J. T. (1993), "Building Good Business Relationships: More than just Partnerships or Strategic Alliances?", *International Journal of Physical Distribution & Logistics Management*, vol. 23, no. 6, pp. 14-26.
- Croom, S., Romano, P., & Giannakis, M. (2000d), "Supply chain management: an analytical framework for critical literature review", *European Journal of Purchasing & Supply Management*, vol. 6, no. 1, pp. 67-83.

- Croom, S., Romano, P., & Giannakis, M. (2000b), "Supply chain management: an analytical framework for critical literature review", *European Journal of Purchasing & Supply Management*, vol. 6, no. 1, pp. 67-83.
- Croom, S., Romano, P., & Giannakis, M. (2000a), "Supply chain management: an analytical framework for critical literature review", *European Journal of Purchasing & Supply Management*, vol. 6, no. 1, pp. 67-83.
- Croom, S., Romano, P., & Giannakis, M. (2000c), "Supply chain management: an analytical framework for critical literature review", *European Journal of Purchasing & Supply Management*, vol. 6, no. 1, pp. 67-83.
- Dahlager, L. (2005/06/08), "Norwegian Hospital presses bribery charges against danish company (Norsk hospital politianmelder dansk firma for bestikkelse)", *Politiken*, Copenhagen, 2005/06/08, p. 15.
- Davenport, T. H. (1993), *Process Innovation, Reengineering Work through Information Technology*, 1. edn, Harvard Business School Press, Boston, Massachusetts.
- Davis, T. (1993), "Effective Supply Chain Management", *Sloan Management Review*, vol. 34, no. 4, pp. 35-46.
- DeLoach, J. W. (2000), *Enterprise-wide Risk Management - strategies for linking risk and opportunity*, PrenticeHall, London.
- Denzler, D. R., Boe, W. J., & Duplaga, E. (1987), "An Experimental Investigation of FMS Scheduling Rules Under Uncertainty", *Journal of Operations Management*, vol. 7, no. 1-2, pp. 139-151.
- Dershin, H. (2000), "Business Process Design - Completing the DNA", *Supply Chain Management Review*, vol. 4, no. 2, pp. 74-82.
- Dierickx, I. & Cool, K. (1989), "Asset stock accumulation and sustainability of competitive advantage", *Management Science*, vol. 35, no. 12, pp. 1504-1511.
- Doherty, N. A. (2000), *Integrated Risk Management - Techniques and Strategies for Managing Corporate Risk*, McGraw-Hill, New York.
- Dyer, J. H. (1997), "Effective Interfirm Collaboration: How Firms Minimize Transaction Costs and Maximize Transaction Value", *Strategic Management Journal*, vol. 18, no. 7, pp. 535-556.
- Dyer, W. G. J. & Wilkins, A. J. (1991), "Better stories, not better constructs, to generate better theory: A rejoinder to Eisenhardt", *Academy of Management Review*, vol. 16, no. 3, pp. 613-619.
- Dyrup (2004), *Dyrup A/S - Annual Report 2003*, Dyrup, Søborg, Denmark.
- Dyrup (2005), *Dyrup A/S - Annual Report 2004*, Dyrup, Søborg, Denmark.
- Easton, G. (1992), "Industrial networks: a review", in *Industrial Networks: A New View of Reality*, B. Axelsson & G. Easton, eds., Routledge, London, pp. 3-27.
- Eisenhardt, K. M. (1989a), "Agency Theory: An Assessment and Review", *Academy of Management Review*, vol. 14, no. 1, pp. 57-74.
- Eisenhardt, K. M. (1989b), "Building Theories from Case Study Research", *Academy of Management Review*, vol. 14, no. 4, pp. 532-550.
- Eisenhardt, K. M. (1991), "Better stories and better constructs: The case for rigor and comparative logic", *Academy of Management Review*, vol. 16, no. 3, pp. 620-627.
- Eisenhardt, K. M. & Martin, J. A. (2000), "Dynamic Capabilities: What Are They?", *Strategic Management Journal*, vol. 21, no. 10-11, pp. 1105-1121.
- Elkington, J. (1998), *Cannibals with Forks: The Triple Bottom Line of the 21st Century Business*, New Society Publishers, Stony Creek, CT.
- Ellram, L. M. & Cooper, M. C. (1990), "Supply Chain Management, Partnership, and the Shipper-Third Party Relationship", *International Journal of Logistics Management*, vol. 1, no. 2, pp. 1-10.
- Emen, Michael S. (2004), www.nasdaq.com/about/ViewFromNASDAQ_EmenArticle_032304.pdf, "Corporate Governance - The View from NASDAQ", accessed 2005-12-30.

- Emmelhainz, L. W. & Stock, J. R. (1989), "An evaluation of logistics and related journals", *International Journal of Physical Distribution & Logistics Management*, vol. 19, no. 12, pp. 40-45.
- Englehart, J. P. (1994), "A Historical Look at Risk Management", *Risk Management*, vol. 41, no. 3, pp. 65-71.
- Erhardtson, B. (2000), "B&O's technology baby (B&O's teknologi-baby)", *Børsens Nyhedsmagasin*, vol. 16, no. 22, pp. 28-30.
- Etienne, E. C. (1987), "Choosing Optimal Buffering Strategies for Dealing with Uncertainty in MRP", *Journal of Operations Management*, vol. 7, no. 1-2, pp. 107-120.
- Evert, E. (1999), "Knutsen shines through (Knutsen blænder op)", *Børsens Nyhedsmagasin*, vol. 15, no. 4, pp. 14-18.
- Fama, E. F. & Jensen, M. C. (1983a), "Agency Problems and Residual Claims", *Journal of Law & Economics*, vol. 26, no. 327, p. 350.
- Fama, E. F. & Jensen, M. C. (1983b), "Separation of Ownership and Control", *Journal of Law & Economics*, vol. 26, no. 2, pp. 301-326.
- Fawcett, S. E. & Magnan, G. M. (2002), "The rhetoric and reality of supply chain integration", *International Journal of Physical Distribution & Logistics Management*, vol. 32, no. 5, pp. 339-361.
- Fawcett, S. E., Vellenga, D. B., & Truitt, L. J. (1995), "An Evaluation of Logistics and Transportation Professional Organizations, Programs, and Publications", *Journal of Business Logistics*, vol. 16, no. 1, pp. 299-314.
- Ferdows, K., Lewis, M. A., & Machuca, J. A. D. (2004), "Rapid-Fire Fulfillment", *Harvard Business Review*, vol. 82, no. 11, pp. 104-110.
- Fine, C. H. (2000b), "Clockspeed-based Strategies for Supply Chain Design", *Production and Operations Management*, vol. 9, no. 3, pp. 213-221.
- Fine, C. H. (2000a), "Clockspeed-based Strategies for Supply Chain Design", *Production and Operations Management*, vol. 9, no. 3, pp. 213-221.
- Fine, C. H., Golany, B., & Naseraldin, H. (2005), "Modeling tradeoffs in three-dimensional concurrent engineering: a goal programming approach", *Journal of Operations Management*, vol. 23, no. 3-4, pp. 389-403.
- Fisher, M. (1997), "What is the right Supply Chain for your product?", *Harvard Business Review*, vol. 75, no. 2, pp. 105-116.
- Fliedner, G. (2003), "CPFR: an emerging supply chain tool", *Industrial Management & Data Systems*, vol. 103, no. 1, pp. 14-21.
- Fondsbørsen (2003), *Report on good corporate governance in Denmark (Rapport om god selskabsledelse i Danmark)*, Copenhagen Stock Exchange, Copenhagen.
- Fondsbørsen (2005), *Report on good corporate governance in Denmark 2005 (Rapport om god selskabsledelse i Danmark 2005)*, Copenhagen Stock Exchange, Copenhagen.
- Ford, D. (1980), "The Development of Buyer-Seller Relationships in Industrial Markets", *European Journal of Marketing*, vol. 14, no. 5/6, pp. 339-354.
- Ford, D. (2000), *Understanding Business Markets*, 2. edn, Thomson Learning, London.
- Ford, D., Håkansson, H., & Johanson, J. (1986), "How Do Companies Interact?", *Industrial Marketing and Purchasing*, vol. 1, no. 1, pp. 26-41.
- Forrester, J. (1961), *Industrial Dynamics*, MIT Press, Cambridge, MA.
- Forza, C., Romano, P., & Vinelli, A. (2000), "Information Technology for Managing the Textile Apparel Chain: Current Use, Shortcomings and Development Directions", *International Journal of Logistics: Research and Applications*, vol. 3, no. 3, pp. 227-243.
- Foss, N. J. (1997), *Resources, Firms and Strategies*, Oxford University Press, New York / Oxford.
- Fowler, A. (1998), "Operations management and systemic modelling as frameworks for BPR", *International Journal of Operations & Production Management*, vol. 18, no. 9/10, pp. 1028-1056.

- Frankel, R., Naslund, D., & Bolumole, Y. (2005), "The 'White Space' of Logistics Research: A Look at The Role of Methods Usage", *Journal of Business Logistics*, vol. 26, no. 2, pp. 185-208.
- Frohlich, M. T. & Westbrook, R. (2001), "Arcs of integration: an international study of supply chain strategies", *Journal of Operations Management*, vol. 19, no. 2, pp. 185-200.
- Gallagher, R. B. (1956), "Risk Management: New Phase of Cost Control", *Harvard Business Review*, vol. 34, no. 5, pp. 75-86.
- Gammelgaard, B. (2004), "Schools in logistics research? - A methodological framework for analysis of the discipline", *International Journal of Physical Distribution & Logistics Management*, vol. 34, no. 6, pp. 479-491.
- Gardner, J. T. & Cooper, M. C. (2003), "Strategic Supply Chain Mapping Approaches", *Journal of Business Logistics*, vol. 24, no. 2, pp. 37-64.
- Geary, S., Childerhouse, P., & Towill, D. R. (2002), "Uncertainty and the Seamless Supply Chain", *Supply Chain Management Review*, vol. 6, no. 4, pp. 52-61.
- Ghuri, P., Grønhaug, K., & Kristianslund, I. (1995), *Research Methods in Business Studies - a practical guide*, 2. edn, Prentice Hall, Harlow, Essex, UK.
- Ghoshal, S. & Moran, P. (1996), "Bad for practice: A critique of the transaction cost theory", *Academy of Management Review*, vol. 21, no. 1, pp. 13-47.
- Giannakis, M., Croom, S., & Slack, N. (2004), "Supply Chain Paradigms", in *Understanding Supply Chains - Concepts, Critiques and Futures*, S. New & R. Westbrook, eds., Oxford University Press, Oxford, pp. 1-21.
- Gibson, B. J. & Hanna, J. B. (2003), "Periodical Usefulness: The U.S. Logistics Educator Perspective", *Journal of Business Logistics*, vol. 24, no. 1, pp. 221-240.
- Gibson, B. J., Mentzer, J. T., & Cook, R. L. (2005), "Supply Chain Management: The Pursuit of a Consensus Definition", *Journal of Business Logistics*, vol. 26, no. 2, pp. 17-25.
- Gilmore, J. H. & Pine, B. J. (1997), "The Four Faces of Mass Customization", *Harvard Business Review*, vol. 75, no. 1, pp. 91-101.
- Grabowski, M. & Roberts, K. (1997), "Risk Mitigation in Large-Scale Systems: Lessons From High Reliability Organizations", *California Management Review*, vol. 39, no. 4, pp. 152-162.
- Grabowski, M. & Roberts, K. (1999), "Risk Mitigation in Virtual Organizations", *Organization Science*, vol. 10, no. 6, pp. 704-721.
- Grant, R. M. (1991), "The Resource-Based Theory of Competitive Advantage: Implications for Strategy Formulation", *California Management Review*, vol. 33, no. 3, pp. 114-135.
- Gripsrud, G., Jahre, M., & Persson, G. (2006), "Supply chain management - back to the future?", *International Journal of Physical Distribution & Logistics Management*, vol. 36, no. 8, pp. 643-659.
- Groes, J. (1991), "Tough round (Barsk omgang)", *Børsens Nyhedsmagasinet*, vol. 7, no. 22, pp. 20-23.
- Guide Jr, V. D. R. & Srivastava, R. (2000), "A review of techniques for buffering against uncertainty with MRP systems", *Production Planning & Control*, vol. 11, no. 3, pp. 223-233.
- Guide Jr, V. D. R. & Van Wassenhove, L. N. (2002), "The Reverse Supply Chain", *Harvard Business Review*, vol. 80, no. 5, pp. 25-26.
- Gupta, D., Gerchak, Y., & Buzacott, J. A. (1992), "The optimal mix of flexible and dedicated manufacturing capacities: Hedging against demand uncertainty", *International Journal of Production Economics*, vol. 28, no. 3, pp. 309-319.
- Håkansson, H. & Johanson, J. (1992), "A Model of Industrial Networks", in *Industrial Networks: A New View of Reality*, B. Axelsson & G. Easton, eds., Routledge, London, pp. 28-34.
- Håkansson, H. & Snehota, I. (1989), "No business is an island: the network concept of business strategy", *Scandinavian Journal of Management*, vol. 5, no. 3, pp. 187-200.

- Håkansson, H. & Snehota, I. (1994), "Analysing Business Relationships", in *Developing Relationships in Business Networks*, H. Håkansson & I. Snehota, eds., Routledge, London, pp. 24-49.
- Håkansson, H., Johanson, J., & Wootz, B. (1976), "Influence tactics in buyer-seller processes", *Industrial Marketing Management*, vol. 5, no. 6, pp. 319-332.
- Hald, K. S. & Hedegaard, O. (2004), "William Demant Holding A/S", in *Eksamenscases i Erhvervsøkonomi 2003-2004*, M. Havsteen & O. Hedegaard, eds., Forlaget Focus, Copenhagen, pp. 97-116.
- Halldorsson, A., Kotzab, H., Mikkola, J. H., & Skjøtt-Larsen, T. (2004), "Design and managing supply chains: theoretical foundation and application", in *Proceedings of NOFOMA 2004*, H. Aronsson, ed., Linköping, Sweden, pp. 247-262.
- Hallikas, J., Karvonen, I., Pulkkinen, U., & Virolainen, V.-M. (2004), "Risk management processes in supplier networks", *International Journal of Production Economics*, vol. 90, no. 1, pp. 47-58.
- Hallikas, J., Virolainen, V.-M., & Tuominen, M. (2002), "Risk analysis and assessment in network environments: A dyadic case study", *International Journal of Production Economics*, vol. 78, no. 1, pp. 45-55.
- Hammel, T., Kuettner, D., & Phelps, T. (2002), "The re-engineering of Hewlett-Packard's CD-RW supply chain", *Supply Chain Management: An International Journal*, vol. 7, no. 3, pp. 113-118.
- Hammel, T. R. & Kopczak, L. R. (1993), "Tightening the supply chain", *Production and Inventory Management*, vol. 34, no. 2, pp. 63-70.
- Hammer, M. (1996), *Beyond Reengineering*, Harper Collins Publishers, London.
- Hammer, M. & Champy, J. (1993), *Reengineering the Corporation - a manifesto for business revolution*, Nicholas Brealey, London.
- Hammer, M. I. (1990), "Reengineering Work: Don't Automate, Obliterate", *Harvard Business Review*, vol. 68, no. 4, pp. 104-112.
- Handfield, R. B. & Bechtel, C. (2002), "The role of trust and relationship structure in improving supply chain responsiveness", *Industrial Marketing Management*, vol. 31, no. 4, pp. 367-382.
- Harland, C., Brenchley, R., & Walker, H. (2003), "Risk in supply networks", *Journal of Purchasing and Supply Management*, vol. 9, no. 2, pp. 51-62.
- Hauser, L. M. (2003), "Risk-adjusted Supply Chain Management", *Supply Chain Management Review*, vol. 7, no. 6, pp. 64-71.
- Hedaa, L. (1996), "Customer Acquisition in Sticky Business Markets", *International Business Review*, vol. 5, no. 5, pp. 509-530.
- Hedaa, L. (1993), "Distrust, Uncertainties and Disconfirmed Expectations in Supplier-Customer Relationships", *International Business Review*, vol. 2, no. 2, pp. 191-206.
- Helbo, M., Jakobsen, J., & Gammelgaard, B. (2004), "Purchasing practices in a SCM perspective - a reader (Indkøbspraksisser i et SCM-perspektiv - en case-samling)", *Copenhagen Business School Working Papers*, no. 03/2004.
- Henthorne, T. L., LaTour, M. S., & Williams, A. J. (1993), "How Organizational Buyers Reduce Risk", *Industrial Marketing Management*, vol. 22, no. 1, pp. 41-48.
- Hertz, D. B. & Thomas, H. (1983), "Decision and Risk Analysis in a New Product and Facilities Planning Problem", *Sloan Management Review*, vol. 24, no. 2, pp. 17-31.
- Hewitt, F. (1994), "Supply Chain Redesign", *International Journal of Logistics Management*, vol. 5, no. 2, pp. 1-9.
- Hill, A. V. & Vollmann, T. E. (1986), "Reducing Vendor Delivery Uncertainties in a JIT Environment", *Journal of Operations Management*, vol. 6, no. 4, pp. 381-392.
- Hill, T. (2005), *Operations Management*, 2. edn, Palgrave Macmillan, New York.
- Hillebrand, B., Kok, R. A. W., & Biemans, W. G. (2001), "Theory-Testing Using Case Studies - A Comment on Johnston, Leach, and Liu", *Industrial Marketing Management*, vol. 30, no. 8, pp. 651-657.

- Hines, P. & Rich, N. (1997), "The seven value stream mapping tools", *International Journal of Operations & Production Management*, vol. 17, no. 1, pp. 46-64.
- Hirschman, A. O. (1970), *Exit, voice, and loyalty. Responses to decline in firms, organizations and states*, Harvard University Press, Cambridge.
- Ho, C. & Carter, P. L. (1994), "Adopting Rescheduling Capability in DRP to Deal with Operational Uncertainty in Logistics Systems", *International Journal of Logistics Management*, vol. 5, no. 1, pp. 33-42.
- Højbo, F. (1996), "B&O loses battle for budget (B&O taber kampen om budgettet)", *Børsens Nyhedsmagasin*, vol. 12, no. 10, pp. 32-33.
- Holmberg, S. (2000), "A systems perspective on supply chain measurement", *International Journal of Physical Distribution & Logistics Management*, vol. 30, no. 10, pp. 847-868.
- Holweg, M. (2005), "The three dimensions of responsiveness", *International Journal of Operations & Production Management*, vol. 25, no. 7, pp. 603-622.
- Houlihan, J. B. (1985), "International Supply Chain Management", *International Journal of Physical Distribution and Materials Management*, vol. 15, no. 1, pp. 22-38.
- Houlihan, J. B. (1988), "International Supply Chains: A New Approach", *Management Decision*, vol. 26, no. 3, pp. 13-19.
- Hunter, L. M., Kasouf, C. J., Celuch, K. G., & Curry, K. A. (2004), "A classification of business-to-business buying decisions: Risk importance and probability as a framework for e-business benefits", *Industrial Marketing Management*, vol. 33, no. 2, pp. 145-154.
- IMP Group (1982), "An Interaction Approach", in *International Marketing and Purchasing of Industrial Goods*, Wiley, Chichester, pp. 10-27.
- Inkpen, A. C. & Currall, S. C. (2004), "The Coevolution of Trust, Control, and Learning in Joint Ventures", *Organization Science*, vol. 15, no. 5, pp. 586-599.
- Iversen, J. (2004), *Legal Risk Management*, Thomson, Copenhagen.
- Javidan, M. (1998), "Core Competence: What Does it Mean in Practice?", *Long Range Planning*, vol. 31, no. 1, pp. 60-71.
- Jayaram, J., Vickery, S. K., & Droge, C. (2000), "The effects of information system infrastructure and process improvements on supply-chain time performance", *International Journal of Physical Distribution & Logistics Management*, vol. 30, no. 3/4, pp. 314-330.
- Johansen, S. G. (1999), "Lot sizing for varying degrees of demand uncertainty", *International Journal of Production Economics*, vol. 59, no. 1-3, pp. 405-414.
- Johanson, J. & Mattsson, L.-G. (1987), "Interorganizational Relations in Industrial Systems: A Network Approach Compared with the Transaction-Cost Approach", *International Studies of Management and Organizations*, vol. 17, no. 1, pp. 34-48.
- Johansson, U. & Elg, U. (2002), "Relationships as entry barriers: a network perspective", *Scandinavian Journal of Management*, vol. 18, no. 3, pp. 393-419.
- Johnson, M. E. (1998), "Giving 'em what they want", *Management Review*, vol. 87, no. 10, pp. 62-67.
- Johnson, M. E. (2001), "Learning From Toys: Lessons In Managing Supply Chain Risk From The Toy Industry", *California Management Review*, vol. 43, no. 3, pp. 106-124.
- Johnston, W. J., Leach, M. P., & Liu, A. H. (1999), "Theory Testing Using Case Studies in Business-to-Business Research", *Industrial Marketing Management*, vol. 28, no. 3, pp. 201-213.
- Jones, T. C. & Riley, D. W. (1985), "Using Inventory for Competitive Advantage through Supply Chain Management", *International Journal of Physical Distribution and Materials Management*, vol. 15, no. 5, pp. 16-26.
- Ju, X. & Pearson, N. D. (1998), "Using value-at-risk to control risk taking: how wrong can you be?", *Journal of Risk*, vol. 1, no. 2, pp. 5-36.
- Karlsson, C. (2003), "The development of industrial networks - challenges to operations management in an extraprise", *International Journal of Operations & Production Management*, vol. 23, no. 1, pp. 44-61.

- Koh, S. C. L. & Saad, S. M. (2003), "A holistic approach to diagnose uncertainty in ERP-controlled manufacturing shop floor", *Production Planning & Control*, vol. 14, no. 3, pp. 273-289.
- Kopczak, L. R. (2001), "Designing Supply Chains for the 'Click-and-Mortar' Economy", *Supply Chain Management Review*, vol. 5, no. 1, pp. 60-66.
- Korpela, J., Kyläheiko, K., Lehmusvaara, A., & Tuominen, M. (2002), "An analytical approach to production capacity allocation and supply chain design", *International Journal of Production Economics*, vol. 78, no. 2, pp. 187-195.
- Korpela, J., Lehmusvaara, A., & Tuominen, M. (2001a), "An analytic approach to supply chain development", *International Journal of Production Economics*, vol. 71, no. 1-3, pp. 145-155.
- Korpela, J., Lehmusvaara, A., & Tuominen, M. (2001b), "Customer service based design of the supply chain", *International Journal of Production Economics*, vol. 69, no. 2, pp. 193-204.
- Kouvelis, P. & Milner, J. M. (2002), "Supply chain capacity and outsourcing decisions: the dynamic interplay of demand and supply uncertainty", *IIE Transactions*, vol. 34, no. 8, pp. 717-728.
- Kraljic, P. (1983), "Purchasing must become supply management", *Harvard Business Review*, vol. 61, no. 5, pp. 109-117.
- Lambert, D. M., Cooper, M. C., & Pagh, J. D. (1998), "Supply Chain Management: Implementation Issues and Research Opportunities", *International Journal of Logistics Management*, vol. 9, no. 2, pp. 1-19.
- Lambert, D. M., Emmelhainz, M. A., & Gardner, J. T. (1996), "Developing and Implementing Supply Chain Partnerships", *International Journal of Physical Distribution & Logistics Management*, vol. 7, no. 2, pp. 1-17.
- Langabeer, J. & Seifert, D. (2003), "Supply Chain Integration: The Key to Merger Success", *Supply Chain Management Review*, vol. 7, no. 2, pp. 58-64.
- Larson, P. D. & Gammelgaard, B. (2001), "Logistics in Denmark: A Survey of the Industry", *International Journal of Logistics: Research and Applications*, vol. 4, no. 2, pp. 191-206.
- Larson, P. D. & Halldorsson, A. (2002), "What is SCM? And, Where is It?", *Journal of Supply Chain Management*, vol. 38, no. 4, pp. 36-44.
- Laursen, S. F. (1991), "Brüel lost to Kjaer (Brüel tabte til Kjær)", *Børsens Nyhedsmagasinet*, vol. 7, no. 27, p. 17.
- Laursen, S. F. and Vestergård, V. (1991a), "Banks control shares (Banker sætter sig på aktier)", *Børsens Nyhedsmagasinet*, vol. 7, no. 35, pp. 20-21.
- Laursen, S. F. and Vestergård, V. (1991b), "Family feud paralyzes Brüel & Kjaer (Familie-strid lammer Brüel & Kjær)", *Børsens Nyhedsmagasinet*, vol. 7, no. 25, pp. 10-14.
- Laursen, S. F. and Vestergård, V. (1991c), "Loss: 3.5 mio DKK per week (Tab: 3,5 mio. om ugen)", *Børsens Nyhedsmagasinet*, vol. 7, no. 31, pp. 16-18.
- Lee, H. L. (2000), "Creating value through supply chain integration", *Supply Chain Management Review*, vol. 4, no. 4, pp. 30-36.
- Lee, H. L. (2002), "Aligning Supply Chain Strategies with Product Uncertainties", *California Management Review*, vol. 44, no. 3, pp. 105-119.
- Lee, H. L. (2004), "The Triple-A Supply Chain", *Harvard Business Review*, vol. 82, no. 10, pp. 102-112.
- Lee, H. L. & Billington, C. (1992), "Managing Supply Chain Inventory: Pitfalls and Opportunities", *Sloan Management Review*, vol. 33, no. 3, pp. 65-73.
- Lee, H. L., Padmanabhan, V., & Whang, S. (1997), "The Bullwhip Effect in Supply Chains", *Sloan Management Review*, vol. 38, no. 3, pp. 93-102.
- Lee, H. L. & Wolfe, M. (2003), "Supply Chain Security Without Tears", *Supply Chain Management Review*, vol. 7, no. 1, pp. 12-20.
- Lewis, M. W. (1998), "Iterative triangulation: a theory development process using existing case studies", *Journal of Operations Management*, vol. 16, no. 4, pp. 455-469.

- Lin, N.-P. & Krajewski, L. (1992), "A Model for Master Production Scheduling in Uncertain Environments", *Decision Sciences*, vol. 23, no. 4, pp. 839-861.
- LINAK (2004), *LINAK - Annual Report 2003/2004 (LINAK - Årsrapport 2003/2004)*, LINAK, Nordborg, Denmark.
- Link, P. & Marxt, C. (2004), "Integration of risk- and chance management in the co-operation process", *International Journal of Production Economics*, vol. 90, no. 1, pp. 71-78.
- Lippman, S. A. & Rumelt, R. P. (1982), "Uncertain imitability: An analysis of interfirm differences in efficiency under competition", *The Bell Journal of Economics*, vol. 13, no. 2, pp. 418-438.
- Lockamy III, A. & McCormack, K. (2004), "The development of a supply chain management process maturity model using the concepts of business process orientation", *Supply Chain Management: An International Journal*, vol. 9, no. 4, pp. 272-278.
- Logan, M. S. (2000), "Using Agency Theory to Design Successful Outsourcing Relationships", *International Journal of Logistics Management*, vol. 11, no. 2, pp. 21-32.
- Lonsdale, C. (1999), "Effectively managing vertical supply relationships: a risk management model for outsourcing", *Supply Chain Management: An International Journal*, vol. 4, no. 4, pp. 176-183.
- Marshall, A. (1948), *Principles of Economics*, 8. edn, Macmillan, New York.
- Martha, J. & Subbakrishna, S. (2002), "Targeting a Just-In-Case Supply Chain for the Inevitable Next Disaster", *Supply Chain Management Review*, vol. 6, no. 5, pp. 18-23.
- Mason, S. J., Cole, M. H., Ulrey, B. T., & Yan, L. (2002), "Improving electronics manufacturing supply chain agility through outsourcing", *International Journal of Physical Distribution & Logistics Management*, vol. 32, no. 7, pp. 610-620.
- Mason-Jones, R., Naylor, B., & Towill, D. R. (2000a), "Engineering the leagile supply chain", *International Journal of Agile Management Systems*, vol. 2, no. 1, pp. 54-61.
- Mason-Jones, R., Naylor, B., & Towill, D. R. (2000b), "Lean, agile or leagile? Matching your supply chain to the marketplace", *International Journal of Production Research*, vol. 38, no. 17, pp. 4061-4070.
- McIvor, R. (2000), "A practical framework for understanding the outsourcing process", *Supply Chain Management: An International Journal*, vol. 5, no. 1, pp. 22-36.
- McIvor, R. (2003), "Outsourcing: insights from the telecommunications industry", *Supply Chain Management: An International Journal*, vol. 8, no. 4, pp. 380-394.
- McWilliams, A. & Smart, D. L. (1993), "Efficiency v. Structure-Conduct-Performance: Implications for Strategy Research and Practice", *Journal of Management*, vol. 19, no. 1, pp. 63-78.
- Meldrum, M. J. & Millman, A. F. (1991), "Ten Risks in Marketing High-Technology Products", *Industrial Marketing Management*, vol. 20, no. 1, pp. 43-50.
- Melnyk, S. A., Stewart, D. M., & Swink, M. (2004), "Metrics and performance measurement in operations management: dealing with the metrics maze", *Journal of Operations Management*, vol. 22, no. 3, pp. 209-217.
- Mentzer, J. T., Dewitt, W., Keebler, J. S., Min, S., Nix, N. W., Smith, C. D., & Zacharia, Z. G. (2001), "Defining Supply Chain Management", *Journal of Business Logistics*, vol. 22, no. 2, pp. 1-25.
- Meredith, J. (1998), "Building operations management theory through case and field research", *Journal of Operations Management*, vol. 16, no. 4, pp. 441-454.
- Mikkola, J. H. & Skjøtt-Larsen, T. (2006), "One-stop-shopping at Oticon", in *Nordic case reader in logistics and supply chain management*, J. S. Arlbjørn, ed..
- Miles, M. B. (1979), "Qualitative Data as an Attractive Nuisance: The Problem of Analysis", *Administrative Science Quarterly*, vol. 24, no. 4, pp. 590-601.
- Ministry of Finance (1999), *Discussion paper on active ownership (Debatoplæg om aktivt ejerskab)*, Schultz, Copenhagen.
- Møller, M. M. (2003), *Bang & Olufsen's Way of Sourcing - Four ways of working*, Bang & Olufsen, Struer, Denmark.

- Montgomery, C. A. & Wernerfelt, B. (1988), "Diversification, Ricardian rents, and Tobin's q ", *The RAND Journal of Economics*, vol. 19, no. 4, pp. 623-632.
- Morash, E. A. & Clinton, S. R. (1998), "Supply Chain Integration: Customer Value Through Collaborative Closeness Versus Operational Excellence", *Journal of Marketing Theory & Practice*, vol. 6, no. 4, pp. 104-120.
- Munch, N. (2006/05/24), "German advert to the Danish market (Tysk reklame til dansk marked)", *Børsen*, 2006/05/24, p. 11.
- New, S. J. (1997), "The scope of supply chain management research", *Supply Chain Management*, vol. 2, no. 1, pp. 15-22.
- New, S. (2004), "Supply Chains: Construction and Legitimation", in *Understanding Supply Chains - Concepts, Critiques, and Futures*, S. New & R. Westbrook, eds., Oxford University Press, Oxford, pp. 69-108.
- Newman, W. R., Hanna, M., & Maffei, M. J. (1993), "Dealing with the Uncertainties of Manufacturing: Flexibility, Buffers and Integration", *International Journal of Operations & Production Management*, vol. 13, no. 1, pp. 19-34.
- Nishiguchi, T. & Beaudet, A. (1998), "The Toyota Group and the Aisin Fire", *Sloan Management Review*, vol. 40, no. 1, pp. 49-59.
- Noorderhaven, N. G. (1995), "Transaction, Interaction, Institutionalization: Toward a dynamic theory of hybrid governance", *Scandinavian Journal of Management*, vol. 11, no. 1, pp. 43-55.
- Nooteboom, B., Berger, H., & Noorderhaven, N. G. (1997), "Effects of Trust and Governance on Relational Risk", *The Academy of Management Journal*, vol. 40, no. 2, pp. 308-338.
- Nørby Johansen, L., Lindegaard, J., Schmidt, W., & Øvlisen, M. (2001), *The Nørby committee report on Corporate Governance in Denmark (Nørby-udvalgets rapport om Corporate Governance i Danmark)*, Erhvervs- og Selskabsstyrelsen.
- Norrman, A. & Jansson, U. (2004), "Ericsson's proactive supply chain risk management approach after a serious sub-supplier accident", *International Journal of Physical Distribution & Logistics Management*, vol. 34, no. 5, pp. 434-456.
- Novozymes (2005), *Novozymes - Annual Report 2004 (Novozymes - Årsrapport 2004)*, Novozymes, Bagsværd, Denmark.
- Nynke Faber, R., de Koster, B. M., & van de Velde, S. (2002), "Linking warehouse complexity to warehouse planning and control structure: An exploratory study of the use of warehouse management information systems", *International Journal of Physical Distribution & Logistics Management*, vol. 32, no. 5, pp. 381-395.
- NYSE (2003), www.nyse.com/pdfs/finalcorpgovrules.pdf, "Final NYSE Corporate Governance Rules", accessed 2005-12-30.
- Ohno, T. (1988), *Toyota Production System - Beyond Large-Scale Production*, Productivity Press, Cambridge, Massachusetts.
- Oliver, R. K. & Webber, M. D. (1982), "Supply Chain Management: logistics catches up with strategy", *Outlook*.
- Oticon Fonden (2004), *Built on caring - Oticon during 100 years (Bygget på omsorg - Oticon gennem 100 år)*, Oticon Fonden.
- Ottesen, G. G. & Gronhaug, K. (2002e), "Market orientation and uncertain supply in upstream markets: an exploratory study", *European Journal of Purchasing & Supply Management*, vol. 8, no. 4, pp. 209-219.
- Ottesen, G. G. & Gronhaug, K. (2002b), "Market orientation and uncertain supply in upstream markets: an exploratory study", *European Journal of Purchasing & Supply Management*, vol. 8, no. 4, pp. 209-219.
- Ottesen, G. G. & Gronhaug, K. (2002c), "Market orientation and uncertain supply in upstream markets: an exploratory study", *European Journal of Purchasing & Supply Management*, vol. 8, no. 4, pp. 209-219.

- Ottesen, G. G. & Gronhaug, K. (2002d), "Market orientation and uncertain supply in upstream markets: an exploratory study", *European Journal of Purchasing & Supply Management*, vol. 8, no. 4, pp. 209-219.
- Ottesen, G. G. & Gronhaug, K. (2002a), "Market orientation and uncertain supply in upstream markets: an exploratory study", *European Journal of Purchasing & Supply Management*, vol. 8, no. 4, pp. 209-219.
- Pagh, J. D. & Cooper, M. C. (1998), "Supply chain postponement and speculation strategies: How to choose the right strategy?", *Journal of Business Logistics*, vol. 19, no. 2, pp. 13-33.
- Payne, T. & Peters, M. J. (2004), "What is the Right Supply Chain For Your Products?", *International Journal of Logistics Management*, vol. 15, no. 2, pp. 77-92.
- Penrose, E. (1959), *The Theory of the Growth of the Firm*, Oxford University Press, Oxford.
- Perrow, C. (1984), *Normal Accidents*, Basic Books, New York.
- Persson, F. & Olhager, J. (2002), "Performance simulation of supply chain designs", *International Journal of Production Economics*, vol. 77, no. 3, pp. 231-245.
- Peteraf, M. A. (1993), "The Cornerstones of Competitive Advantage: A Resource-Based View", *Strategic Management Journal*, vol. 14, no. 3, pp. 179-188.
- Pine II, B. J. (1993), *Mass Customization - the new frontier in business competition*, Harvard Business School Press, Boston.
- Pires, S. R. I., Bremer, C. F., De Santa Eulalia, L. A., & Goulart, C. P. (2001), "Supply Chain and Virtual Enterprises: Comparisons, Migration and a Case Study", *International Journal of Logistics: Research and Applications*, vol. 4, no. 3, pp. 297-311.
- Polk, R., Plank, R. E., & Reid, D. A. (1996), "Technical Risk and New Product Success: An Empirical Test in High Technology Business Markets", *Industrial Marketing Management*, vol. 25, no. 6, pp. 531-543.
- Porter, M. E. (1980), *Competitive Strategy - techniques for analyzing industries and competitors*, The Free Press, New York.
- Porter, M. E. (1985), *Competitive Advantage - creating and sustaining superior advantage*, The Free Press, New York.
- Prahalad, C. K. & Hamel, G. (1990), "The Core Competence of the Corporation", *Harvard Business Review*, vol. 68, no. 3, pp. 79-91.
- PriceWaterhouseCoopers (2003), *COSO Internal Control - Integrated Framework*, AICPA.
- PriceWaterhouseCoopers (2004), *COSO Enterprise Risk Management - Integrated Framework*, AICPA.
- Reiner, G. & Trcka, M. (2003), "Customized supply chain design: Problems and alternatives for a production company in the food industry - a simulation based analysis", *International Journal of Production Economics*, vol. 89, no. 2, pp. 217-229.
- Reitman, V. (1997/05/08a), "To the Rescue: Toyota's Fast Rebound After Fire at Supplier Shows Why It Is Tough", *The Wall Street Journal*, New York, USA, 1997/05/08a, p. A.1.
- Reitman, V. (1997/02/04b), "Toyota factories in Japan grind to a halt", *The Wall Street Journal*, New York, USA, 1997/02/04b, p. A.14.
- Reitman, V. (1997/02/05c), "Toyota Sees Output Recovery by Friday, But Many Parts Suppliers Are Hurting", *The Wall Street Journal*, New York, USA, 1997/02/05c, p. A.15.
- Rice, J. B. & Caniato, F. (2003), "Building a Secure and Resilient Supply Network", *Supply Chain Management Review*, vol. 7, no. 5, pp. 22-29.
- Ritchie, B. & Brindley, C. (2000), "Disintermediation, disintegration and risk in the SME global supply chain", *Management Decision*, vol. 38, no. 8, pp. 575-583.
- Ritter, T. (2000), "A framework for analyzing interconnectedness of relationships", *Industrial Marketing Management*, vol. 29, no. 4, pp. 317-326.
- Ritzau (2006/06/22), "Does the paint say Gori or Flügger? (Siger malingen Gori eller Flügger?)", *Politiken*, 2006/06/22, p. 12.
- Robinson Jr, E. P. & Satterfield, R. K. (1998), "Designing distribution systems to support vendor strategies in supply chain management", *Decision Sciences*, vol. 29, no. 3, pp. 685-706.

- Rumelt, R. P. (1984), "Toward a strategic theory of the firm", in *Competitive Strategic Management*, R. Lamb, ed., Prentice Hall, Englewood Cliffs, NJ, pp. 556-570.
- Rumelt, R. P. (1987), "Theory, strategy, and entrepreneurship", in *The Competitive Challenge*, D. Teece, ed., Harper Row, New York, pp. 137-158.
- Sabath, R. (1998), "Volatile demand calls for quick response", *International Journal of Physical Distribution & Logistics Management*, vol. 28, no. 9/10, pp. 698-703.
- Sabri, E. H. & Beamon, B. M. (2000), "A multi-objective approach to simultaneous strategic and operational planning in supply chain design", *Omega*, vol. 28, no. 5, pp. 581-598.
- Sadgrove, K. (1996), *The complete guide to business risk management*, Gower Publishing Limited, Aldershot, UK & Brookfield, USA.
- Sahay, B. S. (2003), "Understanding trust in supply chain relationships", *Industrial Management & Data Systems*, vol. 103, no. 8, pp. 553-563.
- Sako, M. & Helper, S. (1998), "Determinants of Trust in Supplier Relations: Evidence from the Automotive Industry in Japan and the United States", *Journal of economic behaviour and organization*, vol. 34, no. 3, pp. 387-417.
- Schary, P. B. & Skjøtt-Larsen, T. (2001), *Managing the Global Supply Chain*, 2. edn, Handelshøjskolens Forlag A/S, København.
- Schulze, W. S. (1994), "The Two Schools of Thought in Resource-Based Theory: Definitions and Implications for Research", *Advances in Strategic Management*, vol. 10A, pp. 127-151.
- Schuster, W. (1990), "Agency problems and ownership forms - the case of ICA", *Scandinavian Journal of Management*, vol. 6, no. 4, pp. 251-266.
- Schwarz, L. B. & Weng, Z. K. (2000), "The Design of a JIT Supply Chain: The Effect of Leadtime Uncertainty on Safety Stock", *Journal of Business Logistics*, vol. 21, no. 2, pp. 231-253.
- Scott, C. & Westbrook, R. (1991), "New Strategic Tools for Supply Chain Management", *International Journal of Physical Distribution & Logistics Management*, vol. 21, no. 1, pp. 23-33.
- SDC DanDisc (2005), *SDC DANDISC - Annual Report 2004 (SDC DANDISC - Årsrapport 2004)*, SDC DanDisc, Frederiksberg, Denmark.
- Selznick, P. (1957), *Leadership in Administration*, Harper & Row, New York.
- Sheffi, Y. (2001), "Supply Chain Management under the Threat of International Terrorism", *International Journal of Logistics Management*, vol. 12, no. 2, pp. 1-11.
- Simatupang, T. M. & Sridharan, R. (2005), "An integrative framework for supply chain collaboration", *International Journal of Logistics Management*, vol. 16, no. 2, pp. 257-274.
- Simchi-Levi, D., Snyder, L., & Watson, M. (2002), "Strategies for Uncertain Times", *Supply Chain Management Review*, vol. 6, no. 1, pp. 11-12.
- Simon, H. (1947), *Administrative Behavior*, 2. edn, Macmillan, New York.
- Sinha, P. R., Whitman, L. E., & Malzahn, D. (2004), "Methodology to mitigate supplier risk in an aerospace supply chain", *Supply Chain Management Review*, vol. 9, no. 2, pp. 154-168.
- Skjøtt-Larsen, T. (1999), "Supply Chain Management: A New Challenge for Researchers and Managers in Logistics", *International Journal of Logistics Management*, vol. 10, no. 2, pp. 41-53.
- Skjøtt-Larsen, T., Thernøe, C., & Andresen, C. (2003), "Supply chain collaboration - Theoretical perspectives and empirical evidence", *International Journal of Physical Distribution & Logistics Management*, vol. 33, no. 6, pp. 531-549.
- Slack, N., Chambers, S., & Johnston, R. (2004), *Operations Management*, 4. edn, Prentice Hall, Harlow, UK.
- Smeltzer, L. R. & Siferd, S. P. (1998), "Proactive Supply Management: The Management of Risk", *International Journal of Purchasing and Materials Management*, vol. 34, no. 1, pp. 38-45.

- Snow, C. C. & Hrebiniak, L. G. (1980), "Strategy, Distinctive Competence, and Organizational Performance", *Administrative Science Quarterly*, vol. 25, no. 2, pp. 317-336.
- Sørensen, L. B. (2004), "How risk and uncertainty is used in supply chain management: a literature study", *International Journal of Integrated Supply Management*, vol. 1, no. 4.
- Sørensen, L. B. (2005), "Questioning the path of progression - Failing to measure SCM maturity", in *Proceedings of NOFOMA 2005*, B. Gammelgaard & T. Skjoett-Larsen, eds., Copenhagen, Denmark, pp. 225-240.
- Sørensen, L. B. (2007), "Failing to Measure SCM Maturity", in *Managing Supply Chains - Challenges and Opportunities*, R. de Koster & W. Delfmann, eds., Copenhagen Business School Press, Copenhagen, pp. 59-82.
- Sørensen, L. B. & Holst, L. L. (2003), "The Evolution of Click-n-Mortar E-tailing in Denmark", *Copenhagen Business School Working Papers*, no. 2003-03.
- Spear, S. & Bowen, H. K. (1999), "Decoding the DNA of the Toyota Production System", *Harvard Business Review*, vol. 77, no. 5, pp. 96-106.
- Speh, T. W. & Wagenheim, G. D. (1978), "Demand and Lead-Time Uncertainty: The Impacts on Physical Distribution Performance and Management", *Journal of Business Logistics*, vol. 1, no. 1, pp. 95-113.
- Spekman, R. E. & Davis, E. W. (2004), "Risky business: expanding the discussion on risk and the extended enterprise", *International Journal of Physical Distribution & Logistics Management*, vol. 34, no. 5, pp. 414-433.
- Stabell, C. B. & Fjeldstad, O. D. (1998), "Configuring Value for Competitive Advantage: On Chains, Shops, and Networks", *Strategic Management Journal*, vol. 19, no. 5, pp. 413-437.
- Stefansson, G. (2002), "Business-to-business data sharing: A source for integration of supply chains", *International Journal of Production Economics*, vol. 75, no. 1-2, pp. 135-146.
- Stevens, G. C. (1989), "Integrating the Supply Chain", *International Journal of Physical Distribution and Materials Management*, vol. 19, no. 8, pp. 3-8.
- Stevenson, W. J. (2005), *Operations Management*, 8. edn, McGraw-Hill, New York.
- Storey, J., Emberson, C., Godsell, J., & Harrison, A. (2006), "Supply chain management: theory, practice and future challenges", *International Journal of Operations & Production Management*, vol. 26, no. 7, pp. 754-774.
- Suh, T. & Kwon, I.-W. G. (2006), "Matter over mind: When specific asset investment affects calculative trust in supply chain partnership", *Industrial Marketing Management*, vol. 35, no. 2, pp. 191-201.
- Svensson, G. (2000), "A conceptual framework for the analysis of vulnerability in supply chains", *International Journal of Physical Distribution & Logistics Management*, vol. 30, no. 9, pp. 731-749.
- Svensson, G. (2001), "Firms' Preventive Activities and the Occurrence of Disturbances in the Inbound and Outbound Logistics Flows", *International Journal of Logistics: Research and Applications*, vol. 4, no. 2, pp. 207-236.
- Svensson, G. (2002a), "A conceptual framework of vulnerability in firms' inbound and outbound logistics flows", *International Journal of Physical Distribution & Logistics Management*, vol. 32, no. 2, pp. 110-134.
- Svensson, G. (2002b), "A typology of vulnerability scenarios towards suppliers and customers in supply chains based upon perceived time and relationship dependencies", *International Journal of Physical Distribution & Logistics Management*, vol. 32, no. 3, pp. 168-187.
- Svensson, G. (2002c), "Dyadic Vulnerability in Companies' Inbound and Outbound Logistics Flows", *International Journal of Logistics: Research and Applications*, vol. 5, no. 1, pp. 13-43.
- Svensson, G. (2002d), "Vulnerability scenarios in marketing channels", *Supply Chain Management: An International Journal*, vol. 7, no. 5, pp. 322-333.
- Swaminathan, J. M., Smith, S. F., & Sadeh, N. M. (1998), "Modeling supply chain dynamics: A multiagent approach", *Decision Sciences*, vol. 29, no. 3, pp. 607-632.

- Szabo, Antal (1998), www.unece.org/indust/sme/def-eu, "Definition of SMEs in the European Union", accessed 2005-06-16.
- Tamas, M. (2000), "Mismatched strategies: the weak link in the supply chain?", *Supply Chain Management: An International Journal*, vol. 5, no. 4, pp. 171-175.
- Tan, K. C. (2001), "A framework of supply chain management literature", *European Journal of Purchasing & Supply Management*, vol. 7, no. 1, pp. 39-48.
- Tang, O. & Grubbström, R. W. (2002), "Planning and replanning the master production schedule under demand uncertainty", *International Journal of Production Economics*, vol. 78, no. 3, pp. 323-334.
- Teece, D. J. (1982), "Toward an economic theory of the multiproduct firm", *Journal of economic behaviour and organization*, vol. 3, no. 1, pp. 39-63.
- Teece, D. J. (1986), "Firm boundaries, technological innovation, and strategic management", in *The Economics of Strategic Planning*, L. G. Thomas III, ed., Lexington Books, Lexington, MA, pp. 187-199.
- Teece, D. J., Pisano, G., & Shuen, A. (1997), "Dynamic Capabilities and Strategic Management", *Strategic Management Journal*, vol. 18, no. 7, pp. 509-533.
- Templin, C. R. & Noffsinger, K. R. (1994), "An Assessment of the Role of Technical and Risk Evaluation Factors in Defense Source Selection Decisions", *International Journal of Purchasing and Materials Management*, vol. 30, no. 4, pp. 37-43.
- Thompson, J. D. (1967), *Organizations in action - social science bases of administrative theory*, McGraw-Hill, New York.
- Towill, D. & Christopher, M. (2002), "The Supply Chain Strategy Conundrum: To Be Lean Or Agile or To be Lean And Agile?", *International Journal of Logistics: Research and Applications*, vol. 5, no. 3, pp. 299-309.
- Towill, D. R. (1996), "Time compression and supply chain management - a guided tour", *Supply Chain Management: An International Journal*, vol. 1, no. 1, pp. 15-27.
- Towill, D. R. (1997), "FORRIDGE - Principles of good practice in material flow", *Production Planning & Control*, vol. 8, no. 7, pp. 622-632.
- Towill, D. R., Childerhouse, P., & Disney, S. M. (2002), "Integrating the automotive supply chain: where are we now?", *International Journal of Physical Distribution & Logistics Management*, vol. 32, no. 2, pp. 79-95.
- Towill, D. R., Naim, M. M., & Wikner, J. (1992), "Industrial Dynamics Simulation Models in the Design of Supply Chains", *International Journal of Physical Distribution & Logistics Management*, vol. 22, no. 5, pp. 3-13.
- Treece, J.B. & Rechten, M. (1997/01/01), "Just-too-much single-sourcing spurs Toyota purchasing review", *Automotive News*, 1997/01/01, pp. 3-4.
- Treleven, M. & Schweikhart, S. B. (1988), "A risk/benefit analysis of sourcing strategies: single vs. multiple sourcing", *Journal of Operations Management*, vol. 7, no. 4, pp. 93-114.
- Tullous, R. & Munson, J. M. (1991), "Trade-offs Under Uncertainty: Implications for Industrial Purchasers", *International Journal of Purchasing and Materials Management*, vol. 27, no. 3, pp. 24-31.
- Tuominen, P. (1999), "Episodes and bonds in investor relationships", *Scandinavian Journal of Management*, vol. 15, no. 3, pp. 269-288.
- van Ackere, A. (1993), "The principal/agent paradigm: Its relevance to various functional fields", *European Journal of Operational Research*, vol. 70, no. 1, pp. 83-103.
- van der Horst, J. G. A. J. & Beulens, A. J. M. (2002), "Identifying sources of uncertainty to generate supply chain redesign strategies", *International Journal of Physical Distribution & Logistics Management*, vol. 32, no. 6, pp. 409-430.
- van der Horst, J. G. A. J., van Dijk, S. J., & Beulens, A. J. M. (2001), "Supply chain design in the food industry", *International Journal of Logistics Management*, vol. 12, no. 2, pp. 73-85.

- van Hoek, R. & Weken, H. A. M. (1998), "The Impact of Modular Production on the Dynamics of Supply Chains", *International Journal of Logistics Management*, vol. 9, no. 2, pp. 35-50.
- van Hoek, R. I., Commandeur, H. R., & Vos, B. (1998), "Reconfiguring Logistics Systems Through Postponement Strategies", *Journal of Business Logistics*, vol. 19, no. 1, pp. 33-53.
- Vaughan, E. J. (1997), *Risk Management*, John Wiley & Sons, Inc., New York.
- Vestergård, V. (1992a), "Brüel & Kjaer for sale (Brüel & Kjær sat til salg)", *Børsens Nyhedsmagasin*, vol. 8, no. 7, p. 3.
- Vestergård, V. (1992b), "Struers grim radio doctor (Struers bistre radiodoktor)", *Børsens Nyhedsmagasin*, vol. 8, no. 18, pp. 68-71.
- Vestergård, V. (1994), "CEO in sound and space (Direktør i lyd og rum)", *Børsens Nyhedsmagasin*, vol. 10, no. 15, p. 79.
- VICS (2004), *Collaborative Planning, Forecasting and Replenishment (CPFR)*.
- Vidal, C. J. & Goetschalkx, M. (2000), "Modeling the Effect of Uncertainties on Global Logistics Systems", *Journal of Business Logistics*, vol. 21, no. 1, pp. 95-120.
- Walker, G. (1988), "Strategic Sourcing, Vertical Integration, and Transaction Cost", *Interfaces*, vol. 18, no. 3, pp. 62-73.
- Walker, W. T. (2000), "Rethinking the Reverse Supply Chain", *Supply Chain Management Review*, vol. 4, no. 2, pp. 52-59.
- Watkins, M. D. & Bazerman, M. H. (2003), "Predictable Surprises: The Disasters You Should Have Seen Coming", *Harvard Business Review*, vol. 81, no. 3, pp. 72-80.
- Weil, Gotshal, and Manges (2002), www.ecgi.org/codes/documents/comparative_study_eu_i_to_v_en.pdf, "Comparative Study Of Corporate Governance Codes Relevant to the European Union And Its Member States", accessed 2005-12-30.
- Weng, Z. K. (1999), "Risk-pooling over demand uncertainty in the presence of product modularity", *International Journal of Production Economics*, vol. 62, no. 1-2, pp. 75-85.
- Wernerfelt, B. (1984), "A Resource-Based View of the Firm", *Strategic Management Journal*, vol. 5, no. 2, pp. 171-180.
- Westbrook, K. W. (1996), "Risk Coordinative Maneuvers During Buyer-Seller Negotiations", *Industrial Marketing Management*, vol. 25, no. 4, pp. 283-292.
- Whitney, D. E. (1988), "Manufacturing by Design", *Harvard Business Review*, vol. 66, no. 4, pp. 83-91.
- Wilding, R. (1998a), "The supply chain complexity triangle - Uncertainty generation in the supply chain", *International Journal of Physical Distribution & Logistics Management*, vol. 28, no. 8, pp. 599-616.
- Wilding, R. D. (1998b), "Chaos theory: Implications for supply chain management", *International Journal of Logistics Management*, vol. 9, no. 1, pp. 43-56.
- Wilkinson, I. F. & Young, L. C. (1994), "Business Dancing - The Nature of Interfirm Relations in Business Strategy", *Asia - Australia Marketing Journal*, vol. 2, no. 1, pp. 67-79.
- William Demant Holding (2003), www.demant.dk, "Corporate Governance", accessed 2005-10-01.
- Williams, T. L. (1996), "An Integrated Approach To Risk Management", *Risk Management*, vol. 43, no. 7, pp. 22-27.
- Williamson, O. E. (1971), "The Vertical Integration of Production: Market Failure Considerations", *American Economic Review*, vol. 61, no. 2, pp. 112-123.
- Williamson, O. E. (1975), *Markets and Hierarchies: Analysis and Antitrust Implications*, Free Press, New York.
- Williamson, O. E. (1979), "Transaction-cost Economics: The Governance of Contractual Relations", *Journal of Law and Economics*, vol. 22, no. 2, pp. 233-261.
- Williamson, O. E. (1981), "The Economics of Organization: The Transaction Cost Approach", *American Journal of Sociology*, vol. 87, no. 3, pp. 548-577.

- Williamson, O. E. (1983), "Credible Commitments: Using Hostages to Support Exchange", *American Economic Review*, vol. 73, no. 4, pp. 519-540.
- Williamson, O. E. (1985), *The Economic Institutions of Capitalism*, Free Press, New York.
- Williamson, O. E. (1991a), "Comparative Economic Organization: The Analysis of Discrete Structural Alternatives", *Administrative Science Quarterly*, vol. 36, no. 2, pp. 269-296.
- Williamson, O. E. (1991b), "Strategizing, Economizing, and Economic Organization", *Strategic Management Journal*, vol. 12 (Special Issue, Winter 1991), pp. 75-94.
- Williamson, O. E. (1993), "Calculativeness, Trust, and Economic Organization", *Journal of Law & Economics*, vol. 36, no. 1, Part 2, pp. 453-486.
- Williamson, O. E. (2000), "The New Institutional Economics: Taking Stock, Looking Ahead", *Journal of Economic Literature*, vol. 38, no. 3, pp. 595-613.
- Wilson, T. P. & Clarke, W. R. (1998), "Food safety and traceability in the agricultural supply chain: using the Internet to deliver traceability", *Supply Chain Management: An International Journal*, vol. 3, no. 3, pp. 127-133.
- Womack, J. P., Jones, D. T., & Ross, D. (1990), *The Machine that Changed the World*, Macmillan, New York.
- Woodside, A. G. & Wilson, E. J. (2003), "Case study research methods for theory building", *Journal of Business & Industrial Marketing*, vol. 18, no. 6/7, pp. 493-508.
- Wouters, M. J. F., Sharman, G. J., & Wortmann, H. C. (1999), "Reconstructing the Sales and Fulfillment Cycle to Create Supply Chain Differentiation", *International Journal of Logistics Management*, vol. 10, no. 2, pp. 83-98.
- Wright, G. (1980), "Purchasing, Risk and Logistics: A Neglected Combination?", *International Journal of Operations & Production Management*, vol. 1, no. 1, pp. 47-58.
- Yin, R. K. (1981), "The Case Study Crisis: Some Answers", *Administrative Science Quarterly*, vol. 26, no. 1, pp. 58-65.
- Yin, R. K. (1994), *Case study research - Design and methods*, 2. edn, SAGE Publications, Thousand Oaks, CA.
- Yin, R. K., Bingham, E., & Heald, K. A. (1976), "The difference that quality makes: The case of literature reviews", *Sociological Methods and Research*, vol. 5, no. 2, pp. 139-156.
- Young, P. C. & Tipping, S. C. (2000), *Managing Business Risk - An Organization-Wide Approach to Risk Management*, AMACOM (American Management Association), New York.
- Zaidman, B. (1994), "Market vulnerability in the process industries", *International Journal of Production Economics*, vol. 34, no. 1, pp. 57-64.
- Zajac, E. J. & Olsen, C. P. (1993), "From Transaction Cost to Transactional Value Analysis: Implications for the Study of Interorganisational Strategies", *Journal of Management Studies*, vol. 30, no. 1, pp. 131-145.
- Zeng, A. Z. (2003), "Global sourcing: process and design for efficient management", *Supply Chain Management: An International Journal*, vol. 8, no. 4, pp. 367-379.
- Zografos, K. G. & Giannouli, I. M. (2001), "Development and Application of a Methodological Framework for Assessing Supply Chain Management Trends", *International Journal of Logistics: Research and Applications*, vol. 4, no. 2, pp. 153-190.
- Zsidisin, G. (2003a), "A grounded definition of supply risk", *Journal of Purchasing and Supply Management*, vol. 9, no. 5-6, pp. 217-224.
- Zsidisin, G. (2003b), "Managerial Perceptions of Supply Risk", *Journal of Supply Chain Management*, vol. 39, no. 1, pp. 14-25.
- Zsidisin, G. & Ellram, L. M. (2003), "An Agency Theory Investigation of Supply Risk Management", *Journal of Supply Chain Management*, vol. 39, no. 3, pp. 15-27.
- Zsidisin, G. A., Ellram, L. M., Carter, J. R., & Cavinato, J. L. (2004), "An analysis of supply risk assessment techniques", *International Journal of Physical Distribution & Logistics Management*, vol. 34, no. 5, pp. 397-413.

Zsidisin, G. A., Panelli, A., & Upton, R. (2000), "Purchasing organization involvement in risk assessments, contingency plans, and risk management: an exploratory study", *Supply Chain Management: An International Journal*, vol. 5, no. 4, pp. 187-197.

Internet Resources

amadeus.bvcddep.com	AMADEUS
europa.eu.int/eur-lex	EUR-LEX – The Portal to European Union Law
www.amoena.com	AMOENA
www.bksv.com	Brüel & Kjør Sound & Vibration Measurement
www.coloplast.com	Coloplast
www.cscmp.org	Council of Supply Chain Management Professionals
www.dancotech.dk	Danco Tech a/s
www.demant.dk	William Demant Holding
www.dewert.de	Dewert
www.dtu.dk	The Danish Technical University (DTU)
www.dvdforum.org	DVD Forum
www.dyrup.com	Dyrup
www.ecgi.org	European Corporate Governance Institute
www.ecrnet.org	Efficient Consumer Response (ECR) Europe
www.flextronics.com	Flextronics
www.fritzhansen.com	Fritz Hansen
www.icepower.bang-olufsen.com	IcePower (Bang & Olufsen)
www.ifpi.com	International Federation of the Phonographic Industry
www.infomedia.dk	INFOMEDIA
www.linak.dk	LINAK Denmark A/S
www.linak.com	LINAK A/S.
www.logistikkonferencen.dk	The Danish Logistics Conference
www.magnetic.skf.com	SKF/Magnetic
www.medicom.bang-olufsen.com	Medicom (Bang & Olufsen)
www.nasdaq.com	The NASDAQ Stock Exchange
www.novozymes.com	Novozymes
www.nyse.com	New York Stock Exchange
www.okin.de	Okin
www.oticon.dk	Oticon
www.perst.dk	State Employer's Authority
www.riegens.dk	RIEGENS
www.sanistaal.dk	Sanistål
www.sap.dk	SAP Denmark
www.sdc-group.dk	SDC DANDISC
www.supplychainprisen.dk	The Post Denmark Supply Chain Award
www.st.dk	Skandinavisk Tobakskompagni
www.thejournalofrisk.com	The Journal of Risk
www.unece.org	United Nations Economic Commission for Europe
www.usbyte.com	USByte – computer technology and PC data storage

Risk Management in the Supply Chain

Appendices

Contents

Appendix A	Pilot Studies	1
A.1	Initial Research Focus	1
A.2	Research Method.....	1
A.2.1	SCM Models	2
A.2.2	A Supply Chain Process Maturity Model	5
A.3	Suggesting a SCM Maturity Model	6
A.3.1	SCM Constructs	7
A.3.2	Risk Management Constructs	9
A.3.3	The Initial Questionnaire.....	10
A.4	The CLM Pilot Study	10
A.4.1	Results – Supply Chain Management	12
A.4.2	Results – Supply Chain Integration.....	13
A.4.3	Identifying SCM Maturity.....	15
A.4.4	Practices on Risk Management	17
A.4.5	Combining SCM Maturity and Risk Practices.....	18
A.4.6	Conclusion from the CLM Pilot Study	19
A.5	Modifying the Research Instrument.....	19
A.5.1	The Modified SCM Maturity Model.....	19
A.5.2	Constructs.....	20
A.6	The CBS Pilot Study	22
A.6.1	Population	22
A.6.2	Results	23
A.6.3	Identifying SCM Maturity.....	25
A.6.4	Practices on Risk Management	26
A.6.5	Combining SCM Maturity and Risk Practices.....	28
A.7	Overall Conclusions	28
A.7.1	Consequences for the Research Design	30
A.8	The Initial Questionnaire.....	31
A.9	The Modified Questionnaire	36
Appendix B	Consultancy Practice I	43
B.1	Consultancies, Contacts, and Interviewees	43
B.2	Results	43
B.2.1	IBM Consulting.....	43
B.2.2	Marsh Consulting	44
B.2.3	PricewaterhouseCoopers	46
B.3	Conclusion.....	49
Appendix C	Performing Literature Studies	51
C.1	Building a Generic Model	51
C.1.1	Designing the Study	51
C.1.2	Performing the Study	53
C.1.3	A Typology of Strategies	54
C.2	Combining the Strategies	56
C.3	A Final Word of Caution	56
Appendix D	Risk, Vulnerability, and Uncertainty	57
D.1	Volumes Investigated.....	58
D.2	SCM/Logistics Journals	58
D.3	Operations Management Journals	60
D.4	Management Journals.....	62
D.5	Completeness Check (Cross-database Search)	64
D.6	Themes on Risk, Uncertainty, and Vulnerability	64

Contents (cont'd)

Appendix E	SCM/Logistics in the Risk Domain	65
E.1	Volumes Investigated	65
E.2	Risk Journals.....	66
E.3	Completeness Check (Within Journal Search)	66
Appendix F	Supply Chain Design	67
F.1	Volumes Investigated	68
F.2	SCM/Logistics Journals.....	68
F.3	Operations Management Journals	70
F.4	Management Journals	71
F.5	Completeness Check (Cross-database Search).....	72
F.6	Subject Area	73
F.7	Design Objective(s)	74
Appendix G	Interview Guides	75
G.1	Interview Guide I: SCM & SCRM Practices.....	76
G.2	Interview Guide II: Supply Risk Management.....	81
G.3	Interview Guide III: Appropriateness of Current Practices.....	85
Appendix H	Interviewees & Interviews	87
H.1	Interviewees.....	87
H.2	Interviews	88
Appendix I	Coordination of Critical Risks?	89
I.1	Bang & Olufsen	89
I.2	Coloplast.....	90
I.3	Novozymes	91
I.4	SDC DANDISC.....	92
Appendix J	Triangulation I – External Reporting.....	95
J.1	Construct ‘External Reporting on SCM’	95
J.2	Construct ‘External Reporting on Corporate Governance’	96
J.3	Construct ‘External Reporting on Business Risk Management’	97
J.4	Construct ‘External Reporting on Financial Risk Management’	98
Appendix K	Triangulation II - Finance/Staff Perspective.....	99
K.1	Interviewees.....	99
K.2	Interviews	99
K.3	Interview Guide IV: Risk Management Practice.....	100
Appendix L	Consultancy Practice II	103
L.1	Consultancies, Contacts, and Interviewees.....	103
L.2	Results	103
L.2.1	Accenture.....	103
L.2.2	AT Kearney	104
L.2.3	COWI.....	105
L.2.4	Deloitte & Touche	105
L.2.5	Ernst & Young.....	106
L.2.6	IBM Consulting	106
L.2.7	KPMG Advisory	106
L.2.8	Marsh Consulting	106
L.2.9	McKinsey.....	106
L.2.10	PricewaterhouseCoopers	107
L.3	Conclusion	109

List of Tables

Table A-1:	The ‘Internal’ Construct.....	8
Table A-2:	The ‘Upstream’ Construct.....	8
Table A-3:	The ‘Downstream’ Construct.....	9
Table A-4:	The ‘Network’ Construct.....	9
Table A-5:	Participants in the CLM Pilot Study.....	11
Table A-6:	SCM, Processes, and ERP Support.....	13
Table A-7:	Number and Length of Relationships.....	14
Table A-8:	External Relationships.....	14
Table A-9:	Exchange of Electronic Documents.....	15
Table A-10:	Level 1 Constructs.....	16
Table A-11:	Level 0 Constructs and Maturity Level.....	16
Table A-12:	Level 0 Constructs and Maturity Level (Relaxing Req’s on Internal).....	17
Table A-13:	Risk Management.....	18
Table A-14:	The Modified ‘Internal’ Construct.....	21
Table A-15:	The Modified ‘Upstream’ Construct.....	21
Table A-16:	The Modified ‘Downstream’ Construct.....	21
Table A-17:	The Modified ‘Network’ Construct.....	22
Table A-18:	Participants in the CBS Pilot Study.....	23
Table A-19:	SCM Processes.....	24
Table A-20:	IT Usage.....	24
Table A-21:	Collaboration with External Parties.....	25
Table A-22:	Level 1 Constructs.....	25
Table A-23:	Level 0 Constructs and Maturity Level.....	26
Table A-24:	Level 0 Constructs and Maturity Level (Relaxing Req’s on Network).....	26
Table A-25:	Risk Management.....	28
Table B-1:	Companies, Contacts, and Interviewees.....	43
Table B-2:	Integrated Risk Management Frameworks.....	49
Table C-1:	Strategies Step-by-Step.....	56
Table D-1:	Parameters for Literature Study.....	57
Table D-2:	Volumes Investigated.....	58
Table D-3:	Classification of Articles Published in SCM/Logistics Journals.....	58
Table D-4:	Themes Identified in SCM/Logistics Journals.....	60
Table D-5:	Classification of Articles Published in Operations Management Journals.....	60
Table D-6:	Themes Identified in Operations Management Journals.....	62
Table D-7:	Classification of Articles Published in Management Journals.....	62
Table D-8:	Themes Identified in Management Journals.....	63
Table D-9:	Classification of Articles Published in Other Journals.....	64
Table D-10:	Themes Identified Across Journal Categories.....	64
Table E-1:	Parameters for Literature Study.....	65
Table E-2:	Volumes Investigated.....	65
Table E-3:	Classification of Articles Published in Risk Journals.....	66
Table E-4:	Themes Identified in Risk Journals.....	66
Table E-5:	Classification of Articles Published in Other Journals.....	66
Table F-1:	Parameters for Literature Study.....	67
Table F-2:	Volumes Investigated.....	68
Table F-3:	Classification of Articles Published in SCM/Logistics Journals.....	68
Table F-4:	Classification of Articles Published in Operations Management Journals.....	70
Table F-5:	Classification of Articles Published in Management Journals.....	71
Table F-6:	Classification of Articles Published in Other Journals.....	72
Table F-7:	Classification of Articles Published in Other Journals.....	73

List of Tables (cont'd)

Table F-8:	Articles Classified According to Subject Area.....	73
Table F-9:	Articles Classified According to Design Objective(s)	74
Table G-1:	Application of Interview Guides	75
Table H-1:	Interviewees in the Case Studies	87
Table H-2:	Interviews Performed	88
Table I-1:	Critical Risks Identified – Bang & Olufsen	89
Table I-2:	Critical Risks Categorized – Bang & Olufsen.....	90
Table I-3:	Critical Risks Identified – Coloplast	90
Table I-4:	Critical Risks Categorized – Coloplast	91
Table I-5:	Critical Risks Identified – Novozymes	91
Table I-6:	Critical Risks Categorized – Novozymes.....	92
Table I-7:	Critical Risks Identified – SDC DANDISC	92
Table I-8:	Critical Risks Categorized – SDC DANDISC	93
Table J-1:	Summary of ‘External Reporting on SCM’	95
Table J-2:	Summary of ‘External Reporting on Corporate Governance’	96
Table J-3:	Summary of ‘External Reporting on Business Risk Management’	97
Table J-4:	Summary of ‘External Reporting on Financial Risk Management’	98
Table K-1:	Interviewees in the Case Studies	99
Table K-2:	Interviews Performed	99
Table L-1:	Companies, Contacts, and Interviewees.....	103
Table L-2:	Integrated Risk Management Frameworks.....	109

List of Figures

Figure A-1:	Achieving an Integrated Supply Chain	2
Figure A-2:	Levels of research in supply chain management	3
Figure A-3:	Types of Channel Relationships	4
Figure A-4:	The BPO maturity model	5
Figure A-5:	The supply chain maturity model	6
Figure A-6:	SCM Maturity Model.....	7
Figure A-7:	The Revised SCM Maturity Model.....	20
Figure A-8:	Different Views of Supply Chain Integration.....	29
Figure B-1:	The Four Risk Quartiles.....	45
Figure B-2:	Risk vs. Revenue.....	45
Figure B-3:	Enterprise Risk Management.....	46
Figure B-4:	Components in the COSO Model	48
Figure C-1:	A Generic Model for Literature Studies	54
Figure L-1:	Stages of Excellence in Risk Management.....	104
Figure L-2:	Implementation of Risk Management.....	108

Appendix A Pilot Studies

The aim of this appendix is to document the two pilot studies performed in the beginning of the project. The pilot studies are justified by the need to clarify the relevance of the project, and to adjust the research questions.

A.1 Initial Research Focus

The intent of the researcher is to perform a number of multi-level fit-analyses of the participating supply chains, and subsequently to analyze the consequences of using risk management on the design decisions (structure and type/degree of integration). The questionnaire used in the panel group study does not go to the level of detail necessary in the case studies but will hopefully strengthen the research design by revealing weaknesses and mistakes to be amended before doing the case studies.

The multi-level contingency model contains the following levels of inquiry:

1. SCM “type” (participants, processes, techniques, etc.)
2. Integration (internal, external, system/process/social)
3. Risk management practices

The first level describes the type of SCM in place, in terms of e.g. processes and participating functions. The second level describes the integration with external partners based on a three-variable construct (social, systemic, and process integration). Each of these variables explain a component of the objective of the individual supply chain, e.g. a high degree of external process integration to obtain low inventory and high speed/flexibility and a high degree of external social integration to maximize mutual learning leading to faster development of new products. The third level investigates the awareness of critical risks on network, strategic, and operational level, and their associated levels of impact and probability.

A.2 Research Method

Choosing a research method should be based on the characteristics of the phenomenon under scrutiny and the intended outcome of the study (e.g. Ghauri, Grønhaug, & Kristianslund, 1995; Yin, 1994). In this instance a contingency model was the intended outcome, which implies a large number of variables. To speed up the collection of data in this initial stage, the trade-off between level of detail and amount and diversity of data collected normally observed when performing data collection from panel group discussions was deemed justified. Acknowledging the fact that the implemented SCM practices, the level and type of external and internal integration and not least the risk management practices in place are vital to companies, a questionnaire was designed to collect the information and ensure the highest level of privacy possible. An obstacle to obtaining credible information is the absence of procedures for confirming the information, and the diversity of questions posed.

Before designing the questionnaire, a model for the description of SCM practices must be developed. In order to do so, some of the existing models are reviewed.

A.2.1 SCM Models

The underlying premise of the first and partly the second level in the multi-level contingency model is based on Stevens (1989) frameworks on integration. According to Stevens internal integration is a prerequisite for external integration, and only when external integration is in place is a company practising SCM. The model contains four steps of progression, see Figure A-1 below.

Figure A-1: Achieving an Integrated Supply Chain¹

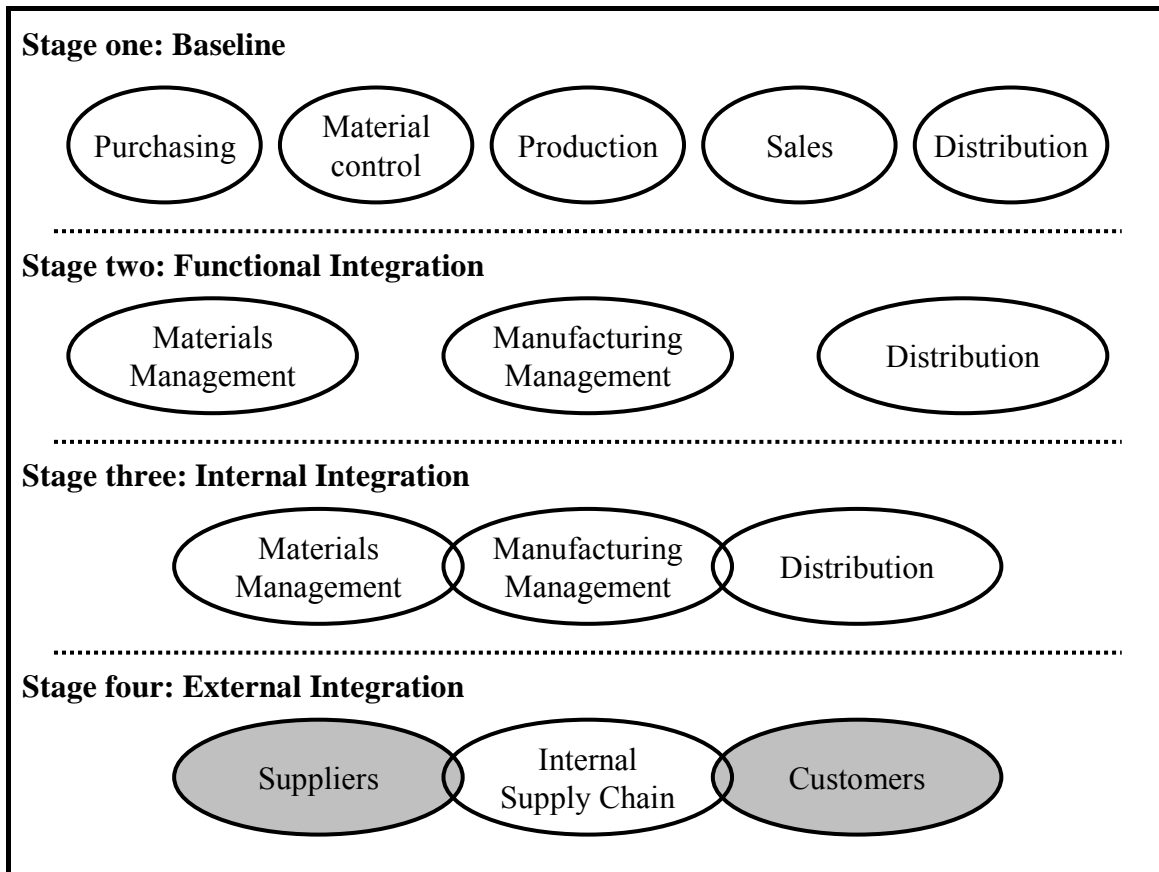

Complementary to this model Harland (1996) propose a four-level model describing the research within Supply Chain Management (see below). The purpose of the model is to describe the levels of inquiry in existing research and to investigate the interconnectedness between them. The model does not make claims on e.g. the integration of the entities or the progression from one type of SCM to the next, but on the objects of inquiry alone.

¹ Source: Figure 5 in Stevens (1989), p. 7.

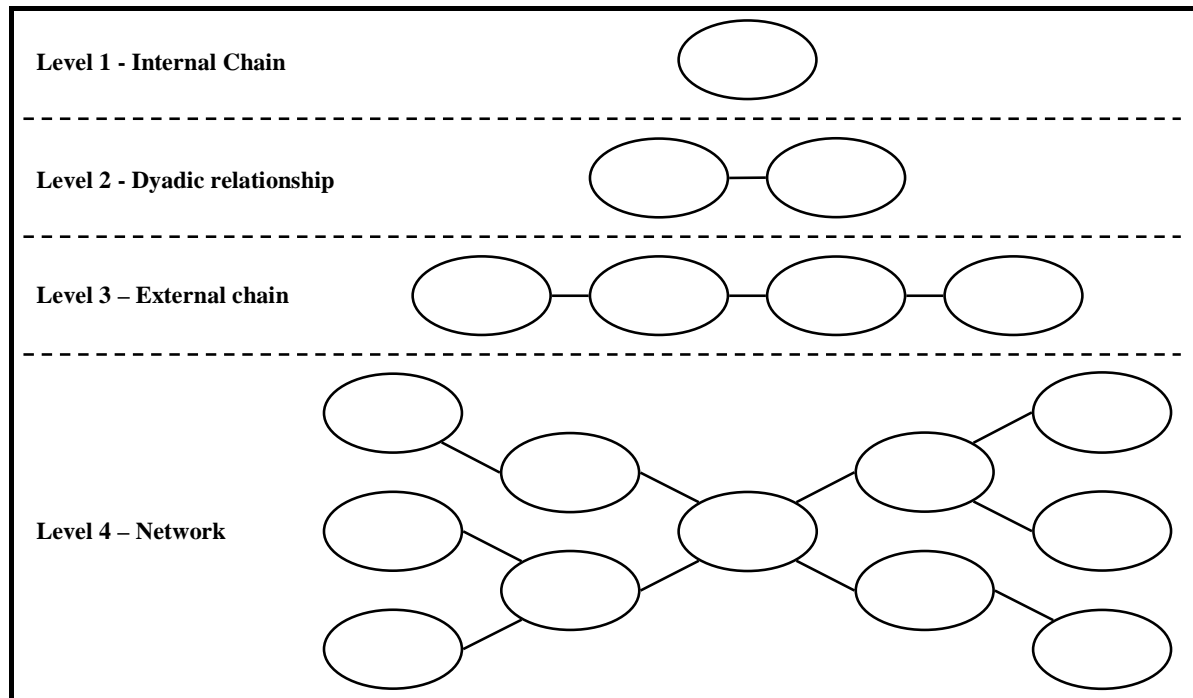
Figure A-2: Levels of research in supply chain management²

Harland thereby does not support the notion of progression from the simpler configuration to the more complex, but documents the tradition of classifying the structure under investigation. Where Stevens talk about internal integration (and Harland in this contribution does not), others use the term process orientation (e.g. Cooper, Lambert, & Pagh, 1997). That process orientation is crucial is apparent in the same article, where it is claimed that

“The integration of business processes across the supply chain is what we are calling supply chain management.” (p. 2)

and

“To implement SCM, some level of coordination across organisational boundaries is needed. This includes integration of processes and functions within organizations and across the supply chain.” (p. 3).

Albeit subscribing to the idea of progression this is not apparent in the three-component (1. business processes, 2. management components, and 3. supply chain structure) model put forward, but it is clearly stated after the definition of “process”³ that

“Supply chain business processes can cross intra- and inter-organizational boundaries, independently of formal structure.” (p. 5).

The emphasis on process orientation is further strengthened in a follow-up article (Lambert, Cooper, & Pagh, 1998) where the major contributions are the classifications of supply chain members into primary and supporting members, and business process links into managed, monitored, not-managed, and non-member process links.

² Source: Figure 7 in Harland (1996), p. S72.

³ “A process is thus a specific ordering of work activities across time and place, with a beginning, an end, and clearly identified inputs and outputs: a structure for action.” (Davenport, 1993, p. 5).

Assuming process orientation Mentzer et al. (2001) extend Stevens framework. They propose a four-step model describing a progression from the single buyer-seller relationship over the multi-tier supply chain to the “complete” business environment including various supporting entities (see Figure A-3). Besides offering a typology of external integration to support the Stevens model, they support the notion of progression from simpler setups towards the more complex.

Figure A-3: Types of Channel Relationships⁴

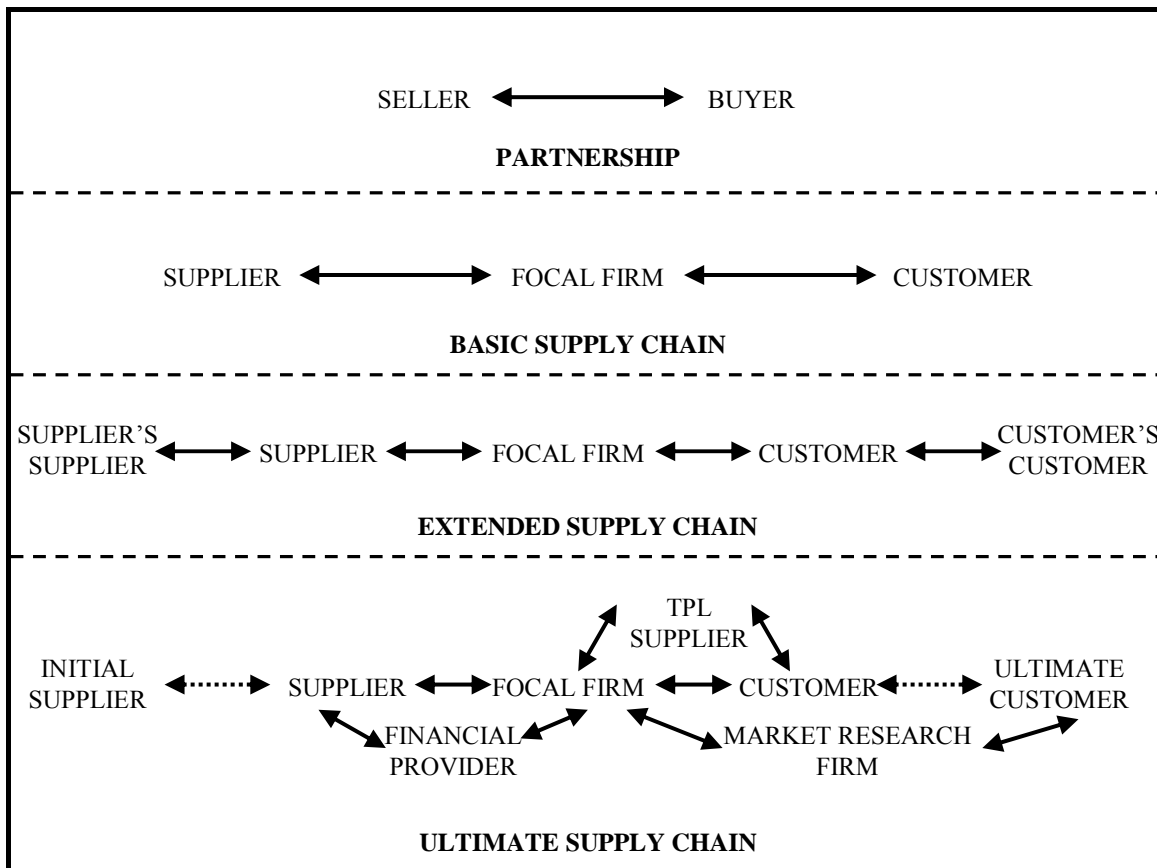

Together these selected contributions describe a number of requirements for a typology of SCM, but a few are missing:

- it is often emphasized that the key to SCM are long, trust-based relationships (e.g. Cooper, Lambert, & Pagh, 1997; Mentzer et al., 2001; Sahay, 2003),
- the use of various IT-tools and techniques are necessary to exchange information in a smooth and timely manner (e.g. Mentzer et al., 2001; Bagchi, Skjøtt-Larsen, & Sørensen, 2003), and
- the network level of management and coordination in the form of e.g. Collaborative Planning, Forecasting & Replenishment (CPFR) (Fliedner, 2003).

⁴ Source: Figure 1 in Mentzer et al. (2001), p. 5.

A.2.2 A Supply Chain Process Maturity Model

In a contemporary contribution, Lockamy III & McCormack (2004) put forward a Supply Chain Process Maturity model. Their framework has a certain commonality with the models described above, as they suggest progression from one level to the next, insist on using business process as an entity, and imply that the supply chain structure can be designed. Their model relies on the work by the Carnegie Mellon University on software development, and utilizes the BPO Maturity Model (a model categorizing companies by the degree of internal and external process integration), see Figure A-4.

Figure A-4: The BPO maturity model⁵

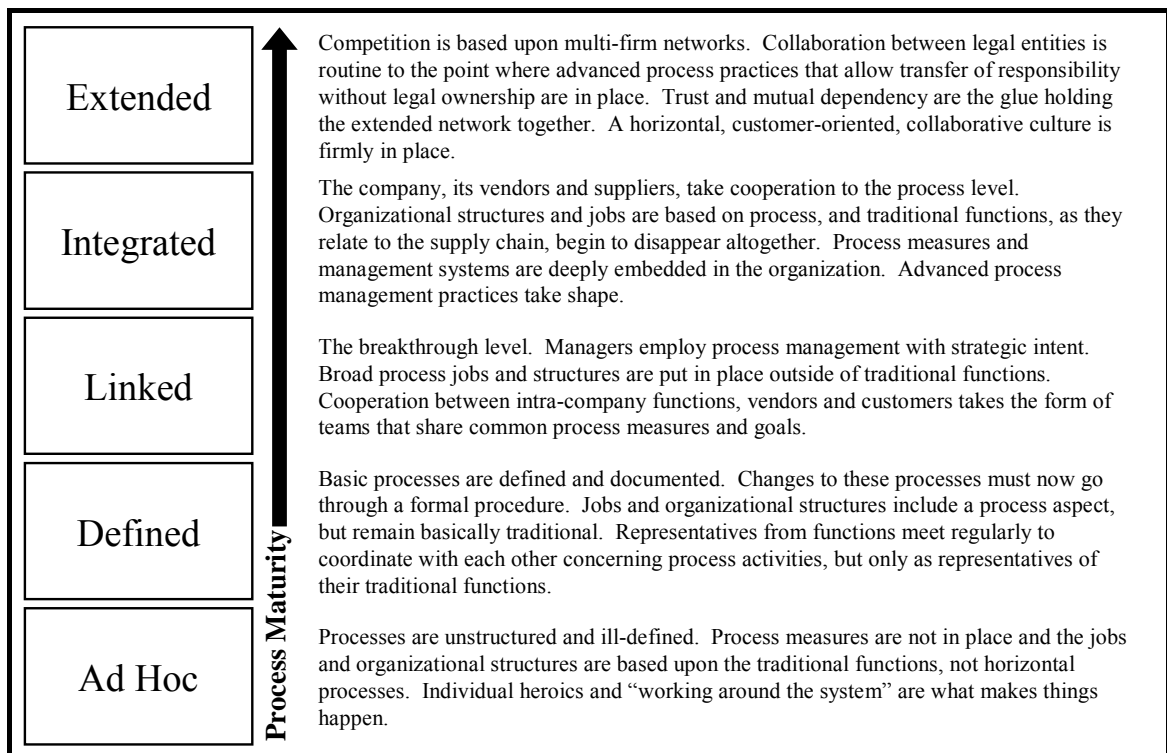

The procedures for categorizing the companies into the five levels is not described in the article, but must rely on an extensive set of variables as the description of the BPO levels include references to jobs, organizational structure, process, collaboration, cooperation, organizational behavior etc. Nonetheless, the model is operationalised using the SCOR⁶ model using the concepts Plan, Source, Make, and Deliver. Unfortunately, this operationalisation is not described in detail but only represented graphically, see Figure A-5 below.

⁵ Source: Figure 3 in Lockamy III & McCormack (2004), p. 275.

⁶ Supply Chain Operations Reference model. For more information, please see www.supply-chain.org.

Figure A-5: The supply chain maturity model⁷

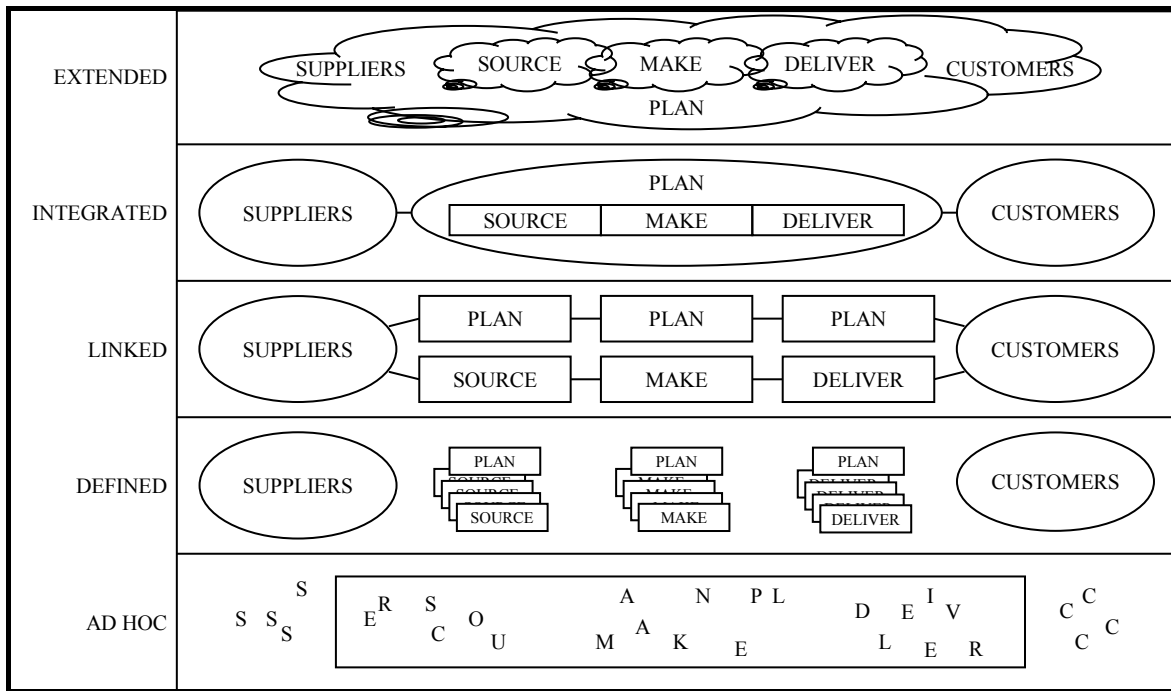

Not evident in the above figure is the level of cooperation between focal company and suppliers and customers. As the reliability of the processes improve from level to level so does the cooperation. At the top level, Extended, competition is between networks (as initially suggested by Christopher (1992)) and collaboration is routine and across legal boundaries.

A.3 Suggesting a SCM Maturity Model

However tempting it is to employ this model, it is deemed unrealistic due to the complexity and sophistication of the model. Other SCM Maturity models exist, but most appear to have a specific focus:

- In Towil, Childerhouse, & Disney (2002) a model aiming at describing the level of uncertainty reduction by means of supply chain integration is presented. The model is based on the Stevens model, and even uses the same terminology.
- Subscribing to the same notion of progression as Stevens and Mentzer et al. (but not referencing either) Fawcett & Magnan (2002) report from a study of supply chain integration. Using a multi-method empiric approach they conclude that the rhetoric and reality of SCM is pretty far apart. Unfortunately, their results on internal and external integration are reported separately, thereby making an analysis of the progression impossible. The way they report their findings are thereby possibly a consequence of their perception of progression instead of the reported levels of integration.
- Also subscribing to the Stevens model, Geary, Childerhouse, & Towill (2002) suggest a four construct model of uncertainty to describe Stage of Supply Chain Integration.

⁷ Source: Figure 4 in Lockamy III & McCormack (2004), p. 276.

Rejecting these models, either due to a narrow scope or lack of documentation, and using the assumptions documented previously, the proposed model thereby contains the following level 0 constructs: Internal, Upstream, Downstream, and Network. Following the assumption of internal integration before external, and simple networks before complex, the following model emerges. (Greyed-out box means the construct is not fulfilled).

Figure A-6: SCM Maturity Model

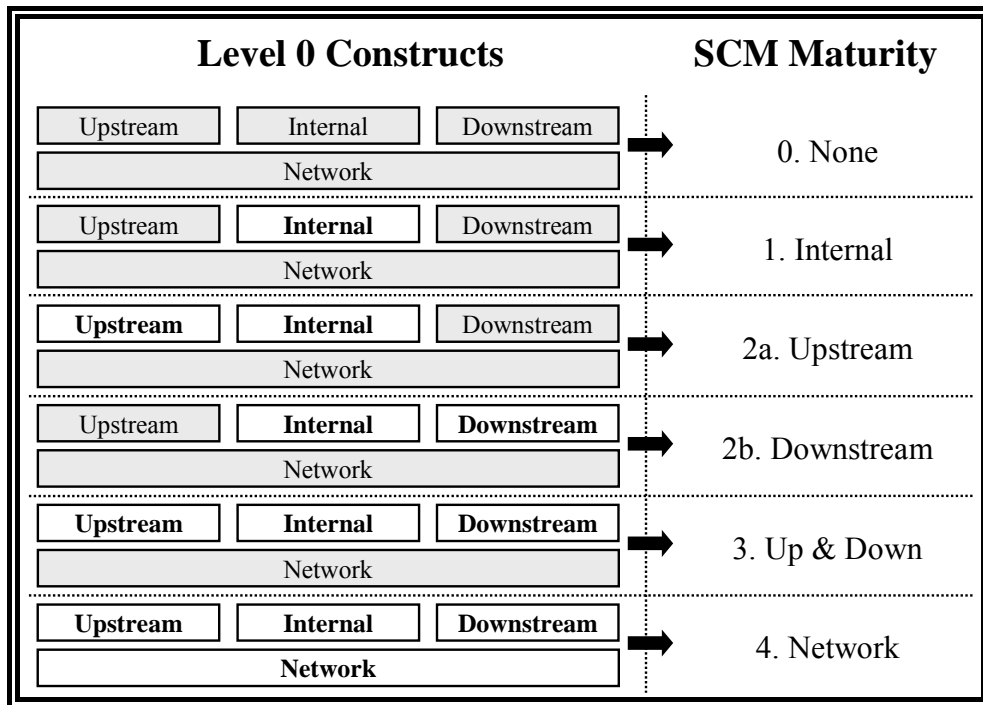

Combining the four level 0 constructs results in a six-level maturity model, describing the “path of progression” from non-SCM to the true network company. As companies possibly do not integrate up- and down-stream at the same time, levels 2a and 2b might be perceived as being parallel. The difference between level 3 and 4 is that the network company has surrendered part of the management to the network, e.g. through CPFR.

A.3.1 SCM Constructs

Applying a method routinely used within e.g. Marketing Research each of the level 0 constructs is de-composed into simpler level 1 constructs, which ultimately is broken down into separate questions (level 2 variables). Both level 1 constructs and questions at level 2 should correlate with the assumptions of SCM described above.

The level 0 construct ‘Internal’ is made up of two mandatory and one optional sub-construct. The sub-construct ‘ERP’ (marked with grey in the figure below) is optional in the sense it is not required for the construct ‘Internal’ to be fulfilled, see Table A-1 below.

Table A-1: The ‘Internal’ Construct

Level 0 (Construct)	Level 1 (Sub-construct)	Level 2 (Variable)
Internal	SCM Internally (Yes)	SCM (Yes) AND SCM Internally (Yes)
	AND	
	Process Orientation (Yes)	Process Orientation (Yes) AND Process Names (Acceptable)
	AND/OR (Optional)	
	ERP (Yes)	ERP (Yes) AND ERP Systems (Acceptable)

The variables ‘Process Names’ and ‘ERP Systems’ differ from the rest in the sense the value of these variables are dependent on the subjective evaluation of the researcher. ‘Process Names’ are deemed acceptable when the process names describe a collection of activities reaching outside and across the traditional functions. A process name like ‘Invoicing’ will thereby not fulfill the criterion whereas the process name ‘Fulfillment’ will. In a similar subjective manner the use of ERP systems is evaluated for each respondent.

Table A-2: The ‘Upstream’ Construct

Level 0 (Construct)	Level 1 (Sub-construct)	Level 2 (Variable)
Upstream (Yes)	SCM Upstream (Yes)	SCM (Yes) AND SCM w/Suppliers (Yes)
	AND	
	Social Integration (Yes)	Frequency of Meetings (>= 4 / year)
	AND	
	History (Yes)	Long Relationships (Yes) AND Longest Relationship (>= 5 years) AND Avg. Relation Length (>= 5 years)
	AND/OR (Optional)	
	IT Integration (Yes)	EDI w/Suppliers (Yes) AND EDI Doc Types (Acceptable)

The level 0 constructs ‘Upstream’ and ‘Downstream’ are identical (except for the actors), and also contain elements for subjective evaluation. The criteria for ‘Frequency of meetings’, ‘Longest relationship’, and ‘Average relationship length’ are all very subjective and do not have a strict academic justification - their values are based on the subjective opinion of the researcher.

Table A-3: The ‘Downstream’ Construct

Level 0 (Construct)	Level 1 (Sub-construct)	Level 2 (Variable)
	SCM Downstream (Yes) ←	SCM (Yes) AND SCM w/Customers (Yes)
	AND	
	Social Integration (Yes) ←	Frequency of Meetings (>= 4 / year)
	AND	
Downstream (Yes) ←	History (Yes) ←	Long Relationships (Yes) AND Longest Relationship (>= 5 years) AND Avg. Relation Length (>= 5 years)
	AND/OR (Optional)	
	IT Integration (Yes) ←	EDI w/Customers (Yes) AND EDI Doc Types (Acceptable)

The last construct ‘Network’ is somewhat simpler as it has only one level 1 construct, consisting of only three level 2 questions, see Table A-4 below.

Table A-4: The ‘Network’ Construct

Level 0 (Construct)	Level 1 (Sub-construct)	Level 2 (Variable)
Network (Yes) ←	CPFR (Yes) ←	CPFR (Yes) AND CPFR w/Suppliers (Yes) AND CPFR w/Customers (Yes)

From these de-composed constructs the maturity of the SCM practices are to be measured. The other element, Risk Management, needs to be measured as well.

A.3.2 Risk Management Constructs

Following the considerations on the sophistication of the model on SCM, the framework for describing the risk management practices is designed for a minimum of complexity as only a basic test of the measurement is required at this stage of the research project.

The model will capture the critical risks as identified by the respondents, describing them by only three variables: ‘Level’, ‘Probability’ and ‘Impact’. The variables ‘Impact’ and ‘Probability’ are quite straightforward, whereas ‘Level’ requires an explanation.

The variable can hold three values: ‘Network’, ‘Strategic’, and ‘Operational’. The former refers to risks challenging the network or originates from the network in which the company is an integrated part. The latter refers to the interruption of the normal operation in terms of disruptions of input, break-down of machinery etc. The last value refers to the risks

challenging the current structure or the long-term plans of the company not covered in the 'Network' class.

To collect the information in the questionnaire three matrices are created, one for each value of the variable 'Level'. By "placing" a risk in one of the three matrices, the respondent thereby identifies the level. Each matrix contains 'Impact' on the one axis and 'Probability' on the other, classified by the dichotomy High/Low.

A.3.3 The Initial Questionnaire

From these constructs and variables a questionnaire was designed, containing four segments: A. Company/Interviewee, B. Supply Chain Management, C. Supply Chain Integration, and D. Risk Management (see section A.8).

The first section is to capture the name of the company and the name and position of the interviewee. The second section is designed to capture information on processes and quantitative information on the participants in SCM cooperation. The interviewee is asked to name processes implemented, if any. Additionally, it is inquired for customers and suppliers separately, the total number in the portfolio, how many of these participate in SCM, and the duration of the longest and the average of relationship. The third section tries to capture another aspect of SCM as it inquires about the internal systemic integration (ERP systems), the social integration, and external systemic integration (exchange of EDI-documents) with customers and suppliers. The last section investigates the formalization of Risk Management, and asks the interviewee to name the most critical risks threatening the continued existence and development of his/her company. The risks identified are thereafter to be classified according to level (network, strategic, operational), impact (high, low), and probability (high, low) as described in the previous section.

A.4 The CLM⁸ Pilot Study

The first pilot study was performed in cooperation with Council of Logistics Management at an ordinary quarterly meeting (March 11th, 2003), hosted by KPMG Consulting. The themes for the meeting were "Supply Chain for Military and Business Operations – Failure is not an option" and "Similarities and Differences in Requirements for Planning and Quality".

Besides consultants and academics, twelve companies participated in the seminar – they all agreed to take part in the study. Of the twelve companies two were software companies interested in supplying solutions within logistics and SCM (shown in bold and italics in the table below). It quickly became apparent, that these two companies did not practice SCM themselves – it therefore did not make any sense for them to fill in the questionnaire. The

⁸ Council of Logistics Management (CLM) is an American organization, originally founded in 1963 as National Council of Physical Distribution Management (NCPDM) by a group of educators, consultants, and managers who envisioned the integration of transportation, warehousing, and inventory as the future of the discipline. CLM has been represented in Denmark since 1996, and has approx. 30 professionals as members. For more information on CLM, please refer to www.clm1.org. Since then the organization has changed name to Council of Supply Chain Management Professionals (CSCMP), see www.cscmp.org.

remaining ten companies were quite diverse as the group consisted of four wholesalers, two manufacturers, two retailers, and two logistics service providers.

Table A-5: Participants in the CLM Pilot Study⁹

ID	Company Person	Industry (NACE Classification)	Rev.	Emp.
PF1-01	Carl F A/S Lars Richter-Olesen	5154 Wholesale of hardware, plumbing and heating	78	275
PF1-02	Sanistaal A/S Per Thomsen	5152 Wholesale of metals and metal ore	501	1.405
PF1-03	LEGO SYSTEM A/S Jørgen Hursted Nielsen	3650 Manufacture of games and toys	574	3.202
PF1-04	LMG A/S Else Vibeke Lauridsen	5154 Wholesale of hardware, plumbing and heating	136	108
PF1-05	K. V. Tjellesen A/S Keld Grünfeld	5146 Wholesale of pharmaceutical goods	438	N/A
PF1-06	QVALE LOGISTIK DK A/S Oli Jørgen Bergsrud	5190 Other wholesale	19	63
PF1-07	SUPERFOS PACKAGING A/S Lars Kold	2522 Manufacture of plastic packing goods	47	348
PF1-08	Unwired Factory Morten Bentzen	-	-	-
PF1-09	MERLIN A/S John Hansen	5248 Other retail sale in specialised stores	173	468
PF1-10	Alfa Laval Corporate AB Knud Midtgaard	7415 Management activities of holding companies	500	1.891
PF1-11	JDA Software Per Juul Ulrich	-	-	-
PF1-12	Jysk A/S Troels F. Larsen	5244 Retail sale: furniture, lighting eq. & household	287	992

After a brief introduction to the study and the part of the presentation focusing on the internal practices a heated discussion started. Problems on identifying the requirements for “proper” SCM were raised as was the opinion that the position in the chain should be included in the analysis. One participant insisted that measuring SCM should include measures on the individual process, as the importance of different processes will vary from company to company, and classifying the company from an overall description of process orientation was too simplistic. It was evident that the companies themselves had problems identifying the criteria by which their SCM practices should be measured. After some discussion and a look on the second part of the questionnaire it was agreed that the questionnaire should be filled in, as it captured most of the critical information after all.

After the second part of the presentation, an intense debate on the nature and importance of relationships with customers and suppliers took place. Most participants agreed that long relationships were of value to their company, only a few objected advocating for short-term contracts and close evaluation.

The use of IT integration was another issue lively discussed - some claimed it was a necessity for operating in the first place, others described their IT solutions as poor and limiting their interaction with customers and suppliers. Discussions were stopped after an overrun of about

⁹ Data from the AMADEUS database, accessed 28-09-2004. Revenue in mio. USD.

½ hour, and it was concluded that the questions posed in the study must have “struck a nerve”. The subsequent analysis of the questionnaires documented the discussions and disagreements.

A.4.1 Results – Supply Chain Management

The first surprising result was that not all companies indicated working with SCM. Looking closer at the companies not working with SCM revealed that one (PG1-06) was a transportation company, one (PG1-07) was a manufacturer of packaging material, and one (PG1-09) was a retailer. Apparently the concept of SCM had no appeal to the retailer (one might speculate if concepts like QR, ECR or the like have been implemented instead)? Also surprising, the implementation of processes did not seem to correspond too closely with the implementation of SCM as companies not using SCM were reporting working process oriented and vice versa. The names of the processes displayed a close resemblance to traditional department names, e.g. Sales, Purchasing etc. Only two companies (PG1-04, PG1-06) seem to have an appropriate process in place, but neither seem to have SCM co-operations (the former has implemented SCM but does not cooperate with anybody, the latter does not work with SCM).

The use of ERP systems, on the other hand, appears to be pretty common. Some of the companies have multiple (standard) ERP systems in place, others combine an ERP system with own systems, and still others use only own systems. The multiplicity of systems is a bit surprising as the dominance of ERP systems like SAP, Baan, and Navision is treated as a fact within the discipline¹⁰. Of the systems mentioned only SAP, Movex, and Navision are recognized as “real” ERP systems, giving the advantage of internal integration and process support. The use of multiple ERP systems limits the flexibility of the implementation in restricting changes due to e.g. high complexity and high cost. Companies using multiple ERP systems therefore often define the usage areas based on functional areas, organizational division, or other distinctly defined boundaries. Other systems like BPCS are older, functionally/module oriented systems based on transactions processing instead of process support. Systems designed and developed specifically to a company have the same characteristics in terms of process support and internal integration. What appeared to be a good coverage of ERP systems is thereby diminished to a single company (PG1-12). Table A-6 below summarizes the answers.

¹⁰ The author has worked for about 15 years within the IT industry, hereof from 1995 till 2002 as a SAP consultant. Statements about the industry are based on this background knowledge.

Table A-6: SCM, Processes, and ERP Support

ID	SCM?	Int.?	Sup.?	Cus.?	Proc.?	Which	ERP?	Which
PF1-01	✓	✓	✓	☐	☐	-	(✓)	Astra (AS/400)
PF1-02	✓	☐	☐	☐	✓	Customer specific	(✓)	Own
PF1-03	✓	✓	✓	✓	✓	(none)	☐	-
PF1-04	(✓)	☐	☐	☐	✓	Fulfilment	(✓)	Guide
PF1-05	✓	☐	✓	✓	✓	Purchasing, Order, Distribution	(✓)	Navision: Finance Own: Logistics
PF1-06	☐	-	-	-	✓	Fulfilment	(✓)	ASW & E3
PF1-07	☐	-	-	-	✓	Sales, Demand, Order, Purch., Manuf.	(✓)	Own
PF1-09	☐	-	-	-	☐	-	☐	-
PF1-10	✓	✓	✓	✓	✓	Demand, Order, Supply	(✓)	BPCS, Movex, Jeeves, Scala
PF1-12	✓	✓	☐	✓	✓	(none)	✓	SAP

A.4.2 Results – Supply Chain Integration

Analyzing the answers on the relationships with suppliers and customers reveal a higher degree of homogeneity as all participants confess having long lasting relationships with suppliers and all but one (PG1-09) with their customers as well. The reported ratio between the total number of suppliers and the number of “close” suppliers is as expected, even if two companies (PG1-04, PG1-05) stand out. These two have comparably small supplier portfolios, thereby enabling a close relationship to most or even all suppliers¹¹. As expected the analysis of the customer portfolio shows a higher degree of diversity. Being a retailer (PG1-09, PG1-12) results in serving a large mass of anonymous customers, whereas e.g. wholesalers in highly regulated markets (PG1-05) or manufacturers of specialized good (PG1-07) have smaller customer portfolios.

Albeit all confess having long lasting relationships, the length of the relationships varies a lot. All but one (PG1-01) report relationships with suppliers in excess of ten years. Conversely, the average length of relationship with a supplier is less accessible, as only half of the participants have answered. Except for one company (PG1-01) the average length of relationship is very long, indicating a high degree of stability.

The customer portfolios show more or less the same results, even if the information available is slightly less. The retailers (PG1-09, PG1-12) have less detailed knowledge on their customers for obvious reasons, and few (PG1-01, PG1-03, PG1-05) have an estimate on the average length of relationship with customers. The length of the longest relationship with customers is comparable with the information on the suppliers. For more detail, see Table A-7 below.

¹¹ It might be interesting to investigate if PG1-04 and PG1-05 have reduced the supplier portfolio recently or if the industry displays such high degree of stability as reported by at least PG1-05.

Table A-7: Number and Length of Relationships

ID	-----Suppliers-----					-----Customers-----				
	Long Rel.?	# Suppliers Total	Longest	Rel. Length Avg.		Long Rel.?	# Customers Total	Longest	Rel. Length Avg.	
PF1-01	✓	6.00	20	2-3	1-2	✓	12.000	10	2-3	1-2
PF1-02	✓	4.000	<10	>10	?	✓	18.000	Few	>5	?
PF1-03	✓	>1.000	10	40	20	✓	?	>10.000 ¹²	50	20
PF1-04	✓	400	300	?	?	✓	?	?	?	?
PF1-05	✓	150	150	20	10	✓	100	70	20	10
PF1-06	✓	370	30	15	?	✓	2 á 25	?	15	?
PF1-07	✓	50-100	10	>20	?	✓	1.200	50	>20	?
PF1-09	✓	120	15	50	10	✓	?	-	-	-
PF1-10	✓	3.000	>100	>15	?	✓	>5.000	Many	+15	?
PF1-12	✓	?	>15	25	15	✓	?	?	?	?

Even if long relationships apparently are the norm, collaborative planning is not. Only three of the ten companies are cooperating with suppliers and customers on planning, and one of these (PG1-04) must rely heavily on e.g. IT-systems as they rarely have meetings with suppliers and customers. The other two (PG1-03, PG1-12) meet frequently with suppliers and customers both. Segmentation of the portfolio is more frequent on the customer side (eight of ten) compared to the supplier side (five of ten). Comparing the frequency of meetings with suppliers with the frequency for customers does not reveal any apparent correlations. If frequent meetings are defined as meeting at least quarterly only three to five companies have frequent meetings with suppliers and four to six have frequent meetings with customers. The companies who differentiate do not seem to meet with customers and suppliers more frequently than the companies not differentiating. Table A-8 below summarizes the results.

Table A-8: External Relationships

ID	---Collab. Planning---			-----External Relations (Meetings)-----			
	CPFR?	Sup.?	Cus.?	Diff.?	How Often?	Diff.?	How Often?
PF1-01	<input type="checkbox"/>	-	-	✓	1 / 6-8 per year	✓	1-12 per year
PF1-02	<input type="checkbox"/>	-	-	✓	?	✓	?
PF1-03	✓	✓	✓	<input type="checkbox"/>	Monthly	✓	Monthly & Weekly
PF1-04	✓	✓	✓	<input type="checkbox"/>	2 per year	<input type="checkbox"/>	?
PF1-05	<input type="checkbox"/>	-	-	<input type="checkbox"/>	Rarely	✓	1-2 per year
PF1-06	<input type="checkbox"/>	-	-	<input type="checkbox"/>	Max 1 per year	✓	Monthly
PF1-07	<input type="checkbox"/>	-	-	✓	0-5 per year	✓	0-5 per year
PF1-09	<input type="checkbox"/>	-	-	✓	Avg: monthly	<input type="checkbox"/>	Never
PF1-10	<input type="checkbox"/>	-	-	<input type="checkbox"/>	?	✓	2 per year
PF1-12	✓	✓	✓	✓	Weekly & monthly	✓	Monthly & Quarterly

The use of EDI/XML exchanges is without doubt the most homogenous area uncovered by the questionnaire. All but one (PG1-03) have EDI/XML exchanges and most companies exchange documents in both directions (up- and down-stream). The documents most commonly exchanged are orders and invoices (6 companies), other types include delivery

¹² Not sure if this was a mistake?

notices, order confirmations, payments and various purchasing information. Besides customers and suppliers, one (PG1-07) exchange documents with the bank, another (PG1-10) with transporters. See Table A-9 below for more detail.

Table A-9: Exchange of Electronic Documents

ID	EDI?	Sup.?	Cus.?	Other	Document Types
PF1-01	✓	✓	☐		Purchase orders, Incoming invoices, Purchase data
PF1-02	✓	✓	✓		Orders, Invoices, various notices
PF1-03	☐	-	-	-	-
PF1-04	✓	✓	✓		Purchase orders, Invoices
PF1-05	✓	✓	✓		Orders, Order confirmations, Delivery notices
PF1-06	✓	☐	✓		Orders, Delivery notices
PF1-07	✓	✓	✓	Banks	Orders, Invoices, Payments
PF1-09	✓	✓	☐		Orders, Invoices
PF1-10	✓	✓	✓	Transporters	Orders, Invoices
PF1-12	✓	(✓)	✓		Delivery notices, Invoices

Having described the results from the questionnaire the build-up of constructs will unveil the fit between assumed and realized interdependencies of variables, and the progression in SCM practices.

A.4.3 Identifying SCM Maturity

Analyzing the results is a process of updating the multi-level model, one level at a time from the bottom up. The construct definitions in use here is extremely restrictive as few (in most cases: one) combinations of a large number of variables is required to fulfill a construct. A vast amount of information will be lost unless the values of each level 2 variable and the entire hierarchy of constructs are made available. For the sake of clarity all steps in the analysis is reported.

Each level 2 variable is updated, following an evaluation if necessary. This enables the update of the level 1 constructs by using the criteria as described in section A.3 above and an evaluation of the “fit” between the level 2 questions and their “parent” level 1 constructs is made possible. After updating the level 1 constructs the level 0 constructs can be updated similarly. Table A-10 below gives an overview of all level 1 constructs, Table A-11 shows the level 0 constructs and the resulting maturity level.

Table A-10: Level 1 Constructs

ID	-----Internal-----			-----Suppliers-----				-----Customers-----				---Network---
	SCM?	Proc?	ERP?	Social	IT	Social	IT	Social	IT	CPFR?		
PF1-01	✓	□	□	✓	(✓)	□	✓	□	(✓)	□	□	□
PF1-02	□	□	□	□	□	□	✓	□	□	□	✓	□
PF1-03	✓	□	□	✓	✓	✓	□	✓	✓	✓	□	✓
PF1-04	□	✓	□	□	□	□	✓	□	□	□	✓	✓
PF1-05	□	□	□	✓	□	✓	✓	✓	□	✓	✓	□
PF1-06	□	✓	□	□	□	□	□	□	✓	□	✓	□
PF1-07	□	□	□	□	(✓)	□	✓	□	(✓)	□	✓	□
PF1-09	□	□	□	□	✓	✓	✓	□	□	□	□	□
PF1-10	✓	□	□	✓	□	□	✓	✓	□	□	✓	□
PF1-12	✓	□	✓	□	✓	✓	□	✓	✓	□	✓	✓

Table A-11: Level 0 Constructs and Maturity Level¹³

ID	Internal?	Upstream?	Downstream?	Network?	Maturity Level	Consistent w/ Model ?
PF1-01	□	□+	□+	□	No SCM	✓ (except IT)
PF1-02	□	□+	□+	□	No SCM	✓ (except IT)
PF1-03	□	✓	✓	✓	No SCM	□
PF1-04	□	□+	□+	✓	No SCM	□
PF1-05	□	□+	□+	□	No SCM	✓ (except IT)
PF1-06	□	□	□	□	No SCM	✓
PF1-07	□	□+	□+	□	No SCM	✓ (except IT)
PF1-09	□	□+	□+	□	No SCM	✓ (except IT)
PF1-10	□	□+	□+	□	No SCM	✓ (except IT)
PF1-12	□+	□	□	✓	No SCM	□

From Table A-11 above it is evident that the construct definitions are too restrictive as all companies are at the lowest maturity level. The top level constructions are only consistent with the model when none of the level 0 constructs are set, all others (PG1-03, PG1-04, PG1-12) are inconsistent as they do not have the ‘Internal’ construct set. The use of IT internally and externally seems to directly contradict the assumption that IT supports the organizational arrangements. Perhaps the logic of efficiency through the use of IT is de-coupled from the logics of SCM? The assumption that process orientation is a prerequisite for internal integration/SCM does not correspond well to the observed practices. Relaxing this requirement will change the Maturity Level quite a lot as three companies (PG1-01, PG1-10, PG1-12) will become ‘Internal’ and one (PG1-03) will become ‘Network’ and be consistent with the model, see Table A-12 below.

¹³ A ‘+’ indicates the optional criteria are fulfilled. E.g. in ‘Internal’ it indicates the support of processes through the presence of an ERP system.

Table A-12: Level 0 Constructs and Maturity Level (Relaxing Req's on Internal)

ID	Internal?	Upstream?	Downstream?	Network?	Maturity Level	Consistent w/ Model ?
PF1-01	✓	<input type="checkbox"/> +	<input type="checkbox"/> +	<input type="checkbox"/>	Internal	✓ (except IT)
PF1-02	<input type="checkbox"/>	<input type="checkbox"/> +	<input type="checkbox"/> +	<input type="checkbox"/>	No SCM	✓ (except IT)
PF1-03	✓	✓	✓	✓	Network	✓
PF1-04	<input type="checkbox"/>	<input type="checkbox"/> +	<input type="checkbox"/> +	✓	No SCM	<input type="checkbox"/>
PF1-05	<input type="checkbox"/>	<input type="checkbox"/> +	<input type="checkbox"/> +	<input type="checkbox"/>	No SCM	✓ (except IT)
PF1-06	<input type="checkbox"/>	<input type="checkbox"/>	<input type="checkbox"/>	<input type="checkbox"/>	No SCM	✓
PF1-07	<input type="checkbox"/>	<input type="checkbox"/> +	<input type="checkbox"/> +	<input type="checkbox"/>	No SCM	✓ (except IT)
PF1-09	<input type="checkbox"/>	<input type="checkbox"/> +	<input type="checkbox"/> +	<input type="checkbox"/>	No SCM	✓ (except IT)
PF1-10	✓	<input type="checkbox"/> +	<input type="checkbox"/> +	<input type="checkbox"/>	Internal	✓ (except IT)
PF1-12	✓ +	<input type="checkbox"/>	<input type="checkbox"/>	✓	Internal	<input type="checkbox"/>

In the analysis of the formalization of Risk Management and the risks identified both sets of classifications will be used.

A.4.4 Practices on Risk Management

The questions posed on Risk Management can be divided in two groups: questions on the identifiable organization around Risk Management, and the personal perception of critical risks. The former aims at unraveling the current level of formalization whereas the latter will describe the awareness in the organization. The former might be perceived as a top-down construct whereas the latter is a bottom-up. The critical risks reported are to be classified as described earlier, by placing the risk in one of twelve cells (three matrices with two by two cells each).

Albeit all participants at the beginning of the presentation said that Risk Management was of critical importance to the modern enterprise, almost half of them report their company does not work actively with it. In three of the four companies the responsibility is placed at the top management. In one instance (PF1-09) it seems that the Risk Management reported is more correctly described as Project Risk Management. For the other three meetings are rare, if any at all. The formalization of Risk Management thereby seem to best almost absent, which was confirmed during the discussions. Of the participating companies only one had a Risk Manager (PF1-03), and that position was primarily concerned with the procurement of insurance.

Analyzing the (personal) perceptions of the critical risks documents a similar absence of attention. Most of the risks reported are generic risks such as IT¹⁴ (PF1-02 #3, PF1-04 #1, PF1-05 #3, PF1-06 #2), supply stability (PF1-02 #2, PF1-10 #1), ability to deliver (PF1-03 #1, PF1-04 #2, PF1-07 #3, PF1-09 #1), competency/HR (PF1-01 #2-3, PF1-06 #3), and anonymous external events (PF1-02 #1, PF1-06 #4, PF1-07 #1, PF1-12 #3). The idiosyncratic risks are limited to the risk of losing a transporter (PF1-01 #4), the threat

¹⁴ The high frequency of IT-related risks is interesting, not least in terms of investigating the level of implementation of Business Continuity. Albeit some authors claim Business Continuity is much more than IT-security, the vast majority of articles on the subject is on IT security and recovery (e.g. Savage, 2002; Turner, 2003).

imposed by an unbalanced customer portfolio (PF1-06 #1), and fire at own (PF1-12 #2) and the suppliers' facilities (PF1-12 #1).

The classification of the risks seem to have failed as only four (4!) of the 28 risks mentioned have been correctly classified. About one third of the invalid answers can be explained by insufficient instructions as the questionnaires contain x's instead of the number referencing the critical risks. The same number of risks lacked an answer, documenting the difficulty or lack of access to probabilities, impact and strategy. Overall this section of the questionnaire documented the lack of communication of relevant risks faced by the companies.

Table A-13: Risk Management¹⁵

ID	Risk Mgmt?	Responsible	Freq. of Meetings?	Risks	----Risk Matrices----		
					Level	Prob.	Impact
PF1-01	☐	-	-	1. Resources/bottle necks	No answer		
				2. Competencies/knowledge	No answer		
				3. People/staff	S	H	H
				4. Transporter disappears	Invalid		
PF1-02	☐	-	-	1. Changes in the market	S	H	H
				2. Stability of supply	N	L	H
				3. IT	O	L	H
PF1-03	✓	Top Management	At least yearly	1. Ability to deliver	Invalid		
PF1-04	(✓)	Management	?	1. IT systems	No answer		
PF1-05	(✓)	VP Logistics	Frequent	2. Ability to deliver	No answer		
				1. Fire	O	?	?
PF1-06	☐	-	-	2. Water	O	?	?
				3. IT	O	?	?
				1. One large customer	Invalid		
PF1-07	☐	-	-	2. IT development	Invalid		
				3. HR development	Invalid		
				4. Globalisation	Invalid		
				5. Security/theft/break-in	Invalid		
				1. Trend/structure adjustments	No answer		
PF1-09	✓	VP Production	In project	2. Demand/capacity adjustments	No answer		
				3. Delivery lead times	No answer		
				4. Competing technology/products	No answer		
				1. Delivery problems	Invalid		
PF1-10	✓	Department heads	?	2. ???	Invalid		
				3. ???	Invalid		
				1. Supply problems	Invalid		
PF1-12	✓	CEO	-	2. Customer/supplier take-over	Invalid		
				1. Fire at suppliers site	Invalid		
				2. Fire at warehouse,	Invalid		
				3. War – loss of the Far East	Invalid		

A.4.5 Combining SCM Maturity and Risk Practices

Combining the SCM Maturity (with or without the relaxed requirements) with the Risk Practices does not result in clarification. The most advanced practitioners of SCM (PF1-01, PF1-03, PF1-10, PF1-12) seem to work actively with risk management and have some degree of formalization as three of the four work with risk management. Conversely, the other practitioners of Risk Management (PF1-04, PF1-05, PF1-09) seem to report more or less

¹⁵ Risk Matrices: Level – O = Operational, S = Strategic, N = Network; Prob. & Impact – L = Low, H = High.

identical practices. From this analysis, it is not possible to detect a difference between the two groups. The perceptions of the critical risks seem to display the same lack of systematic implementation as neither group displays distinct proof of experience with the domain.

A.4.6 Conclusion from the CLM Pilot Study

Conclusions from the first study are quite clear as many of the issues discussed are directly observable in the questionnaires. Many of the participants commented that it was difficult to fit their SCM practices with the questions on SCM in the questionnaire. A few commented that the internal implementation of SCM is unrealistic due to a number of factors – a phenomenon directly observable in the questionnaire. Additionally, the description of processes should be enhanced as the aggregated view taken in the questionnaire results in a loss of a vast amount of detail. A description of participants per process might enhance the description.

Several commented the difficulties of comparing across industries and position in the supply chain. Perhaps analyzing the companies based on similarity in size, process, and position will reveal important findings otherwise lost.

And even if the subject (risk management) was known to the participants on beforehand, none seemed to have detailed knowledge of the type and level of implementation. Analyzing the responses on the risk matrices revealed a need to better explain the differentiation between operational, strategic and network level risks.

As a consequence of the results obtained it was decided to perform yet another pilot study. To isolate the problem of identifying SCM practices the companies invited were from a short list of companies working actively with SCM, and with whom the research environment had previous experience.

Before performing the second pilot study the questionnaire and the constructs were modified according to the experience obtained through the first study.

A.5 Modifying the Research Instrument

The experience from the first study results in the modification of the maturity model and the inherent constructs both.

A.5.1 The Modified SCM Maturity Model

One of the key learning points from the first study was the fact that the internal organization is de-coupled from the external integration. The internal characteristics are thereby reported separate from the external. The first level in the model is unchanged (at this level of detail), but all subsequent levels contain the separate classifications on internal and external both.

Figure A-7: The Revised SCM Maturity Model

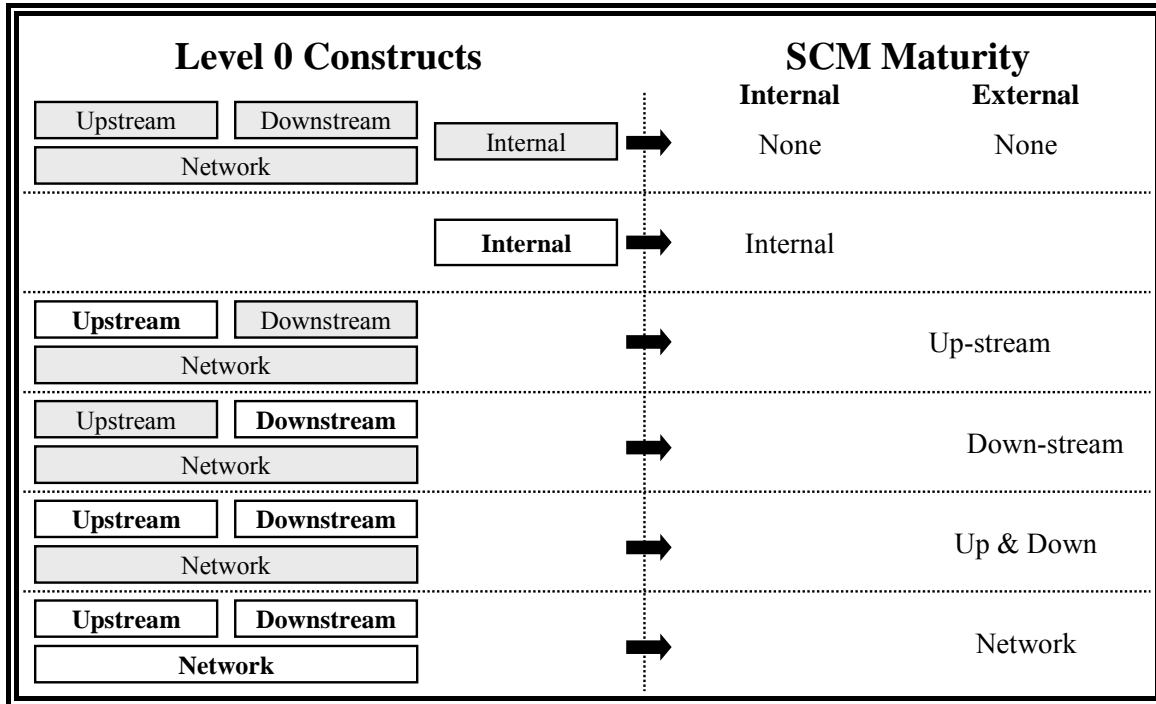

Besides the changes to the maturity model, the constructs themselves need adjusting.

A.5.2 Constructs

The ‘Internal’ construct has been changed quite a bit to reflect the criticisms described above. The top level is unchanged though, still insisting on SCM and process orientation and listing ERP as an optional construct. Enhancing the process descriptions by including a description of the participants in each process has enabled the simplification of the construct ‘SCM Internally’ to consist of the variable ‘SCM’ only. The ‘Process Orientation’ has become a bit more complex as it now consist of four variables including a measure for cross-functionality and the identification of the person or function responsible for the process. The ‘Upstream’ and ‘Downstream’ constructs have changed as the level 1 construct ‘History’ has been removed from both. All three level 0 constructs are shown below.

Table A-14: The Modified ‘Internal’ Construct

Level 0 (Construct)	Level 1 (Sub-construct)	Level 2 (Variable)
Internal	SCM Internally (Yes)	SCM (Yes)
	AND	
	Process Orientation (Yes)	Process Orientation (Yes) AND Process Names (Acceptable) AND Cross-functional (Yes) AND Responsible Defined (Yes)
	AND/OR (Optional)	
	ERP (Yes)	ERP (Yes) AND ERP Systems (Acceptable)

Table A-15: The Modified ‘Upstream’ Construct

Level 0 (Construct)	Level 1 (Sub-construct)	Level 2 (Variable)
Upstream (Yes)	SCM Upstream (Yes)	SCM (Yes) AND Processes (Acceptable) AND Suppliers in Proc’s (Yes)
	AND	
	Social Integration (Yes)	Frequency of Meetings (>= 4 / year)
	AND/OR (Optional)	
	IT Integration (Yes)	EDI w/Suppliers (Yes) AND EDI Doc Types (Acceptable)

Table A-16: The Modified ‘Downstream’ Construct

Level 0 (Construct)	Level 1 (Sub-construct)	Level 2 (Variable)
Downstream (Yes)	SCM Downstream (Yes)	SCM (Yes) AND Processes (Acceptable) AND Customers in Proc’s (Yes)
	AND	
	Social Integration (Yes)	Frequency of Meetings (>= 4 / year)
	AND/OR (Optional)	
	IT Integration (Yes)	EDI w/Customers (Yes) AND EDI Doc Types (Acceptable)

The ‘Network Characteristics’ has been changed to include a measure for adaptation, see Table A-17 below.

Table A-17: The Modified ‘Network’ Construct

Level 0 (Construct)	Level 1 (Sub-construct)	Level 2 (Variable)
		CPFR (Yes) AND CPFR w/Suppliers (Yes) AND CPFR w/Customers (Yes)
Network (Yes) ←	CPFR (Yes) ←	
	OR	
	Adaptation (Yes) ←	Adaptation (Yes) AND Area/process (Acceptable)

The questionnaire has been revised according to these changes (see section A.9). The Risk Management construct has not been amended, but the instructions and the presentation was altered to improve clarity on how to fill in this information.

A.6 The CBS Pilot Study

The second pilot study was conducted in conjunction with a seminar on SCM held at CBS on May 8th, 2003. Approx. 50 persons from 40 companies were invited all of whom the SCM research group had previous experience. As for the first pilot study the seminar contained three sessions, the session on Supply Chain Risk Management was again scheduled for 1½ hours. The presentation given was a revised version of the first one, incorporating the modifications described above. The fit between presentation and questionnaire was identical to the first seminar.

A.6.1 Population

Albeit more than twenty persons from the industry had signed up for the seminar, only ten companies were represented during the study. Of the ten companies three were deemed not suited for the study, leaving the following seven companies in the population, see Table A-18 below.

As in the first study, the presentation was performed in sessions, each session covering a part of the questionnaire. After each presentation a discussion led up to the participants filling in the corresponding part of the questionnaire.

Table A-18: Participants in the CBS Pilot Study¹⁶

ID	Company Person	Industry (NACE Classification)	Rev.	Emp.
PF2-01	Gillette Group Danmark A/S Helle Breinholt	5145 Wholesale of perfume and cosmetics	171	154
PF2-02	Post Danmark A/S Kurt Madsen	6411 National post activities	1.780	21.847
PF2-03	Arla Foods A.m.b.a. Line Grosen	1551 Operation of dairies and cheese making	6.378	17.791
PF2-04	L'Oreal Denmark A/S Lone Larsen	5145 Wholesale of perfume and cosmetics	116	228
PF2-05	Carlsberg Danmark A/S Per Barkholt	1596 Manufacture of beer	687	2.892
PF2-06	Glunz & Jensen A/S Bo Siersbæk	3340 Manufacture of optical instr. & photog. eq.	109	405
PF2-07	LEGO SYSTEM A/S Jan Stentoft Arlbjörn	3650 Manufacture of games and toys	574	3.202

A.6.2 Results

Surprisingly, two of the companies (PF2-02, PF2-05) participating in the study reported not working with SCM. The implementation of a process oriented organization again proved less frequent than the use of SCM as only two reported doing so, and two having partially implemented processes. Interestingly, even one company (PF2-06) reporting not working process oriented give names of five processes which are in place.

Interestingly, two companies (PF2-02, PF2-03) report processes that span more than the typical dyadic relationship. As the processes include up- and down-stream participants, they give the impression of a pretty advanced SCM practise. And even more interestingly, one of the two companies (PF2-03) report that the responsibility of the processes is unknown. Whether this is due to a lack of knowledge of the individual participating in the study or if the management of the processes is really on the network level, remains unknown¹⁷.

¹⁶ Data from the AMADEUS database, accessed 28-09-2004. Revenue in mio. USD.

¹⁷ The nature of the company (the national postal service) might explain the response as the company to a certain degree can be perceived as a resource owner, setting its processes and resources at the disposal of its customers. This remains an interesting hypothesis that might be explored further at a later stage.

Table A-19: SCM Processes

ID	SCM?	Proc.?	Which	Sup-2	Sup-1	Cus-1	Cus-2	Cross-funct.?	Resp.?
PF2-01	✓	(✓)	Monthly internal forecasting	<input type="checkbox"/>	<input type="checkbox"/>	<input type="checkbox"/>	<input type="checkbox"/>	✓	✓
			Monthly supply	<input type="checkbox"/>	✓	<input type="checkbox"/>	<input type="checkbox"/>	<input type="checkbox"/>	✓
			Customer claims / returns	<input type="checkbox"/>	✓	<input type="checkbox"/>	<input type="checkbox"/>	✓	✓
PF2-02	<input type="checkbox"/>	✓	Parcel sorting	✓	<input type="checkbox"/>	<input type="checkbox"/>	<input type="checkbox"/>	<input type="checkbox"/>	✓
			Sales	<input type="checkbox"/>	<input type="checkbox"/>	✓	<input type="checkbox"/>	-	✓
			Transport	✓	<input type="checkbox"/>	✓	<input type="checkbox"/>	✓	✓
			Distribution	<input type="checkbox"/>	✓	✓	<input type="checkbox"/>	✓	✓
PF2-03	✓	✓	Fulfilment	<input type="checkbox"/>	✓	✓	✓	✓	?
			Product development / control	<input type="checkbox"/>	✓	✓	<input type="checkbox"/>	✓	?
			Production planning	<input type="checkbox"/>	✓	<input type="checkbox"/>	<input type="checkbox"/>	✓	✓
PF2-04	(✓)	(✓)	Forecasting	<input type="checkbox"/>	<input type="checkbox"/>	✓	<input type="checkbox"/>	✓	✓
			Planning	<input type="checkbox"/>	✓	<input type="checkbox"/>	<input type="checkbox"/>	✓	✓
			Follow-up on service-level	<input type="checkbox"/>	✓	<input type="checkbox"/>	<input type="checkbox"/>	<input type="checkbox"/>	✓
			Communicating master-data	<input type="checkbox"/>	<input type="checkbox"/>	✓	<input type="checkbox"/>	✓	✓
PF2-05	<input type="checkbox"/>	-	-	-	-	-	-	-	
PF2-06	✓	-	Forecasting	-	-	-	-	-	-
			Planning	-	-	-	-	-	-
			Procurement	-	-	-	-	-	-
			Sales	-	-	-	-	-	-
			Development	-	-	-	-	-	-
PF2-07	✓	<input type="checkbox"/>	-	-	-	-	-	-	

The use of IT shows a much less diversified picture. All participants use ERP systems and all but one use EDI. Document types vary a bit, invoices and purchase orders are not surprisingly the most common.

Table A-20: IT Usage

ID	ERP?	Which	EDI?	Sup.?	Cus.?	Document Types
PF2-01	✓	-	✓	✓	✓	Invoices, Orders, Inventory data
PF2-02	✓	Cust. & prod. systems	✓	<input type="checkbox"/>	✓	Delivery notices, KPI's
PF2-03	✓	SAP R/2 & SAS (R3+APO)	✓	✓	<input type="checkbox"/>	Orders, Claims
PF2-04	✓	SAP	✓	✓	✓	Purchase plans, Invoices, Order, Confirm.
PF2-05	✓	SAP incl. CRM, APS etc.	<input type="checkbox"/>	-	-	-
PF2-06	✓	?	✓	✓	<input type="checkbox"/>	Forecast, Purchase orders, Invoices
PF2-07	✓	SAP (customized)	✓	✓	✓	-

Where systemic integration thereby is high, the social integration seems to be surprisingly low. About half the companies differentiate their social integration with suppliers and customers, but the frequency of meetings vary a lot. None of the participants report working with collaborative planning (CPFR), but most report having adapted processes to fit external partners. The pattern thereby is a bit surprising, as the adaptation would suggest a continued contact between partners in the supply chain.

Table A-21: Collaboration with External Parties

ID	External Relations (Meetings)				Collaboration						
	--Suppliers--		--Customers--		-----CPFR-----			-----Adaptation-----			
	Diff.?	Freq.?	Diff.?	Freq.?	CPFR?	Sup.?	Cus.?	Adap.?	Which Area/Process?		
PF2-01	✓	12-24	-	-	<input type="checkbox"/>	-	-	<input type="checkbox"/>	-		
PF2-02	<input type="checkbox"/>	12	✓	-	<input type="checkbox"/>	-	-	✓	Parcel sorting		
PF2-03	✓	>12	✓	12/?	<input type="checkbox"/>	-	-	✓	E.g. purchasing (min order qty)		
PF2-04	<input type="checkbox"/>	2	✓	2	<input type="checkbox"/>	-	-	✓	Follow-up on service level		
PF2-05	✓	Ad hoc	✓	-	<input type="checkbox"/>	-	-	✓	Forecasting		
PF2-06	✓	4/1	?	?	<input type="checkbox"/>	-	-	-	-		
PF2-07	?	?	?	?	<input type="checkbox"/>	-	-	✓	Distribution		

The next step is to determine the SCM Maturity according to the modified model.

A.6.3 Identifying SCM Maturity

Analogous to the method applied previously, the constructs are updated from the bottom up. As in the first study, the results show a lack of consistency between data and the model, as two of the companies claim to work with SCM but are not process oriented. Looking at the integration up- and down-stream it is obvious that the systemic integration does not correlate with the other types of integration. And it is furthermore evident that social integration and SCM does correlate either.

One way of interpreting the types of integration in place is that the supply chains have already been aligned, but this is contradicted by the level of process orientation. A more likely interpretation is that cooperation is still at a quite low level, albeit the systems seem to be integrated to some degree. The implementation of IT solutions is perceived less “dangerous” than the integration of processes (or even the implementation of processes in the individual organization). If this is correct, Stevens’ assumption is incorrect, and SCM is to be found in the interface between companies instead of across the activities performed in the participating companies. Table A-22 below summarizes the results.

Table A-22: Level 1 Constructs¹⁸

ID	-----Internal-----			-----Suppliers-----			-----Customers-----			-----Network-----	
	SCM?	Proc.?	ERP?	SCM?	Social	IT	SCM?	Social	IT	CPFR?	Adapt.?
				Integ.?		Integ.?	Integ.?		Integ.?		
PF2-01	✓	✓	<input type="checkbox"/>	✓	✓	✓	<input type="checkbox"/>	<input type="checkbox"/>	✓	<input type="checkbox"/>	<input type="checkbox"/>
PF2-02	<input type="checkbox"/>	<input type="checkbox"/>	<input type="checkbox"/>	<input type="checkbox"/>	✓	<input type="checkbox"/>	<input type="checkbox"/>	<input type="checkbox"/>	✓	<input type="checkbox"/>	✓
PF2-03	✓	✓	✓	✓	✓	✓	✓	(✓)	<input type="checkbox"/>	<input type="checkbox"/>	✓
PF2-04	✓	✓	✓	✓	<input type="checkbox"/>	✓	✓	<input type="checkbox"/>	✓	<input type="checkbox"/>	✓
PF2-05	<input type="checkbox"/>	<input type="checkbox"/>	✓	<input type="checkbox"/>	<input type="checkbox"/>	<input type="checkbox"/>	<input type="checkbox"/>	<input type="checkbox"/>	<input type="checkbox"/>	<input type="checkbox"/>	✓
PF2-06	✓	<input type="checkbox"/>	<input type="checkbox"/>	<input type="checkbox"/>	(✓)	✓	<input type="checkbox"/>	<input type="checkbox"/>	<input type="checkbox"/>	<input type="checkbox"/>	<input type="checkbox"/>
PF2-07	✓	<input type="checkbox"/>	✓	<input type="checkbox"/>	<input type="checkbox"/>	<input type="checkbox"/>	<input type="checkbox"/>	<input type="checkbox"/>	✓	<input type="checkbox"/>	✓

Even if the constructs have been modified, still a lot of information is being discarded, albeit a bit less than previously. Of the five companies claiming to work with SCM, only three

¹⁸ Strictly speaking the column ‘SCM?’ should not be reported here, as it references a variable, not a construct.

qualify for the ‘Internal’ construct as two of them do not work process oriented. In comparison, no companies from the first study qualified for the construct.

On the upstream side only two companies qualify for the construct, de-qualifying three companies with either SCM or social integration, but not both. Interestingly both combinations exist. On the downstream side only one company pass the test.

Finally, on the network construct a staggering five companies qualify for the construct as all except two companies report having adapted processes to fit external partners. The table below summarizes the top level constructs and the resulting maturity levels.

Table A-23: Level 0 Constructs and Maturity Level

ID	Internal	Upstream	Downstream	Network	---Maturity Level---		Consistent w/ Model ?
					Internal	External	
PF2-01	✓	✓+	□+	□	Internal	Upstream	✓ (except IT)
PF2-02	□	□	□+	✓	No	No	□
PF2-03	✓+	✓+	✓	✓	Internal	Network	✓
PF2-04	✓+	□+	□+	✓	Internal	No	□
PF2-05	□+	□	□	✓	No	No	□
PF2-06	□	□+	□	□	No	No	✓
PF2-07	□+	□	□+	✓	No	No	□

In Table A-23 above it is evident that the progression suggested in the maturity model is absent as four out of seven does not fit the model. Three companies (PF2-02, PF2-04, PF2-05) have network characteristics (due to the claim adaptation of processes) but does not have the requested up- or down-stream characteristics. The use of the adaptation requirement in the network construct thereby seems to blur the picture instead of providing clarity and insight. Ignoring the network construct and subsequently re-evaluating the consistency with the model results in a perfect fit between the constructs and the model, see Table A-24 below.

Table A-24: Level 0 Constructs and Maturity Level (Relaxing Req’s on Network)

ID	Internal	Upstream	Downstream	Network	---Maturity Level---		Consistent w/ Model ?
					Internal	External	
PF2-01	✓	✓+	□+	%	Internal	Upstream	✓ (except IT)
PF2-02	□	□	□+	%	No	No	✓
PF2-03	✓+	✓+	✓	%	Internal	Up & Down	✓
PF2-04	✓+	□+	□+	%	Internal	No	✓
PF2-05	□+	□	□	%	No	No	✓
PF2-06	□	□+	□	%	No	No	✓
PF2-07	□+	□	□+	%	No	No	✓

On the other hand it is evident that the de-coupling of the internal and external constructs is unnecessary, at least with this population. It seems quite difficult to adjust the model to fit the empirical data.

A.6.4 Practices on Risk Management

As in the first study, all participants claimed that Risk Management is of critical importance for the modern enterprise, only two companies (PF2-02, PF2-06) report having a formal routines and/or structure in place. In the case of the former a position exists but meetings on

Risk Management is infrequent, whereas the latter list a number of departments as responsible but claim meetings are frequent and regular. All other companies report not working with Risk Management. The discrepancy between the rhetoric and the reality of the practices on Risk Management (at least the formal part) is extreme.

The personal perception of the risks faced by the companies is much better documented in the second study than in the first as the classification of the risks have improved dramatically. Only six answers are invalid and four have no classification leaving fourteen risks with full information.

Of the fourteen risks only two are operational (PF2-02 #1, PF2-03 #1) and three are at the network level (PF2-01 #2, PF2-03 #3, PF2-05 #1). Interestingly, all three at the network level reference supply failure in some form, questioning whether this category provides clarity or confusion to the classification of the risks. The discussion on the Risk Management section of the questionnaire (and presentation) supports this suspicion. The term network might have been an unwise choice as it apparently has many translations, and might have been translated into “supply network” in this context. The term “supply chain” might have been a wiser choice.

Even more interestingly, the risks identified by the respondent are predominantly low probability, high impact risks at the strategic (or network) level. Only three risks are reported as high probability, and only one is reported as low impact. The disproportion in the replies is a well-known phenomena within Risk Management and might in this context be explained by the desire to justify the lack of management of the risk (the low probability) and their identification of the risk (its importance in terms of impact). The analysis and description of these mechanisms are clearly outside the scope of this study.

The risks reported seem to lack commonality except at the most overall level, as only one theme, supply management, can be identified among the risks with full information. Including the risks with incomplete information one more theme appear, forecast accuracy. The table below summarizes the results on Risk Management.

Table A-25: Risk Management

ID	Risk Mgmt?	Responsible	Freq. of Meetings?	Risks	----Risk Matrices----		
					Level	Prob.	Impact
PF2-01	<input type="checkbox"/>	-	-	1. Forecast accuracy 2. Supplier failure 3. Product dev./Branding 4. Customer buying power	S N S O	M L L No answer	M H H H
PF2-02	<input checked="" type="checkbox"/>	Risk Manager	Ad hoc	1. Sorting operation fails 2. Choosing wrong partner 3. Sale of shares	S S S	L L L	H H H
PF2-03	<input type="checkbox"/>	-	-	1. Unclear responsibility distr. 2. Quality 3. Dependency on suppliers 4. Monopoly legislation	O S N S	H L L H	H H L H
PF2-04	<input type="checkbox"/>	-	-	1. IT systems 2. Forecast accuracy 3. Factory: fire etc. 4. Transport strike 5. Losing customer trust	Invalid answer Invalid answer Invalid answer Invalid answer Invalid answer		
PF2-05	<input type="checkbox"/>	-	-	1. Supply of input 2. Spare parts for production 3. Quality 4. Revenue 5. Forecasts	N S S S	L No answer L L No answer	H H H H
PF2-06	<input checked="" type="checkbox"/>	Purchasing, Development, Logistics	Monthly	1. Supply failure (Far East) All other are kept confidential	Invalid answer		
PF2-07	<input type="checkbox"/>	-	-	1. Low sales on dev. products 2. Demand management	S	H No answer	H

A.6.5 Combining SCM Maturity and Risk Practices

Combining the SCM Maturity with the Risk Practices does not give the expected results as the correlation seems to be negative instead of positive. The companies having formalized Risk Management (PF2-02, PF2-06) do not have any SCM practices, and the companies with varying degree of SCM practices (PF2-01, PF2-03, PF2-04) do not have formalized Risk Management. For the second time, the expectation of having more Risk Management when the SCM practices are more advanced has not been fulfilled.

Whether this results from the inability to measure the SCM practice or if the Risk Management practices must be measures on the implicit routines and practices instead of the formalized structures and personal perceptions of risks is still not certain.

A.7 Overall Conclusions

From the two pilot studies a number of conclusions can be drawn.

First and foremost, the relevance of Risk Management in relation to SCM was perceived of critical importance by all participants in the two studies. During the discussions and after analyzing the responses it has become evident that some sort of implicit risk management is taking place but the structure and level of formalization is very low.

So, the overall area of concern proved relevant, but when combining with SCM it became a bit more ambiguous. It was difficult to describe the “type” of SCM as it became clear, the

companies implementations of SCM was exaggerated. This finding is in line with the findings of Fawcett & Magnan (2002) who investigated the level of Supply Chain Integration by means of survey instruments and case studies. In their study they subscribed to a modified version of Stevens (1989) model (see Figure A-8 below), found that the level of integration is somewhat less advanced than expected, and claimed that most companies are working on creating seamless processes internally.

Figure A-8: Different Views of Supply Chain Integration¹⁹

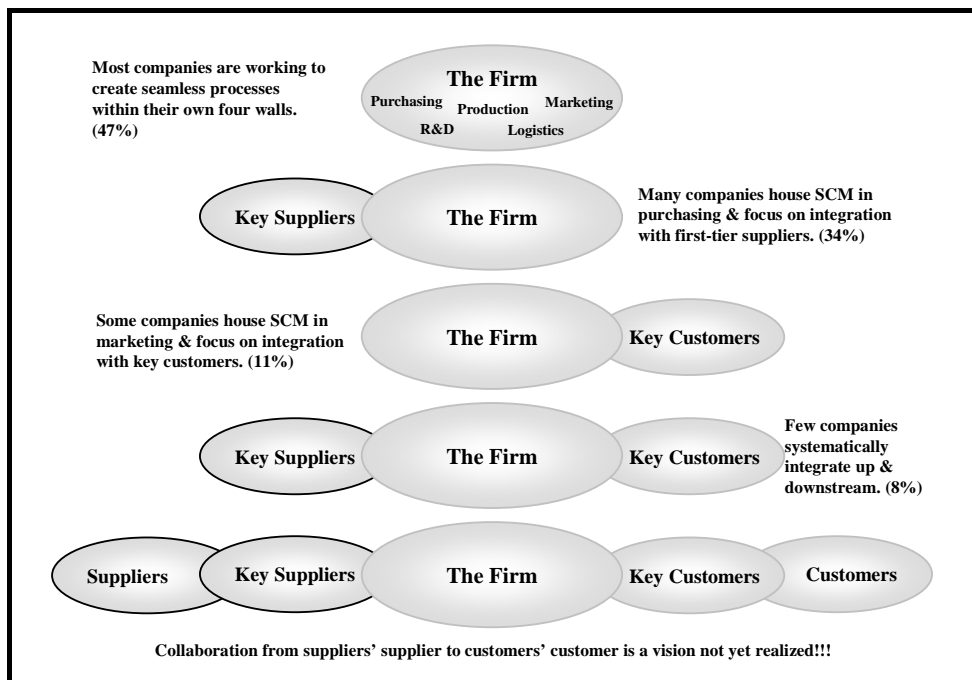

Where Fawcett & Magnan comply with Stevens' assumption and the idea of progression, the pilot studies suggest that internal integration is far more complicated than external integration. Integrating with external partners might prove beneficial (and popular) for both parties, sometimes even resulting in better results for better parties. But implementation of the process-oriented company is a much more difficult task, creating uncertainty about carrier paths, responsibilities, chain and command etc. When implementing process oriented companies, it is vital that the roles and responsibilities are discussed and agreed upon on beforehand, as the crossing of chains of command is detrimental to performance and stability. One reason for this difference in perception might be the cultural difference between Denmark and the USA, an issue raised by e.g. Mentzer et al. (2001):

"Do the antecedents and nature of SCM ... change under and across different national cultures?" (p. 20).

As mentioned previously, perhaps SCM (in Denmark) is to be found in the interfaces between companies in sets of dyadic relationships instead of in continually aligned processes spanning multiple tiers.

¹⁹ Source: Figure 2 in Fawcett & Magnan (2002), p. 354.

A.7.1 Consequences for the Research Design

It seems clear that designing the study to create a contingency model for SCM and Risk Management has been invalidated by these studies. When little knowledge is available or basic assumptions are discarded a more exploratory design is needed. Therefore, instead of performing a survey type study, the design is changed to a multiple case study.

A.8 The Initial Questionnaire

SUPPLY CHAIN INTEGRATION & RISK MANAGEMENT

ID: _____

Agenda

- Section A: Company Profile
- Section B: Supply Chain Management
- Section C: Supply Chain Integration
- Section D: Risk Management

SECTION A: COMPANY PROFILE

A1. Which company do you work for?	
A2. Your name?	
A3. Your position?	
A4. Your e-mail address?	
A5. Transcript for approval?	Yes <input type="checkbox"/> No <input type="checkbox"/>

Comments:

SUPPLY CHAIN INTEGRATION & RISK MANAGEMENT

SECTION B: SUPPLY CHAIN MANAGEMENT

B1. Have you implemented SCM?	Yes <input type="checkbox"/> No <input type="checkbox"/> (jump to B3)
B2. With whom do you perform SCM? (Please tick all relevant)	Internally (eg between departments) <input type="checkbox"/>
	With suppliers <input type="checkbox"/>
	With customers <input type="checkbox"/>
	Other:
B3. Do you work process oriented?	Yes <input type="checkbox"/> No <input type="checkbox"/> (jump to B5)
B4. Which processes?	
B5. Long-term relationships with suppliers?	Yes <input type="checkbox"/> No <input type="checkbox"/> (jump to B9)
B6. How long is the longest relationship (approx.)?	
B7. With how many suppliers do you have long-term relationships?	
B8. What is the average length of relationship with these (B7)?	
B9. Total number of suppliers (approx.)?	
B10. Long-term relationships with customers?	Yes <input type="checkbox"/> No <input type="checkbox"/> (jump to B14)
B11. How long is the longest relationship (approx.)?	
B12. With how many customers do you have long-term relationships?	
B13. What is the average length of relationship with these (B12)?	
B14. Total number of customers (approx.)?	
B15. Where in the chain are you positioned?	

Comments to Supply Chain Management:

SUPPLY CHAIN INTEGRATION & RISK MANAGEMENT

SECTION C: SUPPLY CHAIN INTEGRATION

C1. Do you use ERP system(s)?	Yes <input type="checkbox"/> No <input type="checkbox"/> (jump to C3)
C2. Which system(s)?	
C3. Do you exchange EDI/XML documents with suppliers and/or customers?	Yes <input type="checkbox"/> No <input type="checkbox"/> (jump to C6)
C4. With whom do you exchange electronic documents? (Please tick all relevant)	With suppliers <input type="checkbox"/> With customers <input type="checkbox"/> Other:
C5. Which document types?	
C6. Have you implemented CPFR (collaborative planning, forecasting & replenishment)?	Yes <input type="checkbox"/> No <input type="checkbox"/> (jump to C8)
C7. Who is participating in CPFR? (Relative position in the chain)	
C8. How often do you have meetings with each supplier? Do you have a differentiated approach?	
C9. How often do you have meetings with each customer? Do you have a differentiated approach?	

Comments to Supply Chain Integration:

SUPPLY CHAIN INTEGRATION & RISK MANAGEMENT

SECTION D: RISK MANAGEMENT

D1. Do you actively work with Risk Management ?	Yes <input type="checkbox"/> No <input type="checkbox"/> (jump to D4)
D2. Who is overall responsible?	
D3. How often do you have meetings on Risk Management ?	
D4. Which are the most critical risks in relation to the continued survival and development of your company?	1. _____ 2. _____ 3. _____ 4. _____ 5. _____

Please place the above listed risks in the matrices below.

Network level risks

Impact	Large		
	Small		
		Low	High
Probability			

Strategic risks

Impact	Large		
	Small		
		Low	High
Probability			

SUPPLY CHAIN INTEGRATION & RISK MANAGEMENT

SECTION D: RISK MANAGEMENT (CONT'D)

Operational risks

Impact	Large		
	Small		
		Low	High
		Probability	

Comments to Risk Management:

Thank you for participating !!!

A.9 The Modified Questionnaire

SUPPLY CHAIN INTEGRATION & RISK MANAGEMENT

ID: _____

Agenda

- Section A: Company Profile
- Section B: Supply Chain Management
- Section C: Supply Chain Integration
- Section D: Risk Management

SECTION A: COMPANY PROFILE

A1. Which company do you work for?	
A2. Your name?	
A3. Your position?	
A4. Your e-mail address?	
A5. Transcript for approval?	Yes <input type="checkbox"/> No <input type="checkbox"/>

Comments:

SUPPLY CHAIN INTEGRATION & RISK MANAGEMENT

SECTION B: SUPPLY CHAIN MANAGEMENT

B1. Where in the chain is your company positioned? - What is it's role (eg manufacturer)? - How many tiers upstream? - How many tiers downstream?	
B2. Have you implemented SCM ?	Yes <input type="checkbox"/> No <input type="checkbox"/> (jump to section C)
B3a. Do you work process oriented internally?	Yes <input type="checkbox"/> No <input type="checkbox"/> (jump to B4)
B3b. Which processes have you implemented? (Refer to these when filling out questions below).	

B4a. Proces (eg order fulfillment)?					
B4b. External participants? (Please tick)	Indirect suppliers <input type="checkbox"/>	Direct suppliers <input type="checkbox"/>	Focal company <input checked="" type="checkbox"/>	Direct customers <input type="checkbox"/>	Indirect customers <input type="checkbox"/>
B4c. Internal participants (eg purchasing)?					
B4d. Who is formally responsible?					
B4e. Comments?					

B5a. Proces (eg order fulfillment)?					
B5b. External participants? (Please tick)	Indirect suppliers <input type="checkbox"/>	Direct suppliers <input type="checkbox"/>	Focal company <input checked="" type="checkbox"/>	Direct customers <input type="checkbox"/>	Indirect customers <input type="checkbox"/>
B5c. Internal participants (eg purchasing)?					
B5d. Who is formally responsible?					
B5e. Comments?					

B6a. Proces (eg order fulfillment)?					
B6b. External participants? (Please tick)	Indirect suppliers <input type="checkbox"/>	Direct suppliers <input type="checkbox"/>	Focal company <input checked="" type="checkbox"/>	Direct customers <input type="checkbox"/>	Indirect customers <input type="checkbox"/>
B6c. Internal participants (eg purchasing)?					
B6d. Who is formally responsible?					
B6e. Comments?					

SUPPLY CHAIN INTEGRATION & RISK MANAGEMENT

SECTION B: SUPPLY CHAIN MANAGEMENT (CONT'D)

B7a. Proces (eg order fulfillment)?					
B7b. External participants? (Please tick)	Indirect suppliers <input type="checkbox"/>	Direct suppliers <input type="checkbox"/>	Focal company <input checked="" type="checkbox"/>	Direct customers <input type="checkbox"/>	Indirect customers <input type="checkbox"/>
B7c. Internal participants (eg purchasing)?					
B7d. Who is formally responsible?					
B7e. Comments?					

B8a. Proces (eg order fulfillment)?					
B8b. External participants? (Please tick)	Indirect suppliers <input type="checkbox"/>	Direct suppliers <input type="checkbox"/>	Focal company <input checked="" type="checkbox"/>	Direct customers <input type="checkbox"/>	Indirect customers <input type="checkbox"/>
B8c. Internal participants (eg purchasing)?					
B8d. Who is formally responsible?					
B8e. Comments?					

B9a. Proces (eg order fulfillment)?					
B9b. External participants? (Please tick)	Indirect suppliers <input type="checkbox"/>	Direct suppliers <input type="checkbox"/>	Focal company <input checked="" type="checkbox"/>	Direct customers <input type="checkbox"/>	Indirect customers <input type="checkbox"/>
B9c. Internal participants (eg purchasing)?					
B9d. Who is formally responsible?					
B9e. Comments?					

Comments to Supply Chain Management:

SUPPLY CHAIN INTEGRATION & RISK MANAGEMENT

SECTION C: SUPPLY CHAIN INTEGRATION

C1a. Do you use ERP system(s)?	Yes <input type="checkbox"/> No <input type="checkbox"/> (jump to C2)
C1b. Which system(s)?	
C2a. Do you exchange EDI/XML documents with suppliers and/or customers?	Yes <input type="checkbox"/> No <input type="checkbox"/> (jump to C3)
C2b. With whom do you exchange electronic documents? (Please tick all relevant)	With suppliers <input type="checkbox"/>
	With customers <input type="checkbox"/>
	Other:
C2c. Which document types?	
C3a. Have you implemented CPFR (collaborative planning, forecasting & replenishment)?	Yes <input type="checkbox"/> No <input type="checkbox"/> (jump to C4)
C3b. Who is participating in CPFR? (Relative position in the chain)	
C4a. Have you change routines/procedures in cooperation with or on request by external parties?	Yes <input type="checkbox"/> No <input type="checkbox"/> (jump to C5)
C4b. Which processes/functional areas?	
C5. How often do you have meetings with each supplier? Do you have a differentiated approach?	
C6. How often do you have meetings with each customer? Do you have a differentiated approach?	

Comments to Supply Chain Integration:

SUPPLY CHAIN INTEGRATION & RISK MANAGEMENT

SECTION D: RISK MANAGEMENT

D1. Do you actively work with Risk Management?	Ja <input type="checkbox"/> Nej <input type="checkbox"/> (jump to D4)
D2. Who is overall responsible?	
D3. How often do you have meetings on Risk Management?	
D4. Which are the most critical risks in relation to the continued survival and development of your company?	1. _____ 2. _____ 3. _____ 4. _____ 5. _____

Please place the above listed risks in the matrices below.

Network level risks

Impact	Large		
	Small		
		Low	High
Probability			

Strategic risks

Impact	Large		
	Small		
		Low	High
Probability			

SUPPLY CHAIN INTEGRATION & RISK MANAGEMENT

SECTION D: RISK MANAGEMENT (CONT'D)

Operational risks

Impact	Large		
	Small		
		Low	High
Probability			

<p>D5. Which of these risks (if any) can be mitigated/reduced by changing practises of SCM and integration?</p>	
<p>D6. What should be altered?</p>	

Comments to Risk Management:

Thank you for participating !!!

Appendix B Consultancy Practice I

This appendix contains detailed information on consultancy firms' practices on Supply Chain Risk Management (or other integrated risk management frameworks) as of late 2003. The intent is to perform an empirical triangulation over the practices of integrated risk management.

B.1 Consultancies, Contacts, and Interviewees

The intent of the interviews is to get an idea of the level of interest for and competence within Risk Management in Supply Chains. The list of consultancy firms contacted is based on previous knowledge by the researcher, and is not intended to cover all aspects of consultancy in Denmark (most major players are included, though). The table below contains the names of consultancy firms, contact persons, and interviewee(s) as well as the result of the request for an interview in the initial data collection.

Table B-1: Companies, Contacts, and Interviewees

Consultancy	Contact Interviewee(s)	Contacted on Interviewed on	Result
Accenture	Thorbjørn Nielsen	2003-11-07 & 2003-12-04	No reply
AT Kearney	Tine Sørensen	2003-12-08	Not working on SCM ²⁰
Deloitte & Touche	Henning Winter	2003-11-10 & 2003-12-04	No reply
Ernst & Young	Otto Winterskov	2003-11-10 & 2003-12-04	No reply
IBM Consulting	Henrik Knak Henrik Knak & Peter Matthiessen	2003-11-07 2003-11-26 (personal)	OK!
KPMG	Christian H. Pedersen	2003-11-10	No competence
KPMG Consulting	Stig Due	2003-11-07	Declined the invitation
Marsh Consulting ²¹	Bjørn Rothaus Bjørn Rothaus & Christian Boserup	2003-11-10 2003-11-21 (personal)	OK!
McKinsey	Katrine Lange	2003-11-07 & 2003-12-04	Sent book on SCM
PwC	Leif Christensen Leif Christensen	2003-11-11 2003-11-11 (personal)	OK!

B.2 Results

As can be seen in the table above, most of the companies showed no interest in the subject. Only three consultancies agreed to an interview, each of which is described below.

B.2.1 IBM Consulting

The interview at IBM Consulting revealed that Supply Chain Risk Management is not a part of their services portfolio. Risk management is a focal component in performing

²⁰ Subsequent contact with AT Kearney revealed that this response was incorrect. AT Kearney has worked with SCM for a number of years and perceives the area as one of the most critically important, see Appendix L.

²¹ Marsh Consulting is somewhat different from the rest as they are specialized in insurance brokerage and consultancy on risk management whereas the rest are general consultancies.

(implementation) projects and is supported by an impressive framework containing definition of stages, evaluations, grading, and reporting requirements as well as procedures and routines for the management of exceptions during implementation.

As for the content relating to SCM, Peter Matthiessen shared his experiences from his career in logistics and SCM, and described how outsourcing and e.g. the implementation of risk pooling and inventory monitoring has been implemented in major Danish companies (no names disclosed).

Conceptually the risk management component is present in the models used by IBM, for instance in the Supply Chain Insight Framework (SCIF) model which is used to map out characteristics of the company and its products, and thereby to identify internal and external strengths and weaknesses. The model is used for evaluating strategic changes in companies and therefore has to enable a discussion of risks and potentials. But, at the end of the interview it was concluded that no framework for Supply Chain Risk Management exist within IBM Consulting.

B.2.2 Marsh Consulting

At Marsh Consulting they claimed to be working on a framework for Supply Chain Risk Management. This work was led by senior consultant Rikke Aarøe Carlsen who unfortunately was unavailable at that time²².

Since Rikke Aarøe Carlsen was not attendant no methods/techniques for Supply Chain Risk Management were presented during the interview, but the efforts within Business Continuity Management (BCM) were described along some general models for risk management. The models presented reflect viewing the risk management requirements from a functional (or departmental) perspective, see Figure B-1 below. This is not surprising since Marsh's ambitions to perform more than "simple" risk evaluation and insurance brokerage is not fulfilled at this time.

The desire to work on the right hand side of the figure below, instead of the left hand side (as today) is supported by research performed by Marsh, which documents that 94% of all losses stem from risks located at the right hand side. Aiming at improving processes and strategies are much more beneficial than simply insuring against losses which may be mitigated at minimal cost.

²² The claim is supported by articles identified subsequent to the interview. See e.g. Hauser (2003) or Martha & Subbkrishna (2002).

Figure B-1: The Four Risk Quartiles²³

The method most often used to identify relevant risks in large organizations is questionnaire survey. After identifying employees from all levels and functions (departments) questionnaires are sent out and subsequently analyzed for the identification of central risk issues. From this reduced list the further analysis in terms of quantification and perhaps prioritizing can continue. Aggregating this list may result in a “risk overview” containing a measure for risk and revenue impact both, see Figure B-2 below.

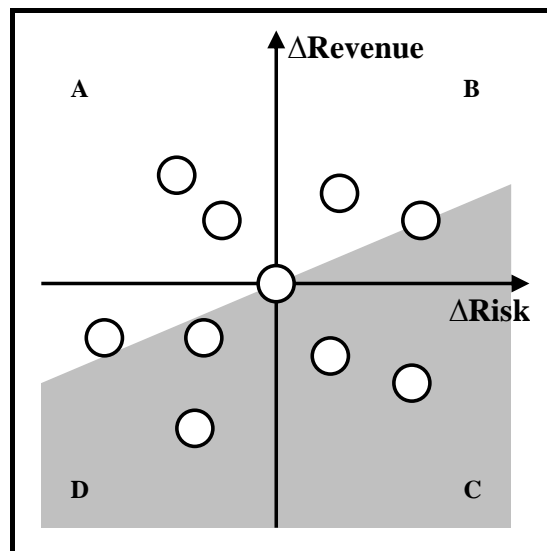
Figure B-2: Risk vs. Revenue²⁴

The example used by Bjørn Rothaus and Christian Boserup was that of a multi-division corporation, but the classification might be product line, distribution channel etc. instead. The

²³ Source: www.marsh.dk (translated from Danish).

²⁴ Source: Marsh Consulting.

strength of this type of analysis is thereby its generic nature. It does not, though, address the complexity of supply chains. The aggregation of risk and revenue impacts is another weakness but the model surely will highlight “unhealthy” combinations of increased risk and decreased revenue.

B.2.3 PricewaterhouseCoopers

Interviewing Leif Christensen, partner at PricewaterhouseCoopers (PwC), spread some light on the practice of modern risk management. Having worked with risk management for some years, Leif Christensen describes how the discipline of (business) risk management within PwC Consulting has matured over the years. Sarcastically he describes the former framework Risk Intelligence (RI), as defined as the square root of the product of Risk Management (RM) and Business Intelligence (BI), that is

$$RI = \sqrt[2]{RM * BI} .$$

Evolving from this rather technically oriented data warehousing construct, the concept in use today is Enterprise Risk Management (ERM), containing the four primary areas: Finance, IT, HR and Facilities, see Figure B-3 below.

Figure B-3: Enterprise Risk Management²⁵

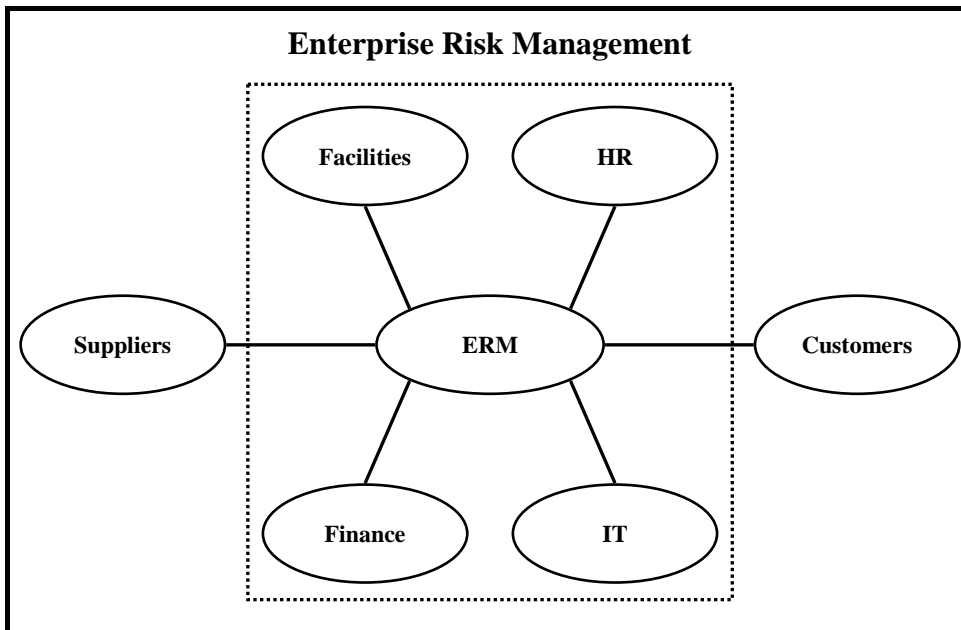

The risk management concept has thereby evolved from a “technical” linkage between Business Warehousing and traditional Business Risk Management into a more holistic concept, albeit still internally oriented²⁶. The term ERM is taken from the work performed by PwC commissioned by the Committee of Sponsoring Organizations of the Treadway Commission (COSO).

²⁵ Source: Leif Christensen (PwC).

²⁶ Different categories but conceptually identical to the ‘four quartiles model’ of Marsh Consulting.

The COSO Framework

Without doubt the most renowned framework within the area²⁷, the (yet not published) report defines ERM as follows:

“Enterprise risk management is a process, effected by an entity’s board of directors, management and other personnel, applied in strategy setting and across the enterprise, designed to identify potential events that may affect the entity, and manage risks to be within its risk appetite, to provide reasonable assurance regarding the achievement of entity objectives” (PriceWaterhouseCoopers, 2004, p. 3).²⁸

The framework aims at improving risk management practices, and more specifically to:

- Align risk appetite and strategy
- Link growth, risk and return
- Enhance risk response decisions
- Minimize operational surprises and losses
- Identify and manage cross-enterprise risks
- Provide integrated responses to multiple risks
- Seize opportunities
- Rationalize capital

Albeit the list is impressive, the report basically advocates integration of risk management practices and emphasizes stringent procedures for risk identification, assessment, and management (so: basically the same steps as before).

The real contribution of the framework is that risks are to be described and analyzed in a “portfolio view”, linking the management of risks to the objectives of the enterprise. Risk management is about more than minimizing the costs of disruptions as the efforts are driven by strategic objectives. Figure B-4 below illustrates the well-known process including the objectives setting and continual monitoring.

Unfortunately, more detailed information on how to perform each of steps in the overall risk management process is not given, leaving the reader/user of the report in the same tight spot as always: how to ensure that the list of risks is complete, the assessment is valid, and risk responses appropriate?

Leif Christensen report that all work performed on projects so far is oriented towards the four boxes (the “departmental” categorizations of risk) in Figure B-3 above. Paradoxically no experience with risk identification and assessment in relation to e.g. outsourcing exist even if this may very well be the area within which the most urgent need exist. No proven frameworks for this type of boundary spanning risk management exist within PwC, all known examples of risk management consulting are characterized by “having a nice chat over dinner” type of investigations. Only from an overall perspective does the “ORCA” (Objectives, Risk, Controls, & Alignment) make any sense, but this framework is so generic it

²⁷ This claim is supported by all other interviewees.

²⁸ Quote taken from an early draft version of the report, supplied by Leif Christensen (PwC). The final version was released in September 2004. See www.coso.org.

does not add any value besides structuring the activities. The risk identification and assessment thereby in its basic nature is extremely subjective as it does not contain any tools/techniques to make a precise measure of neither probability nor impact.

Figure B-4: Components in the COSO Model²⁹

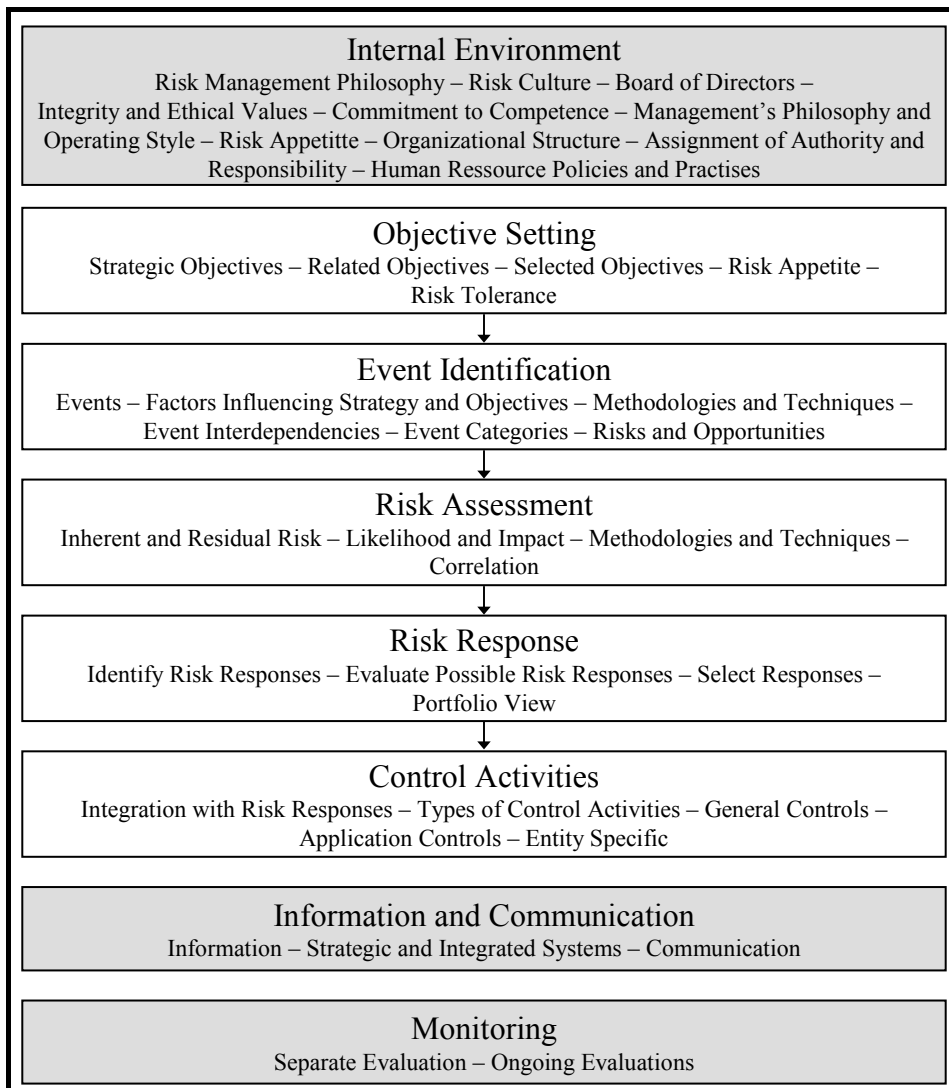

Another weakness of the model is the obvious ignorance of external partners: neither suppliers nor customers are integrated in the risk identification and assessment, and implementation of risk response. Interestingly, material supplied by Leif Christensen describes how supply chain risks relate to the COSO model. Referencing the SCOR³⁰ framework, supply chain risks are process risks located at the lowest level in the corporate hierarchy, detailing out the findings from the enterprise and business unit levels.

²⁹ Source: Exhibit 2 in PricewaterhouseCoopers(2004) (early draft version), p. 17 (colors removed to improve readability).

³⁰ Supply Chain Operations Reference model. For more, see www.supply-chain.org.

Corporate Governance

The final criticism concerning the known practices of Risk Management is the absence of any real contributions in the Nørby report (Nørby Johansen et al., 2001) on Corporate Governance³¹. In the report it is repeatedly stated that risk management is critically important:

“Effective risk management is a precondition for the board of directors to perform the tasks within its area of responsibility. It is therefore of essential importance that the board of directors ensure that appropriate systems for the management of risks are available and fulfill the requirements of the firm at all times. ...

The purpose of risk management is amongst other thing to:

- *develop and retain an understanding in the organization of the strategic and operative goals and an ability to identify critical success factors,*
- *analyze the opportunities for and threats to the realization of abovementioned goals, and*
- *analyze core activities taking place in the company in order to identify relevant risks.” (p. 62, translated)*

No where in the report are more specific guidelines to be found - a waste of a good opportunity, according to Leif Christensen³².

B.3 Conclusion

Findings are summarized in Table B-2 below.

Table B-2: Integrated Risk Management Frameworks

Consultancy	Risk Management Framework	Implemented?
Accenture		
AT Kearney		
Deloitte & Touche		
Ernst & Young		
IBM Consulting	None	N/A
KPMG (Auditors)		
KPMG Consulting		
Marsh Consulting	Business Continuity Management	Yes
	Supply Chain Risk Management (under dev.)	No
McKinsey		
PwC Consulting	ERM / COSO	Yes

From these scarce and diverse findings it must be concluded that no frameworks for Supply Chain Risk Management exist at this time. The integrated risk management framework presented by Leif Christensen (PwC) is a step in the right direction but still pretty far removed

³¹ See www.corporategovernance.dk.

³² This sentiment is supported in Hildebrandt (2002), p. 2.

the “ideal” of a Supply Chain Risk Management as customers and suppliers are not included. The framework under development at Marsh Consulting sounds promising, but time alone will tell.

Appendix C Performing Literature Studies

Having planned to perform at least two extensive literature studies, a thorough and comprehensive method for the task at hand was required. Many textbooks on research methods reviewed³³ emphasize the importance of doing a “critical literature review” in the beginning of the research project (e.g. Bell, 1993), albeit warnings on the potential limiting effects are found as well (e.g. Bickman & Rog, 1998). Ghauri et al. (1995) are uncharacteristically diverse when stating the purposes of the (critical) literature study are to:

- “(a) frame the problem under scrutiny;*
- (b) identify relevant concepts, methods/techniques and facts; and*
- (c) position the study.” (p. 23).*

Most other text books claim only the first purpose. In Welman & Kruger (2001) and Bell (1993) entire chapters are devoted to “the critical literature review”, whereas e.g. Cooper & Schindler (2003), Ghauri et al. (1995), and Bickman & Rog (1998) have only a few pages on the subject. Some authors offer a well-defined process description (e.g. Welman & Kruger, 2001), while others are less detailed (e.g. Cooper & Schindler, 2003).

What these more or less conflicting views on literature studies have in common is the perception that choosing the right strategy for the literature study is of critical importance as it has a definite impact on the research project, the constructs developed, the methods applied, and the conclusions arrived at.

Therefore, this appendix attempts to develop and describe a typology of strategies to choose from when performing literature studies.

C.1 Building a Generic Model

The first step in doing a literature study is to identify the purpose of the study. Is the study a means to getting an overview over a new domain, is it to introduce the research problem in a project application for a Ph.D. position, or is it an attempt to contribute to the academic society through the publication of an overview article?

Depending on the purpose of the study several strategies are available, each having distinct characteristics. Before selecting a strategy, the generic model for designing and performing a literature study is presented below.

C.1.1 Designing the Study

When designing a literature study the following five questions must be answered:

- What is the domain (types of and sources for literature)?
- What are the selection criteria (key words, subjects, authors)?
- What are the relevance criteria (academic level, “fit” with research question)?

³³ Reviewing literature to write a note on reviewing literature! The method applied: (1) domain = personal library plus section 303.4 at the CBS library, (2) selection = availability on September 24th, 2004, (3) relevance = the text “literature review” or “literature study” in the index, (4) validity = assumed, (5) completed = immediate - no iterations!

- What are the validity criteria (methods applied, type of study etc.)?
- How is “completeness” determined?

The first two questions define the input to the literature study – enabling the impressive, all-encompassing overview of the subject in question, or the “introverted” short-listing of the critical few major contribution to a specific problem. The next two questions must be answered for each contribution as the literature study progresses. Irrelevant contributions are dropped from the study as well as the contributions deemed insufficiently valid. The resulting set of contributions is thereafter analyzed for completeness – will the set of contributions identified meet the expectations of the researcher?

In the following each of the five steps are described in more detail.

Step D1 – Define Source

The ultimate literature study will naturally answer the first question by way of: “All!”. As most researchers are quite busy individuals, there is a tendency to limit the sources of literature a bit. The sources may be limited to the local library and the five most commonly used journals within the research area. Defining the population too narrowly will have consequences on the results of the study, whereas defining the population too widely might have consequences on the resources required to perform the study. It is not uncommon to iterate back to questions one and/or two after realizing the consequences of these “easy” choices.

Step D2 – Define Selection Criteria

The selection criteria might be as simple as “all bibliographical material on Wolfgang Amadeus Mozart” or more complex as “studies on bacteriology and epidemics in North Africa before 1970, or in South America after 1980, but only the studies using clinical data”. The former might result in defining the population of sources as a section of the local library and a few electronically available journals, whereas the latter might initially define the source as scores of medical journals, reports, proceedings from conferences, and a massive body of literature in university libraries across the world.

Step D3 – Define Relevance Criteria

The relevance criteria has the dual responsibility of on the one hand permitting material to progress to the next step in the evaluation phase, and on the other to limit the resources needed for evaluation. In case of the study on Mozart, the researcher might choose to discard a children’s book on the composer, as the research is targeted at an academic audience.

Step D4 – Define Validity Criteria

The last of the questions which must be answered for the individual contribution is the question of validity. Is the contribution of a type and to a quality that justifies inclusion in the literature study? Are the tools and techniques applied correctly, and is the research design in the contribution convincing? Precisely defining the criteria for validity is often very difficult

as (relevant) contributions often span wider in terms of type, methods applied etc. than expected initially.

Step D5 – Define Criteria for “Completeness”

The resulting set of contributions is evaluated for completeness, which can be based on various techniques. The simplest test is by counting the number of contributions in the resulting set, and comparing to (explicit) expectations or similar studies. Another technique is to check whether “famous” contributions are amongst the resulting set. Within a discipline there might exist a number of central contributions which can not be left out. In case the “famous” contributions are not included, they might be referenced in the analysis of the results or the literature study can be repeated until the “famous” contributions are present in the resulting set. Finally, a cross-search test can be performed (described in detail later).

C.1.2 Performing the Study

Having defined sources and criteria the literature study can be performed.

Step P1 – Obtain Access to Source

Before the advent of IT-systems and databases in libraries, getting access to materials required considerable effort. Today getting an overview of material available is a matter of using a couple of search engines, and subsequently either reserving or downloading the material (if possible).

Step P2 – List Materials Using Selection Criteria

Again, making use of the search engines enables the fast creation of overview listings. In case the source is electronically available and key word searching is permissible, the creation of lists is almost instantaneous. Otherwise “manual evaluation” is required – here the search engines normally will be able to deliver listings over material (books, journal volumes etc.). Completing this step finalizes the (initial) definition of the input material for the study.

Steps P3 – Evaluate Relevance & P4 – Evaluate Validity

Each entry in the list generated in step P2 will need to be evaluated in two steps: first for relevance and thereafter for validity. In both cases the criteria are defined and the evaluation should be straightforward albeit probably time-consuming.

Step P5 – Perform Check for “Completeness”

Depending on the requirements of the study the completeness of the review can be tested. Performing either a count of the contributions in the resulting set or check if the famous articles are present is quite simple. The cross-search technique requires a bit more explanation. This method applies to studies on material accessible through search engines, e.g. journal articles. Instead of searching by journal for each database a search can be performed using appropriate search terms (e.g. subject area and/or keywords). If more databases are to be used, the results are pooled, and redundancies and matches with the

resulting set are removed leaving what might be called the “control set”. Each contribution from this set is evaluated according to definitions in steps three and four, resulting in a set of valid contributions not identified in the original literature study. Three results might come out of such a cross-search test:

1. A low number of identified journals. This would imply that the literature review has been sufficiently complete, and must be accepted.
2. A large set of articles from other journals (sources). This result would indicate the choice of journals (sources) has been incomplete. The study might be repeated.
3. A large set of articles from journals (sources) in the population. This would imply that the relevance and validity criteria have been used inconsistently. The study will have to be performed again on the same sources.

Figure C-1 below illustrates the process of defining and performing a literature study.

Figure C-1: A Generic Model for Literature Studies

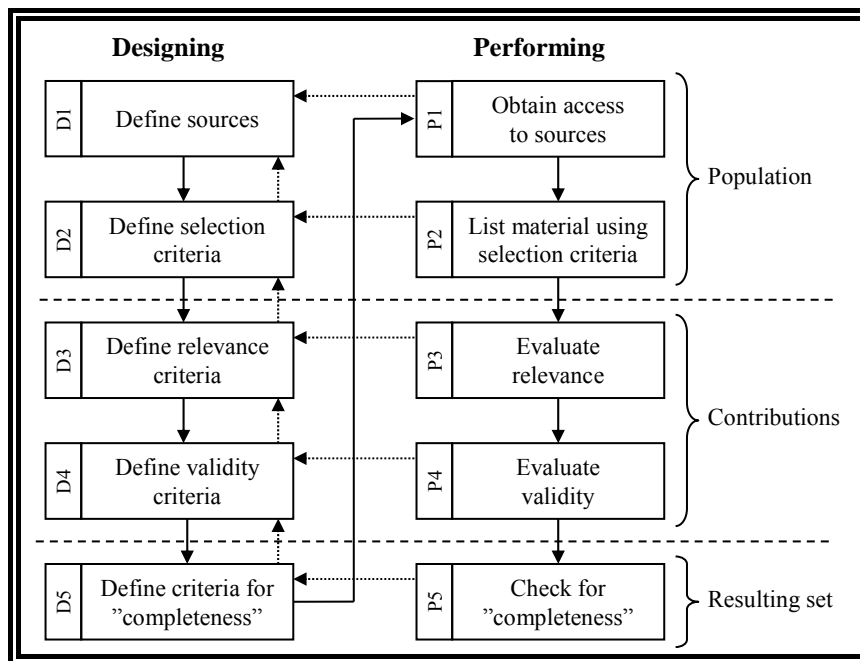

The model presented so far is very stringent and forward progressing. This is naturally not the only strategy available.

C.1.3 A Typology of Strategies

Depending on the type of research project, and the researcher’s experience with and knowledge of the area of research, different strategies might be applied. In case the researcher has previously done work within an area, a quick review of the latest issues of the relevant journals might suffice, whereas the researcher entering a new domain might need a more thorough analysis of the literature. Furthermore, the purpose of the study will have an impact on the resources available for a literature study. To accommodate the various requirements of researchers, a number of strategies can be identified.

The Domain-based Strategy

The domain-based strategy takes its starting point in a (hopefully) precise definition of what is under scrutiny. This most closely resembles the process described above. Often this type of research will be performed by researchers entering a new domain – or if the purpose of the research is to produce an overview article classifying the literature for other researchers' convenience. The definition of domain might consist of a list of (academic) journals, of an index range in the library, a keyword for e-database searches, news databases etc. most often combined with a criterion on the date of publication. Most often (if not always) the date criterion will be a result of a trial-and-error process, based on the relevance and the number of contributions identified. Disadvantages of this strategy are that it is quite time-consuming and requires a considerable degree of discipline in analyzing and categorizing the contributions. Advantages are that the review is complete and that categories match the purpose of the research to be performed subsequently. Except in instances where references are made to internet pages which tend to be updated often and archived only in rare cases, the study can be repeated at a later time.

The Trusted-review Strategy

The trusted-review strategy relies, as indicated by the name, on a review of the subject area published by a trusted source, e.g. a highly ranked journal. Working within an established area of research one will often be able to find review articles, describing and classifying the contributions identified. In case the trusted review is quite new and the classifications fit the purpose of the research, it will simply be a matter of updating the existing body of knowledge. Alternatively it might be necessary to include more journals, to re-do the analysis to accommodate other categories etc. Even if all the categories conflict with the intended framework, the literature study from a trusted source represents a time-saver in terms of having identified the contributions.

The Snow-balling Strategy

The last strategy to be mentioned here is the snow-balling strategy. It provides the least structured result, thereby delivering the least valid result of the strategies described here. The process of performing a study of this type starts with the identification of at least one article of relevance, and then reading the sources referenced. One of several things might occur from this “backtracking”: either the contours of the subject matter is getting clearer in terms of keywords, authors active within the field, or perhaps the subject is dropped. In case the subject is not dropped the further search might be performed by keyword search in e-databases, in the journals identified, by searching for the authors etc. Using internet-enabled tools forward searching is possible as well, perhaps searching in citation databases, personal homepages for newer contributions, or other methods not described in detail here.

Combining the five steps with the three strategies might look like Table C-1 below.

Table C-1: Strategies Step-by-Step

Step	Study type	Domain-based	Trusted-source	Snow-balling
1. Source		Domain in question.	Trusted source, e.g. review article.	Not precisely defined, starts from e.g. overview article or “famous” article on the subject.
2. Selection		Dependent on study.	All references in trusted source.	Not precisely defined.
3. Relevance		“Fit” with purpose of study.	“Fit” with purpose of study.	“Fit” with purpose of study.
4. Validity		The subjective evaluation of the researcher	Assumed.	The subjective evaluation of the researcher
5. Completeness		Relevant, probably using the cross-search test.	Might be relevant.	Not relevant.

C.2 Combining the Strategies

In reality, it might not be possible to perform a “trusted-source” study without the elements of the “snow-balling” strategy. The trusted source might be outdated, or might have an orientation that does not completely cover the domain. Following the stringent procedure outlined in the “domain-based” strategy might be unrealistically time-consuming if applied across all source types, therefore the “domain-based” strategy might be applied for selected journals and the “snow-balling” strategy for all other sources (books etc.).

Applying a mixed-strategy approach thereby confuses the requirement for the overall literature study, and disqualifies the credibility of the study if not addressed. One way of dealing with the complexity is to report each sub-study separately, and combining the studies in a following discussion. Alternatively, the overall study might be perceived as a study of the “snow-balling” type.

C.3 A Final Word of Caution...

As mentioned earlier, the choice of strategy will have dependencies to the epistemological “stance” in the overall research initiative. E.g. choosing the domain-based strategy will imply the possibility to make firm statements about the object studied, fulfilling an aspiration to report the results as a “complete” study. As for all types of studies the overall criteria is the criteria of coherence, choosing the appropriate strategy and defining the desired objectives of the study before performing it.

Furthermore, methods for performing the content analysis and determine relevance and validity has not been addressed here. As this does have a direct impact on the outcomes of the study the researcher will have to explain the interplay between criteria and method.

If these two issues are dealt with, it is the perception of this researcher that the method described enables a discussion of the appropriateness of literature studies performed, and thereby supports the stringent (albeit tiresome) work of creating a sound foundation for research.

Appendix D Risk, Vulnerability, and Uncertainty

This appendix contains the detailed information on the literature study on Risk, Vulnerability, and Uncertainty. Table D-1 below gives the parameters for the study.

Table D-1: Parameters for Literature Study

Step	Description
1. Population	The list of SCM and logistics journals presented in Chapter 1.
2. Selection method & criteria	Browse/read each volume of each journal. Must relate to risk, uncertainty, or vulnerability.
3. Relevance	Editorials, book reviews, and interviews etc. are ignored.
4. Validity	Should be ensured by the definition of the population.
5. Completeness check	Search the five e-databases (across all journals) for articles having the phrase “logistics” or “supply chain” AND the phrase “risk”, “vulnerability”, or “uncertainty” in Abstract.

Besides listing the identified articles, each article is described in terms of a number of categories, namely Term, Phase, Orientation, Level, Research Method, and Explicit Theory. Some of the contributions might not “fit” into one or more of the categories. In such case this will be identified with the symbol “-” in all possible values in the category.

The category ‘Term’ identifies which of the terms Risk (R), Vulnerability (V), or Uncertainty (U) is used in the article.

The next category, ‘Phase’, refers to the three generic phases in the risk management process: Risk Identification (I), Risk Assessment (A), and Risk Management (M).

The ‘Orientation’ category documents the players in scope in the article, and thereby links the study with the holistic view of SCM. The values in the category are: Upstream (U), Internal (I), Downstream (D), and Network (N).

The strategic level is documented in ‘Level’, taking the values: Strategic (S) and Operational (O).

The last two categories, ‘Research Method’ and ‘Explicit Theory’, should be self-explaining.

The articles are furthermore grouped into themes for later reference.

D.1 Volumes Investigated

The table below lists the journals and volumes investigated.

Table D-2: Volumes Investigated

Area		
Journal (Abbr.)	Period Investigated	
SCM/Logistics		
EJPSM	1994 [vol 1, no 1] –	2002 [vol 8, no 4]
IJL-RA	1999 [vol 2, no 1] –	2004 [vol 7, no 2]
IJLM	1998 [vol 9, no 1] –	2003 [vol 14, no 2]
IJPDLM	1989 [vol 19, no 1] –	2004 [vol 34, no 5]
IJPM	1971 [vol 7, no 4] –	1998 [vol 34, no 4]
JBL	1978 [vol 1, no 1] –	2003 [vol 24, no 2]
JPSM	2003 [vol 9, no 1] –	2004 [vol 10, no 2]
JSCM	1990 [vol 26, no 4] –	2004 [vol 40, no 2]
SCM-IJ	1996 [vol 1, no 1] –	2004 [vol 9, no 2]
SCMR	2000 [vol 4, no 1] –	2004 [vol 8, no 4]
Operations Management		
I	1971 [vol 1, no 1] –	2004 [vol 34, no 2]
IMS	1990 [vol 1, no 1] –	2003 [vol 14, no 8]
IJPE	1991 [vol 22, no 1] –	2004 [vol 90, no 2]
IJOPM	1980 [vol 1, no 1] –	2004 [vol 24, no 7]
JMTM	2004 [vol 15, no 1] –	2004 [vol 15, no 4]
JOM	1980 [vol 1, no 1] –	2004 [vol 22, no 4]
PIM	1983 [vol 24, no 1] –	2002 [vol 43, no 3/4]
POM	1999 [vol 8, no 1] –	2003 [vol 12, no 4]
PPC	1990 [vol 1, no 1] –	2004 [vol 15, no 3]
Management		
CMR	1980 [vol 22, no 1] –	2004 [vol 46, no 3]
DS	1985 [vol 16, no 1] –	2004 [vol 35, no 2]
EMJ	1982 [vol 1, no 1] –	2004 [vol 22, no 3]
HBR	1990 [vol 68, no 1] –	2004 [vol 82, no 7/8]
IMM	1985 [vol 14, no 1] –	2004 [vol 33, no 5]
JOcB	1980 [vol 1, no 1] –	1987 [vol 8, no 4]
JOrB	1988 [vol 9, no 1] –	2004 [vol 25, no 5]
SJM	1988 [vol 4, no 1] –	2003 [vol 19, no 4]
SMR	1970 [vol 12, no 1] –	2004 [vol 45, no 3]

D.2 SCM/Logistics Journals

Table D-3: Classification of Articles Published in SCM/Logistics Journals

Journal No	Author(s)	Term RVU	Phase I AM	Orientation U I D N	Level SO	Research Method	Explicit Theory
EJPSM							
1.	Ottesen & Gronhaug, 2002	U	M	U	S	Case study	None
IJLM							
2.	Ho & Carter, 1994	U	- - -	I	O	None	None
3.	Sheffi, 2001	U	M	U D	S	None	Utility
IJL-RA							
4.	Svensson, 2001	V	M	U D	O	Survey	Mkt. Chan.
5.	Svensson, 2002c	V	A	U D	O	Survey	Mkt. Chan.

Table D-3 (cont'd)

Journal No	Author(s)	Term RVU	Phase IAM	Orientation UIDN	Level SO	Research Method	Explicit Theory
IJPDLM							
6.	Boronico & Bland, 1996		U	- - -	I	O	Math. mod. None
7.	Cavinato, 2004	R		- - -	N	S	None None
8.	Christopher & Lee, 2004	R		M	N	S	None None
9.	Koutsoukis et al., 2000		U	- - -	U I D	O	Math. mod. None
10.	Norrman & Jansson, 2004	R		I AM	U I	S	Case study None
11.	Spekman & Davis, 2004	R		I	N	S	None None
12.	Svensson, 2000	V		A	U D	O	Case study Mkt. Chan.
13.	Svensson, 2002a	V		A	U D	O	Survey Mkt. Chan.
14.	Svensson, 2002b	V		A	U D	O	Survey Mkt. Chan.
15.	Talluri, Cetin, & Gardner, 2004		U	- - -	I	O	Math. mod. None
16.	van der Horst & Beulens, 2002		U	I	U	O	None None
17.	Wilding, 1998a		U	I	U D	O	None Chaos
18.	Zsidisin et al., 2004	R		A	U	O	Case study Agency
IJPM							
19.	Carter, Vickery, & D'Itri, 1993	R		M	U	O	Simulation None
20.	Pilling & Zhang, 1992	R		I	U	S	Case study None
21.	Smeltzer & Siferd, 1998	R		- - -	U	O	Case study TCE, RBT
22.	Templin & Noffsinger, 1994	R		A	U	O	Survey None
23.	Tullous & Munson, 1991		U	- - -	U	O	Survey None
JBL							
24.	Copacino & Lapide, 1984		U	- - -	U D	O	Math. mod. None
25.	Lau, 1989		U	- - -	I	O	Math. mod. None
26.	Menachof, 1996	R		M	- - - -	O	Simulation None
27.	Meshkat & Ballou, 1996		U	- - -	I	O	Math. mod. None
28.	Schwarz & Weng, 2000		U	- - -	U D	O	Math. mod. None
29.	Speh & Wagenheim, 1978		U	- - -	D	O	Math. mod. None
30.	Vidal & Goetschalkx, 2000		U	- - -	N	O	Math. mod. None
31.	Wood, 1985	R		A	- - - -	O	Math. mod. None
32.	Zinszer, 1983	R		A	I	O	Math. mod. None
JPSM							
33.	Harland, Brenchley, & Walker, 2003	R		AM	U D	S	Case study None
34.	Zsidisin, 2003a	R		- - -	U	- -	Case study None
JSCM							
35.	Zsidisin, 2003b	R		I A	U	O	Case study None
36.	Zsidisin & Ellram, 2003	R		M	U	S	Survey Agency
SCM-IJ							
37.	Finch, 2004	R		A	U D	S	Case study None
38.	Lonsdale, 1999	R		AM	U	S	Case study RBT
39.	Sinha, Whitman, & Malzahn, 2004	R		M	U	S	None SCOR*
40.	Svensson, 2002d	V		- - -	U D	S	Survey Mkt. Chan.
41.	Zsidisin, Panelli, & Upton, 2000	R		AM	U	S	Survey None
SCMR							
42.	Geary, Childerhouse, & Towill, 2002		U	M	U I D	S	Case study None
43.	Hauser, 2003	R		I AM	N	S	Case study None
44.	Lee & Wolfe, 2003	R		M	U D	S	None TQM*
45.	Martha & Subbakrishna, 2002		U	M	U	S	None None
46.	Rice & Caniato, 2003	R		M	U I D	S	None None
47.	Simchi-Levi, Snyder, & Watson, 2002		U	M	U	S	None None

Table D-4: Themes Identified in SCM/Logistics Journals

Theme	Article No
Improving Operations under Uncertainty	1-2, 6, 9, 15, 24-25, 27-29, 32
Pricing	24, 26, 31
Risk Management in the Supply Chain	7-8, 10-11, 37, 43
Securing the Supply Chain	3, 44-47
Supply Chain Design	16, 30, 38-39, 42-43, 46
Supply Management	1, 6, 10, 18, 21-23, 33-36, 38-39, 41
Vulnerability in Physical Flows	4-5, 12-14, 40
- none -	17, 19-20

D.3 Operations Management Journals

Table D-5: Classification of Articles Published in Operations Management Journals

Journal No	Author(s)	Term RVU	Phase I AM	Orientation U I D N	Level SO	Research Method	Explicit Theory
I							
48.	Boodman, 1987	R	M	U I D	S	None	None
49.	Brown, 1981	U	- - -	- - - -	- -	None	Decision
50.	Davidson & Cooper, 1980	R	A	I	O	Case study	None
51.	Hoffman, 1982	R	A	I	O	Math. mod.	None
52.	Merrick et al., 2002	R	I A	- - - -	O	Simulation	None
53.	Paté-Cornell & Fischbeck, 1994	R	A	I	O	Math. mod.	None
54.	Swoveland, 1987	R	A	I	O	Case study	None
55.	Walker, 1988	R	M	U	S	Case study	RBT, TCE
IJOPM							
56.	Adams & Walbank, 1983	R	- - -	I	O	Survey	None
57.	Baker, 1986	U	- - -	I	O	Math. mod.	None
58.	Callarman & Hamrin, 1984	U	- - -	I D	O	Math. mod.	None
59.	Cousins, Lamming, & Bowen, 2004	R	- - -	U	S	None	None
60.	Newman, Hanna, & Maffei, 1993	U	- - -	I	S	None	None
61.	Wright, 1980	R	M	U	S	None	None
IJPE							
62.	Agrell, Lindroth, & Norrman, 2004	R	AM	N	S	Math. mod.	Agency
63.	Albino & Garavelli, 1995	V	A	U D	O	Math. mod.	None
64.	Bartezzaghi & Verganti, 1995b	U	- - -	D	O	Math. mod.	None
65.	Bartezzaghi, Verganti, & Zotteri, 1999	U	- - -	I	O	Math. mod.	None
66.	Blanchini, Rinaldi, & Ukovich, 1996	U	- - -	N	O	Math. mod.	None
67.	Dolgui & Ould-Louly, 2002	U	- - -	I	O	Math. mod.	None
68.	Gong & Sun, 1995	U	- - -	I	O	Math. mod.	None
69.	Gupta, Gerchak, & Buzacott, 1992	U	- - -	I	O	Math. mod.	None
70.	Güllü, Önol, & Erkip, 1999	U	- - -	U	O	Math. mod.	None
71.	Hallikas, Virolainen, & Tuominen, 2002	R	A	U D	S	Case study	None
72.	Hallikas et al., 2004	R	I AM	N	S	Case study	TCE
73.	Jang & Liu, 1993	U	- - -	I D	O	Math. mod.	None
74.	Jeunet & Jonard, 2000	U	- - -	U	O	Math. mod.	None
75.	Johansen, 1999	U	- - -	D	O	Math. mod.	None
76.	Kelle & Miller, 2001	R	- - -	U	O	Math. mod.	None
77.	Korpela et al., 2002	R	A	D	S	Math. mod.	None
78.	Lau, Lau, & Willett, 2000	U	- - -	D	O	Math. mod.	None
79.	Lefley, 1997	R	- - -	I	- -	None	None
80.	Link & Marxt, 2004	R	I AM	- - - -	S	None	None
81.	Matsuura, Tsubone, & Kataoka, 1995	U	- - -	I	O	Math. mod.	None
82.	Mohebbi, 2004	U	- - -	U	O	Math. mod.	None

Table D-5 (cont'd)

Journal		Term	Phase	Orientation	Level	Research	Explicit
No	Author(s)	RVU	I AM	U I DN	SO	Method	Theory
83.	Muntslag, 1994	R	A	I	O	Math. mod.	None
84.	Murthy & Ma, 1991	U	- - -	I	O	None	None
85.	Petrovic, 2001	U	- - -		O	Simulation	None
86.	Petrovic & Petrovic, 2001	U	- - -	I	O	Math. mod.	None
87.	Tang & Grubbström, 2002	U	- - -	I	O	Math. mod.	None
88.	van der Vaart, de Vries, & Wijngaard, 1996	U	- - -	U	O	Case study	None
89.	van Dorp & Duffey, 1999	R	- - -	I	O	Simulation	None
90.	Vörös, 1999	R	- - -	I	O	Math. mod.	None
91.	Weng, 1999	U	- - -	D	O	Math. mod.	None
92.	Zaidman, 1994	V	- - -	D	O	Math. mod.	None
93.	Zimmer, 2002	U	- - -	U	O	Math. mod.	None
94.	Zäpfel, 1996	U	- - -	I	O	Math. mod.	None
IMS							
- None -							
JMTM							
- None -							
JOM							
95.	Callen & Sarath, 1995	R	- - -	I	O	Math. mod.	None
96.	Denzler, Boe, & Duplaga, 1987	U	- - -	I	O	Simulation	None
97.	Etienne, 1987	U	- - -	U I	O	Math. mod.	None
98.	Hill & Vollmann, 1986	U	- - -	U	O	Math. mod.	None
99.	Kadipasaoglu & Sridharan, 1995	U	- - -	U I	O	Simulation	None
100.	Lewis, 2003	R	- - -	I	O	None	None
101.	Pagell & Krause, 1999	U	- - -	I	O	None	None
102.	Schmitt, 1984	U	- - -	I	O	Math. mod.	None
103.	Treleven & Schweikhart, 1988	R	A	U	S	None	None
104.	Zhao & Lee, 1993	U	- - -	I	O	Simulation	None
PIM							
105.	Allen & Schuster, 2000	R	M	I	O	Math. mod.	None
106.	Chapman, 1992	R	- - -	I	O	None	None
107.	Finch & Luebbe, 1991	R	- - -	- - - -	- -	Math. mod.	None
108.	Pagell et al., 2000	U	- - -	I	S	Case study	None
POM							
109.	Kanyamibwa & Ord, 2000	U	- - -	- - - -	O	Math. mod.	None
PPC							
110.	Akomode, Lees, & Irgens, 1999	R	A	I	O	Math. mod.	None
111.	Bartezzaghi & Verganti, 1995a	U	- - -	I	O	Math. mod.	None
112.	Caputo, 1996	U	- - -	I	O	None	None
113.	Filho, 1999	U	- - -	I	O	Math. mod.	None
114.	Guide Jr & Srivastava, 2000	U	- - -	I	O	None	None
115.	Hegstad, 1990	R	- - -	I	O	Case study	None
116.	Jörnsten & Leisten, 1994	U	- - -	I	O	Math. mod.	None
117.	Koh & Saad, 2003	U	I	I	O	Survey/sim.	None
118.	McGaughey & Gunasekaran, 1999	R	I	U I	S	None	None
119.	Sundararaj et al., 2000	R	M	I	O	Case study	None
120.	Zotteri, 2000	U	- - -	I	O	Simulation	None

Table D-6: Themes Identified in Operations Management Journals

Theme	Article No
Improving Operations under Uncertainty	51, 57, 60, 63, 65-66, 68-70, 73-76, 78, 81-82, 85-86, 88-91, 93, 99, 104-106, 108, 112-113, 116, 119-120
MRP/IT and Uncertainty	58, 64, 67, 84, 87, 94, 96-97, 102, 111, 114, 117
Pricing / Investment	79, 83, 95
Risk Management in the Supply Chain	71-72, 80
Supply Chain Design	60, 62, 69, 77, 103
Supply Management	55, 59, 61, 71-72, 98, 103
- none -	48-50, 52-54, 56, 92, 100-101, 107, 109-110, 115, 118

D.4 Management Journals

Table D-7: Classification of Articles Published in Management Journals

Journal No	Author(s)	Term RVU	Phase I AM	Orientation U I D N	Level SO	Research Method	Explicit Theory
CMR							
121.	Grabowski & Roberts, 1997	R	M	N	S	Case study	None
122.	Johnson, 2001	R	M	U D	S	Case study	None
123.	Lee, 2002	U	M	U D	S	None	None
DS							
124.	Arcelus, Pakkala, & Srinivasan, 2002	R	M	U	O	Math. mod.	None
125.	Ballester, 2002	U	- - -	- - - -	O	Math. mod.	Decision
126.	Ballou & Pazer, 1987	U	- - -	I	O	None	None
127.	Chopra, Reinhardt, & Dada, 2004	U	- - -	- - - -	O	Math. mod.	None
128.	Christy & Kanet, 1988	U	- - -	I	O	Simulation	None
129.	Dillinger, Stein, & Mizzi, 1992	R	- - -	- - - -	O	None	Decision
130.	Ghosh & Ray, 1992	R	- - -	- - - -	O	Math. mod.	Decision
131.	Ghosh & Ray, 1997	R	- - -	- - - -	O	Math. mod.	Decision
132.	Ghosh, 1994	R	- - -	- - - -	O	Math. mod.	Decision
133.	Graves & Ringuest, 1991	R	- - -	U I	O	None	None
134.	Havlena & DeSarbo, 1991	R	- - -	- - - -	O	Survey	None
135.	Krueger & Dickson, 1994	R	- - -	- - - -	O	Survey	Utility
136.	Lee, 1997	R	- - -	- - - -	O	Case study	Prospect
137.	Lin & Krajewski, 1992	U	- - -	I	O	Math. mod.	None
138.	Marshall & Narasimhan, 1989	R	- - -	- - - -	O	Math. mod.	Decision
139.	Noori & Keller, 1986	U	- - -	I	O	None	None
140.	Sridharan & Berry, 1990	U	- - -	I	O	Simulation	None
141.	Wallace, Keil, & Rai, 2004	R	I A	I	O	Survey	Socio-sys.
142.	Wedel & DeSarbo, 1993	R	- - -	- - - -	O	Simulation	Decision
EMJ							
143.	Braithwaite, 1989	R	M	I	S	None	None
144.	Collis, 1992	U	M	I	S	None	Strat. mgt.
145.	Drottz-Sjöberg, 1991	R	- - -	- - - -	- -	Survey	None
146.	Gelber, 1986	R	AM	I	O	None	None
147.	McHugh & Wilson, 1987	R	M	I	S	None	None
148.	Niebling & Shubik, 1982	R	A	- - - -	S	None	None
149.	Noy & Ellis, 2003	R	M	I	S	Survey	Strat. mgt.
150.	Stambaugh, 1996	R	A	I	S	None	None

Table D-7 (cont'd)

Journal No	Author(s)	Term RVU	Phase I AM	Orientation U I D N	Level S O	Research Method	Explicit Theory
HBR							
151.	Bernstein, 1996	R	- - -	- - - -	- -	None	None
152.	Fisher et al., 1994	U	- - -	- - - -	- -	Case study	None
153.	Froot, Scharfstein, & Stein, 1994	R	M	I	O	Case study	None
154.	Groysberg, Nanda, & Nohria, 2004	R	- - -	- - - -	- -	None	None
155.	Hecht & Morici, 1993	R	- - -	- - - -	- -	None	None
156.	Sells, 1994	R	- - -	- - - -	- -	Case study	None
157.	Simons, 1999	R	I A	I	S	None	None
158.	Watkins & Bazerman, 2003	V	M	- - - -	S	None	None
IMM							
159.	Bunn & Liu, 1996	R	I	D	O	Survey	None
160.	Henthorne, LaTour, & Williams, 1993	R	I A	I	O	Survey	None
161.	Hunter et al., 2004	R	- - -	U I	O	None	None
162.	Meldrum & Millman, 1991	R	I	D	S	Case study	None
163.	Polk, Plank, & Reid, 1996	R	A	D	O	Survey	None
164.	Schill, 1985	R	M	U D	S	Math. mod.	None
165.	Westbrook, 1996	R	- - -	D	O	None	None
JOcB							
166.	Clegg & Fitter, 1981	U	- - -	I	O	Case study	Organiz.
JOrB							
- None -							
SJM							
- None -							
SMR							
167.	Allaire & Firsirotsu, 1989	R	M	I	S	None	None
168.	Bowman, 1980	R	- - -	I	S	Case study	Finance
169.	Bowman, 1982	R	- - -	I	S	Case study	Finance
170.	Clemons, 1995	R	- - -	I	S	None	None
171.	Cozzolino, 1979	R	A	- - - -	O	Math. mod.	None
172.	Davis, 1993	U	M	N	S	Case study	None
173.	Ghemawat, 1993	R	- - -	I	S	None	None
174.	Hertz & Thomas, 1983	R	A	I	S	Math. mod.	None
175.	Marsh & Swanson, 1984	R	A	I	S	None	Finance
176.	Quelch, Neslin, & Olson, 1987	R	- - -	D	S	None	None

Table D-8: Themes Identified in Management Journals

Theme	Article No
Decision Making	125, 129-132, 134-136, 138, 142, 171
Improving Operations under Uncertainty	127-128, 133, 139
MRP/IT and Uncertainty	137, 140
New Product Introduction	162-163, 174
Pricing / Investment	124, 146, 150, 153, 164, 168-169, 173, 175
Risk and Strategy	143-144, 147-149, 167
Risk Management in the Supply Chain	121-122, 172
Supply Chain Design	122-123, 172
Supply Management	159-161, 165
- none -	126, 141, 145, 151-152, 154-158, 166, 170, 176

D.5 Completeness Check (Cross-database Search)

Table D-9: Classification of Articles Published in Other Journals

No	Author(s)	Term RVU	Phase IAM	Orientation UIDN	Level SO	Research Method	Explicit Theory
177.	Agrawal & Seshadri, 2000	R	M	U	O	Math. mod.	None
178.	Bensaou & Anderson, 1999	R	- - -	U	S	Case study	TCE, RBT
179.	Bowersox, Stank, & Daugherty, 1999	R	M	D	O	None	None
180.	Escudero et al., 1999	U	- - -	I D	O	Math. mod.	None
181.	Grabowski & Roberts, 1999	R	M	N	S	None	None
182.	Kouvelis & Milner, 2002	U	- - -	U D	S	Math. mod.	None
183.	Nooteboom, Berger, & Noorderhaven, 1997	R	A	U D	S	Survey	TCE
184.	Ritchie & Brindley, 2000	R	M	U D	S	None	None
185.	Sabri & Beamon, 2000	U	- - -	N	S	Math. mod.	None
186.	Sharratt & Choong, 2002	R	A	N	O	None	None
187.	Tsay, 1999	U	- - -	D	O	Math. Mod.	None
188.	van der Horst et al., 1998	U	- - -	I D	O	Case study	None
189.	van Mieghem, 1999	U	- - -	U	O	Math. mod.	None

D.6 Themes on Risk, Uncertainty, and Vulnerability

Table D-10: Themes Identified Across Journal Categories

Theme	Article No
Decision Making	125, 129-132, 134-136, 138, 142, 171, 182, 187
Improving Operations under Uncertainty	1, 6, 9, 15, 24-25, 27-29, 32, 51, 57, 60, 63, 65-66, 68-70, 73-76, 78, 81-82, 85-86, 88-91, 93, 99, 104-106, 108, 112-113, 116, 119-120, 127-128, 133, 139, 177, 180, 185, 188
MRP/IT and Uncertainty	2, 58, 64, 67, 84, 87, 94, 96-97, 102, 111, 114, 117, 137, 140
New Product Introduction	162-163, 174, 179
Pricing/Financial Instruments	24, 26, 31, 79, 83, 95, 124, 146, 150, 153, 164, 168-169, 173, 175, 189
Risk and Strategy	143-144, 147-149, 167, 178
Risk Management in the Supply Chain	7-8, 10-11, 37, 43, 71-72, 80, 121-122, 172
Securing the Supply Chain	3, 44-47
Supply Chain Design	16, 30, 38-39, 42-43, 46, 60, 62, 69, 77, 103, 122-123, 172, 181-182, 184-185
Supply Management	1, 6, 10, 18, 21-23, 33-36, 38-39, 41, 55, 59, 61, 71-72, 98, 103, 159-161, 165
Vulnerability in Physical Flows	4-5, 12-14, 40
- none -	17, 19-20, 48-50, 52-54, 56, 92, 100-101, 107, 109-110, 115, 118, 126, 141, 145, 151-152, 154-158, 166, 170, 176, 183, 186

Appendix E SCM/Logistics in the Risk Domain

This appendix contains the detailed information on the literature study on SCM and Logistics within the Risk domain. The table below gives the parameters for the study.

Table E-1: Parameters for Literature Study

Step	Description
1. Population	The list of risk management journals presented in Chapter 1.
2. Selection method & criteria	Browse/read each volume of each journal. Must relate to logistics and/or SCM.
3. Relevance	Editorials, book reviews and interviews are ignored.
4. Validity	Should be ensured by the definition of the population.
5. Completeness check	E-search for articles having “Supply Chain Management” or “Logistics” in Abstract. The search is performed in the listed journals only.

Besides listing the identified articles, each article is described in terms of a number of categories, namely Orientation, Level, Research Method, and Explicit Theory.

The Orientation category documents the players in scope in the article, and thereby links the study with the holistic view of SCM. The values in the category are: Upstream (U), Internal (I), Downstream (D), and Network (N) (also in this category more than one value is possible).

The strategic level is documented in ‘Level’, taking the values: Strategic (S) and Operational (O).

The last two categories, Research Method and Explicit Theory, should be self-explaining.

E.1 Volumes Investigated

The table below lists the journals and volumes investigated.

Table E-2: Volumes Investigated

Area	Journal (Abbr.)	Period Investigated
Risk	JR	1998 [vol 1, no 1] – 2004 [vol 6, no 4]
	JRI	1990 [vol 57, no 1] – 2004 [vol 71, no 3]
	JRR	1998 [vol 1, no 1] – 2004 [vol 7, no 2]
	JRU	1992 [vol 5, no 1] – 2004 [vol 29, no 2]
	RA-IJ	1981 [vol 1, no 1] – 2004 [vol 24, no 4]
	RM	1979 [vol 26, no 8] – 2004 [vol 51, no 8]

E.2 Risk Journals

Table E-3: Classification of Articles Published in Risk Journals

Journal No	Author(s)	Orientation U I D N	Level S O	Research Method	Explicit Theory
JR					
	- None -				
JRI					
	- None -				
JRR					
	- None -				
JRU					
	- None -				
RA-IJ					
1.	Erkut & Verter, 1995	U D	O	Modelling	None
2.	Hubert & Pages, 1989	U D	O	Case study	None
3.	Meslin, 1981	U D	O	Case study	None
4.	Sacomanno & Haastrup, 2002	U D	O	Modelling	None
RM					
5.	Clark & McGinn, 1997	U D	O	None	None
6.	Darling, 1996	U D	O	None	None

Table E-4: Themes Identified in Risk Journals

Theme	Article No
Transportation	1-6

E.3 Completeness Check (Within Journal Search)

Table E-5: Classification of Articles Published in Other Journals

No	Author(s)	Orientation U I D N	Level S O	Research Method	Explicit Theory
	- None-				

Appendix F Supply Chain Design

This appendix contains the detailed information on the literature study on Supply Chain Design. The table below gives the parameters for the study.

Table F-1: Parameters for Literature Study

Step	Description
1. Population	Volumes of the journals presented in Chapter 1 available electronically.
2. Selection method & criteria	Search for articles for each journal in the population via web-browser. Identify all articles with “Supply” and “Chain” and “Design” in Abstract.
3. Relevance	All identified articles are included. Each article is subsequently evaluated based on it’s contribution to design of processes and structure.
4. Validity	Should be ensured by the definition of the population.
5. Completeness check	Search the five e-databases (across all journals) for articles having “Supply” and “Chain” and “Design” in Keyword ³⁴ .

Besides listing the identified articles, each article is described in terms of a number of categories, namely ‘Relevance’, ‘Design Object’, ‘Orientation’, ‘Research Method’, and ‘Explicit Theory’.

The ‘Relevance’ category describes whether the article deals with Supply Chain Design. Articles on methodology, editorials, book reviews, and articles on sub-disciplines (e.g. reverse logistics, or decision making) are classified ‘Not relevant’ in this study.

The category ‘Design Object’ makes reference to Systems Theory as the design object might be Structure (S) and/or Process (P).

The ‘Orientation’ category documents the players in scope in the article, and thereby links the study with the holistic view of SCM. The values in the category are: Upstream (U), Internal (I), Downstream (D), and Network (N) (also in this category more than one value is possible).

The last two categories, ‘Research Method’ and ‘Explicit Theory’, should be self-explaining.

Table F-2 on the next page contains the list of journals and volumes investigated. The following tables contain the identified articles. Subsequently, the articles are classified according to ‘Subject Area’ and ‘Design Objective(s)’.

³⁴ In databases not supporting keyword searching (ABI-INFORM and JSTOR), abstracts are searched for the text string ‘Supply Chain Design’ instead.

F.1 Volumes Investigated

The table below lists the journals and volumes investigated.

Table F-2: Volumes Investigated

Area	Journal (Abbreviation)	Period Investigated
SCM/Logistics		
	EJPSM	1996 [vol 2, no 1] – 2002 [vol 8, no 4]
	IJLM	1998 [vol 9, no 1] – 2004 [vol 15, no 2]
	IJL-RA	1999 [vol 2, no 1] – 2004 [vol 7, no 1]
	IJPDLM	1992 [vol 22, no 1] – 2005 [vol 35, no 2]
	IJPM	1990 [vol 26, no 4] – 1998 [vol 34, no 4]
	JBL	1978 [vol 1, no 1] – 2005 [vol 26, no 1]
	JPSM	2003 [vol 9, no 1] – 2004 [vol 10, no 4-5]
	JSCM	1990 [vol 26, no 4] – 2004 [vol 41, no 1]
	SCM-IJ	1996 [vol 1, no 1] – 2005 [vol 10, no 1]
	SCMR	2000 [vol 4, no 1] – 2005 [vol 9, no 2]
Operations Management		
	I	1971 [vol 1, no 1] – 2004 [vol 34, no 2]
	IJOPM	1980 [vol 1, no 1] – 2005 [vol 25, no 4]
	IJPE	1991 [vol 22, no 1] – 2004 [vol 96, no 2]
	IMS	1992 [vol 3, no 1] – 2003 [vol 14, no 6]
	JMTM	2004 [vol 15, no 1] – 2005 [vol 16, no 3]
	JOM	1980 [vol 1, no 1] – 2005 [vol 23, no 3/4]
	PIM	1983 [vol 24, no 1] – 2002 [vol 43, no 3/4]
	POM	1997 [vol 6, no 2] – 2004 [vol 13, no 3]
	PPC	1990 [vol 1, no 1] – 2004 [vol 15, no 3]
Management		
	CMR	1958 [vol 1, no 1] – 2005 [vol 47, no 2]
	DS	1988 [vol 19, no 1] – 2005 [vol 36, no 1]
	EMJ	1988 [vol 6, no 1] – 2004 [vol 22, no 6]
	HBR	1922 [vol 1, no 1] – 2005 [vol 83, no 4]
	IMM	1971 [vol 1, no 1] – 2005 [vol 34, no 2]
	JOcB	1980 [vol 1, no 1] – 1987 [vol 8, no 4]
	JOrB	1988 [vol 9, no 1] – 1998 [vol 18, no 7]
	SJM	1988 [vol 4, no 1-2] – 2004 [vol 20, no 4]
	SMR	1970 [vol 12, no 1] – 2004 [vol 46, no 1 (supp.)]

F.2 SCM/Logistics Journals

Table F-3: Classification of Articles Published in SCM/Logistics Journals

Journal No	Author(s)	Relevance	Design SP	Orientation U I D N	Research Method	Explicit Theory
EJPSM						
- None -						
IJLM						
1.	Anderson & Katz, 1998	✓	S	U	None	None
2.	Christopher & Towill, 2002	✓	S	N	Case study	None
3.	Claycomb, Droge, & Germain, 1999	☐				
4.	Hewitt, 1994	✓	P	I N	Case study	None
5.	Payne & Peters, 2004	✓	S	N	Case study	None
6.	van der Horst, van Dijk, & Beulens, 2001	✓	P	N	Case study	None
7.	van Hoek & Weken, 1998	✓	S P	U I	Case study	None
8.	Wilding, 1998b	✓	S P	I N	None	Chaos
9.	Wouters, Sharman, & Wortmann, 1999	✓	P	N	Case study	None

Table F-3 (cont'd)

Journal No	Author(s)	Relevance	Design S P	Orientation U I D N	Research Method	Explicit Theory
IJL-RA						
10.	Forza, Romano, & Vinelli, 2000	<input type="checkbox"/>				
11.	Larson & Gammelgaard, 2001	<input type="checkbox"/>				
12.	McGovern, Hicks, & Earl, 1999	<input type="checkbox"/>				
13.	Towill & Christopher, 2002	<input type="checkbox"/>				
14.	van der Horst & Beulens, 1999	<input type="checkbox"/>				
15.	Zografos & Giannouli, 2001	<input type="checkbox"/>				
IJPDLM						
16.	Anumba, Siemieniuch, & Sinclair, 2000	<input type="checkbox"/>				
17.	Auramo, Kauremaa, & Tanskanen, 2005	<input type="checkbox"/>				
18.	Christiaanse & Kumar, 2000	✓	S P	N	None	TCE
19.	Christopher & Towill, 2001	✓	S P	N	None	None
20.	Dumond, 1996	<input type="checkbox"/>				
21.	Elliman & Orange, 2000	<input type="checkbox"/>				
22.	Farris II, Wittmann, & Hasty, 2005	<input type="checkbox"/>				
23.	Giddings, Bailey, & Moore, 2001	<input type="checkbox"/>				
24.	Graham & Hardaker, 2000	<input type="checkbox"/>				
25.	Jayaram, Vickery, & Droge, 2000	<input type="checkbox"/>				
26.	Klevås, 2005	<input type="checkbox"/>				
27.	Lau & Lee, 2000	<input type="checkbox"/>				
28.	Lehtonen, Småros, & Holmström, 2005	<input type="checkbox"/>				
29.	Mason et al., 2002	✓	S	N	None	None
30.	Mollenkopf & Dapiran, 2005	<input type="checkbox"/>				
31.	Mourits & Evers, 1995	<input type="checkbox"/>				
32.	Nynke Faber, de Koster, & van de Velde, 2002	<input type="checkbox"/>				
33.	Sarkis & Sundarraj, 2000	<input type="checkbox"/>				
34.	Shore & Venkatachalam, 2003	<input type="checkbox"/>				
35.	Simatupang & Sridharan, 2005	<input type="checkbox"/>				
36.	Towill, Naim, & Wikner, 1992	<input type="checkbox"/>				
IJPM						
37.	Carter & Hendrick, 1997	<input type="checkbox"/>				
38.	Walton, Handfield, & Melnyk, 1998	<input type="checkbox"/>				
JBL						
39.	Schwarz & Weng, 2000	<input type="checkbox"/>				
40.	van Hoek, Commandeur, & Vos, 1998	✓	P	I D	Case study	None
41.	Vidal & Goetschalkx, 2000	<input type="checkbox"/>				
JPSM						
- None -						
JSCM						
42.	Carter & Ellram, 2003	<input type="checkbox"/>				
43.	Hallenbeck Jr., Hautaluoma, & Bates, 1999	<input type="checkbox"/>				
44.	Talluri & Ragatz, 2004	<input type="checkbox"/>				
45.	Trent, 2004	<input type="checkbox"/>				
46.	Vonderembse & Tracey, 1999	<input type="checkbox"/>				
SCM-IJ						
47.	Brunnermeier & Martin, 2002	<input type="checkbox"/>				
48.	Chandra & Kumar, 2000	✓	P	I	Case study	None
49.	Childerhouse et al., 2003	<input type="checkbox"/>				
50.	Hammel, Kuettner, & Phelps, 2002	✓	S	N	Case study	None
51.	Hamprecht et al., 2005	<input type="checkbox"/>				
52.	Hoole, 2005	<input type="checkbox"/>				
53.	Huan, Sheoran, & Wang, 2004	<input type="checkbox"/>				
54.	James, Grosvenor, & Prickett, 2004	<input type="checkbox"/>				
55.	Kwon & Suh, 2005	<input type="checkbox"/>				
56.	Li et al., 2005	<input type="checkbox"/>				
57.	Love, Irani, & Edwards, 2004	<input type="checkbox"/>				

Table F-3 (cont'd)

Journal No	Author(s)	Relevance	Design S P	Orientation U I D N	Research Method	Explicit Theory
58.	McIvor, 2000	✓	S	U I	None	TCE, RBT
59.	McIvor, 2003	✓	S	U I	Case study	TCE
60.	Nollet & Beaulieu, 2005	☐				
61.	Preiss & Murray, 2005	☐				
62.	Samaranayake, 2005	☐				
63.	Sinha, Whitman, & Malzahn, 2004	☐				
64.	Towill, 1996	✓	P	I N	Modeling	None
65.	Tracey & Tan, 2001	☐				
66.	Wilson & Clarke, 1998	☐				
67.	Zeng, 2003	✓	S	U I	Case study	None
SCMR						
68.	Arntzen & Shumway, 2002	☐				
69.	Ayers, 2003	☐				
70.	Boyson & Corsi, 2001	✓	P	U I D	None	None
71.	Cargille & Bliss, 2001	☐				
72.	Dershin, 2000	✓	P	I	None	None
73.	Herman, 2002	☐				
74.	Kopczak, 2001	✓	P	D	None	None
75.	Martha & Subbakrishna, 2002	✓	S P	U I D	None	None
76.	Shankar, 2001	☐				
77.	Walker, 2000	☐				

F.3 Operations Management Journals

Table F-4: Classification of Articles Published in Operations Management Journals

Journal No	Author(s)	Relevance	Design S P	Orientation U I D N	Research Method	Explicit Theory
I						
78.	Fleischmann, Van Nunen, & Grave, 2004	☐				
79.	Lee, Billington, & Carter, 1993	☐				
80.	Sodhi, 2001	☐				
IJOPM						
81.	Baines et al., 2005	☐				
82.	Barker, 1994	☐				
83.	Boardman & Clegg, 2001	✓	P	I N	None	None
84.	Buxey, 2005	☐				
85.	Croom, 2005	☐				
86.	Fowler, 1998	✓	P	I	Modeling	None
87.	Fynes, Voss, & de Burca, 2005	☐				
88.	Gimenez & Ventura, 2005	☐				
89.	Voordijk, 2000	☐				
90.	Zirpoli & Caputo, 2002	☐				
IJPE						
91.	Herer, Tzur, & Yücesan, 2002	☐				
92.	Korpela, Lehmusvaara, & Tuominen, 2001a	✓	S P	I N	Modeling	None
93.	Korpela, Lehmusvaara, & Tuominen, 2001b	✓	S	I D	Modeling	None
94.	Korpela et al., 2002	✓	S P	I	Modeling	None
95.	Olhager & Selldin, 2004	☐				
96.	Persson & Olhager, 2002	✓	S	N	Modeling	None
97.	Wang, Huang, & Dismukes, 2004	☐				
IMS						
98.	Macbeth & Ferguson, 1991	☐				
99.	Walsh et al., 2003	☐				

Table F-4 (cont'd)

Journal No	Author(s)	Relevance	Design S P	Orientation U I D N	Research Method	Explicit Theory
JMTM						
100.	Aslanertik, 2005	<input type="checkbox"/>				
101.	Han & Damrongwongsiri, 2005	<input type="checkbox"/>				
102.	Manzini et al., 2005	<input type="checkbox"/>				
103.	Routroy & Kodali, 2005	<input type="checkbox"/>				
JOM						
104.	Blackhurst, Wu, & O'Grady, 2005	✓	S P	I N	Modeling	None
105.	Fine, Golany, & Naseraldin, 2005	✓	S P	I N	Modeling	None
106.	Forza, Salvador, & Rungtusanatham, 2005	<input type="checkbox"/>				
107.	Petersen, Handfield, & Ragatz, 2005	<input type="checkbox"/>				
108.	Rungtusanatham & Forza, 2005	<input type="checkbox"/>				
PIM						
109.	Hammel & Kopczak, 1993	✓	P	I	Case study	None
110.	Vokurka, 1998	<input type="checkbox"/>				
POM						
111.	Anderson Jr, Fine, & Parker, 2000	<input type="checkbox"/>				
112.	Boylor & Olson, 2002	<input type="checkbox"/>				
113.	Fine, 2000	✓	S P	I N	None	None
114.	Fleischmann et al., 2001	<input type="checkbox"/>				
115.	Gan, Sethi, & Yan, 2004	<input type="checkbox"/>				
116.	Kreipl & Pinedo, 2004	<input type="checkbox"/>				
117.	Parker & Anderson Jr, 2002	<input type="checkbox"/>				
118.	Ramdas, 2003	<input type="checkbox"/>				
119.	Tatsiopoulous et al., 2001	<input type="checkbox"/>				
PPC						
120.	Bhattacharya, Coleman, & Brace, 1995	<input type="checkbox"/>				
121.	Korhonen, Huttunen, & Eloranta, 1998	<input type="checkbox"/>				
122.	Lee & Sasser, 1995	<input type="checkbox"/>				
123.	Olhager, 2002	<input type="checkbox"/>				
124.	Onwubolu et al., 1999	<input type="checkbox"/>				
125.	Sadeh et al., 2001	<input type="checkbox"/>				
126.	Taylor & Whicker, 2002	<input type="checkbox"/>				
127.	Towill, 1997	✓	P	I	None	None
128.	Towill & Del Vecchio, 1994	<input type="checkbox"/>				
129.	Trienekens & Beulens, 2001	<input type="checkbox"/>				

F.4 Management Journals

Table F-5: Classification of Articles Published in Management Journals

Journal No	Author(s)	Relevance	Design S P	Orientation U I D N	Research Method	Explicit Theory
CMR						
130.	Blackburn et al., 2004	<input type="checkbox"/>				
131.	Krikke, le Blanc, & van de Velde, 2004	<input type="checkbox"/>				
DS						
132.	Bapna et al., 2002	<input type="checkbox"/>				
133.	Curkovic, Vickery, & Droge, 2000	<input type="checkbox"/>				
134.	Damodaran & Wilhelm, 2004	<input type="checkbox"/>				
135.	Jayaram, 1998	<input type="checkbox"/>				
136.	Mabert & Venkataramanan, 1998	<input type="checkbox"/>				
137.	Robinson Jr & Satterfield, 1998	✓	S	D	Simulation	None
138.	Swaminathan, Smith, & Sadeh, 1998	✓	S	N	Simulation	None
139.	van der Zee & van der Horst, 2005	<input type="checkbox"/>				

Table F-5 (cont'd)

Journal No	Author(s)	Relevance	Design SP	Orientation UIDN	Research Method	Explicit Theory
EMJ						
- None -						
HBR						
140.	Burt, 1989	<input type="checkbox"/>				
141.	Guide Jr & Van Wassenhove, 2002	<input type="checkbox"/>				
142.	Ferdows, Lewis, & Machuca, 2004	<input checked="" type="checkbox"/>	P	N	Case study	None
143.	Stock, Speh, & Shear, 2002	<input type="checkbox"/>				
IMM						
144.	Lancioni, 2000	<input type="checkbox"/>				
145.	Reutterer & Kotzab, 2000	<input type="checkbox"/>				
JOcB						
- None -						
JOrB						
- None -						
SJM						
- None -						
SMR						
146.	Kopczak & Johnson, 2003	<input type="checkbox"/>				
147.	Lee & Billington, 1992	<input type="checkbox"/>				
148.	Lee, Padmanabhan, & Whang, 1997	<input checked="" type="checkbox"/>	P	I N	Case study	None
149.	Sodhi, 2003	<input type="checkbox"/>				

F.5 Completeness Check (Cross-database Search)

Table F-6: Classification of Articles Published in Other Journals

Database No	Author(s)	Relevance	Design SP	Orientation UIDN	Research Method	Explicit Theory
ABI/INFORM						
150.	Anderson Jr, Fine, & Parker, 2000 ³⁵					
151.	Boardman & Clegg, 2001					
152.	Chiang, Chhajed, & Hess, 2003	<input type="checkbox"/>				
153.	Daskin, 2004	<input type="checkbox"/>				
154.	de Vericourt, Karaesmen, & Dallery, 2002	<input type="checkbox"/>				
155.	Fine, 2000					
156.	Hammel, Kuettner, & Phelps, 2002					
157.	Harrison, 2001	<input type="checkbox"/>				
158.	Johnson, 1998	<input checked="" type="checkbox"/>	P	I N	None	None
159.	Kotzab, Skjoldager, & Vinum, 2003	<input type="checkbox"/>				
160.	Kumar, 2004	<input type="checkbox"/>				
161.	Shore & Venkatachalam, 2003					
162.	Sinha, Whitman, & Malzahn, 2004					
163.	Swaminathan, Smith, & Sadeh, 1998					
164.	van der Horst, van Dijk, & Beulens, 2001					
Business Source Premier						
- None -						

³⁵ All articles grayed out in this section are duplicates as they have been identified in the previous search in the journals.

Table F-7: Classification of Articles Published in Other Journals

Database	Rele- vance	Design S P	Orientation U I D N	Research Method	Explicit Theory
No Author(s)					
EMERALD					
165. Abdinnour-Helm, 1999	✓	S	D	Simulation	None
166. Anumba, Siemieniuch, & Sinclair, 2000					
167. Brunnermeier & Martin, 2002					
168. Giddings, Bailey, & Moore, 2001					
169. Roberts, 2001	□				
170. Simatupang, Sandroto, & Lubis, 2004	□				
JSTOR					
- None -					
ScienceDirect					
171. Fine, Golany, & Naseraldin, 2005					
172. Fixson, 2005	□				
173. Goetschalckx, Vidal, & Dogan, 2002	□				
174. Persson & Olhager, 2002					
175. Reiner & Trcka, 2004	✓	P	I	Case study	None
176. Rungtusanatham & Forza, 2005					

F.6 Subject Area

Table F-8: Articles Classified According to Subject Area

No	Author(s)	Subject Area	Grouped
1.	Anderson & Katz, 1998	Supply management	Supply Management
2.	Christopher & Towill, 2002	Leanness/Agility	Agility
4.	Hewitt, 1994	SC re-design	Supply Chain Design
5.	Payne & Peters, 2004	Matching product and chain	3D-CE
6.	van der Horst, van Dijk, & Beulens, 2001	Decoupling	
7.	van Hoek & Weken, 1998	Modular production	
8.	Wilding, 1998b	Chaos theory	
9.	Wouters, Sharman, & Wortmann, 1999	Inventory mgmt.	
18.	Christiaanse & Kumar, 2000	ICT and SC redesign	Supply Chain Design
19.	Christopher & Towill, 2001	Agility	Agility
29.	Mason et al., 2002	Outsourcing (electronics mfg.)	Outsourcing
40.	van Hoek, Commandeur, & Vos, 1998	Postponement	
48.	Chandra & Kumar, 2000	Accurate (quick) response	Quick Response
50.	Hammel, Kuettner, & Phelps, 2002	SC re-design	Supply Chain Design
58.	McIvor, 2000	Outsourcing	Outsourcing
59.	McIvor, 2003	Outsourcing	Outsourcing
64.	Towill, 1996	Time compression	
67.	Zeng, 2003	Global sourcing	Supply Management
70.	Boyson & Corsi, 2001	Real-time supply chain	
72.	Dershin, 2000	Business process re-eng.	Supply Chain Design
74.	Kopczak, 2001	Last mile strategy	Distribution
75.	Martha & Subbakrishna, 2002	Risk management in SCD	
83.	Boardman & Clegg, 2001	3D-CE for Prod. Dev.	3D-CE
86.	Fowler, 1998	Modeling in Mgmt of Ops	
92.	Korpela, Lehmusvaara, & Tuominen, 2001a	Supply Chain Development	Supply Chain Design
93.	Korpela, Lehmusvaara, & Tuominen, 2001b	SC Design for Cust. Service	Supply Chain Design
94.	Korpela et al., 2002	Allocation of prod. capacity	Supply Chain Design
96.	Persson & Olhager, 2002	Simulation of supply chain	
104.	Blackhurst, Wu, & O'Grady, 2005	Design decisions	3D-CE
105.	Fine, Golany, & Naseraldin, 2005	3D-CE	3D-CE
109.	Hammel & Kopczak, 1993	Distrib. Res. Planning (DRP)	Distribution
113.	Fine, 2000	3D-CE	3D-CE
127.	Towill, 1997	Material flow	

Table F-8 (cont'd)

No	Author(s)	Subject Area	Grouped
137.	Robinson Jr & Satterfield, 1998	Design of distrib. systems	Distribution
138.	Swaminathan, Smith, & Sadeh, 1998	SC design	Supply Chain Design
142.	Ferdows, Lewis, & Machuca, 2004	Quick response	Quick Response
148.	Lee, Padmanabhan, & Whang, 1997	Bullwhip/Forrester	Bullwhip
158.	Johnson, 1998	Bullwhip/Forrester	Bullwhip
165.	Abdinnour-Helm, 1999	Distribution	Distribution
175.	Reiner & Trcka, 2004	SC design	Supply Chain Design

F.7 Design Objective(s)

Table F-9: Articles Classified According to Design Objective(s)

No	Cost (Profit)	Performance	Responsiveness	Lead Time	Risk	Residual Design Objective(s)
1.	(✓)	<input type="checkbox"/>	<input type="checkbox"/>	<input type="checkbox"/>	<input type="checkbox"/>	Sustainable growth
2.	✓	<input type="checkbox"/>	✓	<input type="checkbox"/>	<input type="checkbox"/>	
4.	<input type="checkbox"/>	✓	<input type="checkbox"/>	<input type="checkbox"/>	<input type="checkbox"/>	
5.	✓	✓	<input type="checkbox"/>	<input type="checkbox"/>	<input type="checkbox"/>	
6.	<input type="checkbox"/>	<input type="checkbox"/>	<input type="checkbox"/>	<input type="checkbox"/>	<input type="checkbox"/>	Demand uncertainty
7.	<input type="checkbox"/>	✓	✓	<input type="checkbox"/>	<input type="checkbox"/>	
8.	<input type="checkbox"/>	<input type="checkbox"/>	<input type="checkbox"/>	<input type="checkbox"/>	<input type="checkbox"/>	Remove uncertainty
9.	<input type="checkbox"/>	✓	<input type="checkbox"/>	<input type="checkbox"/>	<input type="checkbox"/>	Differentiation
18.	✓	<input type="checkbox"/>	<input type="checkbox"/>	<input type="checkbox"/>	<input type="checkbox"/>	Flexibility
19.	✓	<input type="checkbox"/>	<input type="checkbox"/>	<input type="checkbox"/>	<input type="checkbox"/>	
29.	<input type="checkbox"/>	<input type="checkbox"/>	<input type="checkbox"/>	<input type="checkbox"/>	<input type="checkbox"/>	Agility
40.	<input type="checkbox"/>	<input type="checkbox"/>	✓	<input type="checkbox"/>	<input type="checkbox"/>	
48.	<input type="checkbox"/>	<input type="checkbox"/>	<input type="checkbox"/>	<input type="checkbox"/>	<input type="checkbox"/>	Synchronization of chain
50.	<input type="checkbox"/>	<input type="checkbox"/>	<input type="checkbox"/>	<input type="checkbox"/>	<input type="checkbox"/>	Exploitation of opportun.
58.	<input type="checkbox"/>	<input type="checkbox"/>	<input type="checkbox"/>	<input type="checkbox"/>	<input type="checkbox"/>	Strategic Decision Making
59.	<input type="checkbox"/>	<input type="checkbox"/>	<input type="checkbox"/>	<input type="checkbox"/>	<input type="checkbox"/>	Identify drivers/processes
64.	✓	<input type="checkbox"/>	✓	<input type="checkbox"/>	<input type="checkbox"/>	
67.	<input type="checkbox"/>	✓	<input type="checkbox"/>	<input type="checkbox"/>	<input type="checkbox"/>	
70.	<input type="checkbox"/>	✓	<input type="checkbox"/>	<input type="checkbox"/>	<input type="checkbox"/>	
72.	<input type="checkbox"/>	<input type="checkbox"/>	<input type="checkbox"/>	<input type="checkbox"/>	<input type="checkbox"/>	SC integration
74.	<input type="checkbox"/>	✓	<input type="checkbox"/>	<input type="checkbox"/>	<input type="checkbox"/>	Differentiation
75.	<input type="checkbox"/>	<input type="checkbox"/>	<input type="checkbox"/>	<input type="checkbox"/>	✓	
83.	<input type="checkbox"/>	<input type="checkbox"/>	<input type="checkbox"/>	(✓)	<input type="checkbox"/>	
86.	<input type="checkbox"/>	<input type="checkbox"/>	<input type="checkbox"/>	<input type="checkbox"/>	<input type="checkbox"/>	Competitive Advantage
92.	<input type="checkbox"/>	✓	<input type="checkbox"/>	<input type="checkbox"/>	<input type="checkbox"/>	
93.	✓	<input type="checkbox"/>	<input type="checkbox"/>	<input type="checkbox"/>	<input type="checkbox"/>	Customer service
94.	<input type="checkbox"/>	<input type="checkbox"/>	<input type="checkbox"/>	<input type="checkbox"/>	✓	Customer service
96.	✓	<input type="checkbox"/>	<input type="checkbox"/>	✓	<input type="checkbox"/>	Quality
104.	<input type="checkbox"/>	✓	<input type="checkbox"/>	<input type="checkbox"/>	<input type="checkbox"/>	“Fit”
105.	<input type="checkbox"/>	✓	<input type="checkbox"/>	<input type="checkbox"/>	<input type="checkbox"/>	“Fit”
109.	✓	<input type="checkbox"/>	<input type="checkbox"/>	✓	<input type="checkbox"/>	
113.	<input type="checkbox"/>	✓	<input type="checkbox"/>	<input type="checkbox"/>	<input type="checkbox"/>	“Fit”
127.	<input type="checkbox"/>	<input type="checkbox"/>	<input type="checkbox"/>	✓	<input type="checkbox"/>	
137.	(✓)	<input type="checkbox"/>	<input type="checkbox"/>	<input type="checkbox"/>	<input type="checkbox"/>	
138.	✓	<input type="checkbox"/>	<input type="checkbox"/>	<input type="checkbox"/>	<input type="checkbox"/>	
142.	✓	<input type="checkbox"/>	✓	<input type="checkbox"/>	<input type="checkbox"/>	
148.	✓	<input type="checkbox"/>	<input type="checkbox"/>	<input type="checkbox"/>	<input type="checkbox"/>	
158.	✓	<input type="checkbox"/>	<input type="checkbox"/>	<input type="checkbox"/>	<input type="checkbox"/>	
165.	<input type="checkbox"/>	✓	<input type="checkbox"/>	<input type="checkbox"/>	<input type="checkbox"/>	
175.	<input type="checkbox"/>	✓	<input type="checkbox"/>	<input type="checkbox"/>	<input type="checkbox"/>	Robustness...

Appendix G Interview Guides

This appendix contains the interview guides used during the empirical investigations.

At each company SCM and Purchasing personnel is interviewed in two rounds. The purpose of the first round of interviews is to establish a relationship between the interviewer and the interviewees, and to obtain basic information about the company, the products and technologies, and about their SCM and SCRM practices. The second round poses more “tough” questions as current practices are challenged. Table G-1 below illustrates how the interview guides are applied during the two rounds of interviewing.

Table G-1: Application of Interview Guides

Round	Interview Guide	SCM Interviewee	Purchasing Interviewee
1	I: SCM & SCRM Practices	Yes	Yes
	II: Supply Risk Management		(Yes)
	III: Appropriateness of Current Practices		
2	I: SCM & SCRM Practices	(Yes)	(Yes)
	II: Supply Risk Management		Yes
	III: Appropriateness of Current Practices	Yes	Yes

G.1 Interview Guide I: SCM & SCRM Practices

**Interview Guide: Risk Management in the Supply Chain
SCM & SCRM Practices**

The purpose of this interview guide is to help structure the interview and ensure the planned information is collected. As the interview most likely will uncover non-planned but relevant issues, time must be allocated during the interview to pose questions/talk about issues not covered in the guide.

The interview guide is structured as follows:

- Section A: Introduction
- Section B: Company Profile
- Section C: Supply Chain Management Practice
- Section D: Supply Chain Risk Management Practice
- Section E: Critical Risks & Incidents

Section A: Introduction

This part of the guide introduces the study and the researcher to the interviewee – and verifies the identity of company and interviewee.

- Introduce the study. Explain the study is intending to describe and understand the phenomena SCM and SCRM in a number of contexts.
- Introduce yourself (the researcher) and the Supply Chain Management group within Copenhagen Business School. In case the contact is made through a common acquaintance make sure to mention him/her. Try to establish a trusting relation as early as possible.
- Check if it is acceptable to record the interview. Make sure not to force the interviewee as it might limit the answers.

A1 Verify the identity of the case company.

A2 Verify the name, position, and area of responsibility of the interviewee(s).

Make sure the interviewee(s) feel(s) as confident as possible in answering the questions.

Company <ul style="list-style-type: none"> • Name • Address • Telephone 	[Verify identity of case company.]
Interviewee(s): <ul style="list-style-type: none"> • Name(s) • Position(s) • Time & Place 	[Verify identity of interviewee(s).]

Interview Guide: Risk Management in the Supply Chain *SCM & SCRM Practices*

Section B: Company Profile

Information on the company is collected prior to the interview, e.g. the company's history, financial information, and other types of background information. The collected information should enable an initial classification according to the external conditions.

- B1 Verify/obtain information on the company's history, including mergers and acquisitions.
- B2 Obtain information on turnover and number of employees from the database AMADEUS. Verify this information. Get information on organizational structure.
- B3 Verify/obtain information on product portfolio, and manufacturing technology.
- B4 Verify/obtain information on the customer portfolio, markets etc.
- B5 Verify/obtain information on the supplier portfolio, segmentation etc.
- B6 Verify/obtain information on the competition: players, products, technology...
- B7 Other information...

Company History: <ul style="list-style-type: none"> • Company Start • Milestones 	[Verify collected material. Obtain new/alternative material.]
Current: <ul style="list-style-type: none"> • Turnover • Employees • Organizational Structure and Network 	[Verify collected material. Obtain new/alternative material.]
Portfolio & Operations <ul style="list-style-type: none"> • Products • Technology 	[Verify collected material. Obtain new/alternative material.]
Customers <ul style="list-style-type: none"> • Portfolio • Markets 	[Verify collected material. Obtain new/alternative material.]
Suppliers <ul style="list-style-type: none"> • Portfolio • Segmentation 	[Verify collected material. Obtain new/alternative material.]
Competition <ul style="list-style-type: none"> • Players • Products • Technology 	[Verify collected material. Obtain new/alternative material.]
Other:	[Anything ?]

Interview Guide: Risk Management in the Supply Chain SCM & SCRM Practices

Section C: Supply Chain Management Practice

This part of the guide collects information on the SCM practice.

- C1 Obtain information on the structure of the supply chains, including internal and external participants, markets, and products.
- C2 Obtain information on internal operations, including inventory management, postponement, distribution/hubs, and mass customization.
- C3 Obtain information on IT integration, internally as well as externally.
- C4 Obtain information on any kind of cooperative planning, coordination of schedules, campaigns etc.
- C5 Obtain information on any kind of processes implemented and their content/type.
- C6 Other information...

SCM: <ul style="list-style-type: none"> • Internal participants • External participants • Markets/products 	[Obtain information.]
Operations (Internal): <ul style="list-style-type: none"> • Inventory Management • Postponement • Distribution/Hubs • Mass Customization 	[Obtain information.]
IT Integration: <ul style="list-style-type: none"> • Type • Participants 	[Obtain information.]
Process Orientation: <ul style="list-style-type: none"> • Processes • Process Types 	[Obtain information.]
Cooperative Planning: <ul style="list-style-type: none"> • Type • Participants • Schedule 	[Obtain information.]
Other:	[Anything ?]

Interview Guide: Risk Management in the Supply Chain *SCM & SCRM Practices*

Section D: Supply Chain Risk Management Practice

This part of the guide collects information on the SCM practice.

- D1 Obtain information on formal organization and position within Risk Management.
- D2 Obtain information on informal/decentralized/embedded risk management, including scope and participants.
- D3 Obtain information on risk acknowledged and how each risk is managed (if at all).
- D4 Obtain information on identification and assessment of risks.
- D5 Other information...

Organization: <ul style="list-style-type: none"> • Department • Positions 	[Obtain information.]
Informal/Decentralized Risk Management: <ul style="list-style-type: none"> • Scope • Participants 	[Obtain information.]
Risks Acknowledged: <ul style="list-style-type: none"> • Managed • Not managed 	[Obtain information.]
Risk Identification and Assessment: <ul style="list-style-type: none"> • Scheduling • Procedures 	[Obtain information.]
Other:	[Anything ?]

Interview Guide: Risk Management in the Supply Chain SCM & SCRM Practices

Section E: Incidents & Critical Risks

This part of the guide collects information on illustrative incidents and critical risks (not necessarily related).

- E1 Obtain information on illustrative incidents, describing situation where an incident (almost) seriously impacted the company. Make sure cause/effect is described as well as the response.
- E2 Obtain knowledge on the most critical risks as perceived by the interviewee. Comparing this information from the two interviewees will describe the integration of the informal/decentralized/embedded risk management across the enterprise.
- E3 Other information...

Incident: <ul style="list-style-type: none"> • Cause/Effect • Participants • Response 	[Obtain information.]
Critical Risks: <ul style="list-style-type: none"> • Source • Cause/effect • Appropriate response 	[Obtain information.]
Other:	[Anything ?]

G.2 Interview Guide II: Supply Risk Management

Interview Guide: Risk Management in the Supply Chain *Supply Risk Management*

The purpose of this interview guide is to help structure the interview and ensure the planned information is collected. As the interview most likely will uncover non-planned but relevant issues, time must be allocated during the interview to pose questions/talk about issues not covered in the guide.

The interview guide is structured as follows:

- Section A: Introduction
- Section B: Supply Base Size and Segmentation
- Section C: Supplier Selection
- Section D: Supplier Evaluation & Management

Section A: Introduction

This part of the guide introduces the study and the researcher to the interviewee – and verifies the identity of company and interviewee.

- Introduce the study. Explain the study is intending to describe and understand the phenomena SCM and SCRM in a number of contexts.
- Introduce yourself (the researcher) and the Supply Chain Management group within Copenhagen Business School. In case the contact is made through a common acquaintance make sure to mention him/her. Try to establish a trusting relation as early as possible.
- Check if it is acceptable to record the interview. Make sure not to force the interviewee as it might limit the answers.

A1 Verify the identity of the case company.

A2 Verify the name, position, and area of responsibility of the interviewee(s).

Make sure the interviewee(s) feel(s) as confident as possible in answering the questions.

Company <ul style="list-style-type: none"> • Name • Address • Telephone 	[Verify identity of case company.]
Interviewee(s): <ul style="list-style-type: none"> • Name(s) • Position(s) • Time & Place 	[Verify identity of interviewee(s).]

Interview Guide: Risk Management in the Supply Chain

Supply Risk Management

Section B: Supply Base Size and Segmentation

This part of the guide collects information on the company's supply base hereunder size and segmentation.

- B1 How many suppliers does the company have? What is the yearly purchase value (only direct input to production)?
- B2 Has the company outsourced activities recently? (Or perhaps insourced)? Does the company have plans to outsource in the near future? If so, why?
- B3 Investigate if the supply base is segmented (formally). Check which criteria determine the various categories, and to which stringency the model is used. Investigate if each category has distinct procedures and routines in place. Investigate if uniqueness is dealt with in the model, and if uniqueness is desired or accepted.
- B4 Other information...

Supply Base: <ul style="list-style-type: none"> • Size • Value of purchase 	[Obtain information.]
Outsourcing: <ul style="list-style-type: none"> • Recent outsourcing • Planned ditto 	[Obtain information.]
Segmentation Model? <ul style="list-style-type: none"> • Criteria • Routines • Uniqueness? 	[Obtain information.]
Other:	[Anything ?]

Interview Guide: Risk Management in the Supply Chain

Supply Risk Management

Section C: Supplier Selection

This part of the guide collects information on supplier selection.

- C1 What is the company's supply strategy? Is the use of systems suppliers preferred? How much redundancy is desired?
- C2 On which criteria are suppliers selected? Are exit criteria defined? Are these rules followed?
- C3 Are criteria for exclusion defined? Are there any examples of exclusion of suppliers?
- C4 Other information...

Supply Strategy <ul style="list-style-type: none"> • Level of redundancy (single/sole sourcing) • Use of systems suppliers etc. 	[Obtain information.]
Supplier Selection: <ul style="list-style-type: none"> • Criteria? • Procedure? • Exit defined? 	[Obtain information.]
Supplier Exclusion: <ul style="list-style-type: none"> • Criteria • Risk? • Examples 	[Obtain information.]
Other:	[Anything ?]

Interview Guide: Risk Management in the Supply Chain

Supply Risk Management

Section D: Supplier Evaluation & Management

This part of the guide collects information on the evaluation and management of the supplier base.

- D1 Obtain information on how often suppliers are evaluated. Is it integrated into the segmentation model (if one such exists)?
- D2 Obtain information on which types of information is collected.
Which KPI's are collected continuously, which are obtained periodically?
Is the risk profile of the supplier evaluated periodically?
- D3 Is the supplier audited?
- D4 If there is a dependency, how is it balanced? How is the intended exit managed, and what about the un-intended?
- D5 Other information...

Evaluation Schedule: <ul style="list-style-type: none"> • Timing • Type (meeting etc.) • Financial Data 	[Obtain information.]
Evaluation Content: <ul style="list-style-type: none"> • Process • Structure • KPI's 	[Obtain information.]
Supplier Audits: <ul style="list-style-type: none"> • What & How? • How often? 	[Obtain information.]
Balancing Dependence <ul style="list-style-type: none"> • Intended exit • Un-intended exit 	[Obtain information.]
Other:	[Anything ?]

G.3 Interview Guide III: Appropriateness of Current Practices

Interview Guide: Risk Management in the Supply Chain ***Appropriateness of Current Practices***

The purpose of this interview guide is to help structure the interview and ensure the planned information is collected. As the interview most likely will uncover non-planned but relevant issues, time must be allocated during the interview to pose questions/talk about issues not covered in the guide.

The interview guide is structured as follows:

- Section A: Introduction
- Section B: Appropriateness of Current Practices

Section A: Introduction

This part of the guide introduces the study and the researcher to the interviewee – and verifies the identity of company and interviewee.

- Introduce the study. Explain the study is intending to describe and understand the phenomena SCM and SCRM in a number of contexts.
- Introduce yourself (the researcher) and the Supply Chain Management group within Copenhagen Business School. In case the contact is made through a common acquaintance make sure to mention him/her. Try to establish a trusting relation as early as possible.
- Check if it is acceptable to record the interview. Make sure not to force the interviewee as it might limit the answers.

A1 Verify the identity of the case company.

A2 Verify the name, position, and area of responsibility of the interviewee(s).

Make sure the interviewee(s) feel(s) as confident as possible in answering the questions.

Company <ul style="list-style-type: none"> • Name • Address • Telephone 	[Verify identity of case company.]
Interviewee(s): <ul style="list-style-type: none"> • Name(s) • Position(s) • Time & Place 	[Verify identity of interviewee(s).]

Interview Guide: Risk Management in the Supply Chain

Appropriateness of Current Practices

Section B: Appropriateness of Current Practices

This part of the guide collects information on the appropriateness of current SCM and SCRM practices.

- B1 Is the current practice on SCM appropriate?
 Why / why not?
 Would you like to change the practice?
- B2 Is the current practice on SCRM appropriate?
 Why / why not?
 Would you like to change the practice?
- B3 Other information...

Practice on SCM: <ul style="list-style-type: none"> • Appropriate? • Why / why not? • Change? 	[Obtain information.]
Practice on SCRM: <ul style="list-style-type: none"> • Appropriate? • Why / why not? • Change? 	[Obtain information.]
Other:	[Anything ?]

Appendix H Interviewees & Interviews

In this appendix the interviewees and the main interviews performed are documented.

H.1 Interviewees

In the table below all interviewees in the case studies are listed by company.

Table H-1: Interviewees in the Case Studies

Company	Interviewee	Position
Bang & Olufsen	Kim B. Hansen	Legal Council
	Klaus K. Knudsen	Director, Purchasing
	Peter S. Hune	Senior Manager, Purchasing
	Steen B. Jørgensen	Director, Logistics
Brüel & Kjør	Erik Ziegler	Production Manager
	Henrik Jeppesen	Global Purchasing Manager
	Ole Bjørn	Strategic Purchasing Director
Coloplast	Johnny Nielsen	VP, Supply Chain Management
	Roland V. Pedersen	Purchasing Manager
Dyrup	Finn Aagaard	Logistics Manager
	Henrik D. Nielsen	Supply Chain Director
	Nis Petersen	Purchasing Manager
Fritz Hansen	Bo Rasmussen	Factory Manager
	Henrik Holm	Logistics Manager
	Jacob Pedersen	Supply Chain Coordinator
	Marianne Thompson	Supply Chain Planner
	Rikke Schmidt	Supply Chain Planner
	Rudi Kjeldsen	Supply Chain Planner
	Thomas Touborg	Supply Chain Director
LINAK	Morten Raahede	Logistics Manager
	Paul Frees	Purchasing Director
Novozymes	Ken Friis	Purchasing Director
	Thomas Videbæk	VP, Supply Chain Operations
Oticon	Kim S. Hald	Research Fellow
	Marianne K. Borum	Purchasing Manager
	Per Sørensen	Purchasing Manager
	Peter Finnerup	VP, Logistics
RIEGENS	Claus Jensen	VP (Sales)
	Henrik Jakobsen	Purchasing Director
	Henrik J. Hansen	IT Manager
SDC Group	Erik Clarke	Logistics Planner
	Ernest Fuller	Production Manager
	Henrik Frandsen	Purchasing Manager
	Jesper Boysen	CEO
	Ole Holm ³⁶	Purchasing Assistant
	Søren Mikkelsen	Production Manager

³⁶ Henrik Frandsen left the company.

H.2 Interviews

The table below lists the most important interviews performed during the case studies.

Table H-2: Interviews Performed

Company	Date/time	Type	Recorded?	Interviewee(s)
Bang & Olufsen	2004-05-05 10:00	Pers.	No	Klaus K. Knudsen, Peter S. Hune
	2004-05-05 11:30	Pers.	Yes	Steen B. Jørgensen
	2005-06-22 08:15	Phone	Yes	Steen B. Jørgensen
	2005-08-17 09:00	Phone	Yes	Kim B. Hansen
	2005-08-22 11:15	Phone	Yes	Peter S. Hune
Brüel & Kjør	2002-08-13 13:00	Pers.	No	Erik Ziegler
	2003-11-21 12:00	Pers.	No	Ole Bjørn
	2005-06-27 10:00	Pers.	No	Henrik Jeppesen
	2005-07-29 15:30	Phone	Yes	Henrik Jeppesen
	2005-11-25 15:30	Phone	Yes	Henrik Jeppesen
Coloplast	2004-02-04 10:00	Pers.	Yes	Johnny Nielsen
	2004-05-12 13:00	Pers.	Yes	Roland V. Pedersen
	2005-06-08 14:30	Phone	No	Roland V. Pedersen
	2005-12-12 09:30	Pers.	Yes	Johnny Nielsen
Dyrup	2003-11-18 10:00	Pers.	No	Finn Aagaard
	2004-06-02 09:00	Pers.	Yes	Henrik D. Nielsen
	2004-06-14 10:00	Pers.	Yes	Nis Petersen
	2005-08-25 09:00	Pers.	Yes	Henrik D. Nielsen
Fritz Hansen	2004-11-26 15:30	Pers.	No	Henrik Holm
	2004-12-10 12:00	Pers.	No	Thomas Touborg, Henrik Holm
	2004-12-10 13:00	Pers.	Yes	Henrik Holm, Rudi Kjeldsen, Rikke Schmidt, Marianne Thompson, Jacob Pedersen, Bo Rasmussen
	2005-08-04 08:30	Pers.	Yes	Thomas Touborg, Henrik Holm
LINAK	2004-12-01 12:00	Pers.	No	Morten Raahede
	2005-08-17 10:00	Phone	Yes	Morten Raahede
	2006-01-25 10:00	Phone	Yes	Paul Frees
Novozymes	2003-12-05 10:00	Pers.	Yes	Thomas Videbæk
	2004-04-29 09:00	Pers.	Yes	Thomas Videbæk
	2004-05-06 15:00	Pers.	Yes	Ken Friis
	2005-12-19 16:30	Pers.	Yes	Thomas Videbæk
Oticon	2004-05-10 14:00	Pers.	Yes	Peter Finnerup, Marianne K. Borum, Per Sørensen
	2005-07-24 16:30	Pers.	No	Kim S. Hald
	2005-07-29 13:00	Phone	Yes	Marianne K. Borum
RIEGENS	2004-05-17 14:00	Pers.	Yes	Henrik Jakobsen
	2004-06-22 09:00	Pers.	Yes	Claus Jensen
	2005-07-07 15:00	Phone	Yes	Claus Jensen
	2005-07-29 09:00	Phone	Yes	Henrik Jakobsen
	2005-11-24 15:00	Phone	No	Henrik J. Hansen
SDC Group	2004-04-01 10:00	Pers.	No	Søren Mikkelsen, Erik Clarke
	2004-04-20 10:00	Pers.	Yes	Henrik Frandsen
	2004-05-14 10:00	Pers.	Yes	Jesper Boysen
	2005-07-06 15:00	Phone	No	Ole Holm
	2005-08-02 15:30	Phone	Yes	Ernest Fuller

Appendix I Coordination of Critical Risks?

As a few of the companies have hinted that their Risk Management practice, albeit not formalized, is at least coordinated across departmental boundaries, it is of interest to investigate to which degree this is the case. In case the risk management is in fact coordinated, one might assume the list of critical risks (or sources of risk) has been coordinated. Therefore the four companies having hinted at least some coordination have been subjected to a further analysis – an analysis of their most critical risks. For all four companies, the coordination of risks between the Logistics/SCM and Purchasing has been tested by posing the following question:

Which risks are the most critical – in terms of endangering the survival of your company?

In the following the result of these inquiries is described – one sub-chapter per company. The first table in each section gives a brief description of the risk along classifications and risk management measures in place. The second table categorizes the risks according to the classifications.

I.1 Bang & Olufsen

At Bang & Olufsen six critical risks were identified, see Table I-1 below.

Table I-1: Critical Risks Identified – Bang & Olufsen

No	Risk	Class	Type	Risk Management	Current Practice
P1	The use of systems suppliers leads to increased risk.	U	S	Risk management of critical suppliers by use of contracts and mitigation through long relationships. Risk assessment by analyzing impact (matrix with delays/downtimes, and economic consequence). Possibility: technology forum? Threat: non-intended departure!	(✓)
P2	The 670 B1 stores depend on speedy and precise delivery – they have no local inventory.	D	P	Retail Ordering System: stringency in the ordering process, use of IT-system for configuration/customization. Delivery precision is very high (use of buffer inventory for finished goods)	✓
S1	Master Dealer in e.g. China can not be too successful.	D	S	Limitations (e.g. period and volumes) in contract. Monitoring & thorough evaluation and selection of Master Dealers.	(✓)
S2	Subsidiaries can have their own objectives.	D	S	Monitoring? Power/Influence?	(✓)
S3	Ramp-up generates uncertainty due to lack of systems controls.	D	P	Enhancement of analysis on the introduction of products. Perhaps special indicators on orders for ramp-up?	%
S4	Credit limits for sales offices may have negative impacts on end-customer satisfaction	D	P	Credit limits must be monitored continuously...	%

From this list it is obvious the risk portfolio is not shared across departments. The two department representatives share no risks at all. Combining the identified risks in a matrix results in Table I-2 below.

Table I-2: Critical Risks Categorized – Bang & Olufsen

Risk Type		Risk Class			Market/Env.
		Upstream	Internal	Downstream	
Process	Managed			P2	
	Monitored				
	None			S3, S4	
Structure	Managed				
	Monitored	P1		S1, S2	
	None				

I.2 Coloplast

At Coloplast no less than twelve risks were identified.

Table I-3: Critical Risks Identified – Coloplast

No	Risk	Class	Type	Risk Management	Current Practice
P1	All eggs in one basket – reduction of supplier base	U	S	Closer/more thorough evaluation of suppliers. Risk management of fewer suppliers. Stringent evaluation: financial check, fire safety audits at suppliers plant etc.	(✓)
P2	Limited access to knowledge from suppliers	U	P	Innovation is critically important. Close relationships and innovation with suppliers.	%
P3	Single sourcing	U	S	In the case of BASF no possibility for risk management. BASF's decision perceived as irrational/based on policy.	%
P4	Coloplast being "locked in" by suppliers	U	S	Inertia / stickyness due to customer preferences and variation in suppliers' portfolios.	%
P5	Uncertainty in relation to sourcing from Asia.	U	S	Social and process integration?	%
P6	Increased complexity	E	N/A	???	%
S1	Quality Failure: Input	U	P	Supplier Plant Assessment – being done	✓
S2	Quality Failure: Internal	I	P	Quality procedures and measures in place	✓
S3	Loss of unique supplier	U	S	Very few unique suppliers – all very solid companies. Continuous contact.	✓
S4	Product specifications are too poor / not outdated.	I	P	Continuous updating of product specifications? Difficult to enforce – not attractive work...	%
S5	Suppliers' product specifications are too poor / not updated	U	P	Part of supplier management?	%
S6	Shortage of input	U	P	Warning systems in place for inventory management (order points, minimum inventory)	✓

Two of the risks identified by Purchasing at Coloplast address the issue of single sourcing, each from their own perspective. In the first instance (P1) single sourcing is an undesired result from supplier base reduction – a self inflicted risk which must be managed. The second instance (P3) is the case of BASF, where the required input is protected by patents. Here the risk is not self inflicted but caused by the protection of innovation being stronger than the need for competition (within the patent period).

Also the SCM department is aware of this risk - "Loss of critical supplier" (S3), but besides this risk no commonality between the two departments in terms of identified risks exists. Apparently no coordination is taking place.

Table I-4: Critical Risks Categorized – Coloplast

Risk Type		Risk Class			
		Upstream	Internal	Downstream	Market/Env.
Process	Managed	S1, S6	S2		
	Monitored				
	None	P2, S5			
Structure	Managed	S3			
	Monitored	P1			
	None	P3, P4, P5	S4		P6

I.3 Novozymes

Also at Novozymes at high number of critical risks were identified.

Table I-5: Critical Risks Identified – Novozymes

No	Risk	Class	Type	Risk Management	Current Practice
P1	Indirect purchasing through NN Service Partner.	I	S	Indirect purchase was supposed to be only “trivial” purchases. This was not so...	%
P2	Indirect purchasing - cost/quality & disruptions.	I	S	Constant monitoring, but fault stricken...	(✓)
P3	GMO.	E	N/A	Cooperation with NGO’s across the world. Markets chosen according to the perception of GMO	✓
P4	Increased refinement in the agricultural sector.	M	N/A	Market may or may no be influenced?	%
P5	Lack of understanding of the market.	U	S	E-sourcing not used, except for commodities.	✓
P6	Delivery precision...	U	P	Use of raw materials inventory / bulk purchasing	✓
P7	Single sourcing	U	S	Risk assessment and integration with relevant suppliers	✓
P8	Lead supplier	U	S	Suppliers are not dropped when appropriate as it is time-consuming to assess and certify replacements	%
P9	Shortage of supply (incorrect perception of input)	E	N/A	Diversification	%
S1	Supplier dependency	U	S	It is the deliberate strategy to use standardized input, not due to risks but to cost (and protection of process knowledge and enablement of innovation internally). The market dictates complexity to be placed within the firm.	✓
S2	Production disruption	I	P	Methods and techniques are enhanced continuously. Variation in output - batches are occasionally scrapped.	✓
S3	GMO	E	N/A	No activities within Food & Feed in Europe, not influential enough to correct “misperceptions” the political debate.	✓
S4	Quality breaches	U	P	Monitoring and quality control (but not in second tier)	✓

Also at Novozymes the issue of single sourcing is recognized as a critical risk. This perception is shared between Purchasing and SCM – in a few variations (as was the case for Coloplast). The vulnerability towards the public opinion of GMO’s is also well perceived at both departments – and both reference the current strategy of not supplying Food & Feed in

the European market. The strategic importance of managing the risk of stirring public opinion is apparently communicated throughout the company.

No shorter-term risks are shared across the two departments – risk portfolios do not seem to be shared.

Table I-6: Critical Risks Categorized – Novozymes

Risk Type		Risk Class			
		Upstream	Internal	Downstream	Market/Env.
Process	Managed	P6, S4	S2		
	Monitored				
	None				
Structure	Managed	P5, P6, P7, S1			P3, S3
	Monitored		P1		
	None	P8	P2		P4, P9

I.4 SDC DANDISC

At SDC DANDISC nine risks were identified.

Table I-7: Critical Risks Identified – SDC DANDISC

No	Risk	Class	Type	Risk Management	Current Practice
P1	The VHS market is dying	E	N/A	Consumption of resources closely monitored, planning for exit	✓
P2	Heterogeneous customer base	D	S	Technicolor is a dominant customer (30%)	(✓)
P3	Security breach – property rights	I	P	Entry and exit checks, intensive procedures for mail security, fence surrounding the factory, guards...	✓
P4	Quality breach	U	P	Monitoring and quality control...	✓
S1	Decreasing prices	E	N/A	Constant monitoring of suppliers performance and process. Own competence in distribution in the Nordic countries.	✓
S2	Delivery precision	I	P	Continuous improvement of processes.	(✓)
S3	Shift in technology	E	N/A	“Reading the curves”	(✓)
S4	Heterogeneous customer base	D	S	Adaptation / new services Strategy to diversify	(✓)

Apparently the critical risks for SDC DANDISC are “shift in technology” and “dominant customer”. Both departments have identified both risks which may indicate a level of sharing of risk portfolios.

Interestingly, the size of the dominant customer did not seem to trouble the interviewees – and this is especially interesting since during the research project the customer actually chose to move their purchase to Poland.

The other risk, the shift in technology, is recognized throughout the company as the most important parameter for long-term survival. Many examples of companies in the business who did not pay enough attention to these shifts document the importance of managing this risk.

Table I-8: Critical Risks Categorized – SDC DANDISC

Risk Type		Risk Class			
		Upstream	Internal	Downstream	Market/Env.
Process	Managed	P4	P3		
	Monitored		S2		
	None				
Structure	Managed				P1, S1
	Monitored			P2, S4	S3
	None				

Appendix J Triangulation I – External Reporting

In this appendix the detailed information obtained by the triangulation in the external reporting is described. The information is described by the following constructs: ‘External reporting on SCM’, ‘External reporting on Corporate Governance’, ‘External reporting on Business Risk Management’, and ‘External reporting on Financial Risk Management’.

J.1 Construct ‘External Reporting on SCM’

Table J-1: Summary of ‘External Reporting on SCM’

Company	External Reporting on SCM	Y/N
Bang & Olufsen	The entity ‘supply chain’ is not referenced but the importance of suppliers is described in the “Knowledge Resources” section: “Bang & Olufsen has extended cooperation with some of the worlds best suppliers within a number of areas, where Bang & Olufsen does not itself possess the knowledge and competence. These partners not only supply components to Bang & Olufsen’s production, they also supply knowledge and competence to the development of the products.” (Bang & Olufsen, 2005, p. 53, translated)	(Yes)
Brüel & Kjør	No reference to ‘supply chains’ is made in the annual accounts, but to the practice of having close relationships with suppliers: “On the supply side the company tries to safeguard the technological lead by working closely with the larger suppliers.” (Brüel & Kjør Sound & Vibration Measurement, 2005, p. 4, translated)	(Yes)
Coloplast	No reference to ‘supply chains’ is made in the annual accounts, but ‘Logistics and IT’ is briefly mentioned, hereunder the ERP implementation and the forthcoming European Distribution Centre in Hamburg. (Coloplast, 2004)	No
Dyrup	Under the heading “The supply chain” the importance of SCM is emphasized: “A well-functioning and efficient supply chain is essential for Dyrup to continue in the right direction and to remain competitive. The optimum transport structure, streamlined production processes and effective planning routines are all elements that have a major impact on costs and efficiency in the supply chain. ... The logistics processes are being restructured and strengthened across the Group. The changes are intended to raise productivity and create a more satisfactory working environment.” (Dyrup, 2005, p. 9)	Yes
Fritz Hansen	No reference to ‘supply chains’ or any related concept is made in the annual accounts. (Fritz Hansen, 2004)	No
LINAK	No reference to ‘supply chains’ or any related concept is made in the annual accounts. (LINAK, 2004)	No
Novozymes	No reference to ‘supply chains’ is made in the annual accounts, but the practice of having close relationships with customers is described. Furthermore the company routinely initiates cross-departmental groups to facilitate knowledge sharing. (Novozymes, 2005, p. 19 and 20, respectively)	(Yes)
Oticon	No reference is made to supply chain, but to ‘value chain’: “The companies in the William Demant Holding group work closely together in the early stages of the value chain, e.g. purchasing and production. In the part of the value chain facing the customers, e.g. product development, marketing and sales, each company has its own organization and identity.” (William Demant Holding, 2005, p. 3)	No
RIEGENS	No reference to ‘supply chains’ or any related concept is made in the annual accounts. (RIEGENS, 2005)	No
SDC DANDISC	No reference to ‘supply chains’ is made in the annual accounts, but to ‘value chain’ (which is explained in terms of service offerings). (SDC DanDisc, 2005)	No

J.2 Construct ‘External Reporting on Corporate Governance’

Table J-2: Summary of ‘External Reporting on Corporate Governance’

Company	External Reporting – Corporate Governance	Y/N
Bang & Olufsen	Reference to corporate governance is made, and two issues are dealt with: the use of multiple share types (A and B shares) and incentives for members of management and the boards. No references to risk management is made, but “...concerning the other concrete recommendations in the reports, management continuously use these when evaluating the corporate governance, in such a manner as to best manage the interests of the company and other stakeholders.” (Bang & Olufsen, 2005, p. 48, translated)	Yes
Brüel & Kjær	No reference is made to corporate governance. (Brüel & Kjær Sound & Vibration Measurement, 2005)	No
Coloplast	With the aim of attracting more investors, increase the insight of shareholders and employees, to enhance managements ability to see strengths and weaknesses, and to increase other stakeholders confidence in Coloplast, corporate governance is defined as “... corporate governance refers to the business principles underlying the organization, relations with stakeholders and the processes for determining and implementing basic business concepts, strategy, business objectives and controls. Coloplast’s Board of directors and Group Management regularly review the company’s business processes against these principles.” (Coloplast, 2004, p. 21). In a supplement published on the corporate website the company adds risk management as an issue dealt with under corporate governance (see Table J-3).	Yes
Dyrup	No reference is made to corporate governance. (Dyrup, 2005)	No
Fritz Hansen	No reference is made to corporate governance. (Fritz Hansen, 2004)	No
LINAK	No reference is made to corporate governance. (LINAK, 2004)	No
Novozymes	Corporate governance at Novozymes is an integral element of the management routines and encompasses multiple issues, hereunder risk management. The company has worked with corporate governance for several years, and uses it to improve practices by e.g. evaluating the cooperation between management and the Board. (Novozymes, 2005)	Yes
Oticon	Corporate governance at Oticon is an integral element of management, at least at holding company level: “It is the perception of the Board that corporate governance within the William Demant group fully complies with the guidelines presented in the Nørby report.” (William Demant Holding, 2005, translated). In William Demant Holding (2003) a number of issues are identified, hereunder: 1. shareholders role, 2. principles for communication, 3. duties, composition and remuneration of the board of directors, and 4. risk management. The section on the latter issue is very brief.	Yes
RIEGENS	No reference is made to corporate governance. (RIEGENS, 2005)	No
SDC DANDISC	Corporate governance is briefly mentioned: “SDC DanDisc follows the part of the recommendations from the Nørby report which is relevant for the company.” (SDC DanDisc, 2005, p. 15, translated). The only issue touched upon is minority share holders.	(Yes)

J.3 Construct ‘External Reporting on Business Risk Management’

Table J-3: Summary of ‘External Reporting on Business Risk Management’

Company	External Reporting – Business Risk Management	Y/N
Bang & Olufsen	No reference to the management of business risks was found. (Bang & Olufsen, 2005)	No
Brüel & Kjør	The only business risk mentioned is the risk of losing the technological lead. (Brüel & Kjør Sound & Vibration Measurement, 2005)	(Yes)
Coloplast	“Coloplast has established a formal process for the identification, management, and reporting of business and financial risks. Risk management aims to maintain stability in the generation of profit and to protect Coloplast’s reputation.” (Coloplast, 2004). Significant risks are ‘Market conditions’, ‘Competition’, and ‘Innovation’. In a supplement on corporate governance (Coloplast, 2005a), the process is described: “Coloplast’s risk management is implemented through an annual process based on input from all parts of the organization...” In a supplement on business risk management (Coloplast, 2005b) each of the categories mentioned are described in more detail.	Yes
Dyrup	Risk management is important to Dyrup: “Effective risk management at all levels of the organization contribute to protecting Dyrup’s values and the achievement of planned results.” (Dyrup, 2005, p. 13, translated). The volatility of the market is explicated, and the price formations’ dependence on the oil price is described. Furthermore the dependence on suppliers is mentioned: “Some of the raw materials used by Dyrup are only available from a handful of suppliers. Wherever possible, Dyrup seeks to obtain guarantees with respect to agreed supply capacity and stable prices.” (p. 13)	Yes
Fritz Hansen	Only one business risk is mentioned: “... the general economic trend, since the sales of furniture is strongly dependent on the economic situation of our customers, who are primarily in the corporate and institutional markets in Western Europe, Japan, and USA.” (Fritz Hansen, 2004, p. 5, translated)	No
LINAK	The only business risks mentioned is inventory of obsolete customer-specific products. The liability is limited as customers are obliged to purchase this inventory. (LINAK, 2004)	(Yes)
Novozymes	The main risk identified relates to the core technology: “Novozymes’ business is the industrial application of contained gene technology. The general accept of the application of industrial gene technologies are therefore critically relevant. Novozymes promotes openness towards stakeholders and work dedicated on informing about the advantages of contained application of gene technology” (Novozymes, 2005, part I, p. 14, translated). The other major business risk mentioned is the customer portfolio, which is dominated by relatively few, large customers. To mitigate the risk: “... we cooperate closely with these customers, on e.g. shared production planning and by integrating IT systems.” (part II, p. 7, translated)	Yes
Oticon	In the annual accounts no reference is made to the management of business risks (William Demant Holding, 2005). In the report on Corporate Governance (William Demant Holding, 2003) it is briefly described that the risk management policies include quality assurance systems.	No
RIEGENS	The main risk mentioned is the “general trend in the market” which is somewhat vague. Furthermore, under the heading “Other risks” the following clause is found: “The company has no essential risks concerning any customer, since cooperation with the larger customers typically is based on longer term commitments.” (RIEGENS, 2005, p. 5, translated).	No
SDC DANDISC	Besides the “classic four” financial risk categories, the list of risks in the annual accounts include: price risks, market risks, dependence on key employees, security risks, and environmental risks. Security and market risks are the most important of the business risks (SDC DanDisc, 2005, p. 13).	(Yes)

J.4 Construct ‘External Reporting on Financial Risk Management’

Table J-4: Summary of ‘External Reporting on Financial Risk Management’

Company	External Reporting – Financial Risk Management	Y/N
Bang & Olufsen	The “classic four”: currency, interest rate, credit, and liquidity risks are all described, the former being the only relevant risks category for Bang & Olufsen. (Bang & Olufsen, 2005)	Yes
Brüel & Kjør	Currency, interest rate, and credit risks are mentioned. Due to a conservative credit policy, the company evaluates all its potential creditors, and rarely sustains any losses. Conversely, currency risks are accepted. (Brüel & Kjør Sound & Vibration Measurement, 2005)	Yes
Coloplast	Besides being part of the framework for ‘Managing business risks’ (coloplast managing), overall responsibility for setting policies lies with the parent company’s Corporate Finance department. (Coloplast, 2004, p. 9).	Yes
Dyrup	Currency, interest rate, and credit risks are mentioned, but all are quite limited. Insurance is used to ensure stability: “Besides statutory insurances, the Group has taken out business interruption and product liability insurance.” (Dyrup, 2005, p. 13)	Yes
Fritz Hansen	Currency, interest rate, and credit risks are described in the annual report, currency risk being the only risk category relevant for management: “It is the policy of the company to cover 80% of the expected currency risk by the start each calendar year, if the currency represents a value of at least 200 mio DKK. Currency risks in EURO are not covered.” (Fritz Hansen, 2004, p. 6, translated)	Yes
LINAK	Only currency risk is mentioned. It is managed through balancing purchase and sales in each foreign currency. (LINAK, 2004)	Yes
Novozymes	The “classic four”: currency, interest rate, credit, and liquidity. The company has conservative policies on interest rate and currency risks - credit and liquidity risks are more or less irrelevant. (Novozymes, 2005)	Yes
Oticon	The description of the management of financial risks is very brief, and includes only credit and currency risks. (William Demant Holding, 2005)	Yes
RIEGENS	Only currency risk is referenced. Since most transactions are carried out in EURO and GBP, the risk is perceived as quite minimal. (RIEGENS, 2005)	Yes
SDC DANDISC	The “classic four” are on a list of the relevant risk types. Of the four types the credit risk is the most important as: “... there is a certain concentration of credit risks on few larger customers.” (SDC DanDisc, 2005, p. 13, translated)	Yes

Appendix K Triangulation II - Finance/Staff Perspective

In this appendix the interviewees and interviews performed with the Finance/Controlling departments in the case companies during the second triangulation are documented. The interviews performed thereby constitute a sub-study which is subsequently compared/analyzed against the SCM and Purchasing practices documented in the case studies.

K.1 Interviewees

In the table below all interviewees participating in the sub-study are listed by company.

Table K-1: Interviewees in the Case Studies

Company	Interviewee	Position
Bang & Olufsen	Kim B. Hansen	Legal Council
	Palle Dalgård	Legal Council
Brüel & Kjør	Claus T. Madsen	Controller
Coloplast	Peter Kofoed	Risk Manager
Dyrup	Anders B. Sørensen	Risk Manager
Fritz Hansen	Morten H. Larsen	Head of Accounting
LINAK	Claus Borchert	Finance Director
Novozymes	[Contact person identified but no interview performed]	
Oticon	Svend Thomsen	Finance Manager
RIEGENS	Thomas Hansen	Finance Manager
SDC Group	Torben Nordquist ³⁷	CEO

K.2 Interviews

The table below lists the interviews performed during the sub-study.

Table K-2: Interviews Performed

Company	Date/time	Type	Recorded?	Interviewee(s)
Bang & Olufsen	2005-08-17 09:00	Phone	Yes	Kim B. Hansen
	2005-08-22 11:15	Phone	No	Palle Dalgård
Brüel & Kjør	2005-12-12 16:30	Phone	Yes	Claus T. Madsen
Coloplast	2005-12-21 09:00	Phone	Yes	Peter Kofoed
Dyrup	2005-12-12 15:30	Phone	Yes	Anders B. Sørensen
Fritz Hansen	2005-12-05 15:00	Phone	Yes	Morten H. Larsen
LINAK	2006-01-26 10:00	Phone	Yes	Carsten Borchert
Novozymes	[Contact person identified but no interview performed]			
Oticon	2005-12-16 11:30	Phone	No	Svend Thomsen
RIEGENS	2005-11-28 11:00	Phone	Yes	Thomas Hansen
SDC Group	2005-11-24 15:30	Phone	No	Torben Nordquist

³⁷ Following the merger of DCM and SDC, Jesper Boysen left the new company, Dicientia. Torben Nordquist took over as CEO.

K.3 Interview Guide IV: Risk Management Practice

Interview Guide: Risk Management in the Supply Chain *Triangulation II: Finance/Controlling*

The purpose of this interview guide is to help structure the interview and ensure the planned information is collected. As the interview most likely will uncover non-planned but relevant issues, time must be allocated during the interview to pose questions/talk about issues not covered in the guide.

The interview guide is structured as follows:

- Section A: Introduction
- Section B: Risk Management Practice

Section A: Introduction

This part of the guide introduces the study and the researcher to the interviewees.

- A1 Introduce yourself (the researcher) and the Supply Chain Management group within Copenhagen Business School. In case the contact is made through a common acquaintance make sure to mention him/her. Try to establish a trusting relation as early as possible.
- A2 Verify the name, position, and area of responsibility of the interviewee(s).
- A3 Check if it is acceptable to record the interview. Make sure not to force the interviewee as it might limit the answers.
- A4 Introduce the study. Explain how the two interviews planned at each company is not intended to check/control the interviewee but to unravel as much information as possible. Also explain that the study is not intending to rank companies, but simply to explain the phenomena SCM and Risk Management in a number of contexts.

Make sure the interviewee feels as confident as possible in answering questions on SCM and Risk Management.

Company <ul style="list-style-type: none"> • Name • Address • Telephone 	e.g. B&O A/S Peter Bangs Vej 15 7600 Struer +45 9684 1027
Interviewee(s): <ul style="list-style-type: none"> • Name(s) • Position(s) • Time & Place 	e.g. Klaus Knudsen, (Director, Purchasing), Building 9, May 5 th , 2004, 10:00 AM Sten Bilde Jørgensen, (Director, Logistics), Factory 3, May 5 th , 2004, 11:15 AM

Interview Guide: Risk Management in the Supply Chain

Triangulation II: Finance/Controlling

Section B: Risk Management Practice

This part of the guide collects information on the SCM practice.

- D1 Obtain information on formal organization and position within Risk Management.
 D2 Obtain information on informal/decentralized/embedded risk management, including the identification of routines and participants.
 D3 Other information...

Formal Risk Management: <ul style="list-style-type: none"> • Department • Positions • Shared Procedures 	[Obtain information.]
Informal/Decentralized Risk Management: <ul style="list-style-type: none"> • Routines • Participants 	[Obtain information.]
Other:	[Anything ?]

Appendix L Consultancy Practice II

This appendix contains detailed information on the second investigation of consultancy firms' practices on Supply Chain Risk Management (or other integrated risk management frameworks). This study was performed mid-2005 approx 1½ years after the initial investigation.

L.1 Consultancies, Contacts, and Interviewees

As in the first investigation the intent of the study is to understand the level of interest for and competency within Risk Management in Supply Chains. The method has not changed, but a few companies were added to the list, see Table L-1 below.

Table L-1: Companies, Contacts, and Interviewees

Consultancy	Contact Interviewee	Contacted on Interviewed on	Result
Accenture	Carsten Sachmann	2005-05-03	OK!
	Carsten Sachmann	2005-06-13 (telephone)	
AT Kearney	Jesper Schade	2005-05-03	OK!
	Jesper Schade	2005-05-03 (telephone)	
COWI	Stig P. Christensen	2005-05-03	OK!
	Jens Schierbeck	2005-06-17 (telephone)	
Deloitte & Touche	Henning Winter	2005-05-03	OK!
	Henning Winter	2005-05-03 (telephone)	
Ernst & Young	Henrik Holmark	2005-04-20	OK!
	Henrik Holmark	2005-04-20 (telephone)	
IBM Consulting	Henrik Knak	2005-05-03	OK!
	Henrik Knak	2005-05-03 (telephone)	
KPMG Advisory	Henrik Bang	2005-04-20	OK!
	Henrik Nygård	2005-06-13 (telephone)	
Marsh Consulting	Bjørn Rothaus	2005-06-13	Left Marsh for PwC
	Rikke Aarøe Carlsen	2005-06-13 (telephone)	OK!
McKinsey	Jill Febry / Martin Møller	2005-05-03 / 2005-06-14	OK!
	Johannes Lüneborg	2005-06-17 (telephone)	
PwC	Leif Christensen	2005-06-17	OK!
	Henrik Axelsen	2005-06-22 (telephone)	

L.2 Results

For some reason the companies were much more forthcoming when approached for a telephone interview. No deliberate changes in the way of approaching the consultancy firms were made. The results are described below.

L.2.1 Accenture

Albeit both SCM and Risk Management are both very important discipline areas for Accenture, according to Carsten Sachmann no services combining the two exist at present time. Besides the “traditional” risk management services (IT Risk Management, Financial Risk Management etc.) managing the project risks are a focal responsibility for all project managers. Besides an elaboration on the differences in internal risk management practices between projects types (advisory versus implementation), no conclusions on the advent of a

customer market for Supply Chain Risk Management could be made as no demand for this type of service has been identified. In case such a market eventually would emerge, the competence would most probably be located in the cross-Nordic organization to enable cross-fertilization.

L.2.2 AT Kearney

At AT Kearney, a considerable effort has been made to create a framework to measure/understand the customers’ practices within Risk Management. The framework contains a large number of variables across seven categories, see Figure L-1 below.

Figure L-1: Stages of Excellence in Risk Management³⁸

DIMENSION	STAGE 1	STAGE 2	STAGE 3	STAGE 4
Responsibility level	<ul style="list-style-type: none"> Functional or departmental silo 	<ul style="list-style-type: none"> Business unit 	<ul style="list-style-type: none"> Corporate (chief risk officer) 	<ul style="list-style-type: none"> Extended enterprise (board level)
Scope of risk	<ul style="list-style-type: none"> Market risks (foreign exchange, credit, commodity) Property or safety risks IT security 	<ul style="list-style-type: none"> Market risk Property or safety risk Operational risk IT disruption Easily quantified risks 	<ul style="list-style-type: none"> All enterprise risks Business continuity Country risk Key business processes Day-to-day risks 	<ul style="list-style-type: none"> Strategic risks Operational resilience Global business environment Organizational or cultural component of risk management
Risk-mitigation tools	<ul style="list-style-type: none"> Financial derivatives, property insurance 	<ul style="list-style-type: none"> Incident data and trend analysis Supplier contract reviews Self-assessment 	<ul style="list-style-type: none"> Contingency planning Scenario analysis New business and new venture reviews Independent audits Risk adjusted performance measures 	<ul style="list-style-type: none"> Advance warning systems Back-up of processes as well as data Quarterly drills that include key partners
Motivation	<ul style="list-style-type: none"> Follow regulations, reduce financial exposure 	<ul style="list-style-type: none"> Avoid operational disruptions, avoid costs of accidents 	<ul style="list-style-type: none"> Protect brand image, maintain earnings stability 	<ul style="list-style-type: none"> Create competitive advantage, generate shareholder value
Updates to risk plan	<ul style="list-style-type: none"> Never 	<ul style="list-style-type: none"> After major incidents 	<ul style="list-style-type: none"> Annually 	<ul style="list-style-type: none"> Quarterly
Supply chain	<ul style="list-style-type: none"> Buffer inventories Excess capacity 	<ul style="list-style-type: none"> Alternate suppliers Recovery plans – select scenarios 	<ul style="list-style-type: none"> Coordinated forecasts throughout supply chain ”What if” modeling Agility: products and processes 	<ul style="list-style-type: none"> Supply chain transparency ”War gaming” Dynamic reserves of critical components
Collaboration	<ul style="list-style-type: none"> Focus internally 	<ul style="list-style-type: none"> Communicate policies to suppliers 	<ul style="list-style-type: none"> Collaborate with suppliers, industry associations 	<ul style="list-style-type: none"> Lead industry initiatives, collaborate with government

Describing different levels of competence within the listed categories, the framework can be used to grade the customer and to identify areas for improvement. The framework does not in itself constitute a model for the implementation of Supply Chain Risk Management, but especially the category “Supply chain” might inspire consultants and managers from the

³⁸ Source: Figure 2 in Monahan, Laudicina, & Attis (2003), p. 10.

customer organization to evaluate practices on both the process and structural level³⁹. Interestingly only in stage 4 the area of responsibility extends the legal boundaries of the firm. As for Accenture risk management is a focal component in many SCM and Procurement projects as well as in the internal management of projects, but as far as Jesper Schade knows no separate projects on Supply Chain Risk Management have been implemented by AT Kearney.

L.2.3 COWI

At COWI, a department for Integrated Risk Management Services has been created recently. Jens Schierbeck describes how COWI, in order to enable a better and more comprehensive risk management services portfolio, has decided to invest in the creation of this new business area, pulling together competencies for process and change management and supported by the experts from the various technical areas. The ambition for the business area is to change the risk management focus of COWI itself and their customer from being focused solely on technically oriented risks to the strategic risks and opportunities.

This is to be achieved by the use of their “Risk and Opportunity Check” framework, a generic framework that takes its starting point in the company and its context. The framework is generic in the sense that it does not contain a detailed description of all the risk categories, but provide a process for the identification and assessment of risks and opportunities.

Jens Schierbeck also describes how “selling” the concept internally has been quite a challenge as the new concept is non-quantitative focusing on the broad, overall strategic issues in contrast to the existing quantitatively (engineering-oriented) competencies. The process is quite generic as it:

1. defines the boundaries and the objects for analysis,
2. determines goals/objectives,
3. identifies risks/opportunities, and
4. deploys the appropriate (technical) competencies.

The hope for the concept both internally as well as for the customers is that the upside of risks, the opportunities, is recognized as well, and that the management of risks has to be integrated in the strategizing efforts.

So far the concept has been tested externally on a number of old, loyal customers, who all have responded positively. The services are ready to be marketed after the summer holidays.

L.2.4 Deloitte & Touche

Deloitte & Touche does not have any experience with risk management in a supply chain management context. Obviously, they practice risk management on their own activities (project risk management), and do include risk management evaluation on e.g. scenarios for

³⁹ In other words to evaluate according to the Risk Matrix as defined in Chapter One.

outsourcing, but do not offer advisory services within or experience demand for supply chain risk management.

L.2.5 Ernst & Young

At Ernst & Young some experience with implementation of integrated risk management frameworks exist, as ERM-type frameworks have been implemented earlier. Currently Ernst & Young are working on developing a framework, “Risk Universe”, which basically is comparable to the COSO framework described previously. According to Henrik Holmark the area of Supply Chain Risk Management is perceived as an interesting (not least commercially) area, but so far the experience gained has primarily been obtained through projects on outsourcing to e.g. China.

L.2.6 IBM Consulting

According to Henrik Knak IBM does not work specifically on Risk Management in Supply Chains. Risk management is perceived as an integral element in all project management and in any proposals for corporate re-structuring and process re-engineering.

L.2.7 KPMG Advisory

At KPMG Advisory Henrik Nygård argues that no demand for Supply Chain Risk Management has been identified. As for the other consultancies risk management is a critical competence when managing projects, but the demand they encounter is for more “traditional” SCM services like outsourcing, implementation of LEAN Manufacturing, ERP (SAP) upgrades etc.

L.2.8 Marsh Consulting

A brief interview with before mentioned Rikke Aarøe Carlsen reveals that the framework for Supply Chain Risk Management has not developed into a mature, generic framework, and have definitely not been implemented (in Denmark at least). The company is still eager to migrate into strategic consulting but remain primarily occupied with insurance brokerage and simpler risk evaluation projects for their broad customer portfolio.

According to Rikke Aarøe Carlsen, the customer base is simply not yet ready for this level of sophistication in their risk management practices.

L.2.9 McKinsey

The interview with Johannes Lüneborg at McKinsey documents that the subject is of relevance but that no framework for this type of risk management exists at McKinsey. Having extensive experience with e.g. outsourcing projects the risks of dependency is a natural component in discussing scenarios for strategic change. But since these issues always will be heavily influenced by the company and its context, frameworks will inherently be of a generic nature. According to Johannes Lüneborg, the development of a formal methodology

for Supply Chain Risk Management is therefore quite unlikely. And to his knowledge no projects on the subject exists within McKinsey in the region.

L.2.10 PricewaterhouseCoopers

PwC has developed a global framework for (enterprise) risk management, integrating governance, risk and compliance. Briefly it covers 3 project phases - diagnostic/design/implementation, as PwC views the development of ERM within firms as a change initiative, where benefits must be realized in the process. Risks are assessed, evaluated and prioritized on a portfolio basis across a company's value chain or parts thereof, including the supply chain. Management effectiveness is assessed against the critical risks, using any common risk management framework and a customized risk management framework is designed and implemented on the basis of this diagnostic. The COSO framework described previously described (see Appendix B) is still being used at PwC in particular with non-financial services firms. It acts as the generic framework for the integration of the traditionally functionally separated risk management functions/responsibilities. As already described the framework is not really SCM oriented as it includes neither suppliers nor customers. Still, it aims at integrating risk management practices and emphasizes the strategic dimension.

The final version of the COSO report was released in October 2004, and following that PwC performed a study (PriceWaterhouseCoopers, 2005) of risk management practices in Danish companies across industries. Quite surprisingly, 27% of the companies participating in the study responded having implemented full scale Enterprise Risk Management (ERM). Lest this last category (category E, please see Figure L-2 below) the rest of the responses to this question were as expected with quite few companies having an integrated risk management methodology in place. The study also revealed that approx. half the companies expect to strengthen their risk management in the coming years, and also approx. half the companies rate risk management as very important.

Figure L-2: Implementation of Risk Management⁴⁰

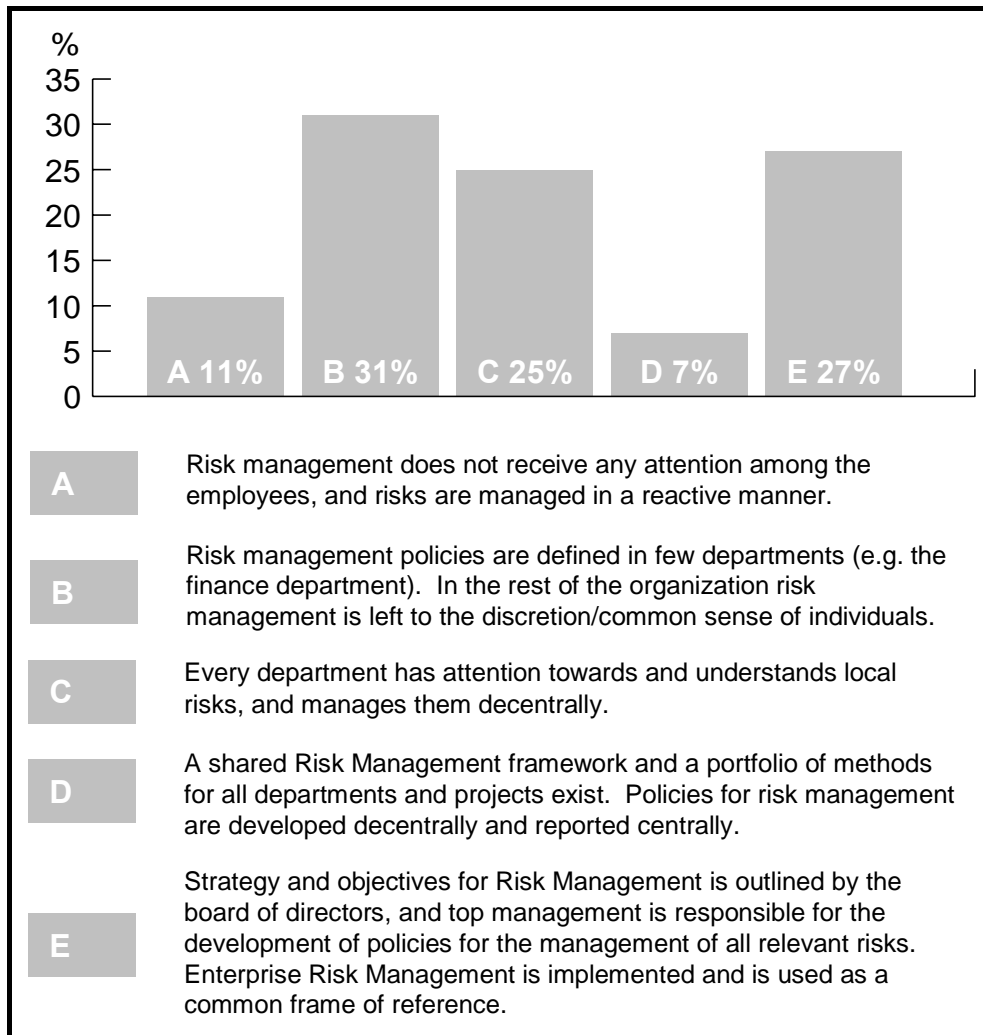

Full implementations of ERM are still absent but partial projects are becoming more and more frequent. Henrik Axelsen report demand for risk management implementations is increasing, primarily for financial risk management projects, where companies want to integrate previous 'silo' functions, such as insurance and treasury or risk adjusted performance and evaluation models as well as certain compliance type projects⁴¹.

As projects are often expected to result in a list of risks and quantified measures, PwC internationally are working on collecting and manipulating (categorizing and aggregating) data for a portfolio of benchmarks for risk management in the COSO framework. The risk identification is still more art than science as the list of potential risk sources in principle is endless, but the structured approach recommended by COSO (Top-down, Bottom-up, External expertise, & Benchmarks) ensure a certain level of certainty.

⁴⁰ Source: Figure 2 in PricewaterhouseCoopers (2005), p. 3 (author's translation).

⁴¹ Risk management projects at PwC originate as either governance ("can we achieve our goals?"), risk ("can we optimize/improve our current approach to risk management using alternative approaches"), or compliance ("do we do what we intend/say?" or "do the right things right?") type projects. Often RFQ's for compliance projects evolve into governance type projects including strategizing and implementation, and vice-versa.

Summing up, PwC expect an increased interest in ERM, and are further developing their competencies to meet demand.

L.3 Conclusion

Comparing with the previous study performed in late 2003, consultancies have been much more forthcoming in terms of giving interviews and sharing knowledge. Table L-2 below summarizes the findings.

Table L-2: Integrated Risk Management Frameworks

Consultancy	Risk Management Framework	Implemented?
Accenture	None	N/A
AT Kearney	Framework on Excellence in Risk Management	N/A
COWI	Risk and Opportunities Check	(Yes)
Deloitte & Touche	None	N/A
Ernst & Young	ERM-type frameworks “Risk Universe”	Yes Yes
IBM Consulting	None	N/A
KPMG Advisory	None	N/A
Marsh Consulting	Supply Chain Risk Management (under dev.)	No
McKinsey	None	N/A
PwC	ERM / COSO	Yes

The majority of consultancies do not work with risk management, except internally when answering bids and working on implementation projects for customers. Neither of the “strategy consultancies” (AT Kearney & McKinsey) has local competencies but may request the transfer personnel from e.g. the US. The same goes for KPMG and IBM, and presumably for Accenture as well.

Albeit three of the consultancies have implemented integrated risk management frameworks of various kinds⁴², none of them are oriented towards SCM. Risk management is thereby not integrated into SCM, even if the consultants working on SCM all state that risk management is of critical importance when implementing various SCM concepts. All agree that reduction of the supplier base and the trend of outsourcing require stringent risk analysis when evaluating scenarios, and it is evident that the leaner supply chain will require a closer monitoring and availability of alternative resources.

But so far, no consultancies have developed concepts comparable to the framework put forward in this dissertation.

⁴² Possibly more of the consultancies have implemented integrated risk management. Especially the larger consultancies probably have the competencies in their (international) network.

References

- Abdinnour-Helm, S. (1999), "Network design in supply chain management", *International Journal of Agile Management Systems*, vol. 1, no. 2, pp. 99-106.
- Adams, A. H. & Walbank, W. M. (1983), "New Products - Strategies and Risks for Smaller Firms", *International Journal of Operations & Production Management*, vol. 3, no. 2, pp. 33-36.
- Agrawal, V. & Seshadri, S. (2000), "Risk intermediation in supply chains", *IIE Transactions*, vol. 32, no. 9, pp. 819-831.
- Agrell, P. J., Lindroth, R., & Norrman, A. (2004), "Risk, information and incentives in telecom supply chains", *International Journal of Production Economics*, vol. 90, no. 1, pp. 1-16.
- Akomode, O. J., Lees, B., & Irgens, C. (1999), "Evaluating risks in the new product development and assessing the satisfaction of customers through information technology", *Production Planning & Control*, vol. 10, no. 1, pp. 35-47.
- Albino, V. & Garavelli, A. C. (1995), "A methodology for the vulnerability analysis of just-in-time production systems", *International Journal of Production Economics*, vol. 41, no. 1-3, pp. 71-80.
- Allaire, Y. & Firsirotsu, M. E. (1989), "Coping with Strategic Uncertainty", *Sloan Management Review*, vol. 30, no. 3, pp. 7-16.
- Allen, S. J. & Schuster, E. W. (2000), "Managing risk for the grape harvest at Welsh's, Inc.", *Production and Inventory Management*, vol. 41, no. 3, pp. 31-36.
- Anderson Jr, E. G., Fine, C. H., & Parker, G. G. (2000), "Upstream volatility in the supply chain: The machine tool industry as a case study", *Production and Operations Management*, vol. 9, no. 3, pp. 239-261.
- Anderson, M. G. & Katz, P. B. (1998), "Strategic sourcing", *International Journal of Logistics Management*, vol. 9, no. 1, pp. 1-13.
- Anumba, C. J., Siemieniuch, C. E., & Sinclair, M. A. (2000), "Supply chain implications of concurrent engineering", *International Journal of Physical Distribution & Logistics Management*, vol. 30, no. 7, pp. 566-597.
- Arcelus, F. J., Pakkala, T. P. M., & Srinivasan, G. (2002), "A purchasing framework for B2B pricing decisions and risk-sharing in supply chains", *Decision Sciences*, vol. 33, no. 4, pp. 645-666.
- Arntzen, B. C. & Shumway, H. M. (2002), "Driven by Demand: A Case Study", *Supply Chain Management Review*, vol. 6, no. 1, pp. 34-41.
- Aslanertik, B. E. (2005), "Model-supported supply chains for cost-efficient intelligent enterprises", *Journal of Manufacturing Technology Management*, vol. 16, no. 1, pp. 75-86.
- Auramo, J., Kauremaa, J., & Tanskanen, K. (2005), "Benefits of IT in supply chain management: an explorative study of progressive companies", *International Journal of Physical Distribution & Logistics Management*, vol. 35, no. 2, pp. 82-100.
- Ayers, J. B. (2003), "COSTS Getting to the root CAUSES", *Supply Chain Management Review*, vol. 7, no. 6, pp. 24-30.
- Bagchi, P. K., Skjøtt-Larsen, T., & Sørensen, L. B. (2003), "Organizational Integration in Supply Chains", in *Proceedings of NOFOMA 2003*, J. Juga, ed., Oulu, Finland, pp. 11-25.
- Baines, T., Kay, G., Adesola, S., & Higson, M. (2005), "Strategic positioning: an integrated decision process for manufacturers", *International Journal of Operations & Production Management*, vol. 25, no. 2, pp. 180-201.
- Baker, K. R. (1986), "Component Buffer Stocks for Uncertainty in Product Mix.", *International Journal of Operations & Production Management*, vol. 6, no. 5, pp. 63-71.
- Ballester, E. (2002), "Strict uncertainty: A criterion for moderately pessimistic decision makers", *Decision Sciences*, vol. 33, no. 1, pp. 87-107.
- Ballou, D. P. & Pazer, H. L. (1987), "Designing Inspection Strategies for Uncertain Environments", *Decision Sciences*, vol. 18, no. 2, pp. 217-233.

- Bang & Olufsen (2005), *Bang & Olufsen Group - Annual Report 2004/05 (Bang & Olufsen a/s koncernen - Årsrapport 2004/05)*, Bang & Olufsen, Struer, Denmark.
- Bapna, R., Goes, P., Gupta, A., & Karuga, G. (2002), "Optimal design of the online auction channel: Analytical, empirical, and computational insights", *Decision Sciences*, vol. 33, no. 4, pp. 557-577.
- Barker, R. C. (1994), "The Design of Lean Manufacturing Systems using Time-based Analysis", *International Journal of Operations & Production Management*, vol. 14, no. 11, pp. 86-96.
- Bartezzaghi, E. & Verganti, R. (1995b), "Managing demand uncertainty through order overplanning", *International Journal of Production Economics*, vol. 40, no. 2-3, pp. 107-120.
- Bartezzaghi, E. & Verganti, R. (1995a), "A technique for uncertainty reduction based on order commonality", *Production Planning & Control*, vol. 6, no. 2, pp. 157-169.
- Bartezzaghi, E., Verganti, R., & Zotteri, G. (1999), "A simulation framework for forecasting uncertain lumpy demand", *International Journal of Production Economics*, vol. 59, no. 1-3, pp. 499-510.
- Bell, J. (1993), *Doing Your Research Project - A Guide for First-Time Researchers in Education and Social Science*, 2. edn, Open University Press, Buckingham.
- Bensaou, M. & Anderson, E. (1999), "Buyer-Supplier Relations in Industrial Markets: When Do Buyers Risk Making Idiosyncratic Investments?", *Organization Science*, vol. 10, no. 4, pp. 460-481.
- Bernstein, P. L. (1996), "The New Religion of Risk Management", *Harvard Business Review*, vol. 74, no. 2, pp. 47-55.
- Bhattacharya, A. K., Coleman, J. L., & Brace, G. (1995), "Re-positioning the supplier: an SME perspective", *Production Planning & Control*, vol. 6, no. 3, pp. 218-226.
- Bickman, L. & Rog, D. J. (1998), *Handbook of Applied Social Research Methods*, Sage Publications, London.
- Blackburn, J. D., Guide Jr, V. D. R., Souza, G. C., & Van Wassenhove, L. N. (2004), "Reverse Supply Chains for Commercial Returns", *California Management Review*, vol. 46, no. 2, pp. 6-22.
- Blackhurst, J., Wu, T., & O'Grady, P. (2005), "PCDM: a decision support modeling methodology for supply chain, product and process design decisions", *Journal of Operations Management*, vol. 23, no. 3-4, pp. 325-343.
- Blanchini, F., Rinaldi, F., & Ukovich, W. (1996), "A dynamic game model for distribution problems with non-stochastic uncertainty", *International Journal of Production Economics*, vol. 45, no. 1-3, pp. 479-487.
- Boardman, J. T. & Clegg, B. T. (2001), "Structured engagement in the extended enterprise", *International Journal of Operations & Production Management*, vol. 21, no. 5/6, pp. 795-811.
- Boodman, D. M. (1987), "Managing Business Risk", *Interfaces*, vol. 17, no. 2, pp. 91-96.
- Boronico, J. S. & Bland, D. J. (1996), "Customer service: the distribution of seasonal food products under risk", *International Journal of Physical Distribution & Logistics Management*, vol. 26, no. 1, pp. 25-39.
- Bowersox, D. J., Stank, T. P., & Daugherty, P. J. (1999), "Lean Launch: Managing Product Introduction Risk Through Response-Based Logistics", *Journal of Product Innovation Management*, vol. 16, no. 6, pp. 557-568.
- Bowman, E. H. (1982), "Risk Seeking by Troubled Firms", *Sloan Management Review*, vol. 23, no. 4, pp. 33-42.
- Bowman, E. H. (1980), "A Risk/Return Paradox for Strategic Management", *Sloan Management Review*, vol. 21, no. 3, pp. 17-31.
- Boylor, K. K. & Olson, J. R. (2002), "Drivers of internet purchasing success", *Production and Operations Management*, vol. 11, no. 4, pp. 480-499.

- Boyson, S. & Corsi, T. (2001), "The Real-Time Supply Chain", *Supply Chain Management Review*, vol. 5, no. 1, pp. 44-50.
- Braithwaite, S. (1989), "The Need for a Corporate Strategy on Risk Management and Risk Transfer", *European Management Journal*, vol. 7, no. 4, pp. 467-482.
- Brown, K. C. (1981), "Uncertainty and the model builder", *Interfaces*, vol. 11, no. 3, pp. 55-58.
- Brüel & Kjær Sound & Vibration Measurement (2005), *Brüel & Kjaer Sound and Vibration Measurement - Annual Report 2004 (Brüel & Kjaer Sound and Vibration Measurement A/S - Årsrapport 2004)*, Brüel & Kjær Sound & Vibration Measurement, Nærum, Denmark.
- Brunnermeier, S. B. & Martin, S. A. (2002), "Interoperability costs in the US automotive supply chain", *Supply Chain Management: An International Journal*, vol. 7, no. 2, pp. 71-82.
- Bunn, M. D. & Liu, B. S.-C. (1996), "Situational Risk in Organizational Buying: A Basis for Adaptive Selling", *Industrial Marketing Management*, vol. 25, no. 6, pp. 439-452.
- Burt, D. N. (1989), "Managing Suppliers Up to Speed", *Harvard Business Review*, vol. 67, no. 4, pp. 127-134.
- Buxey, G. (2005), "Globalisation and manufacturing strategy in the TCF industry", *International Journal of Operations & Production Management*, vol. 25, no. 2, pp. 100-113.
- Callarman, T. E. & Hamrin, R. S. (1984), "A Comparison of Dynamic Lot Sizing Rules for Use in a Single Stage MRP System with Demand Uncertainty", *International Journal of Operations & Production Management*, vol. 4, no. 2, pp. 39-48.
- Callen, J. L. & Sarath, B. (1995), "Risk aversion, generalized correlation and investment in manufacturing capacities", *Journal of Operations Management*, vol. 12, no. 3, pp. 225-237.
- Caputo, M. (1996), "Uncertainty, flexibility and buffers in the management of the firm operating system", *Production Planning & Control*, vol. 7, no. 5, pp. 518-528.
- Cargille, B. & Bliss, R. (2001), "How Supply Chain Analysis Enhances Product Design", *Supply Chain Management Review*, vol. 5, no. 5, pp. 76-81.
- Carter, C. R. & Ellram, L. M. (2003), "Thirty-five years of The Journal of Supply Chain Management: Where have we been and where are we going?", *Journal of Supply Chain Management*, vol. 39, no. 2, pp. 27-39.
- Carter, C. R. & Hendrick, T. E. (1997), "The development of a time-based construct and its impact on departmental design and structure", *International Journal of Purchasing and Materials Management*, vol. 33, no. 4, pp. 26-34.
- Carter, J. R., Vickery, S. K., & D'Itri, M. P. (1993), "Currency Risk Management Strategies for Contracting with Japanese Suppliers", *International Journal of Purchasing and Materials Management*, vol. 29, no. 3, pp. 19-25.
- Cavinato, J. L. (2004), "Supply chain logistics risks - from the back room to the board room", *International Journal of Physical Distribution & Logistics Management*, vol. 34, no. 5, pp. 383-387.
- Chandra, C. & Kumar, S. (2000), "An application of a system analysis methodology to manage logistics in a textile supply chain", *Supply Chain Management: An International Journal*, vol. 5, no. 5, pp. 234-245.
- Chapman, S. N. (1992), "Using risk-averse inventory for JIT process improvements", *Production and Inventory Management*, vol. 33, no. 4, pp. 69-73.
- Chiang, W. K., Chhajed, D., & Hess, J. D. (2003), "Direct marketing, indirect profits: A strategic analysis of dual-channel supply-chain design", *Management Science*, vol. 49, no. 1, pp. 1-20.
- Childerhouse, P., Lewis, J., Naim, M., & Towill, D. R. (2003), "Re-engineering a construction supply chain: a material flow control approach", *Supply Chain Management: An International Journal*, vol. 8, no. 4, pp. 395-406.

- Chopra, S., Reinhardt, G., & Dada, M. (2004), "The effect of Lead Time Uncertainty on Safety Stocks", *Decision Sciences*, vol. 35, no. 1, pp. 1-24.
- Christiaanse, E. & Kumar, K. (2000), "ICT-enabled coordination of dynamic supply webs", *International Journal of Physical Distribution & Logistics Management*, vol. 30, no. 3, pp. 268-285.
- Christopher, M. (1992), *Logistics - the strategic issues*, Chapman & Hall, London.
- Christopher, M. & Lee, H. L. (2004), "Mitigating supply chain risk through improved confidence", *International Journal of Physical Distribution & Logistics Management*, vol. 34, no. 5, pp. 388-396.
- Christopher, M. & Towill, D. R. (2002), "Developing market specific supply chain strategies", *International Journal of Logistics Management*, vol. 13, no. 1, pp. 1-14.
- Christopher, M. & Towill, D. R. (2001), "An integrated model for the design of the agile supply chains", *International Journal of Physical Distribution & Logistics Management*, vol. 31, no. 4, pp. 235-246.
- Christy, D. P. & Kanet, J. K. (1988), "Open Order Rescheduling in Job Shops with Demand Uncertainty: A Simulation Study", *Decision Sciences*, vol. 19, no. 4, pp. 801-818.
- Clark, F. C. & McGinn, K. (1997), "Developing standards for transportation risk", *Risk Management*, vol. 44, no. 6, pp. 50-54.
- Claycomb, C., Droge, C., & Germain, R. (1999), "The effect of just-in-time with customers on organizational design and performance", *International Journal of Logistics Management*, vol. 10, no. 1, pp. 37-58.
- Clegg, C. & Fitter, M. (1981), "Organizational and Behavioural Consequences of Uncertainty: A Case Study", *Journal of Occupational Behavior*, vol. 2, no. 3, pp. 155-175.
- Clemons, E. K. (1995), "Using Scenario Analysis to Manage the Strategic Risks of Reengineering", *Sloan Management Review*, vol. 36, no. 4, pp. 61-71.
- Collis, D. (1992), "The Strategic Management of Uncertainty", *European Management Journal*, vol. 10, no. 2, pp. 125-135.
- Coloplast (2005a), www.coloplast.com, "Corporate Governance", accessed 2005-10-31.
- Coloplast (2005b), www.coloplast.com, "Managing business risk", accessed 2005-10-30.
- Coloplast (2004), *Coloplast - Annual Report 2003/04*, Coloplast, Humlebæk, Denmark.
- Cooper, D. R. & Schindler, P. S. (2003), *Business Research Methods*, 8. edn, McGraw-Hill, New York.
- Cooper, M. C., Lambert, M. D., & Pagh, J. D. (1997), "Supply Chain Management: More Than a New Name for Logistics", *International Journal of Logistics Management*, vol. 8, no. 1, pp. 1-14.
- Copacino, W. C. & Lapide, L. (1984), "The Impact of Uncertain Transportation Costs on Physical Distribution Planning", *Journal of Business Logistics*, vol. 5, no. 1, pp. 40-56.
- Cousins, P. D., Lamming, R. C., & Bowen, F. (2004), "The role of risk in environment-related supplier initiatives", *International Journal of Operations & Production Management*, vol. 24, no. 6, pp. 554-565.
- Cozzolino, J. M. (1979), "A New Method for Risk Analysis", *Sloan Management Review*, vol. 20, no. 3, pp. 53-66.
- Croom, S. (2005), "The impact of e-business on supply chain management: An empirical study of key developments", *International Journal of Operations & Production Management*, vol. 25, no. 1, pp. 55-73.
- Curkovic, S., Vickery, S. K., & Droge, C. (2000), "Quality-related action programs: Their impact on quality performance and firm performance", *Decision Sciences*, vol. 31, no. 4, pp. 885-905.
- Damodaran, P. & Wilhelm, W. E. (2004), "Branch-and-Price Methods for Prescribing Profitable Upgrades of High-Technology Products with Stochastic Demands", *Decision Sciences*, vol. 35, no. 1, pp. 55-82.
- Darling, J. A. (1996), "A safety net for goods in transit", *Risk Management*, vol. 43, no. 10, pp. 40-43.

- Daskin, M. S. (2004), "Research", *Industrial Engineer*, vol. 36, no. 11, pp. 45-47.
- Davenport, T. H. (1993), *Process Innovation, Reengineering Work through Information Technology*, 1. edn, Harvard Business School Press, Boston, Massachusetts.
- Davidson, L. B. & Cooper, D. O. (1980), "Implementing effective risk analysis at Getty Oil Company", *Interfaces*, vol. 10, no. 6, pp. 62-75.
- Davis, T. (1993), "Effective Supply Chain Management", *Sloan Management Review*, vol. 34, no. 4, pp. 35-46.
- de Vericourt, F., Karaesmen, F., & Dallery, Y. (2002), "Optimal stock allocation for a capacitated supply system", *Management Science*, vol. 48, no. 11, pp. 1486-1496.
- Denzler, D. R., Boe, W. J., & Duplaga, E. (1987), "An Experimental Investigation of FMS Scheduling Rules Under Uncertainty", *Journal of Operations Management*, vol. 7, no. 1-2, pp. 139-151.
- Dershin, H. (2000), "Business Process Design - Completing the DNA", *Supply Chain Management Review*, vol. 4, no. 2, pp. 74-82.
- Dillinger, A. M., Stein, W. E., & Mizzi, P. J. (1992), "Risk Averse Decisions in Business Planning", *Decision Sciences*, vol. 23, no. 4, pp. 1003-1008.
- Dolgui, A. & Ould-Louly, M.-A. (2002), "A model for supply planning under lead time uncertainty", *International Journal of Production Economics*, vol. 78, no. 2, pp. 145-152.
- Drottz-Sjöberg, B.-M. (1991), "Risk: How You See It, React and Communicate", *European Management Journal*, vol. 9, no. 1, pp. 88-97.
- Dumond, E. J. (1996), "Applying value-based management to procurement", *International Journal of Physical Distribution & Logistics Management*, vol. 26, no. 1, pp. 5-24.
- Dyrup (2005), *Dyrup A/S - Annual Report 2004*, Dyrup, Søborg, Denmark.
- Elliman, T. & Orange, G. (2000), "Electronic commerce to support construction design and supply-chain management: a research note", *International Journal of Physical Distribution & Logistics Management*, vol. 30, no. 3, pp. 345-360.
- Erkut, E. & Verter, V. (1995), "A Framework for Hazardous Materials Transport Risk Assessment", *Risk Analysis*, vol. 15, no. 5, pp. 589-601.
- Escudero, L. F., Galindo, E., Garcia, G., Gomez, E., & Sabau, V. (1999), "Schumann, a modeling framework for supply chain management under uncertainty", *European Journal of Operational Research*, vol. 119, no. 1, pp. 14-34.
- Etienne, E. C. (1987), "Choosing Optimal Buffering Strategies for Dealing with Uncertainty in MRP", *Journal of Operations Management*, vol. 7, no. 1-2, pp. 107-120.
- Farris II, M. T., Wittmann, C. M., & Hasty, R. (2005), "Aftermarket support and the supply chain: Exemplars and implications from the aerospace industry", *International Journal of Physical Distribution & Logistics Management*, vol. 35, no. 1, pp. 6-19.
- Fawcett, S. E. & Magnan, G. M. (2002), "The rhetoric and reality of supply chain integration", *International Journal of Physical Distribution & Logistics Management*, vol. 32, no. 5, pp. 339-361.
- Ferdows, K., Lewis, M. A., & Machuca, J. A. D. (2004), "Rapid-Fire Fulfillment", *Harvard Business Review*, vol. 82, no. 11, pp. 104-110.
- Filho, O. S. S. (1999), "An aggregate production planning model with demand under uncertainty", *Production Planning & Control*, vol. 10, no. 8, pp. 745-756.
- Finch, B. J. & Luebbe, R. L. (1991), "Risk associated with learning curve estimates", *Production and Inventory Management*, vol. 32, no. 3, pp. 73-76.
- Finch, P. (2004), "Supply chain risk management", *Supply Chain Management: An International Journal*, vol. 9, no. 2, pp. 183-196.
- Fine, C. H. (2000), "Clockspeed-based Strategies for Supply Chain Design", *Production and Operations Management*, vol. 9, no. 3, pp. 213-221.
- Fine, C. H., Golany, B., & Naseraldin, H. (2005), "Modeling tradeoffs in three-dimensional concurrent engineering: a goal programming approach", *Journal of Operations Management*, vol. 23, no. 3-4, pp. 389-403.

- Fisher, M. L., Hammond, J. H., Obermeyer, W. R., & Raman, A. (1994), "Making Supply Meet Demand in an Uncertain World", *Harvard Business Review*, vol. 72, no. 3, pp. 83-93.
- Fixson, S. K. (2005), "Product architecture assessment: a tool to link product, process, and supply chain design decisions", *Journal of Operations Management*, vol. 23, no. 3-4, pp. 345-369.
- Fleischmann, M., Beullens, P., Bloemhof-Ruwaard, J. M., & Van Wassenhove, L. N. (2001), "The impact of product recovery on logistics network design", *Production and Operations Management*, vol. 10, no. 2, pp. 156-173.
- Fleischmann, M., Van Nunen, J. A. E. E., & Grave, B. (2004), "Integrating Closed-Loop Supply Chains and Spare-Parts Management at IBM", *Interfaces*, vol. 33, no. 6, pp. 44-56.
- Fliedner, G. (2003), "CPFR: an emerging supply chain tool", *Industrial Management & Data Systems*, vol. 103, no. 1, pp. 14-21.
- Forza, C., Salvador, F., & Rungtusanatham, M. (2005), "Coordinating product design, process design, and supply chain design decisions - Part B: Coordinating approaches, tradeoffs, and future research directions", *Journal of Operations Management*, vol. 23, no. 3-4, pp. 319-324.
- Forza, C., Romano, P., & Vinelli, A. (2000), "Information Technology for Managing the Textile Apparel Chain: Current Use, Shortcomings and Development Directions", *International Journal of Logistics: Research and Applications*, vol. 3, no. 3, pp. 227-243.
- Fowler, A. (1998), "Operations management and systemic modelling as frameworks for BPR", *International Journal of Operations & Production Management*, vol. 18, no. 9/10, pp. 1028-1056.
- Fritz Hansen (2004), *Fritz Hansen - Annual Report 2003/2004 (Fritz Hansen A/S - Årsrapport 2003/2004)*, Fritz Hansen, Allerød, Denmark.
- Froot, K. A., Scharfstein, D. S., & Stein, J. C. (1994), "A Framework for Risk Management", *Harvard Business Review*, vol. 72, no. 6, pp. 91-102.
- Fynes, B., Voss, C., & de Burca, S. (2005), "The impact of supply chain relationship dynamics on manufacturing performance", *International Journal of Operations & Production Management*, vol. 25, no. 1, pp. 6-19.
- Gan, X., Sethi, S. P., & Yan, H. (2004), "Coordination of Supply Chains with Risk-Averse Agents", *Production and Operations Management*, vol. 13, no. 2, pp. 135-149.
- Geary, S., Childerhouse, P., & Towill, D. R. (2002), "Uncertainty and the Seamless Supply Chain", *Supply Chain Management Review*, vol. 6, no. 4, pp. 52-61.
- Gelber, D. (1986), "How Currency Swaps Can Help Reduce Risks - Mechanics and Case Studies", *European Management Journal*, vol. 4, no. 3, pp. 211-214.
- Ghauri, P., Grønhaug, K., & Kristianslund, I. (1995), *Research Methods in Business Studies - a practical guide*, 2. edn, Prentice Hall, Harlow, Essex, UK.
- Ghemawat, P. (1993), "The Risk of Not Investing in a Recession", *Sloan Management Review*, vol. 34, no. 2, pp. 51-58.
- Ghosh, D. (1994), "Tolerance for ambiguity, risk preference, and negotiator effectiveness", *Decision Sciences*, vol. 25, no. 2, pp. 263-280.
- Ghosh, D. & Ray, M. R. (1992), "Risk Attitude, Ambiguity Intolerance and Decision Making: An Exploratory Investigation", *Decision Sciences*, vol. 23, no. 2, pp. 431-444.
- Ghosh, D. & Ray, M. R. (1997), "Risk, ambiguity, and decision choice: Some additional evidence", *Decision Sciences*, vol. 28, no. 1, pp. 81-104.
- Giddings, A. P., Bailey, T. G., & Moore, J. T. (2001), "Optimality analysis of facility location problems using response surface methodology", *International Journal of Physical Distribution & Logistics Management*, vol. 31, no. 1, pp. 38-52.
- Gimenez, C. & Ventura, E. (2005), "Logistics-production, logistics-marketing and external integration: Their impact on performance", *International Journal of Operations & Production Management*, vol. 25, no. 1, pp. 20-38.

- Goetschalckx, M., Vidal, C. J., & Dogan, K. (2002), "Modeling and design of global logistics systems: A review of integrated strategic and tactical models and design algorithms", *European Journal of Operational Research*, vol. 143, no. 1, pp. 1-18.
- Gong, L. & Sun, B. (1995), "Efficiency measurement of production operations under uncertainty", *International Journal of Production Economics*, vol. 39, no. 1-2, pp. 55-66.
- Grabowski, M. & Roberts, K. (1999), "Risk Mitigation in Virtual Organizations", *Organization Science*, vol. 10, no. 6, pp. 704-721.
- Grabowski, M. & Roberts, K. (1997), "Risk Mitigation in Large-Scale Systems: Lessons From High Reliability Organizations", *California Management Review*, vol. 39, no. 4, pp. 152-162.
- Graham, G. & Hardaker, G. (2000), "Supply-chain management across the Internet", *International Journal of Physical Distribution & Logistics Management*, vol. 30, no. 3/4, pp. 286-295.
- Graves, S. B. & Ringuet, J. L. (1991), "Producer's and Consumer's Risk When Proportion Defective Is a Random Variable", *Decision Sciences*, vol. 22, no. 4, pp. 753-771.
- Groysberg, B., Nanda, A., & Nohria, N. (2004), "The Risky Business of Hiring Stars", *Harvard Business Review*, vol. 82, no. 5, pp. 92-100.
- Guide Jr, V. D. R. & Srivastava, R. (2000), "A review of techniques for buffering against uncertainty with MRP systems", *Production Planning & Control*, vol. 11, no. 3, pp. 223-233.
- Guide Jr, V. D. R. & Van Wassenhove, L. N. (2002), "The Reverse Supply Chain", *Harvard Business Review*, vol. 80, no. 5, pp. 25-26.
- Güllü, R., Önoğ, E., & Erkip, N. (1999), "Analysis of an inventory system under supply uncertainty", *International Journal of Production Economics*, vol. 59, no. 1-3, pp. 377-385.
- Gupta, D., Gerchak, Y., & Buzacott, J. A. (1992), "The optimal mix of flexible and dedicated manufacturing capacities: Hedging against demand uncertainty", *International Journal of Production Economics*, vol. 28, no. 3, pp. 309-319.
- Hallenbeck Jr., G. S., Hautaluoma, J. E., & Bates, S. C. (1999), "The Benefits of Multiple Boundary Spanning Roles in Purchasing", *Journal of Supply Chain Management*, vol. 35, no. 2, pp. 38-43.
- Hallikas, J., Karvonen, I., Pulkkinen, U., & Virolainen, V.-M. (2004), "Risk management processes in supplier networks", *International Journal of Production Economics*, vol. 90, no. 1, pp. 47-58.
- Hallikas, J., Virolainen, V.-M., & Tuominen, M. (2002), "Risk analysis and assessment in network environments: A dyadic case study", *International Journal of Production Economics*, vol. 78, no. 1, pp. 45-55.
- Hammel, T., Kuettner, D., & Phelps, T. (2002), "The re-engineering of Hewlett-Packard's CD-RW supply chain", *Supply Chain Management: An International Journal*, vol. 7, no. 3, pp. 113-118.
- Hammel, T. R. & Kopczak, L. R. (1993), "Tightening the supply chain", *Production and Inventory Management*, vol. 34, no. 2, pp. 63-70.
- Hamprecht, J., Corsten, D., Noll, M., & Meier, E. (2005), "Controlling the sustainability of food supply chains", *Supply Chain Management: An International Journal*, vol. 10, no. 1, pp. 7-10.
- Han, C. & Damrongwongsiri, M. (2005), "Stochastic modeling of a two-echelon multiple sourcing supply chain system with genetic algorithm", *Journal of Manufacturing Technology Management*, vol. 16, no. 1, pp. 87-108.
- Harland, C. (1996), "Supply Chain Management: Relationships, Chains and Networks", *British Journal of Management*, vol. 7, no. Special Issue, pp. 63-80.
- Harland, C., Brenchley, R., & Walker, H. (2003), "Risk in supply networks", *Journal of Purchasing and Supply Management*, vol. 9, no. 2, pp. 51-62.

- Harrison, T. P. (2001), "Global Supply Chain Design", *Information Systems Frontiers*, vol. 3, no. 4, pp. 413-416.
- Hauser, L. M. (2003), "Risk-adjusted Supply Chain Management", *Supply Chain Management Review*, vol. 7, no. 6, pp. 64-71.
- Havlena, W. J. & DeSarbo, W. S. (1991), "On the Measurement of Perceived Consumer Risk", *Decision Sciences*, vol. 22, no. 4, pp. 927-939.
- Hecht, L. & Morici, P. (1993), "Managing risks in Mexico", *Harvard Business Review*, vol. 71, no. 4, pp. 32-40.
- Hegstad, M. (1990), "A simple, low-risk, approach to JIT", *Production Planning & Control*, vol. 1, no. 1, pp. 53-60.
- Henthorne, T. L., LaTour, M. S., & Williams, A. J. (1993), "How Organizational Buyers Reduce Risk", *Industrial Marketing Management*, vol. 22, no. 1, pp. 41-48.
- Herer, Y. T., Tzur, M., & Yücesan, E. (2002), "Transshipments: An emerging inventory recourse to achieve supply chain leagility", *International Journal of Production Economics*, vol. 80, no. 3, pp. 201-212.
- Herman, J. (2002), "Global Value Webs", *Supply Chain Management Review*, vol. 6, no. 4, pp. 30-37.
- Hertz, D. B. & Thomas, H. (1983), "Decision and Risk Analysis in a New Product and Facilities Planning Problem", *Sloan Management Review*, vol. 24, no. 2, pp. 17-31.
- Hewitt, F. (1994), "Supply Chain Redesign", *International Journal of Logistics Management*, vol. 5, no. 2, pp. 1-9.
- Hildebrandt, H. (2002), "Corporate Governance i praksis? Marsh kan hjælpe", *Risiko orientering* no. 1, p. 2.
- Hill, A. V. & Vollmann, T. E. (1986), "Reducing Vendor Delivery Uncertainties in a JIT Environment", *Journal of Operations Management*, vol. 6, no. 4, pp. 381-392.
- Ho, C. & Carter, P. L. (1994), "Adopting Rescheduling Capability in DRP to Deal with Operational Uncertainty in Logistics Systems", *International Journal of Logistics Management*, vol. 5, no. 1, pp. 33-42.
- Hoffman, G. M. (1982), "Project cost control: Dynamic risk analysis of randomly ordered sequential decisions under uncertainty", *Interfaces*, vol. 12, no. 3, pp. 45-51.
- Hoole, R. (2005), "Five ways to simplify your supply chain", *Supply Chain Management: An International Journal*, vol. 10, no. 1, pp. 3-6.
- Huan, S. H., Sheoran, S. K., & Wang, G. (2004), "A review and analysis of supply chain operations reference (SCOR) model", *Supply Chain Management: An International Journal*, vol. 9, no. 1, pp. 23-29.
- Hubert, P. & Pages, P. (1989), "Risk Management for Hazardous Materials Transportation: A Local Study in Lyons", *Risk Analysis*, vol. 9, no. 4, pp. 445-451.
- Hunter, L. M., Kasouf, C. J., Celuch, K. G., & Curry, K. A. (2004), "A classification of business-to-business buying decisions: Risk importance and probability as a framework for e-business benefits", *Industrial Marketing Management*, vol. 33, no. 2, pp. 145-154.
- James, M., Grosvenor, R., & Prickett, P. (2004), "e-Distribution: Internet-based management of a merchandiser supply chain", *Supply Chain Management: An International Journal*, vol. 9, no. 1, pp. 7-15.
- Jang, J. & Liu, R. R. (1993), "Estimating the reduction in labor hours due to a new technology under uncertain demand", *International Journal of Production Economics*, vol. 29, no. 2, pp. 221-222.
- Jayaram, J., Vickery, S. K., & Droge, C. (2000), "The effects of information system infrastructure and process improvements on supply-chain time performance", *International Journal of Physical Distribution & Logistics Management*, vol. 30, no. 3/4, pp. 314-330.
- Jayaram, V. (1998), "An efficient heuristic procedure for practical-sized capacitated warehouse design and management", *Decision Sciences*, vol. 29, no. 3, pp. 729-745.

- Jeunet, J. & Jonard, N. (2000), "Measuring the performance of lot-sizing techniques in uncertain environments", *International Journal of Production Economics*, vol. 64, no. 1-3, pp. 197-208.
- Johansen, S. G. (1999), "Lot sizing for varying degrees of demand uncertainty", *International Journal of Production Economics*, vol. 59, no. 1-3, pp. 405-414.
- Johnson, M. E. (2001), "Learning From Toys: Lessons In Managing Supply Chain Risk From The Toy Industry", *California Management Review*, vol. 43, no. 3, pp. 106-124.
- Johnson, M. E. (1998), "Giving 'em what they want", *Management Review*, vol. 87, no. 10, pp. 62-67.
- Jörnsten, K. & Leisten, R. (1994), "Scenario aggregation in single-resource production planning models with uncertain demand", *Production Planning & Control*, vol. 5, no. 3, pp. 271-281.
- Kadipasaoglu, S. N. & Sridharan, V. (1995), "Alternative approaches for reducing schedule instability in multistage manufacturing under demand uncertainty", *Journal of Operations Management*, vol. 13, no. 3, pp. 193-211.
- Kanyamibwa, F. & Ord, J. K. (2000), "Economic process control under uncertainty", *Production and Operations Management*, vol. 9, no. 2, pp. 184-202.
- Kelle, P. & Miller, P. A. (2001), "Stockout risk and order splitting", *International Journal of Production Economics*, vol. 71, no. 1-3, pp. 407-415.
- Klevås, J. (2005), "Organization of packaging resources at a product-developing company", *International Journal of Physical Distribution & Logistics Management*, vol. 35, no. 2, pp. 116-131.
- Koh, S. C. L. & Saad, S. M. (2003), "A holistic approach to diagnose uncertainty in ERP-controlled manufacturing shop floor", *Production Planning & Control*, vol. 14, no. 3, pp. 273-289.
- Kopczak, L. R. (2001), "Designing Supply Chains for the 'Click-and-Mortar' Economy", *Supply Chain Management Review*, vol. 5, no. 1, pp. 60-66.
- Kopczak, L. R. & Johnson, M. E. (2003), "The Supply-Chain Management Effect", *Sloan Management Review*, vol. 44, no. 3, pp. 27-34.
- Korhonen, P., Huttunen, K., & Eloranta, E. (1998), "Demand chain management in a global enterprise-information management view", *Production Planning & Control*, vol. 9, no. 6, pp. 526-531.
- Korpela, J., Kyläheiko, K., Lehmusvaara, A., & Tuominen, M. (2002), "An analytical approach to production capacity allocation and supply chain design", *International Journal of Production Economics*, vol. 78, no. 2, pp. 187-195.
- Korpela, J., Lehmusvaara, A., & Tuominen, M. (2001b), "Customer service based design of the supply chain", *International Journal of Production Economics*, vol. 69, no. 2, pp. 193-204.
- Korpela, J., Lehmusvaara, A., & Tuominen, M. (2001a), "An analytic approach to supply chain development", *International Journal of Production Economics*, vol. 71, no. 1-3, pp. 145-155.
- Kotzab, H., Skjoldager, N., & Vinum, T. (2003), "The development and empirical validation of an e-based supply chain strategy optimization model", *Industrial Management & Data Systems*, vol. 103, no. 5, pp. 347-360.
- Koutsoukis, N.-S., Dominguez-Ballesteros, B., Lucas, C. A., & Mitra, G. (2000), "A prototype decision support system for strategic planning under uncertainty", *International Journal of Physical Distribution & Logistics Management*, vol. 30, no. 7/8, pp. 640-660.
- Kouvelis, P. & Milner, J. M. (2002), "Supply chain capacity and outsourcing decisions: the dynamic interplay of demand and supply uncertainty", *IIE Transactions*, vol. 34, no. 8, pp. 717-728.
- Kreipl, S. & Pinedo, M. (2004), "Planning and Scheduling in Supply Chains: An Overview of Issues in Practice", *Production and Operations Management*, vol. 13, no. 1, pp. 77-92.

- Krikke, H., le Blanc, I., & van de Velde, S. (2004), "Product Modularity and the Design of Closed-Loop Supply Chains", *California Management Review*, vol. 46, no. 2, pp. 23-39.
- Krueger, N. J. & Dickson, P. R. (1994), "How believing in ourselves increases risk taking: Perceived Self-Efficacy and Opportunity Recognition", *Decision Sciences*, vol. 25, no. 3, pp. 385-400.
- Kumar, D. (2004), "Beyond the low-hanging fruit", *Industrial Engineer*, vol. 36, no. 5, pp. 44-48.
- Kwon, I.-W. G. & Suh, T. (2005), "Trust, commitment and relationships in supply chain management: a path analysis", *Supply Chain Management: An International Journal*, vol. 10, no. 1, pp. 26-33.
- Lambert, D. M., Cooper, M. C., & Pagh, J. D. (1998), "Supply Chain Management: Implementation Issues and Research Opportunities", *International Journal of Logistics Management*, vol. 9, no. 2, pp. 1-19.
- Lancioni, R. A. (2000), "New Developments in Supply Chain Management for the Millennium", *Industrial Marketing Management*, vol. 29, no. 1, pp. 1-6.
- Larson, P. D. & Gammelgaard, B. (2001), "Logistics in Denmark: A Survey of the Industry", *International Journal of Logistics: Research and Applications*, vol. 4, no. 2, pp. 191-206.
- Lau, A. H.-L., Lau, H.-S., & Willett, K. D. (2000), "Demand uncertainty and returns policies for a seasonal product: An alternative model", *International Journal of Production Economics*, vol. 66, no. 1, pp. 1-12.
- Lau, H. C. W. & Lee, W. B. (2000), "On a responsive supply chain information system", *International Journal of Physical Distribution & Logistics Management*, vol. 30, no. 7/8, pp. 598-610.
- Lau, H.-S. (1989), "Toward An Inventory Control System Under Non-Normal Demand And Lead-Time Uncertainty", *Journal of Business Logistics*, vol. 10, no. 1, pp. 88-103.
- Lee, D. Y. (1997), "The impact of poor performance on risk-taking attitudes: A longitudinal study with a PLS causal modeling approach", *Decision Sciences*, vol. 28, no. 1, pp. 59-80.
- Lee, H. L. (2002), "Aligning Supply Chain Strategies with Product Uncertainties", *California Management Review*, vol. 44, no. 3, pp. 105-119.
- Lee, H. L. & Billington, C. (1992), "Managing Supply Chain Inventory: Pitfalls and Opportunities", *Sloan Management Review*, vol. 33, no. 3, pp. 65-73.
- Lee, H. L., Billington, C., & Carter, B. (1993), "Hewlett-Packard Gains Control of Inventory and Service through Design for Localization", *Interfaces*, vol. 23, no. 4, pp. 1-11.
- Lee, H. L., Padmanabhan, V., & Whang, S. (1997), "The Bullwhip Effect in Supply Chains", *Sloan Management Review*, vol. 38, no. 3, pp. 93-102.
- Lee, H. L. & Sasser, M. M. (1995), "Product universality and design for supply chain management", *Production Planning & Control*, vol. 6, no. 3, pp. 270-277.
- Lee, H. L. & Wolfe, M. (2003), "Supply Chain Security Without Tears", *Supply Chain Management Review*, vol. 7, no. 1, pp. 12-20.
- Lefley, F. (1997), "Approaches to risk and uncertainty in the appraisal of new technology capital projects", *International Journal of Production Economics*, vol. 53, no. 1, pp. 21-33.
- Lehtonen, J.-M., Småros, J., & Holmström, J. (2005), "The effect of demand visibility in product introductions", *International Journal of Physical Distribution & Logistics Management*, vol. 35, no. 2, pp. 101-115.
- Lewis, M. A. (2003), "Cause, consequence and control: towards a theoretical and practical model of operational risk", *Journal of Operations Management*, vol. 21, no. 2, pp. 205-224.
- Li, G., Yan, H., Wang, S., & Xia, Y. (2005), "Comparative analysis on value of information sharing in supply chains", *Supply Chain Management: An International Journal*, vol. 10, no. 1, pp. 34-46.
- Lin, N.-P. & Krajewski, L. (1992), "A Model for Master Production Scheduling in Uncertain Environments", *Decision Sciences*, vol. 23, no. 4, pp. 839-861.

- LINAK (2004), *LINAK - Annual Report 2003/2004 (LINAK - Årsrapport 2003/2004)*, LINAK, Nordborg, Denmark.
- Link, P. & Marxt, C. (2004), "Integration of risk- and chance management in the co-operation process", *International Journal of Production Economics*, vol. 90, no. 1, pp. 71-78.
- Lockamy III, A. & McCormack, K. (2004), "The development of a supply chain management process maturity model using the concepts of business process orientation", *Supply Chain Management: An International Journal*, vol. 9, no. 4, pp. 272-278.
- Lonsdale, C. (1999), "Effectively managing vertical supply relationships: a risk management model for outsourcing", *Supply Chain Management: An International Journal*, vol. 4, no. 4, pp. 176-183.
- Love, P. E. D., Irani, Z., & Edwards, D. J. (2004), "A seamless supply chain management model for construction", *Supply Chain Management: An International Journal*, vol. 9, no. 1, pp. 43-56.
- Mabert, V. A. & Venkataramanan, M. A. (1998), "Special research focus on supply chain linkages: Challenges for design and management in the 21st century", *Decision Sciences*, vol. 29, no. 3, pp. 537-552.
- Macbeth, D. K. & Ferguson, N. (1991), "Strategic Aspects of Supply Chain Management", *Integrated Manufacturing Systems*, vol. 2, no. 1, pp. 8-12.
- Manzini, R., Ferrari, E., Gamberi, M., Persona, A., & Regattieri, A. (2005), "Simulation performance in the optimisation of the supply chain", *Journal of Manufacturing Technology Management*, vol. 16, no. 2, pp. 127-144.
- Marsh, T. A. & Swanson, D. S. (1984), "Risk-Return Tradeoffs for Strategic Management", *Sloan Management Review*, vol. 25, no. 3, pp. 35-51.
- Marshall, R. M. & Narasimhan, R. (1989), "Risk-Constrained Information Choice", *Decision Sciences*, vol. 20, no. 4, pp. 677-684.
- Martha, J. & Subbarkrishna, S. (2002), "Targeting a Just-In-Case Supply Chain for the Inevitable Next Disaster", *Supply Chain Management Review*, vol. 6, no. 5, pp. 18-23.
- Mason, S. J., Cole, M. H., Ulrey, B. T., & Yan, L. (2002), "Improving electronics manufacturing supply chain agility through outsourcing", *International Journal of Physical Distribution & Logistics Management*, vol. 32, no. 7, pp. 610-620.
- Matsuura, H., Tsubone, H., & Kataoka, K. (1995), "Comparison between simple infinite loading and loading considering a workload status under uncertainty in job operation times", *International Journal of Production Economics*, vol. 40, no. 1, pp. 45-55.
- McGaughey, R. E. & Gunasekaran, A. (1999), "The Y2K problem: manufacturing inputs at risk", *Production Planning & Control*, vol. 10, no. 8, pp. 796-808.
- McGovern, T., Hicks, C., & Earl, C. F. (1999), "Modelling Supply Chain Management Processes in Engineer-to-Order Companies", *International Journal of Logistics: Research and Applications*, vol. 2, no. 2, pp. 147-159.
- McHugh, L. & Wilson, A. (1987), "High Risk Strategies for Small Firms - Goldmine or Landmine?", *European Management Journal*, vol. 5, no. 1, pp. 13-23.
- McIvor, R. (2003), "Outsourcing: insights from the telecommunications industry", *Supply Chain Management: An International Journal*, vol. 8, no. 4, pp. 380-394.
- McIvor, R. (2000), "A practical framework for understanding the outsourcing process", *Supply Chain Management: An International Journal*, vol. 5, no. 1, pp. 22-36.
- Meldrum, M. J. & Millman, A. F. (1991), "Ten Risks in Marketing High-Technology Products", *Industrial Marketing Management*, vol. 20, no. 1, pp. 43-50.
- Menachof, D. (1996), "Risk Management Methods for the Liner Shipping Industry: The Response to Customer Service Demands for Simplified Tariffs", *Journal of Business Logistics*, vol. 17, no. 1, pp. 259-290.
- Mentzer, J. T., Dewitt, W., Keebler, J. S., Min, S., Nix, N. W., Smith, C. D., & Zacharia, Z. G. (2001), "Defining Supply Chain Management", *Journal of Business Logistics*, vol. 22, no. 2, pp. 1-25.

- Merrick, J. R. W., van Dorp, J. R., Mazzuchi, T., Harrald, J. R., Spahn, J. E., & Grabowski, M. (2002), "The Prince William Sound Risk Assessment", *Interfaces*, vol. 32, no. 6, pp. 25-40.
- Meshkat, H. & Ballou, R. H. (1996), "Warehouse Location with Uncertain Stock Availability", *Journal of Business Logistics*, vol. 17, no. 2, pp. 197-216.
- Meslin, T. B. (1981), "Assessment and Management of Risk in the Transport of Dangerous Materials: The Case of Chlorine Transport in France", *Risk Analysis*, vol. 1, no. 2, pp. 137-142.
- Mohebbi, E. (2004), "A replenishment model for the supply-uncertainty problem", *International Journal of Production Economics*, vol. 87, no. 1, pp. 25-37.
- Mollenkopf, D. & Dapiran, G. P. (2005), "World-class logistics: Australia and New Zealand", *International Journal of Physical Distribution & Logistics Management*, vol. 35, no. 1, pp. 63-74.
- Monahan, S., Laudicina, P., and Attis, D. (2003), "Supply Chains In a Vulnerable, Volatile World", *Executive Agenda (AT Kearney)*, vol. VI, no. 3, pp. 5-16.
- Mourits, M. & Evers, J. J. M. (1995), "Distribution network design", *International Journal of Physical Distribution & Logistics Management*, vol. 25, no. 5, pp. 43-57.
- Muntslag, D. R. (1994), "Profit and risk evaluation in customer driven engineering and manufacturing", *International Journal of Production Economics*, vol. 36, no. 1, pp. 97-107.
- Murthy, D. N. P. & Ma, L. (1991), "MRP with uncertainty: a review and some extensions", *International Journal of Production Economics*, vol. 25, no. 1-3, pp. 51-64.
- Newman, W. R., Hanna, M., & Maffei, M. J. (1993), "Dealing with the Uncertainties of Manufacturing: Flexibility, Buffers and Integration", *International Journal of Operations & Production Management*, vol. 13, no. 1, pp. 19-34.
- Niebling, K. & Shubik, M. (1982), "Business and International Political Risk", *European Management Journal*, vol. 1, no. 1, pp. 12-27.
- Nollet, J. & Beaulieu, M. (2005), "Should an organisation join a purchasing group?", *Supply Chain Management: An International Journal*, vol. 10, no. 1, pp. 11-17.
- Noori, A. H. & Keller, G. (1986), "The Lot-Size Reorder-Point Model with Upstream-Downstream Uncertainty", *Decision Sciences*, vol. 17, no. 3, pp. 285-291.
- Nooteboom, B., Berger, H., & Noorderhaven, N. G. (1997), "Effects of Trust and Governance on Relational Risk", *The Academy of Management Journal*, vol. 40, no. 2, pp. 308-338.
- Nørby Johansen, L., Lindegaard, J., Schmidt, W., & Øvlisen, M. (2001), *The Nørby committee report on Corporate Governance in Denmark (Nørby-udvalgets rapport om Corporate Governance i Danmark)*, Erhvervs- og Selskabsstyrelsen.
- Norrman, A. & Jansson, U. (2004), "Ericsson's proactive supply chain risk management approach after a serious sub-supplier accident", *International Journal of Physical Distribution & Logistics Management*, vol. 34, no. 5, pp. 434-456.
- Novozymes (2005), *Novozymes - Annual Report 2004 (Novozymes - Årsrapport 2004)*, Novozymes, Bagsværd, Denmark.
- Noy, E. & Ellis, S. (2003), "Corporate Risk Strategy: Does it Vary Across Business Activities?", *European Management Journal*, vol. 21, no. 1, pp. 119-128.
- Nynke Faber, R., de Koster, B. M., & van de Velde, S. (2002), "Linking warehouse complexity to warehouse planning and control structure: An exploratory study of the use of warehouse management information systems", *International Journal of Physical Distribution & Logistics Management*, vol. 32, no. 5, pp. 381-395.
- Olhager, J. (2002), "Supply chain management: a just-in-time perspective", *Production Planning & Control*, vol. 13, no. 8, pp. 681-687.
- Olhager, J. & Selldin, E. (2004), "Supply chain management survey of Swedish manufacturing firms", *International Journal of Production Economics*, vol. 89, no. 3, pp. 353-361.

- Onwubolu, G. C., Haupt, W., De Clercq, G., & Visser, J. (1999), "Production management issues in developing nations", *Production Planning & Control*, vol. 10, no. 2, pp. 110-117.
- Ottesen, G. G. & Gronhaug, K. (2002), "Market orientation and uncertain supply in upstream markets: an exploratory study", *European Journal of Purchasing & Supply Management*, vol. 8, no. 4, pp. 209-219.
- Pagell, M. & Krause, D. R. (1999), "A multiple-method study of environmental uncertainty and manufacturing flexibility", *Journal of Operations Management*, vol. 17, no. 3, pp. 307-325.
- Pagell, M., Newman, W. R., Hanna, M., & Krause, D. R. (2000), "Uncertainty, flexibility, and buffers: three case studies", *Production and Inventory Management*, vol. 41, no. 1, pp. 35-43.
- Parker, G. G. & Anderson Jr, E. G. (2002), "From buyer to integrator: the transformation of the supply-chain manager in the vertically disintegrating firm", *Production and Operations Management*, vol. 11, no. 1, pp. 75-91.
- Paté-Cornell, M.-E. & Fischbeck, P. S. (1994), "Risk Management for the Tiles of the Space Shuttle", *Interfaces*, vol. 24, no. 1, pp. 64-86.
- Payne, T. & Peters, M. J. (2004), "What is the Right Supply Chain For Your Products?", *International Journal of Logistics Management*, vol. 15, no. 2, pp. 77-92.
- Persson, F. & Olhager, J. (2002), "Performance simulation of supply chain designs", *International Journal of Production Economics*, vol. 77, no. 3, pp. 231-245.
- Petersen, K. J., Handfield, R. B., & Ragatz, G. L. (2005), "Supplier integration into new product development: coordinating product, process and supply chain design", *Journal of Operations Management*, vol. 23, no. 3-4, pp. 371-388.
- Petrovic, D. (2001), "Simulation of supply chain behaviour and performance in an uncertain environment", *International Journal of Production Economics*, vol. 71, no. 1-3, pp. 429-438.
- Petrovic, R. & Petrovic, D. (2001), "Multicriteria ranking of inventory replenishment policies in the presence of uncertainty in customer demand", *International Journal of Production Economics*, vol. 71, no. 1-3, pp. 439-446.
- Pilling, B. K. & Zhang, L. (1992), "Cooperative Exchange: Rewards and Risks", *International Journal of Purchasing and Materials Management*, vol. 28, no. 2, pp. 2-9.
- Polk, R., Plank, R. E., & Reid, D. A. (1996), "Technical Risk and New Product Success: An Empirical Test in High Technology Business Markets", *Industrial Marketing Management*, vol. 25, no. 6, pp. 531-543.
- Preiss, K. J. & Murray, P. A. (2005), "Fashions of learning: improving supply-chain relationships", *Supply Chain Management: An International Journal*, vol. 10, no. 1, pp. 18-25.
- PriceWaterhouseCoopers (2004), *COSO Enterprise Risk Management - Integrated Framework*, AICPA.
- PriceWaterhouseCoopers (2005), *Enterprise Risk Management*, PricewaterhouseCoopers, Denmark.
- Quelch, J. A., Neslin, S. A., & Olson, L. B. (1987), "Opportunities and Risks of Durable Goods Promotion", *Sloan Management Review*, vol. 28, no. 2, pp. 27-38.
- Ramdas, K. (2003), "Managing product variety: an integrative review and research directions", *Production and Operations Management*, vol. 12, no. 1, pp. 79-101.
- Reiner, G. & Trcka, M. (2004), "Customized supply chain design: Problems and alternatives for a production company in the food industry - a simulation based analysis", *International Journal of Production Economics*, vol. 89, no. 2, pp. 217-229.
- Reutterer, T. & Kotzab, H. W. (2000), "The Use of Conjoint-Analysis for Measuring Preferences in Supply Chain Design", *Industrial Marketing Management*, vol. 29, no. 1, pp. 27-35.
- Rice, J. B. & Caniato, F. (2003), "Building a Secure and Resilient Supply Network", *Supply Chain Management Review*, vol. 7, no. 5, pp. 22-29.

- RIEGENS (2005), *RIEGENS - Annual Report 2004 (RIEGENS A/S - Årsrapport 2004)*, RIEGENS, Næsby, Denmark.
- Ritchie, B. & Brindley, C. (2000), "Disintermediation, disintegration and risk in the SME global supply chain", *Management Decision*, vol. 38, no. 8, pp. 575-583.
- Roberts, P. (2001), "Corporate competence in FM: current problems and issues", *Facilities*, vol. 19, no. 7, pp. 269-275.
- Robinson Jr, E. P. & Satterfield, R. K. (1998), "Designing distribution systems to support vendor strategies in supply chain management", *Decision Sciences*, vol. 29, no. 3, pp. 685-706.
- Routroy, S. & Kodali, R. (2005), "Differential evolution algorithm for supply chain inventory planning", *Journal of Manufacturing Technology Management*, vol. 16, no. 1, pp. 7-17.
- Rungtusanatham, M. & Forza, C. (2005), "Coordinating product design, process design, and supply chain design decisions - Part A: Topic motivation, performance implications, and article review process", *Journal of Operations Management*, vol. 23, no. 3-4, pp. 257-265.
- Sabri, E. H. & Beamon, B. M. (2000), "A multi-objective approach to simultaneous strategic and operational planning in supply chain design", *Omega*, vol. 28, no. 5, pp. 581-598.
- Saccomanno, F. & Haastrup, P. (2002), "Influence of Safety Measures on the Risks of Transporting Dangerous Goods Through Road Tunnels", *Risk Analysis*, vol. 22, no. 6, pp. 1059-1069.
- Sadeh, N. M., Hildum, D. W., Kjenstad, D., & Tseng, A. (2001), "MASCOT: an agent-based architecture for dynamic supply chain creation and coordination in the internet economy", *Production Planning & Control*, vol. 12, no. 3, pp. 212-223.
- Sahay, B. S. (2003), "Understanding trust in supply chain relationships", *Industrial Management & Data Systems*, vol. 103, no. 8, pp. 553-563.
- Samaranayake, P. (2005), "A conceptual framework for supply chain management: a structural integration", *Supply Chain Management: An International Journal*, vol. 10, no. 1, pp. 47-59.
- Sarkis, J. & Sundarraj, R. P. (2000), "Factors for strategic evaluation of enterprise information technologies", *International Journal of Physical Distribution & Logistics Management*, vol. 30, no. 3/4, pp. 196-220.
- Savage, M. (2002), "Business continuity planning", *Work Study*, vol. 51, no. 4/5, pp. 254-261.
- Schill, R. L. (1985), "Managing Risk in Contract Pricing with Multiple Incentives", *Industrial Marketing Management*, vol. 14, no. 1, pp. 1-16.
- Schmitt, T. G. (1984), "Resolving Uncertainty in Manufacturing Systems", *Journal of Operations Management*, vol. 4, no. 4, pp. 331-345.
- Schwarz, L. B. & Weng, Z. K. (2000), "The Design of a JIT Supply Chain: The Effect of Leadtime Uncertainty on Safety Stock", *Journal of Business Logistics*, vol. 21, no. 2, pp. 231-253.
- SDC DanDisc (2005), *SDC DANDISC - Annual Report 2004 (SDC DANDISC - Årsrapport 2004)*, SDC DanDisc, Frederiksberg, Denmark.
- Sells, B. (1994), "What Asbestos Taught Me About Managing Risk", *Harvard Business Review*, vol. 72, no. 2, pp. 76-89.
- Shankar, V. (2001), "Integrating Demand and Supply Chain Management", *Supply Chain Management Review*, vol. 5, no. 5, pp. 76-81.
- Sharratt, P. N. & Choong, P. M. (2002), "A life-cycle framework to analyse business risk in process industry projects", *Journal of Cleaner Production*, vol. 10, no. 5, pp. 479-493.
- Sheffi, Y. (2001), "Supply Chain Management under the Threat of International Terrorism", *International Journal of Logistics Management*, vol. 12, no. 2, pp. 1-11.
- Shore, B. & Venkatachalam, A. R. (2003), "Evaluating the information sharign capabilities of supply chain partners - a fuzzy logic model", *International Journal of Physical Distribution & Logistics Management*, vol. 33, no. 9, pp. 804-824.

- Simatupang, T. M., Sandroto, I. V., & Lubis, S. B. H. (2004), "A coordination analysis of the creative design process", *Business Process Management Journal*, vol. 10, no. 4, pp. 430-444.
- Simatupang, T. M. & Sridharan, R. (2005), "The collaboration index: a measure for supply chain collaboration", *International Journal of Physical Distribution & Logistics Management*, vol. 35, no. 1, pp. 44-62.
- Simchi-Levi, D., Snyder, L., & Watson, M. (2002), "Strategies for Uncertain Times", *Supply Chain Management Review*, vol. 6, no. 1, pp. 11-12.
- Simons, R. (1999), "How Risky is Your Company?", *Harvard Business Review*, vol. 77, no. 3, pp. 85-94.
- Sinha, P. R., Whitman, L. E., & Malzahn, D. (2004), "Methodology to mitigate supplier risk in an aerospace supply chain", *Supply Chain Management Review*, vol. 9, no. 2, pp. 154-168.
- Smeltzer, L. R. & Siferd, S. P. (1998), "Proactive Supply Management: The Management of Risk", *International Journal of Purchasing and Materials Management*, vol. 34, no. 1, pp. 38-45.
- Sodhi, M. S. (2001), "Applications and Opportunities for Operations Research in Internet-Enabled Supply Chains and Electronic Marketplaces", *Interfaces*, vol. 31, no. 2, pp. 56-69.
- Sodhi, M. S. (2003), "How To Do Strategic Supply-Chain Planning", *Sloan Management Review*, vol. 45, no. 1, pp. 69-75.
- Speh, T. W. & Wagenheim, G. D. (1978), "Demand and Lead-Time Uncertainty: The Impacts on Physical Distribution Performance and Management", *Journal of Business Logistics*, vol. 1, no. 1, pp. 95-113.
- Spekman, R. E. & Davis, E. W. (2004), "Risky business: expanding the discussion on risk and the extended enterprise", *International Journal of Physical Distribution & Logistics Management*, vol. 34, no. 5, pp. 414-433.
- Sridharan, V. & Berry, W. L. (1990), "Freezing The Master Production Schedule Under Demand Uncertainty", *Decision Sciences*, vol. 21, no. 1, pp. 97-120.
- Stambaugh, F. (1996), "Risk and Value at Risk", *European Management Journal*, vol. 14, no. 6, pp. 612-621.
- Stevens, G. C. (1989), "Integrating the Supply Chain", *International Journal of Physical Distribution and Materials Management*, vol. 19, no. 8, pp. 3-8.
- Stock, J., Speh, T., & Shear, H. (2002), "Many Happy (Product) Returns", *Harvard Business Review*, vol. 80, no. 7, pp. 16-17.
- Sundararaj, G., Aravindan, P., Devadasan, S. R., & Muthu, S. (2000), "Risk prevention and management in blast furnace operation through mock drill exercise", *Production Planning & Control*, vol. 11, no. 2, pp. 197-206.
- Svensson, G. (2000), "A conceptual framework for the analysis of vulnerability in supply chains", *International Journal of Physical Distribution & Logistics Management*, vol. 30, no. 9, pp. 731-749.
- Svensson, G. (2001), "Firms' Preventive Activities and the Occurrence of Disturbances in the Inbound and Outbound Logistics Flows", *International Journal of Logistics: Research and Applications*, vol. 4, no. 2, pp. 207-236.
- Svensson, G. (2002a), "A conceptual framework of vulnerability in firms' inbound and outbound logistics flows", *International Journal of Physical Distribution & Logistics Management*, vol. 32, no. 2, pp. 110-134.
- Svensson, G. (2002b), "A typology of vulnerability scenarios towards suppliers and customers in supply chains based upon perceived time and relationship dependencies", *International Journal of Physical Distribution & Logistics Management*, vol. 32, no. 3, pp. 168-187.
- Svensson, G. (2002c), "Dyadic Vulnerability in Companies' Inbound and Outbound Logistics Flows", *International Journal of Logistics: Research and Applications*, vol. 5, no. 1, pp. 13-43.

- Svensson, G. (2002d), "Vulnerability scenarios in marketing channels", *Supply Chain Management: An International Journal*, vol. 7, no. 5, pp. 322-333.
- Swaminathan, J. M., Smith, S. F., & Sadeh, N. M. (1998), "Modeling supply chain dynamics: A multiagent approach", *Decision Sciences*, vol. 29, no. 3, pp. 607-632.
- Swoveland, C. (1987), "Risk Analysis of Regulatory Options for the Transport of Dangerous Commodities by Rail", *Interfaces*, vol. 17, no. 4, pp. 90-107.
- Talluri, S., Cetin, K., & Gardner, A. J. (2004), "Integrating demand and supply variability into safety stock evaluations", *International Journal of Physical Distribution & Logistics Management*, vol. 34, no. 1, pp. 62-69.
- Talluri, S. & Ragatz, G. L. (2004), "Multi-Attribute Reverse Auctions in B2B Exchanges: A Framework for Design and Implementation", *Journal of Supply Chain Management*, vol. 40, no. 1, pp. 52-60.
- Tang, O. & Grubbström, R. W. (2002), "Planning and replanning the master production schedule under demand uncertainty", *International Journal of Production Economics*, vol. 78, no. 3, pp. 323-334.
- Tatsiopoulou, I. P., Ponis, S. T., Hadziliadis, E. A., & Panayiotou, N. A. (2001), "Realization of the virtual enterprise paradigm in the clothing industry through e-business technology", *Production and Operations Management*, vol. 11, no. 4, pp. 516-530.
- Taylor, G. D. & Whicker, G. L. (2002), "Optimization and heuristic models supporting distributed manufacturing", *Production Planning & Control*, vol. 13, no. 6, pp. 517-528.
- Templin, C. R. & Noffsinger, K. R. (1994), "An Assessment of the Role of Technical and Risk Evaluation Factors in Defense Source Selection Decisions", *International Journal of Purchasing and Materials Management*, vol. 30, no. 4, pp. 37-43.
- Towill, D. R. & Del Vecchio, A. (1994), "The application of filter theory to the study of supply chain dynamics", *Production Planning & Control*, vol. 5, no. 1, pp. 82-96.
- Towill, D. & Christopher, M. (2002), "The Supply Chain Strategy Conundrum: To Be Lean Or Agile or To be Lean And Agile?", *International Journal of Logistics: Research and Applications*, vol. 5, no. 3, pp. 299-309.
- Towill, D. R. (1996), "Time compression and supply chain management - a guided tour", *Supply Chain Management: An International Journal*, vol. 1, no. 1, pp. 15-27.
- Towill, D. R. (1997), "FORRIDGE - Principles of good practice in material flow", *Production Planning & Control*, vol. 8, no. 7, pp. 622-632.
- Towill, D. R., Childerhouse, P., & Disney, S. M. (2002), "Integrating the automotive supply chain: where are we now?", *International Journal of Physical Distribution & Logistics Management*, vol. 32, no. 2, pp. 79-95.
- Towill, D. R., Naim, M. M., & Wikner, J. (1992), "Industrial Dynamics Simulation Models in the Design of Supply Chains", *International Journal of Physical Distribution & Logistics Management*, vol. 22, no. 5, pp. 3-13.
- Tracey, M. & Tan, C. L. (2001), "Empirical analysis of supplier selection and involvement, customer satisfaction, and firm performance", *Supply Chain Management: An International Journal*, vol. 6, no. 4, pp. 174-188.
- Treleven, M. & Schweikhart, S. B. (1988), "A risk/benefit analysis of sourcing strategies: single vs. multiple sourcing", *Journal of Operations Management*, vol. 7, no. 4, pp. 93-114.
- Trent, R. J. (2004), "The Use of Organizational Design Features in Purchasing and Supply Management", *Journal of Supply Chain Management*, vol. 40, no. 3, pp. 4-18.
- Trienekens, J. H. & Beulens, A. J. M. (2001), "Views on inter-entrepreneur relationships", *Production Planning & Control*, vol. 12, no. 5, pp. 466-477.
- Tsay, A. A. (1999), "The Quantity Flexibility Contract and Supplier-Customer Incentives", *Management Decision*, vol. 45, no. 10, pp. 1339-1358.
- Tullous, R. & Munson, J. M. (1991), "Trade-offs Under Uncertainty: Implications for Industrial Purchasers", *International Journal of Purchasing and Materials Management*, vol. 27, no. 3, pp. 24-31.

- Turner, M. (2003), "Business Continuity: More Than Simply Recovering From a Disaster!", *Credit Control*, vol. 24, no. 2, pp. 25-27.
- van der Horst, J. G. A. J. & Beulens, A. J. M. (2002), "Identifying sources of uncertainty to generate supply chain redesign strategies", *International Journal of Physical Distribution & Logistics Management*, vol. 32, no. 6, pp. 409-430.
- van der Horst, J. G. A. J. & Beulens, A. J. M. (1999), "A Research Model for the Redesign of Food Supply Chains", *International Journal of Logistics: Research and Applications*, vol. 2, no. 2, pp. 161-174.
- van der Horst, J. G. A. J., Beulens, A. J. M., de Wit, W., & van Beek, P. (1998), "Supply Chain Management in Food Chains: Improving Performance by Reducing Uncertainty", *International Transactions in Operational Research*, vol. 5, no. 6, pp. 487-499.
- van der Horst, J. G. A. J., van Dijk, S. J., & Beulens, A. J. M. (2001), "Supply chain design in the food industry", *International Journal of Logistics Management*, vol. 12, no. 2, pp. 73-85.
- van der Vaart, J. T., de Vries, J., & Wijngaard, J. (1996), "Complexity and uncertainty of materials procurement in assembly situations", *International Journal of Production Economics*, vol. 46-47, pp. 137-152.
- van der Zee, D. J. & van der Horst, J. G. A. J. (2005), "A Modeling Framework for Supply Chain Simulation: Opportunities for Improved Decision Making", *Decision Sciences*, vol. 36, no. 1, pp. 65-95.
- van Dorp, J. R. & Duffey, M. R. (1999), "Statistical dependence in risk analysis for project networks using Monte Carlo methods", *International Journal of Production Economics*, vol. 58, no. 1, pp. 17-29.
- van Hoek, R. & Weken, H. A. M. (1998), "The Impact of Modular Production on the Dynamics of Supply Chains", *International Journal of Logistics Management*, vol. 9, no. 2, pp. 35-50.
- van Hoek, R. I., Commandeur, H. R., & Vos, B. (1998), "Reconfiguring Logistics Systems Through Postponement Strategies", *Journal of Business Logistics*, vol. 19, no. 1, pp. 33-53.
- van Mieghem, J. A. (1999), "Coordinating Investment, Production, and Subcontracting", *Management Decision*, vol. 45, no. 7, pp. 954-971.
- Vidal, C. J. & Goetschalkx, M. (2000), "Modeling the Effect of Uncertainties on Global Logistics Systems", *Journal of Business Logistics*, vol. 21, no. 1, pp. 95-120.
- Vokurka, R. J. (1998), "Supplier partnership: A case study", *Production and Inventory Management*, vol. 39, no. 1, pp. 30-35.
- Vonderembse, M. A. & Tracey, M. (1999), "The impact of supplier selection criteria and supplier involvement on manufacturing performance", *Journal of Supply Chain Management*, vol. 35, no. 3, pp. 33-39.
- Voordijk, H. (2000), "The changing logistical system of the building materials supply chain", *International Journal of Operations & Production Management*, vol. 20, no. 7, pp. 823-841.
- Vörös, J. (1999), "On the risk-based aggregate planning for seasonal products", *International Journal of Production Economics*, vol. 59, no. 1-3, pp. 195-201.
- Walker, G. (1988), "Strategic Sourcing, Vertical Integration, and Transaction Cost", *Interfaces*, vol. 18, no. 3, pp. 62-73.
- Walker, W. T. (2000), "Rethinking the Reverse Supply Chain", *Supply Chain Management Review*, vol. 4, no. 2, pp. 52-59.
- Wallace, L., Keil, M., & Rai, A. (2004), "How Software Project Risk Affect Project Performance: An Investigation of the Dimensions of Risk and an Exploratory Model", *Decision Sciences*, vol. 35, no. 2, pp. 289-321.
- Walsh, P., Koutsakos, P., Vontas, A., & Koumpis, A. (2003), "Building enterprise-wide information supply chains based on the fractal concept", *Integrated Manufacturing Systems*, vol. 14, no. 5, pp. 397-408.

- Walton, S. V., Handfield, R. B., & Melnyk, S. A. (1998), "The green supply chain: Integrating suppliers into environmental management processes", *International Journal of Purchasing and Materials Management*, vol. 34, no. 2, pp. 2-11.
- Wang, G., Huang, S. H., & Dismukes, J. P. (2004), "Product-driven supply chain selection using integrated multi-criteria decision-making methodology", *International Journal of Production Economics*, vol. 91, no. 1, pp. 1-15.
- Watkins, M. D. & Bazerman, M. H. (2003), "Predictable Surprises: The Disasters You Should Have Seen Coming", *Harvard Business Review*, vol. 81, no. 3, pp. 72-80.
- Wedel, M. & DeSarbo, W. S. (1993), "A Latent Class Binomial Logit Methodology for the Analysis of Paired Comparison Choice Data: An Application Reinvestigating the Determinants of Perceived Risk", *Decision Sciences*, vol. 24, no. 6, pp. 1157-1170.
- Welman, J. C. & Kruger, S. J. (2001), *Research Methodology - for the Business and Administrative Sciences*, 2. edn, Oxford University Press Southern Africa, Cape Town, South Africa.
- Weng, Z. K. (1999), "Risk-pooling over demand uncertainty in the presence of product modularity", *International Journal of Production Economics*, vol. 62, no. 1-2, pp. 75-85.
- Westbrook, K. W. (1996), "Risk Coordinative Maneuvers During Buyer-Seller Negotiations", *Industrial Marketing Management*, vol. 25, no. 4, pp. 283-292.
- Wilding, R. (1998a), "The supply chain complexity triangle - Uncertainty generation in the supply chain", *International Journal of Physical Distribution & Logistics Management*, vol. 28, no. 8, pp. 599-616.
- Wilding, R. D. (1998b), "Chaos theory: Implications for supply chain management", *International Journal of Logistics Management*, vol. 9, no. 1, pp. 43-56.
- William Demant Holding (2003), www.demant.dk, "Corporate Governance", accessed 2005-10-01.
- William Demant Holding (2005), *William Demant Holding - Annual Report 2004 (William Demant Holding - Årsrapport 2004)*, William Demant Holding, Hellerup, Denmark.
- Wilson, T. P. & Clarke, W. R. (1998), "Food safety and traceability in the agricultural supply chain: using the Internet to deliver traceability", *Supply Chain Management: An International Journal*, vol. 3, no. 3, pp. 127-133.
- Wood, W. R. (1985), "The Risks On Reliance On The Uniform Railroad Costing System", *Journal of Business Logistics*, vol. 6, no. 2, pp. 142-158.
- Wouters, M. J. F., Sharman, G. J., & Wortmann, H. C. (1999), "Reconstructing the Sales and Fulfillment Cycle to Create Supply Chain Differentiation", *International Journal of Logistics Management*, vol. 10, no. 2, pp. 83-98.
- Wright, G. (1980), "Purchasing, Risk and Logistics: A Neglected Combination?", *International Journal of Operations & Production Management*, vol. 1, no. 1, pp. 47-58.
- Yin, R. K. (1994), *Case study research - Design and methods*, 2. edn, SAGE Publications, Thousand Oaks, CA.
- Zaidman, B. (1994), "Market vulnerability in the process industries", *International Journal of Production Economics*, vol. 34, no. 1, pp. 57-64.
- Zäpfel, G. (1996), "Production planning in the case of uncertain individual demand - Extension for an MRP II concept", *International Journal of Production Economics*, vol. 46-47, pp. 153-164.
- Zeng, A. Z. (2003), "Global sourcing: process and design for efficient management", *Supply Chain Management: An International Journal*, vol. 8, no. 4, pp. 367-379.
- Zhao, Z. & Lee, T. S. (1993), "Freezing the master production schedule for material requirements planning systems under demand uncertainty", *Journal of Operations Management*, vol. 11, no. 2, pp. 185-205.
- Zimmer, K. (2002), "Supply chain coordination with uncertain just-in-time delivery", *International Journal of Production Economics*, vol. 77, no. 1, pp. 1-15.
- Zinszer, P. H. (1983), "Inventory Costing: A Return On Inventory Approach To Differentiating Inventory Risk", *Journal of Business Logistics*, vol. 4, no. 2, pp. 20-39.

- Zirpoli, F. & Caputo, M. (2002), "The nature of buyer-supplier relationships in co-design: The Italian auto industry case", *International Journal of Operations & Production Management*, vol. 22, no. 12, pp. 1389-1410.
- Zografos, K. G. & Giannouli, I. M. (2001), "Development and Application of a Methodological Framework for Assessing Supply Chain Management Trends", *International Journal of Logistics: Research and Applications*, vol. 4, no. 2, pp. 153-190.
- Zotteri, G. (2000), "The impact of distributions of uncertain lumpy demand on inventories", *Production Planning & Control*, vol. 11, no. 1, pp. 32-43.
- Zsidisin, G. (2003a), "A grounded definition of supply risk", *Journal of Purchasing and Supply Management*, vol. 9, no. 5-6, pp. 217-224.
- Zsidisin, G. (2003b), "Managerial Perceptions of Supply Risk", *Journal of Supply Chain Management*, vol. 39, no. 1, pp. 14-25.
- Zsidisin, G. & Ellram, L. M. (2003), "An Agency Theory Investigation of Supply Risk Management", *Journal of Supply Chain Management*, vol. 39, no. 3, pp. 15-27.
- Zsidisin, G. A., Ellram, L. M., Carter, J. R., & Cavinato, J. L. (2004), "An analysis of supply risk assessment techniques", *International Journal of Physical Distribution & Logistics Management*, vol. 34, no. 5, pp. 397-413.
- Zsidisin, G. A., Panelli, A., & Upton, R. (2000), "Purchasing organization involvement in risk assessments, contingency plans, and risk management: an exploratory study", *Supply Chain Management: An International Journal*, vol. 5, no. 4, pp. 187-197.

Internet Resources

www.clm1.org	Council of Logistics Management
www.coloplast.com	Coloplast
www.corporategovernance.dk	Corporate Governance (Denmark)
www.coso.org	The Committee of Sponsoring Organizations of the Treadway Commission
www.cscmp.org	Council of Supply Chain Management Professionals
www.demant.dk	William Demant Holding
www.marsh.dk	Marsh Consulting (Denmark)
www.supply-chain.org	Supply Chain Council

ISSN 0906-6934
ISBN 978-87-593-8342-1