

Child, Michael; Kempf, Claudia; Bogdanov, Dmitrii; Breyer, Christian

Article — Published Version

Flexible electricity generation, grid exchange and storage for the transition to a 100% renewable energy system in Europe

Renewable Energy

Provided in Cooperation with:

German Institute for Economic Research (DIW Berlin)

Suggested Citation: Child, Michael; Kempf, Claudia; Bogdanov, Dmitrii; Breyer, Christian (2019) : Flexible electricity generation, grid exchange and storage for the transition to a 100% renewable energy system in Europe, Renewable Energy, ISSN 0960-1481, Elsevier, Amsterdam, Vol. 139, pp. 80-101, <https://doi.org/10.1016/j.renene.2019.02.077> , <http://www.sciencedirect.com/science/article/pii/S0960148119302319>

This Version is available at:

<https://hdl.handle.net/10419/200100>

Standard-Nutzungsbedingungen:

Die Dokumente auf EconStor dürfen zu eigenen wissenschaftlichen Zwecken und zum Privatgebrauch gespeichert und kopiert werden.

Sie dürfen die Dokumente nicht für öffentliche oder kommerzielle Zwecke vervielfältigen, öffentlich ausstellen, öffentlich zugänglich machen, vertreiben oder anderweitig nutzen.

Sofern die Verfasser die Dokumente unter Open-Content-Lizenzen (insbesondere CC-Lizenzen) zur Verfügung gestellt haben sollten, gelten abweichend von diesen Nutzungsbedingungen die in der dort genannten Lizenz gewährten Nutzungsrechte.

Terms of use:

Documents in EconStor may be saved and copied for your personal and scholarly purposes.

You are not to copy documents for public or commercial purposes, to exhibit the documents publicly, to make them publicly available on the internet, or to distribute or otherwise use the documents in public.

If the documents have been made available under an Open Content Licence (especially Creative Commons Licences), you may exercise further usage rights as specified in the indicated licence.



<https://creativecommons.org/licenses/by/4.0>

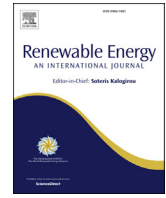

Flexible electricity generation, grid exchange and storage for the transition to a 100% renewable energy system in Europe

Michael Child ^{a,*}, Claudia Kemfert ^b, Dmitrii Bogdanov ^a, Christian Breyer ^a

^a Lappeenranta University of Technology, Skinnarilankatu 34, 53850 Lappeenranta, Finland

^b German Institute for Economic Research (DIW) and Hertie School of Governance, Mohrenstrasse 58, 10117 Berlin, Germany



ARTICLE INFO

Article history:

Received 20 December 2018

Accepted 14 February 2019

Available online 15 February 2019

Keywords:

Energy transition

Storage technologies

Europe

100% Renewable energy

Energy policy

ABSTRACT

Two transition pathways towards a 100% renewable energy (RE) power sector by 2050 are simulated for Europe using the LUT Energy System Transition model. The first is a Regions scenario, whereby regions are modelled independently, and the second is an Area scenario, which has transmission interconnections between regions. Modelling is performed in hourly resolution for 5-year time intervals, from 2015 to 2050, and considers current capacities and ages of power plants, as well as projected increases in future electricity demands. Results of the optimisation suggest that the levelised cost of electricity could fall from the current 69 €/MWh to 56 €/MWh in the Regions scenario and 51 €/MWh in the Area scenario through the adoption of low cost, flexible RE generation and energy storage. Further savings can result from increasing transmission interconnections by a factor of approximately four. This suggests that there is merit in further development of a European Energy Union, one that provides clear governance at a European level, but allows for development that is appropriate for regional contexts. This is the essence of a SuperSmart approach. A 100% RE energy system for Europe is economically competitive, technologically feasible, and consistent with targets of the Paris Agreement.

© 2019 The Authors. Published by Elsevier Ltd. This is an open access article under the CC BY license (<http://creativecommons.org/licenses/by/4.0/>).

1. Introduction

The European Commission has adopted a framework strategy to establish an Energy Union that aims to assist in the transition towards greater sustainability, energy security and economic competitiveness [1]. The union aims to build greater solidarity and cooperation amongst Member States in order to pool and diversify energy resources. This would include integrating energy markets, and strengthening transmission interconnections where necessary to “make the European Union (EU) the world number one in renewable energy and lead the fight against global warming” [1]. In July, 2018 the trio of France, Spain and Portugal agreed that there would be a strategic role of interconnections to add value in Europe, to honour commitments related to the Paris Agreement, and to promote convergence between Member States [2]. Concurrently, the European Commission proposes to support efforts involving cross-border renewable energy (RE) projects, and continue to promote key trans-European network infrastructures [3].

Two relevant issues have emerged related to governance of the

Energy Union. The first concerns the overall objective and time-frame of the union. Some argued that in order to achieve the goals of the Paris Agreement, a “red line” of achieving net-zero greenhouse gas (GHG) emissions by 2050 was needed to avoid liabilities for future generations [4]. At the same time, some Member States displayed reluctance to mention a specific date. Ultimately, the final wording agreed upon was to aim for net-zero GHG emissions “as early as possible”, but it appears that future scenarios and decarbonisation plans for the EU and its Member States will need to show how the objective of net-zero by 2050 could be achieved. The latest long-term vision for Europe incorporates this objective [5] and warns that not achieving such a goal could be a major threat to security and prosperity.

The second issue concerns the level of interconnection that would be needed to achieve such goals. Lilliestam and Hangar [6] describe the contrasting views of two organisations that advocate 100% renewable energy futures for Europe, EUROSOLAR [7] and DESERTEC [8]. On the one hand, EUROSOLAR advocates decentralisation of energy and the disempowerment of the actors and structures that have produced an unsustainable and undemocratic energy system [9]. On the other hand, DESERTEC envisions a highly centralised and regulated system of imports and exports of solar

* Corresponding author.

E-mail address: Michael.Child@lut.fi (M. Child).

Nomenclature			
A-CAES	adiabatic compressed energy storage	M	mega
b	billion	NREAP	National Renewable Energy Action Plan
BAU	business as usual	OCGT	open cycle gas turbine
BECCS	bioenergy enhanced carbon capture and storage	PP	power plant
CCGT	combined cycle gas turbine	PHES	pumped hydro energy storage
CCU	carbon capture and utilisation	PtH	power-to-heat
CHP	combined heat and power	PtG	power-to-gas
CSP	concentrating solar thermal power	PV	photovoltaics
DACCS	direct air carbon capture and storage	RE	renewable energy
GHG	greenhouse gas	RED	Renewable Energy Directive
G	giga	SNG	synthetic natural gas
GT	gas turbine	ST	steam turbine
h	hour	t	ton
HHB	hot heat burner	T	tera
HVAC/HVDC	high voltage alternating current/direct current	TES	thermal energy storage
ICE	internal combustion engine	W	watt
k	kilo	WACC	weighted average cost of capital
LCOE	levelised cost of electricity	e	electric units
		gas	gas units
		th	thermal units

and wind power throughout Europe [10]. However, a third option may be possible. Battaglini et al. [11] advocate an approach for Europe that combines the decentralised Smartgrid with the centralised Supergrid to produce a SuperSmart Grid vision, arguing that “the two concepts are complementary and can and must co-exist in order to guarantee a transition to a decarbonised economy”. Consistent with this vision is the idea that there are already natural areas of energy cooperation within Europe, and that macro-regional partnerships have “the potential to deliver cost-optimised deployment of smart grids, renewables and energy efficiency” [12]. Energy system visions, therefore, should aim to take into account that energy systems can be viewed from the perspective of individual prosumers, nationally, macro-regionally, and from a pan-European perspective. In addition, appropriate policies should be considered that support such visions.

The transition towards 100% RE needs political support. It also needs innovation, not only technological, but also innovative policy strategies, smart measures and efficient governance. In order to reach such goals, countries have to revise their energy transition strategies, measures and governance to include financial incentives for the transition. Thanks to past measures and instruments to promote RE, the costs for RE have been substantially reduced due to technological learning, market diffusion, and improved economies of scale. To increase the share of RE in all sectors and countries, concrete support schemes, financial incentives and market designs are necessary for a full transition. A first step is to define concrete short- and long-term goals for change in the energy system. This will provide the regulatory stability for public authorities and private operators that will be essential to a successful transition [5].

There are joint EU goals defined to increase the share of RE. The overall policy requires the EU to fulfil at least 20% of its total energy consumption from renewables by 2020. Also, all EU countries must ensure at least 10% of their transport fuels come from RE sources by 2020 in National Renewable Energy Action Plans (NREAPs). Leading up to 2020, two trajectories must be achieved. The minimum indicative Renewable Energy Directive (RED) Trajectories for RE share in each Member State had to be met by 2018 and Expected Trajectories had to be adopted as part of the NREAPs of 2010, with reports from Member States submitted to the European Commission in 2011, 2013, and 2015. RED was amended in 2015 to address concerns around the indirect land-use of biofuels, with a limitation

of 5% for food-based fuels. There was an additional framework adopted by the EU Council in 2014 for 2030 goals: a binding minimum 40% domestic reduction in GHG emissions compared with 1990 levels; a binding minimum 27% share of Gross Final Energy Consumption as well as an indicative minimum 27% improvement in energy efficiency; and national level integration of 2030 goals into energy frameworks. The binding renewable energy target was also adjusted upwards to 32% in 2018, with an aim to revise that figure higher still by 2023 [13]. Nationally, targets and goals differ substantially, as well as the support instruments used to achieve them (Figs. 1 and 2).

Over the period of 2007–2017, European installed capacity of RE grew from 258 GW_e to 512 GW_e [16]. As seen in Fig. 3, growth primarily comes from solar PV (+1966%), offshore wind (+1365%), onshore wind (+180%) and bioenergy (+94%).

Growing capacities of RE, particularly solar PV and wind, have resulted in falling costs and increased competitiveness of RE technologies on a levelised cost of electricity (LCOE) basis [17]. Storage technologies have shown similar cost reductions, especially batteries [18]. Therefore, combining RE and storage may offer the lowest cost power solutions in the future [17]. In a European context, this could represent a well-timed opportunity. Currently, much of the generation capacity is rather old and carbon intensive. At the same time, most of the nuclear power plants of Europe may be decommissioned before 2050. So, there appears to be an opportunity to replace older power plants with RE technologies without the risk of stranded investments [19].

Nuclear power generation and carbon capture and storage (CCS) schemes have been proposed as solutions for future low carbon energy systems [20]. However, both involve such high costs and significant risks that the relative benefits to society are increasingly difficult to see. Both industries also appear on the verge of collapse as many nations see greater promise in RE, as institutional investors seek to avoid risk through avoidance and divestment, and as most of the largest nuclear power plant manufacturers have experience serious financial challenges or have opted to end operations [21].

Nuclear power has seen steady increases over the past decades in terms of LCOE. This is due to ever higher capital expenditures that result from increasing system complexity, high budget and construction time overruns, and a need to protect society from the dangers of nuclear accidents and threats of terrorism. Moreover,

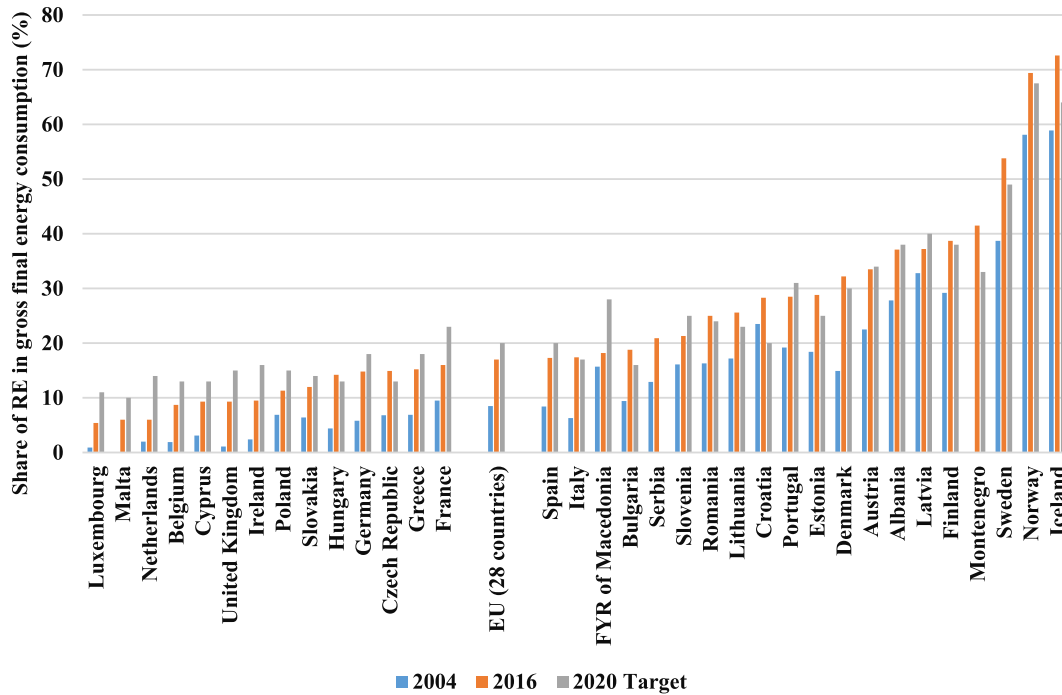

Fig. 1. RE share of energy consumption in selected European countries [14].

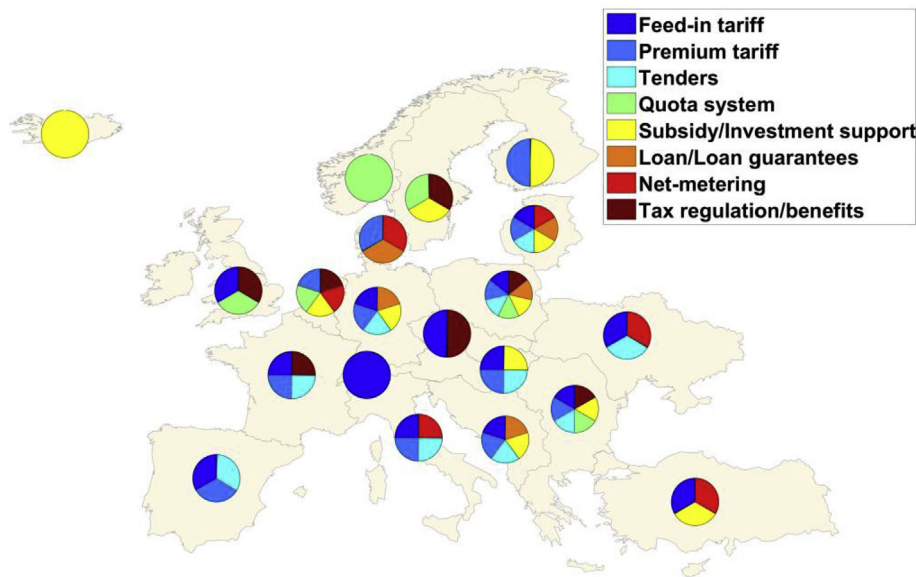

Fig. 2. Main RE support instruments in selected regions of Europe [15].

direct and indirect public subsidies for nuclear power are at high levels. Most notable of these involves the socialisation of many of the risks associated with nuclear power. As the insurance liability of nuclear operators is limited globally through various national laws, much of the financial responsibility for large accidents, such as the so-called “dragon king scale” events at Chernobyl and Fukushima [22], falls firmly on society as a whole, thereby creating unequal sharing of risk and reward. For several reasons discussed in Ref. [23], there may not only be a poor investment horizon for nuclear power, but even a strong risk of stranded investments in current assets if societal goals change.

There are several reasons why the viability of fossil energy based

CCS is also questionable. Ram et al. [23] summarize how CCS represents a high cost, high risk option on economic, environmental and social grounds. First, CCS is a more expensive alternative to RE. Second, budget and construction overruns contribute to the poor economics of a technology that has yet to show the maturity needed for large-scale carbon capture. Third, CCS is not carbon neutral, and risks of future leakage will require vigilant management efforts for generations. Fourth, relying on fossil fuel based CCS obscures the fact that CO₂ is not the only harmful emission associated with fossil fuels, and does nothing to address such threats to human and environmental health as sulphur oxide, nitrogen oxide and heavy metal emissions. Nor does CCS prevent harmful

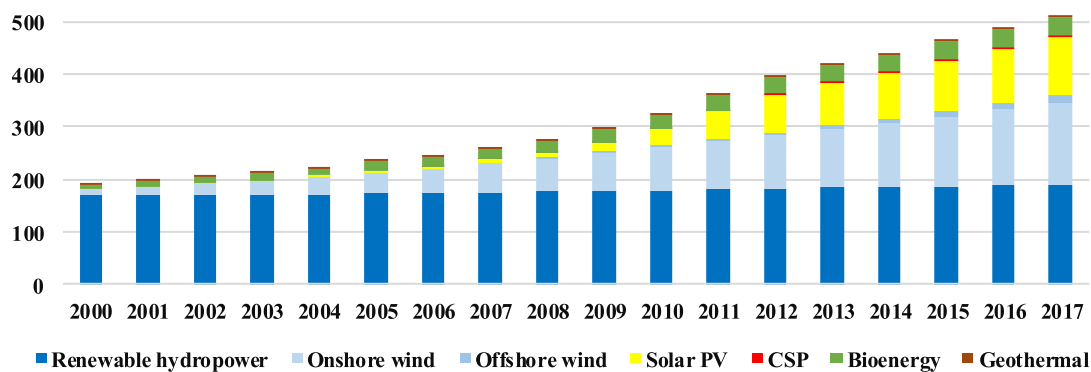

Fig. 3. Installed capacity of renewable energy technologies in Europe (GW) from 2007 to 2017 [16]. Renewable hydropower values do not include installed capacity of pumped hydro storage.

emissions that occur during the mining, refining and transport of fossil fuels. In essence, fossil-based CCS will do little to contribute to a resilient and sustainable energy system, and may represent more harm than good. Instead, more sustainable forms of CCS are being advocated, such as bioenergy enhanced carbon capture and storage (BECCS) and Direct Air Carbon Capture and Storage (DACCS), along with Carbon Capture and Utilisation (CCU) [24].

For these reasons, 100% RE systems have been proposed as feasible and economically viable solutions on a global level [25], and there appears to be a growing body of scientific literature to support this [26]. Energy scenarios with 100% renewable energy have also been identified as conforming to the widest range of sustainability criteria, and respect known planetary boundaries [27]. Recent modelling work on Europe also establishes the technical feasibility and economic competitiveness of high shares of RE, and highlights the strong supporting role of transmission interconnections [28–38]. In addition, Child et al. [39] demonstrated that storage technologies could support a transition towards a cost optimal, 100% RE system for Europe. However, the bulk of this work did not discuss the roles of flexible generation or transmission interconnections in detail, nor was the discussion sufficient to enable recommendations from a policy perspective.

Table 1 shows the main peer-reviewed journal publications on 100% RE systems for Europe. Common themes in the literature indicate that 100% RE scenarios are both technologically feasible and cost competitive for Europe. Further, they rather consistently indicate that cost savings on balancing generation and electricity storage can be achieved through expanded use of transmission interconnections. However, these studies consistently model electricity flows entirely through centralised grids, something that currently does not occur nor is likely to occur in the future. In order to test whether centralised, decentralised or hybrid grids will be the best solution for Europe, some effort must be made to account for the existence of decentralised prosumers (or those who are both self-generators and consumers [37]), that they may decide to employ their own storage technologies, and that some end-user needs for power will be satisfied without the help of a centralised grid. If prosumerism is significant in the future, centralised load profiles for grids may be effected and so may be the need for transmission interconnections between the regions of Europe. In addition, prosumer choices about whether to purchase solar PV systems or energy storage are not uniform. Prosumers can be residential, commercial, or industrial entities. Each will have their own costs for technologies depending on the scale, and each will have their own end-user prices of electricity. Modelling must proceed, therefore, with a fuller range of the realistic choices that can be

made by prosumers, as well as take into account their impacts on central grids.

Therefore, this work extends the investigation begun in Ref. [39] to more fully describe the roles of flexible electricity generation, grid interconnections and energy storage solutions in a transition towards 100% RE for the electricity sector of Europe by 2050. To this end, this work seeks to determine a least cost power sector transition, one that results in sustainable, reliable and secure power supply in Europe. At the same time, this work seeks to compare scenarios in which the specific nations and macro-regions of Europe are either independent energy islands or interconnected in order to determine if a European Energy Union would be part of a least cost solution. Further, this study will more adequately incorporate the possible impacts of prosumers on central electricity grids, and seek to determine if prosumerism would have an effect on the need for interconnections between the regions of Europe. Lastly, upon examining the range of policy options used in Europe to promote renewable energy development, this work will make suggestions related to policy that would promote the transition towards sustainability. This transition is modelled in five-year time steps beginning from 2015 using the Lappeenranta University of Technology (LUT) Energy System Transition Model [37,52]. In order to add to the debate on the role of transmission interconnections, two scenarios are investigated. The first is Regions, whereby Europe is divided into 20 independent energy systems that take into account some macro-regional grouping; and Area, whereby these same nations and macro-regions are interconnected with high voltage transmission lines and cables. In both scenarios, modelling of optimal prosumer solar PV production and battery energy storage will precede the main modelling of the centralised energy system.

2. Materials and methods

The LUT Energy System Transition Model described in Refs. [37,52] was used to model the European power system. Europe was divided into 20 defined nations and macro-regions that take account of the fact that natural areas of cooperation exist [53]. Fig. 4 presents these regional classifications.

2.1. Model summary

The LUT Energy System Transition model target function is to optimize energy system elements in order to minimize total annualised system costs and the cost of end user electricity consumption. The model is multi-nodal, and uses linear optimisation in hourly temporal resolution and 0.45° by 0.45° spatial resolution for

Table 1
Main peer-reviewed journal publications concerning 100% renewable energy in Europe.

Journal publication	Year	Target year	Model used	Type of scenario	Key results
Heide et al. [40]	2010				Solar and wind power show complementarity in Europe
Heide et al. [41]	2011				Storage and balancing needs depend significantly on the mix of solar and wind power generation
Rasmussen et al. [29]	2012				Significant synergies were found between storage and balancing
Steinke et al. [42]	2013	2020	GAMS/CPLEX	Overnight	100% RE will require significant balancing generation, grid extension and storage
Becker et al. [31]	2014		AU model		Higher investments in transmission interconnections can result in less need for balancing
Huber et al. [43]	2014				Flexibility requirements of a transnational European power system are lower than for individual systems
Rodriguez et al. [35]	2014	2050	AU model	Transition	Higher investments in transmission interconnections can result in less need for balancing
Connolly et al. [38]	2014	2050	EnergyPLAN	Transition steps	100% RE is feasible and cost competitive
Bussar et al. [44]	2015	2050	GENESYS	Overnight	Optimisation of 100% renewable power system
Hohmeyer and Bohm [45]	2015	2050	renpass	Transition	100% RE systems are feasible and reliable European cooperation and trade will reduce costs
Rodriguez et al. [46]	2015		AU model		Interconnections between countries can result in less need for balancing
Bussar et al. [36]	2016	2050	GENESYS	Overnight	Optimisation of 100% renewable power system
Schlachtberger et al. [47]	2016		AU model		Balancing capacities can be reduced if countries share their excess and backup
Gils et al. [48]	2017	2050	REMix	Transition	100% RE should be supported by balancing capacity, grids and storage
Eriksen et al. [49]	2017		AU model		Heterogeneous distribution of wind and solar can reduce electricity cost
Raunbak et al. [50]	2017		AU model		Balancing and transmission infrastructure are caused by mismatches between weather-driven RE and load
Pleißmann and Blechinger [51]	2017	2050	elesplan-m	Transition	Decarbonized power is feasible with high levels of interconnection
Brown et al. [28]	2018		PyPSA	Overnight	Expansion of cross-border transmission enables integration of high shares of RE and reduces costs, but energy sector coupling may have a greater impact

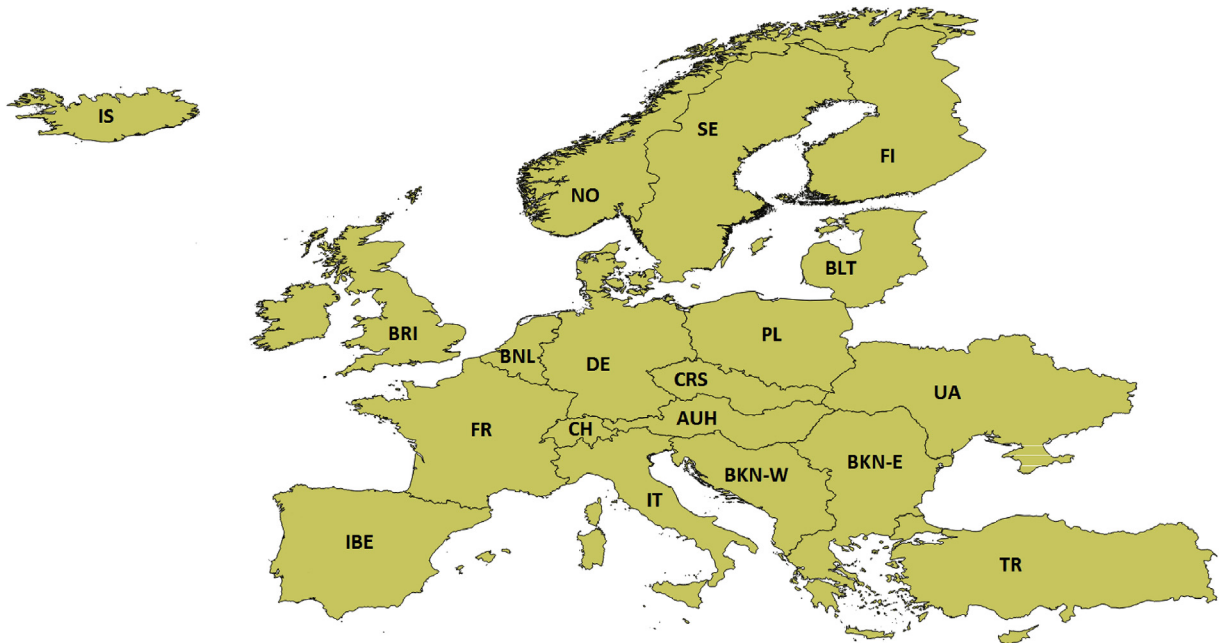

Fig. 4. The 20 defined regions of Europe. NO: Norway; DK: Denmark; SE: Sweden; FI: Finland; BLT: Estonia, Latvia, Lithuania; PL: Poland; CRS: Czech Republic, Slovakia; AUH: Austria, Hungary; CH: Switzerland; DE: Germany; BNL: Belgium, Netherlands, Luxembourg; BRI: UK and Ireland; IS: Iceland; IBE: Portugal, Spain; IT: Italy, Malta; BKN-W: Slovenia, Croatia, Bosnia & Herzegovina, Serbia, Kosovo, Montenegro, Macedonia, Albania; BKN-E: Romania, Bulgaria, Greece; UA: Ukraine, Moldova; TR: Turkey, Cyprus. Adapted from Ref. [39].

solar and wind resources to simulate the annual operation of a power system. Simulations occur in 5-year time steps under given constraints. A comprehensive description of the model can be found from

Ref. [52]. Main inputs and outputs of the model, and a block diagram, are shown in Figs. 5 and 6. Equations related to the calculation of levelised costs are presented in the Supplementary Material.

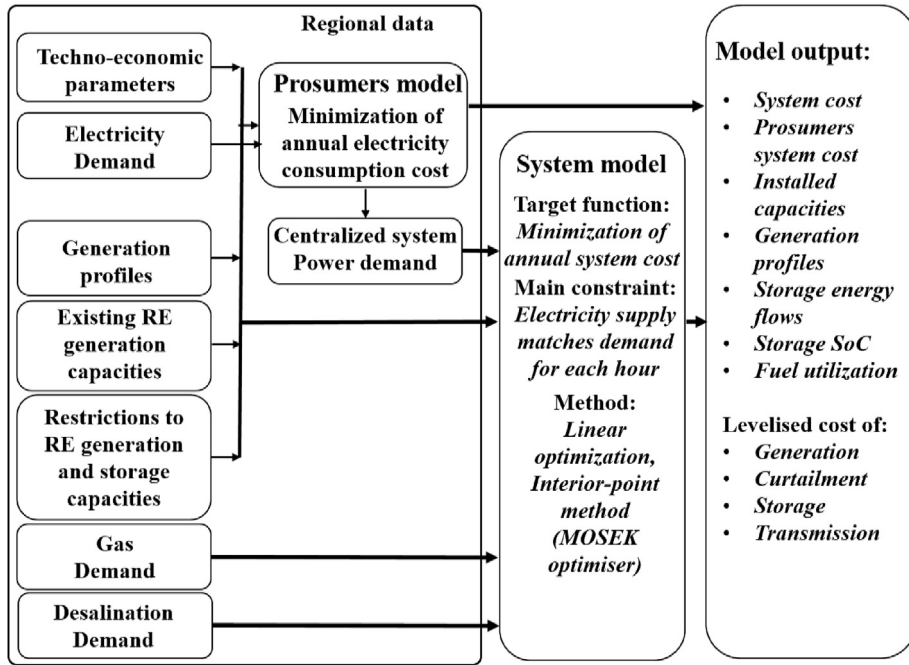

Fig. 5. Main inputs and outputs of the LUT Energy System Transition model. Adapted from Ref. [39].

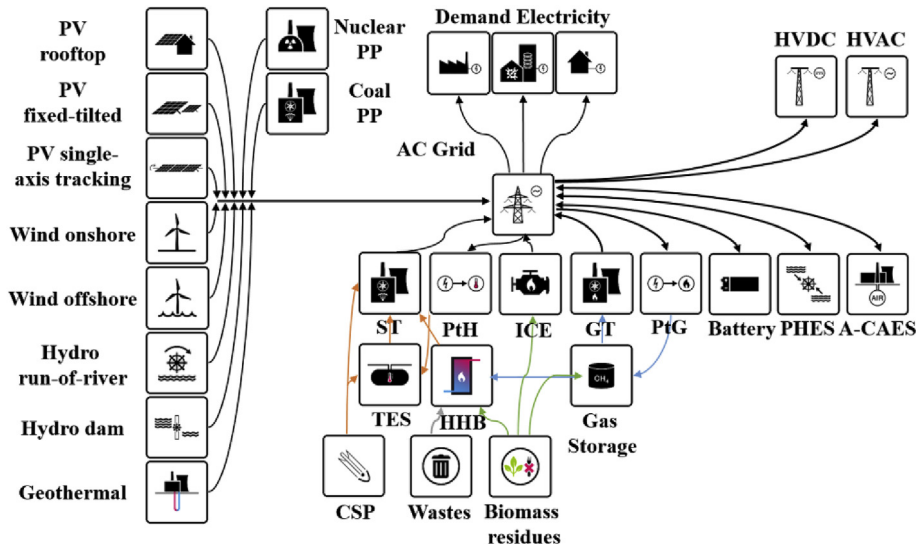

Fig. 6. Block diagram of the LUT Energy System Transition model. Acronyms not introduced elsewhere include: PP - power plant, ST - steam turbine, PtH - power-to-heat, ICE - internal combustion engine, GT - gas turbine, PtG - power-to-gas, PHEs - pumped hydro energy storage, A-CAES - adiabatic compressed air energy storage, TES - thermal energy storage, HHB - hot heat burner, CSP - concentrating solar thermal power. Adapted from Ref. [39].

In order to determine the lowest energy system costs, the sum of various annual costs is optimised, including energy generation costs, generation ramping costs, and the costs of all installed capacities. Further, distributed generation by prosumers is comprised of residential, commercial and industrial prosumers. The costs of three different types of prosumers (residential, commercial, industrial) are included in the system as the respective installed capacities of rooftop PV systems and batteries. The model seeks to minimize the cost of prosumer electricity consumption, which includes self-generation cost and the cost of electricity consumed from the grid. Excess prosumer generation is sold to the grid and subtracted from total annual costs of prosumers.

Four constraints guide the operation of the model in order to limit the deployment of RE technologies to a more realistic growth pattern. The first limits the growth in absolute RE installed capacities to a maximum of 20% for each 5-year time step. An exception to this constraint was made for the first time step, in which growth was limited to 15%. This constraint was devised in order to prevent possible disruption to the power system. The second constraint limits the model from installing technology related to bioenergy production before 2030. Accordingly, only 16% of the biogas and waste resource potentials could be exploited by 2020, 33% by 2025, 66% by 2030 and 100% by 2030 and onwards. This constraint was devised to limit biogas technologies from being installed too

quickly. It was noticed that although there was high biogas resource availability, it would be unlikely that resource exploitation would rapidly advance from its relatively low level currently. Instead, a logistic growth pattern was assumed. The third constraint involved prosumers. Prosumer demand is limited to 20% of total demand, however up to 50% of total excess generation is allowed to feed into the grid. At the same time, the constraint ensures that the level of 20% will not be reached within the first time step. Instead, the model determines a step-wise progression from a maximum of 6% in the first time step to 9%, 15%, 18% and 20% in subsequent time steps if the economic model of prosumers works and there are benefits from self-generation in a given region. This constraint not only limits the growth rate of prosumerism, but also takes into account that there will be different growth rates in different regions. The final constraint was that no new nuclear and fossil fuel-based power plants would be installed after 2015 due to sustainability reasons. This also means that power plants of these categories that are currently under construction are not considered. An exception was made for gas turbines, as such technology is highly efficient, and can utilise sustainably produced synthetic natural gas (methane) and biomethane as fuel.

2.2. Applied technologies

The applied technologies available to the model are shown in Fig. 6, including: electricity generation, energy storage, and electricity transmission. Regional interconnections for the Area scenario are derived from the European Network of Transmission System Operators for Electricity (ENTSOE-E) [54]. This information includes both the current status and future potentials of interconnections. As future potentials established by ENTSO-E included values up to 2030, it was assumed that all subsequent additions would be based on HVDC transmission. These additions are comprised of 70% underground cables and 30% overhead lines. All new undersea connections were assumed to be HVDC cables. These assumptions were made to account for levels of social resistance to visible overhead electricity lines. However, it must be noted that the model results may still differ from what would be

socially desired in some cases. It is beyond the scope of this work to examine such issues, but they most certainly would need to be part of the overall discourse concerning future energy system development. Interconnections and transmission line lengths used for the Area scenario are shown in Fig. 7.

Transmission line lengths were determined for each interconnection on an individual basis, and took into account known locations of undersea cables and border points where interconnections are found. In cases where information was not known, straight lines were drawn between the main electricity demand centers of each region. An additional 10% was added to land lengths to account for topography. Interconnections were assumed to connect the largest electricity consumption centers of each region. A summary of transmission line distances between the main demand centers used in this study is shown in the Supplementary Material.

Scenarios developed by ENTSO-E [54] provided values for current levels of interconnection based on existing transmission line capacities in winter 2010/2011, and potential values for 2030. However, these values were not distinguished as either HVAC or HVDC, so each interconnection was examined to determine the status of each. Only three sources of HVDC cables were found in Europe: ABB [55], Siemens [56], and Interconnexion France-Angleterre [57]. After determining the total of HVDC capacity in a region, this value was subtracted from the current capacity value to determine the current HVAC capacity. The future value proposed by ENTSO-E is assumed to be the upper limit to future HVAC interconnections. However, if this is a known undersea connection, a value of 0 is assigned as all undersea connections are assumed to be HVDC. No upper limit is assigned to the model's ability to build new HVDC interconnections as part of the least lost solution other than the acceptability constraint mentioned above. All values are shown in the Supplementary Material.

2.3. Financial and technical assumptions

Financial assumptions for all energy system components are made in five-year time steps, and a complete list can be found in the Supplementary Material. All costs for technologies as well as

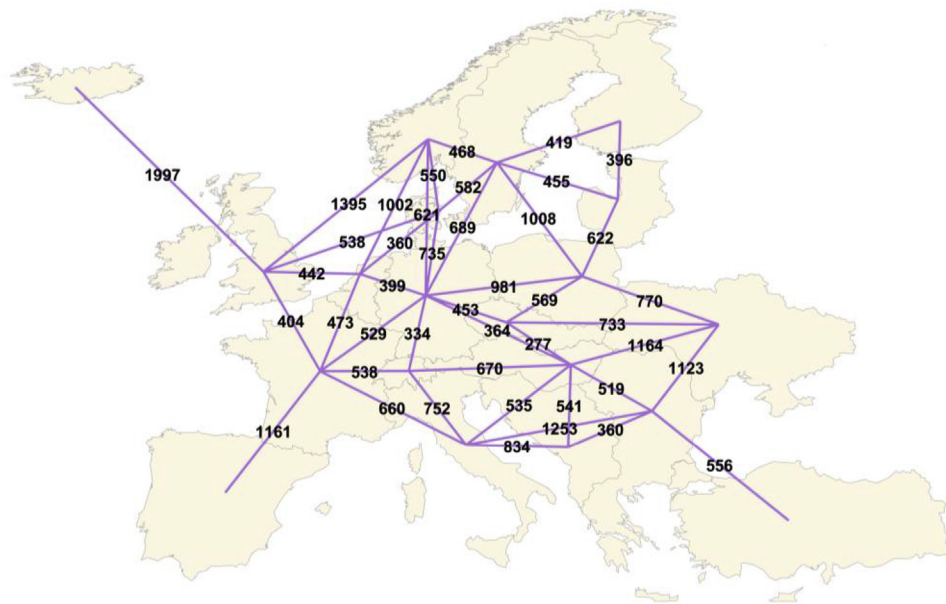

Fig. 7. Interconnections between regions and transmission line lengths (km).

efficiencies are assumed to be the same in all regions. Individual electricity prices for each country and region were calculated using the same method as [58,59] and extended to 2050 for the residential, commercial and industrial sectors. For all scenarios, the weighted average cost of capital (WACC) is set at 7%. An exception was made for residential PV prosumers, whereby WACC is set at 4% due to lower expectations of financial return. Excess prosumer electricity is assumed to be fed into the national grid and sold for a transfer price of 0.02 €/kWh. Before such transfer, the model mandates that prosumer demand for electricity is satisfied.

A synthetic hourly profile of electricity demand for each region, fully considering local time zones, was designed according to the methods described in Ref. [60]. The aggregated hourly profile for Europe is seen in Fig. 20. Total annual demands for each region are based on previous estimates performed for EU countries [61]. For Turkey, annual electricity demand for each five-year time step was taken from Ref. [62]. For all other countries and regions, annual demand values for 2015 were taken from IEA published data [63], and a growth rate of 1.2% per year was assumed, which is consistent with average growth projections for the EU 27+ [61]. Annual values for all regions and each time step are shown in the Supplementary Material.

Information concerning current installed capacities of all technologies was taken from Ref. [64]. The maximum installed capacities for all RE technologies as well as for pumped hydro energy storage were derived based on the method used in Bogdanov and Breyer [52]. For all other technologies, upper limits are not specified. Available biomass, waste and biogas fuels are assumed to be available evenly throughout the year. A synthetic profile of electricity demand was created based on data originating from Refs. [65,66].

2.4. Renewable resource potentials

Several sources were used to determine the renewable energy resource potentials for Europe. The generation profiles of wind power (onshore and offshore), solar PV (optimally tilted and single-axis tracking), and solar CSP were calculated according to methods described in Refs. [52,67]. Capacity factors for each of these technologies can be found in the Supplementary Material. In addition, Ref. [52] outlines how capacity factors are determined for both run-of-river and dam-based hydropower. These are based on precipitation data from the year 2005 as a normalised sum of precipitation throughout the country. Third, calculations concerning the geothermal energy potential were based on methodology detailed in Ref. [68]. Lastly, the potentials of biomass and waste potentials were divided into four main categories, as shown in Table 2. These potentials were taken mainly from year 2030 estimates provided by Ref. [69]. This source often gave two values for the potentials of various categories of biomass and waste, one for a reference scenario and another for a sustainability scenario. When a choice was available, values were taken from the latter. The sustainability scenario employed more strict criteria of sustainability to all

bioenergy sources. The main difference between the two scenarios is that the sustainability scenario includes compensation for GHG emissions related to indirect land use change. In addition, no use of energy crops was included in the current study despite a potential listed for both scenarios. Therefore, it must be acknowledged that greater amounts of biomass are practically available than the resource potentials of the current study lists. Moreover, due to a lack of data for some countries, values were also taken from Ref. [70] for Norway, Balkan West, Switzerland, Turkey and Cyprus, Ukraine and Moldova, and Iceland. Biomass costs were derived from data found at [70]. A gate fee of 100 €/t for solid wastes was assumed for most regions and years. The Supplementary Material provides the full range of assumptions concerning gate fees.

3. Results

The main modelling results of the least cost transition towards 100% RE are shown in Figs. 8–22. However, more extensive results are also shown in the Supplementary Material.

A virtually 100% RE power system was achieved by 2050 because the technical lifetime of a 1.6 GW nuclear power plant was not yet exceeded in this time period. However, a least cost transition pathway towards 100% RE was found for both the Regions and Area scenarios. These pathways show increasing relevance of wind energy, bioenergy and especially solar PV throughout the transition. Cumulative installed capacities for all technologies and both scenarios are shown in Fig. 8. In 2050, the share of installed capacity is 62% for solar PV, 17% for wind power, and 7% for hydropower in the Regions scenario. The respective values are 62%, 22%, and 7% in the Area scenario. The role of gas-based technologies appears to be higher in the Regions scenario. Fig. 9 shows electricity generation by fuel type throughout the transition for both scenarios. Generation of electricity increases in both scenarios to supply the steadily increasing demands of Europe over the transition. In 2050, solar PV accounts for 45% of generation, followed by 30% for wind, and 11% for hydropower in the Regions scenario. The respective values for the Area scenario are 41%, 37%, and 11%, again showing a slightly higher relevance of wind power in this scenario. Gas-based technologies are still seen in the energy system in both scenarios in 2050 despite the fact that fossil natural gas is not a significant fuel after 2025. This indicates that biomethane or synthetic methane gradually replace fossil natural gas over the transition. Gas-based technologies appear somewhat more relevant in the Regions scenario.

Fig. 10 and Table 3 show that the relevance of storage increases with the shares of variable renewable energy over the transition in both scenarios. Up to 2020, current installed capacities of PHES function as the main elements of storage for the system, and the output from PHES is relatively consistent throughout the transition. From 2025, batteries begin to have the highest output, and provide balance over shorter periods (hours to days). At this time, the shares of RE are 73% in the Regions scenario and 81% in the Area scenario. Concurrently, seasonal storage in the form of gas storage and TES appear in the Regions scenario. However, the relevance of seasonal storage is much lower in the Area scenario. It must be noted, however, that outputs of gas storage in Fig. 10 are defined as synthetic natural gas coming only from the PtG process. Storage outputs of fossil natural gas or biomethane are accounted separately as fossil gas or biomass/waste generation (see Fig. 9), and not as storage outputs *per se*. While these resources are seen as important aspects of seasonal flexibility, they are not defined as storage output in this study to highlight a key difference between a dispatchable resource and storage. To provide a contrast, outputs of dispatchable biomethane for 2050 are included as gas storage output in Fig. 11. Moreover, gas storage output of biomethane in

Table 2
Categories of biomass and waste resources.

Category	Resources
Solid waste	Used wood
Solid biomass waste	Sawmill residues, sawdust, industrial residues, black liquor
Solid biomass residues	Straw, agricultural residues, forestry residues
Biogas	Municipal bio-waste, animal excrement and waste, wastewater treatment sludge

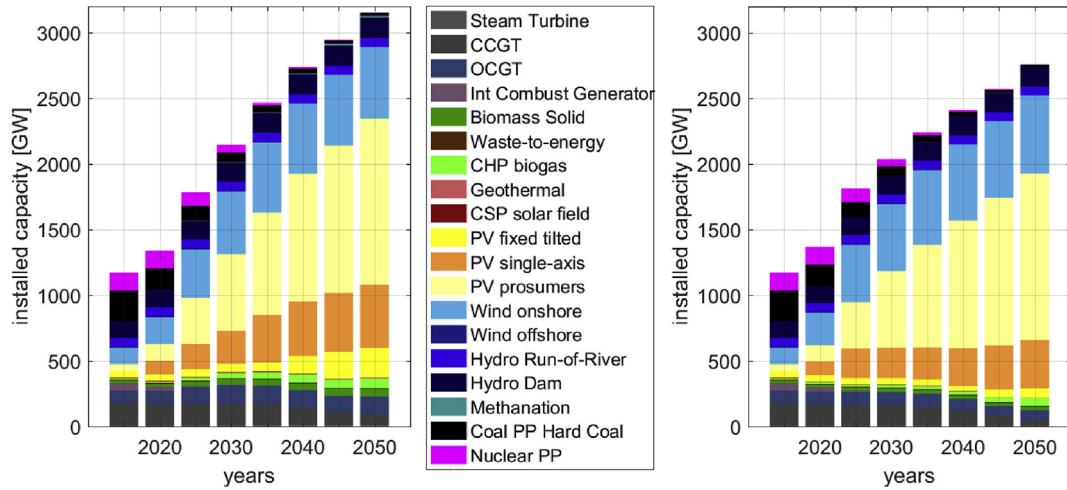

Fig. 8. Installed generation capacities from 2015 to 2050 for the Regions (left) and Area (right) scenarios. Adapted from Ref. [39].

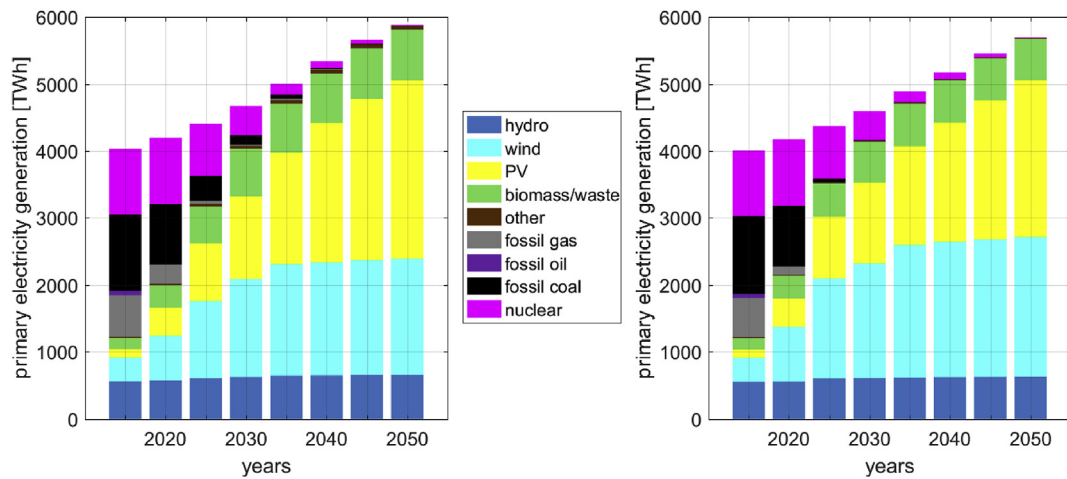

Fig. 9. Electricity generation by fuel from 2015 to 2050 for the Regions (left) and Area (right) scenarios.

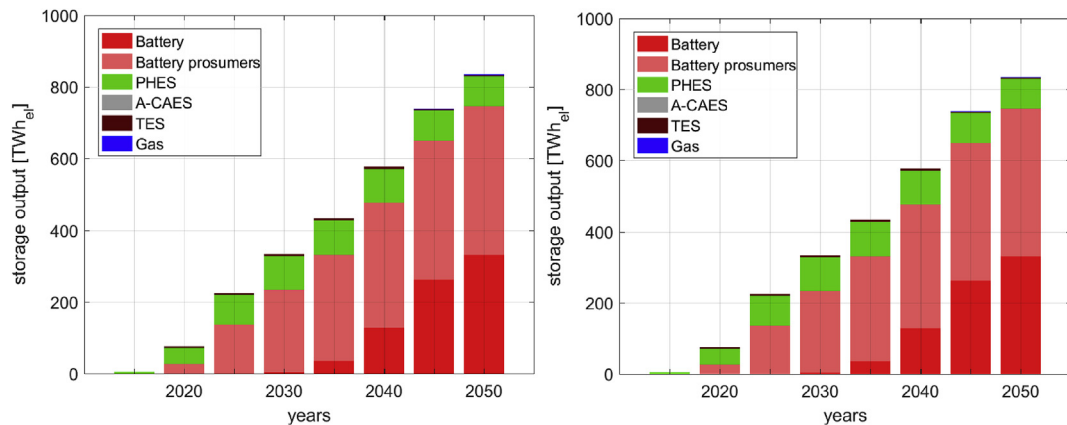

Fig. 10. Annual storage output of all technologies from 2015 to 2050 for the Regions (left) and Area (right) scenarios. Gas storage outputs do not include fossil natural gas or biomethane.

2050 was 536 TWh_{gas} and 392 TWh_{gas} for the Regions and Area scenarios, respectively. Overall, storage capacities and outputs are higher in the Regions scenario.

Lower installed capacities of storage and generation

technologies in the Area scenario are replaced by transmission interconnections. Fig. 12 shows the transmission capacities needed for 2015 (upper) and 2050 (lower) in the Area scenario. Current installed capacity is approximately 63 GW (15 HVDC and 48 HVAC),

Table 3
 Installed capacities of storage technologies (GWh except for Gas in TWh and PtG in GW_e) in the Regions and Area scenarios from 2015 to 2050. Adapted from Ref. [39].

Storage technology	Unit	Scenario	2015	2020	2025	2030	2035	2040	2045	2050
Gas	TWh	Regions	0	6	17	67	97	146	193	218
		Area	0	5	47	72	99	110	141	171
System batteries	GWh	Regions	0	4	33	78	354	794	1189	1465
		Area	0	0	0	10	103	376	798	1023
Prosumer batteries	GWh	Regions	0	100	529	920	1224	1486	1695	1854
		Area	0	100	529	920	1224	1486	1695	1854
PHES	GWh	Regions	388	388	392	392	392	392	396	396
		Area	388	388	388	388	388	388	388	388
TES	GWh	Regions	22	41	149	157	309	326	394	395
		Area	22	23	23	26	29	41	22	23
A-CAES	GWh	Regions	0	25	143	149	149	149	213	214
		Area	0	1	2	5	6	11	14	16
PtG	GW_e input	Regions	0	1	5	3	9	17	37	37
		Area	0	0	0	0	0	0	2	4

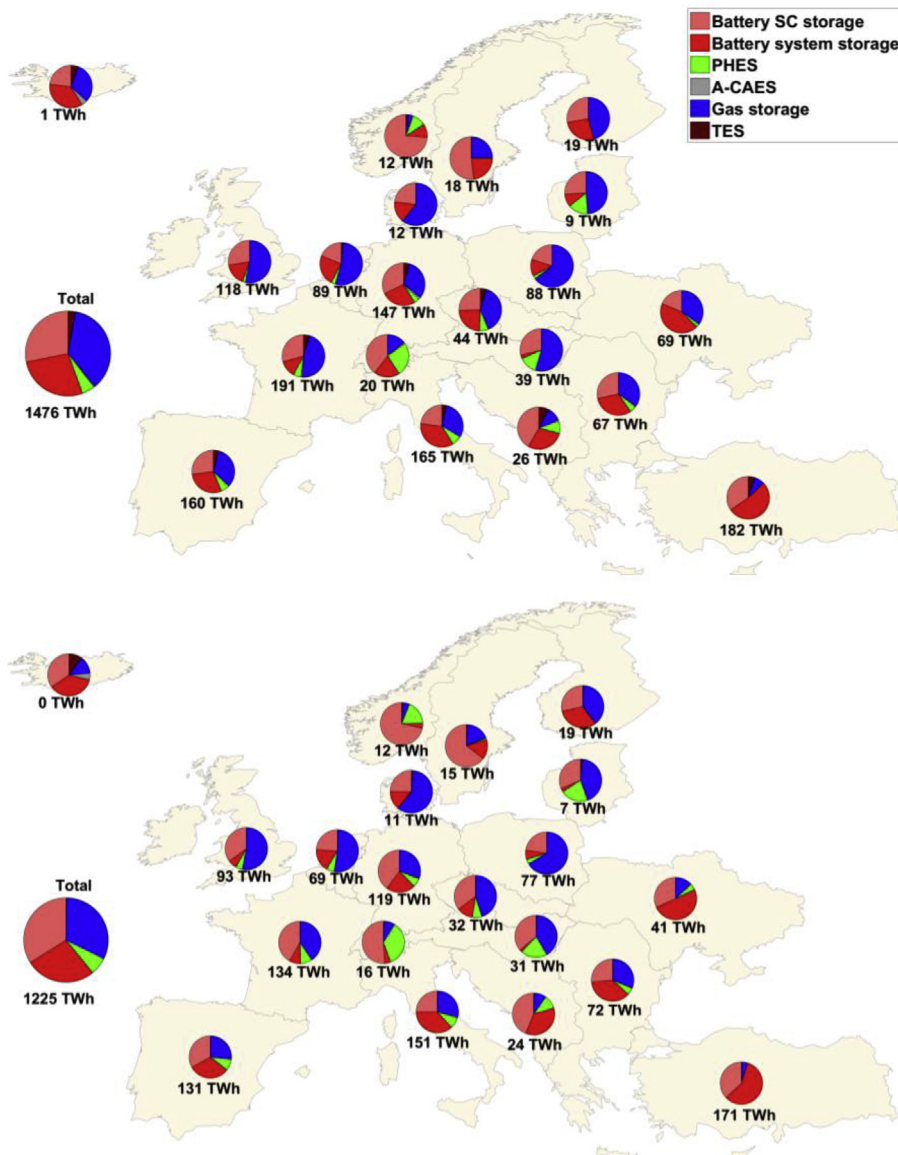

Fig. 11. Storage output for the Regions (upper) and Area (lower) scenarios for 2050. In this instance, output from storage is the sum of electrical, thermal and gas units to determine total storage output. Also, gas storage output includes dispatchable biomethane, in contrast to Fig. 10. Adapted from Ref. [39].

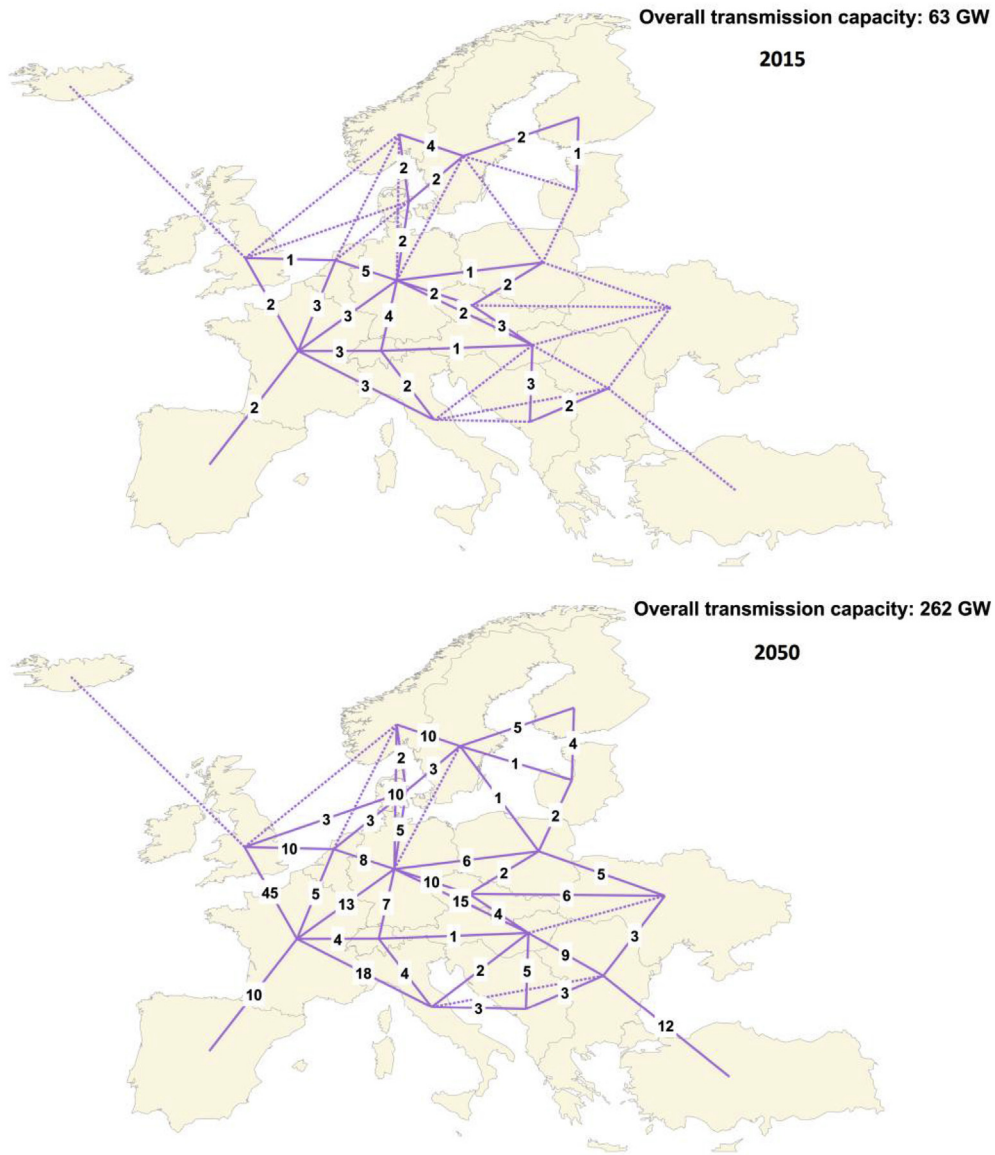

Fig. 12. Interconnection capacity (GW) in the Area scenario for 2015 (upper) and 2050 (lower).

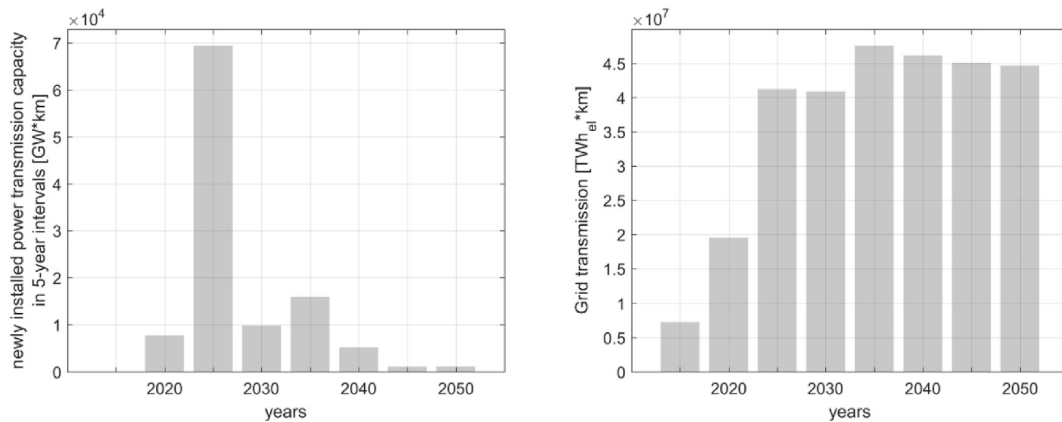

Fig. 13. Newly installed power transmission capacity (GW·km) and electrical energy transfer (TWh·km) as functions of line distance for the period of 2015–2050.

indicating the need for a more than fourfold expansion of capacity to 262 GW. This expansion would primarily occur in the five-year time step leading to 2025, as indicated in Fig. 13 (left). Total cumulative installed interconnection capacity as a function of distance is estimated at 34.2 TWkm in 2015, and increases approximately fourfold to 144.5 TWkm in 2050 in the Area scenario. The relevance of transferring electrical energy over long distances is also seen in Fig. 13 (right), with large increases seen in the periods leading up to 2030, upon which levels stabilise.

Overall grid utilisation appears to be more vibrant during times of higher electricity demand, especially winter months, as shown in Fig. 14. Further, grid utilisation appears to be rather positively related to higher levels of wind energy generation, and rather negatively related to higher levels of generation from solar PV, as shown in Fig. 15. During the period of April to October (days 100–300), wind energy generation tends to be relatively low during morning and evening hours (06:00–10:00 and 16:00–20:00). This corresponds to times of low solar PV generation and relatively higher peaks of consumption. The result is moderate reliance on grid-based electricity during these times.

An examination of the grid utilisation profiles of individual regions shows in more detail where grid energy is coming from, and where it is going to at different times of the year. In general, six types of profiles (Fig. 16) were found for net exporters of wind energy (e.g. BRI, DK), net exporters of solar PV energy (e.g. IT, IBE, TR), net exporters of wind and hydropower (e.g. NO), large

balancing regions (e.g. DE, FR, UA, PL), small balancing regions (e.g. AUH, BLT, BNL, IS) and net importers (e.g. CH, FI, SE, CRS, BKN-E, BKN-W). Excellent wind conditions in Britain and Ireland result in rather consistent export throughout the year, punctuated by relatively lower export during summer. By contrast, Italy shows export of solar PV during spring to autumn, followed by imports during the winter months. Norway shows rather regular export, indicating that the balancing function of wind and hydropower may be important on a pan-European level. Germany is an example of a large balancing region with highly fluctuating levels of import and export. Austria demonstrates more moderate fluctuations in imports and exports as a small balancing region. Lastly, Switzerland shows moderate and regular net imports primarily during times of high demand (winter months and morning and evening peaks) while at other times domestic resources suffice to satisfy demand. Overall annual grid transmissions of electricity are shown in Fig. 17 as well as the relative amount of net transmission as a percentage of domestic demand. High exporters are Britain and Ireland, Norway, Denmark, and the Baltic states (Estonia, Latvia and Lithuania) while high levels of import are seen in Sweden, Finland, Czech Republic and Slovakia, and Switzerland. Exchanges between regions in the Area scenario for 2050 can also be seen in Fig. 18. Comparative energy flow diagrams for the entire Area scenario in 2015 and 2050 are seen in Fig. 19.

An example of the interpretation of Fig. 18 is given for the cases of Germany (DE), Britain and Ireland (BRI), and Belgium, Netherlands and Luxembourg (BNL). DE trades with 8 other regions. Imports come from NO and FR, totaling 38% of trade. Exports go to AUH, CRS, CH, DK, BNL and SE, totaling 62% of trade. BRI trades with 3 other regions, and 100% of this trade is export to FR, DK and BNL. BNL trades with 5 other regions, and 100% of this trade is import from BRI, DE, DK, FR and NO.

The impact of prosumers on the overall profile of electricity demand from the centralised grid for both scenarios can be seen in Fig. 20. In total, consumption from the grid is reduced by 894 TWh annually (17%), and peak load is reduced by 52 GW (6%). Load reduction is more prominent during summer months, when prosumer solar PV generation is highest. As this is normally a time of low overall consumption, minimum load is reduced by 19% from 371 GW to 301 GW.

The defossilisation of the European energy system occurs relatively more quickly in the Area scenario (Fig. 21). Emissions decrease rapidly after 2020 in both scenarios with the phase out of coal-based power generation. Further reductions occur as fossil natural gas is replaced gradually by synthetic methane and bio-methane over time. Defossilisation is essentially complete by 2045 in the Regions scenario, and by 2035 in the Area scenario.

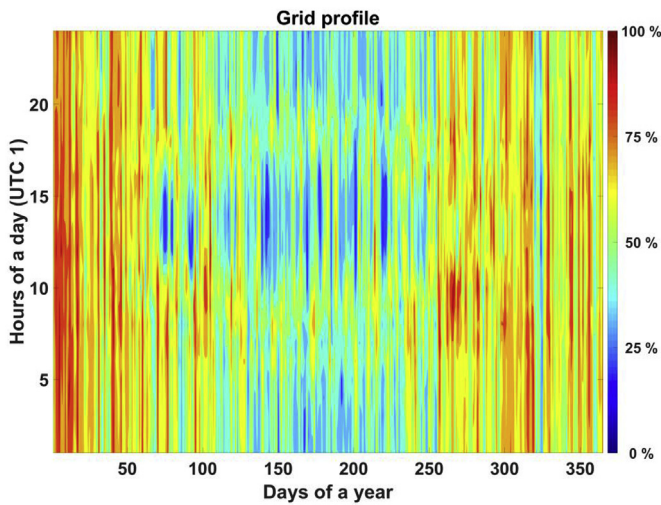

Fig. 14. Grid utilisation profile for the Area scenario in 2050.

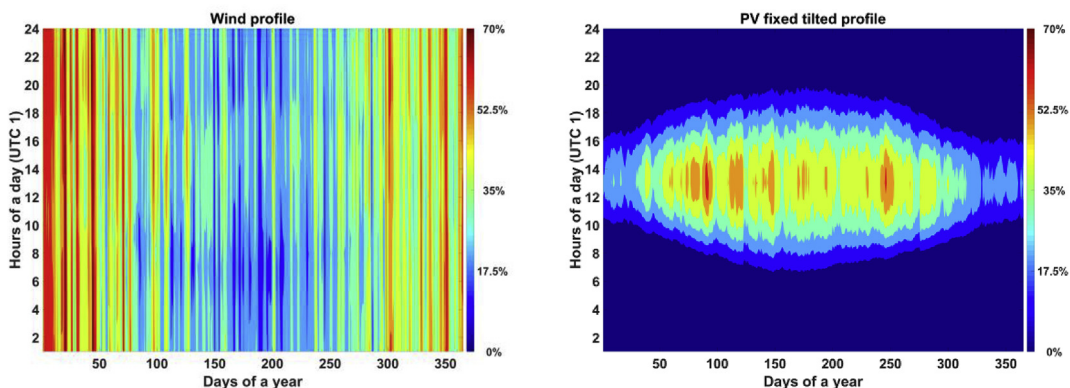

Fig. 15. Wind energy and solar PV generation profiles for the Area scenario in 2050.

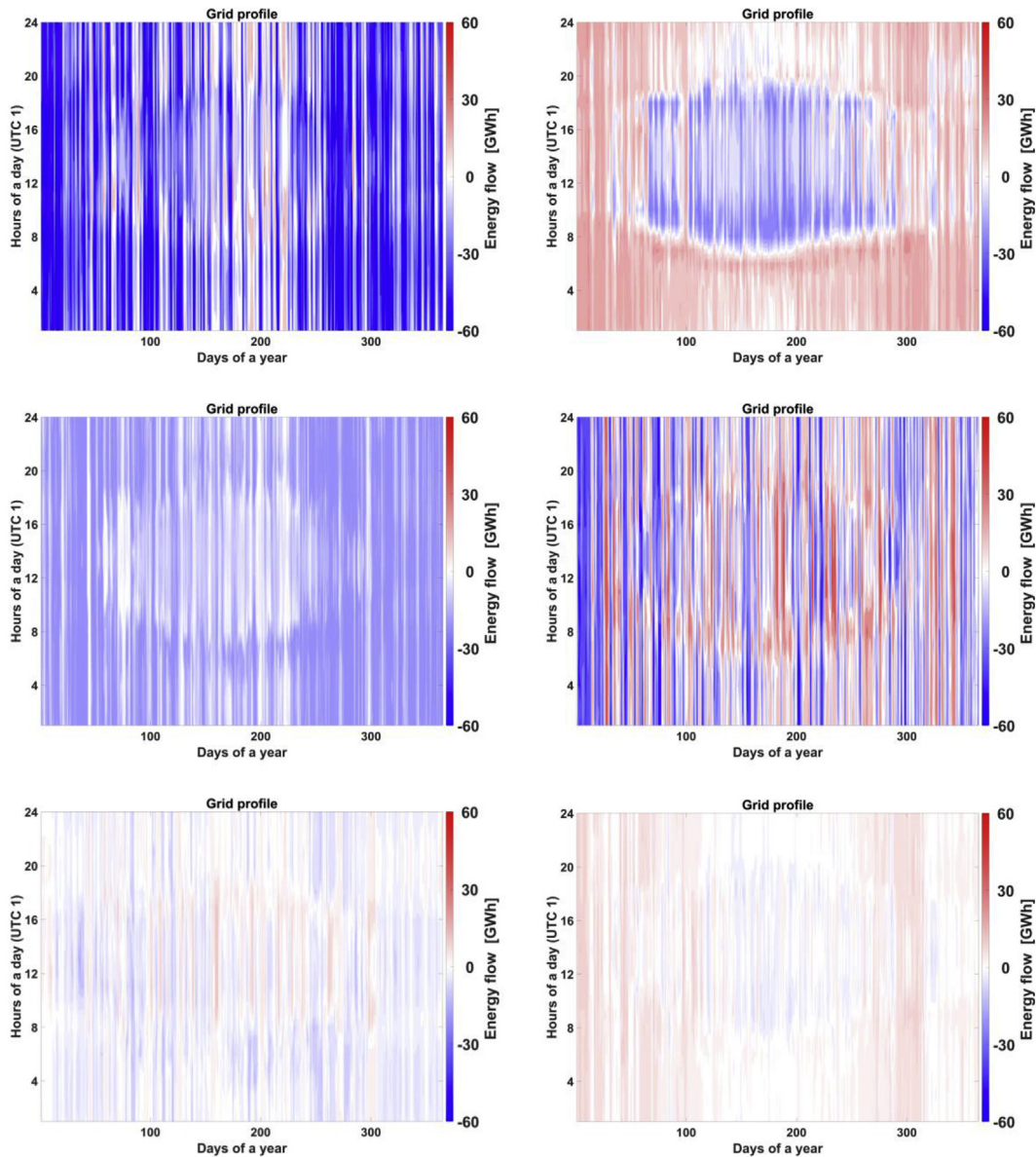

Fig. 16. Example profiles of six different types of grid use for net exporters of wind energy (BRI - upper left), net exporters of solar PV energy (IT - upper right), net exporters of wind and hydropower (NO - middle left), large balancing regions (DE - middle right), small balancing regions (AUH - lower left), and net importers (CH - lower right).

Fig. 22 shows the LCOE decreasing from 2015 to 2050 in both the regions (left) and Area (right) scenarios. During the transition, lower cost solar PV, wind energy and biomass-based generation replace higher cost coal and nuclear generation as these technologies come to their expected lifetimes. Lower LCOE over time is also due to decreasing capital expenditures, operational costs, fuel costs and emissions costs. Increases in transmission and grid costs in the Area scenario are offset by lower capital expenditures related to primary generation, storage and curtailment. Faster defossilisation in the Area scenario leads to more rapid cost reductions.

4. Discussion

According to the results of this study, an essentially 100% renewable power system is technologically and economically feasible for Europe before 2050. Such a system also adheres to the ambitious goals set out in the Paris Agreement [71] by achieving full

defossilisation of the power sector. A transition towards a more sustainable power system would be facilitated by the decreasing costs of renewable energy, flexible generation of sustainable power, electricity storage and power interconnections between the regions of Europe. Over the transition, emissions of harmful GHGs can be significantly reduced as coal power and other carbon intensive elements of the energy system are replaced by more sustainable technologies. This result is also consistent with several recent decisions made by EU Member States to phase out coal-based power generation in the short term (e.g. Austria, Finland, France, the Netherlands). Moreover, it is consistent with a recent announcement by EUR-ELECTRIC, the main union of European electricity companies, to no longer invest in new coal-fired power plants after 2020 [72].

4.1. Flexibility from generation and storage

Generation of electricity in Europe shows a tendency towards

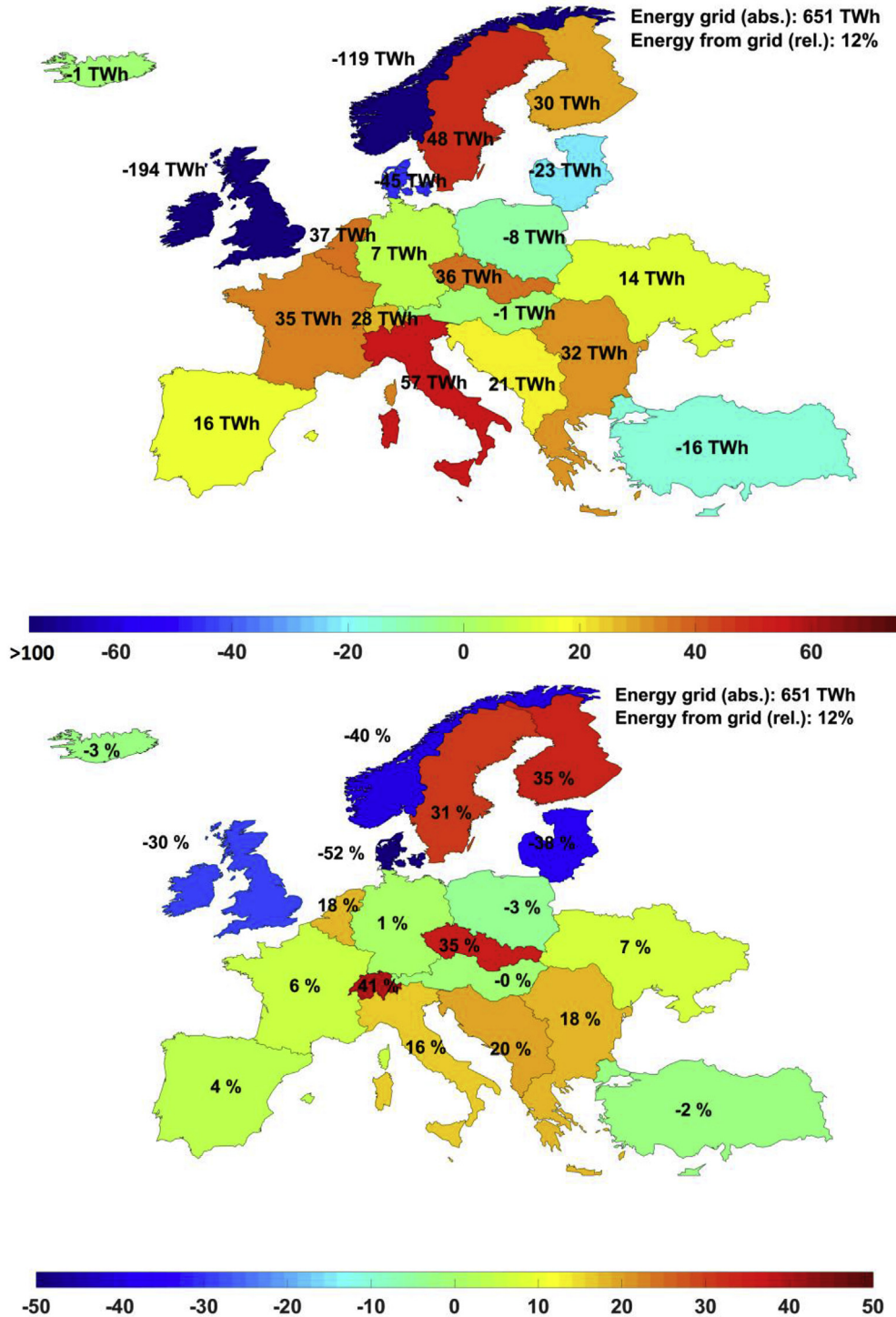

Fig. 17. Absolute annual transmission grid utilisation in TWh (upper) and relative annual grid utilisation as a percent of regional electricity demand (lower) in the Area scenario for the regions of Europe in 2050. Negative values represent net annual export, while positive values represent net annual import. Total grid transmission is 651 TWh, representing 12% of total electricity demand.

greater flexibility and complementarity in both scenarios. Hydro-power and pumped hydro energy storage maintain important functionality in the energy system to assist in balancing over short and long periods. In addition, biomass, biomethane and SNG are utilized as sustainable and dispatchable resources that can also complement the variability of solar PV and wind energy generation. What is more, the extent of wind and solar variability has recently

been challenged by the finding that main weather regimes minimize variability of these resources when considered in a pan-European context [73]. In essence, there is higher than expected complementarity between the winds of the north-west and the solar conditions in the south and south-east. The effects of reduced variability over broader geographic areas, particularly in relation to less need for installed generation capacities, storage and

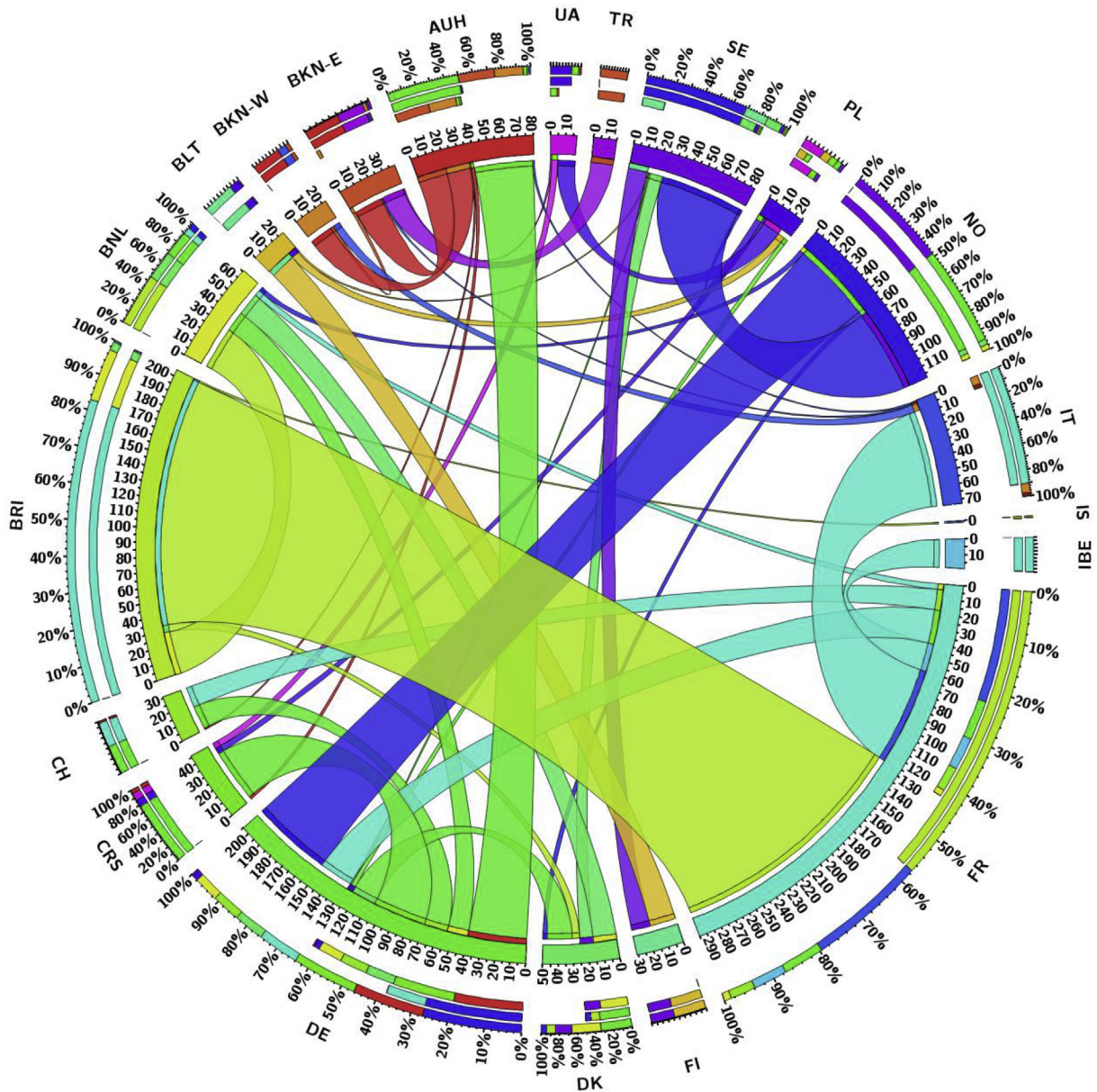

Fig. 18. Grid exchange between the regions of Europe for the Area scenario in 2050. Outer bars show relative exports, imports and overall totals for each region (from inside to out). Inner bars show absolute values of transmitted electricity for each colour-coded region (TWh). Central ribbons show the electricity exchanged from one region to another. Ends of the central ribbons indicate colour-coded regions of origin on one side, and regions of destination on the other. (For interpretation of the references to colour in this figure legend, the reader is referred to the Web version of this article.)

curtailment have been seen generally [74], and for Europe more specifically [75].

The roles of various storage technologies in the Regions and Area scenarios were described in detail in Ref. [39]. In both scenarios, the relevance of storage increases over time. Battery storage is the main technology employed, and is utilized on a short-term basis (hours to days). Results indicate a strong use of batteries by solar PV prosumers, and that system level solar PV influences the charging of system level batteries as well as PHES. For longer term and seasonal storage, TES, A-CAES and PtG technologies are employed, although to a much lower extent in the Area scenario. Instead, hydro dams and existing PHES are sufficient in the Area scenario to provide long-term balancing, along with the important flexibility offered by transmission interconnections. The results of this study are in line with others that suggest that storage

technologies will be essential once the level of RE supply reaches 80% of generation [76–78]. The results of this study also show that PHES and to a lesser extent system battery states of charge are also influenced by the profile of wind energy generation.

Fig. 19 shows that a small amount of battery discharge (approximately 1 TWh) goes to charge the PtG system. This represents roughly 10% of PtG charge power in the Area scenario. Such an effect was also seen in Ref. [74] for the case of India, whereby low overall demand, high battery storage SOC, and high solar PV electricity supply combine to create conditions that favour battery storage discharge to PtG especially in the night and early morning hours. This enables further battery charging the next day from solar PV, and more regular operation of the PtG system. It is also a way of ensuring sufficient seasonal gas storage from lower overall PtG capacity. These each contribute to lower overall costs. However, the

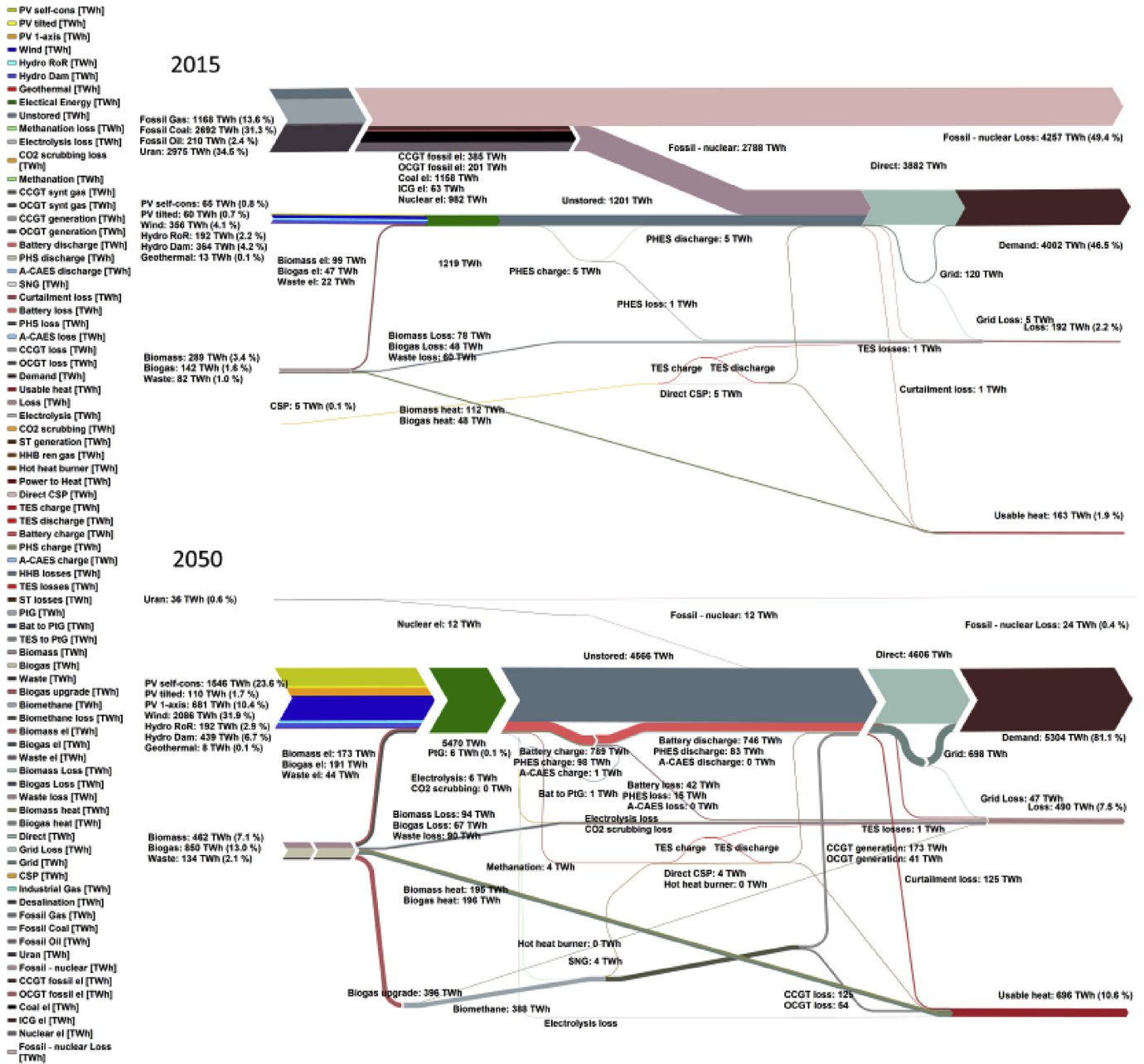

Fig. 19. Energy flow diagrams for the Area scenario in 2015 (upper) and 2050 (lower).

impact of this effect was very limited in Area scenario results due to the wider range of balancing options in Europe compared to India, and less solar PV in the system because of the observed complementary nature of wind and solar PV. It is, though, an indication of how energy storage technologies can work in parallel.

The Area scenario shows approximately 17% less storage output (1225 TWh vs 1476 TWh). There were also noticeable differences in total installed capacities, with the highest relative change in installed capacity seen in reduced system level batteries (30% lower compared to the Regions scenario) and the highest absolute capacity change in gas storage (21% lower compared to the Regions scenario). In total, the Regions scenario showed 218 TWh of installed gas storage capacity compared to 171 TWh in the Area scenario. These values are well below the current levels reported for Europe of 1000 TWh [79]. However, the values in this study are

derived from the needs of the power sector only. It would be expected that gas storage would play a greater role in balancing the seasonal needs for heat, and possibly for the transport and industry sectors. Along with noticeable installed gas-based generation capacity in both scenarios in 2050 (219 GW in the Regions and 123 GW in the Area scenario), this suggests that the role of gas-based technology and infrastructure will remain significant in Europe due to its flexibility, and there is little risk of stranded investments in current assets. While fossil natural gas leaves the system over the transition, it is replaced by sustainably produced biomethane and synthetic natural gas.

4.2. Flexibility from interconnections

A main source of flexibility in the Area scenario is grid exchange

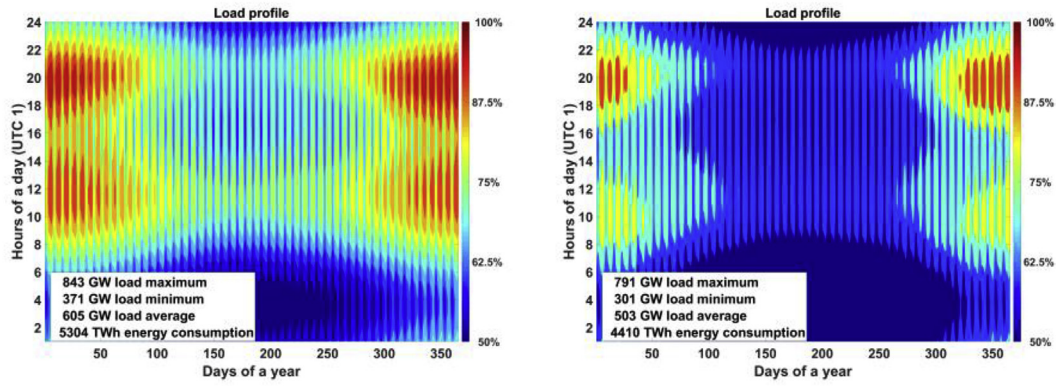

Fig. 20. Load profile of central grid without (left) and with (right) consideration of the impacts of prosumer self-consumption and storage.

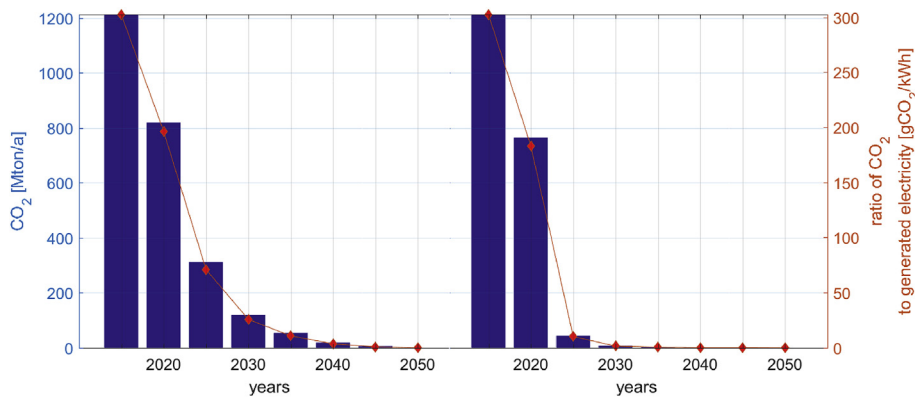

Fig. 21. GHG emissions in the Regions (left) and Area (right) scenarios for the period of 2015–2050. Adapted from Ref. [39].

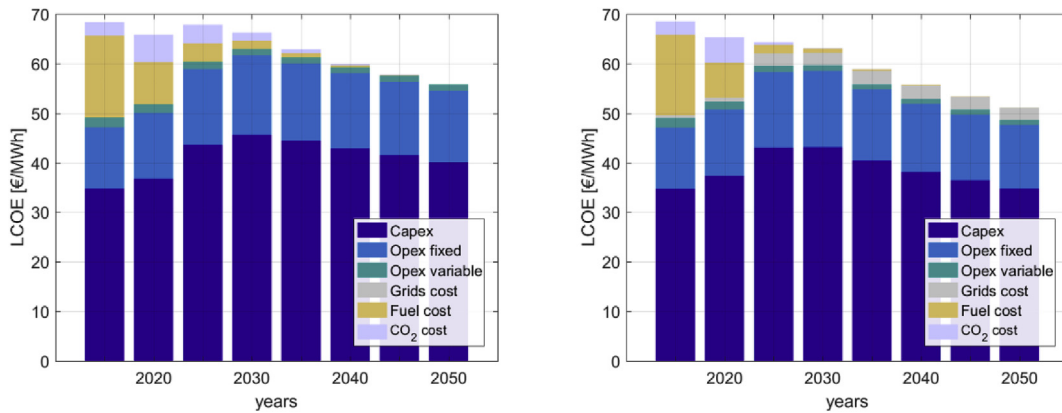

Fig. 22. Levelised cost of electricity and breakdown in cost categories for the Regions (left) and Area (right) scenarios. Grid costs are not accounted for the Regions scenario, as there were no assumed transmission interconnections with neighbouring countries in this scenario.

between regions, amounting to a total of 12% of end-user demand in Europe. As such, the capacity of transmission interconnection would need to grow approximately fourfold, from the current level of 63 GW to 262 GW in 2050. Furthermore, much of this transmission line length would need to be installed before 2025 (see Fig. 13). It appears that the highest levels of interconnections are found around areas rich in wind (e.g. Britain and Ireland, Norway, and Denmark), rich in solar resources (e.g. Italy, Turkey, Iberia), or with extensive hydropower resources (e.g. Norway). Furthermore, interconnections appear important to densely populated and industrial areas, (e.g. German, France).

The results of this study are similar to those reported in Refs. [36,48], which both reported on the significant role of interconnections to provide balance in the European energy system. However, the former found a more than threefold higher need for total grid capacity (503 TWkm vs. approximately 144 TWkm in the Area scenario) in an optimised energy system. In the latter, overall capacity was as high as 331 TWkm, with power transmission representing up to 30% of annual demand depending on the scenario (compared to 12% in the Area scenario). However, the scenario that produced the highest values (VRE100-S20W80) featured all generation from solar and wind as well as a very high ratio of wind to

solar (80:20). One reason for lower capacities seen in the Area scenario could be the relatively high share of solar PV prosumers seen in this study, along with high installed capacities of prosumer batteries. Such distinction of PV prosumers is rarely seen in modelling studies, but the impact on results is that solar PV prosumers with batteries may not require as much power from a centralised grid. Results of this study indicate that maximum load could be reduced by 6%, and total energy flow on grids reduced by 17% by solar PV prosumers (residential, commercial and industrial entities). In addition, it is also important that the full set of generation and storage options are modelled, in particular hydropower and bioenergy, since this inclusion of technological options reduces the demand for wind energy and therefore also the demand for larger scale power transmission interconnection capacities. Finally, caution must be exercised when comparing studies that have fundamental differences in scenario design. The total number of regions or nodes, and where interconnections occur has a noticeable effect on the sum of total grid capacity, and would also account for some of the deviations observed between studies.

To mitigate possible sources of objection to overhead transmission lines, this study assumed that 70% of new HVDC lines would be underground or undersea cables, with the balance being overhead lines. Costs were adjusted accordingly. However, this assumption does not take full account of the important social constraints surrounding transmission interconnections. While it is beyond the scope of this study to discuss this matter beyond technical feasibility and economic competitiveness, it must be acknowledged that the social acceptance of such high levels of transmission interconnection must be part of the overall discourse on energy-related issues in Europe.

4.3. Cost savings

The total annualised costs of the system in 2050 are 302 b€/a for the Regions scenario and 276 b€/a for the Area scenario. This suggests annual savings of 9% or 26 b€/a for the Area scenario. These values compare to about 274 b€/a in 2015, suggesting that the most cost competitive of the 100% RE scenarios (Area) is not significantly greater in cost than the current system, but for a 38% larger electricity demand. This result is in line with other research that suggests that 100% RE systems of the future may be only marginally higher in cost than current systems [80–82]. In addition, Ref. [42] observed only a small increase in electricity costs for a 100% RE system on an LCOE basis, and that the lowest overall system cost was achieved in a system whereby decentralised battery storage could buffer solar PV production peaks and reduce distribution grid costs significantly. Further, Ref. [51] estimates that the least cost transition pathway to decarbonisation would result in an LCOE increase from 67 €/MWh for the current system to 90 €/MWh in 2050. However, this study does not make use of any bioenergy resources, which are rather abundant in many parts of Europe and the PV and battery cost assumptions seem to be very conservative. Lastly, Ref. [28] projects that overall annualised energy system costs would be only 13% higher than the current system when the heating and mobility sectors are included.

However, the authors remind that the calculated costs of the current system do not include significant external costs related to GHGs and airborne pollution. Therefore, comparing costs of current and future systems is one thing. Comparing the overall benefits of a 100% RE system with the current system is quite another. The higher level of sustainability and greater respect for known planetary boundaries of 100% RE energy systems has been noted [27]. The cost of anything must be viewed in relation to its overall benefits. Eliminating such things as slavery, child labour or unsafe working conditions had a cost that may have seemed higher than

the alternative. However, when the least cost alternative is unacceptable, other sources of value must be more strongly weighted. The same must be remembered for energy systems.

In terms of levelised cost of electricity, values reduce from a current level of 69 €/MWh to 56 €/MWh in the Regions scenario in 2050 and 51 €/MWh in the Area scenario. These results are similar to other transition studies to 2050 using the LUT Energy System Transition model [62,74,83–86], which show a range of values from 35 €/MWh to 65 €/MWh, and show that Area scenarios are lower in cost than Regions scenarios. Several of these studies also suggest further integration of the desalination sectors and non-energy gas demands into the energy system could result in further savings on an LCOE basis, which would be a potential area of further study for Europe to better identify the benefit of sector coupling. The impact of sector integration (power, heat and transport) on modelling results for Europe was also seen in Ref. [28], which described such sector coupling as having a stronger impact on overall cost reduction than transmission grid expansion.

Others simulations of the 2050 European energy system suggest that LCOE values may range between 88 €/MWh and 121 €/MWh for 100% renewable energy systems [36,48,51]. However, these studies also reported far lower installed capacities of batteries, and did not include any special categorisation of solar PV prosumers. For these reasons, centralised grids take on a more prominent role in these studies. In Refs. [36,48], grids expand approximately tenfold from current levels, while this study reports only a fourfold increase, at least partly due to the effects of prosumers. Moreover, the other studies used conservative 2050 cost assumption for batteries, which ranged from 111 €/kWh [36] to 289 €/kWh [51] and 300 €/kWh [48]. These must be compared to the assumption used in this study of 75 €/kWh, which seem more reasonable given that current cost estimates see battery pack costs of 100 €/kWh by as soon as 2025 [87]. This is driven by the significant learning rate of batteries [18] and the very high estimated demand in the transport sector for battery electric vehicles [88]. In the end, significantly lower costs of storage and markedly lower costs of interconnections contributed to lower LCOE.

Two studies that examined scenarios that resulted in 95% GHG emissions for Europe also offer comparable results [89,90]. The former analysed three scenarios for 30 regions that were: not interconnected, optimally interconnected, and a compromise between the two extremes. Optimal interconnection was nine times the current line volume, or 286 TWkm. However, the authors remind that such a high level would likely result in social acceptance issues, and so included the compromise scenario whereby line volume increased fourfold to 125 TWkm, comparable to the value of 144 TWkm in the Area scenario. The former study concluded that the compromise solution would require increased storage, particularly battery storage, to balance supply and demand. This additional battery storage is seen in the Area scenario mostly in the form of prosumer batteries, which decrease the need for interconnection. The latter study, in a series of sensitivity analyses related to the former, indicated that greater sensitivity to battery storage costs would be found with lower volumes of interconnection. They showed that battery storage would roughly double with a halving of battery capital cost. Their base cost of batteries was 145 €/kWh, or almost double the assumption used in the present study. Therefore, it is not surprising that the present study showed greater battery storage and a lower overall optimum transmission line volume. It is also not surprising based on the fact that the current study has modelled prosumer decisions quite differently. In other models, prosumers are either not modelled at all, not modelled separately, or their decisions are part of overall system-level optimisation. In this study, prosumers are modelled separately, and make decisions based on their own overall cost of electricity

(including storage) compared to the consumer price of electricity. This less altruistic behaviour should be anticipated for the future as the cost of prosumer solar PV has already reached grid parity in several market segments [59], and the cost of solar PV and battery storage for prosumers is expected to decrease in the near future [17]. It has also been shown that the uptake of various forms of renewable energy, including solar PV, will increase as prosumer costs approach retail price parity [91]. The results of this study show that such levels of prosumerism may have great impacts on the energy system as a whole, and it is recommended that future modelling of Europe include such consideration of prosumers.

4.4. Policies and support in a heterogeneous Energy Union

Although Europe intends to increase RE substantially, progress in individual countries varies substantially. France, on the one hand, still has a very high share of nuclear power, with the aim to decrease it. Poland, on the other hand, still has a high share of coal, but has decided to increase its wind energy share more substantially [92]. Individual countries need to establish concrete financial tools for a full energy transition, establish nuclear and coal phase out plans, increase CO₂ prices, reduce fossil fuel subsidies and define promotion schemes to support RE. Most EU countries still apply a feed-in tariff for financing RE technologies [93–95]. However, countries are beginning to apply more market-based systems and tendering schemes, which increase uncertainties for investors, might reduce competition, favour large utilities and increase financial costs [96]. Germany also recently changed towards a tendering system [97]. However, feed-in tariffs may have the highest policy effectiveness compared to other instruments [97,98]. In a German context, relatively high system flexibility can significantly decrease the need for market-based support [96]. But, high system flexibility is realised through relatively low must-run capacity requirements. As must-run capacity is much more sensitive to the higher market impacts of feed-in tariffs [96], support schemes should match the given context. Barriers stem from the fact that a full transition towards RE changes markets for fossil and nuclear energy companies, which typically operate more must-run capacity. Fossil fuel lobbying influences and distorts effective policy support for a full transition [97,99].

Fig. 2 shows that a range of supportive policies are currently employed throughout Europe. At the same time, Fig. 1 indicates that those policies have been working to increase the relevance of renewable energy in Europe. The diversity of support instruments employed throughout Europe could be some indication that support is best developed at a national or regional level instead of having a single preferred instrument for the whole of Europe. At the same time, governance is critically needed to make the European Union successful. It appears that the Energy Union needs to rally around some kind of common policy goal that is meaningful and effective on a pan-European level. In essence, the Energy Union may need a “red line” that is based on scientific reality rather than political compromise [4]. The results of this study indicate that the goal of decarbonisation in the power sector is feasible and economically competitive by 2050 for all regions of Europe. At the same time, strong-arm tactics may threaten the very union that is needed to achieve European goals. In this manner, there may be a parallel between policy and technological development. It appears that a hybrid, centralised and decentralised SuperSmart Grid is the preferred option for the European Energy Union. The same may be true for SuperSmart Policy. It may be best for Member States and cooperating regions to decide for themselves what kinds of support work best for given contexts, while still working towards specific, pan-European goals.

For the energy transition and GHG emission reductions, there is

substantial technological innovation needed in all energy sectors. Further developments in technological learning curves within the RE sector will bring generation and system costs down. Innovative digital technologies are required to provide management tools for smart grids, which balance variable RE supply and demand. Technological innovation for more energy storage is also needed. Excess RE requires storage and is used for different purposes as heating, cooling or transportation. Innovative storage technologies bridge the gap between the individual sectors of energy, heating and transportation. To these can be added non-energy sectors such as industrial feedstock demand and water desalination [100]. New technologies like power-to-liquids or hydrogen technology cannot only store variable RE, but products can also be used as fuel for ships, planes and long distance transportation. Innovative batteries are needed to bring costs down for electric mobility and prosumers, i.e. decentralised PV energy produced and stored. Lastly, pan-European transmission grids will require substantial investment in energy infrastructure.

4.5. Smartgrids and supergrids

This study confirms that the decentralised Smartgrid vision of EUROSOLAR and the centralised Supergrid vision of DESERTEC each have merits, and that the SuperSmart Grid hybrid approach proposed by Ref. [6] may result in the most benefits for Europe. The DESERTEC approach also advocates extension of the grid into the solar-rich regions of the Middle East and North Africa (MENA). An even broader extension of the European energy system was simulated for Europe, Eurasia and MENA for 2030 [101], and confirmed that lower costs and increased flexibility could be achieved through such integration. However, these benefits are comparatively small to those seen in the Area scenario of this study, and must be weighed against the increased potential risk that greater grid extension implies. Further study is needed to confirm if further grid integration would be beneficial in the context of 2050.

Further study is also needed to confirm the extent to which sector integration would affect the results of this study, which is limited to the power sector. As stated previously, integrating the heat and transport sector has been shown to affect optimal levels of interconnection [28]. In addition, trade of RE-based synthetic fuels between different parts of the world may offer still more economic opportunities [102], and could also impact the optimal configuration of the European energy system.

5. Conclusions

Given the assumptions used in this study, a 100% RE system appears achievable for Europe by 2050. Such a system is a cost competitive solution for Europe, which also adheres to the goals set out in the Paris Agreement. Notably, more rapid defossilisation and greater cost savings can be achieved through the establishment of increased interconnections between the regions of Europe. Further development of a European Energy Union seems fruitful. However, to achieve such a system, supportive policies must be further enhanced to ensure effective governance. Such governance appears to be lacking at the moment, but not necessarily for lack of effort. Both technologically and in terms of energy and climate policy, Europe must be viewed not only from the top-down, but national and regional contexts must be properly considered. A SuperSmart solution seems appropriate.

This study takes into account important elements of the European power sector in manners that are not always included in modelling studies. First, prosumers of solar PV energy with batteries may have an impact on the overall amount of energy that flows to a centralised grid. Up to 6% less peak interconnection capacity

would be needed when considering the impacts of prosumers, leading to lower costs. Future modelling should therefore take into account that prosumers, motivated by the low cost of solar PV and batteries, can generate significant amounts of their own electricity that will reduce the need for large, centralised grids. Studies that do not take the latest cost trends for these technologies in relation to the retail price of electricity in different regions into account may exaggerate dependence on central grids to some extent and show higher grid-related costs.

Second, there are natural areas of energy cooperation between some EU Member States that are better reflected in the planning of regions used in this study. These include the Baltic states of Estonia, Latvia and Lithuania; the Balkan states; Austria/Hungary, Czech Republic/Slovakia; Spain/Portugal; and UK/Ireland. Of particular note is the complementarity in renewable resource supply between the windy regions of the North-West and the sunny regions of the South and South East. New dynamics of import and export between regions should be expected. Cooperation within and between these regions of Europe can result in benefits for all.

Next, the combination of flexible generation, interconnections and energy storage is shown to lead to reliable, affordable and sustainable power in an hourly resolution for an entire year. Flexible generation can be achieved by moderately increased levels of hydropower and capacities of dispatchable bioenergy and sustainable gas-based generation (SNG, biomethane and biogas). This will also ensure that past and current investments in bioenergy and gas-based technologies and infrastructure will not be stranded. Interconnections, up to four times the current European level (to 144 TWkm), between the regions can reduce the need for generation and storage capacities by exploiting the natural complementarities between solar PV generation in the south, and wind generation in the northwest that result in lower variability in overall electricity generation. At the same time, energy storage will be expanded significantly, with batteries primarily supplying short-term storage, and TES, A-CAES and PtG providing seasonal balance. Lastly, this study confirms that an economically viable transition towards sustainability can be achieved in Europe through more accurate incorporation of the trends towards the low costs of RE generation and storage. To accomplish such a transition towards sustainability, policy and support instruments should be chosen that work best at a regional level while still adhering to clearly defined goals of a European Energy Union.

Declarations of interest

None.

Acknowledgements

The authors gratefully acknowledge the public financing of Tekes, the Finnish Funding Agency for Innovation, for the 'Neo-Carbon Energy' project under the number 40101/14, and Stiftung Mercator GmbH and Deutsche Bundesstiftung Umwelt supporting the Energy Watch Group, which helped to realise parts of this study. The authors thank Arman Aghahosseini for support in diagram creation.

Appendix A. Supplementary data

Supplementary data to this article can be found online at <https://doi.org/10.1016/j.renene.2019.02.077>.

References

- [1] European Commission, Energy Union and Climate, 2017 [Online]. Available: https://ec.europa.eu/commission/priorities/energy-union-and-climate_en. (Accessed 5 October 2018).
- [2] A. Costa, P. Sanchez, E. Macron, M. Canete, "Lisbon Declaration," Lisbon, 2018 [Online]. Available: https://ec.europa.eu/info/sites/info/files/lisbon_declaration_energyinterconnections_final.pdf. (Accessed 5 September 2018).
- [3] European Commission, EU Budget: Commission Proposes Increased Funding to Invest in Connecting Europeans with High-Performance Infrastructure, Brussels, 2018 [Online]. Available: http://europa.eu/rapid/press-release_IP-18-4029_en.htm. (Accessed 5 September 2018).
- [4] F. Simon, EU Strikes Early Morning Deal on Energy Governance Bill, *Euractiv*, 2018 [Online]. Available: <https://www.euractiv.com/section/energy/news/eu-strikes-early-morning-deal-on-energy-governance-bill/>. (Accessed 3 August 2018).
- [5] European Commission, "A Clean Planet for All: A European Strategic Long-Term Vision for a Prosperous, Modern, Competitive and Climate Neutral Economy," Brussels, 2018 [Online]. Available: https://ec.europa.eu/clima/policies/strategies/2050_en. (Accessed 3 December 2018).
- [6] J. Lilliestam, S. Hanger, Shades of green: centralisation, decentralisation and controversy among European renewable electricity visions, *Energy Res. Soc. Sci.* 17 (2016) 20–29.
- [7] EUROSOLAR, EUROSOLAR, 2018 [Online]. Available: <https://www.eurosolar.de/en/>. (Accessed 11 September 2018).
- [8] P. Godron, J. Neubarth, M. Soyah, "Desert Power: Getting Connected," Munich, 2014 [Online]. Available: <https://doi.org/10.1016/j.energy.2017.01.115>. (Accessed 6 September 2018).
- [9] I. Pontenagel, Das großprojekt EEG statt Desertec, *Solarzeitalter* 4 (2009) 8–11.
- [10] C. Kronabel, S. Jungebluth, I. Campino, Global "Energiewende": the DESERTEC Concept for Climate Protection and Development, CEP European Publishers, Hamburg, 2014.
- [11] A. Battaglini, J. Lilliestam, A. Haas, A. Patt, Development of SuperSmart Grids for a more efficient utilisation of electricity from renewable sources, *J. Clean. Prod.* 17 (10) (2009) 911–918.
- [12] C. Turmes, M. Rivasi, Stronger Together: the EU's Energy and Climate Governance, *Euractiv*, 2017 [Online]. Available: <https://www.euractiv.com/section/energy/opinion/stronger-together-the-eus-energy-and-climate-governance/>. (Accessed 3 August 2018).
- [13] European Commission, "Renewable Energy," Brussels, 2018 [Online]. Available: <https://ec.europa.eu/energy/en/topics/renewable-energy>. (Accessed 11 September 2018).
- [14] Eurostat, Short Assessment of Renewable Energy Sources (SHARES), Luxembourg, 2017 [Online]. Available: <https://ec.europa.eu/eurostat/documents/2995521/8612324/8-25012018-AP-EN.pdf/9d28caef-1961-4dd1-a901-af18f121fb2d>. (Accessed 5 September 2017).
- [15] RES Legal, Legal Sources on Renewable Energy, 2017 [Online]. Available: <http://www.res-legal.eu/>. (Accessed 15 September 2017).
- [16] International Renewable Energy Agency, Statistics Time Series, Abu Dhabi, 2018 [Online]. Available: <http://resourcereina.irena.org/gateway/dashboard/>. (Accessed 2 August 2018).
- [17] M. Ram, M. Child, A. Aghahosseini, D. Bogdanov, A. Lohrmann, C. Breyer, A comparative analysis of electricity generation costs from renewable, fossil fuel and nuclear sources in G20 countries for the period 2015–2030, *J. Clean. Prod.* 199 (2018) 687–704.
- [18] O. Schmidt, I. Hawkes, A. Gambhir, A. Staffell, The future cost of electrical energy storage based on experience rates, *Nat. Energy* 2 (2017).
- [19] J. Farfan, C. Breyer, Aging of European power plant infrastructure as an opportunity to evolve towards sustainability, *Int. J. Hydrogen Energy* 42 (28) (2016) 18081–18091.
- [20] J. Eom, J. Edmonds, V. Krey, N. Johnson, T. Longden, G. Luderer, K. Riahi, D.P. Van Vuuren, The impact of near-term climate policy choices on technology and emission transition pathways, *Technol. Forecast. Soc. Change* 90 (2015) 73–88.
- [21] F. Pearce, Industry meltdown: is the era of nuclear power coming to an end? *Yale Environ.* 360 (2017) [Online]. Available: <http://e360.yale.edu/features/industry-meltdown-is-era-of-nuclear-power-coming-to-an-end>. (Accessed 10 May 2017).
- [22] S. Wheatley, B. Sovacool, D. Sornette, Of Disasters and dragon kings: a statistical analysis of nuclear power incidents & accidents, *Risk Anal.* 1 (2015) 1–24.
- [23] M. Ram, M. Child, A. Aghahosseini, D. Bogdanov, A. Poleva, Comparing Electricity Production Costs of Renewables to Fossil and Nuclear Power Plants in G20 Countries, Hamburg, 2017 [Online]. Available: https://www.researchgate.net/publication/318217005_Comparing_electricity_production_costs_of_renewables_to_fossil_and_nuclear_power_plants_in_G20_countries. (Accessed 10 June 2018).
- [24] Science advice for policy by european academies, in: Novel Carbon Capture and Utilisation Technologies, Berlin, 2018 [Online]. Available: <https://www.sapea.info/wp-content/uploads/CCU-report-proof3-for-23-May.pdf>. (Accessed 5 August 2018).
- [25] T.W. Brown, T. Bischof-Niemz, K. Blok, C. Breyer, H. Lund, B.V. Mathiesen, Response to 'Burden of proof: a comprehensive review of the feasibility of 100% renewable-electricity systems, *Renew. Sustain. Energy Rev.* 92 (2018) 834–847.
- [26] M.Z. Jacobson, Abstracts of 30 Peer-Reviewed Published Journal Articles Supporting the Result that the Electric Grid Can Stay Stable with Electricity

- provided by 100% or Near-100% Renewable Energy, 2017 [Online]. Available: <http://web.stanford.edu/group/efmh/jacobson/Articles/I/CombiningRenew/100PercentPaperAbstracts.pdf>. (Accessed 8 September 2017).
- [27] M. Child, O. Koskinen, L. Linnanen, C. Breyer, Sustainability guardrails for energy scenarios of the global energy transition, *Renew. Sustain. Energy Rev.* 91 (2018) 321–334.
- [28] T. Brown, D. Schlachtberger, A. Kies, S. Schramm, M. Greiner, Synergies of sector coupling and transmission extension in a cost-optimised, highly renewable European energy system, *Energy* 160 (2018) 720–739.
- [29] M.G. Rasmussen, G.B. Andresen, M. Greiner, Storage and balancing synergies in a fully or highly renewable pan-European power system, *Energy Policy* 51 (2012) 642–651.
- [30] S. Becker, R. a. Rodriguez, G.B. Andresen, M.O.W. Greiner, S. Schramm, What can transmission do for a fully renewable Europe?, in: Proceedings of the 8th SDEWES Conference, Dubrovnik, 2014.
- [31] S. Becker, R.A. Rodriguez, G.B. Andresen, S. Schramm, M. Greiner, Transmission grid extensions during the build-up of a fully renewable pan-European electricity supply, *Energy* 64 (2014) 404–418.
- [32] K. Schaber, F. Steinke, T. Hamacher, Transmission grid extensions for the integration of variable renewable energies in Europe: who benefits where? *Energy Policy* 43 (2012) 123–135.
- [33] K. Schaber, F. Steinke, P. Mühlich, T. Hamacher, Parametric study of variable renewable energy integration in Europe: advantages and costs of transmission grid extensions, *Energy Policy* 42 (2012) 498–508.
- [34] G.B. Andresen, M.G. Rasmussen, R.A. Rodriguez, S. Becker, M. Greiner, Fundamental properties of and transition to a fully renewable pan-European power system, *EPJ Web Conf.* 33 (2012) 4001.
- [35] R.A. Rodriguez, S. Becker, G.B. Andresen, D. Heide, M. Greiner, Transmission needs across a fully renewable European power system, *Renew. Energy* 63 (2014) 467–476.
- [36] C. Bussar, P. Stöcker, Z. Cai, L. Moraes, D. Magnor, P. Wiernes, N. van Bracht, A. Moser, D.U. Sauer, Large-scale integration of renewable energies and impact on storage demand in a European renewable power system of 2050-Sensitivity study, *J. Energy Storage* 6 (2016) 1–10.
- [37] C. Breyer, D. Bogdanov, A. Aghahosseini, A. Gulagi, M. Child, A. Oyewo, J. Farfan, K. Sadovskaia, P. Vainikka, Solar photovoltaics demand for the global energy transition in the power sector, *Prog. Photovoltaics Res. Appl.* 26 (2017) 505–523. <https://doi.org/10.1002/ptp.2950>.
- [38] D. Connolly, H. Lund, B.V. Mathiesen, S. Werner, B. Möller, U. Persson, T. Boermans, D. Trier, P.A. Østergaard, S. Nielsen, Heat roadmap Europe: combining district heating with heat savings to decarbonise the EU energy system, *Energy Policy* 65 (2014) 475–489.
- [39] M. Child, D. Bogdanov, C. Breyer, The role of storage technologies for the transition to a 100% renewable energy system in Europe, *Energy Proced.* 155 (2018) 44–60.
- [40] D. Heide, L. von Bremen, M. Greiner, C. Hoffmann, M. Speckmann, S. Bofinger, Seasonal optimal mix of wind and solar power in a future, highly renewable Europe, *Renew. Energy* 35 (11) (2010) 2483–2489.
- [41] D. Heide, M. Greiner, L. von Bremen, C. Hoffmann, Reduced storage and balancing needs in a fully renewable European power system with excess wind and solar power generation, *Renew. Energy* 36 (9) (2011) 2515–2523.
- [42] F. Steinke, P. Wolfrum, C. Hoffmann, Grid vs. storage in a 100% renewable Europe, *Renew. Energy* 50 (2013) 826–832.
- [43] M. Huber, D. Dimkova, T. Hamacher, Integration of wind and solar power in Europe: assessment of flexibility requirements, *Energy* 69 (2014) 236–246.
- [44] C. Bussar, P. Stöcker, Z. Cai, L. Moraes, D. Magnor, P. Wiernes, N. van Bracht, A. Moser, D.U. Sauer, Large-scale integration of renewable energies and impact on storage demand in a European renewable power system of 2050-Sensitivity study, *Energy Proced.* 73 (2015) 145–153.
- [45] O.H. Hohmeyer, S. Bohm, Trends toward 100% renewable electricity supply in Germany and Europe: a paradigm shift in energy policies, *Wiley Interdiscip. Rev. Energy Environ.* 4 (1) (2015) 74–97.
- [46] R.A. Rodriguez, S. Becker, M. Greiner, Cost-optimal design of a simplified, highly renewable pan-European electricity system, *Energy* 83 (2015) 658–668.
- [47] D.P. Schlachtberger, S. Becker, S. Schramm, M. Greiner, Backup flexibility classes in emerging large-scale renewable electricity systems, *Energy Convers. Manag.* 125 (2016) 336–346.
- [48] H.C. Gils, Y. Scholz, T. Pregar, D. Luca de Tena, D. Heide, Integrated modelling of variable renewable energy-based power supply in Europe, *Energy* 123 (2017) 173–188.
- [49] E.H. Eriksen, L.J. Schwenk-Nebbe, B. Tranberg, T. Brown, M. Greiner, Optimal heterogeneity in a simplified highly renewable European electricity system, *Energy* 133 (2017) 913–928.
- [50] M. Raunbak, T. Zeyer, K. Zhu, M. Greiner, Principal mismatch patterns across a simplified highly renewable European electricity network, *Energies* 10 (12) (2017) 33–38.
- [51] G. Pleßmann, P. Blechinger, How to meet EU GHG emission reduction targets? A model based decarbonization pathway for Europe's electricity supply system until 2050, *Energy Strateg. Rev.* 15 (2017) 19–32.
- [52] D. Bogdanov, C. Breyer, North-East Asian Super Grid for 100% renewable energy supply: optimal mix of energy technologies for electricity, gas and heat supply options, *Energy Convers. Manag.* 112 (2016) 176–190.
- [53] C. Turmes, A sustainable & interconnected Mediterranean region, in: A Manifesto by 17 Members of the European Parliament, 2017 [Online]. Available: <http://energyblog.claudeturmes.lu/wp-content/uploads/sites/3/2017/02/MEP-Manifesto-for-regional-cooperation-in-the-Mediterranean.pdf>. (Accessed 5 October 2017).
- [54] ENTSO-E, TYNDP 2016 Scenario Development Report, 2016. Brussels.
- [55] ABB, HVDC References, 2018 [Online]. Available: <https://new.abb.com/systems/hvdc/references>. (Accessed 12 January 2018).
- [56] A.G. Siemens, High-voltage Direct Current Transmission, 2017 [Online]. Available: https://www.energy.siemens.com/co/pool/hq/power-transmission/HVDC/HVDC-Classic/HVDC-Classic_Transmission_References_en.pdf. (Accessed 12 January 2018).
- [57] Interconnexio France-Angleterre, Assets, 2018 [Online]. Available: <http://ifa1interconnector.com/about-us/assets/>. (Accessed 12 January 2018).
- [58] A. Gerlach, C. Breyer, C. Werner, Impact of financing cost on global grid-parity dynamics till 2030, in: 29th European Photovoltaic Solar Energy Conference, Amsterdam, 2014.
- [59] C. Breyer, A. Gerlach, Global overview on grid-parity, *Prog. Photovoltaics Res. Appl.* 21 (1) (2013) 121–136.
- [60] A. Toktarova, “Long-term Load Forecasting in High Resolution for All Countries Globally,” Master’s Thesis, School of Energy Systems, Lappeenranta University of Technology, 2017 [Online]. Available: <https://lutpub.lut.fi/handle/10024/143609>. (Accessed 4 June 2018).
- [61] European Commission, “EU Energy, Transport and GHG Emissions: Trends to 2050,” Brussels, 2013 [Online]. Available: <https://ec.europa.eu/transport/sites/transport/files/media/publications/doc/trends-to-2050-update-2013.pdf>. (Accessed 3 May 2018).
- [62] A. Kilickaplan, D. Bogdanov, O.P. Bülent, C. Breyer, An energy transition pathway for Turkey to achieve 100% renewable energy powered electricity, desalination and non-energetic industrial gas demand sectors by 2050, *Sol. Energy* 158 (2017) 218–235.
- [63] International Energy Agency, “Statistics,” Paris, 2018 [Online]. Available: <https://www.iea.org/statistics/?country=WORLD&year=2016&category=KeyIndicators&indicator=TPESbySource&mode=chart&categoryBrowse=false&dataTable=BALANCES&showDataTable=false>. (Accessed 12 January 2018).
- [64] J. Farfan, C. Breyer, Structural changes of global power generation capacity towards sustainability and the risk of stranded investments supported by a sustainability indicator, *J. Clean. Prod.* 141 (2016) 370–384.
- [65] International Energy Agency, “Key World Energy Statistics 2015,” Statistics, Paris, 2015 [Online]. Available: http://www.oecd-ilibrary.org/energy/http://www.oecd-ilibrary.org/energy/key-world-energy-statistics-2015_key_eng_stat-2015-en. (Accessed 15 October 2016).
- [66] International Energy Agency, “Eastern Europe, Caucasus and Central Asia: Energy Policies beyond IEA Countries,” Paris, 2015 [Online]. Available: https://www.iea.org/publications/freepublications/publication/IDR_EasternEuropeCaucasus_2015.pdf. (Accessed 6 October 2016).
- [67] S. Afanasyeva, D. Bogdanov, C. Breyer, Relevance of PV with single-axis tracking for energy scenarios, *Sol. Energy* 173 (2018) 173–191.
- [68] L. Barbosa, D. Bogdanov, P. Vainikka, C. Breyer, Hydro, wind and solar power as a base for a 100% Renewable Energy supply for South and Central America, *PLoS One* 12 (3) (2017), e0173820.
- [69] B. Elbersen, I. Startisky, G. Hengeveld, M.-J. Schelhaas, H. Naëff, Atlas of EU Biomass Potentials, 2012 [Online]. Available: https://ec.europa.eu/energy/intelligent/projects/sites/iee-projects/files/projects/documents/biomass_futures_atlas_of_technical_and_economic_biomass_potential_en.pdf. (Accessed 2 January 2018).
- [70] K. Bunzel, V. Zeller, M. Buchhorn, F. Griem, D. Thrän, Regionale und globale räumliche Verteilung von Biomassepotenzialen, German Biomass Research Center, Leipzig, 2009.
- [71] UNFCCC conference of the parties, in: Adoption of the Paris Agreement. Proposal by the President, 2015, New York.
- [72] EURELECTRIC, European Electricity Sector Gears up for the Energy Transition, *Press release*, Brussels, 2017 [Online]. Available: <http://www.eurelectric.org/media/318381/2017-04-05-eurelectric-press-release-on-energy-transition-statement-launch-of-cep-papers-embargo-9-am-542017.pdf>. (Accessed 9 August 2017).
- [73] C.M. Grams, R. Beerli, S. Pfenninger, I. Staffell, H. Wernli, Balancing Europe's wind-power output through spatial deployment informed by weather regimes, *Nat. Clim. Change* (2017) 557–562.
- [74] A. Gulagi, D. Bogdanov, C. Breyer, The role of storage technologies in energy transition pathways towards achieving a fully sustainable energy system for India, *J. Energy Storage* 17 (2018) 525–539.
- [75] C. Breyer, M. Child, O. Koskinen, D. Bogdanov, A low cost power system for Europe based on renewable electricity, in: European Utility Week, Barcelona, November 15–17, 2016.
- [76] D. Bogdanov, C. Breyer, The role of solar energy towards 100 % renewable power supply for Israel: integrating solar PV , wind energy , CSP and storages, in: Proceedings of the 19th Sede Boqer Symposium on Solar Electricity Production, Sede Boqer, 2015. February 23–25.
- [77] S. Weitmeyer, D. Kleinhans, T. Vogt, C. Agert, Integration of Renewable Energy Sources in future power systems: the role of storage, *Renew. Energy* 75 (2015) 14–20.
- [78] P.D. Lund, J. Lindgren, J. Mikkola, J. Salpakari, Review of energy system flexibility measures to enable high levels of variable renewable electricity, *Renew. Sustain. Energy Rev.* 45 (2015) 785–807.
- [79] European Commission, The Role of Gas Storage in Internal Market and in

- Ensuring Security of Supply, Brussels, 2015 [Online]. Available: <https://ec.europa.eu/energy/sites/ener/files/documents/REPORT-GasStorage-20150728.pdf>. (Accessed 18 August 2018).
- [80] H. Lund, B.V. Mathiesen, Energy system analysis of 100% renewable energy systems—The case of Denmark in years 2030 and 2050, *Energy* 34 (5) (2009) 524–531.
- [81] D. Connolly, B.V. Mathiesen, A technical and economic analysis of one potential pathway to a 100% renewable energy system, *Int. J. Sustain. Energy Plan. Manag.* 1 (2014) 7–28.
- [82] B.V. Mathiesen, H. Lund, D. Connolly, H. Wenzel, P.A. Ostergaard, B. Möller, S. Nielsen, I. Ridjan, P. KarnOe, K. Sperling, F.K. Hvelplund, Smart Energy Systems for coherent 100% renewable energy and transport solutions, *Appl. Energy* 145 (2015) 139–154.
- [83] M. Child, C. Breyer, D. Bogdanov, H.-J. Fell, The role of storage technologies for the transition to a 100% renewable energy system in Ukraine, *Energy Proced.* 135 (2017) 410–423.
- [84] U. Caldera, D. Bogdanov, S. Afanasyeva, C. Breyer, Role of seawater desalination in the management of an integrated water and 100% renewable energy based power sector in Saudi arabia, *Water* 10 (2018) 3.
- [85] N. Ghorbani, A. Aghahosseini, C. Breyer, Transition towards a 100% renewable energy system and the role of storage technologies: a case study of Iran, *Energy Proced.* 135 (2017) 23–36.
- [86] A.S. Oyewo, A. Aghahosseini, C. Breyer, Pathways to a fully sustainable electricity supply for Nigeria in the mid-term future, *Energy Convers. Manag.* 178 (2018) 44–64.
- [87] UBS, Will solar, batteries and electric cars re-shape the electricity system?, in: Q-Series®: Global Utilities, Autos & Chemicals, 2014 [Online]. Available: <http://knowledge.neri.org.nz/assets/uploads/files/270acd1V0tO4LmKMZuB3.pdf>. (Accessed 11 November 2015).
- [88] DNV GL, Energy Transition Outlook 2017, 2017, p. 11 [Online]. Available: <https://www.dnvgl.com/energy/publications/podcast/pc-eto-2017.html>. (Accessed September 2018).
- [89] D.P. Schlachtberger, T. Brown, S. Schramm, M. Greiner, The benefits of cooperation in a highly renewable European electricity network, *Energy* 134 (2017) 469–481.
- [90] D.P. Schlachtberger, T. Brown, M. Schäfer, S. Schramm, M. Greiner, Cost optimal scenarios of a future highly renewable European electricity system: exploring the influence of weather data, cost parameters and policy constraints, *Energy* 163 (2018) 100–114.
- [91] P.D. Lund, Energy policy planning near grid parity using a price-driven technology penetration model, *Technol. Forecast. Soc. Change* 90 (PB) (2015) 389–399.
- [92] A. Barteczko, P. Goraj, Exclusive: PGE Picks Baltic Wind over Nuclear as Poland Embraces Green Power, Reuters, Environment, 2018 [Online]. Available: <https://www.reuters.com/article/us-poland-energy/exclusive-pge-picks-baltic-wind-over-nuclear-as-poland-embraces-green-power-idUSKBN1IBOLE>. (Accessed 29 August 2018).
- [93] D. Jacobs, Renewable Energy Policy Convergence in the Eu: the Evolution of Feed-In Tariffs in Germany, Spain and France, Ashgate Publishing Ltd, Farnham, 2012.
- [94] L. Dusonchet, E. Telaretti, Comparative economic analysis of support policies for solar PV in the most representative EU countries, *Renew. Sustain. Energy Rev.* 42 (2015) 986–998.
- [95] P. Lehmann, E. Gawel, Why should support schemes for renewable electricity complement the EU emissions trading scheme? *Energy Policy* 52 (2013) 597–607.
- [96] J. Winkler, A. Gaio, B. Pfluger, M. Ragwitz, Impact of renewables on electricity markets - do support schemes matter? *Energy Policy* 93 (2016) 157–167.
- [97] C. Kemfert, Germany must go back to its low-carbon future, *Nature* 549 (2017) 26–27.
- [98] M. Ragwitz, S. Steinhilber, B. Breitschopf, G. Resch, C. Panzer, A. Ortner, S. Busch, M. Rathmann, C. Klessmann, C. Nabe, I. de Lovinfosse, K. Neuhoff, R. Boyd, M. Junginger, R. Hoefnagels, N. Cusumano, A. Lorenzoni, J. Burgers, M. Boots, I. Konstantinaviciute, B. Weöres, “RE-Shaping : Shaping an Effective and Efficient European Renewable Energy Market,” Karlsruhe, 2012 [Online]. Available: http://www.reshaping-res-policy.eu/downloads/FinalreportRE-Shaping_Druck_D23.pdf. (Accessed 16 August 2018).
- [99] C. Kemfert, *The Battle about Electricity*, Murmann Verlag, Hamburg, 2013.
- [100] U. Caldera, D. Bogdanov, C. Breyer, Local cost of seawater RO desalination based on solar PV and wind energy: a global estimate, *Desalination* 385 (2016) 207–216.
- [101] D. Bogdanov, O. Koskinen, A. Aghahosseini, C. Breyer, Integrated renewable energy based power system for Europe, Eurasia and MENA regions, in: 5th International Energy and Sustainability Conference, June 30–July 1, 2016.
- [102] M. Fasihi, D. Bogdanov, C. Breyer, Long-Term hydrocarbon trade options for the maghreb region and europe—renewable energy based synthetic fuels for a net zero emissions world, *Sustainability* 9 (2) (2017). Article number 306.