

University of Latvia (Ed.); Professional Association of Project Managers (Latvia) (Ed.)

Proceedings

Project Management Development – Practice and Perspectives: First International Scientific Conference on Project Management in the Baltic Countries. February 8-9, 2012, Riga, University of Latvia. Conference Proceedings

Provided in Cooperation with:

Research Institute of the Project Management, University of Latvia

Suggested Citation: University of Latvia (Ed.); Professional Association of Project Managers (Latvia) (Ed.) (2012) : Project Management Development – Practice and Perspectives: First International Scientific Conference on Project Management in the Baltic Countries. February 8-9, 2012, Riga, University of Latvia. Conference Proceedings, ISBN 978-9984-49-470-8, University of Latvia, Research Institute of the Project Management, Riga

This Version is available at:

<https://hdl.handle.net/10419/197308>

Standard-Nutzungsbedingungen:

Die Dokumente auf EconStor dürfen zu eigenen wissenschaftlichen Zwecken und zum Privatgebrauch gespeichert und kopiert werden.

Sie dürfen die Dokumente nicht für öffentliche oder kommerzielle Zwecke vervielfältigen, öffentlich ausstellen, öffentlich zugänglich machen, vertreiben oder anderweitig nutzen.

Sofern die Verfasser die Dokumente unter Open-Content-Lizenzen (insbesondere CC-Lizenzen) zur Verfügung gestellt haben sollten, gelten abweichend von diesen Nutzungsbedingungen die in der dort genannten Lizenz gewährten Nutzungsrechte.

Terms of use:

Documents in EconStor may be saved and copied for your personal and scholarly purposes.

You are not to copy documents for public or commercial purposes, to exhibit the documents publicly, to make them publicly available on the internet, or to distribute or otherwise use the documents in public.

If the documents have been made available under an Open Content Licence (especially Creative Commons Licences), you may exercise further usage rights as specified in the indicated licence.



Project Management Development – Practice and Perspectives

First International Scientific Conference on Project Management in the Baltic Countries

February 8-9, 2012, Riga, University of Latvia

CONFERENCE PROCEEDINGS

Conference is organized by the Faculty of Economics and Management, University of Latvia, in cooperation with the Professional Association of Project Managers and supported by the Baltic-German University Liason Office with funds from the German Academic Exchange Service (DAAD), "Latvijas Mobilais Telefons" Ltd. and "Aldaris" Ltd.



February 8-9, 2012
Riga, University of Latvia



LATVIJAS
UNIVERSITĀTE
UNIVERSITY OF LATVIA
ANNO 1919

EVF

**Ekonomikas
un vadības fakultāte**

First International Scientific Conference on Project Management in the Baltic Countries “Project Management Development – Practice and Perspectives”: Riga, Latvia, February 8-9, 2012. Conference Proceedings. Riga: University of Latvia, 2012, 244 p.

Scientific Committee – Editorial Board

Prof. Dr.oec. Žaneta Ilmete (University of Latvia, President of Professional Association of Project Managers, Latvia) **Chair**

Prof. Dr. Arvi Kuura (University of Tartu, Estonia) **Co-Chair**

Prof. Dr. Dr. h.c. mult. Peter J. A. Reusch (Dortmund University of Applied Science and Arts, Germany) **Co-Chair**

Prof. Dr. Signe Bāliņa (University of Latvia, President of Latvian Information and Communications Technology Association, Latvia)

Prof. Dr. Edgar Below (Reims Management School, France)

Dr. oec. Juris Binde (President of “Latvian Mobile Telephone” Ltd., Latvia)

Prof. Dr. Florian E. Dorrenberg (South Westphalia University of Applied Sciences, Germany)

M. Eng, CPP, MPD. Adesh Jain (First Assessor IPMA, Director of Centre for Excellence in Project Management, India)

Prof. Dr. Jerzy Kisielnicki (Warsaw University, Poland)

Prof. Dr. Juris Krūmiņš (University of Latvia, Latvia, Latvia)

Prof. Dr. Michael J. Littman (Buffalo State University of New York, USA)

Prof. Dr. Katrin Löhr (Dortmund University of Applied Science and Arts, Germany)

Prof. Dr. José Ramon Otegi Olaso (Head of EuroMPM at the University of the Basque Country in Bilbao, Spain)

Prof. Dr. Māris Purgailis (Dean of Faculty of Economics and Management, University of Latvia, Latvia)

Prof. Dr. Biruta Sloka (University of Latvia, Latvia)

Prof. Dr. Wolfgang Tysiak (Dortmund University of Applied Science and Arts, Germany)

Prof. Dr. Inese Vorončuka (University of Latvia, Latvia)

Prof. Dr. Carsten Wolff (Dortmund University of Applied Science and Arts, Germany)

Project coordinators: **MSc.proj.mgmt. Silvija Bruņa** and **MSc.proj.mgmt. Emīls Pūlmanis**

Design: **Andra Liepiņa** and **Emīls Pūlmanis**

Layout: **Sandra Neidere** and **Ludis Neiders**

The publication contents are the sole responsibility of the publication author
and it does not reflect the Baltic-German University Liaison Office

© University of Latvia, 2012

© Professional Association of Project Managers, 2012

ISBN 978-9984-49-470-8



CONTENTS

Christopher Brink, Martin Peters, Sabine Sachweh. Improved Software Project Management through the Use of Product Lines	5
Trung Quang Dinh, Hilmar Þór Hilmarsson. How Can Private Companies Use the Financial Services and Risk Mitigation Instruments Offered by Export Credit Agencies in Emerging Markets?	14
István Fekete. Does Lost Time Cost You Money and Create High Risk?	26
Hêriş Golpîra. Making Comparison between FMCDM and MCDM to Define Project Activities Weights	35
Hêriş Golpîra. Real Project Success Measurement by Using Data Envelopment Analysis	43
Alejandro Gutiérrez, José Ramón Otegi. The Use of Application Frameworks in Software Development Projects: A System Dynamics Model	49
Hilmar Þór Hilmarsson. Public-Private Partnerships and Clean Energy Projects in Emerging Market Economies: How Can Companies from Small States Manage the Risks? ...	61
Žaneta Ilmete, Silvija Bruņa, Emīls Pūlmanis. Increasing the Level of Organizational Competence in Project Management – The New Project Work Development Perspective	75
Olita Janberga. EU Funds Project Controls	82
Laura Kersule, Biruta Sloka. Company Reputation – Long Term Project for Company Successful Development	92
Marius R. Khan, Can Elmali, Christian Reimann, Sabine Sachweh, Carsten Wolff. Support of Collaborative Work through the ANOTO- and Multi-Touch Technology	102
György Kocziszky. Experiences of the Utilization of EU Funds in Hungary	114
Irina Lando. The Experience of Implementation of the Innovational Teaching Methods for Adult Training within the Framework of the European Union Project “The Vocational Education and Training”	125
Linda Mackevica. International Project Experience as a Tool for Improving Professional Competence and Quality of Teachers Education	135
Peter J. A. Reusch, Muhammad Khushnood, José Ramon Otegi Olaso. An Object Role Oriented Project Management Approach	143
Peter J. A. Reusch, Katrin Löhr, Muhammad Khushnood. What Can Standards Standardize in International Project Management?	152
Ramona Rupeika-Apoga, Irina Solovjova. Project Foreign Exchange Risk Management in Enterprises: The Case of the Baltic States	161



Project Management Development – Practice and Perspectives

First International Scientific Conference on Project Management in the Baltic Countries

February 8-9, 2012, Riga, University of Latvia

<i>Emīls Pūlmanis.</i> Evaluation of Regional Development Financial Instruments Funded Project Management	174
<i>Mariann Somosi.</i> Self-Evaluation Model of Organizational Behavior in Higher Education Quality Development Projects	184
<i>Dezso Szakaly.</i> Specialities of Technology Transfer Projects in Knowledge Based Economy	194
<i>Wolfgang Tysiak.</i> From Critical Path to Critical Field	204
<i>Juris Uzulāns.</i> Project Management Maturity and Risk Management Documentation	212
<i>Agnese Vaivade, Edgars Brēķis.</i> Project Risk Assessment Using Quantitative Methods	221
<i>Carsten Wolff.</i> Configuration Management in Multi-Site Projects – An Approach for Collaborative Work	232
<i>Tatiana Yurieva.</i> Project Crisis Management	238



IMPROVED SOFTWARE PROJECT MANAGEMENT THROUGH THE USE OF PRODUCT LINES

Christopher Brink

Department of Computer Science

University of Applied Sciences and Arts Dortmund

Emil-Figge-Str. 42, 44227 Dortmund, Germany

E-mail: Christopher.Brink@fh-dortmund.de

Martin Peters

Department of Computer Science

University of Applied Sciences and Arts Dortmund

Emil-Figge-Str. 42, 44227 Dortmund, Germany

E-mail: Martin.Peters@fh-dortmund.de

Sabine Sachweh

Department of Computer Science

University of Applied Sciences and Arts Dortmund

Emil-Figge-Str. 42, 44227 Dortmund, Germany

E-mail: Sabine.Sachweh@fh-dortmund.de

Keywords: project management, product lines, feature models, variability

Abstract

Widening projects in software engineering also bring an increased complexity in the associated project management, especially if the software product consists of many different components and has a high variability and long lifetime with an iterative process of improvements. Problems like maintaining dependencies between different components and different versions of components, managing a huge diversity of possible configurations and test management arise. To handle the problem of configuration management and the variability in software projects, software product lines are used which consists of one or more feature model.

In this paper we present an approach that supports the modeling and configuration of product lines taking into account different project management aspects. The modeling of the variable and common parts of the product line is accomplished by using multifeature models. Furthermore, we present a process for development and configuration of these product lines which also enables support for project management disciplines. For this purpose, the individual features of the feature models are assigned with different development artifacts, which may include for example requirements, software components or test cases.

1. Introduction

Software products showing a high variability are difficult to manage because of different aspects. On the one hand it is a complex task to manage the lifecycle due to dependencies



between different components, which may vary in each final product, on the other side such a product will be further developed due to new requirements or improvements. To manage these aspects in the software development, software product lines [1] can be used.

The central element for the representation of common and variable parts of a product line is one or more feature model [2, 3]. Each feature model has many features, which represent stakeholder requirements or product characteristics [4, 5, 6]. These features are arranged hierarchically and may have dependencies to other features. Supplementary each feature has a semantic which indicates the meaning within a group (optional, mandatory, or, alternative). The feature itself is associated with a concrete software component or software artifact, so that it is possible to produce software based on a selection of features and their dependencies. A defined and valid selection of features represents one configuration (product) of the product line.

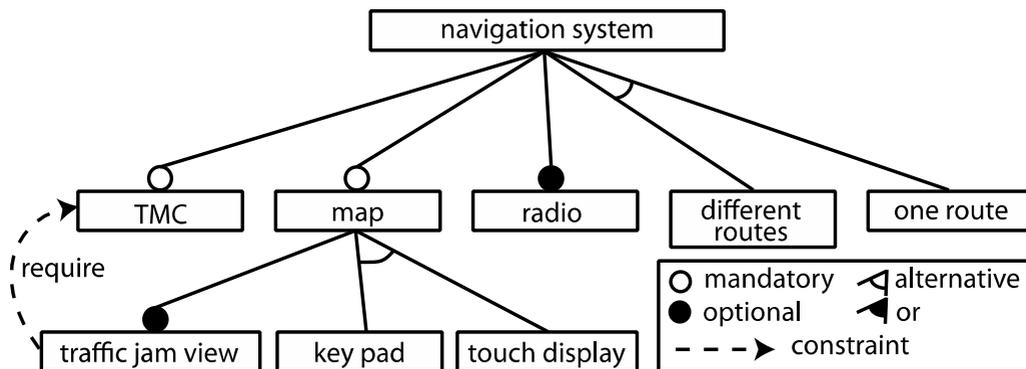

Figure 1. Feature model

Figure 1 shows an example of a feature model for the software of a navigation system. The feature model let's you select for example, if you want the Traffic Message Channel (TMC) service to be included in your system or not. Based on this kind of description, many different features and their relationships of a configurable system can be developed and finally lead to a highly variable product. To handle the variability of the product and to support the development of products based on software features, the concept of feature models has been extended in numerous approaches [3, 5, 6, 7, 8]. Apart from the support to handle the variability of a system, a software product line can also be used to provide support for the quality management of a product. While the variability of a system brings challenges in the field of testing due to the large number of different products that can be created, the product line can also be used to provide different test cases according to the selected configuration.

In this paper we present an approach that extends the concept of product lines to the field of software project management for complex projects handling products with a high variability. Our approach supports a continuous documentation of requirements and their implementation by associating requirements with a set of features. In addition, we associate each feature with test cases, so that the quality of products is ensured and can be tested even within a varying product. Both, the software product itself and the test cases are generated based on a configuration. To fulfill the aforementioned requirements we extend the notation of feature models by introducing new artifacts and new types of associations. We also show how the use



of software product lines in conjunction with the presented approach opens up the possibility for organizing the development process of software products in a structured way by tiling the functionality and corresponding artifacts and develop that functionality in parallel.

We start with a description of the development process of a software product line in section 2 where we show, how to integrate aspects of the quality management into a product line. Section 2 also describes feature models and the distribution of one product line into multiple feature models in detail while section 3 describes the development of artifacts. Section 4 shows the process of a product generation including test cases and further documents. Finally, we discuss the proposed approach in section 5 and conclude our work in section 6.

2. Development Process

To support different aspects of project management, processes were defined that can be followed to manage a project. Accordingly in [1] a process was defined that supports the project management in projects handling with complex and durable software product lines and can be used as a guideline to develop a product line and to create a product from a configuration. Nevertheless, they don't consider aspects of the quality- and test management. To add the aforementioned support to the existing process chain, we extended the process by introducing further steps regarding test development and test execution. Because of the nature of a product line, the whole process consists of two fundamental steps, the development process and the configuration process. While the development process includes steps to identify requirements and to develop the product line including the required features, the configuration process includes the product generation based on a customers needs. Figure 2 depicts the first part of the extended process chain, the development process which is tiled, just like the configuration process, too, into two levels of development that partly can be developed in parallel. The first step includes the requirements engineering which is the basis for the feature definition. During this phase of the project, the variables of the product line are defined which have a strong impact on the requirements engineering for the software development.

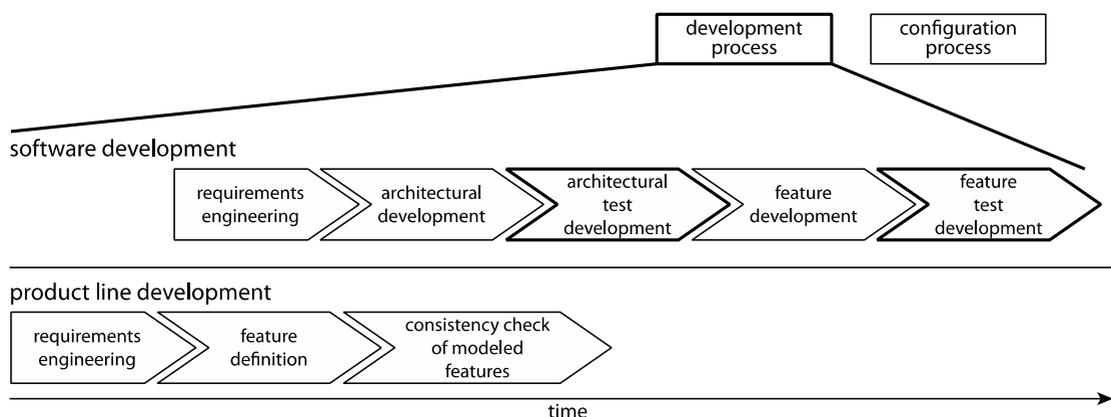

Figure 2. Development process



During the software development process chain, we added to stages for the development of test cases. The first stage includes the development of architectural tests, which ensures the quality and functionality of the architectural basis of a product. Accordingly test cases for non-variable parts of the system are developed that will be included in each product generation process. The second introduced stage includes the test development for a specific feature and therefore needs to be developed for each feature, too. This step allows us to include specific test cases into a configured product depending on the selected features. Due to the association of a feature with the corresponding test cases, even a product with a high variability can easily be tested including architectural tests as well as tests for each single feature that was included.

Feature Models in the Development Process

During the development process of a product line, feature models are used in the stage of *feature definition* to describe the variables of a system. Nevertheless, the use of a single feature model for the whole product line rises some disadvantages in the handling of the system, especially if the system becomes complex. On the one hand a distinction of different systems parts, for example the software for different ECUs in a car, which is necessary for the product generation, is not possible. On the other side dependencies and properties, which may exist between those parts cannot be modeled in an adequate way. However, such information is needed during the product generation process to determine related system parts and to identify further requirements like software platforms and execution environments.

To address the aforementioned issues related to the use of a single feature model, we propose a multi product line approach where individual system parts are developed within a single feature model and the different feature models can be associated with each other. To describe the dependencies between multiple features belonging to different feature models, we extended the concept of constraints introduced in [9] by allowing an association over multiple feature models.

A *require* and an *exclude* constraint, like described in Table 1, is used to define associations between multiple feature models as well as between features within a single feature model.

Table 1

Constrainttypes

Constraint	Description
require	Describes the dependence between two features in a feature model. Furthermore it is also possible that the features are located in different system parts. Feature A requires feature B.
exclude	Describes the mutual exclusion between two features in a feature model. Again, it is possible that the features are in different system parts. Feature A cannot be combined with feature B.

Figure 3 shows an example of a simple multi product line with two feature models connected to each other describing two variable parts of a car configuration. On the left side, a parking system can be configured where the rear-view camera feature requires the presents of a



navigation system with a graphical display (map). On the right side, further details on the navigation system can be configured. The example shows, how different system parts can be distributed over multiple feature models, so that the parking system is managed within one feature model and the navigation system is managed within another feature model.

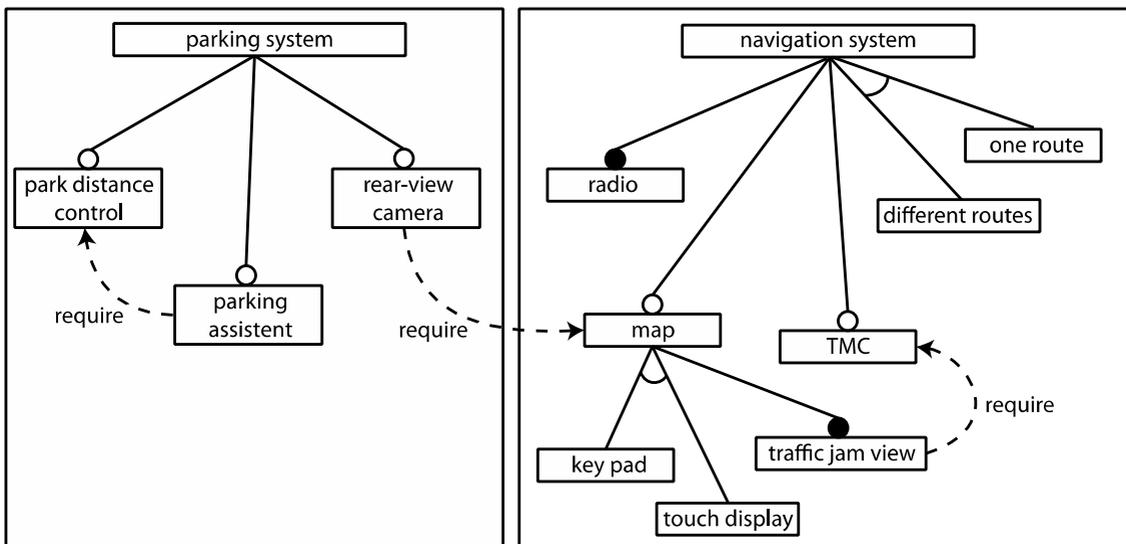

Figure 3. Different system parts of one product line

With the proposed distribution of features into multiple feature models and the constraints associating multiple feature models with each other, a complex product line can be broken down into multiple parts that may be developed and maintained individually. It also allows a differentiation of single system parts during the generation process, which offers a higher flexibility regarding the elevation of further requirements.

3. Extended Feature Concept

To be able to generate a product from a configuration of a product line, each feature is typically associated with a software artifact like a component. During the generation process, all software artifacts are used to produce the configured product. To gain a wider support for the quality management the association of a feature with just a software artifact is insufficient. Instead, we directly associate requirements with one or more features so that it is comprehensible which requirement leads to which feature and on the other side, which feature implements which requirement.

The same concept like used with requirements is applied to tests cases, too. That way it is possible to develop not only a software artifact for a feature, but also to develop test cases which are directly associated to a feature and therefore also to a requirement. This allows a continuous development of the software product line not only including functionality, but also important aspects on quality management. Test cases can also not only be developed for a single



feature, but also for multiple features. Thus it is possible to create test cases that will be included in a product test if all associated features of a test case are within the configuration. This kind of test cases can be used to ensure the proper functionality of multiple features, which interact with each other or may have an impact on each other.

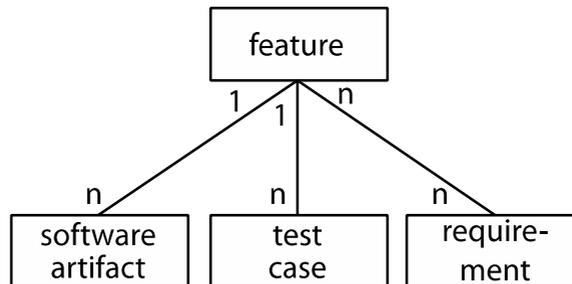

Figure 4. Feature concept

In Summary through the use of the proposed feature concept it is possible to determine three different aspects of a configuration:

1. The requirements which are fulfilled by a configuration
2. The software artifacts, which are necessary to generate the configured product
3. The test cases that ensure a valid software product

The applied concept allows the traceability of requirements and can also be extended to include further artifacts for example for documentation. In this manner it could be possible to associate text blocks with each feature to generate not only the software itself, but also a complete documentation or user manual that exactly meets the configured product.

4. Generating Products and Test Cases Based on a Feature Selection

In section 2, the development process and the configuration process of a software product line were introduced. While the development process refers to tasks like requirements engineering and development of features and the corresponding test cases, the configuration process describes the steps that are necessary to create a product from a product line. The basis of a product generation is a valid configuration of a product line. A valid configuration is given if all mandatory features are included and no constraints contradict each other. Each configuration includes several selected features that define the functionality and behavior of the product. A valid configuration for the example in

Figure 3 could include the *park distance control* within the *parking system* feature model and the *radio feature* within the *navigation system* feature model. Based on this configuration, all necessary artifacts that are associated with the selected features can be determined and processed to generate the final product.

To include further quality management aspects into the configuration process, we also extended the process chain and added a step for test case generation and a step for the execution of the tests like depicted in Figure 5.

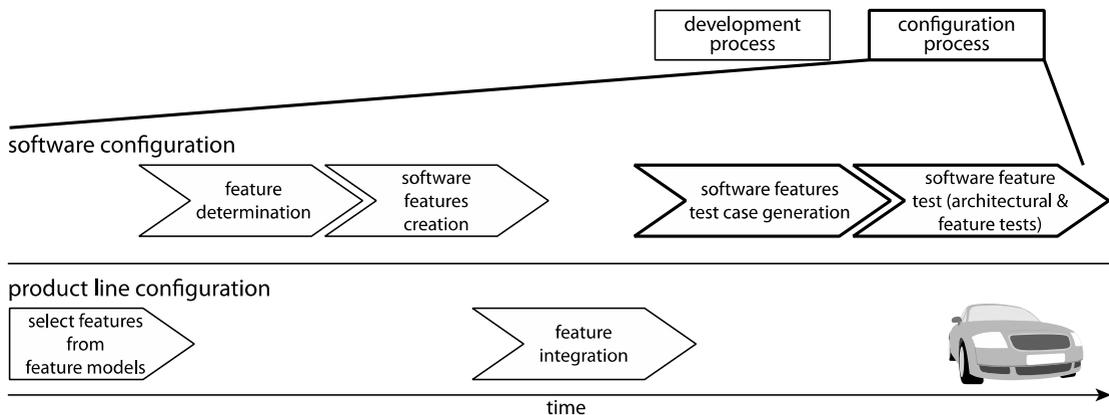

Figure 5. Configuration process

Test cases are generated depending on the features that were selected. Thereby a distinction is made based on the kind of test case. If a test case refers to only one feature, each test case of the selected features is generated and will be executed in the next step. Test cases that are associated with multiple features to test the impact on each other are only included, if all associated features are selected and thereby will be included into the product. The last step in the process chain before the final product can be delivered is the execution of the generated test cases. Within this step, all test cases are executed and problems within a generated product or the selected configuration can be identified.

With the proposed configuration process it is possible to ensure that even a highly variable system were the components that may lead to a final product can vary, each component was tested and the functionality of the whole system is given.

5. Related Work

Recently many approaches were proposed to extend the concept of product lines to integrate software development artifacts like requirements, classes or components [4, 10, 11]. Apelet. al. introduced away to connect classes as well as refinements of classes with features. Depending on the selected configuration of a product line, those classes were modified based on the previous mentioned refinements. Finally, the software is provided by the generated artifacts. Although this approach is promising for software product lines it is not adequate for project management because neither artifacts like test cases nor dependencies between different system parts can be considered. Furthermore the approach does not allow the association of one artifact with multiple features like we proposed with requirements and test cases.

Streitferdt extends the concept of product lines in his PhD-thesis and considers an association between features and requirements. Therefore he identifies different types of dependencies, which mainly differ from the dependencies introduced in this paper that they only can be applied to features within one feature model. In addition test cases are not taken into account.



Another refinement of the concept of product lines is introduced in [1], where a process for the development of software product lines is presented. This concept is used in our approach and accordingly applied to multiproduct lines and extended for support of quality management.

In the following section we are going to focus on product line concepts for multi feature models.

Multi Feature Models

In [12] Apelet. al. outlines a process for a combined hardware and software product lines which is quite similar to [1]. Nevertheless they also do not support quality management in their process or consider the necessary associations between features of different system parts.

Reiseret. al. introduced in [13] an approach for modeling multi level feature trees. In contrast to our approach, Reiseret. al. organize feature models hierarchically and do not consider different development artifacts.

One approach where the configuration of software and hardware features is considered within one product line was suggested in [14]. However, only requirements are mapped and only one single feature model is used, which limits the differentiation between features of different system parts. Furthermore no information about the test cases can be integrated in the model.

The handling of multi product lines was also focused in [15] where Rosenmülleret. al. introduced composition models to associate multiple feature models within one multi product line to generate a configurator based on the composition models. In contrast, we use different feature models and connect them with various artifacts like requirements, software components or test cases. Furthermore our process supports the whole development process.

6. Conclusion and Further Work

In this paper a process was presented which allows the modeling and developing of variable systems and the generation of associated test cases based on a multi feature model approach. The quality management support in terms of test case development and traceable requirements was integrated into the product line development process. Furthermore, the concept of constraints between multiple features has been extended to support constraints between features of different feature models, too. This allows a subsequent combined configuration of complex systems. Nevertheless, it has been shown that simple constraints are not always adequate to model all kinds of constraints. To address this circumstance, we plan to extend the presented approach and define a description language for complex dependencies. The proposed approach was prototypically implemented in our tool FoCuS. FoCuS is constantly being developed to support various development artifacts for features and also to enable an optimized configuration based on specified parameters. Furthermore we are going to examine how other disciplines of project management can be integrated into the proposed approach. In a next step, a configuration support is integrated into FoCuS. This will calculate features of existing system parts and configure them for stakeholders based on a properties selection.



Acknowledgments

We thank the anonymous reviewers for their helpful comments. The work was funded partly by the Federal Ministry of Education and Research (BMBF), project number, 17N3909.

References

1. Paul Clements and Linda Northrop. *Software Product Lines: Practices and Patterns*, Addison Wesley, 6th edit, 2007.
2. K.C. Kang. Feature-oriented domain analysis (FODA) feasibility study. *Report, DTIC Document*, 1990.
3. S. Apel, T. Leich and G. Saake. Aspectual feature modules. In *IEEE Transactions on Software Engineering*, IEEE Computer Society, 2008, pp. 162-180.
4. Sven Apel and Christian Kästner. An overview of feature-oriented software development. *Journal of Object Technology (JOT)*, 2009, pp. 49-84.
5. Krzysztof Czarnecki, Thomas Bednasch, Peter Unger and Ulrich Eisenecker. Generative Programming for Embedded Software *,An Industrial Experience Report*, 2002, pp. 156-172.
6. Krzysztof Czarnecki, Chang Hwan and Peter Kim. Cardinality-Based Feature Modeling and Constraints *:A Progress Report*, 2005.
7. S. Apel, M. Kuhlemann and T. Leich. Generic feature modules: Two-staged program customization. In *Proceedings of the International Conference on Software and Data Technologies (ICSOFT)*, 2006, pp. 127-132.
8. D. Benavides and P. Trinidad. Using Constraint Programming to Reason on Feature Models. In *The Seventeenth International Conference on Software Engineering and Knowledge Engineering (SEKE'05)*, 2005.
9. K. Czarnecki and U. Eisenecker. *Generative Programming Methods, Tools, Applications*. Addison-Wesley, Boston, 2000.
10. T. Buchmann. Modelle und Werkzeuge für modellgetriebene Softwareproduktlinien am Beispiel von Verwaltungssystemen (in German). PhD Thesis, University of Bayreuth, 2010.
11. Detlef Streitferdt. Family-oriented requirements engineering. PhD – Thesis, Technical University of Ilmenau, 2004.
12. J. Liebig, S. Apel, C. Lengauer, and T. Leich. Robby DBMS: a case study on hardware/software product line engineering. In *Proceedings of the First International Workshop on Feature-Oriented Software Development*, ACM, 2009, pp. 63-68.
13. Mark-Oliver Reiser and Matthias Weber. 2006. Managing Highly Complex Product Families with Multi-Level Feature Trees. In *Proceedings of the 14th IEEE International Requirements Engineering Conference (RE '06)*. IEEE Computer Society, Washington, DC, USA, 2006, pp. 146-155.
14. Detlef Streitferdt, Periklis Sochos, Christian Heller and Ilka Philippow. Configuring Embedded System Families Using Feature Models. In *Proc. of Net. Object Days*, Erfurt, 2005, pp. 339-350.
15. M. Rosenmüller and N. Siegmund. Automating the configuration of multi software product lines. In *Proceedings of the Fourth International Workshop on Variability Modelling of Software-intensive Systems (VAMOS 2010)*, 2010, pp. 123-130.

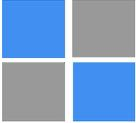

HOW CAN PRIVATE COMPANIES USE THE FINANCIAL SERVICES AND RISK MITIGATION INSTRUMENTS OFFERED BY EXPORT CREDIT AGENCIES IN EMERGING MARKETS?

Trung Quang Dinh

*M.Sc Student in International Business
School of Business and Science
University of Akureyri
Borgir v/Norðurlóð, 600 Akureyri, Iceland
Phone: +(354) 841 0499
E-mail: ha110243@unak.is*

Professor Hilmar Þór Hilmarsson

*School of Business and Science
University of Akureyri
Borgir v/Norðurlóð, 600 Akureyri, Iceland
Phone: +(354) 460 8620, +(354) 849 8380
E-mail: hilmar@unak.is*

Keywords: Cross border trade and investment, emerging markets, export credit agencies (ECAs), commercial and non-commercial risks, and risk mitigation instruments

JEL classification: F14, F21, G24, G32

Abstract

When private companies engage in cross border trade and/or investments in emerging market economies they are faced with risks that are different from risks in domestic markets. Emerging markets can offer opportunities for high returns, but at the same time the risks, including both commercial and non-commercial risks, can be high. Those risks need to be managed. This article discusses the opportunities and the challenges that private companies may face when engaging in trade and investment in emerging markets. It will then discuss options for using risk mitigation instruments offered by export credit agencies (ECAs). The article will discuss examples of cross border trade and projects in emerging markets to illustrate how those instruments have been applied in real world situations.

Introduction

Companies who engage in trade and investments in emerging markets are both faced with commercial risks and non-commercial/political risks. Political risks are normally higher in emerging markets than in developed countries. The World Bank's Multilateral Investment Guarantee Agency (MIGA) recently published a report titled World Investment and Political Risk (MIGA 2009). This report includes an extensive literature review on foreign direct investment and political risks. The study found that while a degree of ambiguity exists when it

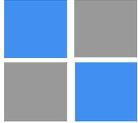

comes to the relationship between political risk variables and foreign direct investment (FDI) based on econometric studies, findings based on surveys unequivocally support the view that companies do take into account political risk in their investment decisions (MIGA 2009). According to the Economist Intelligence Unit in recent years there has been growing evidence that political risk not only features in investment decisions, but is also moving towards the top of corporate agendas, as reflected in various business surveys. This is especially true for emerging markets where generic political risk is identified as main investment constraint (EIU 2007). A report from Lloyd's found that global businesses were becoming more concerned about risk from political violence. More than one third of 154 survey takers said that they were avoiding overseas investments for fear of political violence. This report also stated that business leaders believe political violence risk is real and rising; and concerns about political violence are preventing companies from investing where they would like to invest (Lloyd's 2007).

So what is political risk? There are many definitions of political risk. MIGA defines political risk as “the probability of disruption of the operations of MNEs by political forces or events, whether they occur in host countries, home country, or result from changes in the international environment. In host countries, political risk is largely determined by uncertainty over the actions of governments and political institutions, but also of minority groups, such as separatist movements. In home countries, political risk may stem from political actions directly aimed at investment destinations, such as sanctions, or from policies that restrict outward investment” (MIGA 2009, p. 28). When discussing the reasons why a country needs to set up an ECA, Stephens¹ states that “political risks are those relating to the actions of governments in importing countries to prevent payment being made to the foreign exporter, for instance problems with transferring foreign currency. Default by government or public sector buyers or guarantors in another example, as is civil war” (Stephens 1996). Beside political risk, commercial risk is also a concern of companies worldwide when they expand their business to emerging markets. The commercial risk is defined by the OECD (in the context of export credits) as “the risk of nonpayment by a non-sovereign or private sector buyer or borrower in his or her domestic currency arising from default, insolvency, and/or a failure to take up goods that have been shipped according to the supply contract” (OECD 2003). And Stephens has a quite similar definition on commercial risk “the principal commercial risks are insolvency of the buyer, default on payment by the buyer and repudiation of or refusal to accept the goods or services ordered” (Stephens 1996). Commercial risk can be high in emerging markets where the financial system is still immature as compared to developed countries. The lack of financial information and the quality of information in these markets partly institutes the threats of commercial risk. Credit rating agencies and the exporters themselves cannot always assess credit worthiness comprehensively and sufficiently based on the limited financial information of their buyers. As Nerouppos et. al. emphasized in a study the lack of data in emerging markets can lead to tremendous difficulties for risk management. “Another problem, equally important from a risk management point of view, is that there is a startling scarcity of available data. Often, the institutional mechanisms that lead to the plethora of data in advanced markets do not exist (e.g. derivatives exchanges, secondary markets, and even regular auctions of a standard set of government bonds). Furthermore, those data that are available are contaminated for many reasons. Since many emerging markets have

¹ Malcolm Stephens is Secretary-General of the International Union of Credit and Investment Insurers (Berne Union). He was formerly Chief Executive of the Export Credits Guarantee Department in the United Kingdom.

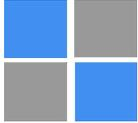

gone through some period of crisis, the history of local financial variables is of questionable value in calibrating mathematical models for assessing future risks. Any current price data that are available must be viewed in light of the volumes and liquidity of local markets. All of these factors lead to tremendous difficulties for risk management” (Nerouppos et. al. 2006, 180-181.p).

In spite of the high level of risks in emerging markets, companies do not stop tapping into these markets because of potentially high profit margins they can get. In order to mitigate against political and commercial risks the use of risk mitigation instruments has become more important for companies exporting to and doing business in emerging markets. These instruments are provided mostly by export credit agencies (ECAs), multilateral financial institutions and private insurers. Most ECAs and multilaterals are members of the Berne Union² (International Union of Credit and Investment Insurers).

According to EKN, the Swedish Export Credit Agency, the volume of guarantees this agency issued increased from more than SEK 20 billion in 2007 to more than SEK 115 billion³ in 2010 (EKN 2010a). This evidence unequivocally illustrates that risk mitigation instruments are in high demand in a country like Sweden and risks in foreign markets need to be managed and reduced. This increased demand enhances the important role of an ECA in exporting or home country. And in a discussion paper Stephens argues that among the many reasons why to set up an ECA in a country have to do with confidence to export, protection against risk, improvement in competitive position, access to bank finance, source of information and trade expertise (Stephens 1996).

The following chapter discusses risk mitigation instruments offered by ECAs and at the same time discusses the preliminary findings from a research conducted by the authors in co-operation with a large Icelandic company, Marel, who is engaged in manufacturing food processing equipment. This company has production facilities in several countries. The objective of this research is to answer the research question “How can private companies use the financial services and risk mitigation instruments offered by Export Credit Agencies in emerging markets?”

Risks Mitigation Instruments by ECAs

When private companies engage in cross border trade or investment in emerging markets, the risks they face is a key concern. Not only small and medium sized companies need to evaluate and assess the risks they are faced with carefully but also large corporations with stronger financial capabilities need to protect properly their business from risks. In order to meet this existing demand the political and commercial risk insurance industry has been formed. The leading association in this industry is the Berne Union (founded 1934) with 73 members including mainly ECAs, multilateral institutions, and private insurers (MIGA 2010). ECAs are either public-sector institutions in their respective countries, established to provide support for

² “The Berne Union (BU) was founded in 1934 in order to promote international acceptance of sound principles in export credit and investment insurance and to exchange information relating to these activities. Today, the BU has 73 members (including Prague Club members) comprising mainly export credit agencies (ECAs), multilaterals and private insurers. The BU plays an important role in bringing together the public and private insurers to enhance cooperation and information sharing. Members meet on a regular basis to discuss industry trends and challenges” (MIGA 2009).

³ This amount is equivalent to USD 3 billion in 2007 to USD 17 billion in 2010.

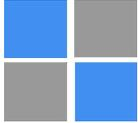

Project Management Development – Practice and Perspectives

First International Scientific Conference on Project Management in the Baltic Countries

February 8-9, 2012, Riga, University of Latvia

the exports of that country, or private-sector companies that act as a channel for government support for exports from the country concerned (Yescombe 2002).

In general, these ECAs will charge premium to those companies who use their products. The “OECD country ratings are designed to set guidelines to price the default risk on export credit and to set minimum premium rates charged by participating ECAs” (MIGA 2010, p. 63). The ratings known as Knaepen Package came into effect in 1999, is a system for assessing country credit risk and classifying countries into eight risk categories, from 0 to 7 (OECD n.d). Basically, ECAs will assess political risk and commercial risk when they issue guarantees to exporters or foreign buyers. ECAs use country ratings by OECD as platform to assess political risk or country risk while commercial risk is assessed based on each individual corporate’s information such as operation and background information, financial and audited annual reports, project feasibility studies, etc. Companies who are eligible to use products or services provided by an ECA must have their operations relevant to national interest of the country where the ECA is located. In other words, the companies must contribute to national economic development of that country in a direct or indirect way. For instance, a company must have production facilities located in the home country of the ECA. The ECA can also support a home company who has production facility in a host country.

There are various products or risk mitigation instruments offered by these ECAs and these products can be the same or very similar from one ECA to another. Products of ECAs include, for example: Bond Guarantee, Investment Guarantee, Project Financing Guarantee, Financing Guarantee, Project Delivery Guarantee, Working Capital Guarantee or Reinsurance. The products that this paper focuses on and analyzes are: (i) Buyer Credit Guarantee, (ii) Supplier Credit Guarantees and (iii) Export Loans. Each individual ECA may have different names for their products. For instance Export Credit Guarantee Department (ECGD), i.e. the ECA of UK, names Buyer Credit Guarantee and Supplier Credit Guarantee (the two products of EKF, the Danish ECA) as Buyer Credit Facility and Supplier Credit Financing Facility. The criteria for selection of ECA also can be various. EKF, the Danish ECA and EKN, the Swedish ECA, do not set any limits to the minimum nor maximum amount of contract value between the exporter and foreign buyer as long as the premium is sufficient to cover for their margin and operational cost, however, ECGD specifies the purchase of good or service worth at least £ 5 million for Buyer Credit Facility or £ 25, 000 for Supplier Credit Financing Facility. The authors chose the three products mentioned above for analysis based on their other relevant research of a large European company in connection to its business expansion in Vietnam. These products seem to be the most suitable in terms of risk mitigation when companies export goods or services to their buyers in emerging markets. However, companies need to find what product suits them best in every specific case.

Buyer Credit Guarantee is basically a guarantee issued by an ECA to a bank that lends money to a foreign importer to pay for an order of goods or services from an exporter in the country where this ECA is located (see figure 1). In emerging economic countries, both local and international banks are cautious when decide to lend capital to companies. A research⁴

⁴ In co-operation with Marel Food Systems, the authors selected, visited and interviewed 4 of the largest Vietnamese pangasius processors in order to understand their difficulties and constraints in modernizing their processing lines. Export value of these processors on a yearly basis varied from USD 17 million to USD 61.7 million in 2010 (according statistic from VASEP sent via email July 22, 2011). These companies are thus an important source of foreign exchange for Vietnam.

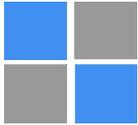

among the largest fisheries processors (ranked by VASEP⁵) in Vietnam conducted by the authors in November 2011 found that when companies applied for medium long term loans (up to 5 years) to invest in their processing equipment they usually only got 50 to 55 percent of the amount requested. If a company has good working experience and good relations with a local bank and the feasibility study of their project is highly assessed, the amount of loan could be increased to 70 percent out the total loan requested. The companies had to use their own fund to for the rest of the investment. Some processors said that they could hardly obtain any medium or long term loan if the size of loan is up to few millions of US dollars. This has been one of the companies' main constraints and it prevents companies from investing intensively in more comprehensive processing lines.

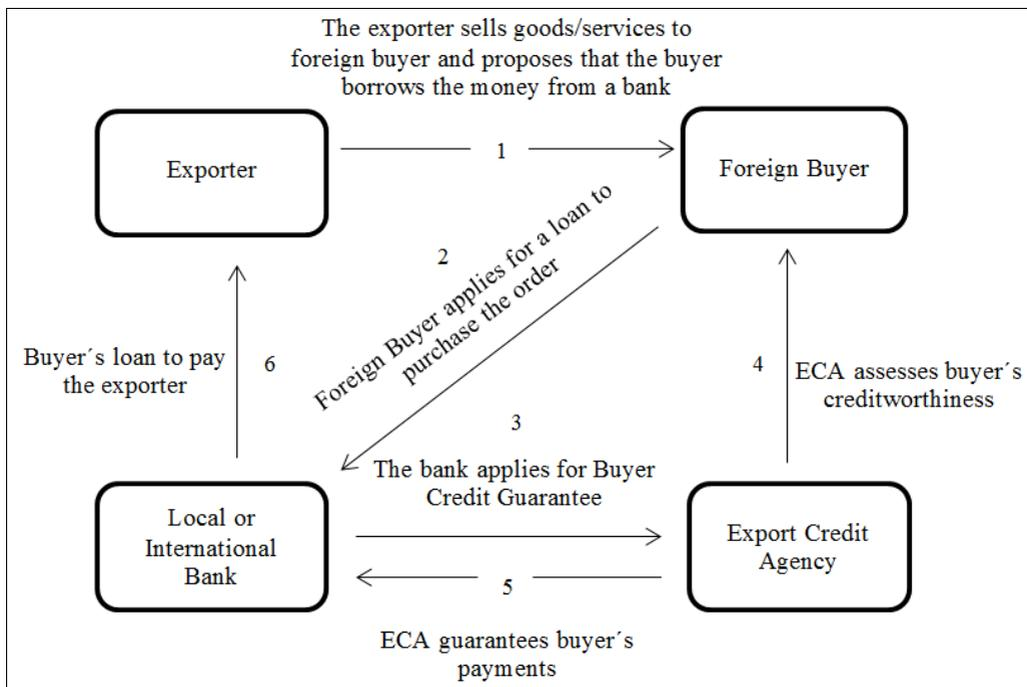
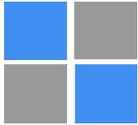

Figure 1. Model of Buyer Credit Guarantee of Danish ECA – EKF.

Buyer Credit Guarantee will help foreign buyers in emerging markets to obtain larger loans from international banks and with longer lending term. This can also be done through a local bank but it would normally take more time as the ECA is more likely to know the international banks. The bank will then be covered from buyer's default in repayment due to commercial or non-commercial risks.

Supplier Credit Guarantee is a guarantee issued by an ECA to the supplier or the exporter and this exporter can grant the foreign buyer extended credit on amounts payable for the order. The

⁵ Vietnam Association of Seafood Exporters and Producers (VASEP) is a non-governmental organization, established on June 12th 1998, based on the principles of volunteer, autonomy and equality. VASEP members include leading Vietnamese seafood producers and exporters and companies providing service to the seafood sector.



supplier or the exporter will be protected against the risk of not being paid by the buyer or the importer due to political or commercial risks. The exporter can take advantage of supplier credit guarantee to lend the foreign buyers in an emerging market where an extended credit period may be the key incentive for the buyers to select the most competitive supplier over the others. Supplier Credit Guarantee helps the buyer or the importer repay the order in a longer period (see figure 2). This can be very advantageous for a buyer who may have limited cash flow and has difficulty in accessing to funds. In a prior research conducted by the authors among 20 largest Vietnamese fisheries processors in August 2011, a set of questionnaire was sent out. All of those who answered indicated that they have to pay the supplier within 3 to 6 months after the equipment has been fully installed and checked. This short term repayment period for the equipment from the supplier is one of their main constraints especially for companies who lack working capital and have difficulty in obtaining loans. The research conducted by the authors in November 2011 found that these companies have not been offered an extended credit period from any supplier. They have to apply for loans from local banks with high interest rates. Most loans lent to them are both short term loans (less than 12 months) and the amount allocated is far lower than the amount they requested. This constraint is one of the reasons why Vietnamese fisheries processors could not purchase sophisticated processing equipment from European manufacturers on a large scale.

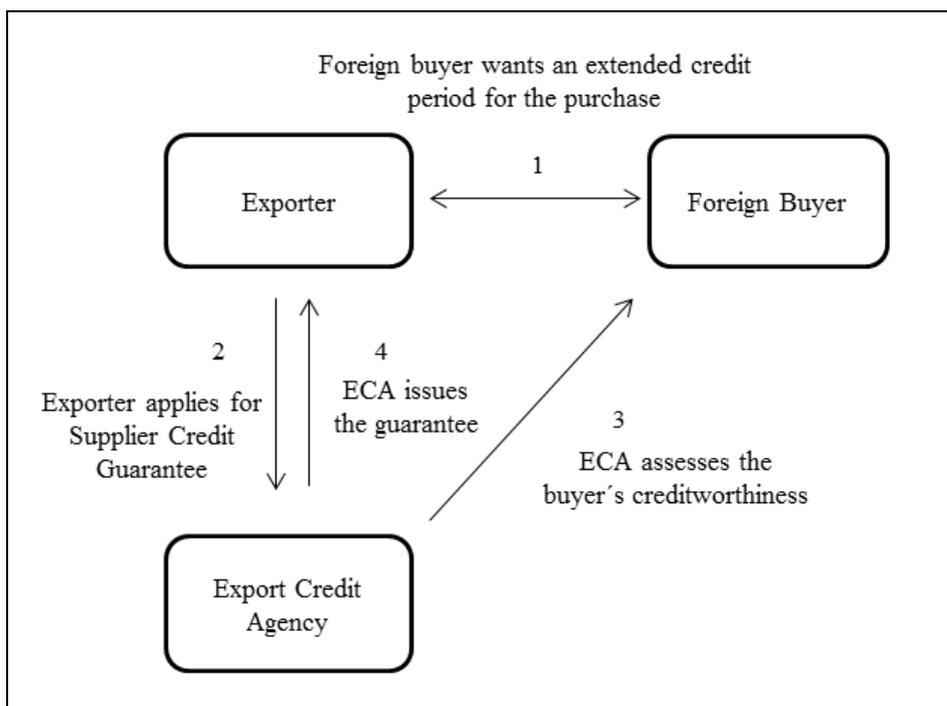
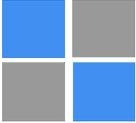

Figure 2: Model of Supplier Credit Guarantee of Danish ECA – EKF.

They only bought a small part of the equipment needed from these manufactures and the rest of processing lines were locally made or imported from more affordable Asian manufacturers like China, Korea or Japan. This suggests that if buyers from an emerging market like Vietnam are offered an extended credit period, it may affect their investment decision which means that they



would perhaps invest more sophisticated processing equipment on a larger scale. Some of the processors in Vietnam have indicated that if they were granted a longer repayment period from the supplier and at reasonable cost they would consider to invest and modernize their processing lines more comprehensively. See figure 2 for the description of how Supplier Credit Guarantee works.

An export loan is a lending scheme to help the exporter's foreign buyer when this buyer is unable to secure credit facilities from banks for purchasing products and services from the exporter (see figure 3). In the case of EKF, the Danish Export Credit Agency, they facilitate the export loan through a bank, and the loan is based on the bank's lending terms. It depends on each individual ECA whether or not they offer the export loan product and how long the lending term will be. But this product is very important in the situation of financial crisis where banks are unable to provide loans to corporations. The EKF offers export loans as a result of the crisis and application for export loan of EKF can be made until end of 2015. In the same research by the authors in November 2011, the Vietnamese pangasius processors shared the view that local banks can only lend them with the amount not exceeding 20 percent of those banks' totals lending capital. This reflects the limits in lending capacity of banks in Vietnam. And thus it limits the opportunities for processors in particular and Vietnamese enterprises in a broader view, if they wish to invest intensively. Besides that, each company may enjoy different interest rates depending on how good their relationship is with the lending bank. When this research was conducted, interest rate that these processors had to pay for medium long term loan was 19 percent for VND and 8 percent for USD, these interest rates varies from company to company as explained, however, these rates are considered high, especially the local rates in VND.

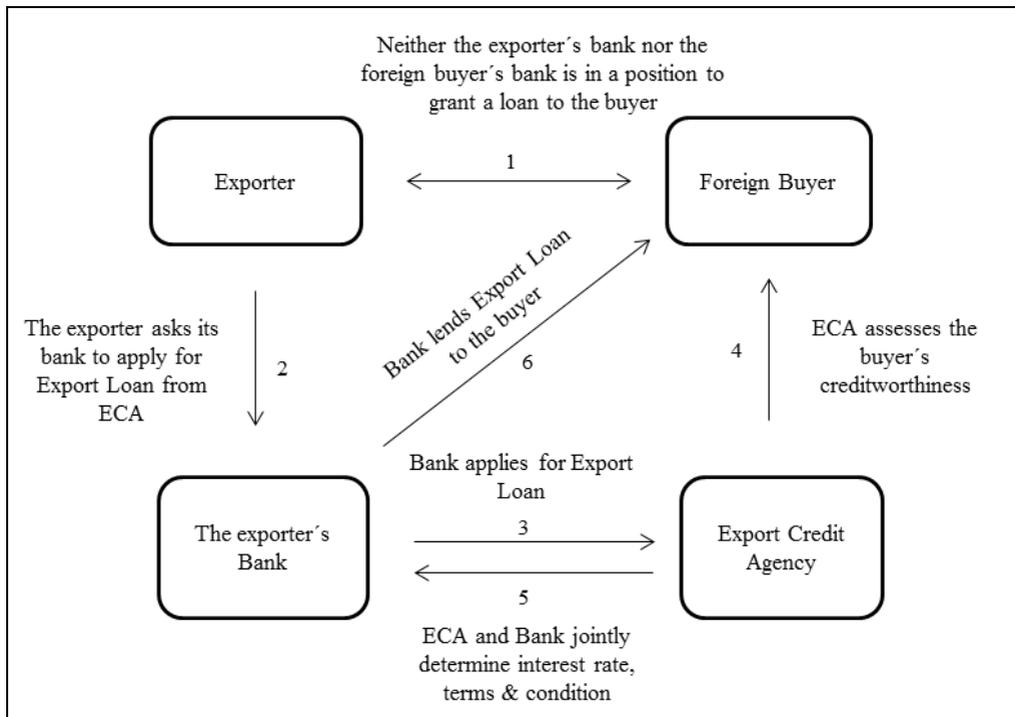
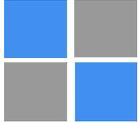

Figure 3: Model of Export Loan of Danish ECA – EKF.



However, the cost associated and premium for this Export Loan scheme is not necessary cheaper than other traditional lending schemes because the export loan is granted jointly by a bank (usually the exporter's bank) and an ECA to the foreign buyer based on commercial basis and market conditions. Export loan can be even more expensive but it also can be critically important in international trade especially under financial crisis time where most of banks are unable to provide funds to companies. The next chapter will illustrate how this produce is applied with a case in Jordan.

Cases

This chapter demonstrates some success stories of companies who used products of the Danish Export Credit Agency, EKF. These cases are quoted directly from cases published on the EKF's website.

1. **Olam International Limited and The Use Of Buyer Credit Guarantee from Danish ECA - EKF – for a manufacturing facility in Vietnam (2009)**

Olam is a leading global supply chain manager and processor of agricultural products and food ingredients. With direct sourcing and processing in most major producing countries for various products, with the headquarters in Singapore, Olam has built a global leadership position in many businesses, including cocoa, coffee, cashew, sesame, rice, cotton and wood products. Olam operates an integrated supply chain for 20 products in 65 countries, delivering these products to over 11,000 customers worldwide (Olam 2011).

The challenge

In the year 2009, Olam was looking to invest in equipment for its new coffee manufacturing facility in Vietnam. Olam chose a Danish company namely GEA Process Engineering A/S as the supplier. Unfortunately, the global economic and financial crisis made it difficult for Olam to secure the financing it needed to buy the equipment. At the same time, Olam's bank was reluctant to secure long term financing. "Owing to the lack of liquidity in the financial market in February 2009 it would in all probability have been impossible to secure financing with a repayment term beyond 2-3 years for Olam," says Antero Ranta from Olam's bank, ANZ Structured Asset and Export Finance, in Singapore

The Process

Thanks to long standing working relations between GEA and EKF, GEA proposed that EKF be involved in the process of procuring financing for Olam's project in Vietnam. "I was convinced that EKF would be able to assist in putting the financing in place. For our part, it was all plain sailing, as, right from the start, our customer and ANZ were keen to take over and deal with EKF directly," says Jesper Duckert, Project Finance Manager, GEA Process Engineering A/S. In order to implement the financing negotiations, EKF decided to send its representatives to Vietnam and had a meeting with representatives from Olam and ANZ Structured Asset. After the visit to Vietnam, EKF had better basis for assessing the actual credit risk entailed by the project.

The Solution

After the meeting and negotiation EKF came up with a detailed assessment of the project and was able to offer a buyer credit guarantee. This guarantee meant that EKF

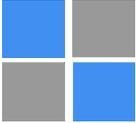

assumed a share of the risk of extending a loan to Olam, and therefore, ANZ could secure financing for Olam as they needed. “With an export credit guarantee from EKF we were able to offer Olam a loan with a repayment term of 8.5 years,” says Antero Ranta from ANZ Structured Asset and Export Finance in Singapore. “In spite of the financial crisis we were able to secure long-term financing for our activities on a growth market,” says Arun Sharma, Senior Vice President, Coffee Division, Olam (EKF 2009a)

2. **A Jordanian Company namely Modern Cement & Mining Company, and The Use of Export Loan and Buyer Credit Guarantee from Danish ECA – EKF (period of credit: 2010 to 2017)**

The challenge

In July 2008 the Jordanian company Modern Cement & Mining Company chose a Danish company namely FLSmidth as an equipment supplier for its new cement plant in the south of Amman. The first deliveries were already paid by the Jordanian company but the main part of the order was to be financed by a local bank. However, due to the global economic and financial crisis, the bank turned down applications for new loans. This threatened the progress of the construction and the order of FLSmidth. FLSmidth decided to contact EKF in the spring of 2009 because FLSmidth had previously been assisted by EKF with guarantees for financing solutions.

The process

EKF had meetings with a number of international and local banks who expressed their interest in taking on the risks of the project provided that EKF would guarantee most of the loans. Furthermore, through the export lending scheme EKF was able to offer a loan to the buyer of FLSmidth services. Then EKF quickly endorsed the project. “EKF’s endorsement was conditional to the approval of the risks and terms in the transaction, its environmental impact and the extent of the Danish economic interest in the transaction – aspects which all needed further examination and subsequent negotiation with the parties involved.” (EKN 2010b)

The solution

Finally the solution came into place in May 2010. “Half of the FLSmidth contract was financed with equity from the owners of the cement plant while the other half was financed with loans. More than half of the debt financing came from the Danish export lending scheme administered by EKF, while the remainder was provided by a group of local banks” (EKN 2010b). HSBC London arranged the EKF financing. HSBC London is also acting as agent bank on behalf of EKF. Thanks to EKF’s loan and guarantee, the construction of the cement plant in Jordan could continue as planned. And the plant is expected to be ready for production start-up at the beginning of 2012 (EKF 2010b)

3. **Grain and Seed Exporter Nibulon Company in Ukraine Used EKF’s Buyer Credit Guarantee to Borrow Money from a Western European Bank At a Far Lower Interest Rate Than in Ukraine**

The challenge

In 2009, a Danish company, Cimbria Unigrain received the first of two large orders worth EUR 20 million from Nibulon, Ukraine’s largest grain and seed exporter and a

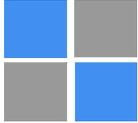

high-growth company. . This order consisted of eight silo facilities for storing, drying and loading grain and seed. And Nibulon uses this equipment to extend and standardize its storage and transportation facilities by the rivers of Ukraine and the Black Sea. However, the Ukrainian buyer's constraint was that they had to borrow at a high interest rate in Ukraine to pay Cimbria Unigrain. And this might create uncertainty regarding the order from the Danish manufacturer.

The Process

Cimbria contacted EKF and EKF agreed to assess the viability of the export order and work on the financing options via a guarantee from EKF. "Even allowing for the premium payable to EKF, Nibulon is making a big saving," says Sales Director Henning Roslev Bukh. He adds that Nibulon regards Cimbria Unigrain and EKF as important and regular business partners.

The solution

Finally EKF offered buyer credit guarantee to Nibulon. This meant that Nibulon was able to secure a loan from a Western European Bank at a far lower interest rate than in Ukraine. "Nibulon is very pleased that it was possible to arrange a Danish guarantee for this order. We might well have got the order anyway, as Nibulon has ordered from us for many years and is very satisfied with our products. Nibulon could perhaps have financed the purchase with equity, but it is often cheaper to borrow the money than to use equity, and equity is greatly needed in a growth-oriented company such as Nibulon," says Henning Roslev Bukh. And in 2010, Nibulon made another order for eight silo facilities – and once again, EKF provided a guarantee for the buyer's payments. Thanks to this order Cimbria Unigrain has hired 30 employees in 2010. (EKF 2009b)

4. Marel Food Systems and the possibility of the use of ECAs products in Vietnam Market

Marel Food Systems is one of the leading manufactures in food processing equipment. Marel is headquartered in Iceland but has production facilities for processing lines in fish, poultry, and meat in numbers of European countries, USA, Brazil and in Asia. Marel is ambitious to expand their business in emerging markets where food processing industry is becoming more important like for example in China, Thailand and Vietnam. However, the purchasing volume of buyers from these markets remains low especially in Vietnam. The research in cooperation with Marel, mentioned earlier, among largest pangasius processors in Vietnam, found that Vietnamese buyers bought some limited number of equipment rather than comprehensive processing lines. During in-depth interviews with the 4 largest Vietnamese processors, the authors was told that most of equipment made by European manufacturers is very sophisticated and advanced, however, this equipment is too expensive for them to purchase on a large scale. Instead, they needed to select some equipment which is most important for them. The remaining equipment they bought from more affordable manufacturers from China, Korea or Japan and some other equipment is locally made. When asked, these processors said they were aware of the fact that having advanced equipment in their processing lines would enable them to export more of their products to high income markets like USA, Europe and Japan. The critical issues rest in funding which

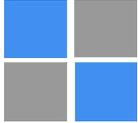

Project Management Development – Practice and Perspectives

First International Scientific Conference on Project Management in the Baltic Countries

February 8-9, 2012, Riga, University of Latvia

prevents them from investing intensively. The issues here include low amount of loan allocation from local banks, limited availability and accessibility to long term loans especially in foreign currency like USD, high interest rate, short repayment period to the equipment suppliers etc. At the same time, the authors interviewed some ECAs in Europe like EKF (Denmark), EKN (Sweden) and ECICS (Singapore); in response to the question what products offered by ECAs they thought are most suitable for Marel and its buyers in Vietnam given the constraints mentioned above, these ECAs thought that two products should be suitable which are Buyer Credit Guarantee and Supplier Credit Guarantee. The recommended products of ECAs could help Marel achieve its goal which is to expand its business in Vietnam. However, the ECAs also said that in order to be supported by ECAs' instruments the Vietnamese buyers need to fulfill the requirement in terms of being able to provide sufficient and transparent information of their companies, especially financial information, including audited annual reports. The readiness and well done "home-work" of Vietnamese buyers will help the process of ECAs in assessing their creditworthiness and making decision on their request quicker. Most of the Vietnamese fisheries processors now are working with local banks both state owned and privately, however, ECAs indicated that if foreign buyers work with international banks it will normally make the process faster because ECAs have more working experience with large international banks than local banks in a specific country.

Conclusion

When companies engage in cross border trade and/or investment they are more likely to face higher risks than in domestic markets. These risks can be political and commercial risks and the level of risk is also different in different markets. In the context of emerging markets and due to the current uncertainty in financial market, these risks have moved towards to the top corporate agendas. Certainly, these risks should be managed. In order to cover the existing demand and to promote the export of its home products, ECAs worldwide provide various risks mitigation instruments. Through the research done by the authors and the real cases described in this paper, we can see that there are real possibilities for companies to have risks covered thus enhance their business development especially when they tap into emerging markets.

Among the key factors to make things happen is the ability of ECAs to assess the creditworthiness of companies especially the foreign buyers. Therefore, in response to this issue, foreign buyers should provide full and transparent financial information to help the process move faster, including audited annual reports. Besides that, ECAs prefer working with international banks that they know and already have a business relationship with so it would be advantage of foreign buyers to seek loans from international banks like ANZ, HSBC, American Standard Chartered Bank or international organizations like the Asian Development Bank and the International Finance Corporation of the World Bank Group, etc. The products offered by ECAs show that the risks associated with political and commercial risks in emerging markets can be managed, and the cases discussed in this paper are tangible evidence of recent success during a global economic and financial crisis.

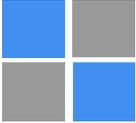

Project Management Development – Practice and Perspectives

First International Scientific Conference on Project Management in the Baltic Countries

February 8-9, 2012, Riga, University of Latvia

References

1. EIU (2007). EIU and the Colombia Program on International Investment 2007. World Investment Prospects to 2011: Foreign Direct Investment and the Challenge of Political Risk. London: Economist Intelligence Unit. Available at: http://graphics.eiu.com/upload/WIP_2007_WEB.pdf (Accessed on September 6, 2011).
2. EKF (2009a). Case: Olam Buys Danish Equipment with Long-term Loan. Available at: <http://www.ekf.dk/en/How-it-works/cases/Pages/GEA-Process-Engineering.aspx> (Accessed on November 14, 2011).
3. EKF (2009b). Case: Ukraine Orders Create Jobs in Thisted, Denmark. Available at: <http://www.ekf.dk/en/How-it-works/cases/Pages/Cimbria.aspx> (Accessed on November 14, 2011).
4. EKN (2010a). Annual Report. Available at: http://www.ekn.se/ar2010/EKNs_annualreport_2010.pdf (Accessed on December 12, 2011).
5. EKF (2010b). Case: EKF Secures Financing of Large FL Smidth Order to Jordan. Available at: <http://www.ekf.dk/en/How-it-works/cases/Pages/FLSmidth.aspx> (Accessed on November 14, 2011).
6. Lloyd's (2007). Lloyds 360. Under Attack? Global Business and the Threat of Political Violence. London: Lloyd's. Available at: <http://www.lloyds.com/~media/Lloyds/Reports/360%20Terrorism%20Reports/GlobalBusinessUnderAttack.pdf> (Accessed on September 6, 2011).
7. MIGA (2009). World Investment and Political Risk. Available at: <http://www.miga.org/documents/flagship09ebook.pdf> (Accessed on December 12, 2011).
8. MIGA (2010). World Investment and Political Risk. Available at: <http://www.miga.org/documents/WIPR10ebook.pdf> (Accessed on December 12, 2011).
9. Nerouppos, Marios et. al. (2006). Risk Management in Emerging Markets: Practical Methodologies and Empirical Tests. *Multinational Finance Journal*, vol.10, no.3/4. 180-181 p. Available at: <http://mfs.rutgers.edu/mfj/Articles-pdf/V10N34p2.pdf> (Accessed on September 5, 2011).
10. OECD (2003). Definition of commercial risk. Available at: <http://stats.oecd.org/glossary/detail.asp?ID=5896> (Access on October 15, 2011).
11. OECD (n.d). Country risk classification. Available at: http://www.oecd.org/document/49/0,2340,en_2649_34171_1901105_1_1_1_1,00.html (Accessed on December 12, 2011).
12. Olam (2011). Annual Report. Available at: <http://www.olamonline.com/resources/documents/ar2011/ar2011.pdf> (Accessed on December 14, 2011).
13. Stephens, Malcolm. (1996). Setting up An Export Credit Export Insurance Agency. *International Trade Forum*, Issue 3, 3-8 p. Available at: <http://web.ebscohost.com/ehost/delivery?sid=ff4ec966-3f96-4c89-8b65-6e4d945c3e8b%40sessionmgr10&vid=7&hid=18> (Accessed on August 31, 2011).
14. VASEP. Vietnam Association of Seafood Exporters and Producers. Official website: <http://www.vasep.com.vn/vasep/eDailynews.nsf/Homepage>.
15. Yescombe, E.R. (2002). Principles of Project Finance. Academic Press, London. 343 p.



DOES LOST TIME COST YOU MONEY AND CREATE HIGH RISK?

Dr. István Fekete

Corvinus University of Budapest

H-1093 Budapest Fővám tér 8, Hungary

Tel: +3630-456-3424

E-mail: istvan.fekete@uni-corvinus.hu

Keywords: risk assessment, outage, maintenance, project implementation plan, scenario analysis, Monte-Carlo Simulation

Abstract

The aim of the case study is to express the delayed repair time impact on the revenues and profit in numbers with the example of the outage of power plant units.

Main steps of risk assessment:

- creating project plan suitable for risk assessment;
- identification of the risk factors for each project activities;
- scenario-analysis based evaluation of risk factors;
- selection of the critical risk factors based on the results of quantitative risk analysis;
- formulating risk response actions for the critical risks;
- running Monte-Carlo simulation [1] using the results of scenario-analysis;
- building up a macro which creates the connection among the results of the risk assessment, the production plan and the business plan.

Results

The result clearly demonstrates that **if the outage of certain units is delayed by 3-4 days as compared to the scheduled date due to the inadequately managed risks, the profit before tax might decrease by approximately HUF 1.4 Bn (€ 5M).**

With the execution of the risk management actions there are real chances to **meet the planned deadline** of outage works, and avoid the € 5M loss. Of course, risk management activity costs certain amount of money as well, but the execution costs of the risk management actions are only a fragment of the loss we can avoid.

Preliminaries

Risk management is a practice of systematically identifying, evaluating, treating and monitoring risks that might have a negative or positive effect on the ability of a company to achieve its strategic goals. Risk can be a **future event, activity or failure of activity** that has a positive or negative effect on the strategic goals. It can come from many sources, e.g. uncertainty in financial markets, credit risks, regulations and legal liabilities, authorization,



accidents, natural disasters as well as unintended human mistakes, deliberate attack from an adversary or employee, cooperation between partners etc.

Risk management can be used in many different business areas. One of the issues is calculating the **impact of risks on the productivity and profit plan** of a manufacturing company. This case study shows an example of a nuclear power plant.

The Paks Nuclear Power Plant is located in South-Hungary. The license holder is the Paks NPP Joint Stock Company (Paks NPP Ltd). The majority owner of the company is the state owned Hungarian Power Companies Ltd. with a total equity of more than 99.99%.

The four reactor units of the power plant were first connected to grid between 1982 and 1987. Each of the four units is a VVER-440/V-213 power reactor type, cooled and moderated with light water, and each has a thermal output power of 1,485 MW. After power upgrading program the individual electrical capacity of each reactor unit is 500 MW, giving a total electrical capacity of Paks NPP site approximately 2,000 MW. The daily production value per reactor unit is 0,5M €. The yearly electricity production of the power plant is 15 000 GWh and the revenue is 700 M €.

The electrical energy produced by a nuclear power plant is sold to power providers. The sales contract records the volume of electric power to be sold expressed in GWh. If a nuclear power plant does not meet the production volumes of electric power commitment as scheduled in the contract, and the difference exceeds the pre-defined percentage values, the contract requires the nuclear power plant to purchase the missing amount from the electric power exchange. Since the price of electric power is much higher at the electric power exchange than the production costs of the nuclear power plant, its profit will significantly reduce. Therefore, it is the vital interest of the nuclear power plant to identify any potential risks causing production outages, and model their impact on revenues and profit via the production plan.

The Aim of the Case Study

The reactor units need regular maintenance and refueling. During these works the reactors have to be shut down. There are two basic types of planned outages for Paks nuclear power plants: the longer service outage and the shorter refueling outage. The service outage includes refueling, major plant modifications, periodical inspections and tests required by the Technical Specifications. Typical duration of the service outage project is 57 days. The refueling outage mainly consists of partial refueling, corrective and preventive maintenance. Typical duration is 26 days. The typical work plan of refueling outage has about 6500 different activities. The maintenance program always has an uncertainty, which can be confronted when the reactor unit is disassembled. Based on experience the average delay of the refueling outage is 3 days. This implies 1.5 M € direct financial loss.

Every tool that **eliminates this potential loss** is essential for the company, and risk management can help reveal the reasons of loss and reduce probability and/or impact of critical risks.

There are two aspects of risk analysis issues related to this topic. First is a **strategic view**: How can we achieve the strategic goal of load factor?¹ In other words, how to ensure the highest level of production? The second targeted area is: Identifying potential delay of outage activities at the **operational level** and eliminate the additional cost.

¹ Load factor = Actual gross energy output in year *i* / Maximum gross energy output in year *i*



This case study is making an attempt to assess the effect of the unplanned outages derived from the delayed maintenance works in a nuclear power station and express the delayed repair time impact on the revenues and profit.

Precondition: During risk analysis we accepted the accuracy of the project plan for the maintenance works as a starting proposition. This means, we did not examine if the outage works of the certain units could be shortened e.g. with better work organization.

Main Steps of Risk Assessment Project [2] [3]

The first step is to **simplify the project plan** for risk assessment. The project managers of the company have already prepared a project plan, but that contains thousands of activities. It is obvious that the number of activities is too big to be suitable for an efficient risk management because of the time needed for analyzing each activity. Therefore the main task is to reduce the number of activities to a manageable number but of course the content of the outage plan must be preserved. This number should be between 10 and 30.

We also have to define the **logical relationships** among the activities to get the critical path. [4] In this example the length of the critical path is 26 days for refueling and 57 days for service outage.

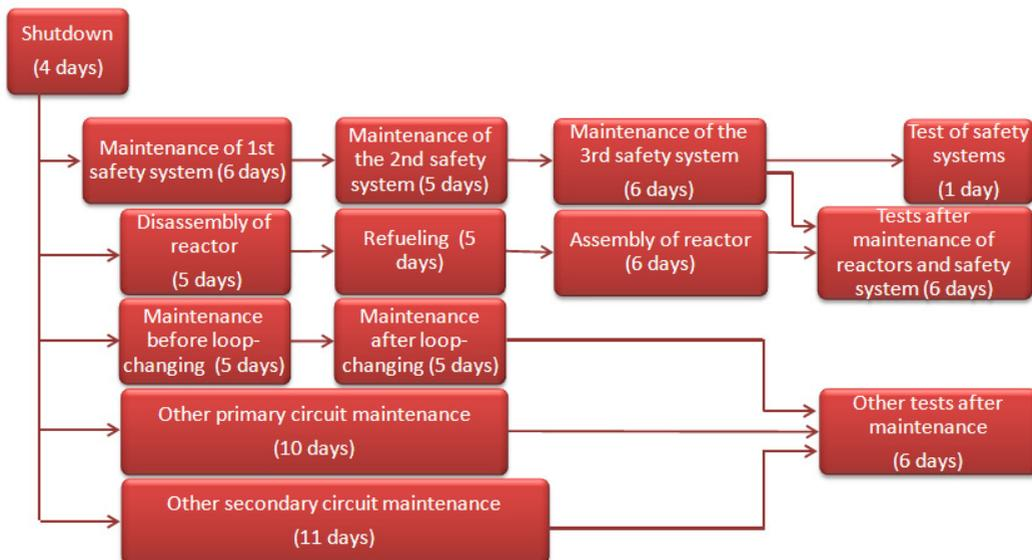

Figure 1. Simplified project plan

The next step is to **identify the potential risk factors** for each project activities. We suggest the company organize workshops for risk assessment, involving the experts of the project (engineers and project managers). We used our own risk management software named Szigma Integrisk® and a premade standard risk database that is based on our several years of experience. In this database the risk factors are assigned to risk groups, e.g. legal risks, technological risks, human resources, IT-technology, cooperation, management risks etc. In our example the experts have assigned cc. 10-12 risk factors to every project activity.



The **scenario analysis** helps calculate the probable impact of a risk. We have to estimate all of the potential outcomes, included the worst and the best case. Maximum four different scenarios can be defined and evaluated. In the course of the evaluation the experts estimate the probability of occurrence of the given scenario and the impact in terms of days.

Then we can calculate the **mean value** and **standard deviation** for each risk.

The selection of the **critical risk factors** is based on the previously defined mean value threshold and relative deviation threshold. If the calculated mean value or the deviation overruns the threshold because of a risk, that risk is labeled as critical risk.

Table 1

Example of risk assessment

Activity: Reassembling of reactor		
Risk factor: Capacity is not sufficient for completing the task.		
Detailed description: Not being ready on time caused by lack of capacity. Engineers and technical supervisors cannot handle the huge amount of simultaneous tasks.		
	SCENARIOS	
	Scenario 1	Involving of additional capacity is belated, so a delay of 5 days is possible.
	Explanation of estimation	Lack of capacity is realized in time, so a maximum delay of 5 days is possible.
	Probability	0.3
	Impact (days)	5.00
	Scenario 2	Involving of additional capacity is belated, so a delay of 10 days is possible.
	Explanation of estimation	Surveying lack of capacity is belated; therefore a delay of 10 days is possible.
	Probability	0.5
	Impact (days)	10.00
	Scenario 3	Involving of additional capacity is belated, so a delay of 15 days is possible.
	Explanation of estimation	Project manager fails to realize the lack of capacity or reacts very late, so a delay of 15 days is possible.
	Probability	0.2
Impact (days)	15.00	
Mean value of deviation compared to original value (days)	9.5000	
Standard deviation	3.5000	
Critical?	YES	
Describe action	Strict control of planning activity and continuous communication with project owners and project management department	
Risk owner	Project manager of refueling project	
Deadline	31.01.2012	
Estimated cost of execution	160 000 HUF	

It could easily happen that the same risk factor would be critical at different project activities. In these cases the risk manager or project manager should filter these duplicities and



consolidate the risk responses. Through this simplifying step we can reduce the total cost of risk mitigating activities, so the risk management process becomes more effective.

The next task is to **create risk mitigating actions** for all critical risks. The main aim of the risk response is to help finish the given activity within predefined time that was set in the original project plan. Risk mitigation consists of the following steps: denomination of risk action, denomination of risk owner (responsible for the execution of the risk management plan), deadline of execution and the detailed description of the content of actions. In the example, the main aim of the risk response is to finish the given activity within predefined time that was set before the risk analysis.

We show an example how to evaluate project risks with scenario analysis (see Table 1).

Monte-Carlo simulation uses the results coming from scenario-analysis and a correlation random number generator in order to get the probability distribution [5] [6] of the total duration time of the refueling project. This is the last step related to risk assessment.

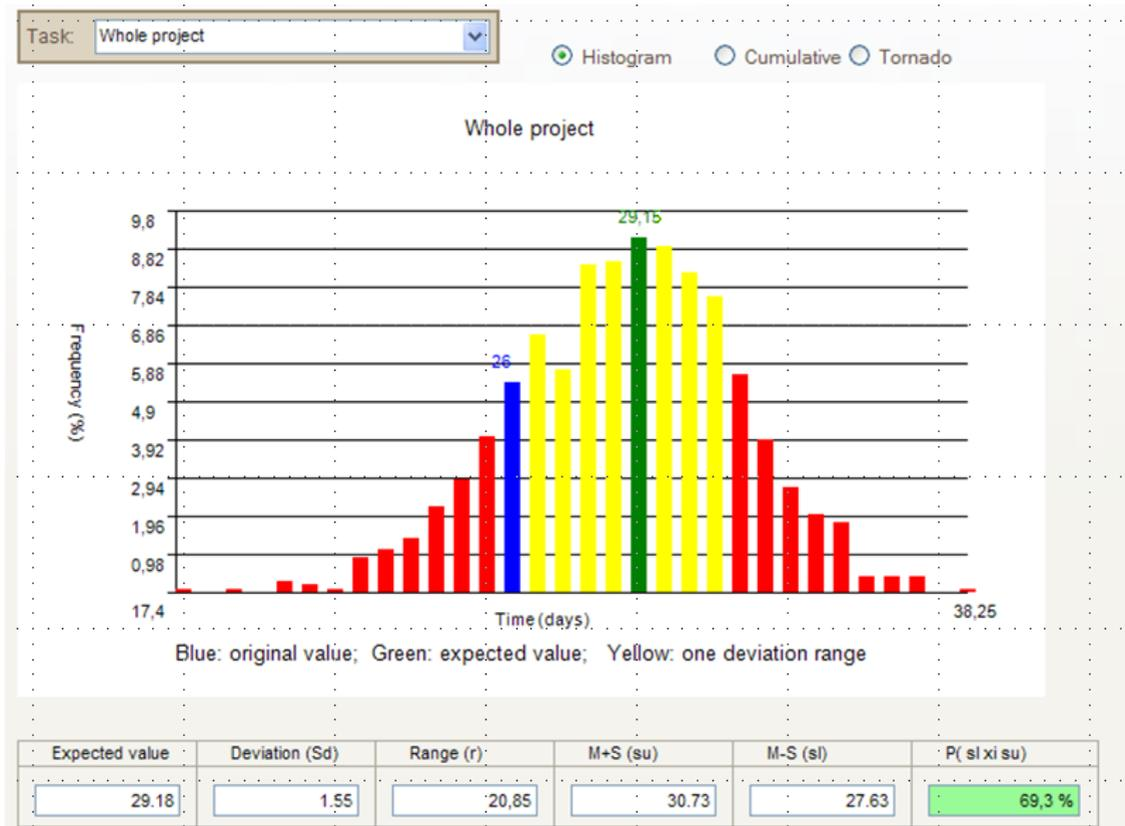

Figure 2. Result of Monte-Carlo simulation

In the course of the scenario analysis a maximum number of four scenarios could be defined. These scenarios are the most important variations that the experts can set out but in real life much more outcomes are possible. In the course of Monte-Carlo simulation the number of



samples could be multiplied so we can simulate a more realistic project environment. As a result we get the mean value, standard deviation, range and other parameters of the distribution of the execution time of each activity and the whole project.

If there had been enough historical data regarding the duration and delays of former refueling and maintenance projects, Monte-Carlo simulation would have been started immediately, instead of risk assessment. In this case the company had not collected such data before the analysis.

As a result we can see that the expected outage duration will be in a **three-day delay**. But because of the huge deviation, there is a high potential for finishing the outage before the original deadline. This means the project has not only negative risks but there are positive risks as well. Positive risks can be called opportunities the company should take advantage of by immediate realization of the risk response and implementation of risk controlling and monitoring actions.

The **Tornado-diagram** was generated by the run of Monte-Carlo simulation. The essence of this diagram is to show the activities that are mostly responsible for the project delay. These are the activities that can divert actual duration of maintenance to the greatest extent, due to their great risk exposure. That is why it is advised to execute firstly the risk response actions of these **critical activities**. By managing these most important risks way the original duration (26 / 57 days) can be kept.

In the example of Paks Nuclear Power Plant *Shutdown* and *Other primary circuit maintenance* are the tasks that are most responsible for the project delay.

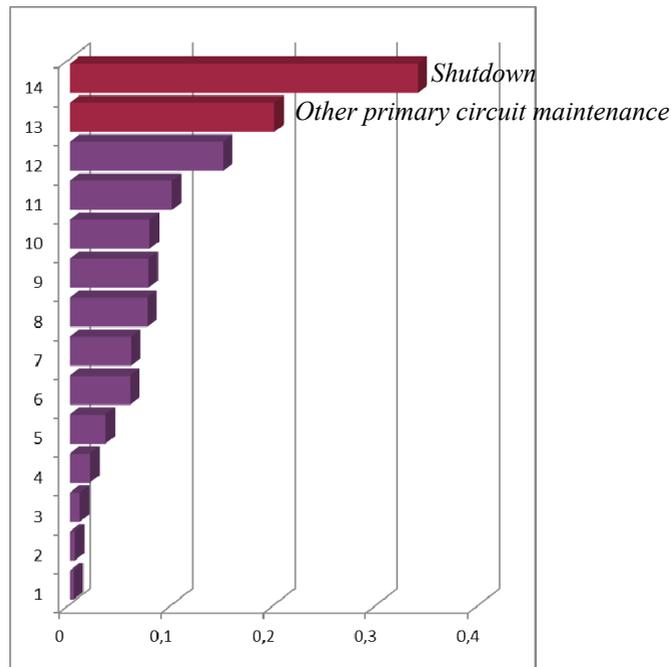

Figure 3. Tornado diagram



Using the results of risk assessment, we can answer the most important question: What is the impact of the delayed maintenance and refueling project on the **electricity production** and on the **business result**? To answer this question we need the nuclear power plant’s electricity production data and business plan. We use a macro which creates the connection among the result of the risk assessment, the production plan and the business plan.

With the help of this macro we could immediately model the impact of risks on the changes in produced electricity (GWh), changes in other costs (MHUF) and changes in pre-tax profit (MHUF). If we run the macro, we can answer for example the following question: ‘In what range the electric energy is going to fluctuate with relatively high probability (60 %) in case the previously revealed and evaluated risks happen?’

Results and Possible Further Steps

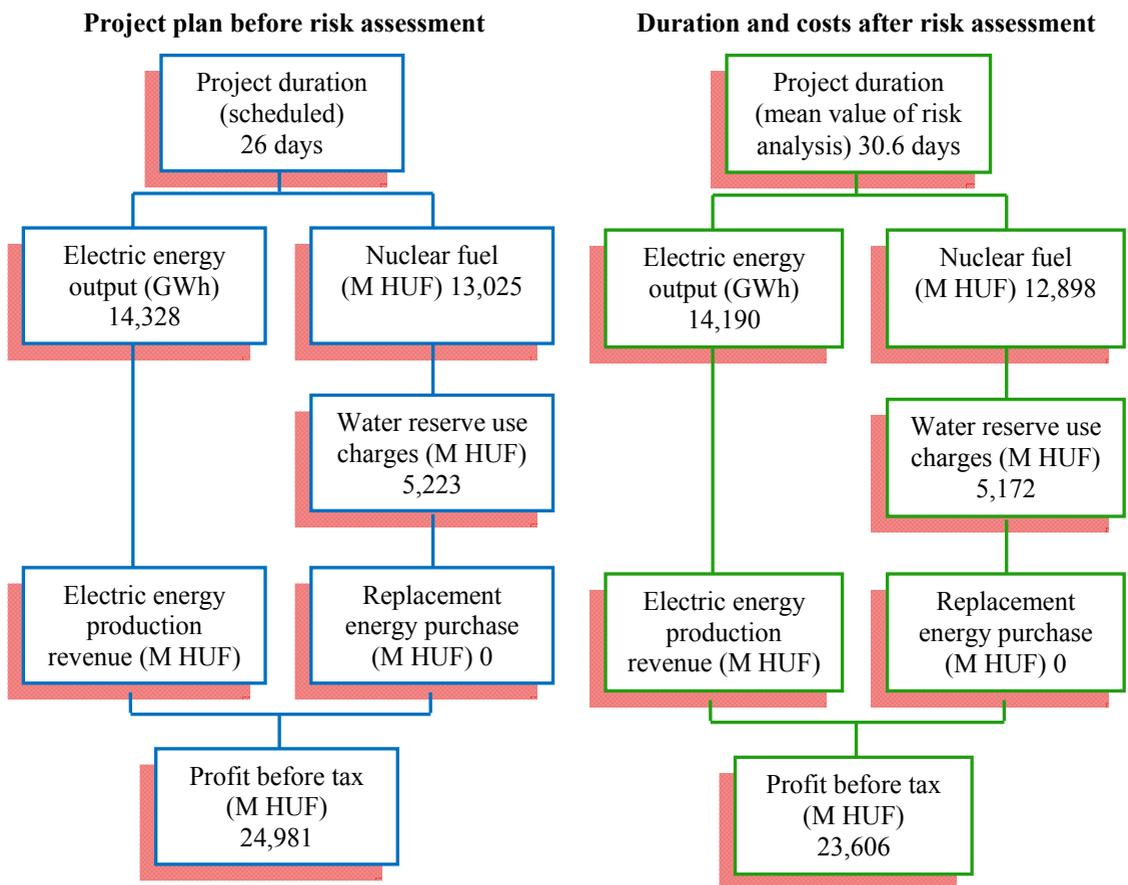

Figure 4. Impact of risks on project duration and costs

The result clearly demonstrates that **if the outage of certain units is delayed by 3-4 days as compared to the scheduled date due to the inadequately managed risks, the profit before tax might decrease by approximately HUF 1.4 Bn (€ 5M).**



With the execution of the risk management actions there are real chances to **meet the planned deadline** of outage works, and avoid the € 5M loss. Of course, risk management activity costs certain amount of money as well, but the execution costs of the risk management actions are only a fragment of the loss we can avoid.

The level of details, the methodology applied and the technology are fully in line with the user environment and demand. It is able to produce rapid and exact results based on the available empirical information.

Relying on the analysis we could identify opportunities that could improve the developed model:

- An additional **customization** of the presented model is required for modeling the risks related to the risk response actions of this project.
- At the end of the analyzing period it is advisable to examine how many of the previously identified risks occurred, what their **actual impacts** were and whether there were any realized risks that were not identified by the analysis.
- It is also expedient to make a **cost-benefit analysis** that points out what the relationship is between the cost saving due to risk management and the costs related to the risk management.
- The efficiency and accuracy of the risk management can be increased and the time of the data recording can be decreased by developing an **interface** among the different data storing systems.
- Not every risk factor was taken into consideration, since this is just an analysis made for modeling, but later other risk factors can be added to the model increasing its reliability and accuracy.

Conclusion

We summarize shortly the advantages of risk management from the point of view of Paks Nuclear Power Plant Ltd.

- The management of Paks NPP Ltd. treats the realization of the **strategic goals** with high priority. Therefore they welcome every initiation that aims to help reach the strategic goals. And one of the most important from these goals is to ensure the delivery of the predefined amount of energy to the business partner. The chance for completing this strategic goal can be increased with the reduction in the outage durations.
- The turbulent economic environment forces the management to make decisions in critical situations. The application of Szigma Integrisk[®] system can help answer many **strategic dilemmas** that the power plant faces.
- The applied risk management method ensures the execution of the efficient risk response actions. The **ex-post evaluations** confirm that the risk exposure related to the outage activity has decreased in the previous year.
- An important characteristic of risks is that they have an impact even if they are not identified in time. In this case their occurrence surprises everyone and the response of them cannot be efficient enough. By systematic risk assessment the management and project managers can identify potential risks **in time** and thus their efficient risk response is also possible.



Project Management Development – Practice and Perspectives

First International Scientific Conference on Project Management in the Baltic Countries

February 8-9, 2012, Riga, University of Latvia

- The additional value of risk assessment can be actions and programs that can improve the **operational environment**.
- Last but not least we can see in the case study that with the help of risk assessment the potential for **successful completion of the project** has increased to a great extent.

The most important conclusions are as follows:

- The main tasks of risk management are to identify and analyze the long-term and huge-budget projects' critical risks that might have an impact on duration and return. And also an important task is to formulate and execute an effective risk response plan.
- In the course of risk assessment not only the impacts on single projects should be analyzed, but also the impact on **corporate level**.
- It is very important to understand how the effective risk management contributes to avoid risks or mitigate their impacts and reach the strategic goals.

References

1. David B. Hertz: Risk Analysis in Capital Investment. Harward Business Review, Vol. 42. (January – February 1964).
2. Eurescom Project Extended Investment Analysis of Telecommunication Operator Strategies, Deliverable 2, Annex C. Heidelberg, 2000.
3. Rozalia Konkoly – István Fekete – Attila Gyürke: Evaluation of Uncertainties in Investment Projects. Third European Workshop on Techno-economics for Multimedia Networks and Services. Aveiro, Portugal, 1999.
4. Stephen Grey: Pratical Risk Assessment for Project Management. John Wiley&Sons Inc., 1995.
5. Eilon, S.C. – Fowkes, T.R.: Sampling Procedure for Risk Simulation Operational Research Quarterly, Vol. 24, 1973, pp. 241-252.
6. Merran Evans – Nicholas Hastings – Brian Peacock: Statistical Distributions John Wiley&Sons Inc., 1993.



MAKING COMPARISON BETWEEN FMCDM AND MCDM TO DEFINE PROJECT ACTIVITIES WEIGHTS

Hêriş Golpîra

*Department of Industrial Engineering
Sanandaj Branch, Islamic Azad University
Sanandaj Branch, Sanandaj, Iran
E-mail: H_Golpira@iausdj.ac.ir*

Keywords: Project success, S-curve, Fuzzy MCDM, Hypothesis

Abstract

This paper combines a group analytic hierarchy process (GAHP) and technique of order performance by similarity to ideal solution (TOPSIS) in fuzzy or non-fuzzy form to define project activities weight factors. For this purpose, a project with 121 activities is proposed as a case. Critical parameters that are affecting the priority of each activity are recognized and weighted by GAHP in its fuzzy or non-fuzzy forms. These weights are subsequently used as the inputs for TOPSIS in its fuzzy or non-fuzzy forms to define the project activities weights. Then activities are affected by the weights and the S-curves of the two new fuzzy and non-fuzzy methods are drawn to compare with the two accepted traditional ones – Bill of quantity (BOQ) and Milestones methods. Finally for mathematical comparing the two new methods and the two traditional ones, analyze of variance method is used. The results are shown that the two new methods are valid and the non-fuzzy one is better than the fuzzy one.

Introduction and Literature Review

Approximately, all researches define the schedule, cost and quality as the three traditional main criteria, directly affect the project success [1-5]. Simplicity and ever remaining within the project organization realm make the traditional approach attractive for a project manager. The major drawback of traditional approach is its inaccurate behavior [1, 3, 6]. Separately considering schedule and cost not only depict many weaknesses in each of them but also, causes duplicated manipulation of the same data for different usage [7]. So, several models like weighted percent complete model [8, 9], Work package model [10], Teicholz's model [11], Steven's curve model [12], Rasdorf's and Abudayyeh's study [9] and earned value model [13] are proposed to combine them.

Paolini and Glaser in 1977 [14], DeCotti and Dyer in 1979 [15] and Pinto and Slevin in 1988 [6], denoted the customer satisfaction as the other project success factor. Type of the projects and human factor are the other critical factors that affect the project success [1, 5, 16]. Shenhar et al. [3] in 1997 introduced thirteen success measures in four groups and some researchers denoted that a payment to contractors is the other project success factor [17, 18, 19, 20].



It is clear that the project success is tracked with actual progress of the project in comparison with the baseline schedule in the project lifecycle [18, 19, 20]. In this case, there are two main methods named as Milestones and BOQ methods where contractor prefers the BOQ method and owner prefers the other one. The significant difference between these methods [8] denotes the necessity of defining new method. Golpîra and Moradi in 2011 [4, 21] introduced a new method by using TOPSIS and GAHP. Alternatively, they made use of these two methods in their fuzzy form to have trade of with vagueness and uncertainty of the method [22].

In order to rank the methods, in this paper the two traditional methods and the two recent ones are compared with together. For this purpose, the S-curve and hypothesis analysis are widely used as the graphical and statistical tools to demonstrate the usefulness, creditability and accuracy of the models. The planned schedule which is taking from literature of the research is used to have the same base in methods comparing.

In following paragraphs the GAHP, FGAHP, TOPSIS, and FTOPSIS are briefly addressed and then the methods compared with together. The methods are completely defined in references number [4, 21, 22].

Principles of GAHP and FGAHP

AHP, introduced by Saaty in 1980 is a multiple criteria decision making (MCDM) method that can determine the priorities among various criteria [23]. Saaty believed that some uncertainty is lying in the nature of the method [24]. Bellman and Zade in 1970 were the first to study the fuzzy decision making problem [25]. Buckley in 1985 was the first to study FAHP technique [26]. Moreover, Tanino in 1984 [27], Bezdek et al. in 1985 [28], and Kacprzyk et al. in 1993 [29] address the group MCDM methods.

Fuzzy and non-fuzzy AHP are started with translating the problem into a hierarchy with a top goal, criteria, sub-criteria and decision alternatives [30]. The comparison matrix (D) of each decision maker (DM) is constructed [30, 31] and the eigenvector and λ_{\max} are evaluated by $|D - \lambda I| = 0$. This leads the problem into the consistency index (CI) and consistency ratio (CR) for each DMs comparison matrix by $CR = CI/RI$, $CI = \frac{\lambda_{\max} - n}{n-1}$. The CR must be less than 0.1; otherwise the DM should revise his/her judgments [4, 21, 22]. Hereafter, the route of FGAHP and GAHP are deferred as follows:

- In GAHP weight of each factor is calculated by Eigenvector technique and then consolidated by geometric mean method [4, 21].
- In FGAHP the comparative weights are transformed to fuzzy triangular numbers. In order to this transforming, in this paper the Gumus method is used [32]. The weights of criteria for each DM and consolidated group decision are calculated by geometric mean method to attain the $\tilde{w} = (\tilde{w}_1, \tilde{w}_2, \dots, \tilde{w}_i, \dots, \tilde{w}_n)$, $\tilde{w}_i = (l_i, m_i, u_i)$ as the criteria fuzzy weight vector [22, 26].

Principles of TOPSIS and FTOPSIS

Hwang and Yoon in 1981[33] proposed TOPSIS model to order performance by similarity to ideal solution [22]. But it is difficult for DMs to assign accurate performance rating

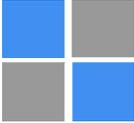

to alternatives [34], and therefore the fuzzy logic is used which is lead the decision making close to the real world [35, 36].

- The TOPSIS model is started with defining decision matrix (D^+), Standardizing and then normalizing it (N_{D^+}). The criteria weight vector –that is recalled from result of GAHP in previous step- is multiplied by N_{D^+} . The ideal (A^+) and nadir ideal (A^-) alternatives are defined and distance measures over each criterion to both ideal (d_i^+) and nadir ideal (d_i^-) are developed and the ratio cl_{i+} is evaluated by $cl_{i+} = C_i = \frac{d_i^-}{d_i^+ - d_i^-}$. Finally to make the ratios useful for using in planed schedule, they are all normalized in the range of [0 1] as the weights of activities [4, 21, 37].
- Like the TOPSIS model, The FTOPSIS model is started with defining fuzzy decision matrix. In this paper the rule of thumb is used to translate the decision matrix to fuzzy decision matrix with triangular fuzzy numbers (\tilde{t}_{ij}) as its elements. The matrix is normalized (\tilde{T}) and then the standardized fuzzy weighted decision matrix is developed by $V = [\tilde{v}_{ij}] = [\tilde{w}_i \tilde{t}_{ij}]$. Fuzzy negative $\tilde{v}_j^- = (0,0,0)$ and fuzzy positive $\tilde{v}_j^+ = (1,1,1)$ ideals are assigned and the decision of each alternative from fuzzy negative and fuzzy positive ideals. The closeness coefficients are calculated and they are all normalized in the range of [0 1] as the fuzzy weights of activities [22, 30].

Empirical Example

As an empirical study, the planed schedule which is taking from literature of the research is widely used to have the same base in methods comparing. The data for this study were collected in winter 2010 in Kurdistan. The project contains 121 activities in 4 WBS levels when three types of DMs were asked for establishing WBS and time-scaled plan in MSP software. Evaluation process is demonstrated as follows:

GAHP and FGAHP in practice

The hierarchical structure is portrayed in Figure 1 and DM's judgment about criteria, λ_{max} and CR for all three DMs are illustrated in Table 1.

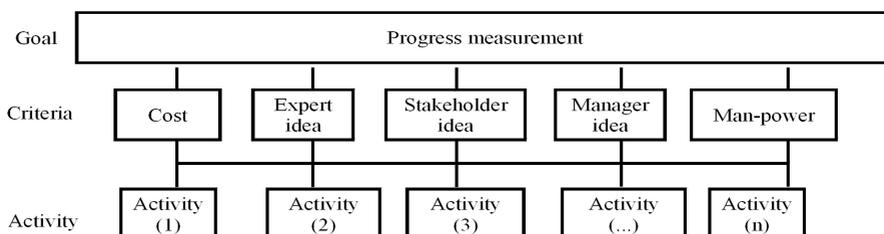

Figure 1. The case study problem's decision-making hierarchy



Following the GAHP process, lead the method to develop the consolidated criteria weight that is $W=(0.4341, 0.1272, 0.1844, 0.1236, 0.0884)$. Similarly, following the FGAHP process, lead the method to evaluate the consolidated weight as illustrated in Table 2.

TOPSIS and FTOPSIS in Practice

The data are gathered by using a special format and then Five-point Likert as used to transform quantitative performance ratings to qualitative ones. Following the TOPSIS model lead us to attain the activity weights as shown in Table 3 -column NFMW- and installing the FTOPSIS is lead us to gain the fuzzy weights as simultaneously illustrated in Table 3 – column FMW.

Table 1

Three DMs pairwise comparison matrix of criterion

DM ^{1,2,3}	Cost (BCWP)			Experts Idea			Stakeholder Idea			Manager Idea			Man-power		
	DM			DM			DM			DM			DM		
	1	2	3	1	2	3	1	2	3	1	2	3	1	2	3
	Cost (BCWP)	1	1	1	5	2	0.5	3	2	0.5	3	5	0.6	7	7
Experts Idea	0.2	0.5	2	1	1	1	1/3	0.5	3	0.5	3	5	2	2	1
Stakeholder Idea	1/3	0.5	2	3	2	1/3	1	1	1	2	3	1	3	5	0.5
Manager Idea	1/3	0.2	1/0.6	2	0.5	0.2	0.5	0.2	1	1	1	1	2	2	0.5
Man-power	1/7	1/7	5	0.5	0.5	1	1/3	0.2	2	0.5	0.5	2	1	1	1
	DM ¹			$\lambda_{max} : 5.09$						CR: 0.019					
	DM ²			$\lambda_{max} : 5.10$						CR: 0.022					
	DM ³			$\lambda_{max} : 5.23$						CR: 0.052					

Table 2

Consolidated fuzzy criteria weights

	Fuzzy weight (\tilde{w})
Cost (BCWP)	(0.1413, 0.2451, 0.4527)
Experts Idea	(0.0925, 0.1653, 0.3128)
Stakeholder Idea	(0.1071, 0.1928, 0.3593)
Manager Idea	(0.6103, 0.1091, 0.2064)
Man-power	(0.5940, 0.1004, 0.1903)

Comparison between the Two Proposed Methods and the Previous Ones

The S-curve for cash flow of the case by using Milestone, BOQ, and the two proposed methods are extracted. The results are graphically illustrated in Figure 2.



Figure 2 shows that the S-curves of the proposed methods stand near the S-curves of two traditional methods. The adjustments are demonstrated statistically by using hypothesis analysis that is illustrated in Table 4.

Hypothesis analysis in Table 4 shows the significant difference between BOQ and Milestone methods and also the insignificant differences between the two proposed methods and any of the two traditional ones. So we can correctly use the proposed method instead of the BOQ and Milestone methods. Moreover, one can see that if α is approximately equal to 0.09 – pessimistic think in comparison with $\alpha = 0.05$ – the non-fuzzy method is still being a substitution of the two traditional methods – the null hypothesis is still accepted. But with this new α the null hypothesis is rejected in the case of fuzzy method. So, the hypothesis results show that in this case, the proposed non-fuzzy model stands in the better position in comparison with the fuzzy method.

Conclusion

In this paper, the two new comprehensive methods, one of them is using the GAHP and TOPSIS and the other one is using the FGAHP and FTOPSIS, are proposed in order to define the activity weights of projects. The results show superiority of the two proposed methods in case of comprehensiveness and flexibility in comparison with the other methods. Moreover, superiority of the methods is compared with the traditional methods. The results show that in this case, the non-fuzzy method is the better substitution for the two traditional ones.

Table 3

Activities Weights Evaluated by MCDM and FMCDM

ID	NFMW	FMW	ID	NFMW	FMW	ID	NFMW	FMW	ID	NFMW	FMW
1	3.133	0.78	31	3.912	0.78	61	0.307	0.85	91	0.199	0.84
2	0.748	0.84	32	0.377	0.78	62	0.22	0.84	92	0.199	0.84
3	0.12	0.69	33	0.266	0.9	63	0.417	0.8	93	0.199	0.84
4	0.256	0.8	34	0.308	0.84	64	0.22	0.84	94	0.143	0.74
5	5.299	1.08	35	0.272	0.78	65	0.22	0.84	95	0.143	0.74
6	0.351	0.84	36	0.474	0.69	66	0.307	0.84	96	0.194	0.74
7	0.199	0.74	37	0.2	0.78	67	0.22	0.84	97	0.194	0.74
8	0.252	0.8	38	0.404	0.88	68	0.417	0.8	98	0.38	1
9	5.688	0.98	39	0.553	1	69	0.273	0.84	99	0.269	0.84
10	0.22	0.84	40	2.114	0.88	70	0.273	0.84	100	0.336	0.88
11	0.15	0.74	41	0.315	0.94	71	0.371	0.94	101	0.288	0.76
12	0.583	0.84	42	0.315	0.94	72	0.22	0.84	102	0.224	0.72
13	0.166	0.78	43	0.171	0.84	73	0.457	0.9	103	0.191	0.67
14	11.33	1.17	44	0.315	0.94	74	0.215	0.84	104	0.322	0.9
15	0.821	0.8	45	0.255	0.8	75	0.171	0.84	105	0.274	0.84
16	0.307	0.69	46	0.225	0.84	76	0.311	0.9	106	0.264	0.78
17	5.679	0.98	47	0.22	0.84	77	0.137	0.69	107	0.287	0.76
18	3.189	0.72	48	0.338	0.9	78	0.245	0.84	108	0.224	0.72



Project Management Development – Practice and Perspectives

First International Scientific Conference on Project Management in the Baltic Countries

February 8-9, 2012, Riga, University of Latvia

ID	NFMW	FMW	ID	NFMW	FMW	ID	NFMW	FMW	ID	NFMW	FMW
19	0.138	0.78	49	0.262	0.84	79	0.245	0.84	109	0.191	0.67
20	3.127	0.69	50	0.189	0.69	80	0.245	0.84	110	0.371	0.94
21	0.125	0.78	51	0.22	0.84	81	0.245	0.84	111	0.269	0.84
22	22.79	1.63	52	0.329	0.8	82	0.746	0.9	112	0.264	0.78
23	1.085	0.84	53	0.262	0.85	83	0.236	0.84	113	0.288	0.76
24	0.872	0.78	54	0.199	0.75	84	0.302	0.88	114	0.224	0.72
25	0.221	0.84	55	0.22	0.84	85	1.117	1	115	0.101	0.67
26	0.15	0.74	56	0.244	0.74	86	0.318	0.9	116	0.371	0.94
27	0.793	0.69	57	0.199	0.74	87	0.318	0.9	117	0.269	0.84
28	0.295	0.69	58	0.427	0.9	88	0.318	0.9	118	0.264	0.78
29	0.537	0.69	59	0.199	0.74	89	0.318	0.9	119	0.288	0.76
30	0.223	0.69	60	0.199	0.74	90	0.199	0.84	120	0.224	0.72
									121	0.101	0.67

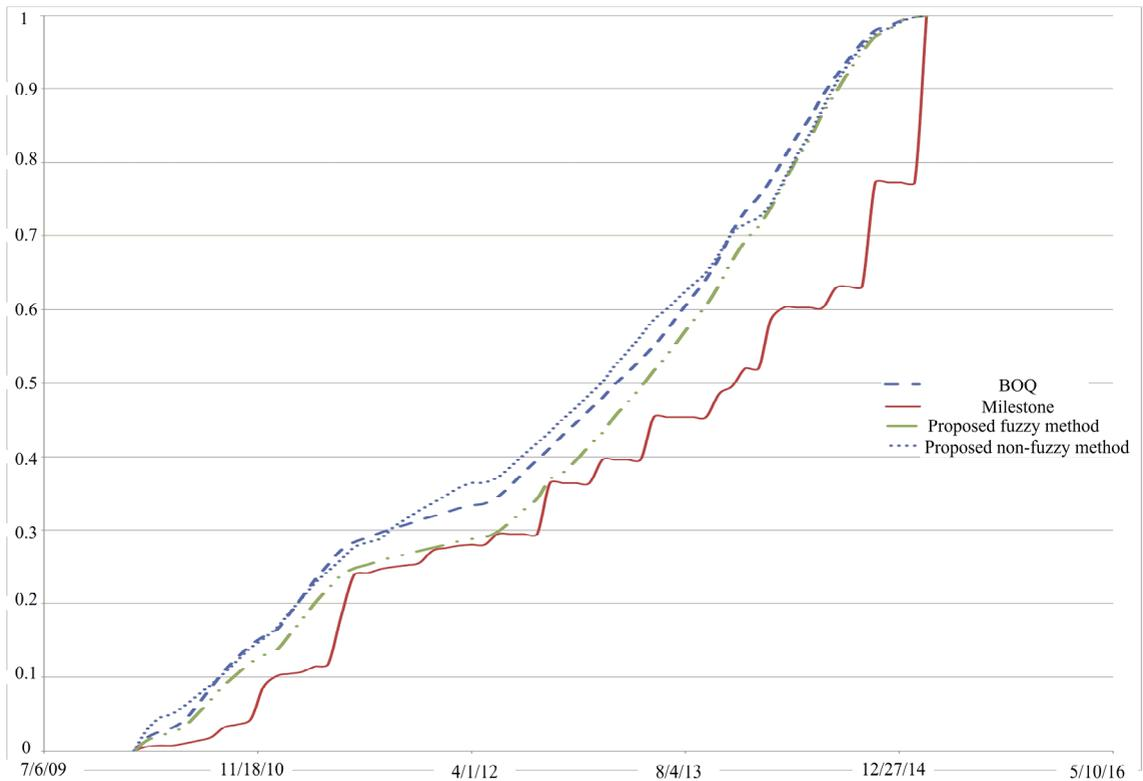

Figure 2. S-curves of milestone, BOQ and proposed methods



Table 4

Hypothesis results

BOQ method can substituted by Proposed non-fuzzy method	Null hypothesis is accepted	BOQ vs. Proposed non-fuzzy	$Z_{\alpha/2} > (Z = 0.7188)$
Milestone method can substituted by Proposed non-fuzzy method	Null hypothesis is accepted	Milestone vs. Proposed non-fuzzy	$Z_{\alpha/2} > (Z = 1.6995)$
Milestone method cannot substituted by BOQ method	Null hypothesis is not accepted	BOQ vs. Milestone	$Z_{\alpha/2} < (Z = 2.0360)$
BOQ method can substituted by Proposed fuzzy method	Null hypothesis is accepted	BOQ vs. Proposed fuzzy	$Z_{\alpha/2} > (Z = 0.0148)$
Milestone method can substituted by Proposed fuzzy method	Null hypothesis is accepted	Milestone vs. Proposed fuzzy	$Z_{\alpha/2} > (Z = 1.9390)$
$\alpha = 0.05 \Rightarrow Z_{\alpha} = 1.96$			

References

1. Barber, E., Miley, F., Monitoring project progress: more than a series of feedback loops, Australasian Evaluation Society International Conference, 2002, pp. 1-9.
2. Levine, Harvey, Practical project management tips, tactics, and tools, New York, John Wiley and Sons, INC, 2002.
3. Shenhar, A.J., Levy, O., Driv, D., Mapping the dimensions of project success, Project management journal, 28 (2), 1997, pp. 5-13.
4. Golpîra, H., Moradi, V., Application of TOPSIS and Group AHP for Project Management, in Proc. Iran 4th international conference of operations research society, 2011.
5. Barrie, D.S., Paulson, B.C., Professional Construction Management, McGraw-Hill, New York, 1992, pp. 252-274.
6. Pinto J. K., Slevin, D., P., Project success: definitions and measurement techniques, Project management journal, 19(3), 1988, pp. 67-73.
7. Jung, Y., Gibson, G.E., Planning for computer integrated construction, J. Comput. Civ. Eng. 13(4), 1999, pp. 217-225.
8. Clark, F.D., Lorenzoni, A.B., Applied cost engineering, Marcel Dekker, New York, 1978.
9. Rasdorf, W.J., Abudayyeh, O.Y., Cost-and schedule control integration: issues and needs, J. Constr. Eng. Manage. 117(3), 1991, pp. 486-502.
10. Department of Defense (DoD), Cost and schedule control systems criteria for contract performance measurement, Document No. DOD/CR-0017, Washington, D.C, 1980.
11. Teicholz, P.M., Current needs for cost control systems, Project controls: needs and solutions C. W. Ibbs and D. B. Ashley, eds., ASCE, New York, 1987, pp. 47-57.
12. Stevens, W.M., Cost control: Integrated cost/schedule performance, J. Manage. Eng. 1986, pp. 157-164.
13. Eldin, N.N., Measurement of work progress: Quantitative technique, J. Constr. Eng. Manage. 115(3), 1989, pp. 462-474.
14. Paolini, Jr., A., Glaser, M.A., Product selection methods to pick winners, Research Management 20, 1977, pp. 26-29.
15. DeCotiie, T.A., Dyer, L., Defining and measuring project performance, Research Management 16, 1979, pp. 17-22.



16. Yong, C.Y., Park, C.J., Kim, J.H., Kim, J.J., Management of daily progress in construction project of multiple apartment buildings, *J. Constr. Eng. Manage.*, 2007, pp. 242-253.
17. Wazed, M.A., Ahmad, S., Project management maturity models (PMMM) in developing on-line statistical process control software: an integrated approach, *Journal of applied science research*, 5(11), 2009, pp. 1904-1914.
18. Hamilton, A., *Managing projects for success*, Tomas Telford Ltd. 2001.
19. Clough, R., Sears, G., *Construction contracting*, Indianapolis, John Wiley & Sons, Inc. 1994.
20. Williams, A., *Contemporary business statistics*, Florence: Thomas learning, 2001.
Freeman, M., Beale, P., Measuring project success, *Project Management Journal*, 13(1), 1992, 9-16.
21. Golpîra, H., Moradi, V., New Method to Calculating Projects Progress, Based on Multi Criteria Decision Making, *J. Industrial management*, Faculty of humanities, Islamic Azad university of Sanandaj, 2011.
22. Golpîra, H., Fuzzy method for project success achievement, in *Proc. Iran international project management conference*, 2011.
23. Saaty T.L., Vargas L.G., Comparison of eigenvalue, logarithmic least squares and least squares methods in estimating ratios, *Mathematical Modeling*, 1984, pp. 5-309.
24. Saaty, T.L., *Fundamentals of decision making and priority theory with the analytic hierarchy process*, AHP series 2nd edition, 2nd printing, RWS Publication, Pittsburgh 2006, 6, p. 77.
25. Bellman, R.E., Zadeh, L.A., Decision making in a fuzzy environment, *J. Management Science* 17, 1970, pp. 141-164.
26. Buckley, J.J., Ranking alternatives using fuzzy numbers, *Fuzzy Sets and Systems* 10, 1985, pp. 21-31.
27. Tanino, T., Fuzzy preference orderings in group decision making, *Fuzzy Sets and Systems* 12, 1984, pp. 117-131.
28. Bezdek, J., Spillman, B., Spillman, R.A., Fuzzy relation spaces for group decision theory: an application, *Fuzzy Sets and Systems* 2, 1979, pp. 5-14.
29. Kacprzyk, J., Fedrizzi M., Nurmi, H., Group decision making with fuzzy majorities represented by linguistic quantifiers, in: D. Dubois, H. Prade, R. R. Yager (Eds.), *Readings in Fuzzy Sets for Intelligent Systems*, Morgan Kaufmann, Los Altos, CA, 1993.
30. Torfi, F., Farahani R. Z., Rezapour, S., Fuzzy AHP to determine the relative weights of evaluation criteria and Fuzzy TOPSIS to rank the alternatives, *Elsevier* 10, 2010, pp. 520-528.
31. Sun, C.C., A performance evaluation model by integrating fuzzy AHP and fuzzy TOPSIS methods, *Expert systems with applications*, 10.1016/j.eswa.2010.04.066.
32. Gumus, A.T, Evaluation of hazardous waste transportation firms by using a two-step fuzzy-AHP and TOPSIS methodology, *Expert system and applications* 36, 2009, pp. 4067-4074.
33. Hwang, C.L., Yoon, K., *Multiple attribute decision making: methods and applications*, Springer, Berlin, Heidelberg, 1981.
34. Yang, T., Hung, C.C., Multiple-attribute decision-making methods for plant layout design problem, *Robotics and Computer-integrated manufacturing* 23, 2007, pp. 126-137.
35. Tsaour, H., Chang, T., Yen C., The evaluation of airline service quality by fuzzy MCDM, *Tour. Manage*, 23, 2002, pp. 107-115.
36. Carlson, C., Tackling an MCDM-problem with the help of some results from fuzzy set theory, *Eur. J. Opera. Res.*, 10, 1982, pp. 270-281.
37. Golpîra, H., Noorossana, R., Improve and applying the balance scorecard for organizational improvement measurement, *J. Industrial management*, Faculty of humanities, Islamic Azad university of Sanandaj, 2008.



REAL PROJECT SUCCESS MEASUREMENT BY USING DATA ENVELOPMENT ANALYSIS

Hêriş Golpîra

*Department of Industrial Engineering
Sanandaj Branch, Islamic Azad University
Sanandaj Branch, Sanandaj, Iran
E-mail: H_Golpira@iausdj.ac.ir*

Keywords: Project success, S-curve, DEA, Hypothesis

Abstract

This paper addresses the realistic model for project success measurement. The proposed scheme defines a reliable weight factor for projects activities in order to gain the upper level of accuracy in the term of project measurement as the important factor for managing projects. The method accurately considers all of the project success factors in any type of project by using data envelopment analysis (DEA) method with ideal decision making unit (IDMU) and anti-ideal decision making unit (ADMU). This makes it not only more comprehensive, flexible and reliable method in comparison with the other previous ones but also preferable by all projects main elements. Empirical results show the viability of the proposed method.

Introduction and Literature Review

Success of a project depends on well-defining the schedule, cost and quality as the three traditional main criteria, directly affect the project success [1]. The closeness of schedule and cost leads researchers proposes several models by combining those two criteria [2]. As well as the cost, several researchers explore human factor [1], type of project [3] and customer satisfaction as project success critical factors [4]. Moreover, the success is initiated as a multi-dimensional multi-criteria approach [3], which leads Golpîra proposes a new comprehensive method based on fuzzy multi-criteria decision making in 2011 [5]. Golpîra and Moradi, also develops a method based on multi-criteria decision making in 2011 [6, 7].

Monitoring and controlling these criteria, which is based on project progress measurement is the most important term. Project progress measurement not only directly affects the project success, but also used as the base of payment to contractor, which is done based on two methods named Milestones (0/100) and bill of quantity (BOQ or 0-100) methods. It is proved that there is significant difference between these two methods and it is the challenge. In this case, Hughes in 1986 provides six cusses for projects failures that contain poor attention on the project management system [8]. Brooks in 1995 introduces the submission to the unrealistic customers due date and poor monitoring of project progress as the two cusses for failure in IT projects [9]. Black in 1996 introduces the poor planning, project changes and poor scheduling as the three cusses for failure in projects [10].



In addition to these researchers, Browne (2001), Pitagorsky (2001), Matta and Ashkenas (2003) Neimat (2005) and Golpîra (2011) point out the success factors of projects and note the causes of projects failures [5, 6, 7].

This paper proposes an advanced weighting method that considers all of the main factors to achieve the correct progress measurement. The method accurately considers all of the project success factors in any type of project by using DEA method with IDMU and ADMU. The rest of this paper organized as follows. Section 2 describes the model in detail. In section 3, simulation details and results are explained and finally, section 4 concludes the paper.

Principles of DEA Method with IDMU and ADMU

Charnes et al. [11] introduced DEA to evaluate decision making units (DMUs) from the best one [12]. Entani et al. [13] and Wang et al. [14] developed the model until Wang et al. [12] proposed their model based on the relative closeness (RC) to the IDMU that may be used for ranking of all DMUs [12]. This recent advanced method is used in this paper, which is introduced below:

Assume that there are n DMUs to be evaluated. Each of them consumes m inputs, denoted by x_{ij} ($i = 1, \dots, m, j = 1, \dots, n$), to produce s outputs denoted by y_{rj} ($i = 1, \dots, s, j = 1, \dots, n$). Then, an IDMU may be the DMU that can use the least inputs, x_i^{\min} ($i = 1, \dots, m$), to produce the most outputs, y_r^{\max} ($r = 1, \dots, s$), while an ADMU consumes the most inputs, x_i^{\max} ($i = 1, \dots, m$), to make the least outputs, y_r^{\min} ($r = 1, \dots, s$).

To completing the model, the LP model shown in Eq. (1) and Eq. (2) must be solved for all DMUs such as DMU_0 to calculate the $\theta_{j_0}^*, \varphi_{j_0}^*$, where j_0 is the DMU under evaluation (denoted by DMU_0), u_r, v_i are decision variables, ε is the non-Archimedean infinitesimal, θ_{IDMU}^* is the optimum efficiency of IDMU that may be calculated by Eq. (3) and φ_{ADMU}^* is the worst efficiency of the ADMU that may be calculated by Eq. (4).

After this step, the RC index may be calculated to combine the best and the worst possible relative efficiencies, for all DMUs by Eq. (5). It is clear that the bigger the RC_{j_0} value, the better the performance of DMU_0 [12].

$$\begin{aligned}
 \text{Max} \quad & \theta_{j_0} = \sum_{r=1}^s u_r y_{rj_0} \\
 \text{S.T.} \quad & \sum_{i=1}^m v_i x_{ij_0} = 1 \\
 & \sum_{r=1}^s u_r y_j^{\max} - \sum_{i=1}^m v_i (\theta_{IDMU}^* x_i^{\min}) = 0 \\
 & \sum_{r=1}^s u_r y_{rj} - \sum_{i=1}^m v_i x_{ij} \leq 0 \quad j = 1, \dots, n \\
 & u_r, v_i \geq \varepsilon \quad \forall r, i
 \end{aligned} \tag{1}$$



$$\begin{aligned}
 \text{Max} \quad & \varphi_{j0} = \sum_{r=1}^s u_r y_{rj0} \\
 \text{S.T.} \quad & \sum_{i=1}^m v_i x_{ij0} = 1 \\
 & \sum_{r=1}^s u_r y_{rj}^{\min} - \sum_{i=1}^m v_i (\varphi_{IDMU}^* x_i^{\max}) = 0 \\
 & \sum_{r=1}^s u_r y_{rj} - \sum_{i=1}^m v_i x_{ij} \leq 0 \quad j = 1, \dots, n \\
 & u_r, v_i \geq \varepsilon \quad \forall r, i
 \end{aligned} \tag{2}$$

$$\begin{aligned}
 \text{Max} \quad & \theta_{IDMU} = \sum_{r=1}^s u_r y_r^{\max} \\
 \text{S.T.} \quad & \sum_{i=1}^m v_i x_i^{\min} = 1 \\
 & \sum_{r=1}^s u_r y_{rj} - \sum_{i=1}^m v_i x_{ij} \leq 0 \quad j = 1, \dots, n \\
 & u_r, v_i \geq \varepsilon \quad \forall r, i
 \end{aligned} \tag{3}$$

$$\begin{aligned}
 \text{Max} \quad & \varphi_{ADMU} = \sum_{r=1}^s u_r y_r^{\min} \\
 \text{S.T.} \quad & \sum_{i=1}^m v_i x_i^{\max} = 1 \\
 & \sum_{r=1}^s u_r y_{rj} - \sum_{i=1}^m v_i x_{ij} \leq 0 \quad j = 1, \dots, n \\
 & u_r, v_i \geq \varepsilon \quad \forall r, i
 \end{aligned} \tag{4}$$

$$RC_{j0} = \frac{\varphi_{j0}^* - \varphi_{ADMU}^*}{(\varphi_{j0}^* - \varphi_{ADMU}^*) + (\theta_{IDMU}^* - \theta_{j0}^*)} \tag{5}$$

Empirical Example

As an empirical study, a building is proposed as an empirical sample of construction projects to demonstrate usefulness of the proposed method. The data for this study were collected in May 2011 in Kurdistan. The project contains 45 activities in 4 WBS levels that are scheduled in Microsoft project software.

As previously explained, DEA may use several inputs and also several outputs. In this paper, man power, cost (without cost of machine and manpower), machine power, total float and duration are used as the inputs and the effect of each activity on quality of project is used as the output of the model. By these data, DEA model lead us to have activities weight factor (WF) as shown in Table 1.



Table 1

Summary of applying DEA model on activities data

DMU	φ^*	Θ^*	RC	WF	DMU	φ^*	Θ^*	RC	WF
Activity 1	3.983868	1.63E-02	0.08	0.65	Activity 23	1.898369	2.81E-02	0.04	0.31
Activity 2	0.9979796	6.17E-03	0.02	0.16	Activity 24	3.506774	0.5333186	0.07	0.58
Activity 3	2.571278	1.59E-02	0.05	0.42	Activity 25	2.657979	0.2227359	0.06	0.44
Activity 4	2.085818	7.28E-02	0.04	0.34	Activity 26	11.93014	3.68E-02	0.21	1.68
Activity 5	38.18633	0.26153	0.47	3.68	Activity 27	23.63772	0.1288131	0.35	2.76
Activity 6	19.61288	6.80E-02	0.31	2.44	Activity 28	3.932085	0.4588145	0.08	0.64
Activity 7	14.65174	0.35062	0.25	1.98	Activity 29	5.145933	0.13462	0.10	0.82
Activity 8	74.00567	0.19239	0.63	4.95	Activity 30	1.900858	0.1280524	0.04	0.31
Activity 9	75.13824	0.20338	0.64	4.98	Activity 31	33.02407	0.2587316	0.43	3.40
Activity 10	106.7761	0.21575	0.71	5.58	Activity 32	11.51107	0.9609657	0.21	1.66
Activity 11	7.914768	0.59913	0.15	1.21	Activity 33	3.359401	0.1075177	0.07	0.55
Activity 12	157.0512	0.49167	0.79	6.15	Activity 34	4.785098	3.10E-02	0.10	0.77
Activity 13	1	0.15861	0.02	0.16	Activity 35	15.85441	7.81E-02	0.27	2.09
Activity 14	116.0098	1	0.73	5.74	Activity 36	4.630582	4.39E-02	0.09	0.74
Activity 15	162.3392	0.93393	0.79	6.21	Activity 37	8.28091	2.21E-01	0.16	1.25
Activity 16	8.053274	1	0.16	1.24	Activity 38	2.932299	6.43E-02	0.06	0.48
Activity 17	82.53478	0.41375	0.66	5.15	Activity 39	95.01048	1.00E+00	0.69	5.42
Activity 18	86.83495	0.21644	0.67	5.23	Activity 40	77.63913	5.35E-01	0.64	5.05
Activity 19	5.65442	0.3412	0.11	0.90	Activity 41	19.15277	7.60E-01	0.31	2.42
Activity 20	8.406416	5.54E-01	0.16	1.28	Activity 42	2.768869	5.03E-03	0.06	0.46
Activity 21	65.36616	0.37952	0.60	4.73	Activity 43	1.784115	4.12E-03	0.04	0.29
Activity 22	4.523726	0.65758	0.09	0.74	Activity 44	40.56359	3.23E-01	0.49	3.80
					Activity 45	1	5.73E-03	0.02	0.16
$\Theta^*(IDMU)$			43.25681	$\varphi^*(ADMU)$		0.10031			

Results and Conclusion

To make a comparison between the method and the two traditional ones, the S-curves of project by applying these three methods are extracted as shown in Fig. 1.

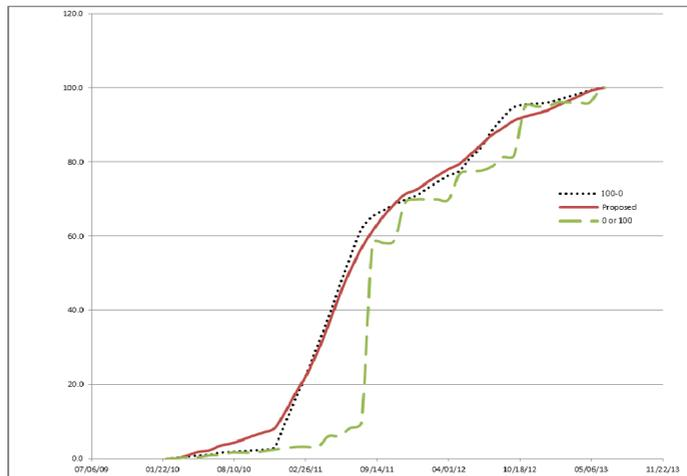

Figure 1. S-curves of milestone, BOQ and proposed method



The achieved adjustment demonstrated mathematically however it clearly indicated in Fig.1. one can see the adjustment not only in the position of the curve in comparison with the other ones, but also in the shape and smoothness of it. This demonstration has been constructed by using hypothesis analysis and the results are illustrated in Table 2.

Table 2

Hypothesis results

Statistical analysis (sample size =20)			Conclusion	
			$\alpha = 0.12 \Rightarrow Z_{\alpha/2} = 1.55$	
BOQ	Mean	23652716216.08	BOQ vs. Proposed	$Z_{\alpha/2} > Z$
	Variance	4370452809278920		
Proposed	Mean	25768473982.8304	Milestone vs. Proposed	$Z_{\alpha/2} > Z$
	Variance	3719323919351940		
Milestone	Mean	92209816106	BOQ vs. Milestone	$Z_{\alpha/2} < Z$
	Variance	3.81367366284307E+22		
BOQ vs. Proposed	S=40448883643154300	Z=1.51416826726693	BOQ vs. Proposed	Null hypothesis is accepted
	S=1.92868909546793E+21			
Milestone vs. Proposed	S=1.92868909546793E+21	Z=0.332669261303247	Milestone vs. Proposed	Null hypothesis is accepted
	S=1.92543345101829E+21			
BOQ vs. Milestone	S=1.92543345101829E+21	Z=1.56106621676416	BOQ vs. Milestone	Null hypothesis cannot accepted
	S=1.92543345101829E+21			

Hypothesis analysis in Table 2 shows the significant difference between two traditional methods (it's proved by previous researches) and also the insignificant differences between the proposed method and any of the two traditional ones. Note that by pessimistically considering α being 0.12, so we can correctly use the proposed method instead of the BOQ and Milestone methods.

In this paper, the usage of DEA with IDMU and ADMU method for defining activities weight factors is examined. The method can consider all of variables that may affect the project progress all together. The simplicity and flexibility of the method and its success in getting agreement of all project elements make it better than the previous ones.

References

1. Barber, Elizabeth, and Miley, Frances, Monitoring project progress: more than a series of feedback loops, Australasian evaluation society international conference, 2002, pp. 1-9.
2. Rasdorf, W. J., and Abudayyeh, O. Y., Cost-and schedule control integration: issues and needs, J. Constr. Eng. Manage. 117(3), 1991, pp. 486-502.
3. Freeman, M. and Beale, P., Measuring project success, Project Management Journal, 13(1), 1992, pp. 9-16.



Project Management Development – Practice and Perspectives

First International Scientific Conference on Project Management in the Baltic Countries

February 8-9, 2012, Riga, University of Latvia

4. Pinto J. K., Slevin, D., P., Project success: definitions and measurement techniques, *Project management journal*, 19(3), 1988, pp. 67-73.
5. Golpîra, H., Fuzzy method for project success achievement, in *Proc. Iran international project management conference*, 2011.
6. Golpîra, H., Moradi, V., Application of TOPSIS and Group AHP for Project Management, in *Proc. Iran 4th international conference of operations researches society*, 2011.
7. Golpîra, H., Moradi, V., A new method for calculating project progress based on Multi-criteria decision making, *Journal of Industrial Management, Islamic Azad University of Sanandaj*, 14, 2011.
8. Hughes, M.W., Why projects fail: The efforts of ignoring the obvious, *Industrial Engineering*, 1986, pp. 14-18.
9. Brooks, F.P., *The mythical man-month, Anniversary Edition*. Boston: Addison-Wesley, 1995.
10. Black, K., Causes of project failure: A survey of professional engineers, *PM Network* 1996, 21–24.
11. Charnes, A., Cooper, W. W., and Rhodes, E., Measuring the efficiency of decision making units, *European Journal of Operation Research*, 2, 1978, pp. 529-444.
12. Wang, Y. M. and Luo, Y., DEA efficiency assessment using ideal and anti-ideal decision making units, *Applied Mathematics and Computation*, 173, 2006, pp. 902-915.
13. Entani, T., Maeda, Y. and Tanaka, H., “Dual models of interval DEA and its extension to interval data”, *European Journal of Operational Research*, 136, 2002, pp. 32-45.
14. Wang, Y. M., Greatbanks, R., and Yang, J. B., “Measuring the efficiency of decision making units using interval efficiencies”, *European Journal of Operation Research*, 2007.



THE USE OF APPLICATION FRAMEWORKS IN SOFTWARE DEVELOPMENT PROJECTS: A SYSTEM DYNAMICS MODEL

Alejandro Gutiérrez

University of Basque Country

Alameda de Urquijo s/n, 48013, Bilbao – VIZCAYA, Spain

Phone: +346 62078491

E-mail: alejandrogzlpz@gmail.com

José Ramón Otegi

University of Basque Country

Alameda de Urquijo s/n, 48013, Bilbao – VIZCAYA, Spain

Phone: +346 05789248

E-mail: joserra.otegi@ehu.es

Keywords: Technology assessment, System Dynamics, Software development, Project Management, Application Frameworks

Abstract

Technology selection is a critical decision in projects and organizations. Using system dynamics models is possible to analyze how a technology could impact aspects of the project and the organization. In this paper, the application framework technology is analyzed. Application frameworks are a reuse technique for software development projects. The purpose of this study is to generate and test a model with which project managers will be able to better understand the implications before implementing this technology. The results of how different reuse levels due to a framework and its learning affect the coding phase are presented.

1. Introduction

The objective of delivering projects and products on time, with an expected quality and in budget is part of the day to day in the software industry. Different technologies try to improve these and other aspects of software processes and projects from various angles and in different project phases, for example: fourth-generation programming languages, case tools, commercial off-the-shelf components (COTS) and application frameworks, among many others. Furthermore, new technologies appear constantly and most of them are in constant evolution themselves.

Project managers, software architects and software engineers need to make critical decisions concerning the technologies that will be used in their projects. Unfortunately, making these decisions is no trivial task.

An adequate method to assess the technology effectiveness would be an evaluation based on the analysis of empirical data from pilot projects before the introduction of an improvement action (such as introducing a new technology) [1]. But in large-scale industrial software



production environments, performing experiments with alternative development technologies in real projects is considered time-consuming and costly [1].

Project managers could also analyze the selected technology after the project conclusion as preparation for future projects, but this alternative can be expensive; in such case, a project manager needs to use the project resources in order to get that experience.

Additionally, making a correct selection is difficult because human beings can't perceive complex relations easily, and software development is riddled with this kind of relations. Software development projects are integrated by several different interrelated entities (methods, people, processes, products, techniques and tools), forming a complex software development system [1].

An alternative to solve this difficulty is the use of models to simulate a project, a portion of its life cycle or a process, and analyze the implications of the technologies prior to its commitment. The process of building a model, simulating it and analyzing its behavior is a common engineering approach when experimentation on the real system is unfeasible [1].

A model "is an abstraction of a real or conceptual complex system" [2]. It doesn't include all the elements of a system, but only those relevant to the issue that one wants to study, predict, modify or control [2].

Using system dynamics, models can be constructed and simulated. System dynamics is a method to enhance learning of complex systems developed by Jay Forrester in 1950. It provides a methodology that allows integrating multiple perspectives in complex and dynamic processes [3] such as software development. According to John Sterman [3], it is a "perspective and set of conceptual tools that enable us to understand the structure and dynamics of complex systems" and it's "grounded in the theory of nonlinear dynamics and feedback control developed in mathematics, physics, and engineering".

System dynamics is part of the simulation approaches which enable organizations to gain insights and analyze the impacts of changes in their software development processes or organizations [2]. A software process could be defined as "a set of activities, methods, practices and transformations that people use to develop and maintain software and the associated products" [2].

System dynamics has been applied previously to assess the effects of technologies in software processes. Madachy [4] describes a model of the effects of reuse and fourth-generation languages (4GLs). In the same book, a research regarding the development time of glue code of COTS (Commercial Off-The-Shelf) components and their integration into a system is analyzed [4]. Ruiz et al. [5] analyze the implications of specific features of a COTS-based software development process.

Outside the software development industry, system dynamics has also been applied to assess technologies. Wolstenholme [6] carries out a technology assessment of two management information systems for defense organizations. Additionally, Wolstenholme [6] explores the benefits of introducing a new anesthetic drug at hospitals. In Stavredes [7], a model is used to understand the important variables that are involved in the success or failure of implementing technology enhanced learning environments within higher education.

Wolstenholme also introduces a framework for technological assessment at an intermediate level based on system dynamics [6]. This assessment could be located between the high level view given by an economic analysis and a low level from a detailed analysis of the characteristics and functionalities of a technology. To analyze the technology at an intermediate level, it is necessary to create a model based on the technology and the domain where it will be



used [6]. A previous difficulty in developing an intermediate assessment was the lack of suitable tools, but with system dynamics it is possible.

In this paper, we propose the application of a system dynamics model to analyze the effects and tradeoffs of implementing an application framework technology over the coding phase of software development projects.

Application frameworks are an object-oriented reuse technique [8] generally targeted to a particular application domain [9]. One commonly used definition of frameworks is “semi-complete application that can be specialized to produce custom applications” [10]. Their objective is the reuse of larger-grain components and high-level designs which differ to other reuse models such as libraries [11] [12], design patterns [12] and components [12].

At present, much of the research effort about application frameworks has been dedicated to the design and construction of frameworks. However, a comparable effort has not occurred in research regarding the evaluation of application frameworks. In Morisio et al. [11], two models for the evaluation of this technology are introduced; one of the models is for productivity and the other for quality. There are only a few models that a project manager could use to decide if implementing the technology is a feasible alternative. Unfortunately, this creates a difficulty for project managers to assess if an application framework is a viable technology for their projects.

Regarding this technology evaluation, there are questions which are not easily solved, for example: can benefits be reached in time if the framework learning curve is steep but the project is small?, is it better to have a steep framework learning curve but achieve a higher level of reusable functionalities for the project?, are the benefits reached if there is high quit rate among developers?. Using a system dynamics model, a project manager could analyze different scenarios before the introduction of the technology to decide if it is a viable alternative.

This paper is organized as follows: Section 2 introduces the existing problem and motivation for this study. Section 3 explains the simulation approach used to create the model. Section 4 clarifies the application frameworks technology and their use in software development projects. Section 5 explains the fundamental elements of the constructed model, describes its limitations, and presents the first results of its simulation. In section 6, this paper concludes with a brief summary of this study, along with our conclusions and further work.

2. Motivation and Problem Definition

The purpose of this research is to better understand the effects of implementing an application framework technology in software development projects. This research focuses on the technology use or implementation in software development projects but not on its development.

Unlike libraries, components, quality assurance tools and other technologies that can be removed from the software project without affecting the complete development; an application framework cannot be removed unless the software application code is completely rewritten. The decision of using a framework must be made at least before the coding phase begins. If not, the same situation applies; the application code must be rewritten with the framework.

Moreover, because a framework can't be easily removed, it will be part of the application for the complete duration of the application's life cycle. Therefore more research should be conducted on the implications of their use in software projects and their evaluation before being introduced into projects.



3. Simulation Approach

There are different simulation strategies, but there are two main approaches depending on how the represented system changes over time: discrete and continuous modeling [5].

Under a discrete-event view, each event is modeled. Here, discrete flows of entities move through the system at separated time points without considering their feedbacks. This is different from a continuous view, where individual events are not tracked; instead, the focus is on the behavior patterns of the model accumulations [4]. Under the continuous view, time changes at a constant rate and entities are considered as an aggregate that can be described using differential equations [4].

System dynamics uses a continuum with feedback approach. In a feedback or “closed” system approach, the system’s future behavior is influenced by its past actions, compared to an “open” perspective where the outputs are not influenced by the inputs. These feedback loops are what generate and control all that changes through time [4]. The results of modeling and simulating a system are used to improve the knowledge about it [2].

A system dynamics model uses a diagramming notation. The model’s most basic elements are stocks, also known as levels or accumulations, and flows, inflow and outflow. Levels keep track of the accumulations of elements in the model, for example: material, energy, information, knowledge, etc. Flows create the changes in levels. Sources and sinks indicate that there is an external infinite source of resources where the model process takes from and deposits them.

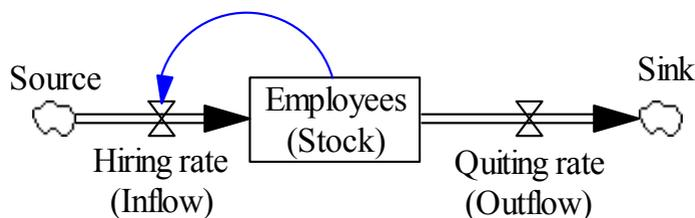

Figure 1. Diagramming notation of system dynamics

System dynamics models can be simulated using one of the different simulation software packages available, such as STELLA® [13], iThink® [13] and Vensim® [14]; we used the latter for this study.

4. Application Frameworks in Software Development Projects

4.1. Application frameworks

An application framework is a technology that allows the reuse of code and patterns via code [8]. They are usually composed of a hierarchy of related classes [11] and contain dynamic and static components that are customized when used to building an application [9].

Frameworks are different from other reuse approaches. Johnson [8] compares frameworks against components and pure designs which are other reuse techniques. He describes frameworks as more abstract and flexible than components, therefore providing more customization but with more complex interfaces. Compared to pure design, frameworks are



more concrete and easier to reuse, although more rigid and with less applications. Frameworks could be placed between these two reuse techniques [8].

Another difference representative of frameworks is the “inversion of control”. It consists in the framework establishing the flow of control that has to be accepted by the application, compared to a traditional development where the flow of control is defined by the application [11].

4.2. Software Development with an Application Framework

There are two main periods in the software development with an application framework, first the development of the framework (development for reuse) and the implementation of the framework in a specific development project (development with reuse).

The implementation of an application framework provides benefits and adds difficulties to software development. The benefits that appear constantly in the framework-based development literature are: savings in time to market [8] [11], effort and costs [11] [15], along with improvements in productivity [11] [15] and quality enhancement [11] [15]. These improvements are achieved as an obvious consequence of reusing code [8] [11], but also because reusing the designs that are part of the framework creates uniformity in the application [8].

On the negative side, frameworks have a steep learning curve, requiring a longer period of training for the programmer [11]. This learning curve can be a decisive factor in making a framework technology profitable [11]. Furthermore, they create dependency on the developed applications [8], which can affect the software maintenance.

As a result of the benefits and difficulties mentioned before, an organization should evaluate if this technology is adequate to accomplish their objectives. Reuse is valuable but not free[8]; there are expenses that the organization must consider.

Johnson [8] proposes that before using any reuse technique, its costs and benefits should be analyzed. Using our system dynamics model, different scenarios can be simulated to analyze the benefits and drawbacks of implementing a framework technology. After generating the different simulations, the potential benefits and drawbacks could be converted to monetary units.

5. Developing the Simulation Model for Application Frameworks

5.1. System Dynamics Model for Application Frameworks

For the purpose of this study, a system dynamics model has been developed. The model, introduced in Figure 1, was created using system dynamics models of software projects described in the literature and also elements that characterize the software development with an application framework. As mentioned before, an application framework is a technique that allows reusing code and patterns via code. Given that reuse takes place via code, the projects coding phase was taken as the domain of the technology in our model.

There are four subsections in the model: **projects, software development, human resources and framework learning.**

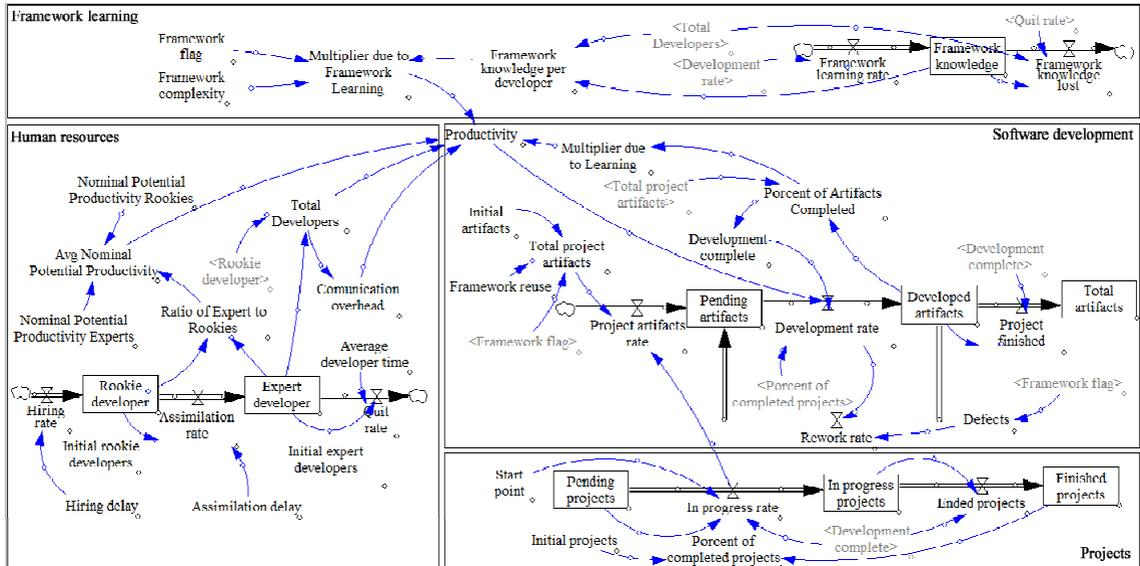

Figure 1. System dynamics model for application frameworks assessment

The subsection **projects** controls the projects in the model. The variable *Initial projects* controls the initial number of projects that will be developed, its value can be one or more projects. Projects are accumulated in three different levels: *Pending projects*, *In progress projects* and *Finished projects*. These levels represent, respectively, the projects that still need to be developed, are being developed and have been developed. Projects move through these three levels in a logical order, pending first, then in progress and after they are completed, they move to finished.

The subsection of **software development**, as the name indicates, controls the software development. In the model, projects are composed by a number of artifacts that must be developed. The term artifacts was used to avoid limiting the types of elements that can be simulated with the model, Abdel-Hamid and Madnick [16] use the term “task” instead. Artifacts can be, for example: lines of code, functions or object oriented function points (OOFPP). This paper uses OOFPP because the data and results used to calibrate the model were quantified in such measure.

If a project is going to be developed, the level of *Pending artifacts* increases. The *Pending artifacts* increase is based on the number of artifacts of which a project is composed - *Initial artifacts* – minus a percentage that will be reused because of the framework. The use of an application framework allows reusing, and therefore reducing, a percentage of the work. The model allows testing different percentages of artifacts reused in a project as a result of implementing a framework. The variable *Framework reuse* is used in the model to calculate the percentage of artifacts reused by the framework. Morisio et al. [11], use a reuse level to indicate the ratio between reused size and total size delivered; the average reuse level is 0.8 in a scale of 0-1. A value of 80% was considered to calibrate the model.

The model considers that the projects, and therefore their artifacts, are developed in sequence. In other words, the model considers that as soon as all the artifacts of a project are



completed, the artifacts for the next project will begin to be developed. This will continue until all pending projects are completed. *Pending artifacts* are developed at a certain rate - *Developed productivity* – based on the developers' *Productivity*.

The concept of quality applied in the model is related to the rework required to correct errors. In the model, the variable *Rework rate* is calculated based on a percentage of *Defects* occurred during development. Even though it is not included in our study, it is important to highlight that only the delay to detect errors and correct them during rework can create different effects in the simulation and therefore in the project.

Elements from Abdel-Hamid and Madnick's model [16] were incorporated for the **human resources** subsection. A simplification of the human resource management subsystem was included to test combinations of developer levels with different productivities. These differences in developers' productivity can be the result of experience in similar projects or in the organization. The productivities of the experts and the rookies can be found in the variables *Nominal Potential Productivity Experts* and *Nominal Potential Productivity Rookies*. These productivities are the rate at which artifacts are developed before the other modeled variables affect them. Given that there would be communication between developers, as it is documented in Abdel-Hamid and Madnick's work [16], a loss in productivity was also included.

In the model, the role of learning is fundamental. As mentioned before, application frameworks have a steep learning curve that must be considered if an organization is analyzing the use of this technology. As a result, two independent learning curves were included in the model. One learning curve corresponds to the increase of the project's knowledge as it is documented in Abdel-Hamid and Madnick [16]. According to Abdel-Hamid and Madnick [16], there is an increase in productivity that peaks at an increased value of 25% at the end of the project. This learning curve can be found in the **software development** subsection as *Multiplier due to Learning*.

The second learning curve - *Multiplier due to Framework Learning* – corresponds to the application framework knowledge and it is located in the **framework learning** subsection. Unlike the previous learning curve, gaining framework knowledge can take more than one project, as documented in Morisio et al. [11].

The framework's learning curve used in our model was generated from the productivity values in Morisio et al. [11]. In their study, Morisio et al. [11] documented an increase in productivity during the development of five applications using a proprietary framework [11]. To complete these five applications, 1370 OOFPs were developed, and an improvement of 7.26 OOFPs/Hour was achieved at the end. For our model, we converted the number of OOFPs developed in the five projects to percentages with the respective increase in productivity. Figure 2 shows the values of the framework learning curve used in the model.

In the figure 2, the input value represents the percentage of the framework knowledge that the developer acquires; this percentage is calculated based on the *Framework complexity* and the number of OOFPs that have been developed. In the model, the programmer gains framework knowledge by developing OOFPs. The output variable is the improvement in the productivity at OOFPs/Hour as a result of the framework knowledge acquired.

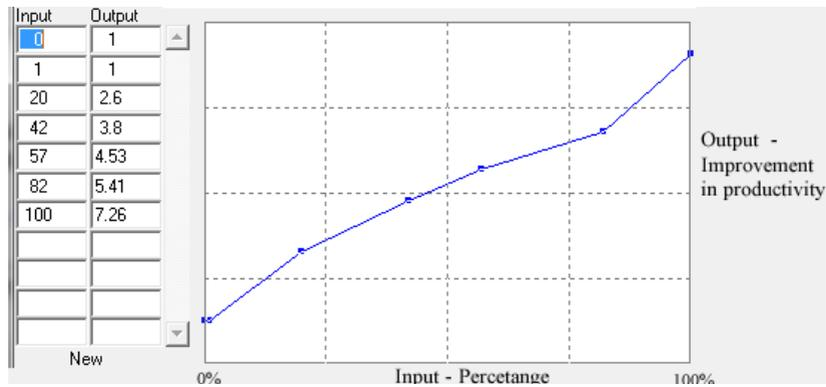

Figure 2. Values of Multiplier due to Framework Learning

The variable *Framework complexity* is used to indicate how many OOFp a programmer must develop to reach the maximum expected benefits in productivity as a result of framework usage. Changing *Framework complexity* will affect the amount of OOFp required to achieve the improvements. The effects of different framework difficulties can be analyzed by simulating different *Framework complexities*.

One difficulty of using dynamic simulations is the lack of available data to validate and populate the models [5]. To populate and validate our model, data exposed in Morisio et al. was used. [11]. Morisio et al. [11] conducted an exploratory case study with a single subject in a network division of a research and development company. In the case study, five applications were developed with an application framework and four without by the same programmer during a six month period. The changes in the productivity, quality and learning effect of the two development modes (with and without framework) are analyzed quantitatively. The programmer who participated in the case study was a novice in the particular framework used.

Morisio et al. [11] reports gains in terms of productivity and quality in the two development modes (with and without framework), but significantly higher in the development with the application framework. We consider important to highlight that the gains in productivity and quality presented in Morisio et al. [11] consider only new code developed and not the functions and code reused from the framework.

The framework used was proprietary of the company where the case study took place [11]. It was developed in JAVA and it used a Common Object Request Broker Architecture (CORBA) infrastructure and integrated some Commercial Off-The-Shelf (COTS) products. The framework can be categorized as a small to medium size framework [11]. It was composed of 22 classes with a size of approximately 10,000 SLOC (source lines of code). To know more about the framework characteristics, the development process or results please refer to Morisio et al. [11].

5.2. Model Limitations

A model doesn't include all the elements of a system; therefore, there are limitations of what can be simulated with it. In the following paragraphs know limitations of the constructed model are detailed.



The model is designed to evaluate the use of the technology (development with reuse), but not the framework technology development (development for reuse). Although there is no doubt that if an organization is considering developing a framework, its development costs and time should be analyzed as well.

The model only considers developers without knowledge of the framework and all the knowledge of the framework is acquired by developing artifacts, in this paper OOFP.

The coding phases of the projects are supposed to start and be developed in sequence. In other words, according phase of new project starts as soon as the previous is finished. This assumption could be false in organizations where there are down times between projects.

The model doesn't consider changes in the *Framework complexity* variable as a result of changes the *Framework reuse* variable. A change in the *Framework reuse* variable could result in an increase of the framework adaptability or flexibility, making it useful in more contexts. Nonetheless, this could also result in an increase of the framework complexity [12].

As a consequence of using data and results from Morisio et al. [11] to calibrate and test the model, the results are limited by the application area of their case study. For example, in Morisio et al. [11] there are productivity improvements after the five applications that used the framework for development, but whether the improvement will increase in future developments is unknown. However, our model's simulation can be used to generate different alternatives. For example, an alternative where the productivity improvements will be stabilized could be simulated.

Furthermore, it is important to highlight that the framework's learning curve and therefore the changes in productivity can be different between frameworks. More complex frameworks could create a negative effect in developer productivity.

5.3. First Simulation Results

The objective of the following section is to introduce the results of a tradeoff analysis between changes in the framework learning curve and the percentage of artifacts reused based on the model presented in Figure 1. To configure our model and generate the first results we have used the following values:

- The data and results of the simulation are in object oriented function points (OOFP).
- The number of projects developed with the framework technology is set to 5.
- The average size of each project is 1370 OOFP. After a reduction of 80% because of framework reuse, the average project size is 274 OOFP. This is the same size as the average application with a framework in Morisio et al. [11].
- A *Rework rate* of 10% is considered when developing with the framework.
- The number of *Initial expert developers* is set to 1 and *Initial rookie developers* is set to 0. This ratio is kept during the simulations.
- The *Experts' nominal potential productivity* is set at 1 OOFP/Hour.

Three scenarios were configured to test the effort in hours required to complete five projects. In scenario 1, it takes 1370 OOFP to reach the maximum level of benefits in productivity because of the framework learning curve; in scenario 2 takes half the effort (685 OOFP) and in scenario 3 takes twice the effort (2794 OOFP). With regards to the reuse level, scenarios 1 and 3 consider the same reuse level, an 80% reduction of the initial OOFP for each project; compared to a 60% reduction in scenario 2. The results of the simulation are presented in Figure 3.



Table 1

Scenarios' values for the simulation

Scenario	Framework complexity	Reuse level
Scenario 1	1370 OOFp	80%
Scenario 2	685 OOFp	60%
Scenario 3	2749 OOFp	80%

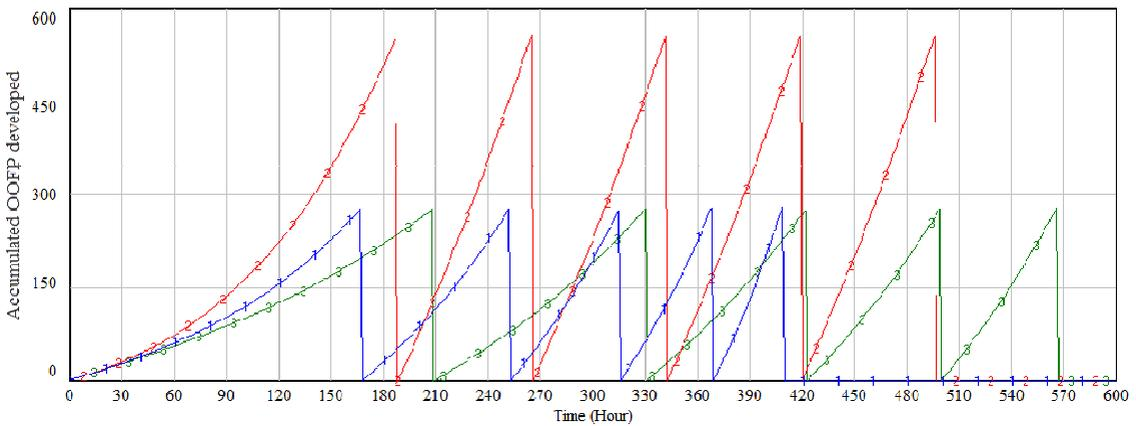

Figure 3. Accumulated number of OOFp developed per project for each scenario

In Figure 3, the peaks represent the moment when all the OOFp required in each a project are completed. There are five peaks per simulated scenario because there are five projects developed in sequence for each. The last peak of each scenario represents the last project.

Table 2

Total time to complete five projects using a framework

Scenario	Framework complexity	Reuse level	Total time to complete five projects
Scenario 1	1370 OOFp	80%	410 hours
Scenario 2	685 OOFp	60%	497 hours
Scenario 3	2749 OOFp	80%	567 hours

The results of the simulation in Figure 3 and Table 2 evidence that scenario 1 takes the least amount of time to complete the five projects. Under this configuration, the scenario 2 would be a better alternative over the scenario 3. When the first project is completed, the variance between the three scenarios is not extensive; but after the five projects are finished, the difference changes drastically.

The difference between the total time of scenarios 1 and 3 as a result of the change in the framework complexity is an increase of 157 hours or 38% over scenario 1; and compared



between scenario 1 and 2 an increase of 87 hours or 21%. Scenario 2 reaches a higher level of OOFP developed because the reuse level in this scenario is lower; in consequence, more OOFP must be developed to finish the projects.

We consider that the differences in the results of the three scenarios match the application framework literature. The framework learning curve and the reuse level as a result of using a framework are important elements to analyze when implementing a framework technology in software development projects.

If project manager needs to decide between different application frameworks the selection could be obvious if an alternative provides more reuse and its expected learning curve is the smallest. But if the selection is between frameworks with different reuse levels and learning curves, this can complicate the analysis. This model can be used to test different scenarios with the objective of finding the best alternative for the projects.

Although these results were based on small projects as the documented in Morisio et al. [11] the parameters could be changed to analyze larger projects. When simulating a larger project the percentage of reuse could make a difference, but usually in larger projects more developers are involved and then again, the most suitable alternative won't be easy to identify.

6. Conclusions and Future Work

Technology selection must take into account not just the technology itself but how the technology will affect the domain area where it will be used. In software development projects, the technology selection must consider how the different interrelated entities involved in a project, such as methods, people, processes, products, techniques and tools, are connected and affect each other.

The main objective in developing this work was to improve the understanding of application frameworks applied during software development. Application frameworks are an increasingly important technology for reuse. In this work, we described why the use of simulations in the contexts of software projects is an alternative to gain knowledge of technologies before introducing the min projects. We presented our motivations, described application frameworks and the simulation approach used. We also explained how the implementation of this technology affects software development projects.

We introduced a system dynamics model to evaluate application frameworks based on the application domain of this technology. The model's main elements were described and the results of three scenarios simulation were included. We consider that the results of these simulations concur with the application framework literature that establishes the reuse level and the learning curve of the framework must be taken in to consideration when evaluating application frameworks.

Our future work will be focused on integrating a maintenance phase into the model as well of conducting an experiment to validate the productivity improvements as result of using an application framework in a project. Additionally, we intend to obtain data from projects developed in the industry to validate the model with case studies.



References

1. Dietmar Pfahl, Karl Lebsanft. *Using simulation to analyse the impact of software requirement volatility on project performance*, Information and Software Technology, Vol. 42, No 14, 2000, pp. 1001-1008.
2. Marc I. Kellner, Raymond J. Madachy, David M. Raffo. *Software process simulation modeling: Why? what? how?*, Journal of Systems and Software, Vol. 46, No 2-3, 1999, pp. 91-105.
3. John D. Sterman. *Business dynamics: Systems thinking and modeling for a complex world*, United States of America: McGraw-Hill. 2000. 982 p.
4. Raymond J. Madachy. *Software process dynamics*: Wiley-IEEE Press. 2008. 601 p.
5. Mercedes Ruiz, Isabel Ramos, Miguel Toro. *Using dynamic modeling and simulation to improve the COTS software process*, Product Focused Software Process Improvement, Volume 3009/2004, 2004, pp. 568-581.
6. Eric F. Wolstenholme. *The use of system dynamics as a tool for intermediate level technology evaluation: Three case studies*, Journal of Engineering and Technology Management, Vol. 20, No 3, 2003, pp. 193-204.
7. Tina Stavredes. *A system dynamics evaluation model and methodology for instructional technology support*, Computers in Human Behavior, Vol. 17, No 4, 2001, pp. 409-419.
8. Ralph E. Johnson. *Frameworks = (components + patterns)*, Communications of the ACM, Vol. 40, No 10, 1997, pp. 39-42.
9. Fayad E. Mohamed, Douglas C. Schmidt, Ralph Johnson. *Implementing application frameworks: Object-oriented frameworks at work*, 1st edit.: John Wiley & Sons, 1999. 730 p.
10. Ralph E. Johnson, Brian Foote. *Designing Reusable Classes*, Object Oriented Programming, Vol. 1, No 5, 1988.
11. Maurizio Morisio, Daniele Romano, Ioannis Stamelos. *Quality, productivity, and learning in framework-based development: An exploratory case study*, IEEE Transactions on Software Engineering, Vol. 28, No 9, 2002, pp. 876-888.
12. Gregor Polančič, Romana V. Horvat, Ivan Rozman. *Improving object-oriented frameworks by considering the characteristics of constituent elements*, Journal of Information Science and Engineering, Vol. 25, No 4, 2009, pp. 1067-1085.
13. ISEE systems. 2011. Available at: <http://www.iseesystems.com/>.
14. Vensim from Ventana Systems, Inc. 2011. Available at: <http://www.vensim.com/>.
15. Fayad Mohamed, Douglas C. Schmidt. *Object-oriented application frameworks*, Communications of the ACM, Vol. 40, No 10, 1997, pp. 32-38.
16. Tarek Abdel-Hamid, Stuart Madnick. *Software project dynamics: An integrated approach*: Prentice Hall, Inc., 1991. 264 p.



**PUBLIC-PRIVATE PARTNERSHIPS AND CLEAN ENERGY
PROJECTS IN EMERGING MARKET ECONOMIES:
HOW CAN COMPANIES FROM SMALL STATES
MANAGE THE RISKS?**

Professor Hilmar Þór Hilmarsson

University of Akureyri

School of Business and Science

Borgir v/Nordurslóð, 600 Akureyri, Iceland

Phone: +(354) 460 8620, +(354) 849 8380

E-mail: hilmar@unak.is

Keywords: Public-private partnerships (PPPs), clean and renewable energy, emerging markets, risks and risk mitigation instruments

JEL classification: F30, G20, G32, O22, Q20, Q40

Abstract

Investments in clean energy are increasingly important to meet the growing energy needs in the world as well as for environmental reasons and as part of the battle against climate change. A large part of clean energy sources in the world are located in emerging market economies. Investors in emerging markets are often faced with higher risks than those investing in high income developed economies. Higher risks in turn reduce capital flows to emerging markets. At the same time energy projects tend to be large, capital intensive with long repayment periods. Energy projects also often require partnership between the public and the private sector i.e. public private partnerships (PPPs). Efficient allocation of risks among the different partners in PPPs is key to success and generally results in more profitable projects and will benefit each of the parties involved. This article will discuss public-private partnerships in the energy sector in emerging market economies. The focus will be on cross border investments for investors from small states where Iceland is selected as a case. The characteristics of emerging markets will be discussed, the risk faced by investors and risk mitigation instruments offered by international and national institutions to manage those risks.

Introduction

Investments in clean energy are increasingly important to meet the growing energy needs in the world as well as for environmental reasons and as part of the battle against climate change. A large part of clean energy sources in the world are located in emerging market economies. Investors in emerging markets are often faced with higher risks than those investing in high income developed economies. Higher risks in turn reduce capital flows to emerging markets. This is particularly true during times of economic and financial



crisis. At the same time energy projects tend to be large and capital intensive with long repayment periods. Energy projects also often require partnership between the public and the private sector i.e. public private partnerships (PPPs). Efficient allocation of risks among the different partners in PPPs is key to success and generally results in more profitable projects and will benefit each of the parties involved. This article will discuss public-private partnerships in the energy sector in emerging market economies. The focus will be on cross border investments for investors from small states where Iceland is selected as a case. The characteristics of emerging markets will be discussed, the risk faced by investors and risk mitigation instruments offered by international and national institutions (IFIs) and export credit agencies (ECAs) to manage those risks.¹ The main research question is: How can companies from small countries like Iceland use the risk mitigation instruments of national and international organizations when investing in clean energy projects in emerging market economies?

The article argues that a small country like Iceland can make a contribution to the global transformation to clean energy and to the fight against climate change if IFIs offer flexible and affordable funding and risk mitigation instruments for private investors. Such risk mitigation could lower the risk profile of energy projects sufficiently to attract private sector funding. Guarantees from an Icelandic ECA could also be important when Icelandic companies provide services and/or equipment for cross border energy investments in emerging markets. The article does not attempt to judge how efficient PPPs are operationally in comparison with projects that are solely financed, built and operated by governments. Its focus is on the institutional aspects of PPPs, long-term infrastructure contracts, and risk mitigation in markets where the private sector normally hesitates to engage.

Iceland and the Transition from Fossil Fuel to Clean Energy

Only a few decades ago most of Iceland's energy needs came from fossil fuel, coal and oil. Most electricity and space heating is now based on clean energy. Al Gore describes this transformation in his recent book "Our Choice" as follows: "Iceland responded to the oil shocks of the 1970s by converting to domestic resources, virtually every building in the entire country is heated by the hot water resources close to the surface of the tectonically active land" (Al Gore 2009, p. 109). This transformation also meant that local capacity in geothermal energy utilization was developed. Several Icelandic firms and institutions possess considerable experience in exploring geothermal sites and in constructing and operating geothermal power plants. There are also service providers and research and education institutions that can support geothermal energy projects in Iceland and potentially also participate in cross border investments, see table 1.

¹ The international institutions focused on are international financial institutions like the World Bank Group and the regional development banks, and the national institutions are export credit agencies (ECAs).



Table 1

Some Icelandic companies, service providers, research and education institutions in geothermal energy

GeoScience	ISOR, Mannvit, Vatnaskil
Technical Consulting	Mannvit, Verkis, Efla, Reykjavik Geothermal, Landsvirkjun Power, Reykjavik Energy Invest
Business Consulting	KPMG, Capacent Corporate Finance, Íslandsbanki
Drilling	Jarðboranir, Ræktunarsamband Flóa og Skeiða
Construction	ISTAK, ÍAV and Loftorka
Energy Audit & Law Firms	KPMG, Pricewaterhouse Coopers, Deloitte, Lex (law firm), Logos (law firm)
Financing	Arion banki, Íslandsbanki, Landsbankinn
Geothermal Research	ISOR, Mannvit, Vatnaskil, Utilities, Universities
Research Funding	Orkusjóður, Geothermal Research Group, Landsvirkjun's Energy Fund, Orkuveita Reykjavíkur Energy Fund, Rannís
Training and Education	University of Iceland, Reykjavik University, University of Akureyri, Reykjavik Energy Graduate School of Sustainable Systems, Keilir – Atlantic Center of Excellence, United Nations University – Geothermal Training Programme

This know-how has been developed during a few decades and one can say that there is now a proven capacity to construct and operate geothermal power plants in Iceland.

Clean Energy and Emerging Market Economies

Utilizing clean energy is not only a concern of Iceland. This is a global issue affecting both rich and poor countries. Many developing countries and emerging market economies in Africa, Asia and Latin America have large geothermal resources but are only in the early stages of development of using those resources, see figure 1.

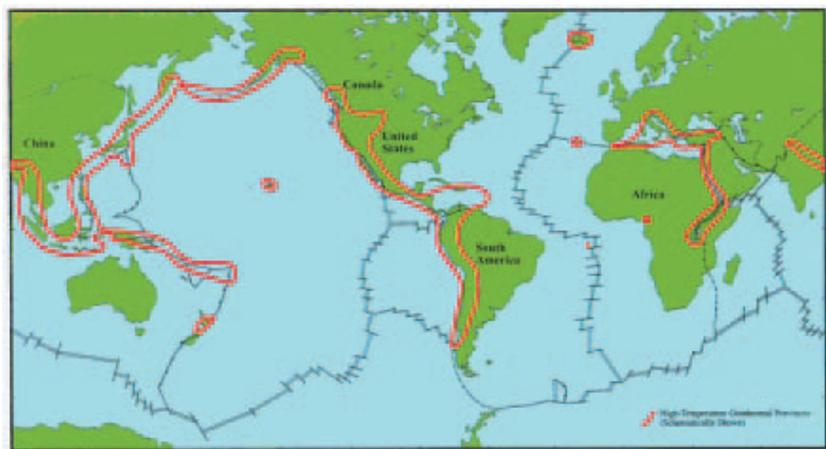

Figure 1. Geothermal Fracture Zones

Source: Enex 2008



The future growth in demand for electricity is also likely to be strongest in those emerging regions (see for example Tooman 2004). Transformation to clean energy could be of great benefit to those countries and have global implications in the battle against climate change and thus also benefit developed countries. However, it is not sufficient to have the natural resources and potential growth in future demand. Funding is also needed and energy investments tend to be large, capital intensive and long-term. Developing countries also often have risky business and investment environments that limit private sector cross-border investment to those countries. Proper risk mitigation can thus be a major challenge.

Small States Private Sector Cross Border Investments in Emerging Market Economies

Private sector funding and participation in clean energy projects can be a challenge for many reasons. One reason is that the host government is often the only buyer of the electricity or hot water produced i.e. it is the so called offtake purchaser². Many emerging countries with large clean energy potential have limited creditworthiness. They have low per capita income and are often going through an economic and a political transition. In such cases the sponsors³ of a project could hesitate to fund the project because of the uncertainty with the income stream from the investment made. Lenders, including commercial investment banks, would also often hesitate to provide loans to such projects because of the uncertainty that the project company, whose income stream is at risk, can service its loans. Being an investor from a small country like Iceland only adds to those risks. Small countries can only be expected to have a limited leverage in the event of dispute with a host government in an emerging country that can be a much larger country. A proper institutional framework with efficient and effective risk allocation and risk mitigation can help.

One possible institutional arrangement to address this situation is to form a Public-Private Partnership (PPP) and use the Build-Operate-Transfer (BOT) scheme. The PPP becomes a venue for the public and private sector to cooperate on a project that would traditionally have been in the public domain. The BOT arrangement means that the project is transferred back to the government when the concession⁴ agreement ends. In this situation efficient and effective risk allocation is key to success and the international community can play a constructive role, e.g. through international financial institutions that can offer a variety of risk mitigation instruments. Among the remedies that small country investors can apply to manage risks is thus partnership with IFIs and/or participation in a consortium with stronger partners. National institutions such as ECAs can also play a constructive role in reducing the risks taken by private investors.

² Offtake purchaser is the purchaser of the product produced by a project. In the case of a power project the product produced is the electricity generated.

³ A sponsor of a project is a party wishing to develop or undertake a project. A sponsor would normally provide financial support for the project e.g. early equity capital.

⁴ The concession is the right granted by the host government for a private company to undertake a public sector project and operate it over an agreed period of time.



Public Private Partnerships (PPPs) and the Allocation of Risks

PPPs can be a feasible venue to fund infrastructure development and to increase the efficiency of public sector service delivery. Infrastructure projects in the energy sector are often large, capital intensive and long-term. Repayment periods are also often long. It can take a private investor 10 to 25 years to recover the investment and the project returns.

The private sector is recognized as a significant financing source for meeting developing country investment requirements, but financial markets remain largely untapped for this purpose and have yet to live up to their potential (Asian Development Bank 2006). PPPs are one venue worth considering for the private sector to engage in infrastructure projects. Private capital, donor support (including IFIs) and public funds can be combined in a PPP project. A well designed policy and institutional framework for PPPs offers the opportunity to leverage and combine all three sources of financing and expertise, without crowding out the private investment. By forming a PPP the public and the private sectors can share the risks and the rewards of infrastructure projects.

There are many different definitions for PPPs. One definition is “any public sector service provided partially or wholly by the private sector” (Delmon 2009, 601). Another definition is a “co-operative institutional arrangements between public and private sector actors” (Hodge and Greve 2009, p. 33). Yet another definition of a PPP is “the transfer to the private sector of investment projects that traditionally have been executed or financed by the public sector” (World Bank 2008, p. 93).

To engage in cooperation, the public and the private sector can employ several different schemes⁵ including the so called BOT, i.e. Build-Operate-Transfer (IMF 2004). In BOT projects the private sector is responsible for financing, constructing and operating the project. Under this arrangement the host country grants a concession, i.e. the right to a private firm to undertake a public sector project and operate it over an agreed period of time. When the concession expires the ownership of the project is transferred back to the party granting the concession. For a comprehensive discussion on BOTs see Jeffrey Delmon’s outstanding book on Private Sector Investment in Infrastructure (Delmon 2009).

The partners typically involved in a BOT project are: the project company that undertakes the project, the host government (that can also be the offtake/power purchaser), the shareholders, the lenders, the grantor, the construction contractor, the operator, the offtake purchaser/power purchaser and the input supplier. Figure 2 below shows a typical PPP BOT contractual structure.

The project company uses the income stream from the project to service its debt from the project and to pay returns to its investors (i.e. the equity contributors to the project company). The lenders to a BOT project could, for example, be commercial investment banks, international financial institutions (IFIs) and bilateral agencies (BLAs). The IFIs and the ECAs could also serve as guarantors e.g. for payment to the lenders, including commercial investment banks. The lenders would be keen to manage their risks (i.e. only take measurable and measured risks) and would receive a fixed margin on their loan whereas the shareholders (i.e. the equity holders in

⁵ Among PPP schemes and modalities in addition to Build-Operate-Transfer (BOT) are for example: Build-Own-Operate-Transfer (BOOT), Build-Rent-Own-Transfer (BROT), Build-Lease-Operate-Transfer (BLOT), Build-Transfer-Operate (BTO).



the project company) maximize the profits on their equity investment. In addition to obtaining funding for the project, the project company procures the design and coordinates the construction and operation of the project in accordance with the requirements of the concession agreement. Project company shareholders often include firms with construction and operation experience, and with offtake purchase capabilities (Delmon 2009, p. 98).

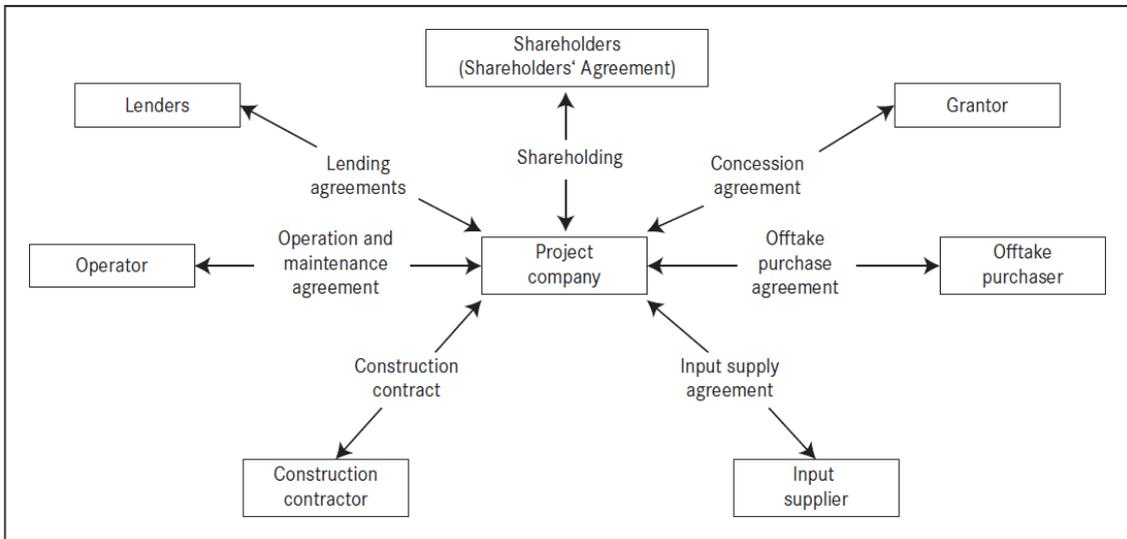

Figure 2. Typical PPP BOT contractual structure

Source: Delmon 2009

The offtake purchase agreement secures the project payment stream. The offtake purchaser will be looking for a guaranteed long-term output from the project. The credit risk associated with the offtake purchaser will be of particular concern to the project company and the lenders. This is where guarantees from the host governments or IFIs, including the World Bank, become important.

Critical to the design of PPPs is the way risks are allocated between the partners in the PPP. A general principle is that risk should fall on the party that is more able to do something about it. Risks in PPP tend to be allocated on the basis of commercial and negotiating strength. The stronger party will allocate risk that it does not want to bear to the weaker party. Efficient allocation of risk will generally result in a more successful and profitable project and will benefit each of the parties involved (Delmon 2009).

In order to minimize the market risk from the project company and the project lenders an offtake purchase agreement, or in the case of a power project, a power purchase agreement may be made. This is to create a secure payment stream which will be an important basis for financing the project. The offtake purchaser may also be the grantor, or a government entity such as a public utility, in which case the offtake purchase agreement and the concession agreement may be one and the same document (Delmon 2009).

The lenders will want the project risks to be allocated to project participants, i.e. the construction contractor and the operator and not the project company who is their debtor.

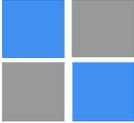

The project company will enter into a contract with the construction contractor in order to divest its obligations to the grantor to design, build, test and commission the project. Completion risk for the project should be allocated to the construction contractor. In the case of a turnkey project, completion and performance risk should be on the construction contractor.

If the main risks are associated with poor management of the service, shifting the risk to the operator could provide the right incentives to make sure that the project delivers. If the risks are related to changes in policies, then the government should bear the risk. This is because the project company will not generally be able to manage political risk. The project company will ask the government to bear those risks not necessarily to demand a compensation at a future date, but to pressure the government to avoid such risks and to minimize the probability that such risks will occur.

International Financial Institutions and Their Role in Risk Mitigation in Emerging Market Economies

Concerns about investment environments and perceptions of political risk often inhibit foreign investment, with the majority of flows going to a few countries leaving the world's poorest economies mostly ignored. This is especially true during times of economic and financial crisis. The limited number of investors engaging in risky environments might also be tempted to invest only when quick paybacks periods are possible. International financial institutions can have an important role to play here and responsibility to offer effective venues and viable risk mitigation instruments. This is especially true for long-term investments in energy infrastructure.

For large infrastructure projects investors must pay considerably more attention to political risk management issues. Risk reduction can reduce the cost of funding projects and facilitate longer loan periods. Political risk insurance, especially from multilateral agencies can act as an effective deterrent against host government interference with insured private investments.

Another typical problem in developing countries and emerging market economies is the limited scope for cost recovery. Customers often have a limited ability to pay for the services rendered and the government is in a weak position to force them to do so. This may result in a diminished interest from private investors.

One solution is for the host government to offer a guarantee to the private investor. But what should the government guarantee? Should it guarantee a minimum rate of return for the investment? Here the government needs to be careful as this guarantee represents a contingent liability and a poorly designed PPP can become a source of liability for the government. If the main risks are associated with poor management of infrastructure service, shifting the risk to the investor could provide better incentives to make sure that the project delivers. But this would not be accomplished if the government guarantees the revenue of the private sector.

Even if it makes sense for the government to provide a guarantee this guarantee may not be meaningful for the private sector if the government is not creditworthy. Here again international financial institutions can play an important role by providing insurance or a guarantee to the private investor (and in some cases using a host government guarantee as a counter guarantee).



Project Management Development – Practice and Perspectives

First International Scientific Conference on Project Management in the Baltic Countries

February 8-9, 2012, Riga, University of Latvia

IFIs offer a number of financial and risk management instruments that can be useful for Public-Private Partnerships.⁶ Those include loans, equity investments and guarantees or insurance against political risk (non-commercial risk).

Among the IFIs active in this area are: (i) the World Bank Group <http://www.worldbank.org/>, (ii) the European Bank for Reconstruction and Development <http://www.ebrd.org/>, (iii) the Asian Development Bank <http://www.adb.org/>, (iv) Inter-American Development Bank <http://www.iadb.org/>, (v) the African Development Bank <http://www.afdb.org/>, (vi) the European Investment Bank <http://www.eib.org/>, and the Nordic Investment Bank, <http://www.nib.int/home/>. Iceland is not a member of the Asian Development Bank, the Inter-American Development Bank and the African Development Bank. Icelandic companies do therefore not have access to the services of all the IFIs and have fewer options to form partnerships when investing in emerging markets than for example companies from the other Nordic countries who are members of all the above institutions.

Key risk issues can be categorized as: political, breach of contract by a government entity, market risk and default risk.⁷ Risk mitigation products can attract new financing resources, reduce costs of capital, and extend maturities by providing coverage for risks that the market is unable or unwilling to bare (Delmon 2009). Those products can attract more private capital to invest in infrastructure. Examples of guarantee products provided by the World Bank Group are IBRD/IDA partial risk guarantees (PRGs) and IBRD partial credit guarantees (PCGs), IFC partial credit guarantees and MIGA political risk insurance (Delmon 2009). Those risk mitigation instruments allow investors to be compensated in the case of certain adverse events and thus reduce the risk and thus the project costs. For an overview of risk mitigation products offered by the World Bank Group, see Annex I.

In the case of energy infrastructure projects World Bank guarantee products such as partial risk guarantees (PRG) and partial risk insurance (PRI) can be key to success. According to the World Bank PRGs “cover commercial lenders for a private sector project against default arising from a government-owned entity failing to perform its obligations. PRGs can cover changes in law, failure to meet contractual obligations, expropriation and nationalization, currency transfer and convertibility, nonpayment of a termination amount, failure to issue licenses in a timely manner, other risk to the extent that they are covered by contractual obligations of a government entity, and noncompliance with an agreed dispute resolution clause. PRGs can be provided in both IBRD and IDA countries and require a government counter-guarantee” (World Bank 2009, p. 10).

Regarding the IBRD/IDA PRGs the investor receives comfort, improved credit terms, and is not liable for loan repayment. Among the strengths of this instrument is increased government commitment to success of projects, accompanied with the benefits of an ongoing by policy dialogue between the World Bank and the host government. Among the weaknesses are

⁶ In addition to those services, IFIs often engage in a policy dialogue with the governments of emerging market economies to improve economic policy and management. This includes reforms to improve the business and investment climate for the private sector, to promote business activities, and to encourage foreign direct investment. IFIs also provide loans and credits to various government-led projects in developing countries and emerging markets that are subject to international competitive bidding. This allows private sector firms to participate in the bidding process and potentially to benefit from those public sector projects supported by the IFIs.

⁷ For an excellent overview of World Bank risk mitigation products, see Jeffrey Delmon Chapter 7 (Delmon 2009).



sovereign guarantees required in all cases, cumbersome processing and high transaction costs. The demand for this instrument is mainly limited to PPPs and sectors with heavy government engagement (World Bank 2009, p. 74).

Among the five institutions of the World Bank Group is also the Multilateral Investment Guarantee Agency (MIGA). MIGA provides guarantees against political risks, i.e. non-commercial risks for investments in emerging markets. It also provides technical assistance and dispute mediation service. Developing countries would hesitate to take measures that would negatively affect projects that MIGA is involved with because of the concern that it could adversely affect their relationship with IDA and/or IBRD and possible credit or a loan (see for example West, 1999, p. 29 to 30).

According to the World Bank, MIGA “offers PRI coverage to foreign direct investors for any combination of the following political risks: transfer restriction, expropriation, war and civil disturbance, and breach of contract. MIGA can insure direct equity, quasi-equity, nonequity direct, and other investments. To insure debt, however, it must have an equity link. MIGA guarantees cover new foreign-currency-denominated investments, including “new” investments to existing investments, investments by private for-profit and nonprofit organizations, and public owned investors and organizations that operate on commercial basis. MIGA can cover any freely usable currency, which may include local currency investments/loans. Under certain circumstances, MIGA can cover investments by local investors” (World Bank 2009, p. 10).

Regarding the MIGA PRI the investor receives comfort, improved credit terms, mediation services and compensation in the event of loss. Among the strengths are flexible coverage of all PRI risks; main product for equity investments; dispute resolution; minimal time and processing. Among weaknesses are no comprehensive coverage (commercial risk and political risk cover) and lengthy process to change Convention limitations (World Bank 2009, p. 74).

Given the global needs for energy investments these instruments have not been used frequently and the amounts are still modest. IBRD/IDA PRG has been deployed for 13 projects with the commitment amount US\$ 1.2 billion and 92 percent for infrastructure projects. MIGA PRI has been deployed 566 projects with a commitment amount US\$ 16.6 billion and 24 percent for infrastructure projects (World Bank 2009, p 68).

The Asian Development Bank (AsDB) and the other regional development banks also offer risk mitigation instruments that are important for private investors in emerging markets although they are not discussed in any detail here. AsDB risk mitigation instruments can for example cover breach of contract. For a power project such breach may result from failure by the government-owned entity to make payments in accordance with the power purchase agreement between the independent power producer and the user or distributor (Asian Development Bank 2000, p. 2). Such insurance can be critical for the success of an energy infrastructure project. According to the AsDB the majority of the PRGs that AsDB has provided have been private sector-oriented, including PRGs for public-private partnerships (PPPs) (Asian Development Bank 2006, p. 5).

International Financial Institutions and the Effectiveness of Their Risk Mitigation Instruments

The effectiveness of the risk mitigation instruments offered by IFIs and the performance of those institutions must be under constant review and scrutiny. In 2009 the World Bank Group (WBG) issued a report titled: The World Bank Group Guarantee Instruments 1990-2007. An Independent Evaluation (World Bank 2009). As part of the evaluation the Independent



Project Management Development – Practice and Perspectives

First International Scientific Conference on Project Management in the Baltic Countries

February 8-9, 2012, Riga, University of Latvia

Evaluation Group (IEG) at the Bank conducted a survey in 2008 to solicit views among its staff about the use and effectiveness of guarantee instruments (World Bank 2009). A survey questionnaire was sent to 363 staff and 206 responded.

Among the things that the survey revealed is that WBG staff are familiar with their own products but not with the guarantee products of other WBG institutions.⁸ For example only one-fifth of IFC⁹ staff were familiar with IBRD/IDA¹⁰ products. In fact, IFC staff was not familiar with the products of IBRD, IDA or MIGA.

According to the survey more than 85 percent of WBG staff felt that the most critical benefits of the WBGs guarantee instruments were enhanced image of financial soundness and improved rates and tenors. Among other benefits include WBG's role as an honest broker and securing other investors (World Bank 2009).

It is also notable how few guarantees and insurances have been issued from an institution as large as the World Bank Group. A high proportion of staff felt that changes are needed to improve the WBG's guarantee instruments (World Bank 2009). Interestingly enough most WBG staff felt that reducing time and cost of processing guarantees and improving marketing were important for improving WBG guarantee instruments. Furthermore staff reported that clients proceeding with the project without a guarantee and long processing time were the main reason for dropped guarantee projects. 80 percent of IFC staff reported the droppages occurred because the cost of the guarantee was too high for the client (World Bank 2009).

IBRD, IDA and MIGA staff reported that project sponsors/investors most frequently originated the request of guarantees. IFC staff reported that, host governments and staff of another WBG institution are least likely to originate its guarantees.

On May 7, 2008 the Committee on Development Effectiveness (CODE) at the World Bank considered the IEG independent evaluation. Several speakers called for greater collaboration among WBG institutions based on their comparative advantages, and strengthening the coherence of the products offered, including their pricing. They also called for more coordinated WBG efforts for marketing, increased staff knowledge of the guarantee products, and appropriate staff incentives (World Bank 2009, p. xxviii). Comments were also made about the need of the WBG to think about a "single Window" for guarantee products (World Bank 2009, p. xxvi).

The ongoing debate about the role of international financial institutions increasingly recognizes the importance of making greater use of the risk mitigation potential inherent in their unique multilateral structure (Asian Development Bank 2006). The World Economic Forum (WEF)¹¹ has for example argued strongly for IFIs to better use guarantee and risk mitigation

⁸ The World Bank Group represents five institutions. Those are: (i) the International Bank for Reconstruction and Development, IBRD, established in 1944, (ii) the International Development Association, IDA, established in 1960, (iii) the International Finance Corporation, IFC, established in 1956, (iv) the Multilateral Investment Guarantee Agency, MIGA, established in 1988, (v) International Centre for Settlement of Investment Disputes, ICSID, established in 1966. Four of those institutions issue insurances or guarantees, i.e.: IBRD, IDA, IFC and MIGA.

⁹ The International Finance Corporation, IFC, is the private sector arm of the World Bank Group, WBG.

¹⁰ The IBRD and the IDA are the public sector arms of the WBG.

¹¹ The World Economic Forum's Financing for Development Initiative comprises more than 200 global experts from financial institutions, corporations, governments, international organizations, universities, and nongovernmental organizations, who offer their views on improving the effectiveness of efforts to stimulate private sector investment in developing countries.



instruments and capabilities to attract increased commercial investment in development projects. In 2006 WEF issued a report titled Building on the Monterrey Consensus: The Untapped Potential of Development Finance Institutions to Catalyze Private Investment. In this report the Forum specifically asserted that: "...the weight of DFI (development finance institutions) activities should shift over time from direct lending to facilitating the mobilization of resources from the world's large private savings pools – international and domestic – for development – oriented investment through:

- wider use of risk mitigation instruments to alleviate part of the risk faced by investors; and
- stronger direct support for capacity building to strengthen the enabling environment for investment." (World Economic Forum 2006, p. 9).

Furthermore the WEF argued that DFIs should "...adapt their services, culture and capital allocation to the imperative of "crowding in" domestic and foreign private investment by placing much more emphasis on such risk mitigation instruments as partial guarantees as transitional strategy and on capacity building" (World Economic Forum 2006, p. 10) and that "an international consensus has emerged, embodied by the Monterrey Consensus, that a deeper partnership between the public and private sector is needed if we are to achieve common development objectives" (World Economic Forum 2006, p. 10). In its final recommendations the WEF says: "The overwhelming majority of expert participants in the project recommended a major expansion of risk mitigation activity by DFIs..." (World Economic Forum 2006, p. 15).

The WEF is thus sending a very clear signal to the international financial institutions and the IFIs are listening. In its report Review of ADB's Credit Enhancement Operations the Asian Development Bank takes a clear note of WEF's views and refers to their 2006 report several times (Asian Development Bank 2006).

While there is a clear need for risk mitigation in emerging markets for sectors like the energy sector, it looks like the IFIs, including the WBG, have some way to go to make those instruments widely used. IFIs need to do a better job in coordinating risk mitigation activities within the institutions and spend more efforts to market those products and to make them more efficient and more cost effective for the private sector and shorten their processing time.

Export Credit Agencies and Their Role in Risk Mitigation for Cross Border Investments to Emerging Markets

In most developed countries there are export credit agencies (ECAs) that have been established by the home countries to help finance export of their national goods and services as well as cross border investments. These agencies can provide guarantees in connection with projects where there are deliveries of equipment and/or services to the project from the home country. This applies generally speaking to all ECAs supporting the export industry of their home country. In Iceland such an agency exists and is called Tryggingardeild útflutnings (TRÚ). ECAs can provide guarantees both against commercial and non-commercial risks in emerging markets and these instruments can be quite suitable to support overseas energy investments in developing countries and emerging markets, including for energy investments. TRÚ works in partnership with the Swedish export credit agency EKN which would assist the Icelandic agency to assess risks in host countries. According to Icelandic law TRÚ can provide



Project Management Development – Practice and Perspectives

First International Scientific Conference on Project Management in the Baltic Countries

February 8-9, 2012, Riga, University of Latvia

guarantees and insurances up to 130 million SDR. This is a sizable amount of money. To make the story short TRÚ services have never been used by Icelandic exporters or cross border investors.

Emerging countries are increasingly important to Swedish exports and EKN is needed for expansion in these markets. From January to September 2011 the volume of guarantees issued by EKN amounted to SEK 40 billion. This is EKN's highest ever figure for guarantee-issuing in the period January-September, apart from the temporary solutions offered in 2009 and the first half of 2010. EKN issued new guarantees for 1,163 transactions in 121 countries, compared with 1,249 transactions (same number of countries) during the same period in 2010. (EKN 2011). In contrast Icelandic exporters and investors are not using the risk mitigation instruments that are available at TRÚ at all.

Conclusions

A small country like Iceland can play a constructive role in sharing its experience in transforming its economy from fossil fuel to clean energy and could be an example for other countries. Icelandic energy companies have a proven record in building and operating geothermal power plants. There are also several service providers, research and education institutions in geothermal energy that could contribute to the transition to geothermal energy in emerging market economies.

Most of the future increase in demand for electricity is likely to come from emerging market economies. This is also where most of the clean energy resources are located. This offers a tremendous opportunity for emerging market countries, but also is a challenge, including with funding. Sufficient private funds will not flow into those countries unless the risk profile energy projects can be reduced. This is especially true during times of financial and economic crisis.

To fill the tremendous energy infrastructure gap in emerging markets the public and private sector need to work in partnership, including via PPPs. Such partnerships can be supported by international financial institutions. For large energy projects partnerships, pooling public, private and donors funds should not crowd out the private sector, instead they offer the potential to crowd in private funds into risky markets that would not get private investment without proper risk mitigation.

The international financial institutions can be an important partner not only with direct funding, i.e. loans and equity investments, but also increasingly through risk mitigation instruments. IFIs need to provide instruments that are more flexible and more cost effective for the private sector and with shorter processing time. Better coordination between the World Bank Group institutions providing guarantees/insurances are needed and better marketing of the instruments.

Export credit agencies can also play a constructive role in supporting exporters of equipment and services to emerging markets by providing guarantees and insurances against commercial and non-commercial risk to facilitate longer-term lending and at more affordable costs.

If Icelandic companies participate in energy projects as sponsors/investors in emerging market economies they should make serious efforts to develop a comprehensive risk identification and mitigation strategy before they engage. This could be done by forming an



international consortium with participation of IFIs that Iceland is a member of and with support of the Icelandic ECA.

The government of Iceland should carry out feasibility studies that could help in the decision making process of applying for membership in the regional development banks. This could help strengthen the bargaining position of Icelandic companies vis-à-vis IFIs and enable them to select from a larger menu of financial and risk mitigation instruments in emerging markets than they presently can. Access to IFIs is also even more important for Icelandic companies than for companies from larger countries, as Iceland does not have wide representation in emerging markets through embassies and business representatives. The government should also investigate why Icelandic companies are not using the services of the Icelandic export credit agency, TRÚ. The services of TRÚ can be an important export promotion tool for Icelandic exporters especially during times of crisis.

References

1. Asian Development Bank. (2006). *Review of ADB's Credit Enhancement Operations*, available at: <http://www.adb.org/documents/policies/Credit-Enhancement/Credit-Enhancement-operation.pdf> (Accessed on September 9, 2011).
2. Asian Development Bank. (2000). Review of the Partial Risk Guarantee of the Asian Development Bank, available at: <http://www.adb.org/documents/policies/prg/default.asp> (Accessed on October 21, 2011).
3. Delmon, Jeffrey. (2009). *Private Sector Investment in Infrastructure. Project Finance, PPP Projects and Risk*. 2nd edition, Kluwer Law International, the Netherlands. 640 p.
4. EKN. (2011). *EKN in figures*. Available at: <http://www.ekn.se/en/Om-EKN/About-EKN/> (Accessed on December 10, 2011).
5. Gore, Al. (2009). *Our Choice – A Plan to Solve the Climate Crisis*. Melcher Media, New York.
6. Hodge, Graeme A. and Carsten Greve (2009), PPPs: The Passage of Time Permits a Sober Reflection. Institute of Economic Affairs, Blackwell Publishing, Oxford, Vol. 29. Issue 1, pp. 33-39.
7. International Monetary Fund (2004), *Public Private Partnerships*. IMF, Washington, DC, available at: <http://www.imf.org/external/np/fad/2004/pjfp/eng/031204.pdf> (Accessed on August 15, 2011).
8. Tooman, Charles (2004), Measuring Opportunity and Risk in Global Energy Investments: Practices and Techniques for Assessing International Investment Risk and Enhancing Capital Allocation. *Journal of Structured and Project Finance*, 10, pp. 62-73.
9. West, Gerald T. (1999), Political Risk Investment Insurance: A Renaissance. *Journal of Project Finance*, 5(2), pp. 27-36.
10. World Bank (2009), *The World Bank Group Guarantee Instruments 1990-2007. An Independent Evaluation*. The World Bank Washington, D.C.
11. World Bank (2008), *Capital Matters*, Vietnam Consultative Group Meeting Hanoi, 2008, available at: http://www.presscenter.org.vn/en/images/WP_Capital_Matters.pdf (Accessed on September 27, 2011).
12. World Economic Forum (2006), *Building on the Monterrey Consensus: The Untapped Potential of Development Finance Institutions to Catalyze Private Investment*, available at: <http://www.weforum.org/pdf/Financing/Monterrey.pdf> (Accessed on November 6, 2011).

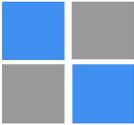

Annex I

World Bank Group Guarantees

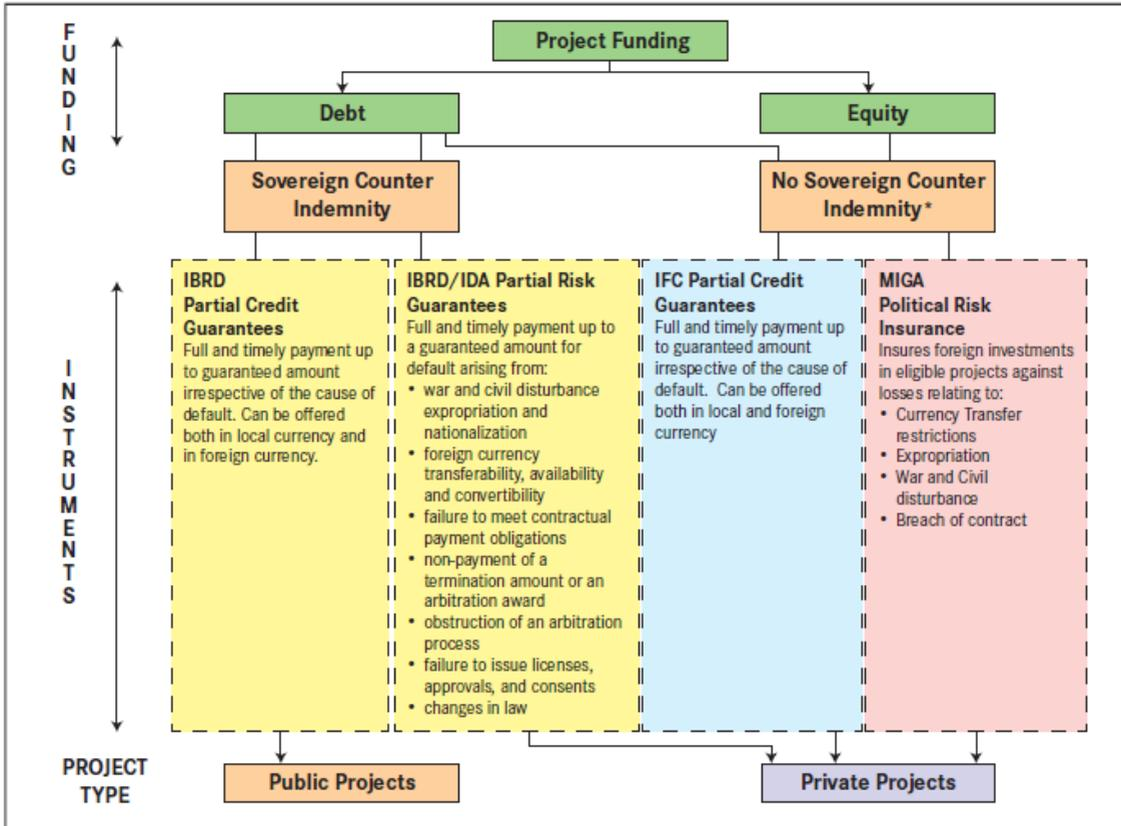

Source: Delmon 2009



INCREASING THE LEVEL OF ORGANIZATIONAL COMPETENCE IN PROJECT MANAGEMENT – THE NEW PROJECT WORK DEVELOPMENT PERSPECTIVE

*Professor Dr.oec. **Žaneta Ilmete***

University of Latvia

Faculty of Economics and Management

Aspazijas bulvāris 5, Riga, LV-1010, Latvia

E-mail: zaneta@lanet.lv

*MSc.proj.mgmt. **Silvija Bruņa***

Professional Association of Project Managers

Brīvības gatve 338-11, Riga, LV-1006, Latvia

E-mail: Silvija.Bruna@gmail.com

*MSc.proj.mgmt. **Emīls Pūlmanis***

State Regional Development Agency

Elizabetes iela 19, Riga, LV-1050, Latvia

E-mail: Emils.Pulmanis@gmail.com

Keywords: organizational competence in project management, project manager competence

Abstract

This paper looks at the essence of the concepts of individual and organizational common competence and their influence on project success, or failure, in a given object. The paper analyzes the opportunities for individual competence development of project managers in Europe and Latvia, with emphasis on higher education in project management. It also studies and evaluates the factors enabling one to judge an organization's competence in project management. Special attention is given to the competence of all those involved in a project in the organization, as well as the project management culture in the organization. At the end of the article, conclusions and suggestions are provided concerning the order of tasks to increase the organizational competence level.

Introduction

In the last years, project management has been taking an increasingly important place in the operation of companies and organizations (in this article called “organization”).

The market economy causes faster development of new service and product supply in organizations. Accordingly, the amount, complexity and dynamic of tasks increase. The personnel management style in organizations is changing, a new management culture and infrastructure are emerging. The traditional management methods are replaced by new project management methods. Organizations are increasingly focusing on executing various tasks in



the form of projects. Projects are used not only to develop new products/services, but also widely applied in organization management and reorganization. Projects and project management have become the everyday in all of the developed Western Europe countries. For instance, research in Germany [1] indicates that for most of the businesses in the country project work is an everyday matter. This refers to both big and small, and medium, companies. The situation is similar in other Western European countries.

Still, many projects fail, miss the deadlines, exceed their financial resources, do not meet the clients' expectations. There are different reasons for failure. It is caused by flaws in management of the particular projects, for example unclear project execution conditions, ill-defined objectives, bad communication at the project beginning, unqualified project team, errors in the planning process. Other reasons do not refer any specific project, since they concern all projects implemented by the organization. These include the competence level of all people in the organization, the accepted project culture in the organization etc.

These are factors that an individual project manager cannot influence because they are beyond his/her control and depend on both the highest level managers in the organization and the whole organization competence level in general. That is why currently organizations are paying ever more attention not only to the individual competence of project managers, but also to the organization's common competence in project management.

The purpose of this paper is to study the concept of organizational competence and its difference from the individual competence in project management, to establish the most important factors of organizational competence, and to reflect their impact on project management by analyzing the project stakeholders, and to determine the problems in raising the organizational competence level in Latvia.

1. Competence in Project Management

Competence is the most often quoted notion in business literature. It is derived from the Latin word 'competentia'. The translation is approximately 'being capable of reasoning' or 'authorized to speak', and it relates to the competence of an individual in a particular field.

There are several definitions of project management competence of a person, individual, in literature.

The International Project Management Association (IPMA) explains an individual's competence in its competence guidelines (IPMA Competence Baseline-ICB), version 3, as "a body of knowledge, personal properties, skills, and experience necessary to perform certain kind of functions successfully" [2].

The Project Management Institute (PMI) in their project manager competence development framework document [3] explain competence in project management as "the ability to demonstrate readiness to perform activities within the limits of project environment that lead to expect outcomes based on defined and accepted standards".

The German Project Management Association (Deutsche Gesellschaft für Projektmanagement-GPM) in its work [4] considers competence in project management from two perspectives – "on the one hand, as a person's formal competence and rights within a certain organization, and on the other hand as a person's ability (knowledge, practice, experience) and position".



In summary of the above, we can conclude that the individual competence in project management combines a person's readiness for a certain activity on a project and his/her ability to deal with the project task within the given time and costs.

Rapid increase in the project managers' individual competence level in project management could be observed around the world over the last few years. This is witnessed by both fast growth of the numbers of professionals organizations in many countries of the world, and inclusion of the professional higher education programmes for project managers in the university curricula.

Project management study courses were included in most university master study programmes as early as at the beginning of the 90s. Those were relatively small courses, where students were introduced to the basics of project management. Professional master study programmes for project management appeared in later years, when sufficient experience and knowledge in the project management areas had been accumulated and qualified professors had been prepared. However, the work in this area was still not all that smooth. This can be seen in the results of research carried out under the supervision of professor R.Gareis (5).

Table 1

Evaluation of the Possibilities for Obtaining Official Education Documents in Project Management in the Compared Countries (Table contains the latest data on Latvia)

Countries	Doctoral study programmes	Master study programmes	Bachelor study programmes
The United Kingdom	13	13	3
Romania	None	2	None
Sweden	Possible	2	None
Hungary	Possible	2	None
Denmark	Possible	None	1
Norway	3	2	No data
Ireland	1	3	None
Austria	Possible	5	None
Latvia	Partly possible	2	None

As it can be seen from Table 1, the highest level in terms of project managements education is held by the United Kingdom, where 13 universities offer the academic master and doctor study programmes and 3 universities offer the academic bachelor study programmes. About 120 universities provide a separate course on project management.

As of 2000, a master study programme is offered by two Romanian universities as well – the Bukarest Academy of Economic Studies and the Ovidius University in Constant. The rest of Romania's universities have introduced a project management course as a separate module.

In Sweden, one can obtain the academic master and doctor's (Ph. D.) degree in project management at two universities.

In Denmark, at the time of the research it was not yet possible to obtain a master's diploma in project management, but it was possible to obtain the doctor's (Ph.D.) degree, and



Project Management Development – Practice and Perspectives

First International Scientific Conference on Project Management in the Baltic Countries

February 8-9, 2012, Riga, University of Latvia

at one university project management could be studied in a bachelor study programme. In several study programmes project management was included as a separate module.

A master's diploma in project management could be earned in Norway at one university and one professional higher education institution, and a doctor's degree (Ph. D.) at 3 universities.

Three universities in Ireland offer master study programmes in project management, and at one university it is possible to obtain the doctor's degree in project management.

In Austria, project management master study programmes offer five professional higher education institutions. The Vienna University of Economics offers both master and doctor study project management.

In Latvia, project management was included in the Latvian University economic science master study programmes as a separate course as early as 1996. Based on this experience, the Faculty of Economics and Business of the University of Latvia developed a professional master study programme, which was accredited for six years in March 2010. This was the first two-year study programme accredited for six years that today accepts over 60 students. Considering the scientific potential of the University of Latvia, it also offers a doctoral study programme with a focus on project management. Currently it includes three doctoral students. Apart from that, a professional master study programme is offered by the Latvian University of Agriculture, Faculty of Social Science, and RSEBA.

Development of the professionalization of project management in Latvia was influenced by informal education in project management, i.e. 160 hour courses offered by the Centre of Project Management and Business Education. This work is at present carried on by the LU Faculty of Economics and Business, Learning Centre.

The formal confirmation of knowledge obtained via informal education is the project manager certification. There are two internationally recognized project manager certification systems operating in Latvia, offered by the PMI and IPMA. The certificates are necessary if a candidate decides to operate outside Latvia and has no appropriate document – a diploma of higher education in project management. Currently there are 29 IPMA certified persons in Latvia, registered in the Latvian database.

Professional organizations play an important role in raising of the individual competence of project managers. There are two professional organizations for project management operating in Latvia: the National Project Management Association of Latvia (LNPVA), combining all the stakeholders regardless of their education level, skills and knowledge in project management, and the Professional Association of Project Managers (PVPA), currently accepting only professionals with higher education in the field, as well as doctoral students and professional master study programme students. This composition of organization members enables solution of serious theoretic and practical issues in project management on a new level.

All of the above measures aim mainly to increase the competence level of individuals in project management, but practice shows that the project success is determined not only by the competence of individuals, but also that of the entire organization. For this reason, we will further on consider the concept of organizational competence in project management and individual factors of its impact.



2. Organizational Competence in Project Management

Studying the organizational competence in project management has been addressed in the last years by many researchers [8, 9, 10, 11].

The author of the work [8] expands the concept of competence in its definition, referring it to not only individuals in a particular area, but to groups of persons, organizations, industries, and even the society as a whole. This is how the theoretical basis for the concept of organizational competence was created.

The author of the work [9] goes on to explain competence as the ability to collectively achieve an objective in the given environment, underlining that this ability follows from a sum of individual competences transformed and prepared for the solving of organizational tasks.

The work [10] addresses competence not in general, but as an organizational competence formed by the sum of individual competences and the rules developed for the needs of an organization, and its strategic directions and culture.

An explanation of the concept of organizational competence in project management is given by the authors of the publication [11]. According to them, organizational competence in project management is the ability of an organization to achieve their goals by combining the individual, strategic, and cultural competences at their disposal, using the resources available for project implementation. This explanation of the organizational competence is accepted by the authors of this publication as well.

For the purposes of achieving every organization's objectives, appropriate rules, strategies, processes, structure, and culture are developed. Thus, for instance strategy is devised based on the organization's vision and mission, and processes and structures suitable for its implementation are developed. To involve all employees of an organization in a common task, an organization develops common regulations and forms the organization culture. Finally, resources are required to achieve an organization's objectives. If an organization intends to reach its goals by implementing as many successful projects as possible, then it must have high competence in project management in all of the above items.

This publication studies the environment and stakeholders of projects, as well as the factor forming the organization's competence and its influence on the project outcomes.

3. Development of Project Management Competence in an Organization

How to develop the project management competence in an organization?

One of the first tasks is to convince the organization's management of the need for change in the organization. A workshop can be organized for this purpose, including the management, and additional meetings with employees on problems within the organization in terms of project management, for example – what is the actual situation in project management in the organization, what are the causes of any problems, and what are the potential solutions?

In order to see the true picture of the situation in an organization, anonymous employee surveys or interviewing can be attempted. Interviews within an organization are recommended to be done by outsourced people. In preparation for such a process, it is important that we know in advance the issues where we are trying to locate problems. These could be related to the project culture in the organization, forming of the organizational structure of projects,



project management process organization, project manual development, and finally, the questions relating to employee qualification.

Based on the results obtained from these measures, suggestions can be developed on the organizational competence development activities in the field of project management. It could be suggestions on project management qualification raising activities within the organization, or on project manual development process, or project management process organization, or creation of the projects' organizational structure and project culture. The above suggestions form the key conception of organization competence development discussed in the organization.

Practice shows that this job requires a team, which can be dismissed after the key conception is approved. Introduction of this conception in the organization is implemented as a project.

Examples abroad demonstrate that this procedure can be used to ensure project management competence development in an organization of 900 employees over two years.

In Latvia, this practice is not yet introduced, or introduced partly in some organizations. This can be explained by several reasons.

First, the project managers' individual competence is in most cases relatively low. Project managers are not asked for knowledge in this field. It is not required that a project manager use generally accepted project management methods, technologies, or resources in their work. Consequently, projects in Latvia suffer great failures, such as the one of the Southern Bridge project, and resources are wasted. To improve this situation, project manager candidates should be required to have official documents confirming their knowledge. At this time, these are either a university diploma for completion of master studies in project management, or a certificate on having completed at least 160 hour course in a sufficiently authoritative educational institution.

Second, the top level managers of organizations do not have the basic knowledge of project management, so they are incapable of assessing the significance and benefits of project management that the organization would obtain thanks to applying project management methods in the organization.

Third, even if there is at least one competent employee in the organization who could be suggested for the post of project manager, then finding competent employees for the project team is a real challenge. As a result, the project manager's work is complicated by working with a team that is professionally incapable of understanding him/her.

Fourth, few organizations understand the tasks of project management offices and would be prepared to create ones as a separate structural unit. Hence organizations have trouble developing project manuals, applying the latest methods in project management, raising the qualification of the project team members and other personnel and creating the project culture.

Conclusions and Suggestions

- For an organization's projects to be successful, it is not enough to have separate individuals in the organization with high individual competence in project management – at the same time, the organization's common competence in the field must be developed.
- The total level of an organization's competences is affected by that of all people involved in the project in the organization, that is why it is important to develop the competence in



Project Management Development – Practice and Perspectives

First International Scientific Conference on Project Management in the Baltic Countries
February 8-9, 2012, Riga, University of Latvia

project management of all levels of managers, so that they could successfully cooperate with the project manager in the performance of their tasks.

- An organization's competence is also affected by factors such as creation and introduction of organizational structure and culture suitable for project management. For this reason organizations thinking of raising their level of competence in project management should pay a lot of attention to developing the project manual and applying project management methods and technologies in the project assignments.
- The organizational competence development is time-taking, systematic work, which means it is done in several stages.
- Latvia must identify the problems inhibiting or stalling the raising of the level of competence in project management in individual organizations, and develop measures to overcome these.

References

1. Rump, J./ Schabel, F.: Wie projektarbeit Unternehmen verandert. In:Harvard Business Manager, Ausgabe Februar 2010, S. 16-19.
1. IPMA: IPMA Competence Baseline Version 3.0. IPMA, Nijkerk 2006.
2. PMI: Project Manager Competency Development (PMCD) Framework. PMI, Newtown Square 2002.
3. Gessler, M. (Hrsg.):Kompetenzbasierte Projektmanagement (PM3)- Handbuch fur die Projektarbeit, Qualifizierung und Zertifizierung, Band 1. GPM, Nurnberg 2009.
4. Gareis,R. : Happy Projects!, 2. Auflage, Manz, Wien 2004, S 628-630.
5. Gareis, R.:Assessing and Benchmarking Projekt-oriented Societies: Results of the Benchmarking of Austria, Ireland, Latvia and Norway as Pos. University of Economics and Business Administration, Vienna September 2002.
6. Ilmete, Ž.: Projektu vadīšanas kompetences līmeņa izvērtējums Latvijā. Latvijas Universitātes raksti, 718. sēj. Ekonomika VI, Rīga, 2007, 134-151 lpp.
7. Motzel, E.: Projektmanagement-Lexikon, WILEY-VCH, Weinheim 2006, S. 100.
8. Eberl, M.: Die Dynamisierung organisationaler Kompetenzen. eine kritische Rekonstruktion und Analyse der Dynamic Capability – Debatte. Verlag Dr. Kovac, Hamburg 2009, S. 32.
9. Stieger,O.: Projektmanagement als strategisch wichtige Führungsaufgabe emanzipieren. organisationale kompetenz-Ein neues Leihema fur das Projektmanagement. In: projektMANAGEMENT aktuell 2/2010, TUV Media GmbH, Koln 2010, S. 3-14.
10. Cron, D., Dierig, S., Rietiker S., Wagner, R.: Organisationale kompetenz- eine neue Perspektive fur die Projektarbeit. In: projektMANGEMENT aktuell 2/2010, TUV Media GmbH, Koln 2010, S. 15-22.



EU FUNDS PROJECT CONTROLS

Olita Janberga

Ministry of Finance, Republic of Latvia

Smilšu iela 1, Riga, LV-1050, Latvia

Phone: +371 26597119

E-mail: Olita.janberga@fm.gov.lv

Keywords: project, control, error, irregularity

Abstract

As one of prerequisites in order to ensure successful and efficient management of EU funds projects, is establishing of management and control system that is able to react and prevent or minimize in a timely manner the risks that endanger implementation of EU funds, as one of the European Commission's requirements are adequate EU funds project controls. Controls set up in terms of the management and control system checks (carried out by responsible institutions and cooperation institutions), and audits of operations, on-the-spot checks have to provide assurance to the European Commission on the operational effectiveness of EU funds management and control system and the legality and regularity of declared expenditures.

By testing at project management level it is possible to determine the management and control system's practical effectiveness – whether the sufficient traceability of transactions is ensured, whether the costs of the project are supported by appropriate calculations and supporting documentation. By contrast, examinations at EU funds project accounting level, reflects the essence and time compliance with action requirements and the actual transactions.

Common question asked during EU funds project controls is: “Do you have irregularities?” The answer usually received is: “No, we have just errors.” The reply which will never be received is: “We do have irregularities.” Why? Is it because irregularities always result in financial correction?

What is the difference between error and irregularity? Irregularity in fact is any administrative or financial mismanagement, which includes both time and money loss. Irregularities exist. Such is life. Irregularities should not be denied, but should be disclosed and corrected. The most important thing is to assess whether the law is violated intentionally.

The fundamental question is related to the consequences of error - whether it is financial or non-financial as well as the intention and capabilities of final beneficiaries to correct these errors. How to reduce errors in EU funded projects? Of course, one could say that cooperation institutions should increase publicity measures to provide more advice and support to EU funds project final beneficiaries. The question – whether the final beneficiaries use the opportunity to receive these information, and whether they have sufficient good faith? As one of the most effective solution is to conduct preventive controls in order to timely identify gaps and errors, as well as to minimize the risks that endanger the management of EU funds projects.



Introduction

EU funds in 2007 to 2013 planning period are regulated by a number of EU laws and regulations, the most important of which is the Council Regulation No.1083/2006 of 11 July 2006 laying down general provisions on the European Regional Development Fund (ERDF), European Social Fund (ESF) and Cohesion Fund (CF). [3]

EU funds management in Latvia is regulated by the EU Structural Funds and Cohesion Fund Management Law, under which the following is stated:

- Rights and obligations of the institutions involved in the EU funds management as well as rights and obligations of the EU funds beneficiaries.
- The decision making and appeal procedures of the institutions involved in the EU funds management.
- The Cabinet of Ministers responsibility.

The planning process of EU funds is also done at both EU and national level – according to EU level strategy (*Community Strategic Guidelines*), national strategy (*National Strategic Reference Framework*) and national *Operational programmes*. [5]

The Latvian institutional framework of the EU funds management can be seen on the following figure.

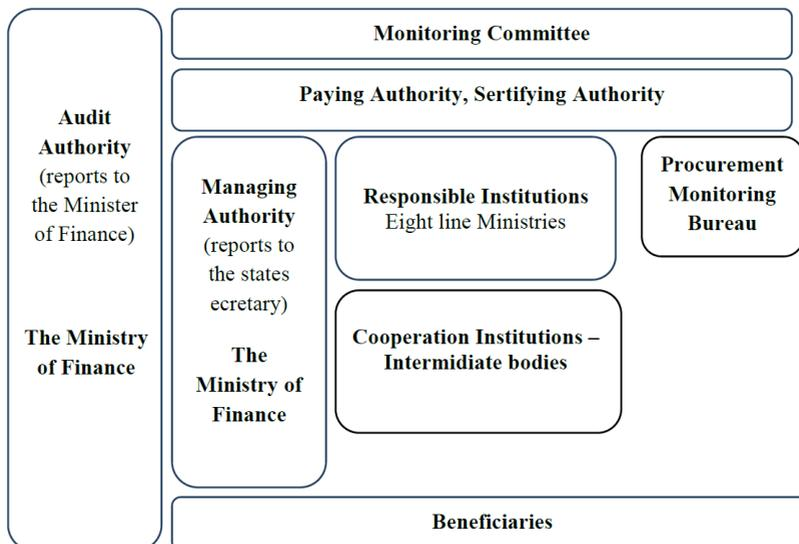

Figure 1. Latvian institutional framework of the EU funds management

Theoretical Background

According to the information provided in the figure 1 the management system of the EU funds in Latvia consists from multiple levels of authorities.

The first / highest level is the Monitoring Committee, which is established to ensure effective monitoring of the implementation of the EU funds under the priorities and targets set up in the Operational programmes.



Project Management Development – Practice and Perspectives

First International Scientific Conference on Project Management in the Baltic Countries

February 8-9, 2012, Riga, University of Latvia

The Monitoring Committee is chaired by the Head of the managing authority and includes representatives from the managing authority, responsible institutions, cooperation institutions, paying authority, certifying authority, Audit authority, as well as social, non-governmental and regional partners. In fact, the Monitoring Committee is one of the European Commission's tools by which the European Commission performs monitoring of the EU funds implementation, as representatives from European Commission always participate in the meetings of the Monitoring Committee.

The next level of the EU funds management is the managing authority, which functions is performed by the Ministry of Finance, and it is responsible for ensuring EU funds management and implementation. The managing authority, in cooperation with the responsible institutions and in consultation with the social, non-governmental and regional partners, developed national planning documents including Operational programmes for the period from 2007 to 2013, thus ensuring the partnership principle in the preparation of the planning documents, as well as ensuring coordination between structural and cohesion funds sectors. Moreover, the managing authority ensures development of computer-based EU funds management information system and evaluation of the EU funds and communication management.

Part of the functions of the managing authority in Latvia is delegated to the intermediate bodies—responsible institutions and cooperation institutions. Together with its functions the managing authority delegates to the intermediate bodies the responsibility to carry out controls at the beneficiaries level, but still Latvian legislation reserves the rights for the managing authority to perform its own on-the-spot verifications of individual projects on a sample basis in case of necessity. [2]

Intermediate bodies – responsible institution and cooperation institution for each EU funds activity is determined in the Operational programmes, which are approved by the Cabinet of Ministers and which also determines the division of responsibilities between before mentioned institutions. [3]

The responsible institutions are eight line Ministries:

- The Ministry of Economics;
- The Ministry of Finance;
- The Ministry of Education and Science;
- The Ministry of Culture;
- The Ministry of Welfare;
- The Ministry of Transport;
- The Ministry of Health;
- The Ministry of Environmental Protection and Regional Development;
- The State Chancellery.

Responsible institutions have the following functions, when conducting functions of the intermediate bodies:

- participate in the development of the planning documents including Operational programmes;
- develop EU funds project evaluation criteria;
- ensure selection and evaluation of the EU funds project applications;
- ensure project implementation monitoring and control;
- analyse the problems of the EU funds and project implementation and submit to the managing authority and to the Monitoring Committee proposals for the improvement of the implementation of EU funds activities and projects.



Project Management Development – Practice and Perspectives

First International Scientific Conference on Project Management in the Baltic Countries

February 8-9, 2012, Riga, University of Latvia

Responsible institutions perform the following controls on the beneficiaries' level in accordance with the delegated functions and based on the requirement set up by the European Commission and Republic of Latvia:

- Carry out on-the-spot verifications of individual projects on a sample basis.
- Carry out administrative verifications in respect of each payment claim received from the beneficiary, including:
 - Review of beneficiary's procurement plans.
 - Review of the documentation of the procurements carried out by the beneficiaries.
 - Check of beneficiary's payment claims and supporting documentation.
 - Check of beneficiary's project progress reports.

As can be seen from the above mentioned controls, all the controls can be divided into on-the-spot verifications and administrative verifications. The main difference between these two types of control is that the on-the-spot verifications are carried out at the premises of beneficiary and administrative verifications are carried out at the premises of the intermediate bodies on the documentation received from the beneficiaries. [1]

Responsible institution can delegate all or part of the before mentioned functions to the cooperation institution. In this case the performance of the controls is also delegated to the cooperation institution and responsible institution then maintains only the overall responsibility for the implementation of the EU funds activities, as well as the functions of developing of planning documents and evaluation criteria, which cannot be delegated, as these functions presumes the development of the legislation acts which is the direct function of the line Ministries.

The cooperation institutions are six state agencies:

- Central Finance and Contracting Agency.
- Latvian Investment and Development Agency.
- State Employment Agency.
- State Education Development Agency.
- State Regional Development Agency.
- Society Integration Foundation.

Till November 1, 2011, the Centre for Health Economics also performed functions of cooperation institution, but since the before mentioned date these functions have been transferred to the Central Finance and Contracting Agency.

The Procurement Monitoring Bureau is also acting as an intermediate body to which some of the managing authority's functions are delegated. The Procurement Monitoring Bureau carries out ex-ante checks of the beneficiaries' procurement documentation and procurement procedures. The goal of the ex-ante checks is to control the correctness of the procurement documents and procedure before the procurement contract is signed. Therefore the ex-ante procurement checks can effectively minimize the errors to a minimum and respectively the errors found can be corrected and have no financial impact.

Functions of the paying authority are performed by the State Treasury, and paying authority is responsible for making payments concerning EU funds projects and for financial accounting of payments made.

In addition to the paying authority functions, the State Treasury also performs functions of the certifying authority – prepares and submits to the European Commission certified expenditure declarations and payment claims, thus confirming that the expenditure declarations



are correct and result from the reliable accounting systems and are based on the verifiable supporting documents, as well as the expenditure declared complies with the applicable Community and Latvian law and are made in respect of operations selected for funding under the programme, the applicable criteria and complying with Community and Latvian legislation.

In order to prepare and submit to the European Commission certified expenditure declarations and payment claims, certifying authority must take a series of controls to make sure the incurred costs are real.

In order to ensure verification of the expenditure declarations and certification of expenditure the certifying authority shall carry out the following administrative controls:

- Checks of the data included in the interim expenditure declarations.
- Checks of the data included in the final expenditure declarations.
- Sample checks of the payment claims supporting documentation. [2]

Moreover for obtaining assurance, certifying authority has the right to propose and carry out on-the-spot verifications of individual projects on a sample basis.

Figure 2 clearly shows the role of the certifying authority and paying authority in the EU Funds management system. [3]

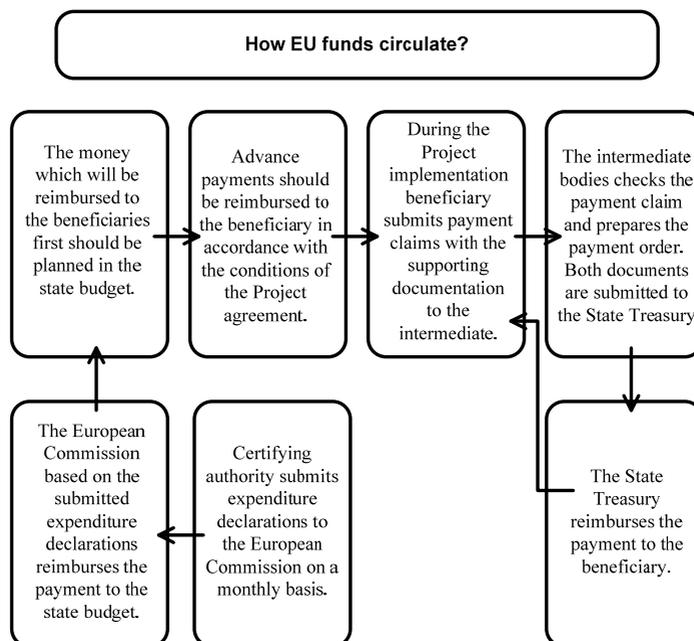

Figure 2. The role of the certifying authority and paying authority in the EU Funds management system

Audit authority has to be mentioned as a last element of the EU funds management system, which functions are ensured by the Ministry of Finance. Audit authority's functions are strictly separated from the managing authority's functions.

The purpose of the functioning of the Audit authority is to provide independent and objective statement to the European Commission, regarding the efficiency of the functioning of the management and control system of the EU funds and the legality and accuracy of the declared expenditure.



Project Management Development – Practice and Perspectives

First International Scientific Conference on Project Management in the Baltic Countries

February 8-9, 2012, Riga, University of Latvia

Audit authority is independent in the planning of the functioning thereof, the carrying out of audits, the preparation of reports and the provision of an opinion, and it operates in compliance with the International Standards on Auditing and the Code of Ethics.

In order to achieve its target the Audit authority performs:

- audits of the management and control system in the institutions involved in the management of the EU funds and follow up the progress of implementation of the recommendations expressed as a result of audits;
- audits of operations in the institutions involved in the management of the EU funds, as well as at the final beneficiaries and follow up the progress of implementation of the recommendations expressed as a result of audits.

The Latvian management and control system of EU funds is a part of the overall European EU funds management system and accordingly European institutions reserved rights to perform controls at a national level as well. [4]

The first controlling authority at a European level is the European Commission, which, chooses either to rely on the work carried out by the national audit authority or otherwise – makes ex-examination of the work carried out by the Audit authority or carries out independent controls.

The second controlling authority at a European level is the European Court of Auditors, which examines the effectiveness of the European Commission's work, as well as performs DAS test (checks individual project applications on a sample basis).

The European Commission as well as the European Court of Auditors when performing their controls can go up to beneficiaries' level.

Summarising all before mentioned and as described in Figure 3, the controls in the EU funds programming period from 2007 to 2013 can be carried out on the national level by the managing authority, responsible institutions, cooperation institutions, the Procurement Monitoring Bureau, certifying authority and Audit authority as well as on the EU level by the European Commission and the European Court of Auditors. Each of the mentioned institutions takes appropriate controls to make sure that EU funds are spent properly.

Research

The Member State must ensure that an adequate control system is in place to prevent irregularities occurring.

All the controls should be carried out on the original documents available at the final beneficiary and where controls are carried out on the copies of the documents (for example payment claims checks) the intermediate bodies should obtain assurance that the originals are maintained at the final beneficiaries level (for example by carrying out on-the-spot checks). The information on all carried out controls is available in the database managed by the managing authority – the Management Information System, ensuring that all the institutions involved in the management of EU funds have the access to this information and can use it in order to optimise its controls.

Measures to prevent errors or irregularities usually are provided in the result of controls. If irregularities are identified the procedure needs to be started as well to:

- Notify the competent authorities of the event in order to determine proprietary, administrative, civil or penal responsibility.



Project Management Development – Practice and Perspectives

First International Scientific Conference on Project Management in the Baltic Countries

February 8-9, 2012, Riga, University of Latvia

- Recover any EU funds that were unduly used, ensure the restitution to the central administration on the part of the State, and to the European Commission on the part of the Community.

Moreover the managing authority shall adopt the measures necessary to end the irregular situations.

Common question asked during EU funds project controls is: “Do you have irregularities?” The answer usually received is: “No, we have just errors.” The reply which will never be received is: “We do have irregularities.” Why? Is it because irregularities always result in financial correction? Each Member State has established a set of rules for penalties and financial corrections to be used in the case of irregularities. These penalties and financial corrections are usually based on the principle of proportionality – the more serious is the irregularity the more money should be paid back and the most substantial irregularity is that is done intentionally – fraud.

In order to avoid irregularities and loss at the levels of both the beneficiary and at the national level first focus should be on providing strategic legislation to the EU funds controllers and beneficiaries. [1]

EU funds control research was based on the management and control system audits carried out by the Audit Authority’s during 2011 in the institutions involved in the management of the EU funds 2007-2013 planning period – managing authority, certifying and paying authority, Procurement Monitoring Bureau, responsible authorities (8 line ministries and State Chancellery) and cooperation authorities (6 agencies). In total results of 15 management and control system audits were analysed. Peripheral research was carried out on audits of operation at the final beneficiaries. In total results of 127 EU funds projects’ audits were analysed.

First of all we should be convinced that the project meets the selection criteria. Thus, the mature selection criteria developed by the responsible institutions will be, the less risk of negative impact on the state budget will be, but taking into account that controls performed by the intermediate bodies should also be very strong.

It is already has been described before that there are administrative controls and on-the-spot control, but what should be checked during these controls?

The most important controls performed by the intermediate bodies are controls on the expenditures.

There are the 2 ways to make expenditure real:

- Real Costs.
- Simplified Costs:
 - indirect costs declared on a flat-rate basis, up to 20% of the direct costs of a project;
 - flat-rate costs calculated by application of standard scales of unit cost as defined by the Member State;
 - lump sums to cover all or part of the costs of a project.

The controls carried out on the expenditures directly depend on the way the expenditures are made real.

In the case of real costs typical documents that are subject to checks by EU funds project controllers are:

- Invoices.
- Ledgers (proofs of payment).
- Pro-rata basis if needed.



Project Management Development – Practice and Perspectives

First International Scientific Conference on Project Management in the Baltic Countries
February 8-9, 2012, Riga, University of Latvia

In the case of simplified costs:

- There are no supporting documents about costs at the beneficiaries' level.
- Documentation is available only at programme level – the flat-rates, unit costs or lump sums are stated in the Cabinet of Ministers regulations on the implementation of certain activity.
- Specific attention during the controls should be paid to the outputs and / or results of a project.

Besides checks of the expenditures checks also should be carried out in order to verify if the products/services/construction is actually delivered /made in accordance with the project agreement. Particular attention during these controls must be paid on:

- Project budget not overrun.
- Budget line respected (and correctly registered).
- Financial plan respected.
- Timetable respected.
- Indicators achieved.
- If there are clear linkages to the project (deliverables).
- If the changes made in the project agreement meets the project selection criteria.

The next step is to gain assurance whether the project is implemented in accordance with EU and national laws which includes:

- The eligibility rules. The eligibility rules at Latvian level are stated in the Cabinet of Ministers regulations on the implementation of certain activity. And particular attention during controls of eligibility must be paid on:
 - Time – are there activities outside eligibility dates? Is there a need for pro-rata basis? Is there a need for depreciation costs?
 - Location – are benefits for the eligible regions respected? Is there specification for travel and accommodations? Is there a need for pro-rata basis?
 - Action – Expenditure related to the project? Is there a need for pro-rata basis?
- Durability and Revenue:
 - In case of projects with the investments in infrastructure and operational investments it should be controlled if the maintenance of an investment or jobs created is ensured within five years (three for SME) from the completion of the project.
 - In case of profit generating projects it should be controlled if the revenue generated within five years of the completion of a project is deducted from the expenditure declared to the European Commission.
- Information and Publicity Rules. Particular attention during the controls of information and publicity should be paid to that if the publicity and information measures ensure following:
 - Increase transparency and awareness of EU funds.
 - Let the public know that EU money is being well spent.
 - Helping others to benefit from your activities, good practices and results achieved.
 - Ensure maximum benefit by multiplying the effects of EU funding.
 - Creating awareness of project activities and results.



Project Management Development – Practice and Perspectives

First International Scientific Conference on Project Management in the Baltic Countries

February 8-9, 2012, Riga, University of Latvia

The next step is to gain assurance whether the project is implemented in accordance with the EU treaty rules which include:

- State aid. When verifying if state aid rules relates to a project the following cumulative criteria should be assessed and all criteria have to be met to constitute state aid:
 - Granted by a Member State or through State resources.
 - Advantage “favouring” certain undertakings or the production of certain goods.
 - Distortion or risk of distortion of competition.
 - Effect on trade between Member State.
- Public procurement – whether the project is implemented in accordance with the Public Procurement Law and is not contrary to the European Commission Directives on public contracts. Here, the role of the Procurement Monitoring Bureau here must be stressed out, but, unfortunately, the Procurement Monitoring Bureau performs controls on a sample basis and it’s amount is too small, as well as the Procurement Monitoring Bureau does not have all the necessary procurement documentation when performing it’s ex-ante checks. Accordingly the procurement ex-post checks carried by the intermediate bodies still should be very strong.
- Gender Equality – controllers must verify if the equal treatment between women and men is respected during project implementation.
- EU environmental policies and rules should be checked not only in compliance with EU and national legislation but also against provisions of the project agreement, if specific contributions are foreseen.

The intermediate bodies shall include procedures to avoid double-financing of expenditure with other Community or national schemes and with other programming periods. Particular attention during controls of double-financing should be paid to:

- Expenditure already claimed.
 - For these financial perspectives.
 - In previous financial perspectives.
- Expenditure double-claimed.
 - Under Structural Funds.
 - In other EU programme.
- Operation over-financed.
 - Financial plan not respected.

When performing the study of the errors found by the institutions involved in the EU funds management typical errors made by the EU funds beneficiaries were identified:

- Incorrectly calculated resources necessary for the project implementation – financial, time limits, people.
- Delayed project deadlines.
- The commercial extensions are not coordinated.
- Lack of carefully selected partners.
- Poorly planned cash flow.
- The agreement is not read and beneficiary has not complied with the agreement conditions.
- Expenditure estimates is not provided.



Project Management Development – Practice and Perspectives

First International Scientific Conference on Project Management in the Baltic Countries

February 8-9, 2012, Riga, University of Latvia

- Project accounting procedures are not described in the accounting methodology, which does not contribute to the audit trail.
- Accounting does not comply with Latvian laws and regulations - the principles of accounting, document processing, transaction legality.
- The data on the preparation of payment claims is not kept.
- The data that do not meet the accounting is included in the payment claims.
- The contract / project number is not indicated in the project-related documentation, thus creating the risk of double-financing.
- There is no evidence that the project manager controls the progress of the project and finances.
- Documents are not stored in accordance with statutory requirements and contractual terms (term used in the nomenclature, storage location records).
- The nomenclature does not set the document retention period.

Mostly all of the above mentioned errors are timely preventable by use of preventive measures, as well as by complying with the above mentioned requirements, upon receipt of EU funding.

Conclusion

The research on the EU funds controls provides the following conclusions.

- The established EU funds project control mechanism is heavy.
- All the institutions involved in the EU funds management perform EU funds project controls, accordingly there is no single institution which would have the overall vision of results from performed controls and thus the overall compliance of projects with EU and Latvian regulations.
- It is necessary to focus on the EU funds project ex-ante checks, eliminating the errors in the project initiation stage, thereby minimizing the potential non-compliance and avoiding financial corrections.
- By identifying typical errors made during EU funds projects implementation, the beneficiaries should focus on the preventive measures in order to timely prevent errors.
- When applying for the EU funding the beneficiaries should get acquainted with the set requirements and should follow them in good faith.

References

1. Franck Sottou, *A to Z Guide for Perfect European Funds Managers*, France, Aubervilliers, ETCP Editions, 2010, 85 p.
2. Annual Control Report for the period from 01.07.2010. to 30.06.2011. (Approved 23.12.2011.).
3. Council Regulation (EC) No 1083/2006 of 11 July 2006 laying down general provisions on the European Regional Development Fund, the European Social Fund and the Cohesion Fund and repealing Regulation (EC) No 1260/1999 (OJ L 210, 31.7.2006, 25 p.
4. http://www.liaa.gov.lv/uploaded_files/00JAUNIE00/Sfondi/KAN/Mainamie/APA2/Programma_11_01_11.pdf.
5. Draft National Strategic Reference Framework 2007-2013, Ministry of Finance of Republic of Latvia, 2007, 116 p.

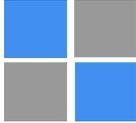

COMPANY REPUTATION – LONG TERM PROJECT FOR COMPANY SUCCESSFUL DEVELOPMENT

Laura Kersule

Faculty of Economics and Management

University of Latvia

Aspazijas bulv. 5, Riga, LV-1050, Latvia

E-mail: Laura.Kersule@imt.lv

Biruta Sloka

Faculty of Economics and Management

University of Latvia

Aspazijas bulv. 5, Riga, LV-1050, Latvia

E-mail: Biruta.Sloka@lu.lv

Keywords: human resource management; project management; company image

Abstract

The speedy development of modern telecommunication technologies in the world as well as in Latvia has led to struggle and close contest in today's telecommunication industry. Telecommunication companies demand that their staff would be educated, creative, efficient, motivated and loyal. Preparation of good practitioners able to perform activities for creation of competitive products and services takes time and huge efforts. Companies are interested to keep their professional staff for the company development as the scientific research has proved that employment of new employees is more expensive. For keeping qualified personnel efficient motivation ways and means are needed. To keep so good and motivated staff besides material and moral motivators is very important also company image in the eyes of the current employees as well as in the minds of general public where are also possible future employees, but of course, current service users.

The purpose of the study was to explore relationships between motivation factors and company image – attractiveness of company as employer; examine factors that are associated with likelihood that employees will engage in effective and efficient business performance, evaluate how changes the evaluations of the company as attractive employer during the last five years when attractiveness of companies and organisations are evaluated. Authors compared findings on factors associated with likelihood that employees will engage in effective and efficient business performance and analyzed what are the relationships among – motivation and company image in telecommunication and other industries in Latvia. Research methods used: scientific literature review, survey of employees (1098 surveys of general public and 473 surveys of telecommunications industry employees are used for empirical data analysis). The following measures in the survey were used to: 1) list of motivators; 2) list of statements on skills, engagement and resources available in company; 3) perceptual performance; 4) demographic profile of sample (age, gender, occupational type and detailed

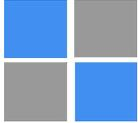

information on position, education, income and industry). The respondents were asked to use 7-point scale ranging from 1 – inapplicable to 7 – applicable in higher extent to indicate which motivational instruments are applied in current working place. Skills were evaluated in 7-point scale, where 1 – strongly disagree and 7 – strongly agree. For data analysis factor analysis as well as indicators of central tendency or location and indicators of variability and cross-tabulations were used.

Theoretical Background

Researches on employee behaviour in organizations have outlined several critically significant factors that can either positively or negatively influence the overall performance of company or organization. There is common assumption in both academic and professional environment that qualitatively selected and managed human capital in the most important factor advancing a company's success. In times when unpredictable economic changes take place, the human capital available to organizations has to be managed and used so that it would be useful, reflective to society's changing needs, productive and effective in creating new value [2]. There are approaches of researchers who underline that company management has to pay attention to project management in the company [9; 15]. Researchers Meyer, Becker and Vandenberg [12] emphasize that although knowledge is recognized as one of the company's most valuable assets, most companies lack a systematic approach towards maintaining knowledge as a value and utilizing for company's needs. Researchers Humphrey, Nahrgang and Morgenson [10] emphasized that the return on investment in knowledge and the creation of skills is a long term process, therefore, from the viewpoint of return on investment and effectiveness, keeping an employee is important. Moreover, the skills and wish to utilize one's knowledge also depend on one's salary, professional development, career opportunities and job content [3]. In turn, researcher Meyer [17] associates knowledge transfer in a company with employee's commitment to it. Commitment component is included in an employee's intellectual capital definition and according to him/her, a company's intellectual capital is the competence of each one of his employees or skills, knowledge and personal characteristics in synergy with each employees readiness to work to their full potential. In scientific literature [19; 14; 28; 31], there exist conclusions that there are several reasons why employees become committed to companies. These factors can be both emotional attachment to an organization whose values correspond to those of employees and rational considerations on gaining material benefits, and also the feeling of responsibility towards an organization [17]. Organizational scientists and practitioners have long been looking for answers what does effective behaviour of employee drive more – motivation or commitment, is there a difference between motivation and commitment, are both concepts worth retaining and if so, how they are related and how they combine to influence employee's behaviour? One explanation for the relative independence of the two concepts is might be differences in their origin and objectives. Theories of work motivation evolved out of more general theories of motivation and have largely been applied to explain task performance. This emphasis is most evident in goal setting theory developed in great extent by Locke and Latham [20] which is dominant theory in work motivation literature [25; 15; 30]. In turn commitment has its roots in sociology and social psychology and is viewed as a potential predictor of employee turnover. However, motivation theories have since been used to explain

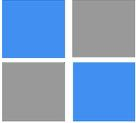

turnover [21; 32] and commitment has been examined as determinant of job performance [4; 6] and organizational citizenship behaviour [27; 23; 5]. The motivation as concept is generally defined as a composition of powers and mechanisms which help to direct human behaviour in a desired manner or with a more specific context it is described as the all convincing and encouraging actions which employees fulfil their tasks willingly and to come closer to organizations' objectives. In turn commitment is defined in similar way as a force that binds an individual to a course of action that is of relevance to particular target [3]. Recently serious attempts have been made to insert psychological theories of motivation into economic theories mainly because of connecting extrinsic motivation and employee's productivity or work performance.

Researchers Moorhead and Griffin [18] claim that retaining the employee and his productivity depends on his motivation. They conclude that a successful application of several motivators increases job satisfaction and therefore enhances job productivity. The relationship between motivation and productivity can be summarized as that productivity is directly linked to motivation, and motivation is, in turn dependent on productivity. Suitable motivation of employees can be hypothesized as a key contributor to maximizing workers' productivity [29]. The output or performance of employee is a function of effort, ability and incentives. Incentives being the fundamental of economics, grounded by agency theory which rely on perception that motivation and increased performance can be explained by external stimulus mainly [11]. Researcher Sumanth [29] defines productivity as the amount of work that an employee can perform in a specific period of time. More often productivity is being regarded as a quantitative measure of work and is being associated with speed in which an employee can perform a task in comparison with others performing a similar task. Perceptions of productivity concepts vary widely within engineering, academia, manufacturing and service industries. In academic research [8; 18; 26] continuously is confirmed that services are becoming increasingly important. As economies world-wide are experiencing a tremendous shift from manufacturing to knowledge-based service, the major competitive advantage of these industries has become service quality and customer loyalty consequently. Numerous studies support the idea that a link exists between employee satisfaction and customer satisfaction, productivity, and financial results [6; 13; 33]. As customer loyalty is viewed as a primary determinant of a company's profit and growth, the existing researches on human resource management in different businesses highlight that value to the customer is created by loyal and satisfied employees [7; 20; 25]. Employee involvement and satisfaction are acknowledged as two of the most important drivers of continuous improvement and satisfied customers. Total quality management concept argues that satisfied employees are highly motivated, have good work morale, and work more effectively and efficiently [17]. However currently a large amount of studies measured of effectiveness and motivation of employees are devoted to manufacturing industries, the measurement researched in the field of telecommunication industry are hardly fewer [22]. This study will provide insight into the fact how motivational forces can enhance performance of employees in telecommunication industry in countries like Latvia where productivity rate call to question issues which motivate or demotivate employees.

Companies values and culture may not only be a factor attracting employees but it also performs by retaining employees and enhancing commitment towards the company. Employees that wish to work in the company for a longer period of time mention company values and their

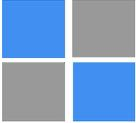

Project Management Development – Practice and Perspectives

First International Scientific Conference on Project Management in the Baltic Countries

February 8-9, 2012, Riga, University of Latvia

realization in organization's culture as one of the attracting factors. However, the greater the discrepancy between the declared values and realized culture, the greater disagreements between the management and employee are expected, the greater the dissatisfaction with work and more cynical behaviour from employees. Moreover, it is believed that the more organization's preferable and real values and realized culture correspond, the more employees are trustworthy and motivated to work in this company [19] Therefore, the author sets to research whether company's culture could work as a motivational factor which strengthens motivation.

The main purpose of this study is exploring what factors influence motivation and commitment in service sector particularly in telecommunication industry in Latvia. The paper will contribute to the explanation of understanding of the relationships between people motivation dimensions and effective performance in service sector. The results of this study can provide telecommunication operations with insights into resource allocation for motivating employees and getting competitive advantage as well as help with strategic decision-making, especially regarding operational styles under an intense competitive environment.

Empirical Research Results

The author have chosen telecommunications industry which has been characterized by one of the most stable growth trends also during the economic crisis, intense competition in the industry, especially in mobile communications niche, diverse range of products offered, and changes from being discretionary to essential service for customer needs. In Latvia, 2010 there were 419 registered electronic communications' merchants out of which 297 were operating [22]. 47 electronic communication's merchants [22] have indicated that they operate in whole territory of the Republic of Latvia, while the rest operates in some regions or cities. However, it should be noted that the majority of electronic communications' merchants are small and the offered services are available only in small parts of the region or in cities. Internet and mobile communications have developed particularly rapidly, therefore, these areas should be specifically analyzed when discussing the future and development of telecommunications industry. In the past years, the number of merchants that provide internet access services has decreased, while the number of provided access points significantly increases. The Latvian telecommunication industry can be characterized by a small group of strong players, possessing significant market power. For many years the major state owned telecommunication company *Lattelecom* took the leading role in providing fixed line services. The role was altered by two strong mobile operators *Latvijas Mobilais telefons (LMT)* (state and *Lattelecom* owned) and *Tele2*, acquired by foreign investors and being represented in all three Baltic countries. Lately *Bite* started price and marketing aggressive activities in Latvian market that shaped price and products' offerings in this industry. A telecommunications company must invest resources in company's development in order for it to be competitive and attracting clients. When comparing capital investments in telecommunications operators, it can be concluded that investments have decreased in all telecommunication companies' during the economic crisis in Latvia. A significant part of investment for mobile communications operators are channelled into the development of network because it is one the main competitive

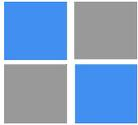

advantages which is highly valued by clients. If the overlay of providing voice services practically covers all territory of Latvia for all three operators, then in order to provide a fast and qualitative data transmission operators actively invest in new generation (3G) network development. 3G mobile internet technology is able to provide data download speed up to 42 megabits per second [22]. Leading mobile communications companies in Latvia have already tested the next generation's – fourth's 4G network, however, none of the operators have intended to hurry up with its implementation due to the lack of a certain business model that would be attractive to both the consumer and the company [22]. Telecommunications industry is not only technologically rapidly developing sector, but also an industry that actively attracts and employs workforce. According to research findings from Lithuania telecommunication industry, the usage of non-financial company's performance measures for top level management decision making is prevalent against the usage of financial measures [13]. Such factors as customer service and service quality are high-ranked and always connected to employee satisfaction, loyalty and motivation. Moreover, employees working in this industry differ from other by demographic and social indicators. Also job content is different – employees are required to have higher competence, creativity and good communication skills. Possibly, the work culture in this industry is more client and quality oriented, therefore satisfaction of clients, good financial results and progressive technological solutions are among the requirements, goals for the employees.

To evaluate attractiveness and reputation of the company, authors have used the research results of research and consulting company *Workingday* [24] which already fifth year have conducted research on the most attractive employer in Latvia. 2400 respondents are asked to give answers several questions among them: "Which employers are most attractive in the eyes of employees?". The results of Ranks of LMT (Latvijas Mobilais Telefons) in surveys as the most attractive employer in Latvia 2007 – 2011 are stated in table 1.

Table 1

Ranks of LMT (Latvijas Mobilais Telefons) in surveys as the most attractive employer in Latvia 2007 – 2011

Year	2007	2008	2009	2010	2011
Number in rank 1-100	2	2	1	2	1

Source: Ranks performed by results of surveys by Workingday in 2007 – 2011 (n=2400)

To evaluate the situation of employees motivation and importance of the company reputation in telecommunication industry in comparison with other industries in Latvia, author has initiated survey of employees (1098 surveys of general public and 473 surveys of telecommunications industry employees). The respondents were asked to use 7-point scale ranging from 1 – strongly disagree and 7 – strongly agree. Results of factor analysis on evaluations of statements in telecommunication companies and other companies in Latvia in 2010 are presented in table 2.

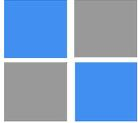

Table 2

Rotated Component Matrix of responses of Telecommunication Companies and Other Employees on Company's Streak by Views of Employees

Initial factors/evaluated by respondents*	Component** for telecommunication companies (n=473)			Component*** for other employees (n=1098)	
	1	2	3	1	2
Stable	0.536	0.361	0.046	0.236	0.580
Fair	0.786	0.171	0.179	0.550	0.515
Equitable	0.788	0.171	0.271	0.610	0.449
Responsive	0.778	0.203	0.290	0.683	0.479
Arranged	0.729	0.308	0.154	0.440	0.567
Supportive for personality development	0.797	0.192	0.179	0.736	0.352
Energetic, inspiring	0.746	0.303	0.266	0.693	0.450
Ensures unique professional experience	0.643	0.342	0.065	0.584	0.368
Creative	0.676	0.160	0.251	0.689	0.369
Dynamic	0.612	0.458	0.254	0.644	0.422
Controlling	0.161	0.712	-0.214	0.075	0.746
Not restrictive	0.450	-0.095	0.677	0.751	-0.032
Oriented on big goals	0.185	0.671	0.278	0.178	0.672
Flexible	0.632	0.116	0.498	0.780	0.290
Not bureaucratic	0.352	0.022	0.698	0.678	0.136
Informal	0.371	-0.006	0.665	0.699	-0.036
Exacting (high prerequisite to performance of individuals)	0.345	0.690	-0.033	0.191	0.765
Democratic	0.713	0.113	0.443	0.774	0.244
Problem recognition and solution attitude	0.751	0.220	0.273	0.590	0.528
Client oriented	0.429	0.473	0.233	0.384	0.641
Profit oriented	-0.147	0.488	0.692	0.064	0.612
Energetic	0.622	0.448	0.225	0.592	0.529
Quality oriented	0.603	0.480	0.180	0.228	0.726

Extraction Method: Principal Component Analysis.

Rotation Method: Varimax with Kaiser Normalization

* Evaluation scale 1 – 7, where 1 – fully disagree; 7 – fully agree

** Rotation converged in 15 iterations

*** Rotation converged in 3 iterations

Source: survey results in 2010, author's calculations

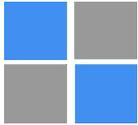

In situation of telecommunication employees factor analysis was performed in 15 iterations and 3 complex factors were calculated. Authors the complex factors named: creative development factor; control and client oriented factor and informal relations factor. In situation of other employees factor analysis was performed in 3 iterations and 2 complex factors were calculated. Authors the complex factors named: organisational factor; competitiveness factor. Evaluations of statements in telecommunication companies and other companies in Latvia related to exacting (high prerequisite to performance of individuals) and quality orientation is reflected in table 3.

Table 3

Distribution of main statistical indicators on evaluations of statements in telecommunication companies and other companies in Latvia in 2010

		Exacting (high prerequisite to performance of individuals)		Quality oriented	
		Telecommunication	Other	Telecommunication	Other
No	Valid	473	1098	473	1098
	Missing	0	0	0	0
	Mean	6.13	5.49	6.22	5.49
	Std. Error of Mean	0.040	0.042	0.042	0.045
	Median	6.00	6.00	6.00	6.00
	Mode	6	6	7	7
	Std. Deviation	0.878	1.384	0.907	1.484
	Variance	0.771	1.915	0.822	2.201
	Range	4	6	6	6
	Minimum	3	1	1	1
	Maximum	7	7	7	7

Evaluation scale 1 – 7, where 1 – strongly disagree; 7 – strongly agree

Source: Author’s calculations, data of survey August – December, 2010: telecommunication employees (n=473) and other employees (n=1098)

Data of table 3 indicates that evaluations on statement “Exacting (high prerequisite to performance of individuals)” are a little higher (arithmetic mean) in telecommunication companies, as well as variability of responses is lower in telecommunication companies. Distribution of evaluations on statement that employees have “Exacting (high prerequisite to performance of individuals)” in telecommunication companies and other companies in Latvia in 2010 is presented in table 4.

Data of table 4 indicates that evaluations on statement “Exacting (high prerequisite to performance of individuals)” are higher in telecommunication industry (there are no lower

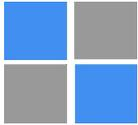

evaluations, more that 80% of respondents give the evaluation 6 or higher), for other industries 1.1% of respondents gave the lowest evaluations and evaluation of 6 or more gave 58.2% of the respondents. Distribution of evaluations on statement that employees have notion that company is “Client oriented” in telecommunication companies and other companies in Latvia in 2010 is presented in table 5.

Table 4

Distribution of evaluations on statement that employees have “Exacting (high prerequisite to performance of individuals)” in telecommunication companies and other companies in Latvia in 2010

		Telecommunication		Other	
		Frequency	Percent	Frequency	Percent
Valid	1	0	0	12	1.1
	2	0	0	25	2.3
	3	3	0.6	66	6.0
	4	24	5.1	144	13.1
	5	65	13.7	212	19.3
	6	197	41.6	338	30.8
	7	184	38.9	301	27.4
	Total	473	100.0	1098	100.0

Evaluation scale 1 – 7, where 1 – strongly disagree; 7 – strongly agree

Source: Author’s calculations, data of survey August – December, 2010: telecommunication employees (n=473) and other employees (n=1098)

Table 5

Distribution of evaluations on statement that employees have notion that company is “Quality oriented” in telecommunication companies and other companies in Latvia in 2010

		Telecommunication		Other	
		Frequency	Percent	Frequency	Percent
Valid	1	1	0.2	19	1.7
	2	1	0.2	36	3.3
	3	2	0.4	68	6.2
	4	19	4.0	128	11.7
	5	60	12.7	197	17.9
	6	175	37.0	318	29.0
	7	215	45.5	332	30.2
	Total	473	100.0	1098	100.0

Evaluation scale 1 – 7, where 1 – strongly disagree; 7 – strongly agree

Source: Author’s calculations, data of survey August – December, 2010: telecommunication employees (n=473) and other employees (n=1098)

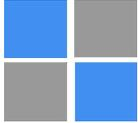

Data of table 5 indicates that evaluations on statement that employees have notion that company is “Quality oriented” are higher in the telecommunication companies (evaluation of 6 or higher is given by 82.5% of the respondents), in other fields evaluations differ more and highest evaluations are much less (evaluation of 6 or higher is given by 59.2% of the respondents).

Conclusions

The company image in the eyes of employees as well as general public has to be among the priorities in company management: this project has to be long – term and serious attention demanding. Besides payment and stability factors there are many other factors influencing image of the company as attractive employer. Among the motivation factors for employees on great importance are exacting (high prerequisite to performance of individuals) and that employees have notion that company is “Quality oriented”. Employees of telecommunication companies have evaluated the exacting (high prerequisite to performance of individuals) higher as representatives from other fields.

References

1. Adomaitiene R., Slatkevičiene G., Employee Satisfaction and Service quality in Contact Centres, *Economics and Management*, 2008, 13, pp. 770-775.
2. Bandura, A., Schunk, Dale H., Cultivating Competence, Self-Efficacy, and Intrinsic Interest Through Proximal Self-Motivation, *Journal of Personality & Social Psychology*, Sep. 1981, Vol. 41, Issue 3, pp. 586-598.
3. Deci, E. L., Ryan, R. M., The “what” and “why” of goal pursuits: Human needs and the self-determination of behaviour. *Psychological Inquiry*, 2000, Vol. 11, pp. 227-268.
4. Dysvik A., Kuvaas B., The relationship between perceived training opportunities, work motivation and employees outcomes, *International Journal of Training and Development*, 2008, pp. 138-157.
5. Fernandez, Z., Usero B. (2009). Competitive behaviour in the European mobile telecommunications industry: Pioneers vs. followers, *Telecommunications Policy*, Vol. 33, pp. 339-347.
6. Fleck, D. L. Why We Should Dare to Manage Growth Responsibly, *Management Decision*, Vol. 48, No 10, 2011, pp. 1529-1538.
7. Gains – Ross, L. Corporate Reputation. *Wiley & Sons*. 2008. 657 p.
8. Hackman, J. R., Oldham, G. R., Development of the Job Diagnostic Survey. *Journal of Applied Psychology*, 1975, 60, pp. 159-170.
9. Heumann, M., Keegan, A., Turner, J.R. Human Resource Management in the project – oriented company: A review, *International Journal of Project Management*, 2007, Vol. 25, pp. 315-323.
10. Humphrey, S., E.; Nahrgang, J., D.; Morgeson, F., P., Integrating Motivational, Social, and Contextual Work Design Features: A Meta-Analytic Summary and Theoretical Extension of the Work Design Literature, *Journal of Applied Psychology*, Sep. 2007, Vol. 92, Issue 5, pp. 1332-1356.
11. Jeremy Pincus, The consequences of unmet needs: The evolving role of motivation in consumer research, *Journal of Consumer Behaviour*, 2011, Vol. 3, 4, pp. 375-387.
12. John P. Meyer, Thomas E. Becker, Christian Vandenberghe, Employee Commitment and Motivation: A Conceptual Analysis and Integrative Model, *Journal of Applied Psychology*, 2004, Vol. 89, No. 6, pp. 991-1007.

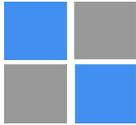

Project Management Development – Practice and Perspectives

First International Scientific Conference on Project Management in the Baltic Countries

February 8-9, 2012, Riga, University of Latvia

13. Jurkštieņe A., Darškuvienė V., Dūda A., Management Control Systems and stakeholders' Interests in Lithuania multinational Companies: cases from the Telecommunications industry, *Journal of Business Economics and Management*, 2008, 9(2), pp. 97-106.
14. Kazlauskaitė, R., & Bučiūnienė, I. HR function developments in Lithuania, *Baltic Journal of Management*, 2010, Vol. 5 (2), pp. 218-241.
15. Koskinen K. U., Problem Absorption as an organisational learning mechanism in project – based companies: Process thinking perspective, *International Journal of Project Management*, 2012, Vol. 30, pp. 308-316.
16. McFillen, J.M.; Maloney, William F., New answers and new questions in construction worker motivation. *Construction Management & Economics*, Mar 1988, Vol. 6, Issue 1, pp. 12-35.
17. Meyer J.P., Herscovitch L., Commitment in the workplace: Toward a general model, *Human Resources Management Review*, 2001, Vol. 11, pp. 299-326.
18. Moorhead G., Griffin R. W., Organizational behaviour: managing people and organizations (5th edition), Houghton Mifflin, Boston, 1998.
19. Latham, G. P., Pinder, C. C., Work motivation theory and research at the dawn of the twenty-first century. *Annual Review of Psychology*, 2005, Vol. 56, pp. 485-516.
20. Locke, E. A., Latham, G. P., What should we do about motivation theory? Six recommendations for the twenty-first century, *Academy of Management Review*, 2004. Vol. 28, pp. 388-403.
21. Osterloh, M., Frost, J., Frey, B., The Dynamics of Motivation in New Organizational Forms, *International Journal of the Economics of Business*, Feb2002, Vol. 9, Issue 1, pp. 61-77.
22. Review of Public service regulation committee on telecommunication industry in Latvia, 2011. May, <http://www.sprk.gov.lv/index.php?id=11057&sadala=616>.
23. Rafikul I., Ahmad Zaki Hj, I., Employee Motivation: a Malaysian perspective, *Journal of Consumer Behaviour* 2011, Vol. 3, 4, pp. 346-359.
24. *Ranks performed by results of surveys by Workingday in 2007 – 2011*, www.workingday.lv, observed 10.01.2012.
25. Ross, S., George Loewenstein: Exotic Preferences: Behavioural Economics and Human Motivation. Mission Possible? The Performance of Prosocially Motivated Employees Depends on Manager Trustworthiness, *Czech Sociological Review*, 2008, Vol. 44, Issue 6, pp. 1200-1205.
26. Ryan, R. M., Deci, E. L., Overview of self-determination theory. In E. L. Deci, & R. M. Ryan, Rochester, NY: University of Rochester Press, 2002, pp. 3-33.
27. Ryan, R.M., Deci, E.L., Self-determination theory and the facilitation of intrinsic motivation, social development and well-being, *American Psychologist*, 2000, Vol. 55, pp. 68-78.
28. Savaneviciene A., Stankeviciute Z., Human Resource Management Practices Linkage with Organizational commitment and Job Satisfaction, *Economics and Management*, 2011, Vol. 16, pp. 921-929.
29. Sumanth, D., Total productivity management. A Systemic and Quantitative Approach to Compete in Quality, Price and Time. USA, 1998, CRC Press LLC.
30. Van Yperen, N. W., Hagedoorn, M., Do High job Demands Increase Intrinsic Motivation of Fatigue or Both? The Role of Job Control and Job Social Support, *Academy of Management Journal*, Jun. 2003, Vol. 46, Issue 3, pp. 339-348.
31. Vroom, Victor H., Jones, Stephen C., Division of Labor and Performance under Cooperative and Competitive conditions., *Journal of Abnormal & Social Psychology*, Mar. 1964, Vol. 68, Issue 3, pp. 313-320, 8 p., 4 Charts.
32. Wang Ke-Yi, Liu Lin-Lin, An Empirical Study of Service Innovation's Effect on Customers' Repurchase Intention in Telecommunication Industry, *Canadian Social Science*, Vol. 6, No. 5, 2010, pp. 190-199.
33. Župerkiene E., Žilinskas V. Analysis of Factors Motivating the Managers' Career, 2008, *Engineering Economics*, No 2, pp. 85-92.

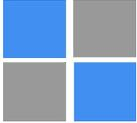

SUPPORT OF COLLABORATIVE WORK THROUGH THE ANOTO- AND MULTI-TOUCH TECHNOLOGY

Marius R. Khan, Can Elmali, Christian Reimann, Sabine Sachweh, Carsten Wolff

Multi-touch Group

Department of Computer Science

University of Applied Sciences and Arts

FH Dortmund, Emil-Figge-Str. 42, 44227 Dortmund, Germany

E-mails: marius.khan@stud.fh-dortmund.de, can.elmali@fh-dortmund.de,

christian.reimann@fh-dortmund.de, sabine.sachweh@fh-dortmund.de,

carsten.wolff@fh-dortmund.de

Keywords: project management, collaborative work, pen-based interfaces, multi-touch interaction

Abstract

This paper deals with the usage of the fundamental technology that explores the interaction between real paper and digital systems to support collaborative work. To take notes or drawings during a meeting, traditional paper is preferred to current technical devices. However, we can also see the rising popularity of devices which are based on multi-touch technology. The Anoto technology in combination with a multi-touchtable bridges the gap between real paper and digital realms. However, these technologies do not deliver solutions of supporting collaborative work in the industry.

Therefore we present a collaborative concept to support collaborative work in business environments using the Anoto and multi-touch technologies. As an example of a business domain we chose the architectural context. Our custom-made software prototype gives an idea of how the workflow in architectural offices can be facilitated. We then provide an introduction of the approaches that support collaborative work through these technologies. At the end of this paper, we present an evaluation of our concept. The results of the evaluation show how professionals in the open industry having additional knowledge in project management assess the concept. We can conclude that the majority of the participants prefer the utility of the introduced concept regarding the facilitation of collaborative work.

1. Introduction

The human computer interface is continuously improving and users permanently get new possibilities to enter specific data to the digital system. The keyboard as well as the computer mouse are still reliable input devices and are still efficient for certain fields of application. However, in a lot of different situations we have the desire to make *handwritten* notes, sketches or drawings directly on the computer. The users can use the computer mouse or a track pad to make drawings directly on the computer and therefore solve the problem rudimentarily. However, the usage of these input devices to make handwritten notes or sketchesis not very intuitive.



While observing scenarios of collaborative work, one can recognize that handwritten notes or sketches are used very often in the context of meetings or conferences. Thereby traditional black boards, paper notebooks or regular white boards are usual tools. A reason for using these traditional tools is given through their reliability. Users can trust on the traditional pen and paper techniques. The possibility of losing data by working with pen and paper is considerably less than using computer systems. Additionally, users are used to traditional pen and paper and therefore they do not need to get used to new digital computer technology.

Today, however, most companies' data is required digitally. Specific sketches or reports for example have to be sent to employees who are based in other countries or cities. Applying the traditional pen and paper techniques, we need to digitalize for instance the results of a meeting. This process is not efficient and is thus time-consuming for the employees. Another situation where analogue sketches are problematic and not efficient is the context of architectural meetings. Architects usually have a few ground plans they discuss during a meeting. The plans are mostly printed on paper. The additional sketches are made by the participants on transparent paper which the architects lay over the plan. This transparent paper is used so the original ground plan is not modified. The changes on the ground plan, made during the meeting, have to be digitalized afterwards through a CAD (Computer Aided Design) software application. Through these examples we can see that transferring handwritten documents into digital form is undesired.

With the now existing digital pen technologies like tablet PCs we have the possibility to save handwritten data digitally on the tablet PC. Nevertheless, this technology cannot support collaborative work because participants are not able to work simultaneously on this computer system. On the other hand we can see the rising popularity of multi-touch systems[1]. Large multi-touch solutions like the Microsoft Surface [2] could support collaborative work through the possibility of using the table sized surface with other participants of the meeting simultaneously. With this solution the participants can sit or stand around the table and have a similar working desk like the traditional writing desk.

The usage of the multi-touch and Anoto technology combines the traditional world with digital fields. Paper-based interaction can be realized and therefore we can receive handwritten data on digital computer applications. But the technologies themselves are not enough to support collaborative work in the open industry. We need a *concept* that uses these technologies and couples the workflow of employees with the digital systems.

This paper deals with the facilitation of collaborative work. As an example to show the facilitation we focused on the architectural domain. We received requirements from architects according to our custom-made digital system that should be implemented to support collaborative work in the architectural domain. The list of requirements included that the system should make it possible for the user to change digital content dynamically. We also figured out through the requirements that the digital computer system should distinguish between the different users interacting with the software. Additionally, the users should have a private working area. The security of the digital system as well as the costs were also important requirements for the architects. Beyond that, we added the requirement to integrate mobile devices in our digital system.

Our aim is to support collaborative work through our *collaborative concept*. After giving an overview about the related research projects, we first introduce the current technologies that were used to realize our custom-made software. Through the approach to support collaborative



work with our software in the architectural context we want to show that the workflow in general business environments can be supported. We will present a solution that makes the used digital pen technology more accessible by other companies through porting the technology to the open source sector. In this way companies are not restricted to commercial software. Furthermore, our collaborative concept also contains a solution to integrate mobile devices into the workflow of a firm. Here we want to facilitate the dataflow between the employees. Finally we wanted to get feedback about our architectural prototype and collaborative concept supporting collaborative work. Hence we made an evaluation and asked experienced architectural professionals with additional project management knowledge about our system and concept. In summary, we combined three approaches in this paper to support collaborative work: (i) the prototype, (ii) using the Anoto technology in the open source environment and (iii) integrating mobile devices. Because of the technical focus of approach (ii) we do not include this approach in the evaluation. At the end of this paper we give a conclusion and outline our future work.

2. Related Work

Haller et al. [3] developed an interactive room to support collaborative work. The digital conference room used a digital whiteboard including multi-touch technology combining paper based interaction through the Anoto technology. Empirical results, which indicate that the use of this digital conference room supports collaborative work, are shown in that paper. Also the facts of the paper show that the system based on these technologies is intuitive to use. However, we can see that their solution is not focusing on a specific domain or the facilitation of collaborative work in the open industry.

Brandl et al. [4] illustrate the realization of combining the paper-based world with digital systems. They focus on interactive paper and resolve the issue to integrate real paper in digital environments. Their conclusion reflects that real paper is still needed and necessary for business environments.

Paper-based interaction is also examined by Liao et al. [5]. They describe how users can use real printouts as a proxy to change digital data. Staying with real paper, Yeh et al. [6] outline the use of interactive paper to combine handwritten notes and pictures to one document on computer systems. The project should support biologists in fieldwork.

Scott et al. [7] cover the usage of the Anoto and multi-touch technology to support collaborative work in military environments. By facilitating collaborative work they want to achieve faster decision-making and a faster workflow. Therefore they developed design requirements, which should be considered by developing multi-touch applications for military contexts. By presenting a custom-made software prototype to military personnel, the authors received positive feedback.

3. Tabletops

Multi-touch tabletops have like the current smartphones a touch surface for multiple finger inputs. Most tabletops have the advantage that they provide a large surface. So they are predestined to support collaborative work with many people. One of the first tabletops was the



Diamond Touch. The speciality of the Diamond Touch was its ability to identify the user explicitly [8]. Further optical techniques are developed to offer even more possibilities of interaction. Now there are a lot of techniques to realize optical multi-touch tabletops. All these techniques use infrared light to detect fingerprints. In or around the table are several infrared-strips to illuminate the surface. When an object or finger touches the surface it reflects at this point more than the surface reflection. An infrared camera is then able to detect these points. In the table also a computer is installed to interpret these data with software. The different technologies provide various possibilities. Jefferson Y. Han is one of the main developers of the optical multi-touch tabletops and he developed the FTIR-technique [9]. The FTIR-technique (Frustrated Total Internal Reflection) allows using optical tabletops stable on daylight. These innovative optical techniques are tangibles [10]. Tangibles are objects that can be placed on the tabletop. They are badges that are pasted under an object. The camera is able to see these badges and identify the tangibles. To use tangibles, it is necessary to work with the DI (Diffused Illumination) or DSI-technique (Diffused Surface Illumination). The Microsoft surface used these technologies for instance. A multi-touch table is able to recognize various tangibles, the position and the orientation of a tangible. Tangibles enable a deeper and more intuitive usage of touchscreens because of the additional user input and the explicit identification of tangibles.

4. The Anoto Technology

The Swedish company *Anoto* developed a technology for tracking positions of digital pens on a specific pattern [11, 12]. This technology realizes the interaction between real paper and digital realms.

Fundament of the technology is a dot-pattern which has to be printed on the interaction surface.

The pattern consists of black carbon dots. Apart from the required dot pattern, a digital Anoto pen is necessary for the interaction with a digital computer system. An infrared camera and an infrared LED are installed in the pen's tip.

While the user writes with the pen on the patterned surface, the infrared LED is being activated.

The patterned surface reflects the light while the black carbon dots on the surface absorb the IR-light. Consequently the IR camera detects the surface as a very bright background and the dots are seen dark by the camera at the same time. A combination of different points detected on the pattern makes it possible for the Anoto pen to recognize its unique position on the surface. This information can be sent via Bluetooth or USB docking station to a computer system. By using the Bluetooth technology, the streaming of the pens data to the computer is possible in real time.

To realize an interaction between real *paper* and a computer system, the dot pattern has to be printed on the paper. Additionally, the digital pens can be used for instance on a multi-touch surface with an overlaid Anoto pattern.

The information received by the digital computer system, such as a multi-touch table, can reconstruct the written information or work with the pens' coordinates. This can be useful for example to realize pressing digital buttons on the digital surface.



5. An Approach to Support Collaborative Work

Sharing and distributing information is in the process of planning in project management a highly significant aspect. Using the previously mentioned technologies to facilitate the workflow in working groups with the goal to support collaborative work is shown for instance in architectural projects.

Therefore we developed a software prototype for the context of architecture. Architects can work together on one ground plan which is projected on a multi-touch table. The users are able to interact on the interactive surface in any angle. The participants can also work simultaneously through an independent work area for each person. Therefore this area containing information is managed in a window that can easily be moved by the person's finger-input.

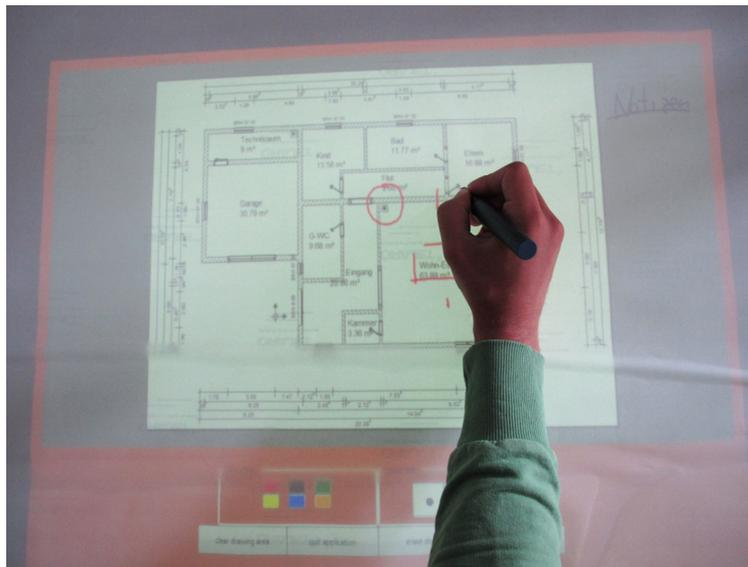

Figure 1. The software prototype

Additionally, using digital Anoto pens for each person facilitates drawing on the projected ground plan with various toolkits like stroke sizes and colors. The Anoto-technology also allows digital pens to be used on traditional paper with a regular pen tip. Thus, the participants are able to send drawings taken during the meeting from real paper to the multi-touch table for presentation purposes [4]. Furthermore, the architects are able to store the plan with the additional drawings digitally. In this way it is possible to duplicate the information and to send them to all participants of the meeting or workshop. The results of the architectural meeting can be presented later on a wall through a projector. After discussions about the ground plan it is possible to return to old versions of the plan's digital history. The next iteration step of the management for the refinement is optimized by that technology.

In the process of planning or during discussions it is often necessary that the system can distinguish between the users. It is useful to give for instance more permission for the system and more access for the software functions to a project manager than to regular participants. In



this way the project manager could be able to change a specific content on the system to a persistent status whereas the other users do not have any permission to change the data. Beyond that, it might be helpful to know who added which information and most specifically, at which time. The so-called *logging of users* makes it possible to assign the information to the specific participant. To resolve these issues, we used the unique Anoto identity number, which is being sent from the Anoto-pen to the computer system via Bluetooth. In this way the system records which user interacts with the interface. To make this system more secure for more critical context with extremely sensitive data, we implemented a multi-authorization. This indicates that each person has to be authenticated by a password or more desirable by biometric scans.

Figure 1 depicts the custom-made software prototype, running on a FTIR multi-touch table, and a user interacting with an Anoto pen. The software is written in the object orientated programming language C# and uses the Microsoft WPF Framework for realizing the Graphical User Interface. To receive the pen data in real time at the .NET application we used the custom-made *application-programming interface (API)* developed by Haller et al. [13].

6. Using the Anoto Technology in the Open Source Environment

To support collaborative work globally, it is necessary to address a wide range of companies and different firms in the open industry. Besides, there exist various companies in different sizes. However, a lot of small business companies cannot always invest in expensive software solutions. Additionally, the previous software prototype, using the external pen-based API for Windows 7, is restricted to Microsoft technology. Thus the developer can only choose between commercial Microsoft .NET development environments and multi-touch technology that can only be used on Windows operating systems.

To ensure platform independency and reusability of the *entire* software running on multi-touch tables, we decided to use the Java technology. Here we face the previously mentioned problems.

Java is a programming language and is part of the Java technology. Furthermore, this technology is not a commercial solution. Software applications written in Java run with the corresponding Java platform on every computer platform [14]. With the use of Java we achieve the platform independence of the multi-touch software by default, but without the ability to use functions of the pen-based Anoto technology. Hence we developed a Java Application Programming Interface that makes the Anoto technology accessible from the Java environment. Finally, we achieved reusability and platform independency of the Anoto technology.

Using this destination platform as the environment for our multi-touch application, which should support collaborative work, we obtained positive results. First, companies can use the combination of multi-touch and Anoto pens with all existing operating systems. They do not need to exchange their computer operating systems. Furthermore, there is a much bigger assortment of prefabricated multi-touch frameworks for the Java platform that allow the use of that technology in custom-made Java applications. The developers can write Java applications for the multi-touch table more ergonomically because of having more options in programming the graphical user interface. We also found out that through our solution the pen data received from the digital pens was handled faster than our previous software running on Windows OS and based on the external API. Haller et al. [3] outline that the pen data is received by the Windows application in real time and takes 50 milliseconds to process. Their facts are based on



empirical results and tests. By using the Anoto technology in an open source context, we finally do not face the problem that companies cannot afford the pen-based tabletop solution that needed the commercial .NET development studio. In this manner we provide an affordable access to the technology to facilitate the workflow of a company and thereby support collaborative work.

7. Integrating Mobile Devices

In the field of businesses, the use of mobile devices was always significant, essential and it supported various business processes [15]. Today we can see the rising popularity of mobile phones or tablet computers [16].

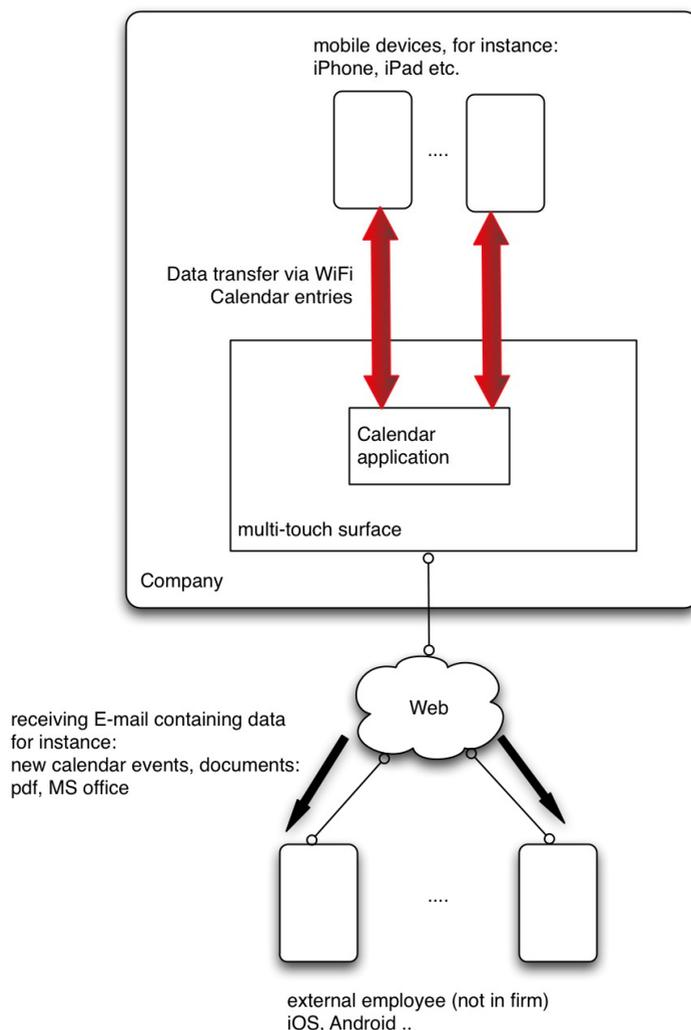

Figure 2. Synchronizing data on mobile devices



Especially in an era when international business is ubiquitous, improving the dataflow between employees of a company is inevitable. Supporting these aspects, coupled with the previous introduced technological concepts, we developed an interface to synchronize the data of mobile devices with a software application of the multi-touch table. Thus we decided to integrate mobile devices to our concept. Figure 2 depicts an overview of the synchronization of data.

The participants can lay down their mobile phone on the multi-touch surface. Data, for instance calendar entries, is then being transferred through WiFi technology to the multi-touch table or from the table to the mobile phones. The system of the multi-touch table can distinguish between the different devices and therefore assign the devices and data to a specific person. The project manager can for example set up a timetable for a week by interacting with the software of the multi-touch table. When the meeting is coming to an end, the participants of the meeting lay down their mobile phones to synchronize their calendar with the current business timetable on the digital table. Since a company can also have external employees in other countries or cities, not everyone can participate in every meeting. For this reason the software running on the multi-touch table can send data via the Internet to mobile phones outside the companies' building. This data is not limited to calendar entries. Protocols of the meeting, contents in word, pdf or excel documents can additionally be send. This is realized by sending e-mails from the surface software to the various mobile phones.

The developed connection between the multi-touch table and the mobile phones is only applicable with the Apple iPhone so far.

8. Evaluation of the Approaches

After the development of the so far introduced approaches to support collaborative work, we want to assess if our concept would be accepted by professionals in the industry, who have experience in the architectural environment and preferably in the context of project management. Moreover we wanted to receive the opinion of these professionals to identify our weak spots and the positive aspects of our system that could facilitate the workflow in architectural offices.

Therefore we presented our concept to architectural professionals who are experienced in the field of construction management. The participants work in two different architectural offices in the same city. We had thirteen female (59%) and nine male (41%) participants. They were in the age between 28 to 39 and 52 to 58. 27% of the participants indicated that they spend five to eight hours a day working on the computer. Besides, 41% of the participants spend eight to ten hours a day working on computer systems, and 32% indicated that they use computers over ten hours a day. None of the participants had prior experience with Anoto pens.

The presentation of our concept took place at the architectural offices where the participants work. After the presentation, a discussion started through the interest and questions of the architects. To our satisfaction, the audience was interested in more details about the Anoto technology. We then handed out the questionnaire to the participants.



Table 1

Results of the questionnaire regarding to the introduced collaborative concept

Questions to architectural professionals	Yes	No
Is in your opinion the usage of the technology in the architectural /project management context efficient?	16(73%)	6 (27%)
Do you think that the introduced collaborative concept could support the workflow in your firm?	14(64%)	8(36%)
Would you use the introduced system if available?	12(55%)	10(45%)
In your opinion, could the paper-based interaction be a relief in the architectural context for meetings?	19(86%)	3(14%)
In your opinion, could collaborative work of colleagues be supported by the introduced concept?	15(68%)	7(32%)
Do you think that the concept could be efficient for architects in field work (i.e. customer/construction site)?	21(95%)	1(5%)
Would you trust the system regarding the data security and data protection?	3(14%)	19(86%)
Would it be a relief for you to receive the important data of the meeting like protocols and calendar entries with your mobile device if you cannot participate in a meeting?	7(32%)	15(68%)

First we asked the participants about their experience at work and their background in the office. The results show that 77% of the architects have zero to two meetings a week while 14% have two to five meetings a week. Only 9% stated to have five to eight meetings a week. Furthermore, the average duration of the meeting in minutes was asked in the questionnaire. We figured out that the majority (55%) participates on meetings with a duration of 30 to 60 minutes. 27% of the architects indicated that a meeting lasts one to two hours in their office. Only 18% of the participants agreed that a meeting lasts not more than 15 to 30 minutes in average. We also asked them if they worked in projects together with different departments of the office. The result was that all persons work together in projects and also with employees from other departments of the same office.

Further down in the questionnaire we asked the participants about the previously introduced technology and concept that should facilitate collaborative work in the architectural and project management domain. Table 1 depicts the results. The goal of these questions was to obtain feedback from professionals about the contribution of our concept. It was important for us to know if this system can be used in the industry and how the experienced participants rate the solution. Overall we received a positive feedback. Regarding the efficiency and the support of the work flow of the system, the majority was optimistic. Nevertheless, as we can see in Table 1, 36% of the participants think that the collaborative concept will not support the workflow in their firm. The difficulty of coupling the system with their office and the missing experience with that system



could be a reason for these negative opinions. Accordingly, only 55% of the architects would like to use the introduced digital system at work right now. Through further comments from the participants we figured out that the costs of the system would be too expensive for the offices without any experience of that technology in the open industry. However, the majority of the participants (86%) think that the paper-based interaction is a relief in architectural meetings. We assume that digitalizing technical sketches in real time during meetings is very efficient for architects and engineers. The usage of the prototype also makes it much easier to distribute and share the sketches. The fact that all participants prefer traditional paper to a computer device supports the thesis of a demand of digitalizing handwritten content. It was very positive that 68% of the architects indicated that the introduced collaborative concept could support collaborative work. Because of this result we assume that our prototype can be a support for collaborative work in architectural contexts. The efficiency in fieldwork was also rated very positively. We wanted to know if architects like the idea of using the Anoto pen on the construction site and at their customer's offices to send the written data on the Anoto pen with a smartphone to a server of the office. Then, arriving at the office, the architect can open the digital sketches. But through further feedback from the test population it became clear that this function would not be efficient on the construction site. Sending the data from a customer would be more efficient. Only 14% of the participants would trust the digital system regarding the data security and data protection. We hypothesize that this is not a problem concerning our prototype and concept. We assume that this mistrust exists because of the negative experience the users have with regular desktop computers. Finally, 68% of the architects do not think that receiving documents from a meeting on their mobile device is helpful. The test population argued that they do not need such data on a mobile device, because the duration of being outside the office is not very high. They have access to a desktop computer most of the time.

In summary, we can see positive results. The requirements we received from the architects before writing this paper found an echo. However, mobile devices do not have success in the architectural environment. Although we have security mechanisms, there is mistrust concerning the digital system.

In regard to the support of collaborative work in architectural environments through our prototype and our additional approaches the audience was optimistic. Additionally, we had the advantage of working with participants who also had experience in project management through their position at the office. This was important because this test population could judge the improvements of the workflow better than people without any knowledge of project management.

In general, the participants liked the idea of combining the multi-touch and Anoto technology. A major concern was the possible costs. Almost everyone had the opinion that this concept is too expensive especially for smaller offices or companies because of the expensive Anoto paper and the needed hardware.

9. Conclusion & Future Work

On the one hand, using traditional pen and paper is preferred in meetings and conferences to take notes or make professional sketches. On the other hand, new technical possibilities are very interesting in this context, but not intuitively usable at this time. Additionally we see the rising popularity of multi-touch systems. The multi-touch and Anoto technology link the paper-



Project Management Development – Practice and Perspectives

First International Scientific Conference on Project Management in the Baltic Countries

February 8-9, 2012, Riga, University of Latvia

based interaction with a computer system, but we do not have any current experiences about how to integrate these technologies in the open industry.

Therefore we decided to elaborate a concept and to evaluate it based on our dedicated prototype.

We presented our software prototype that should support collaborative work in the architectural domain and thus focused on scenarios in the work of an architect. In contrast to most related works, we did not have the aim to support collaborative work just by developing user-friendly computer interfaces. We elaborated our concept from the viewpoint of the companies and thus figured out that costs are a major concern regarding technical products. The results of the evaluation show that the participants do not trust the system regarding the security of data. Additionally we see that the test population does not accept the extended use of mobile devices broadly.

We developed an Application Programming Interface (API) to get access to the digital pen technology through non-commercial software. Thus, the companies do not need to invest a lot of money through software solutions and have the possibility to get a better workflow in the business domain by using the paper-based Anoto technology in combination with multi-touch solutions.

In order to integrate mobile devices we developed another interface. Through the possibility of synchronizing data from a mobile device with the multi-touch table, we facilitate the dataflow between employees in meetings and conferences. Additionally, our solution makes it possible to send meeting data to participants who were not being able to participate in the meeting or conference. The negative opinions of the test population regarding the integration of mobile devices show that this scenario is not necessarily important for the architectural domain.

Our evaluation shows that architectural professionals with additional knowledge in project management agree that our concept can support collaborative work in the open industry. Thus, the collaborative concept makes clear how collaborative work can be supported in companies, especially in the architectural environment.

The evaluation of our concept shows clear results for the architectural environment. However, we need to test the prototype in different offices and domains. The system has to be used in the typical work environment on a regular basis to identify its strength and weakness. A detailed analysis is therefore required in the future. Furthermore, we would like to extend the software prototype. The integration of CAD software within the prototype could be efficient for architectural professionals. Integrating digital white boards and coupling those with the multi-touch table and traditional paper will also be a new milestone for the future. Integrating the possibility of projecting holograms from the multi-touch table could also be an advantage for participants of a meeting to understand complex 3D models. Extending our research field to the hologram technology is planned in the future.

References

1. Schöning, Johannes; Krüger, Antonio; Olivier, Patrick: *Multi-touch is Dead, Long live Multi-touch*, ACM Press, Boston, MA, USA April 2009.
2. Wall, Josh; *Demo I Microsoft Surface and the Single View Platform*, CTS '09 Proceedings of the 2009 International Symposium on Collaborative Technologies and Systems, IEEE Computer Society Washington, DC, USA 2009.



Project Management Development – Practice and Perspectives

First International Scientific Conference on Project Management in the Baltic Countries
February 8-9, 2012, Riga, University of Latvia

3. Haller, M; Leitner, J; Seifried, T; Wallace, J; Scott, S; Richter, C; Brandl, P; Gokcezade, A: *The NiCE Discussion Room: Integrating Paper and Digital Media to Support Co-Located Group Meetings*, CHI 10: Proceedings of the 28th international conference on Human factors in computing systems, New York 2010, pp. 609-618.
4. Brandl, P.; Haller, M.; Oberngruber, J.; Schafleitner, C.: *Bridging the gap between real printouts and digital whiteboard*, AVI 08: Proceedings of the working conference on Advanced Visual Interfaces, New York 2008, pp. 31-38.
5. Liao, Chunyuan; Guimbreti'ere, Francois; Hinckley, Ken: *PapierCraft: A Command System for Interactive Paper*, ACM, Washington 2005.
6. Yeh, Ron; Liao, Chunyuan; Klemmer, Scott; Guimbreti'ere, Francois; Lee, Brian; Kakaradov, Boyko; Stamberger, Jeannie; Paepcke, Andreas: *ButterflyNet: A Mobile Capture and Access System for Field Biology Research*, Proceedings of CHI'06, ACM, Montreal 2006.
7. Scott, S.D.; Allavena, A.; Cerar, K.; Franck, G.; Hazen, M.; Shuter, T.; Colliver, C: Investigating Tabletop Interfaces to Support Collaborative Decision-Making in Maritime Operations. *Proceedings of ICCRTS 2010: International Command and Control Research and Technology Symposium*, Santa Monica, CA, USA, June 22-24, 2010.
8. Deitz, P.; Leigh, D.: *DiamondTouch: A Multi-User Touch Technology*. Paper presented at the Proceedings of UIST'00: ACM Symposium on User Interface Software and Technology, San Diego, 2000, CA.
9. Jefferson Y. Han: *Low-cost multi-touch sensing through frustrated total internal reflection*. In UIST '05: Proceedings of the 18th annual ACM symposium on User interface software and technology, New York, NY, USA, 2005, pp. 115-118.
10. Bencina, R.; Kaltenbrunner, M.; Jordà, S.: *Improved Topological Fiducial Tracking in the reacTIVision System*, Proceedings of the IEEE International Workshop on Projector-Camera Systems (Procams 2005), San Diego, USA.
11. Anoto (Publisher): Development Guide for Services enabled by Anoto Functionality, 2010.
12. Anoto (Publisher): Development Guide for Digital Paper Applications, 2001.
13. Media Interaction Lab: Interactive Whiteboard Development Kit – The PointDeviceService Library, API Specification 2011.
14. Sabharwal, C.L.: *Java, Java, Java*, Potentials, IEEE, Vol. 17, Iss. 3, Aug.-Sept. 1998, pp. 33-37.
15. Siau, Keng; Shen, Zixing: *Mobile Communications and Mobile Services*, International Journal of Mobile Communications, Issue Volume 1, Numbers 1-2, July 2003, pp. 3-14.
16. Lacroix, Jean-Pierre: *Hello, are you there?: Marketing in a smartphone world*, white paper, ShikataniLacroix, June 2011.

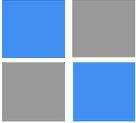

EXPERIENCES OF THE UTILIZATION OF EU FUNDS IN HUNGARY¹

Professor, Dr. György Kocziszky, CsC

Dean of Faculty of Economics

Institute of World and Regional Economics

University of Miskolc

E-mail: regkagye@uni-miskolc.hu

Keywords: regional policy, regional growth, regional equilibrium, regional sustainability

JEL-code: O11, R11

Abstract

The geopolitical change of direction taking place after 1989 induced a number of positive and negative social and economic changes in Hungary (as in the other post-socialist countries). Among the latter changes perhaps the most depressive one is that in the past two decades economic policy has not been able to achieve a sustainable and balanced economic growth either in the short or in the long term, or to manage the problems arising from its lack. The external and internal imbalance (at macro and mezzo levels) arising in this way is continuously generating serious tensions.

The paper wishes to find an answer to the question what role regional policy can play in creating local and regional economic equilibrium and in starting a relative convergence.

Introduction

The economic policy of Hungary of the past decades can be described by a number of controversies. Little wonder that the final outcome is mixed: in accordance with the ill-advised and whimsical improvisations (matching the election cycles) and, on the other hand, with the business cycles taking place in the world economy, the rate of Hungary's macroeconomic growth and the deviance from the equilibrium path keep changing cyclically from smaller to bigger; the sign and size of the domestic output margin keep changing cyclically while the exposure of macro- and mezzo-level outputs to external disturbances has also increased.

Causes and Results of the Depression

Lasting economic convergence is a function of three factors: growth rate, the sustainability of the growth rate and economic equilibrium (Figure 1).

¹ "This research was carried out as part of the TAMOP-4.2.1.B-10/2/KONV-2010-0001 project with support by the European Union, co-financed by the European Social Fund."

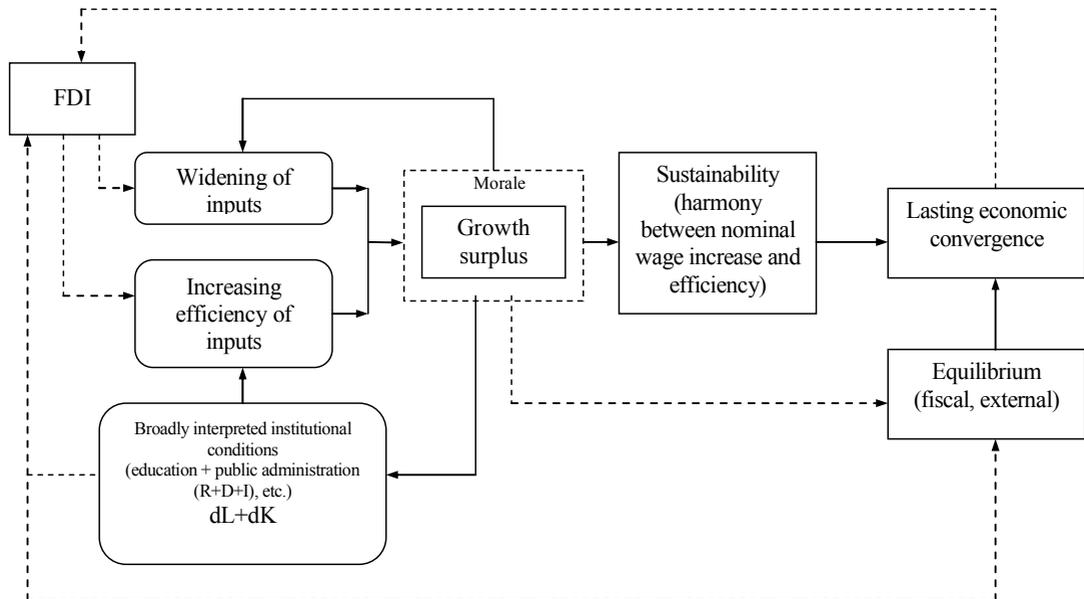
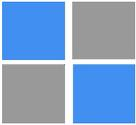

Figure 1. System of conditions of lasting convergence

Source: author's own work

Those shaping the Hungarian economic policy have disregarded this axiom since the 1970s.

The debt spiral of Hungary began at the same time as the oil price explosion of 1974. The continuous deterioration of our terms of trade and the increase in the imports price level (20% annually on average) were compensated by the government by means of continuous borrowing.

Our imbalance kept strengthening between 1985 and 1989 (while our net outstanding total debt increased from 6.5 billion USD to 14.9 billion USD, and gross outstanding total debt increased from 11 billion USD to 20.4 billion USD).

On the basis of the foregoing it can be understood that the domestic economy came to a state close to depression several times in the past decades.

The slow stabilisation of the past years has been halted by the economic policy deployed after 2002, and the outstanding total debt of Hungary began to increase again. Our position was further damaged by the financial crisis of 2008. The internal causes of our present situation close to depression can be attributed to the following (with some simplification).

a) Growth deficit, excessive desindustrialisation

The Hungarian economy has been struggling for more than three decades with the problem that the added value of our products and services is small. Since the beginning of the 1980s this has set back employment and the output growth rate in Hungary (Figure 2).

The decline of the processing industry has played a significant role in this in the past two decades. The service sector in Hungary has been unable to replace or outdo the employment or the production value of the industrial companies being closed down.

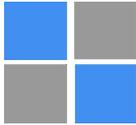

Project Management Development – Practice and Perspectives

First International Scientific Conference on Project Management in the Baltic Countries

February 8-9, 2012, Riga, University of Latvia

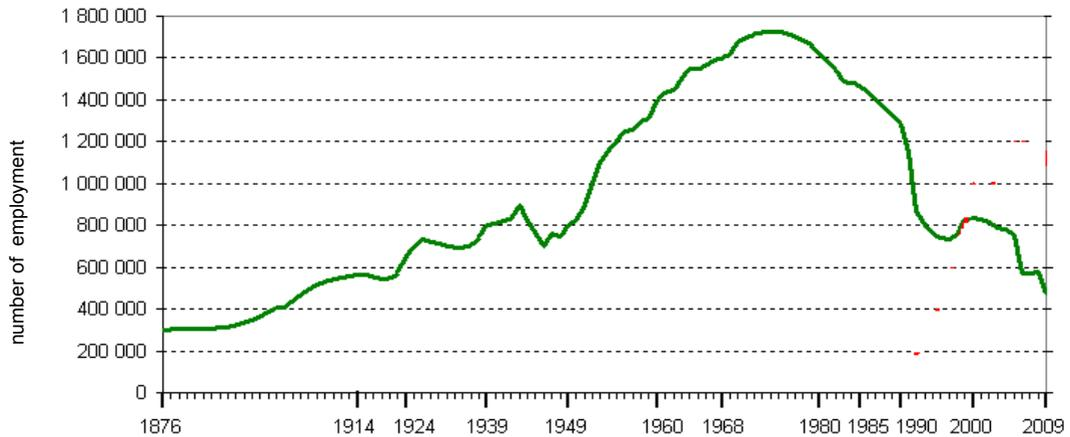

Figure 2. Development of the number of those employed in the Hungarian industry (1876-2009)

Source: author's own work

b) Lack of equilibrium

Thus (as shown by the above) the lack of equilibrium in the economy of Hungary is not a new phenomenon. The professional authors dealing with economic policy are debating at most the date of the acceleration of the process.

A lasting lack of equilibrium can be retraced, with some simplification, basically to three causes which are in close interaction with each other: the decreasing competitiveness and exportability of our products, the increase in consumption that has become disconnected from the economic growth rate and the unfavourable changes in exchange rates. The lack of imbalance (in the budget and in the balance of foreign trade) thus arising has resulted in twin deficits.

c) Lack of sustainability

The growth path of the Hungarian economy has been hindered in addition to the errors in the economic policy of the past years by the increasing obligations in payments in interest.

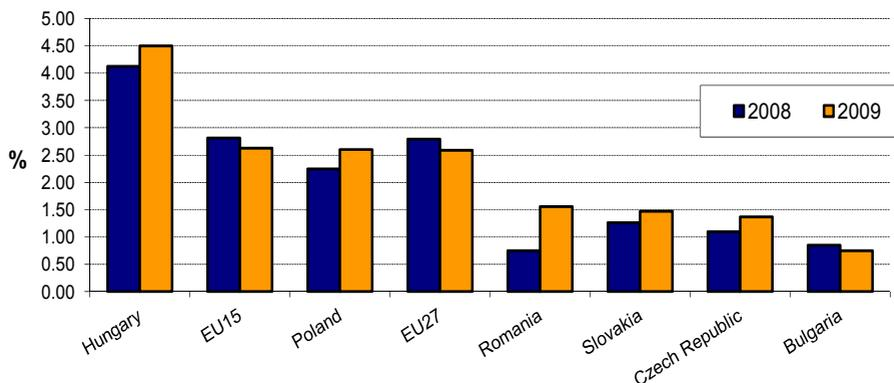

Figure 3. Interest expenditure as percentage of GDP 2008-2009

Source: EU Commission – AMECO



The high state deficit incurs large redemption burdens, which narrows the range of possibilities for action of the budget (Figure 3). Part of the close to 1100 billion HUF, which is at present used to pay interest, could be spent on productive investments and other productive expenditure (health care, public education, etc.), and while leaving the expenditure unchanged, tax burdens could be considerably reduced (7.5 times as much could be spent on housing support as in 2010, or more than twice as much could be spent on family support as in 2010, or the value added tax burden could be reduced by nearly half, or one third of the interest expenditure could be sufficient to eliminate company tax completely, or personal income tax could be reduced by more than 40%, or the social security contributions of employers and employees could be reduced by more than one third, thus reducing the tax wedge further and stimulating the labour market).

d) Moral affliction

The recognition that sustainable economic growth can hardly be set in motion without stable moral foundations is not a new phenomenon. The problem is not typical to Hungary, but the social and economic consequences of the deterioration of the general conditions are serious in Hungary as well.^{2/}

The above deficiencies result in problems at the levels of both the national economy and of regions (Figure 4).

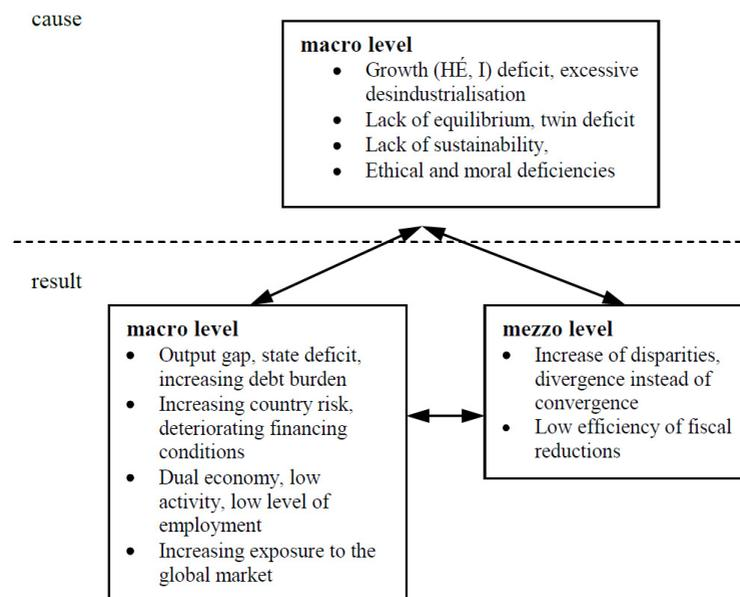
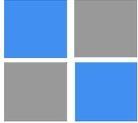

Figure 4. Macro- and sub-national results of depression

Source: author's own work

² In Europe more than one third of the workers of large companies asked were willing to offer cash or other presents for clinching a deal, one quarter do not trust the ethical behaviour of the company management. Hungary is the second after Russia on grounds of the occurrence of malpractice. In the framework of the survey conducted in 25 countries in Europe, more than 2300 employees were asked from workers to top executives (For the complete survey, see <http://www.ey.com/HU/FIDS>.)



Results of the Depression

In the following, regional (mezzo-level) problems will be discussed, as flowing from our topic.

a) Increase in disparities, divergence instead of convergence

The transition to the market economy (1989) found the Hungarian society and economy in regionally differing situations. The real and latent regional differences are not new. In the early and mid 1980s, with the deterioration of the competitiveness of the industry, mono-structural regions came into difficult positions (a good 20 years after the processes appearing in Western Europe due to similar causes).

As is well-known, though the party and political management of the times was aware of the problems, it took no steps concerning the merits of the situation (measures taken for the sake of keeping up appearances were born instead).

The change of economic and geopolitical direction increased the regional differences further, for the counties took advantage of the opportunities arising from the changes in room for action in different ways (due to external and internal causes).

Table 1

Gross domestic product (million HUF)

Year	Hungary	Regions						
		Central Hungary	Central Dunántúl	Western Dunántúl	Southern Dunántúl	Northern Hungary	Northern Alföld	Southern Alföld
1995	5746248	2308185	568269	580095	464657	533365	631593	660084
1996	7113667	2921656	710224	729160	558437	625806	771320	797064
1997	8814578	3672887	924147	908175	672553	755408	938459	942949
1998	10453044	4337164	1121369	1127137	786839	900063	1089406	1091066
1999	11640204	4914707	1205769	1315062	888122	978850	1152614	1185080
2000	13368903	5749466	1409831	1486596	984178	1096006	1318453	1324373
2001	15307183	6753595	1580835	1578964	1110079	1258985	1559864	1464861
2002	17231288	7842653	1665076	1752481	1230432	1394712	1717465	1628469
2003	18838254	8371940	1909057	2008898	1330164	1543478	1915188	1759529
2004	20822396	9332337	2166169	2142326	1433297	1732352	2074520	1941395
2005	21970780	10149328	2264769	2157842	1468924	1809434	2125955	1994528
2006	23730035	11238468	2349996	2352278	1538333	1886009	2268181	2096770
2007	25321478	12066320	2565394	2451606	1648809	1989681	2389327	2210341
2008	26753906	12879358	2647830	2588827	1746031	2020802	2499135	2371923
2009	26054326	12915040	2457169	2409882	1693787	1907020	2402846	2268582

Source: KSH

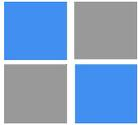

The investment and employment dynamics of the regions developed also depending on the sectoral structure of the regions (existence or lack of the driving sectors). Long-term low investment was matched by long-term low employment (although after 2009 the regional distribution of the unemployment rate decreased somewhat, it was thanks much more to higher public employment in the backward regions than to an improvement in the labour market situation (Figure 5).

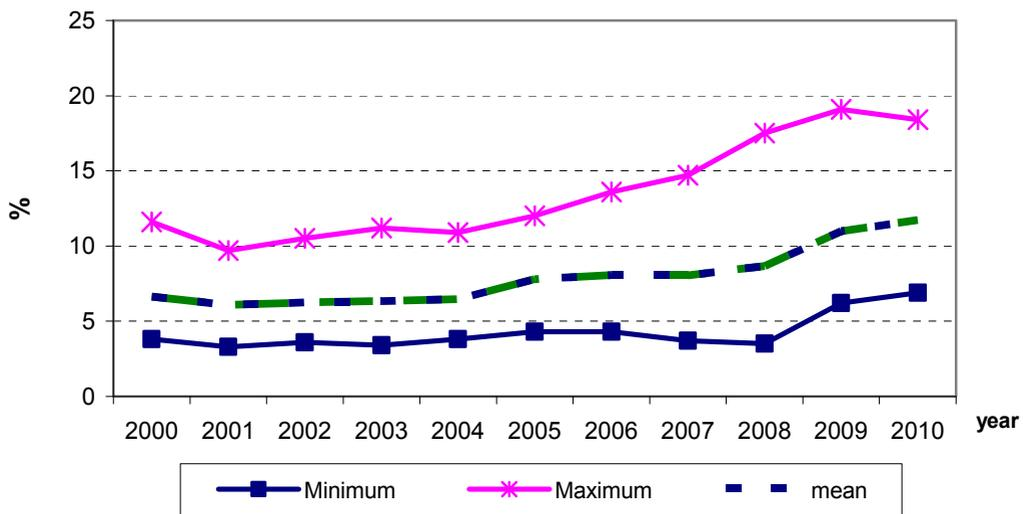

Figure 5. Distribution by county of the unemployment rate in Hungary

Source: author's own work

As a result in the labour market of the transformation starting after 1990, the West-East direction unemployment slope emerged in Hungary; and a more than tenfold difference came into existence between the regions with lower and with higher unemployment rates.^{3/}

The different output paths of the regions can be explained by the different personal consumption and investment as well as by the external demand.

Our empirical investigations show that the volatility of regional output has been higher than the volatility of the output gap of the Hungarian macro-economy in the past years (Table 2).

³ The number of those employed in January 2011 – in the age group 15-74 – was 3 million 743 thousand, which exceeded the figure for the previous year by 0.5% (KSH, 2011).

The number of unemployed aged 15-74 was 487 thousand, 8 thousand more than a year previously. The unemployment rate of 11.5% was basically identical to that of the previous year (male unemployment rate of 12.0%, and female unemployment rate of 10.9%).

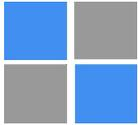

Table 2

Annual changes in output gap ^{4/} (%)

Year	Hungary	Regions						
		Central Hungary	Central Dunántúl	Western Dunántúl	Southern Dunántúl	Northern Hungary	Northern Alföld	Southern Alföld
1995	-0.08	15.67	-9.57	-15.26	-8.60	-4.48	-5.58	-6.61
1996	-3.09	3.97	-9.17	-12.20	-7.38	-7.04	-4.78	-4.19
1997	-1.29	1.34	-1.21	-6.99	-3.58	-4.14	-1.34	-1.47
1998	-0.63	-2.29	2.98	0.43	-0.66	-0.31	-0.27	0.83
1999	-3.87	-6.45	-2.96	3.69	0.17	-3.82	-6.56	-1.83
2000	-2.41	-5.25	0.99	5.12	0.31	-3.22	-4.09	-0.59
2001	0.12	-1.87	2.02	1.21	3.19	0.94	2.91	0.51
2002	2.09	1.89	-2.23	2.73	5.14	2.39	3.65	2.91
2003	2.01	-1.64	2.83	8.48	5.16	4.50	6.51	3.04
2004	3.82	0.07	7.76	7.24	5.43	8.83	6.97	5.93
2005	1.50	0.09	4.67	0.66	1.03	6.03	2.19	1.88
2006	2.13	2.59	1.42	2.74	-0.66	3.55	2.10	0.67
2007	2.00	2.52	3.83	0.66	0.35	2.76	1.13	0.11
2008	1.28	2.35	0.90	0.29	0.48	-1.48	-0.19	1.67
2009	-6.96	-3.61	-11.54	-11.64	-7.56	-11.95	-9.16	-7.71

Source: author’s own calculations based on KSH data

Net exports are primarily responsible for the short-term fluctuation in output (Figure 6).

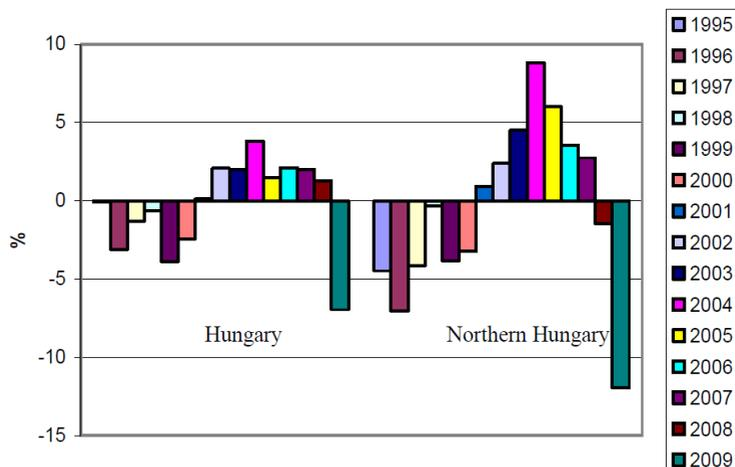
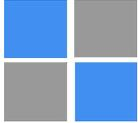

Figure 6. Output gap path

Source: author’s own work based on KSH data

^{4/} The literature offers several definitions for output gap; e.g.: P. Kiss/Vadas (2005). Our data use the results of calculations based on the actual and potential GDP ($GDP_{pot} - G_{tényl4}] / GDP_{tényl}] \times 100$).



This means that the government measures limiting or expanding consumption have a smaller effect influencing the incomes of the population than the effect of monetary policy affecting net exports (assuming unchanged demand). And changes in net exports depend on the economic structure of the given region (to a considerable extent on the cyclical positions of the multinational companies established in the region).

b) Low efficiency of fiscal moves

The EU funding appearing in the Hungarian budget (1999: 3.3 billion HUF; 2010: 706.8 billion HUF, data at current price) and expenditure (1999: 14.9 billion HUF; 2010: 804.8 billion HUF, data at current price) increased dynamically between 1999 and 2010. Although the time period is relatively short (therefore it is hardly possible to draw considerable consequences), it can be clearly seen that the impact of the support arriving in Hungary on increasing the GDP lags behind that of the EU average (Table 3).^{5/}

⁵ Under the I. National Development Plan in 2004-06 Hungary had close to 700 billion HUF at its disposal including national co-financing from the structural funds of the European Union, and the funds provided for the realisation of about 20 thousand projects in Hungary.

Hungary was able to use almost all – 99% – of the said EU funding in the period examined, however, the results is worsened by the fact that the beneficial financial performance incurred excess expenditure from the Hungarian budget of approximately 35 billion HUF. Among the reasons the national Auditing Office highlighted deficiencies in the harmonisation of the major national economic objectives, changes in certain objectives and the fact that while the institutions providing the support concentrated on the as complete as possible use of the funds, they did not pay appropriate attention to their efficiency (due to non-performance of winning projects it was necessary to have reserve developments, which cost more for their rapid production; there were also examples where developments already began had to be funded completely from national means due to suspicions about mismanagement).

The convergence of Hungary to the EU average is not progressing as we would have liked it to: the per capita gross domestic product increased only one per cent between 2004 and 2009 as a result of EU funding. At regional level the picture is even more disillusioning: while the more developed region of Central Hungary developed considerably, the positions of the six convergence regions did not change significantly, what's more Northern Hungary, Northern and Southern Alföld, and Southern Dunántúl entered the group of the twenty poorest regions of the EU.

Examining the environmental, healthcare and certain education investments as well as regional development, it was found that we were coming closer to the EU development level, however, in the short term they did not result in economic growth. The situation was further complicated by the size of the funds and the compartmentalisation of their use, which resulted in the fact that we were only able to achieve partial results even in the realisation of the nicely sounding objectives. It can also be seen that while unemployment was soaring, in the development programs the effect of retaining jobs prevailed. In trainings promoting finding employment, approximately half of those completing the training and only 10% of the disadvantaged found jobs. (ÁSZ, 2011).

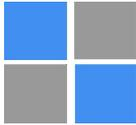

Table 3

Impact of support on increasing the GDP

Country	GDP/EU* support	Contribution to increasing the GDP (%)		
		1989-1993	1994-1999	2000-2006
Portugal**	~ 3%	3.9	4.6	6.1
Spain**	~ 1.5%	2.9	3.1	4.2
Greece**	~ 2.6%	4.3	5.6	6.1
Ireland**	~ 2.8%	n.d.	8.9	8.6
Hungary***	~ 2.1%	-	-	1.2

Notes: * AGENDA 2000 (max. 4%)

** The Role of Fiscal Transfers for Regional Economic Convergence in Europe (No. 1029.2009.)

*** between 2004-2006 (*Source*: author’s own calculations)

This has several causes, such as:

- ‘brainstorming’ in the course the allocation of funds;
- the majority of funding (60-65%) had the impact of increasing one-time demand or improving the community infrastructure and not of improving the economic potential, and within that there was a high rate of ‘soft’ projects. By contrast, the fundamental objective of the EU cohesion policy is to enable the regions with a low performance to converge. From this it follows that support is efficient when it generates additional output (compared to the situation without support);
- Empirical investigations and analyses prove also in this respect that there are considerable differences (besides positive examples low absorption efficiency is not rare);
- granting the funds took place on the grounds of political interests, significant portions were not used for investments supporting long-term convergence, and thus their impacts are also weak;
- funds are not additive, but have a substitution character. In the majority of cases they appeared not as additional funds but were substituted for former private or government investments (Kocziszky, 2010).

Our lagging and depressed regions were caught in a trap, for the efficiency of the fiscal moves of the past years (partly due to their soft nature and partly to their level being under the sensitivity threshold) was low, the injections of capital proved insufficient to generate real convergence (that would have required a much stronger fiscal impetus).^{6/}

Beyond the macro- and mezzo-economic conditions of the real and nominal convergence of the regions in Hungary, the past years were lacking in sectoral and local economic policy harmony as well as in the underlying moral background. Part of the programmes had a virtual impact and the supports were used for ‘political show schemes’.

^{6/} There are no significant changes in the leading pack or in the lower third of the human development index (compared to 2000). According to the figures for 2009, the positions of Budapest (0.8739) Győr-Moson-Sopron county (0.687) and Fejér county (0.669) are the same, while those of Nógrád county (0.600) and Szabolcs-Szatmár-Bereg county (0.587) deteriorated further somewhat.

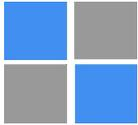

An economic policy using a variety of fiscal and monetary instruments exclusively is insufficient for the management of regional problems, for the various shocks affect the counties to different extents.

Desirable Directions of a Paradigm Change

The mainstream of economic policy has been obsessed with growth in the past three decades and this view was mostly adopted by the authors of studies on regional growth and convergence as well. Today, however, it is more and more recognised that economic growth (even in such export-driven economies as Hungary) can be primarily achieved by an increase in productivity and added value and not by obtaining an increasing share of the global markets.^{7/}

The makers of the Hungarian economic and regional policy are facing a task that is not slight: they have to reduce low employment and the lack in output arising from the deficit of added value simultaneously. This, however, requires a change of paradigm in regional policy.

Hungarian regional policy re-visited has to meet several requirements at the same time.

Condition 1: it has to be integrative, that is it has to arrange the elements of sectoral policies referring to regions in a multiplicative way along realistic objectives and funds; it has to meet top-down and bottom-up planning principles simultaneously.

Constructing regional policy is not independent of the objectives, instruments, resources of the sectoral and other cross-sectional policies (budgetary and monetary) or of the national economy-level allocation and re-allocation mechanisms.

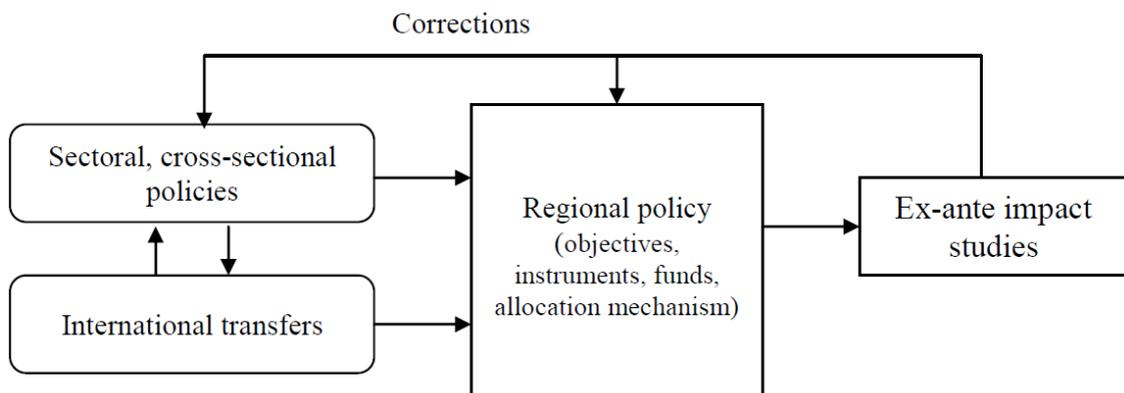
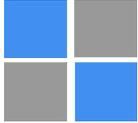

Figure 7. Logical process of constructing regional policy

Source: author's own work

⁷ Economic widening is determined by the fight for a share that can be obtained in the global markets of processed goods. Economies showing external surpluses are generally declared to be 'competitive', taking no account of the development of their economic growth or productivity. Trade balance is regarded as the major index of a country, as if it were only a company. In reality, however, the two have hardly anything to do with each other. Trade balance means simply the difference between investments and domestic savings, or in a more general sense, the difference between aggregate expenditure and total output.



Condition 2: sustainable and realistic regional growth objectives have to be set.

The objectives for a given region have to achieve improvements in economic growth and employment simultaneously.^{8/} That is why the empirical literature on convergence devotes more and more attention to conditional (relative) convergence (Barro, Sala-i-Martin, 1992; Romer, 1986), that is instead of ‘catching up’ it is increasingly the lasting growth rate that is determined by the own equilibrium path that comes to the foreground.

Creating the state of equilibrium at a lower level uses the empirical experience that in peripheral regions the likelihood of producing a high added value is lower due to the lower human potential index, therefore increasing employment should be put in the foreground. This can increase the income of the population even in the short term, and local consumption can be increased without raising inflation.

Condition 3: expected consequences of regional policy are to be supported by ex-ante impact studies; its system of indicators and its methodology have to be elaborated.

Acknowledgments

The paper/research work has been completed as part of the project TÁMOP-4.2.1.B10/2/KONV-2010-0001 – in the framework of the New Hungary Development Plan – with European Union support and co-financing by the European Social Fund.

References

1. ÁSZ (2011): *Jelentés a Nemzeti Fejlesztési Terv végrehajtásának ellenőrzéséről* (Report on the Inspection of the Completion of the National Development Plan). Állami Számvevőszék, Budapest.
2. Kocziszky György (2010): Mítosz és valóság: Forrásbevonások hatása a regionális konvergenciára. (Myth and Reality: Impact of FDI on Regional Convergence) *Észak-Magyarországi Stratégiai Füzetek*. VI. évf. 2. pp. 2-45.
3. P. Kiss Gábor – Vadas Gábor. (2005): Légy résen! Az államháztartási egyenleg ciklikus igazítása. (Be Alert! The Cyclic Management of the Balance of the Budget) *Közgazdasági Szemle*, LII. évf. febr. pp. 109-129.

⁸ This will probably be a prolonged process without the domestic industry (particularly the processing industry). It must not be forgotten that the high-tech (nano-, bio-, etc.) sectors produce high added value, have a low employment capacity and are located in highly concentrated areas even in the developed countries.



**THE EXPERIENCE OF IMPLEMENTATION OF THE
INNOVATIONAL TEACHING METHODS FOR ADULT
TRAINING WITHIN THE FRAMEWORK OF THE EUROPEAN
UNION PROJECT “THE VOCATIONAL EDUCATION
AND TRAINING”**

PhD. cnd. Irina Lando

Master of Social Science in Society Management

Master in Marketing

University of Latvia

Mob.: +371 2949151

E-mails: info@lando.lv, www.lando.lv

Keywords: project management, adult education, vocational education, innovative teaching methods

Abstract

In 2007-2008 the author accomplished a project aimed at development, testing and practical implementation of the fast and effective method of teaching, using the unconventional teaching methods to enhance the competitiveness of adults in the Republic of Latvia. The program was developed and implemented for adult people engaged in agriculture and forestry, to enable them to more quickly and easily integrate and adapt to the requirements of the European Community.

The main objective of the project was to help adults develop their skills and abilities in the shortest time, and to increase their level of professional proficiency, in accordance with the requirements of the labor market of the European Community.

The compulsory subjects, taught to the adult individuals within the project were the innovations in the education system, project management and marketing. The author believes that the experience gained during this training can be used for education of the adult individuals who for a long period of time had neither the opportunity nor experience in being trained.

It is the opinion of the author that there are fundamental differences between the learning processes of the adults and students living in Riga, where they are motivated to study and know what results they want to achieve during the training, and those of the adult individuals of the countryside who are involved in agriculture and forestry.

The main issue that the author faced during the implementation of the European Union project was the inability of the adults to learn lack of understanding of the value of new knowledge and, more importantly, lack of the skills to process and keep in mind large amounts of information, as well as the inability to apply their knowledge in practice.

The objective of the researches conducted by the author was resolving those issues.

During the training the adult students had to fill out questionnaires, which allowed introducing adjustments to the teaching methods.



Project Management Development – Practice and Perspectives

First International Scientific Conference on Project Management in the Baltic Countries
February 8-9, 2012, Riga, University of Latvia

Another feature of the training was the prerequisite requirement that each group consisted of at least 60% of female students. In addition, it was mandatory that the number of students in each group was at least 15 and not more than 30 people. The program was developed and put into practice within the project “the Vocational Education 2005-2006.” On the whole, over 2562 people in 119 groups in 21 regions of Latvia have been trained within the scope of the program.

All project materials have been recorded and made available to government bodies and the bodies of the European Union within the *Lifelong Learning* program.

Introduction

In 2006, the governmental organizations of the Republic of Latvia have launched an open competition for re-training employees of the agricultural and timber processing industries. The project was launched within the scope of the national program „Development of professional skills of employees from the agricultural and timber processing industries” and was based on the concepts outlined in the European Union memorandum on Lifelong Learning. Educational centre LANDO® has won the right to facilitate trainings in 21 Latvian regions. The training course consisted of project management modules, basics of marketing and organizational management techniques and was conducted using non-traditional and innovative training methods. To deliver these trainings a new limited liability company was set up – “Lando Apmācība” (“Lando Training”).

According to the requirements of the project, each trainee had to assess training effectiveness and quality of teaching delivered by facilitators. Questionnaires were completed in a written form, then the results were accumulated and summarized in the reports. Thus, all information related to the delivery of the project has been documented. All information related to this project has also been published according to the requirements of the European Commission dated 30th May 2000. In addition, the results of this training program have been published on a website of the Latvian Ministry of Agriculture and were mentioned in mass media.

Actuality of Research

As a result of new economic conditions, the EU is compelled to act rather conservatively when funding new member states. EU is committed to level out disproportions in labor productivity and welfare of citizens in the new member states. The EU has recently launched a “Policy for Cooperation” (2007-2013) and has assigned approximately 348 billion Euros. “Convergence” remains the key objective of the policy and is funded with 82% of funds. The main objective of the European investments is to „reduce structural disproportions between regions of the EU and to encourage a balanced development in all territories of EU, as well as to maintain equal opportunities for all EU citizens”.

Latvia is a relatively new EU member state that enjoys continuous investments from the EU funds; therefore it is important to analyse the current conditions of the internal labour market. It is critical to assess not only the amounts of the investments received by Latvia's regions, but their targeted use. For example, during realization of the project described below,



Project Management Development – Practice and Perspectives

First International Scientific Conference on Project Management in the Baltic Countries

February 8-9, 2012, Riga, University of Latvia

the author has established several patterns of the labour market in the Latvia's agricultural sector.

While requirements to of the EU development program were based on the skill levels of the Western European citizens, the author has noted that many Latvia's regions were underdeveloped and people were not familiar with basic learning skills, including using a keyboard for typing or using Internet searching engines). Also, the author noted that Internet was not available in all regions.

People employed in agriculture and farmers own large grounds and Internet providers find it unprofitable to launch individual Internet access for users in the remote areas. As a result, trainees in the rural areas found it difficult to deal with some exercises that would be straightforward for trainees in cities.

The major issue is that people from rural areas are used to physical work, but lack basic skills required for mental training. Vygotsky has mentioned that „it is impossible to train, it is possible to learn”, while Pythagoras said „it is impossible to fill a dirty glass with pure water”. Therefore, the author considers that before training adult people, it is necessary to teach them the basic learning techniques.

Novelty

For the first time attention is paid not to the subject being taught, but the process of teaching. Application of non-traditional teaching methods allows trainees to substantially improve their skills of memorizing new information, analyzing and summarizing it, identifying key correlations and establishing categories, and most importantly, doing it at high speed. Results achieved by trainees suggest that the non-traditional training methods can be effectively applied in any organization.

It is for the first time that such substantial research has been conducted and all questionnaires, charts, photo and video resources can be provided upon request. For the first time the system approach was developed for the speed reading and memorizing trainings using Mind Maps. This approach allows monitoring of each trainee's progress to benefit from direct coaching and achieving highest results.

For the first time a 2-days memory improvement training has produced significant results. The average training is designed for six days and takes 3-4 hours per day. There are no equivalents of so stable long term results achieved within so short period of time.

Description of the Issue

In order to develop comprehension of the organization of appropriate training in the various regions and in different directions, the author has personally conducted training of student groups at the beginning stage. The main requirement of the project was that an opportunity had to be provided to commence teaching immediately after closing the contract with the Ministry of Agriculture. Therefore, the author has personally conducted training of the first groups of students to assess the level of preparedness of the trainees.

During the process of training adult students, which was implemented by the author in the scope of this project, the author encountered a number of completely unexpected issues.



Project Management Development – Practice and Perspectives

First International Scientific Conference on Project Management in the Baltic Countries

February 8-9, 2012, Riga, University of Latvia

For example, it has been found that the majority of students were simply unable to physically withstand the classes that would last six hours (given that the breaks were organized in every seventy-ninety minutes). That is a huge number of people who just need to acquire new knowledge, both the theoretical and, which is very important, its practical application (such as the project management, business fundamentals, basics of marketing) were simply unable to perceive the body of knowledge equal to the duration of the six lessons in high school. Moreover, most people could not comprehend the relationship between theory and practice.

For example, the adult individuals engaged in agriculture seriously believed that advertising was evil. They reasoned that since the product is good (they produce the quality organic food), the customer will look for information on how to get it.

It did not matter that this information was not readily available anywhere (the Internet is not accessible, and rarely do the small farms have their own web pages), the customer would find out about the products by word of mouth. In other words, the myths, which were alive and well twenty years ago in the heads of the people during the creation of an independent state, seem to have been very resilient in the countryside. This can be explained by a mere lack of basic information. The Internet is almost inaccessible, and book reading is hardly the most important activity in the countryside, especially on the subjects related to running a business or project management.

People who are accustomed to hard physical work, that is “People Who Work with Their Hands” seemed to be completely inapt and unsuited to intellectual work. However, since now in the world there is a shift to mechanization and automation of work processes, people in rural areas should possess a higher potential to compete.

The roots of the problem can be assessed in the process of teaching at in rural schools. In the period from 2006 to 2009 the author at her own expense published a magazine on the matters of education for school students, teachers and parents, the *SKOLA* + (Reg. No. 000703075 ISSN – 1691-3337, Reg. No. LV-40003846471 and ISSN – 1691-340X, Reg. No. – 000703066), in total 26 issues have been published. On the basis of this magazine, the prizes worth at least fifty Latvian Lats would be awarded every semester for those school students who have a grade point average of eight or higher in their school report card (by a ten-point grade system) and above.

To the surprise of the author, in the rural areas the grade point average was very high. The school Report cards of the students of the rural schools might surprise standout students in the capital. Quite often, the students showed the report cards with only the highest grades, the 10's. At the same time, the tests revealed that the overall level of education in the rural schools lagged far behind that of the city schools. Meanwhile, these children are our future.

Thus, at the moment in Latvia it is possible to establish a fact of a major difference between the level of education in urban and rural areas, and the lag of the rural areas will only get worse over time.

It is the viewpoint of the author that it is very important to begin to implement the teaching methods for adults in rural areas, in order to train the adults to be trained. Popularization of the concept of the *lifelong learning* can bring tangible benefits to people in rural areas, where adults do not feel the need to increase their knowledge, learn new subjects, expand horizons, and generally become skilled at new things.



Novelty

For the first time in Latvia the author has introduced the innovative methods of teaching adults engaged in agriculture on a large-scale. As a basis the author employed the programs for rapid memorization, implementing the techniques of association and creative (imaginative) thinking developed by the author. As the experience showed, nearly all adults who have received training found that these techniques were new for them.

Most adults in the questionnaire indicated that they had never thought that there existed certain techniques that would make it easy to memorize, and what's important to recall at the right time the necessary information.

From the point of view of the author, the important point is that the adults received the explanations of the methods of learning and acquiring the new information.

This is important because if an adult individual after an hour and a half lesson is not able to assimilate new information, any training becomes pointless.

In the given project a very topical issue was how to implement the training as soon as possible. Also, in accordance with the requirements of the project, the author was substantially limited with respect to the cost of rent. In this regard, it was necessary to organize training in such a manner as to spend for each training course (the quantity of training hours was strictly regulated by the terms of the project) as few days as possible. The issue of the number of days was very important for the learners themselves, because they said they could not leave the work on the land for any longer than two or three days. The time issues would aggravate during the periods of sowing and harvesting.

According to the requirements of the project, all the adult students to undergo training would have to pass the tests, by which results it would be concluded whether such training was effective and whether each student was able to acquire at least 75% of the information delivered within the course during the training.

These factors influenced the author and made her develop the new approaches to teaching the adult students taking into account the previous experience, both in learning and teaching.

For the first time the non-traditional teaching and learning techniques have been tested in practice for the training of so many people who had had no learning skills.

Materials and Methods

The requirements for the project clearly specified the number and quality of the printed materials that can be prepared for distribution to students. The author usually prepares a complete package of materials, which includes both theory and practical exercises, so that after classes the trainees have the materials to repeat the studied material.

To conduct the lessons the author implemented her own computers and a projector, the classrooms were equipped with chalkboards for keeping records.

The educational course, which the author has conducted, using the non-traditional teaching and learning techniques, included the following topics: initial testing, determination of the amount of the short-term memory. Identification of methods used by adults in everyday life. Evaluation of their effectiveness. Theoretical information on operation of memory, information on the short-term and long-term memory. Model of functioning of memory. Basic rules to facilitate memorization and subsequent reproduction of the information.



Project Management Development – Practice and Perspectives

First International Scientific Conference on Project Management in the Baltic Countries

February 8-9, 2012, Riga, University of Latvia

Memorization of complex names, terms, abstract information. Remembering names and surnames. In the course of training a wide range of practical exercises for development of imagination that would allow to remember the necessary information at the right moment (agile reproduction) and the right-brain perception have been implemented.

The course also included techniques for memorizing diagrams and formulas, methods of storing accurate information.

A strong emphasis in the course of training was placed on the use of the association techniques to memorize foreign words along with their translation. This subject matter is becoming increasingly popular with the adults, as the united Europe has opened labor markets for all, which allows anybody to migrate in search for more attractive working conditions. Also, for people engaged in agriculture in Latvia (who were the target group of this project) search and cooperation with foreign partners becomes an important issue, as does entering new markets.

However, the prerequisite requirement for the implementation of such activities is a command of a foreign language, which causes some difficulties for older people. Therefore, the course also included the subject of memorizing words in a foreign language with a translation of the text.

On the whole the course included eight subjects. Testing was conducted before studying of each new topic and after it. Thus, during training, each of the students could determine the level of their own achievements and compare it with the level of the group.

Training was carried out in the form of training sessions, i.e., it was practice training. All results were recorded in the minutes and they are available in the form of reports to the Ministry of Agriculture of the Latvian Republic.

In accordance with the requirements of the project, after accomplishment of the training course each participant had to demonstrate acquisition of no less than 75% of the material. For the first time in her practice the author encountered the fact that many adults simply do not know how to learn.

For people engaged in agriculture, it was almost impossible to withstand the load during training equal to six school lessons. Moreover, the adult individuals at the beginning of the training course just could not reproduce even a small part of the information delivered by the author.

However, the author was on the one hand very limited by the requirements for training (requirements related to the facilities, coffee breaks, materials for training, handouts, the cost of training sessions per hour), and on the other hand the author had to take into account the interests of the students who came to learn.

Therefore, the materials were presented in the form of intelligence cards and pictogram techniques were used, which allowed repeating the studied material using funny pictures. In the course of training the method of associations and creative thinking have been employed for memorization.

Results

During implementation of this project the author was able to teach using the quick memorizing techniques. As a result after completion of the training program all students noted:

- 80% – a very good organization of the learning process,



Project Management Development – Practice and Perspectives

First International Scientific Conference on Project Management in the Baltic Countries

February 8-9, 2012, Riga, University of Latvia

- 76% – high professionalism and commitment of teachers,
- 72% – high level of teaching,
- 65% – wonderfully styled handout materials.

The author believes that these estimates could be even higher if the trainees had more experience in attending seminars and courses.

39% of students remarked indicated that this was their first experience in attending seminars related to additional education. Certain complications in the learning process have been noted. For example, many students (42%) found that they could not study six hours a day, although the training was carried out intermittently, and there have always been coffee breaks.

From the viewpoint of the author, this was a small load for an adult, given that in even in elementary grades of school seldom there are less than six lessons a day. Moreover, the fact that adults, who need to develop and constantly raise their intellectual level to meet the European level, don't have the skills necessary to make the learning process more effective, and the author is anxious about the future of these people.

In Latvia, in accordance with the requirements of the European Community, the retirement age is pushed back all the time. This means that people of age should be more active in the labor market and maintain competitiveness for a longer time accordingly.

During the course of training, the author found that the levels of intellectual development of adults in various regions of Latvia are quite different. Thus, the most active people among those engaged in agriculture were in the areas of Cesis and Jekabpils, with the least active in the areas of Jelgava and Ogre. It can be explained by the number of training courses offered in a particular area.

However, the major obstacles for training would occur during the periods of sowing or harvesting when gathering people in groups for training would become a very difficult task. During such periods every day is very important for people engaged in agriculture, they cannot study because they have to work. According to the requirements of the European Project training had to be carried out evenly over two years.

In addition, the attitude towards studying was influenced by the political parties. It was strongly evident with respect to the regions. In some regions, officials would simply refuse to pass to farms the information on the opportunity of free education. To resolve this problem the author would use the powers of the press. Interestingly enough, not a single publication has shown the slightest interest in covering the issues and opportunities associated with this kind of training.

The author would use the advertisements, even though the attitude of the rural population in Latvia to advertising is very biased. More often than not people just would not believe that everything would be free of charge.

On the other hand, the author believes that at least some amount of cash, maybe only 5-15%, students should pay out of pocket. This would provide a more serious attitude toward learning. Because, even though it was extremely seldom, there have been instances where the adult individuals would come to the training in a state of alcoholic intoxication.

Also should be noted the wariness of rural people to classified advertising.

This cautious attitude was eliminated only because the *Lando*® *Memory Development and Speed Reading School* has been on the market for over ten years, and all the information could be accessed at the Lursoft (a Latvian information technology company).



Project Management Development – Practice and Perspectives

First International Scientific Conference on Project Management in the Baltic Countries

February 8-9, 2012, Riga, University of Latvia

From the viewpoint of the author, the rural population in Latvia does not have enough motivation to study; people experience a lack of information on project management, business basics, marketing, and consider these subjects rather theoretical and having no practical application. In addition, most of these people are not used to pay for education and education is not considered valuable. Often they do not understand the need for continued development, although life shows that young people seek to abandon the rural regions, even the large farms to continue their education after high school in Riga.

Very popular was the course on project management, implemented in the course of this European project. Nevertheless, people engaged in agriculture were much more interested in the possibility of receiving European funding and participation in European projects than in the theory. Often people would not realize that receiving the funds would necessitate drawing up very precise statements, taking into account the requirements prescribed in each specific project.

In addition, most of the adult students just didn't know how to use a computer, and as the author has already mentioned, the Internet is not available on many farms. People would complain about the lack of information, not realizing that all the information is publicly available, it was just that nobody would fetch it to you, instead you have to take it by yourself.

During training, the author found that the majority of adults in rural areas were unable to learn. Often the problem remains from their school time. In fact, most adults simply do not have the basic skills to get the information. For example, the reading speed of most adults in the rural areas was within the range of 60-120 words per minute.

90 words per minute is a standard reading speed in the third grade.

Thus, it is easy to imagine how long it will take for an adult to read the requirements for the simplest European project. In this case, for the majority of adults in rural areas reading is no longer leisure, but a hard work, requiring high intellectual efforts.

Discussion

Project management is a subject rigid enough per se. And if the requirements for the implementation of the project specify the exact quantitative indexes, they cannot be violated.

But in the course of project implementation the author was unable to exclude from work the human factor. For example, according to project requirements, the number of students in one group should not exceed thirty. But in the course of project implementation in several areas the author faced the situation where people would arrive from all over the area for training as if it were some sort of a holiday or festivity. Following the formal requirements, if 34 individuals enroll for the training, anybody who fails to do so in advance should not be allowed to attend.

But how could they not be allowed, especially if one takes into consideration that those people had to get up at four o'clock in the morning to have the time to do all the work on the farm, and to get some free time to be able to attend the training.

The second issue is the financing of the handout materials. From the viewpoint of the author, it was not proper to disregard those extra students who arrived later and not to give the handouts to such students. Therefore, the author assumed all additional costs. The author believes that the requirements imposed by the given European project are far from taking into account the realities of Latvia.



For example, the idea of adjusting the skills and abilities of all adults to a uniform level as well as the level of education in the European Community in and of itself is very relevant. However the means of its implementation are often too restrained by bureaucratic approach.

For example, during training of a group in Latgale, the students asked to be dismissed 15 minutes earlier. It was because of the schedule of the buses that the students didn't want to miss.

Having not found the group where it was supposed to be at 17:50 the Supervisory Commission, despite the photos presented, would not count this training. From the viewpoint of the author, in addition to the formal requirements to implementation of the projects the human factor should be paid attention to as well.

When teaching adults it would be more productive to determine the level of command of the skills necessary for learning. From the viewpoint of the author, no training will be effective if people do not have the skills and abilities that allow them to process, memorize and use the received information.

Conclusions and Offer

Taking into account the recent trends in the European market, it becomes apparent that in addition to the process of aligning the overall situation in Europe and the equalization of living standards, the issue of not only purposeful, but also more efficient expenditure of funds allocated by the European community is becoming increasingly relevant. In this regard, the author considers the widespread adoption of courses using innovative teaching methods to enhance the competitiveness of adults to be relevant and timely.

In order to acquire new knowledge, taking into account the concept of lifelong learning, adults just need to possess the skills necessary for learning. In other words, the adults should have the learning skills. While in the large cities the education of the adult individuals does not present a problem since a wide variety of courses is readily available, the situation in the rural areas is quite different.

From the viewpoint of the author, it is necessary to explain to people not only the value of formal education, but also the benefits that can be obtained by using a system of complementary or non-formal education.

Education of adults will require a very large input from teachers. It is especially so when it comes to those folks who have not enjoyed their learning skills over a number of years, as it is the case with the rural population.

In this case, as Pythagoras said, "The purpose of the teacher is to light up the pupil as a torch, rather than to try to fill a dirty vessel with clean water."

It is the application of the innovative teaching methods that allowed the author in the course of implementation of the project to make the adults interested in the process of self-development, launch the mechanism of learning, develop their skills to work with semantic structures, and thus prepare the ground for the work of other educators who would in turn teach the specific subjects such as business management, project management, etc.

If the goal of the *lifelong learning concept* is to provide the equal opportunities to all adults, the techniques of fast memorizing and the methods of Speed-reading, along with the techniques of fast memorizing of textual information will allow the adults not only to learn quickly, but also most importantly, make it more efficiently.



Project Management Development – Practice and Perspectives

First International Scientific Conference on Project Management in the Baltic Countries

February 8-9, 2012, Riga, University of Latvia

The methods of memorizing and speed-reading can be very efficiently incorporated into the curriculum of regular students.

The first university to do so will secure the undeniable competitive advantage. In many countries, students first learn “how to learn”, and only then begin studying the necessary subjects.

Such a learning system can be implemented at the school level as well. The author has a broad database of results obtained during the course of training of more than 2,000 school students (mostly aged 8-12) who have mastered the program for rapid memorization and speed-reading.

This study allows making a conclusion about the level that can be achieved by the adults. Latvia is a small country. And in such a territory it is much easier to arrange training in order to stop the flow-out of labor force, and give people the opportunity to pursue their goals in Latvia.

Children are the economic future of the state. They will create the GDP, provide pensions to the older generation, and pay taxes. The author believes that today there are opportunities to make the education, including the informal education so effective as to produce the real results in terms of monetary equivalents.

Extensive use of innovative teaching methods allows arranging the educational process in all groups of adults, including those who have not used the skills necessary for learning for a long time. The non-traditional teaching methods are a tool that allows not only remembering, but also retrieving the necessary information at the right moment.

The author has the considerable experience in teaching adults in groups for general public, where anybody can receive training. In such groups there is great interest in non-traditional teaching methods. Most often, the students are those who have worked abroad and now want to continue their studies at institutions of higher education, though they now realize that they’ve just forgotten how to learn; people who plan their careers and who will be required to work effectively and study, professionals who are planning to go to work abroad.

The broader practical implementation of such methods would enable the Latvian state in the shortest possible time to raise the competitiveness of the workforce by providing the working people with the tools to help them be more effective at work.

Acknowledgments

This work has been supported by the European Social Fund within the project “Support for Doctoral Studies at University of Latvia”.



INTERNATIONAL PROJECT EXPERIENCE AS A TOOL FOR IMPROVING PROFESSIONAL COMPETENCE AND QUALITY OF TEACHERS EDUCATION

Dr.paed. Linda Mackevica

Liepaja University

Baseina iela 9, Liepaja, LV-3401, Latvia

Phone: +371 29553461

E-mail: linda.mackevica@liepu.lv

Keywords: innovative teaching and learning approaches, international collaboration, professional competence, project management, quality of education

Abstract

Current situation in the field of education is a continuous process of looking for the possibilities that improve its quality, based on democratic approach to pedagogy. Education has been considered as a deposit for progress in the 21st century and personal responsibility in using ones own potential abilities has become an urgent and topical issue [1].

Managing and joining international projects of collaboration, offer wide and up to now not very often used possibilities for personality development and self-realization. Bringing students together from the network institutions, gives them the opportunity to experience how different cultures, societies and educations influence the pedagogical tradition as well as the development of democracy and cultural identity. Transnational cooperation network promotes awareness of different cultures, experience exchange, and allows making observations and comparative analysis of educational systems and policies of partner countries.

Implementation of innovative projects, which have resulted from international collaboration promotes the development of cultural processes, fosters creative activities and makes the results available to the society, as well as it facilitates the improvement of professional competence of becoming teachers.

The article will share experience in both project management (ERASMUS IP “NEPME-New Perspectives in Music Education”) and collaboration as a partner in transnational projects (multilateral COMENIUS network “CREANET-Creativity in preschool education”).

Introduction

As it is believed, there exists a reciprocal link between global success and the level of education: if the competence level of society is improved by implementing life long education strategies, the abilities of society for adapting to the global processes have been promoted accordingly. Therefore, education, scientific research, creativity and innovations have been put forward as the most significant and challenging aspects of 21st century [1, 2].



Results of the research point to the essential aspects that show the link among opportunities for personality development and creative self-expression in the process of intercultural interaction, as well as to the significance of international collaboration as a challenge for self-realization and professional competence improvement of both practitioners and becoming teachers. According to M. Williams [3], projects are an increasing feature of nowadays reality that consists of ongoing projects, new technologies and challenges, where project management skills are considered as significant transferable skills that are highly valued and sufficiently improve professional competence.

Project management skills are promoted by both managing projects and participating in a network, thus, international projects of collaboration offer wide and up to now not very often used possibilities for personal development and self-realization. Bringing partners together from network institutions, gives them an opportunity to experience how different cultures, societies and educations influence the pedagogical tradition, as well as the development of democracy and cultural identity. In a changing society there is a need to create innovative teaching methods to be used in different classroom environments. Transnational cooperation network promotes awareness of different cultures, experience exchange, and allows making observations and comparative analysis of educational systems and policies of partner countries.

The article will give insight into two good practice examples:

- still ongoing transnational project (Liepaja University as one of the partners),
- completed international project (Liepaja University as a project promoter).

CREANET – Creativity in Preschool Education

CREANET is a multilateral Comenius Network running between 2010 and 2013. The project is the result of a transnational partnership representing 12 partner and 40 associate partner organisations from 10 European countries active in the field of education. The partnership consists of universities, teacher training colleges and regional authorities that cover four key areas in order to create a high quality forum for discussion, exchange and development of the theme: research, training, drafting of policies and management of services. The rationale at the basis of building the partnership has been the involvement of participants that could bring added value and inputs from different perspectives on the issue, aiming at creating a European forum for discussion, research, exchange of best practices on creativity in pre-school education from a multidisciplinary and cross-institutional perspective [4].

The **objectives of the network** are:

1. To create a European forum for discussion for those interested in creativity in the pre-school context;
2. To identify, compare and exchange the methodologies, approaches and environments favouring the development of creativity among children and teachers in the countries involved;
3. To increase the quality of educational offer by promoting the competences of preschool teaching staff on the issue of creativity;
4. To use creativity as a means to favour educational and social inclusion of children and families belonging to minorities and/or disadvantaged groups;
5. To strengthen the European dimension referred to the Lifelong Learning Programme and to fostering creativity from the earliest stages of development.



Implementation of the Project

To achieve the objectives successfully, the ongoing project activities have been structured in seven work blocks:

1. Management and coordination;
2. Research activities;
3. CREANET annual conferences;
4. Working groups “Creativity and Context” and “Creativity and expressive languages”;
5. Dissemination activities;
6. Evaluation and quality management;
7. Valorisation and follow-up.

In order to create an effective project of networking, the theme of creativity is being approached by focusing on two specific aspects, developed by the **working groups** and supported by the researchers – 1) creativity and contexts, including spaces, materials, relations, and creativity and 2) expressive languages, revealing artistic, verbal languages and body language. The first meeting of the working groups involved about 20 preschools and it achieved the following results:

- all the participating teachers were given the opportunity to introduce themselves and their pre-schools,
- a discussion about the focus of the group on the basis of the specific interests of the pre-schools were begun,
- agreement on how the activities within the group will be organized in the light of the work plan of the project was made.

The network has been developing **three main sets of activities**:

- The research activities that aim at developing a European approach to creativity in preschools by using the methodology of literature review, fieldwork and action research.
- The exchange of best practices among preschools of partner states.
- The annual conferences that aim at presenting the results of the research work, exchange of best practice examples, promoting the debate among policymakers on issues related to creativity in preschool education, and developing new projects [4].

The **research activities** have been planned according to developed methodology, taking into account the main purpose of the project to generate an understanding and awareness of the profound significance of creativity in children’s lives. According to the focus, the research in the project is being conducted in different ways by the means of:

- reviews of the national and international literature on young children and creativity,
- field-work – anthropological research carried out in pre-school institutions, chosen for the purpose,
- action research with practitioners.

The research design is evolving as a spiral, enlarging in scope and deepening in reflection and understanding, and characterizing the activities and methodologies that can promote creativity in pre-school settings in different socio-cultural contexts, reflecting upon the creative processes and products of children and adults, analysing the ways they relate to each other and to the different environments and contexts. The outcomes of the research will contribute to policy recommendation of how to foster creativity in pre-school context and more in general in children’s lives.



Project Management Development – Practice and Perspectives

First International Scientific Conference on Project Management in the Baltic Countries

February 8-9, 2012, Riga, University of Latvia

In order to make the best use of the project activities and results, it is very important to take into consideration the necessity of **dissemination activities**. Along with such dissemination tools as newsletters, well working website and participation at conferences, national dissemination meetings are of great significance. They reveal interest about the possibility to collaborate with preschools from other partner countries and share experience in the area of creativity, thus finding new ways of expression and ideas. There was pointed out the need for an inspiring environment and available materials, as well as for sound knowledge about the essence of creativity and methods of implementing it into everyday life at preschools. However, the preschool teachers were not very convinced about their English as a language of communication.

The Results Foreseen by the Project

The network will provide an opportunity for spreading information about research and best practices identified in the participating countries, as well as it enhance to create more transnational projects focusing on creativity in the pre-school context. The **project results** will have an impact also in terms of improved skills and providing pre-school teachers with materials, including the results of research work, information and opportunity for reflection leading to new in-service training projects focusing on creativity. Through dissemination and valorisation activities there will be reached the following four groups that benefit from the project activities: 1) academics – professors, lecturers and university researchers in the field of education, 2) teachers, educators, managers of preschool services and unions, 3) decision makers at different political level and civil servants at local or regional level, 4) families of children attending preschool services.

The **main products** of the project will be:

- Guidelines on creativity in pre-school educational context, aimed at policy and decision makers;
- DVD and a virtual exhibition showcasing the best practices of the network;
- Edited academic book resulting from the work done by the universities and researchers.

ERASMUS Intensive Programme NEPME – New Perspectives in Music Education

The ERASMUS Intensive Programme is one of the implemented international projects of collaboration, which was promoted by Liepaja University (with the author of the article as the project manager; project implemented from 2005 to 2008). The partners of collaboration both in creative and scientific area were Music Departments of Växjö University (Sweden) and Hildesheim University (Germany). A necessity for Intensive Programme appeared in a frame of common projects and collaboration. The background for the contacts between the institutions in Växjö (Sweden) and Liepaja are dated back to 1994, between Hildesheim (Germany) and Liepaja – 1998. The common projects and collaboration were mostly connected with mobility of students and teaching staff, evaluation visits and collaboration dealing with development of new universities structures and improvement of the content of education.

On this background a decision was made to deepen the cooperation as a consequent development of existing relationship, to develop joint courses for students and teaching staff as well as students and staff mobility, and to integrate innovative methods of teaching and learning in the field of music education, that is closely connected with promoting intercultural dialog and understanding different cultural issues all over Europe and its neighbouring regions [6].



Project Management Development – Practice and Perspectives

First International Scientific Conference on Project Management in the Baltic Countries
February 8-9, 2012, Riga, University of Latvia

The project was intended to be a long-term collaboration in societal and cultural aspect, thus ensuring sustainable development. The **long-term goals** for the project were put forward as follows:

1. To improve the quality and the European dimension of higher education in the sphere of music.
2. To get to know different cultures and educational approaches and to encourage creativity, inter – cultural dialog and knowledge of musical heritage of the nations of Europe.

The **main activities** of the project:

1. To develop intensive courses for students and promote students and staff mobility in the field of music education in order to improve their professional experience and competencies, and enhance the quality of education.
2. To develop different innovative methods of teaching and learning music founded on interactive, goal oriented as well as problem and democracy based learning and teaching activities (in the cultural context of each country).
3. To implement the most appropriate approaches and methods within the study process.
4. To organize concerts of the students acting in the project, that presents different cultures, approaches, and attitudes [5, 6, 7].

Implementation of the Erasmus Intensive Programme

Every year the Intensive Programme (IP) took place in one of the participating institutions. The overall theme of the project is “New Perspectives in Music Education”, but each year there was a **focus on different topics** selected according to the study process specific for every partner University and availability of experts – professionals in the field. The following themes were covered during the project implementation period:

- 2005/2006 – Folk Music in our Cultures (in Latvia),
- 2006/2007 – Jazz, Pop and Rock Music in our Cultures (in Sweden),
- 2007/2008 – World Music (in Germany).

Working together allowed analyzing our different needs and resources, and field studies were offered to get a deeper insight into relating theory with practice. Teachers and students could benefit by working together in multinational groups and by experiencing learning and teaching conditions not available in a home institution. There was a possibility to test new approaches and teaching methods in an international classroom environment and integrate the acquired experience into the study process. The **organizational aspects** of the IP included musical presentations, network workshops, lectures and seminars, field studies, master classes, ensemble playing, discussions, reflections, rehearsals and the final concert.

The IP ended up with the final concert that reflected on the effort done during two weeks of the intensive courses and resulted into wonderful performance of all project participants. It revealed musical traditions and repertoire of the participating countries as well as improved performance skills of students and was an excellent opportunity for creative self-expression and self-realization. The records of Final concerts can be found in a video and DVD format.

Study process during the IP was based on **interdisciplinary approach** and the unity of theory and practice in the context of inter–cultural education. Interactive teaching methods, problem-based learning, discussions, group works and lectures were used to reveal the content



of the subjects offered. Development of appropriate approaches to the acquisition and management of knowledge as well as innovative teaching methods are still improving the study process and facilitate the development of existing study programmes.

To **monitor the success** or failure the discussion method was used that was a good indicator of the project progression and reflected on the issues that had to be improved during the process itself. A self-evaluation of the students and the teaching staff participating in the IP (in the form of questionnaires and reports) was used to evaluate the progress of the project implemented.

The **total number of participants** during the three years of activity has been estimated to 87 students, 15 teachers and 21 expert teachers. The IP covered 6 ECTS and all the subjects taught during the programme were integrated into the existing study programmes connected with music and teacher education of all participating institutions – Cultural studies and esthetical practice, Major in music, with focus on composing, Chamber music, Musicology, Swedish folk music, Music teacher, Sports and dance teacher, Preschool teacher, Primary school teacher, Culture management. Learning agreements ensured academic recognition of the studies undertaken within the project and Certificates were issued. It is considered that the IP can become a regular part of existing study programmes and the most appropriate methods and approaches can be selected and integrated within the study process of all participating institutions.

Results of the Project

The materials created and used during the IP have been included in the issue of publications. It is possible to get acquainted with a brief description of the project, reflections and summary of discussions as well as with materials from lectures about Folk music, World music and Jazz, Pop and Rock music in cultures of participating countries. At the end of the issue of publications there is the music material used during intensive courses. The CDs and DVDs have complemented the materials that could be used in the further study process.

The outputs have been used in the study process at every partner institution and presented in different seminars and courses. Elaborated educational materials and issued music materials ensure continuation and broad dissemination of acquired knowledge and repertoire.

The most significant results of the project, which have been refined by the means of questionnaires and reflections, are:

1. The project responds to nowadays needs and challenges in education, ensures broader view and understanding as well as international perspective in the process of music education. It presents a multidisciplinary approach and the unity of theory and praxis that is reflected by the subjects included in the IP.
2. The project ensures flexibility of music education in the current situation using different approaches and methods, thus making the study process more up-to-date and effective:
 - making music instruments from nature materials;
 - using computer programmes in composing and creative activities – 3D frequency analysis with WaveLab, Garage Band;
 - learning different methods of improvisation;
 - experiencing different approaches for playing in rock and pop ensembles;
 - acquiring awareness and knowledge on developmental tendencies of culture in participating countries.



3. It has raised motivation for playing an instrument and developing own professional competence. The project has raised interest in other music styles and in music of other countries as well as it gives a possibility to get to know different cultures and offers a possibility for creative self-expression.
4. Dissemination seminars have introduced students, teaching staff, music teachers at schools with the results of IP, thus spreading the most sufficient ideas for broader auditory to gain new perspectives and professional competencies, broader view and understanding.
5. The IP lets to meet different music students inside of Europe and learn a lot not only about music, but also about other cultures. It helps to experience of meeting and respecting people from other cultures and creating an intercultural dialog. The project is the right way to make people more open-minded to other cultures [5,6,7].

Conclusions and Discussion

The projects in the sphere of education, like projects in any other sphere, have: 1) a finite and defined life span, 2) they aim to produce a measurable benefit or product, 3) contain a corresponding set of activities designed to achieve that benefit or product, and 4) have a defined amount of resources allocated. The final, vital requirement is that the project also has a proper organisation structure with defined responsibilities, so that everyone involved knows what they are doing and why, how it must be done, and by when [8].

There are four basic and interrelated elements of a project: time, cost, scope and quality that should be simultaneously managed by a project manager or by a national coordinator. It has to be considered that any change to the scope of the project have a matching change in the resources, time and money if the project is to be managed effectively. The quality may include not only the quality of the final product, but also a qualitative management approach [3, 9].

Therefore, a project manager is the key person who is responsible for keeping the balance between these parameters of time, cost, and quality mentioned above. They need to have a good level of know-how in the field their project is in, as well as sufficient authority to have influence with senior decision-makers [9].

In order to provide a qualitative project management through the life cycle of the project, the project manager should be able not only to:

- plan all aspects of the project,
- monitor costs, efficiency, and quality without generating unnecessary extra work for others,
- involve the whole team in decision making,
- get the right people for the right task at the right time,
- keep focused on results,
- demonstrate excellent problem-solving skills,

but also possess interpersonal skills to negotiate project requirements with senior decision-makers, motivate with integrity, sensitivity, and imagination, as well as build excellent team relationships [3, 9]. These interpersonal skills are of great significance when there is a need to overcome difficulties during the implementation of the project. Some of the most common difficulties, according to the existing experience, are as follows:

- to find a common understanding and explanation of the concepts used in the sphere of the project;



Project Management Development – Practice and Perspectives

First International Scientific Conference on Project Management in the Baltic Countries

February 8-9, 2012, Riga, University of Latvia

- to set common and clear criteria and work plan for research and other project activities;
- to agree on how to link experiences in order to see a complete picture and achieve the goals put forward by the project.

The implementation of innovative projects, which have resulted from international collaboration promotes the development of cultural processes, fosters creative activities and makes the results available to the society, as well as it facilitates the improvement of professional competence and the quality of education of becoming teachers. By the means of the projects, participants are given the opportunity to get to know the influence of different cultures, societies and education on the development of cultural identity.

Thus, such kind of projects could be an integral part of study programmes and the results could be integrated to improve both professional competence and the quality of education, and meet the educational and cultural needs of nowadays society. Participants benefit by working together in multinational groups and by experiencing learning and teaching conditions not available in a single institution.

Unique learning and teaching experience, development of new subjects, in order to respond to today's needs, ensure flexibility of the education system and achievements in scientific research work. One of the most important results can be an improved professional competency of the staff, updated knowledge and integrated experience from all the partners of collaboration.

As the result, there can be concluded that joining international projects is:

- a significant factor in maintaining and developing national identity and culture,
- one of the means of creativity development,
- an essential opportunity for students' cooperation and collaboration,
- a subject that fosters harmonic personality forming.

References

1. *Latvijas izaugsmes modelis [Developmental Model of Latvia]*, 2005. Retrieved September 15, 2011 from http://www.nap.lv/lat/attistibas_planosana/latvijas_izaugsmes_modelis.
2. N. Fuglesangs. Radošums un uzņēmējdarbība. Rubrika: Kultūras Diena, *Diena*, 12.janvāris, 2007. 16. lpp.
3. Meri Williams. *The principles of project management*. Canada: Site Point Pty. Ltd., 2008. 224 p.
4. CREANET-Creativity in Preschool Education. Retrieved December 3, from <http://www.creativityinpreschool.eu/creanet/>.
5. Linda Mackevica, Olga Blauzde. *Jazz, Pop and Rock Music in our Cultures*. ERASMUS International Project "New Perspectives in Music Education". Materials of Intensive Courses. Liepāja: LiePa, 2007. pp. 31-45.
6. *ERASMUS International Project "New Perspectives in Music Education"*. Materials of Intensive Courses. Summarization of the materials: I. Valce, L. Mackevica. Liepāja: LiePa, 2006. 40 p.
7. *Summary of the Materials 2006-2008*. Erasmus International Project "New Perspectives in Music Education". Summarization of the materials: L. Mackevica. Liepāja: LiePa, 2008. 132 p.
8. *Understanding the basics of project management*. Retrieved November 10, 2011 from <http://www.ultimatebusinessresource.com/images/pmal.pdf>.
9. James P. Lewis. *Project planning, scheduling and control*, 3rd edit. New York: McGraw-Hill, 2001. 515 p.

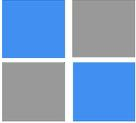

AN OBJECT ROLE ORIENTED PROJECT MANAGEMENT APPROACH

*Professor Dr. **Peter J. A. Reusch***

University of Applied Sciences and Arts

Fachhochschule Dortmund

Emil-Figge-Str. 44, D 44227 Dortmund, Germany

E-mail: Peter.Reusch@FH-Dortmund.de

Muhammad Khushnood

University of Applied Sciences and Arts

Technical University Dortmund, Germany

E-mail: mkhushnood@hotmail.com

José Ramon Otegi Olaso

University of the Basque Country Bilbao, Spain

E-mail: joserra.otegi@ehu.es

Keywords: Project Management, Object Role Modeling, Standardization

Abstract

Object Role Modeling can clarify fundamental management concepts in project management and can support all fundamental management levels:

- There are the basic mainly operational processes, like defining the scope of a project, develop a work breakdown structure, develop a project plan, etc.
- There are processes for managing and controlling projects, like running a project according to the plan and updating the plan.
- And there are audit processes, which check if there is a project plan, if the project is managed according to the project plan, and if deviations are detected and lead to updates of plans.

For all three levels there are responsible project team members and stakeholders and they all must take their roles and responsibilities.

1. Introduction

There are several concepts to develop project management – classical approaches for example or new agile approaches [1]. Agile project management at the beginning was promoted as a method to support dynamic projects. The new philosophy of agile project management was celebrated as a key to solve many problems in project management. Today we look more at the common issues of classical and agile project management – and realize that classical and agile project management can support each other.



Project Management Development – Practice and Perspectives

First International Scientific Conference on Project Management in the Baltic Countries

February 8-9, 2012, Riga, University of Latvia

Project management needs more well developed and well implemented methods to meet future requirements. When we look at knowledge areas of project management as developed by PMI® [2] for example, there are strong methods to create a work breakdown structure and start project planning by sequencing and linking tasks as successors and predecessors. Such methods go back to the 50s and even beyond. Often in the knowledge areas we find proposals for checklists or general hints – “ask experts” for example. Many fields in knowledge areas are not well developed – there is a lack in strong and appropriate methods and tools in project management.

There are well developed methods with high potential to support project management like Object Role Modeling – ORM, an approach derived from information analysis and data base design many years ago – [3], [4], [5], [6]. Object Role Modeling can help to identify roles and responsibilities in projects – and is strong in specifying constraints. Object Role Modeling can support change management by identifying new roles and responsibilities and role changes as discussed in [7],[8]. In projects there is a need to recognize social responsibility. There are standards how to develop social responsibility [9]. ORM can support many aspects of social responsibility in projects as discussed in [10]. Object Role Modeling can help to manage complex systems.

A few further aspects to mention here:

In ORM we can assign tasks to team members. We can assign different roles of team members. Team members can work on tasks, can control tasks, etc. We can clearly separate control functions from working functions. Tasks are assigned to a unique team member or several team members. In a second level we can assign a risk to the work of team members on tasks. Such risks are identified, registered, and classified. For a risk there are plans how to avoid the risks, how to mitigate, or how to reduce the impact of the risk. All those risks must be managed. Risk owners should be introduced who watch the project and its context with respect to that risk. Again the roles and responsibilities of risk owners must be described.

ORM is well established in information analysis and systems design. Tools are available to support ORM like Microsoft Visio® with ORM shapes or NORMA [11], a tool that supports a natural language approach to ORM – an approach that is also discussed since many years – [5], [6].

ORM can contribute to the development of standards in project management. Project management standards are weak. Many years ago ISO 10006 with Guidelines for Quality Management in Projects was based upon the ISO 9000 family of standards in quality management and upon the deep understanding that project management must follow the principles of quality management. But ISO 10006 was too far away from knowledge areas and processes that were better developed in PMBOK® of PMI® [2]. Now in 2011 we have the ISO 21500 proposal on a “Guidance on Project Management” mainly based upon PMBOK®, but also with the same gaps PMBOK® has, many important processes in the designed knowledge areas are missing. There are too many general remarks and open proposals than strong concepts and models.

ORM can contribute to develop an architecture for future standards in project management. This paper is embedded in a broad initiative on standards on project management – [7], [12]. Within the European Master in Project Management – implemented in Dortmund, Bilbao, and Trondheim – there is a project to implement ORM concepts for most areas of project management.



2. Core concepts of Object Role Modeling

The figure below shows an Object Role Diagram for an employee. There is a graphical representation for employees – the object type “Employee” with a lexical object type “E code” to identify employees.

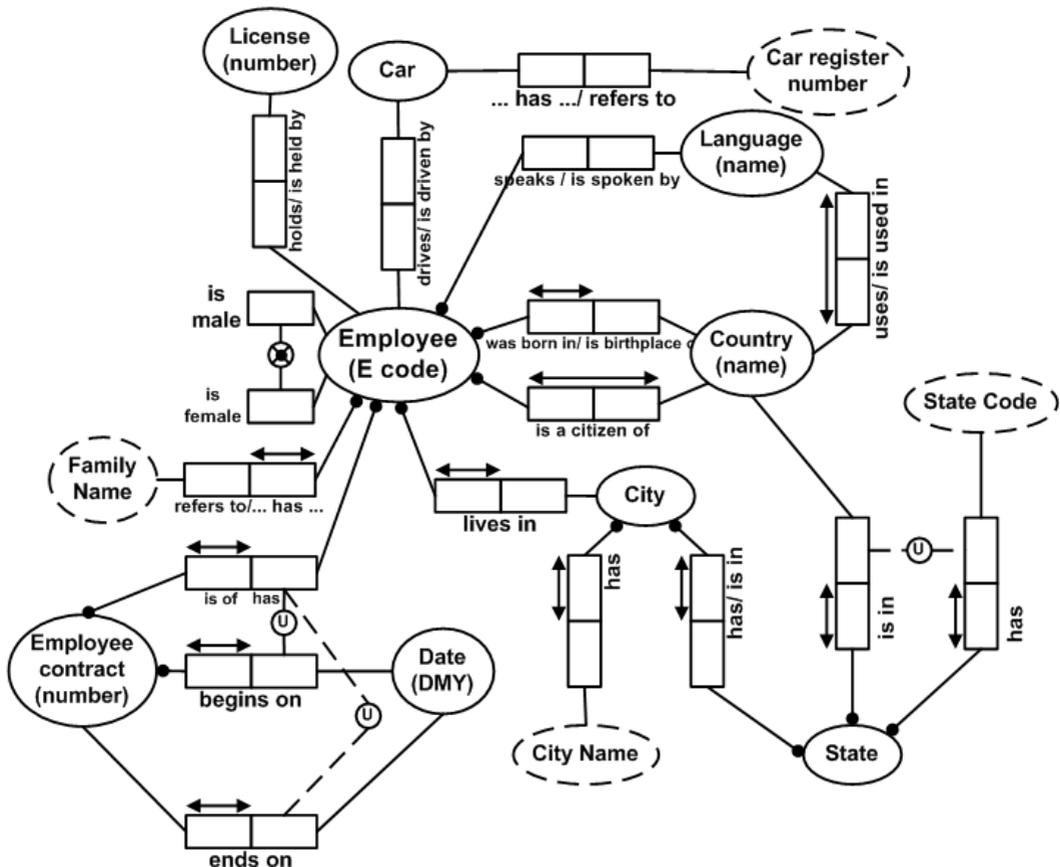

Figure 1. Object Role Diagram for an Employee and his/her Context

Each employee has exactly one family name, has one or more contracts, has probably a car, etc. Object types are linked through roles (rectangular boxes) and follow constraints. Details cannot be discussed here. Such an Object Role Diagram can be used to generate database tables to manage employees.

Besides the perspectives discussed very often in such an Object Role Diagram in this case there is a special focus on contracts which is important for project management. An employee working in a project may change his or her contracts. That is important for cost calculations and other activities. This Object Role Diagram shows that the contract is an important issue and that contracts can change.

The following Object Role Diagram shows an Object Role Diagram to introduce a project. On the upper left side there are object types for a general description of a project –



description, sponsor, project leader, steering board, budget, schedule, etc. On the upper right side there are object types to link to the standards that must be applied in a project, to core documents, resources and further issues like project audits. In the lower parts of the diagram there is a central object type for stakeholders with various subtypes – internal and external stakeholders, users, customers, suppliers, etc. The central part of the diagrams shows that projects may be included in programs and portfolios. It includes also a link to a business case – typically better linked to a program than to a single project.

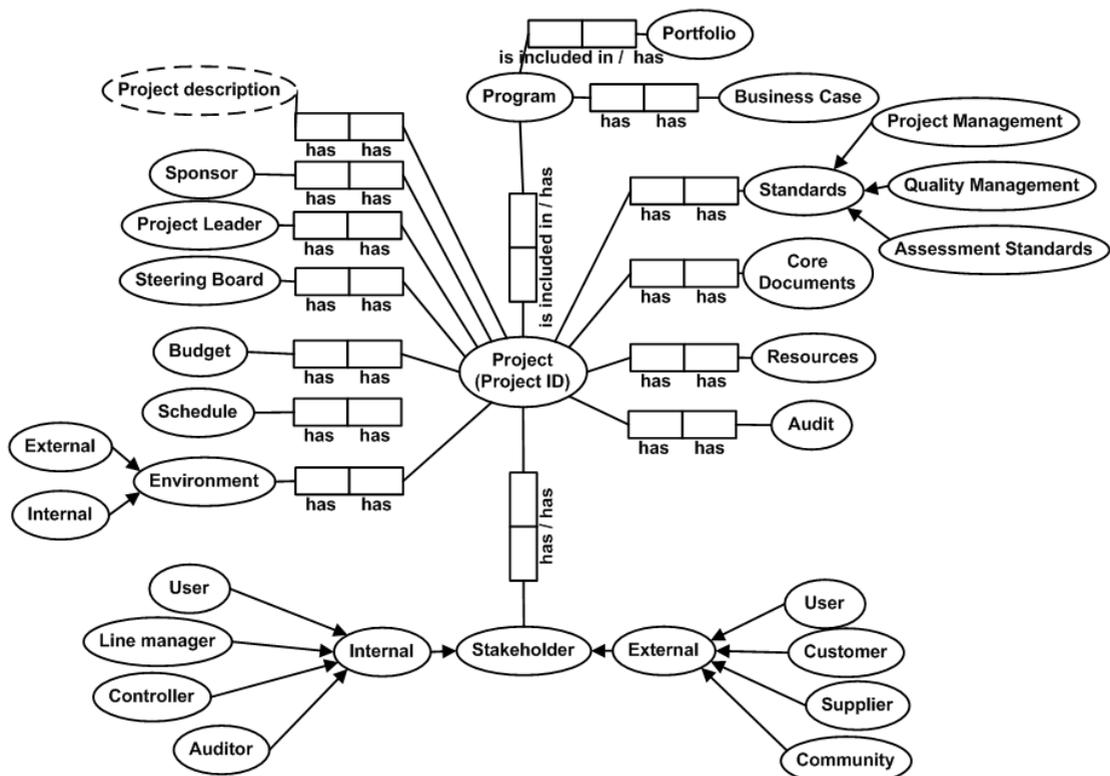

Figure 2. The Context of a Project in an Object Role Diagram

3. Risk Management in Projects

In this section we go a bit deeper into risk management – one of the knowledge areas of project management. We can show only a few diagrams that are developed right now in the European Master in Project Management – even for this area of project management there are about 20 diagrams.

The following figure shows that we want to go deeper in 3 areas of risk management – in general aspects of risks (organization, description, assessment, etc.), in risk management concepts (risk avoidance, mitigation, transfer, etc.), and in risk categorization.

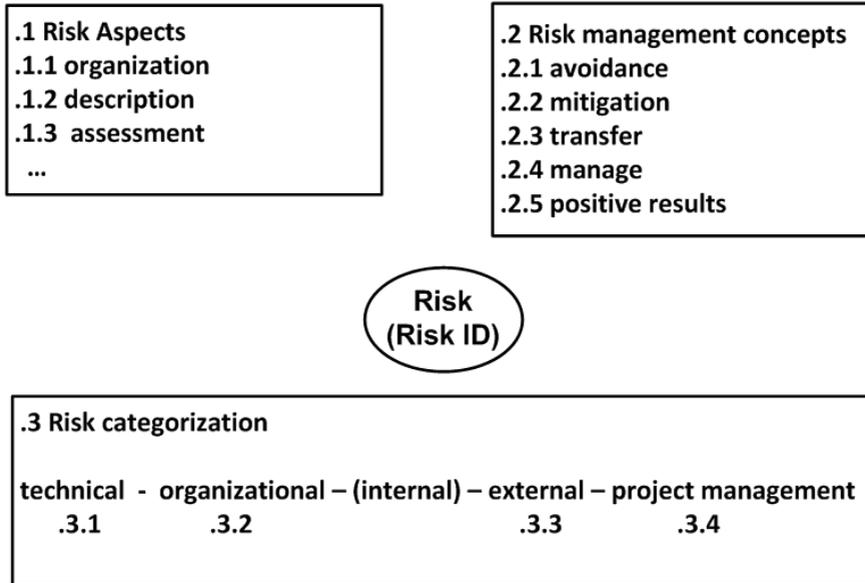

Figure 3. Perspectives for Risks in Projects

The next figure shows that risks should be included in a risk register, that risks should have a risk owner and a risk level. There should be further information on the assessment of the risk level.

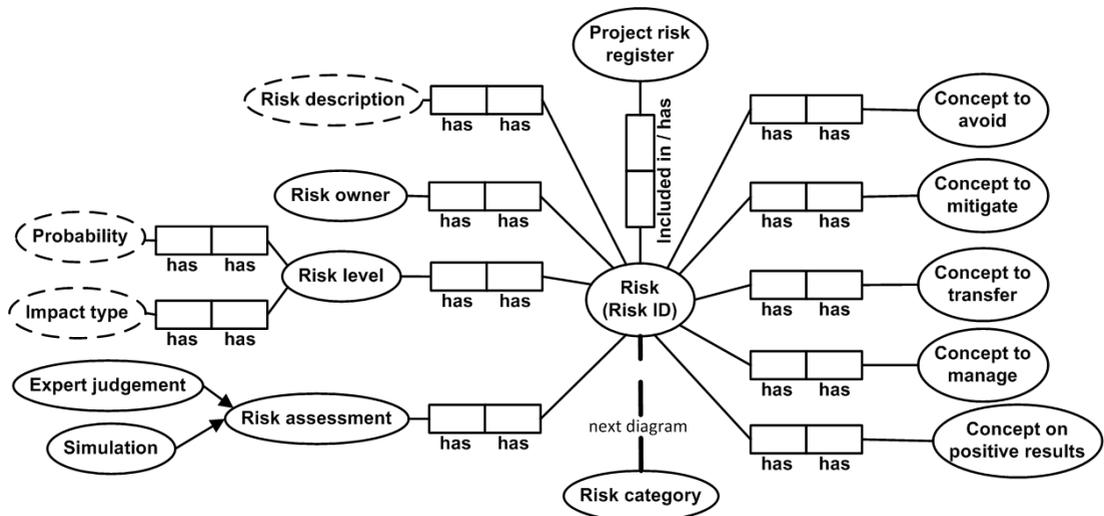

Figure 4. Object Role Diagram for Risk Management in Projects – 1



On the right side of the diagram there is the collection of concepts for risk management – concepts to avoid risk, to mitigate risks, etc. Of course all that can be detailed and subdivided according to priorities and further details can follow.

The next figure shows the second part of our core diagram for risks – the risk categories – subdivided into technical risks, external risks, organizational risks, project management risks, etc.

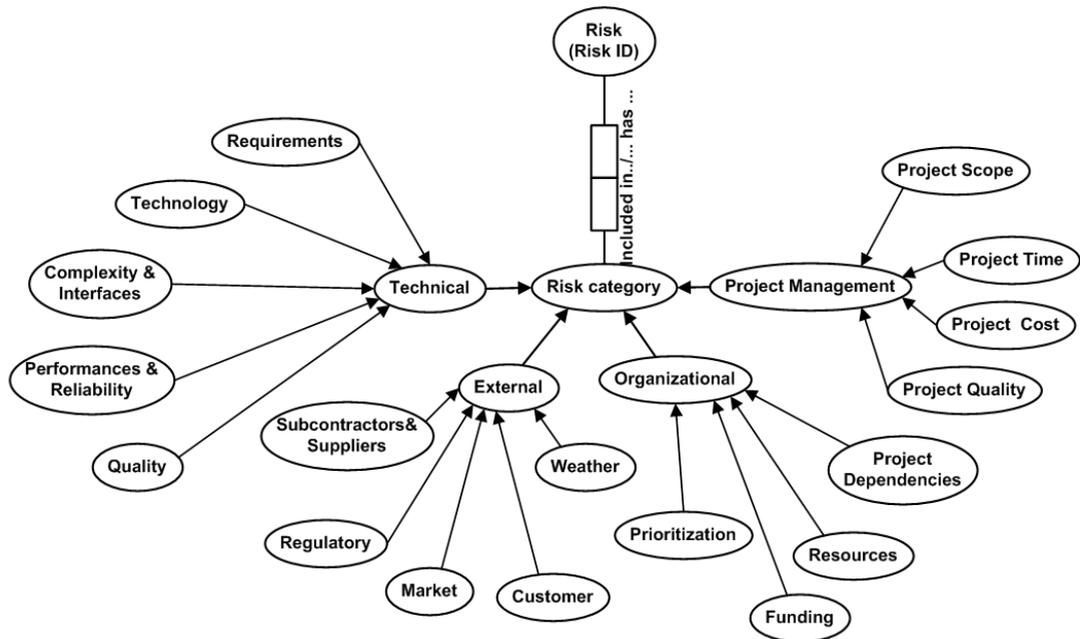

Figure 5. Object Role Diagram for Risk Management in Projects – 2

This Object Role Diagrams gives us a map for risk management in projects – so far a general map – but more detailed maps are available – about 20 maps should be used for detailed discussions on risk management in projects.

We are able to develop the concepts of risk management in a project – and to shape the diagrams. We can specify what is mandatory for our risk management in a given project and what is optional. We can add concepts – and can change concepts.

4. Development of Roles and Competencies in Project Management

As mentioned before and in [7], [8], [10] Object Role Modeling can be used to describe and organize changes and development. The following diagram shows a very simple case for modeling the development of roles and competencies in projects.

Employees work as team member in projects – lower part of the diagram. Employees working as project managers need experience – typically gained as project team member. So project managers are a subset of those employees that worked in projects before – a subset arrow indicates this relation. Employees working as project controller should have experience as



project manager – again a subset arrow indicates this relation. And further more – employees working as program directors should have experience as project managers.

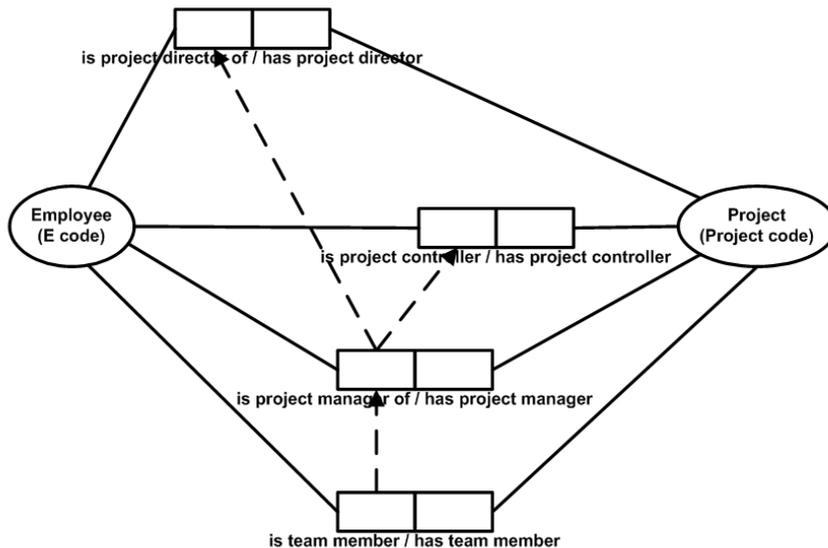

Figure 6. Development of Roles and Competencies in Projects

This diagram is isolated here, but it can be further developed and can contribute to develop knowledge management in projects.

5. Management Levels in Project Management

Object Role Modeling is open for hierarchical approaches. This is a key to represent management levels. The following figure shows the 3 most important management levels in projects:

- We plan and manage tasks, resources, etc.
- We control planned and managed tasks, resources, etc.
- Auditors check if we have plans and if we follow plans.

The figure below shows just a very simple case for these management levels, but our approach for an Object Role Oriented project management is totally open here.

The core ORM concept applied here is objectification. Here the relation including tasks with predecessors, earliest start (ES), latest start (LS), earliest finish (EF), latest finish (LF) and further roles becomes an object – embedded in an ellipse – and is linked to another object, the controller. For details see [3].

The task-controller relation again becomes an object linked to auditors.

This ORM approach for management levels can improve many aspects of project management. In [12] we describe that there is a real need for concepts for project audit.



1st Level. Management

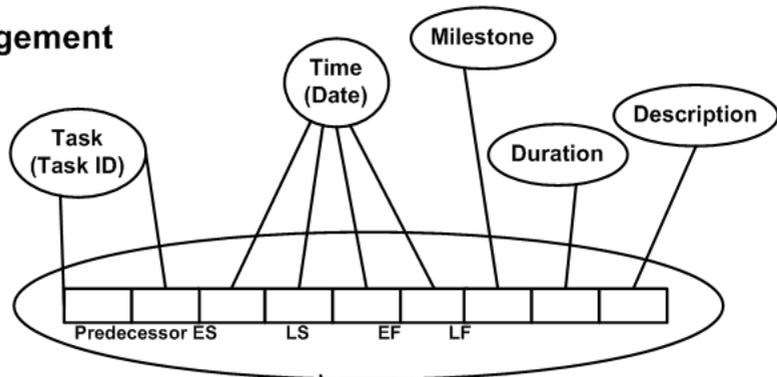

2nd Level. Management & Control

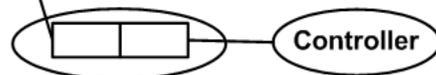

3rd Level. Management & Audit



Figure 7. Object Role Diagram for Management Levels in Projects

6. Conclusions

Object Role Modeling can support concept building for project management and is open for all areas of project management.

Improved models can contribute to project management directly, and can also help to improve standardization in project management.

The contributions developed in the European Master in Project Management [13] go beyond former approaches as used in [14] for example.

References

1. Cobb, Charles G.: Making Sense of Agile Project Management: Balancing Control and Agility, John Wiley & Sons; 2011.
2. <http://www.pmi.org>.
3. Halpin, Terry; Morgan, Tony: Information Modeling and Relational Databases, Morgan Kaufmann Publishers, Burlington 2009.
4. Reusch, Peter J. A.; Wintraecken, Jean-Jacques: Systemanalyse und Systemspezifikation, Mannheim 1990.
5. Reusch, Peter J. A.; Wolf, Axel: Natürlich-sprachliche Informations-Analyse-Methode, Dortmund 1995.



Project Management Development – Practice and Perspectives

First International Scientific Conference on Project Management in the Baltic Countries
February 8-9, 2012, Riga, University of Latvia

6. Nijssen, G. M.: Universele Informatiekunde, Beutenaken 1993.
7. Reusch, Peter J. A.; Khushnood, Mohammad: Extended Object Role Models to Support Human Development, Organizational Development and Change Management, International Conference on Current Issues in Management of Business and Society Development, University of Latvia, Riga, 2009. <http://www.evf.lu.lv/conf2009/>.
8. Reusch, Peter J. A.; Ntais, Ilias; Khushnood, Muhammad: Improving Creativity and Creative Problem Solving in Business Administration, International Research Conference, University of Northern Florida, Jacksonville 2009.
9. ISO 26000 – Social Responsibility.
10. Reusch, Peter J. A.; Khushnood, Muhammad; Khan, Rao Aamir; Aslam, Sohail: After the Crisis we need Social Project Management, International Business Research Conference, University of Northern Florida UNF, Jacksonville 2010.
11. <http://www.ormnet.org>.
12. Reusch, Peter J. A.: New Standards for Project Audit and the Impact on Existing Standards for Project Management, Intelligent Data Acquisition and Advanced Computing Systems, IEEE-IDAACS 2011, Prague. <http://www.idaacs.net/>.
13. <http://www.eurompm.net> – <http://www.wirtschaft.fh-dortmund.de/eurompm/startdo.htm>.
14. Cantor, Murray: Object-Oriented Project Management with, John Wiley & Sons 1998.
15. ISO 21500 Guidance on Project Management.



WHAT CAN STANDARDS STANDARDIZE IN INTERNATIONAL PROJECT MANAGEMENT?

*Professor Dr. **Peter J. A. Reusch***

University of Applied Sciences and Arts

Fachhochschule Dortmund

Emil-Figge-Str. 44, D 44227 Dortmund, Germany

E-mail: Peter.Reusch@FH-Dortmund.de

Katrin Löhr

University of Applied Sciences and Arts

Dortmund, Germany

E-mail: Katrin.Loehr@FH-Dortmund.de

Muhammad Khushnood

University of Applied Sciences and Arts

Technical University Dortmund, Germany

E-mail: mkhushnood@hotmail.com

Keywords: Project Management, Standards, ISO 31000, ISO 21500, ISO 10006, PMBOK, IFRS

Abstract

Existing standards for project management are often fuzzy guidelines with various perspectives. Gaps in standards are discussed – and links among standards. For the future we need standards that integrate project, program and portfolio management. We need standards in project management that integrate core standards in other areas like risk management and social responsibility for example. And we need strong methods that support an integrative project management approach – object role modeling can contribute here.

Introduction

Good international standards are hard to develop and hard to harmonize. The development and implementation of international standards should be based upon strong and recognized concepts and should integrate core issues of project management.

In international project management we have a situation today that is shaped by diverse more or less successful approaches.

Years ago ISO 10006 [1] with “Guidelines for Quality Management in Projects” was based upon the ISO 9000 [2] family of standards in quality management and upon the deep understanding that project management must follow the principles of quality management. But ISO 10006 was too far away from knowledge areas and processes that were better developed in PMBOK® [3] of PMI® for example – and ISO 10006 finally was not really accepted in the



project management community. Now in 2011 we have the ISO 21500 [4] proposal on a “Guidance on Project Management” mainly based upon PMBOK[®], but without significant links to concepts beyond the PMI[®] community. Most concepts of IPMA, AIPMA, APM, etc. are not included in ISO 21500. ISO 21500 makes PMBOK[®] stronger and other standards weaker, and will cause problems in a global recognition of ISO 21500. ISO 21500 grew in the ISO garden before ISO 10006 was officially buried – and was too weak to include the spirit and power of other concepts.

Today we have to reconsider what standards should standardize and can standardize. In project management we need a standard to introduce and develop the terminology for people working on projects – they need a common language. We need recommendations for developing a work breakdown structure and a project plan for example. Such recommendations should not be linked to tools like Microsoft Project[®]. They should be open for any implementation. So we have to focus on networks of tasks with predecessor and successors, with summary tasks and milestones, with lags and leads and other concepts.

Standards used in project management must take into account that in many cases standards used in project management are developed and applied in other areas like risk management. In risk management we have ISO 31000 [5] for example. We can take recommendations regarding risk management in projects from ISO 31000 – but it makes no sense to reinvent risk management within project management.

There are many more established standards that should be embedded in a new standard for project management like ISO 26000 [6] on Social Responsibility.

Another example for a broadly proven standard are the International Financial Reporting Standards (IFRS) [7] which also include a Conceptual Framework for the Preparation and Presentation of Financial Statements. One of the goals of these standards is to provide a true and fair view of the business affairs of the organization. This is also relevant for the project management field irrespectively from the local GAAP (Generally Accepted Accounting Principles).

ISO 31000, ISO 26000, and many more standards are much stronger than ISO 21500. In project management we need a clear understanding about the application of existing standards and about the additional specific contributions we need to support project management.

Specific contributions for project management are often very weak – in PMBOK[®] we often find the proposal “ask experts!”. There is finally no clear concept regarding the architecture for project management standards. In project planning today we use concepts that go back to the 50s or even beyond. We need more contributions on newer concepts and methods that can contribute to project management and can support the development and implementation of standards.

Here we focus on a review of core perspectives of standards in project management and on the scope of such standards with respect to program and portfolio management.

1. On Perspectives of Existing Standards

In [9] we read: “ISO 10006: 2003 gives guidance on the application of quality management in projects.



It is applicable to projects of varying complexity, small or large, of short or long duration, in different environments, and irrespective of the kind of product or process involved. This can necessitate some tailoring of the guidance to suit a particular project.

ISO 10006:2003 is not a guide to “project management” itself. Guidance on quality in project management processes is discussed in this International Standard. Guidance on quality in a project's product-related processes, and on the “process approach”, is covered in ISO 9004.

Since ISO 10006:2003 is a guidance document, it is not intended to be used for certification/registration purposes.”

The last statement above states a strategy that is different from standards like PMBOK® which is strongly focused on certification and registration as Project Management Professional – PMP® – for example.

ISO 10006 is based upon the principles of quality management as introduced in ISO 9000:

- Principle 1: Customer focus
- Principle 2: Leadership
- Principle 3: Involvement of people
- Principle 4: Process approach
- Principle 5: System approach to management
- Principle 6: Continual improvement
- Principle 7: Factual approach to decision making
- Principle 8: Mutually beneficial supplier relationships

According to this focus ISO 10006 deals more with customers than with stakeholders what makes ISO 10006 weaker than other standards in project management.

On the other side the strong focus on management responsibility and management commitment is really good and stronger than in other standards in project management – or is even missing in other standards.

“The commitment and active involvement of the top management of the originating and project organizations are essential for developing and maintaining an effective and efficient quality management system for the project.

Top management of both the originating and project organizations should provide input into the strategic process.

Since the project organization may be dispersed on completion of the project, the top management of the originating organization should ensure that continual improvement actions are implemented for current and future projects.

Top management of the originating and project organizations need to create a culture for quality, which is an important factor in ensuring the success of the project.” – ISO 10006 page 14.

“The ISO 10006 emphasizes the need for projects to be strategically aligned while the PMBOK® does not touch on this important aspect of project management. Projects that aren't somehow linked to a departmental or organizational strategy risk failure.” [10]

Management responsibility and management commitment today is stronger in standards dealing with program and portfolio management – like in Management of Portfolios of OGC:



Five Portfolio Management Principles:

“The portfolio management principles represent the foundations upon which effective portfolio management is built; they provide the organizational environment in which the portfolio definition and delivery practices can operate effectively.

1. Senior Management Commitment

Senior Management must publicly champion and positively communicate the value of portfolio management whilst participating actively in the processes.

2. Governance Alignment

A clearly defined escalation and decision making structure must exist that integrates with the existing corporate decision making processes.

3. Strategy Alignment

The portfolio must contain investments that contribute towards the achievement of the organizations strategic objectives.

4. Portfolio Office

Reporting to Board Level, a Portfolio Office function must exist containing PPM professionals that provide standards, analysis and enhanced collaborative working across departments such as finance and operations.

5. Energized Change Culture

The organization has created a culture where people are motivated and striving to do things better, they believe in the organization’s goals and feel part of one team.”[11]

One of the core issues of standardization in project management is the fact that projects cannot be considered alone. Projects are embedded in programs and portfolios and some standards we need in projects must be derived from standards for programs or portfolios.

2. On Standards for Portfolio, Program, and Project Management

The next tables below show the processes of project management and program management with their knowledge areas and process groups. Even in the 4th edition of PMBOK® there are a lot of gaps as shown in table 1 – areas with no defined processes, but areas which need processes. In the last column processes for collecting lessons learned for example are missing. In the first column processes that link project planning for example to enterprise strategies are missing. We cannot start human resource management without knowing the HR strategies of the enterprise – strategies regarding employment and payment for example. Such strategies could be derived from program or portfolio management, but table 2 shows that the process boxes for human resource management in programs are empty – no processes are defined here – in the program guide there is an empty chapter with the reference to PMBOK®. Also the boxes for processes in cost management and quality management are empty.



Project Management Development – Practice and Perspectives

First International Scientific Conference on Project Management in the Baltic Countries

February 8-9, 2012, Riga, University of Latvia

Table 1

PMI® Project Management Process Groups and Knowledge Areas [3]

-	Project Management Process Groups				
Knowledge Areas	Initiating-Process Group	Planning-Process Group	Executing-Process Group	Monitoring & Controlling Process Group	Closing-Process Group
4. Project Management Integration	4.1 Develop Project Charter	4.2 Develop Project Management Plan	4.3 Direct and Manage Project Execution	4.4 Monitor and Control Project Work 4.5 Perform Integrated Change Control	4.6 Close Project or Phase
5. Project Scope Management	-	5.1 Collect Requirements 5.2 Define Scope 5.3 Create WBS	-	5.4 Verify Scope	-
6. Project Time Management	-	6.1 Define Activities 6.2 Sequence Activities 6.3 Estimate Activity Resources 6.4 Estimate Activity Durations 6.5 Develop Schedule	-	6.6 Control Schedule	-
7. Project Cost Management	-	7.1 Estimate Costs 7.2 Determine Budget	-	7.3 Control Costs	-
8. Project Quality Management	-	8.1 Plan Quality	8.2 Perform Quality Assurance	8.3 Perform Quality Control	-
9. Project Human Resource Management	-	9.1 Develop Human Resource Plan	9.2 Acquire Project Team 9.3 Develop Project Team 9.4 Manage Project Team	-	-
10. Project Communications Management	10.1 Identify-Stakeholders	10.2 Plan Communications	10.3 Distribute Information 10.4 Manage Stakeholder Expectations	10.5 Report Performance	-
11. Project Risk Management	-	11.1 Plan Risk Management 11.2 Identify Risks 11.3 Perform Qualitative Risk Analysis 11.4 Perform Quantitative Risk Analysis 11.5 Plan Risk Responses	-	11.6 Monitor and Control Risks	-
12. Project Procurement Management	-	12.1 Plan Procurements	12.2 Conduct-Procurements	12.3 Administer-Procurements	12.4 Close Procurements



Project Management Development – Practice and Perspectives

First International Scientific Conference on Project Management in the Baltic Countries

February 8-9, 2012, Riga, University of Latvia

Table 2

PMI® Program Management Process Groups and Knowledge Areas [12]

-	Program Management Process Groups and Knowledge Area Mapping				
Knowledge Areas	Initiating- Process Group	Planning- Process Group	Executing- Process Group	Monitoring & Controlling Process Group	Closing- Process Group
4. Program Integration Management	4.1 Initiate- Program	4.2 Develop Program Management Plan	4.4 Direct and Manage Program	4.6 Monitor and Control Program Performance	4.8 Close Program
		4.3 Develop Program Infrastructure	4.5 Manage Program Resources	4.7 Manage Program Issues	
5. Program Scope Management	-	5.1 Plan Program scope	5.6 Manage Program Architecture	5.8 Monitor and Control Program Scope	-
		5.2 Define Program Goals and Objectives	5.7 Manage Component Interfaces		
		5.3 Develop Program Requirements			
		5.4 Develop Program Architecture			
		5.5 Develop Program WBS			
6. Program Time Management	-	6.1 Develop Program Schedule	-	6.6 Control Schedule	-
7. Program Cost Management	-	-	-	-	-
8. Program Quality Management	-	-	-	-	-
9. Program Human Resource Management	-	-	-	-	-
10. Program Communications Management	-	10.1 Plan Communications	10.2 Distribute Information	10.3 Report Program Performance	-
11. Program Risk Management	-	11.1 Plan Program Risk Management	-	11.5 Monitor and Control Program Risks	-
		11.2 Identify Program Risks			
		11.3 Analyse Program Risk			
		11.4 Plan Program Risk Responses			
12. Program- Procurement Management	-	12.1 Plan Program Procurements	12.2 Conduct Program- Procurements	12.3 Administer Program- Procurements	12.4 Close Program- Procurements
13. Program- Financial Management	13.1 Establish Program Financial Framework	13.2 Develop Program Financial Plan	-	13.5 Monitor and Control Program Financials	-
		13.3 Estimate Program Costs			
		13.4 Budget Program Costs			
14. Program- Stakeholder Management	-	14.1 Plan Program- Stakeholder Management	14.3 Engage Program- Stakeholders	14.4 Manage Program- Stakeholder Expectations	-
		14.2 Identify Program- Stakeholders			
15. Program Governance	-	15.1 Plan and Establish Program Governance Structure	15.4 Approve Component Installation	15.5 Provide Governance Oversight	15.8 Approve Component Transition
		15.2 Plan for Audit		15.6 Manage Program Benefits	
		15.3 Plan Program Quality		15.7 Monitor and Control Program Changes	



Project Management Development – Practice and Perspectives

First International Scientific Conference on Project Management in the Baltic Countries

February 8-9, 2012, Riga, University of Latvia

The following table shows the corresponding overview in ISO 21500. There are additional knowledge areas for stakeholder management and communication, and the knowledge area for resources extends the knowledge area of human resource management in PMBOK.[®] Regarding the boxes we meet gaps as in PMBOK.[®]

Table 3

ISO 21500 Project Management Process Groups and Knowledge Areas [4]

Subject Groups	Process Groups				
	Initiating	Planning	Implementing	Controlling	Closing
Integration	Develop Project Charter	Develop Project Plans	Direct Project Work	Control Project Work	Close Project or Phase Collect Lessons-Learned
				Control Changes	
Stakeholder	Identify-Stakeholders	-	Manage Stakeholders	-	-
Scope	-	Define Scope	-	ControlScope	-
		Create WBS			
		Define Activities			
Resources	Establish Project Team	Estimate Resources	Develop Project Team	Control Resources	-
		Define Project Organization		Manage Project Team	
Time	-	Sequence Activities	-	Control Schedule	-
		Estimate Activity Durations			
		Develop Schedule			
Cost	-	Estimate Costs	-	Control Costs	-
		Develop Budget			
Risk	-	Identify Risks	Treat Risks	Control Risks	-
		Assess Risks			
Quality	-	Plan Quality	Perform Quality Assurance	Perform Quality Control	-
Procurement	-	Plan Procurement	Select Suppliers	Administer Contracts	-
Communication	-	Plan Communications	Distribute Information	Manage Communications	-

ISO 21500 is mainly as incomplete as PMBOK[®] and a corresponding new ISO standard on program and portfolio management is missing. And the PMI[®] Guide on Program Management is not strong enough to support project management in many aspects.

Compared to these situation OGC standards are better. The integration of portfolio, program and project management is much stronger here – as shown in the P3O approach for example. [13]

Derived from the OGC approach the following table shows components of an integrated project, program and portfolio management. Human resource management for example we need at all levels – on the portfolio level we need strategic human resource management – on the project level we must install and develop human resources according to the HR strategies.

We need integrated information, knowledge, and communication management on all levels – there must be a transfer of lessons learned beyond projects. We need a well-developed communication and information culture in an organization as a backbone for project management. We need an integrated quality management for projects based upon strategic



quality management and management responsibility and management commitment as mentioned above – core issues of ISO 10006.

We must integrate environmental management and social responsibility in project management. That cannot be done only at the project level – the mission statements of an organization on social responsibility and environmental protection are the starting points that shape project management.

And finally most aspects of organizational development and change management must integrate project, program, and portfolio management.

Table 4

Components of an integrated project, program and portfolio management developed by the authors based upon [13]

Project	Develop, Manage, and Change Organization	Information & Knowledge & Communication Management	Risk Management	Strategic Risk Management	Human Resource Management	Quality Management	Strategic Quality Management	Social Responsibility Environmental Management					
				Management of Risks in Projects			Install and develop Human Resources		Quality Management in Projects				
				Manage Changes			Manage Human Resources		Quality Control				
			Program										
Portfolio													

The integration can be supported by object role modeling as discussed in [14], [16], [17].

3. Conclusion

Today standards in project management are incomplete, fuzzy and mostly isolated.

Standards in project management must be closely linked to program and portfolio management. Finally a full integration of portfolio, program, and project management standards is the best solution.

Standards in project management must integrate standards like ISO 14000, ISO 26000, ISO31000, and others.



Project Management Development – Practice and Perspectives

First International Scientific Conference on Project Management in the Baltic Countries
February 8-9, 2012, Riga, University of Latvia

Strong concepts and methods like object role modeling can support the development of an integrated project management.

References

1. ISO 10006 – Guidelines for Quality Management in Projects.
2. ISO 9000 – Quality Management Systems.
3. PMI: Project Management Body of Knowledge – PMBOK, 4th edition 2008.
4. ISO 21500 – Guidance on Project Management.
5. ISO 31000 – Risk Management – Principles and Guidelines.
6. ISO 26000 – Social Responsibility.
7. IFRS – International Financial Reporting Standards – www.ifrs.org.
8. <http://www.pmi.org>.
9. http://www.iso.org/iso/iso_catalogue/catalogue_tc/catalogue_detail.htm?csnumber=36643.
10. <http://www.bia.ca/articles/pj-combining-iso-10006-pmbok-to-ensure-successful-projects.htm>.
11. http://www.best-management-practice.com/gempdf/MoP_Brochure.pdf.
12. PMI: The Standard for Program Management, 2nd edition 2008.
13. http://www.best-management-practice.com/gempdf/P3O_Appendix_D_Version_1_2009.pdf.
14. Reusch, Peter J. A.: New Standards for Project Audit and the Impact on Existing Standards for Project Management, Intelligent Data Acquisition and Advanced Computing Systems – IEEE-IDAACS 2011, Prague. <http://www.idaacs.net/>.
15. Löhr, Katrin; Khan, Rao Aamir: Project Finance – On New Standards for Process in Project and Program Management, Intelligent Data Acquisition and Advanced Computing Systems – IEEE-IDAACS 2011, Prague. <http://www.idaacs.net/>.
16. Reusch, Peter J. A.; Khushnood, Muhammad; Khan, Rao Aamir; Aslam, Sohail: After the Crisis we need Social Project Management, International Business Research Conference – University of Northern Florida UNF, Jacksonville 2010.
17. Reusch, Peter J. A.; Khushnood, Muhammad; Otegi, José Ramon: An Object Role Oriented Project Management Approach, First International Scientific Conference on Project Management in the Baltic Countries, Riga 2012.

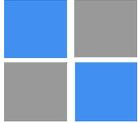

PROJECT FOREIGN EXCHANGE RISK MANAGEMENT IN ENTERPRISES: THE CASE OF THE BALTIC STATES

Ramona Rupeika-Apoga

University of Latvia

Aspazijas bulv. 5, Riga, LV-1050, Latvia

Phone: +371 6703462

E-mail: ramona.rupeika-apoga@lu.lv

Irina Solovjova

University of Latvia

Aspazijas bulv. 5, Riga, LV-1050, Latvia

Phone: +371 67034638

E-mail: irina.solovjova@lu.lv

Keywords: foreign exchange risk, risk measuring and exposure, hedging strategies and project management

Abstract

The first step in project risk management is to identify the risks that are present in your project with following risk measurement and management. This paper deals with special risk: foreign exchange risk management. The world financial crisis started in 2008 has again put on the agenda the question of foreign exchange risk management and not only at transnational companies, but also at smaller companies. The importance of managing foreign exchange risk has increased at the first stage, when company existence is only on the paper as a project, due to the instability all over the world. Risk management is especially actual nowadays, when the future of world dominant currencies: USD and EUR, GBP and JPY is under the question.

The **purpose** of this research is by analysing different issues relating to the measurement and management of foreign exchange risk exposure to define an approach to the management of foreign exchange risk in projects by emphasising the Baltic States case.

To achieve the purpose the following **tasks** were conducted:

1. Analysis of the theoretical aspects of the measuring and managing currency risk exposure.
2. Designing a hedging strategy for project managers.
3. Clarifying firm' attitudes towards foreign exchange risk management in the Baltic States.
4. Development of recommendation for an approach to the management of foreign exchange risk in projects.

During development of the paper the generally accepted qualitative and quantitative **methods of economic research** were used.

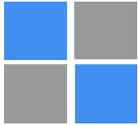

Introduction

Since mid-2007, currency markets have become more volatile due to the financial crisis in 2008 and the euro crisis in 2011. The collapse and breakup of the euro is now a serious possibility. If it happens, it will almost certainly be followed by explosive currency devaluations in most of the euro zone, followed by huge pressure on governments to introduce protective tariffs and the effective end of the single European market, one of the greatest achievements of post-war Europe. Generally, risk contribution from unhedged currency exposures will be higher than it has been in the past. For this reason, currency risk management may be more of a priority than ever. That is why as firms as financial institutions have tended to take a more proactive approach to the management of foreign exchange positions in recent years by separately identifying and managing currency exposures, starting already from project risk management. This partly reflects a trend towards greater diversification of underlying asset positions across international markets. This is essentially because unmanaged currency exposure has a zero expected return in the long term but adds volatility to reported returns in the meantime, however, many companies do not seek to manage currency risk at all.

Project risk management is a complicated and difficult task. Varieties of hedging techniques are available, but before a firm use them:

- 1) It must decide on which exposures to manage.
- 2) If foreign exchange risks are to be managed, they must first be quantified.
- 3) Once the firm has determined the exposure position it intends to manage, how should it manage that position?

The **object** of this paper is project foreign exchange risk management.

The **purpose** of this research is by analysing different issues relating to the measurement and management of foreign exchange risk exposure to define an approach to the management of foreign exchange risk in projects by emphasising the Baltic States case.

To achieve the purpose the following **tasks** were conducted:

1. Analysis of the theoretical aspects of the measuring and managing currency risk exposure.
2. Designing a hedging strategy for project managers.
3. Clarifying firm' attitudes towards foreign exchange risk management in the Baltic States.
4. Development of recommendation for an approach to the management of foreign exchange risk in projects.

Chapter1 explores issues relating to the identification, measuring and managing currency risk exposure, by examining the general concept of exposure and by designating the management strategy. Chapter 2 explores firms' attitudes towards foreign exchange risk management during last year's and future tendencies in the Baltic States, by developing an approach to the management of foreign exchange risk in projects.

During development of the paper the generally accepted qualitative and quantitative **methods of economic research** were used.

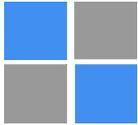

1. Exchange Rate Risk

1.1. Necessity of Foreign Exchange Exposure Management

Many firms refrain from active management of their foreign exchange exposure, even though they understand that exchange rate fluctuations can affect their earnings and value. They make this decision for a number of reasons:

1. Firms' managers do not understand why and how to manage foreign exchange exposure, considering financial derivatives as speculative or they argue that such financial manipulations lie outside the firm's field of expertise.
2. Impossibility of measurement, considering currency exposure management too complex.
3. Considering that netting is enough a hedge for a firm, by covering imports or exports transactions, and foreign subsidiaries finance in local currencies.
4. Denying any exchange risk because it does all its business in home currency.

All mentioned reasons could be counter – argued. In its broadest sense, *foreign exchange risk* refers to events abroad that affect the net income of a domestic firm. These could include, for example, a recession in a foreign market that adversely affects sales of domestic vendors to foreign buyers. Such a recession can affect not only the domestic vendor, but also the vendor's suppliers who may operate only in the domestic economy. In this sense, foreign exchange risk can affect nearly all firms in a global economy. Taking into account that foreign exchange market activity became more global, with cross-border transactions representing 65% of trading activity in April 2010, while local transactions account for 35%, risk management question become more actual. The percentage share of the US dollar has continued its slow decline witnessed since the April 2001 survey, while the euro and the Japanese yen gained relative to April 2007. Among the 10 most actively traded currencies, the Australian and Canadian dollars both increased market share, while the pound sterling lost ground and the Swiss franc declined marginally. The market share of emerging market currencies increased, with the biggest gains for the Turkish lira and the Korean won. [5]

The general concept of exposure refers to the degree to which a firm is affected by exchange rate changes. The impact can be measured in several ways, by using:

- Accounting approach;
- Economic approach.

The three basic types of exposure are:

- Accounting exposure;
 - Operating exposure;
 - Transaction exposure
- } Economic exposure

Accounting exposure (Translation) – changes in the book value of balance sheet assets and liabilities and income statement items that are caused by an exchange rate change.

Exchange rate change occurs impacts balance sheet assets and liabilities and income statement items that already exist. The measurement of accounting exposure is retrospective in nature as it based on activities that occurred in the past.

Results: Paper only.

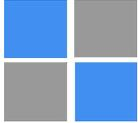

Operating exposure – changes in the amount of future operating cash flows (its future revenues and costs) caused by an exchange rate change.

Exchange rate change occurs impacts:

1. Revenues and costs associated with future sales.
2. Any company whose revenues or costs are affected by currency changes, even it is a purely domestic corporation and has all its cash flows denominated in home currency.

The measurement of operating exposure is prospective in nature as it is based on future activities.

Results:

- 1) Firm's future competitive position;
- 2) Real.

Transaction exposure – change in the value of outstanding foreign currency-denominated contracts that are caused by an exchange rate change.

Exchange rate change occurs impacts:

1. Contractually-binding future foreign currency-denominated cash inflows and outflows.
2. Contracts already entered into, but to be settled at a later date.

The measurement of transaction exposure is prospective in nature as it is based on future activities.

Results:

- 1) Firm's future competitive position.
- 2) Real.

Economic exposure is based on the extent to which the value of the firm – as measured by the present value of its expected future cash flows – will change when exchange rate change. Economic exposure can be separated into two components: transaction exposure and operating exposure.

Economic exposure can be separated into two components: transaction exposure and operating exposure. The firm faces operating exposure when it makes investments. These investments include new-product development, a distribution network, foreign supply contracts and so on. Transaction exposure arises later on and only if the firm's commitments lead it to engage in foreign currency-denominated sales or purchases. [3]

1.2. Hedging Strategy for Project Managers

An essential intergradient in any successful hedging project is for the firm to specify operational set of goals for those involved in exchange risk management. Failure to do so can lead to possibly conflicting and costly actions on the part of employees. Although many firms do have objectives, their goals are often sufficiently vague and simplistic as to provide little realistic guidance to managers. Often managers must challenge with dilemma of choosing between the goals of increased profits and reduced exchange losses. Moreover, reducing translation exposure could lead to an increase in transaction exposure and vice versa. What tradeoffs, if any, should a manager be willing to make between these two types of exposure?

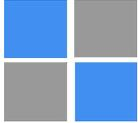

These and similar questions demonstrate the need for a coherent and effective strategy. The following elements are suggested for an effective exposure-management strategy:

1. Determine the types of exposure to be monitored.
2. Formulate corporate objectives and give guidance in resolving potential conflicts in objectives.
3. Ensure that these corporate objectives are consistent with maximising shareholder value and can be implemented.
4. Clearly specify who is responsible for which exposures, and detail the criteria by which each manager is to be judged.
5. Make explicit any constraints on the use of exposure-management techniques, such as limitations on entering into forward contracts.
6. Identify the channels by which exchange rate considerations are incorporated into operating decisions that will affect the firm's exchange risk posture.

Develop a system for monitoring and evaluating exchange risk management activities. (Most of the elements are suggested in Evans T. and Folks W. [1])

Objectives

The usefulness of a particular hedging strategy depends on both acceptability and quality. Acceptability refers to approval by those in the organization who will implement the strategy, and quality refers to the ability to provide better decisions. To be acceptable, a hedging strategy must be consistent with top management's values and overall corporate objectives. In turn, these values and objectives are strongly motivated by management's belief about financial markets and how its performance will be evaluated. The quality, or value to the shareholders, of a particular hedging strategy, therefore, related to the congruence between those perceptions and the realities of the business environment. [3]

The most frequently occurring objectives, explicit and implicit, in management behaviour include the following:

1. *Minimise translation exposure.* This common goal necessitates a complete focus on protecting foreign currency-denominated assets and liabilities from changes in value due to exchange rate fluctuations. Given that translation and transaction exposures are not synonymous, reducing the former could cause an increase in the latter (and vice versa).
2. *Minimise quarter-to-quarter (or year to year) earnings fluctuations owing to exchange rate changes.* This goal requires a firm to consider both its translation exposure and its transaction exposure.
3. *Minimise transaction exposure.* This objective involves managing a subset of the firm's true cash flow exposure.
4. *Minimise economic exposure.* To achieve this goal, a firm must ignore accounting earnings and concentrate on reducing cash flow fluctuations stemming from currency fluctuations.
5. *Minimise foreign exchange risk management costs.* This goal requires a firm to balance off the benefits of hedging with its costs. It also assumes risk neutrality.
6. *Avoid surprises.* This objective involves preventing large foreign exchange losses. [6]

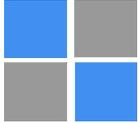

The most appropriate way to rank these objectives is on their consistency with the overarching goal of maximising shareholder value. To establish what hedging can do to further this goal, we must consider total risk. Total risk tends to adversely affect a firm's value by leading to lower sales and higher costs. Consequently, actions taken by a firm that decrease its total risk will improve its sales and cost outlooks, thereby increasing its expected cash flows.

Reducing total risk can also ensure that a firm will not run out of the cash to fund its planned investment program. Otherwise, potentially profitable investment opportunities may be passed up because of corporate reluctance to tap the financial markets when internally generated cash is insufficient. [2]

To the extent that earnings fluctuations or large losses can adversely affect the company's perceptions in the minds of potential investors, customers, employees, and so on, there may be reason to also pay attention to Objectives 2 and 6. However, despite these potential benefits, there are likely to be few, if any, advantages to devoting substantial resources to managing earnings fluctuations or accounting exposure more generally (Objectives 1 and 3). To begin, trying to manage accounting exposure is inconsistent with a large body of empirical evidence that investors have the uncanny ability to peer beyond the ephemeral and concentrate on the firm's true cash flow generating ability. In addition, whereas hedging can dampen balance sheet gains and losses, operating earnings will also fluctuate in line with the combined and offsetting effects of currency changes and inflation. Further, hedging costs themselves will vary unpredictably from one period to the next, leading to unpredictable earnings changes. Thus, it is impossible for firms to protect themselves from earnings fluctuations due to exchange rate changes except in the very short run.

In the next chapter the authors consider firms' attitudes towards foreign exchange risk management during last year's and future tendencies in the Baltic States.

2. Companies' Attitudes towards Foreign Exchange Risk Management in the Baltic States

From 1999 (by the introduction of the euro) most firms have adopted a more conservative/less dynamic approach to foreign exchange risk management. A number of the firms' treasurers interviewed by the ESCB study group (The study of the Market Operations Committee (MOC) of the ESCB was conducted by a working group involving representatives from the ECB and from NCB's) reported that their firms' senior management was increasingly risk-averse. [4] They have clearly refocused on the firms' core business, while their propensity for market risk has declined substantially. In the next table the authors analyse the Baltic States companies' sensitivity to the foreign exchange risk and risk management concepts in these companies, by analysing annual reports, NASDAQ OMX RIGA stock exchange information, and interviews with companies' managers and unpublished information.

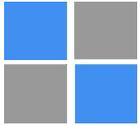
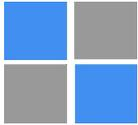

Table 1

Baltic States companies' sensitivity to the foreign exchange risk and risk management concepts in these companies [7-38]

Company	Country	Sensitivity to the foreign Exchange risk	Risk management explanation in concert with the annual reports of the companies
AS Silvano Fashion Group	Estonia	The group is exposed to Exchange rate risk rising from revenues and operating in the EUR, LVL, LTL, RUR, BYR.	The group does not use derivatives for hedging the risk.
Tallink grupp	Estonia	The group is exposed to Exchange rate risk rising from revenues and operating in the US dollar(USD), Swedish crown (SEK) and Latvian lats (LVL). Exposure to USD results from the purchase of ship fuel and insurance and exposure to SEK and LVL arises from the fact as these are the operational currencies on some routes.	Tallink seeks to minimize <u>currency risk by using derivative instruments</u> (currency forward contracts and currency swaps), and matching foreign currency inflows with outflows.
Tallinna Kaubamaja	Estonia	To manage foreign currency risk of the Group, most of the contracts are denominated in EUR. The Group does not have any financial assets and liabilities in currencies that are not tied to the euro. All important long-term loan agreements have been concluded in Euros; therefore they are treated as liabilities free of foreign currency risk.	The Group estimates that the risks arising from changes in the foreign currency risk and the need to manage foreign currency risks to be minimal.
AS Tallinna Vesi	Estonia	Most of Company's international purchases are made in Euros and the proportion of purchases in other currencies in less than 1%.	Because of the small proportion of purchases in other currencies Company considered is unnecessary to undertake special activities to minimize this currency risk.
TEO LT	Lithuania	The Group operates internationally and is exposed to foreign exchange risk arising from various currency exposures, primarily with respect to Euro (EUR), US Dollar (USD) and Special Drawing Rights (XDR). Foreign exchange risk arises from future commercial transactions, recognised assets and liabilities.	The Group manages foreign exchange risk by minimising the net exposure to open foreign currency position. Substantially all the Group's trade payables and trade receivables are short-term and in addition revenues and expenses in foreign currencies are insignificant as compared to those in Lithuanian Litas.
Trigon Property Development		Group's assets and liabilities are nominated in Euros.	The group does not use derivatives for hedging the risk.



Project Management Development – Practice and Perspectives

First International Scientific Conference on Project Management in the Baltic Countries

February 8-9, 2012, Riga, University of Latvia

Company	Country	Sensitivity to the foreign Exchange risk	Risk management explanation in concert with the annual reports of the companies
Ūkio bankas	Lithuania	Group's assets and liabilities are nominated in USD and UAH.	To manage currency risks, the Group uses a system of limits imposed on individual positions and portfolios.
Utenos Trikotažas	Lithuania	The Group has subsidiary office in Ukraine.UAH strengthening/weakening by 10 per cent against EUR would increase/reduce the Group's net loss by LTL 2.000. thousand (2009)	Foreign Exchange risk for the Company's activity is reduced by matching sales transactions and accounts receivable dominated in Euros to purchase transactions, accounts payable and borrowings denominated in euro.
Viisnurk	Estonia	Group's assets and liabilities are nominated in EUR, SEK, LVL and UAH.	Currency exchange risk is low because most of the contracts have been concluded in euros.
Vilkyškiu pienine	Lithuania	The main part of the Company's transactions is denominated in LTL and EUR.	Foreign exchange risk is insignificant.
Vilniaus baldai	Lithuania	The main part of the Company's transactions is denominated in LTL and EUR.	Foreign exchange risk is insignificant.
Šiaulių bankas	Lithuania	The presumable FX rate change creates impact on the Bank's annual profit and makes LTL 91 thousand (2009)	The Group and the Bank monitors the foreign currency risk by calculating open currency position. Group's net open position in 2009 was – 0.31%.
Sanitas	Lithuania	Total impact on net profit by expected LTL/PLN rate fluctuation +/-10%, PLN/USD rate fluctuation +/-10%, PLN/EUR +/-10% is 17100 LTL (2009)	The Group and the Company seeks to mitigate the effect of its structural currency exposure by keeping the assets and the liabilities denominated in the same currency, which is the functional currency for each individual entity.
SF Tehnika AS	Latvia	The Group operates internationally and is exposed to foreign currency risk mainly arising from U.S. dollar fluctuations.	To manage the foreign currency risk arising from future commercial transactions and recognised assets and liabilities, the Group uses forward foreign currency contracts.
Rytu skirstomieji tinklai	Lithuania	All monetary assets and liabilities of the Group and the Company are denominated in LTL or EUR, therefore, the Group and the Company practically is not exposed to the foreign exchange rate risk.	The Group and the Company do not use hedging strategies



Project Management Development – Practice and Perspectives

First International Scientific Conference on Project Management in the Baltic Countries

February 8-9, 2012, Riga, University of Latvia

Company	Country	Sensitivity to the foreign Exchange risk	Risk management explanation in concert with the annual reports of the companies
Rokiškio sūris	Lithuania	The Company operates internationally, however, their exposure to foreign exchange risk is set at minimum level, and sales outside Lithuania are performed mostly in EUR.	Foreign exchange risk is insignificant.
Premia Foods AS	Estonia	The Group tries to avoid large open foreign exchange positions. The main used currencies are LTL, LVL, SEK and EUR. The company is most open to the exchange rate fluctuations of SEK and LVL.	The Group has not used any financial instruments to secure against the foreign-exchange risks that may arise from the business transactions and assets and liabilities in the future. The Group does not have significant foreign exchange risks.
Pieno žvaigždės	Lithuania	All monetary assets and liabilities of the Group and the Company are denominated in LTL or EUR.	Currency exchange risk is low.
Panevėžio statibos trestas	Lithuania	All monetary assets and liabilities of the Group and the Company are denominated in LTL or EUR.	The Group does not use any financial instruments to manage its exposure to foreign Exchange risk.
Olainfarm	Latvia	The Company operates internationally in USD and EUR. The company is most open to the exchange rate fluctuations of USD.	The Company doesn't have Foreign currency Management Policy.
Nordecon International AS	Estonia	The bulk of the Group's operations is conducted in Estonia and the financial instruments of the Group's Estonian entities are denominated in EUR.	The Group does not use any financial instruments to manage its exposure to foreign Exchange risk.
Merko Ehitus	Estonia	In case of simultaneous devaluation of all national currencies by 25%, the group would have additional finance income of EEK 13 472 thousand, including finance income of EEK 115 311 on the position of EEK, and costs of EEK 84 211 thousand on the position of LVL and EEK 17 828 thousand on the position of LTL (2009)	In order to eliminate foreign exchange risk, the proportions of assets and liabilities denominated in different currencies are monitored and key foreign contracts and long-term loan agreements are preferentially concluded in EUR.
Lietuvos dujos	Lithuania	All monetary assets and liabilities of the Group and the Company are denominated in LTL or EUR.	The Group does not use any financial instruments to manage its exposure to foreign Exchange risk.
Invalda	Lithuania	The Group and the Company do not apply any financial means allowing to hedge foreign currency risks, because these risks can be considered as insignificant.	The Group's and the Company's policy is related to matching of money inflows from the most probable potential sales with purchases by each foreign currency.

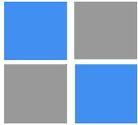

Project Management Development – Practice and Perspectives

First International Scientific Conference on Project Management in the Baltic Countries

February 8-9, 2012, Riga, University of Latvia

Company	Country	Sensitivity to the foreign Exchange risk	Risk management explanation in concert with the annual reports of the companies
Harju elekter	Estonia	The Group operates in EUR and LTL.	All existing long-term loan and finance lease contracts have been made in EUR or the functional currency of the relevant Group company.
Grindeks	Latvia	The Company faces foreign currency risk on contracts that are denominated in RUB.	The Company does not use any financial instruments to manage its exposure to foreign Exchange risk.
Grigiškes	Lithuania	The Group faces foreign currency risk on purchases and borrowings that are denominated in currencies other than Litas and EUR.	The Group does not use any financial instruments to manage its exposure to foreign Exchange risk.
Express grupp	Estonia	The groups settlements in significant amounts are made in EUR, a smaller extent in Russian roubles, SEK, LTL and LVL, and in insignificant amounts in UAH.	The group does not have any significant amounts exposed to foreign exchange risk. The group does not use derivatives for hedging the risk.
Arco Vara	Estonia	The Group mostly operates in EUR.	Currency risks are hedged by performing most transactions and signing most agreements and contracts in EUR or currencies pegged to the euro.
City service	Lithuania	The Company's monetary assets and liabilities are denominated in LTL or EUR, consequently the management of the Company believes that foreign exchange risk on EUR is insignificant. Total impact on net profit by expected EUR rate fluctuation +/-15% will be 1835 LTL in 2009.	No instruments were used to hedge foreign currency risks.
Apranga	Lithuania	The Group operates in Lithuania, Latvia and Estonia and accordingly has two functional currencies that all are pegged to EUR and do not fluctuate significantly.	The Group has a policy to synchronize the cash flows from expected sales in the future with the expected purchases and other expenses in each foreign currency.

The analysis of the Baltic companies' foreign exchange risk exposure management practice shows that our companies are more passive than active. Foreign exchange risk can be managed either passively or actively:

- Passive hedging programs systematically remove a pre-determined proportion of currency risk (e.g., 50%, 75% or 100%).
- Active hedging programs are designed to manage currency risk in order to add value to the overall portfolio. The active currency hedge manager actively increases the

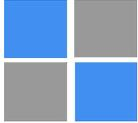

hedge ratio applied to currencies that are expected to depreciate, thus protecting the investor from exposure to depreciating foreign currencies; and actively reduces the hedge ratio applied to currencies that are expected to appreciate, allowing the investor to benefit from exposure to those currencies.

Firms' analysis highlighted that generally managers in our countries do not seek to manage currency risk at all.

Main reasons not to hedge foreign exchange exposure are:

1. Insignificance of foreign exchange risk, due to the assets and liabilities denomination in EUR or currencies hardly pegged to the euro; therefore they are treated as items free of foreign currency risk.
2. The cost of implementing a currency hedge (transaction costs + interest rate differential between currencies) may be too expensive versus the expected risk contribution from unhedged currency risk.
3. The risk contribution from unhedged currency exposure is relatively low.
4. The manager is unable to meet potential negative cash flows which may result from the currency hedge.
5. The manager has a well-informed and strong conviction that the foreign currencies to which he has exposure will appreciate versus his base currency.

Bigger companies are not using active risk management mostly due to the first three reasons and smaller ones mostly because of the lack of knowledge how to manage risk at all.

The authors analysed more than 30 Baltic companies and only two of them use external methods of risk management, while the majority of companies prefer internal methods.

The main hedging strategies in our companies are following:

1. To sign contracts in EUR or other currencies hardly pegged to the euro.
2. To match assets and liabilities in EUR or currencies hardly pegged to the euro.
3. To net open foreign currency positions in currencies other than EUR, for example USD, UAH.
4. To limit open positions.

Conclusions

- I. The first step in project risk management is to acknowledge that such risk does exist and that managing it is in the interest of the firm and its shareholders. The next step, however, is much more difficult: the identification of the nature and magnitude of foreign exchange exposure. In other words, identifying what is at risk, and in what way.

Determine the types of exposure to be monitored

- II. The second step in project risk management is to measure potential foreign exchange exposure: to calculate possible losses from unhedged positions. A lot of Baltic companies are not using active risk management due to the impossibility of measurement, considering currency exposure management too complex. Unfortunately, this is true as in small companies as in bigger ones. In reality, risk measurement is not so complicated task, as companies could use as qualitative (the risk matrix) as quantitative (VAR) analyses and to use consulting firms at the last.

Measurement of foreign exchange exposure

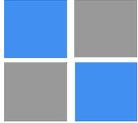

III. The third step in project risk management is to use effective methods of exposure management. It is necessary clearly specify who will be responsible for which exposures, and detail the criteria by which each manager is to be judged.

Many Baltic companies' refrain from active management of their foreign exchange exposure, even though they understand that exchange rate fluctuations can affect their earnings and value. They make this decision for a number of reasons:

1. Insignificance of foreign exchange risk, due to the assets and liabilities denomination in EUR or currencies hardly pegged to the euro; therefore they are treated as items free of foreign currency risk.
2. Companies' managers do not understand why and how to manage foreign exchange exposure, considering financial derivatives as speculative or they argue that such financial manipulations lie outside the firm's field of expertise (mostly in the smaller one companies, especially operating in local markets).
3. Denying any exchange risk because it does all its business in home currency.
4. Considering that netting is enough a hedge for a firm, by covering imports or exports transactions, and foreign subsidiaries finance in local currencies (the most popular).

For effective risk management project risk managers need to:

- Make explicit any constraints on the use of exposure-management techniques, such as limitations on entering into forward contracts.
- Identify the channels by which exchange rate considerations are incorporated into operating decisions that will affect the firm's exchange risk posture.

Management of foreign exchange exposure

References

1. Evans, T., Folks W. Defining Objectives for Exposure Management, *Business International Money Report*, February 2, 1979.
2. Froot K., Scharfstein, D. and Stein J. A Framework for Risk Management, *Journal of Applied Corporate Finance* 7, no. 3, 1994, pp. 22-32.
3. Rupeika-Apoga R., Kudinska M. Innovative approach to foreign exchange risk management, Innovation Driven Entrepreneurship, ISM University of Management and Economics, Vilnius, Lithuania, 2010, p. 11.
4. *Review of the Foreign Exchange Market Structure*, European Central Bank, 2003, source available at: <http://www.ecb.int/pub/pdf/other/fxmarketstructure200303en.pdf>.
5. Triennial Central Bank Survey of Foreign Exchange and Derivatives Market Activity in April 2010, Preliminary global results, Bank for International Settlements, Press & Communications CH-4002 Basel, Switzerland, September 2010.
6. Zenoff, D. *Applying management principles to Foreign Exchange Exposure*, Euromoney, September 1978.
7. Annual reports of AS Silvano Fashion Group, 2008, 2009, 2010.
8. Annual reports of Tallink grupp, 2008, 2009, 2010.
9. Annual reports of Tallinna Kaubamaja, 2008, 2009, 2010.
10. Annual reports of AS Tallinna Vesi, 2008, 2009, 2010.
11. Annual reports of TEO LT, 2008, 2009, 2010.
12. Annual reports of Trigon Property Development, 2008, 2009, 2010.
13. Annual reports of Ūkio bankas, 2008, 2009, 2010.
14. Annual reports of Utenos Trikotāžas, 2008, 2009.

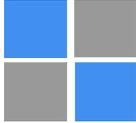

Project Management Development – Practice and Perspectives

First International Scientific Conference on Project Management in the Baltic Countries

February 8-9, 2012, Riga, University of Latvia

15. Annual reports of Viisnurk, 2008, 2009, 2010.
16. Annual reports of Vilkyškiu pienine, 2008, 2009, 2010.
17. Annual reports of Vilniaus baldai, 2008, 2009, 2010.
18. Annual reports of Šiaulių bankas, 2008, 2009.
19. Annual reports of Sanitas, 2008, 2009.
20. Annual reports of SF Tehnika AS, 2008, 2009, 2010.
21. Annual reports of Rytu skirstomieji tinklai, 2008, 2009, 2010.
22. Annual reports of Rokiškio sūris, 2008, 2009, 2010.
23. Annual reports of Premia Foods AS, 2008, 2009, 2010.
24. Annual reports of Pieno žvaigždės, 2008, 2009, 2010.
25. Annual reports of Panevežio statybos trestas, 2008, 2009, 2010.
26. Annual reports of Olainfarm, 2008, 2009, 2010.
27. Annual reports of Nordecon International AS, 2008, 2009, 2010.
28. Annual reports of Merko Ehitus, 2008, 2009.
29. Annual reports of Lietuvos dujos, 2008, 2009, 2010.
30. Annual reports of Invalda, 2008, 2009.
31. Annual reports of Harju elekter, 2008, 2009, 2010.
32. Annual reports of Grindeks, 2008, 2009, 2010.
33. Annual reports of Grigiškes, 2008, 2009, 2010.
34. Annual reports of Express grupp, 2008, 2009, 2010.
35. Annual reports of Arco Vara, 2008, 2009, 2010.
36. Annual reports of City service, 2008, 2009, 2010.
37. Annual reports of Apranga, 2008, 2009, 2010.



EVALUATION OF REGIONAL DEVELOPMENT FINANCIAL INSTRUMENTS FUNDED PROJECT MANAGEMENT

*MSc.proj.mgmt. **Emīls Pūlmanis**
State Regional Development Agency
Elizabetes iela 19, Riga, LV-1050, Latvia
E-mail: Emils.Pulmanis@gmail.com*

Keywords: Project management, project implementation, EU funds

Abstract

In an open global economy, competitiveness lies in the capacity of businesses to create high value added goods and services. A move towards innovation-based sustainable growth is therefore at the heart of the EU's response to globalization. In addition to strong financial support, the state must assume responsibility for the efficient administration of financial resources, including quality of program and project definition and validation. In the frame of EU funding in the Latvia government has adapted new laws and created institutions that oversee these funds for reaching the objective. In the paper author has analysed the EU funded project practical implementation problems and provide suggestions for project implementation process improvement.

Introduction

Recipients of funding – both public authorities, public institutions and businesses, is a major challenge for financial gain and to promote public welfare. However, the benefits bring with them the responsibility for waste and financial records and reports on practical goals. Funding Administration requires thorough knowledge and understanding of the law. A growing number of mass media and the administration of financial instruments institutional statements we hear that a large number of project applications, which is a low quality place. Now that the errors and weaknesses in project development and administration are unacceptable, more and more to think of an effective system that would be according to the conventional project management theory. Such a system would be built at local level, ensuring appropriate project specialist, but the program level, i.e. need to improve the administration of financial instruments including methodical and regulatory documents update and synchronize project management theory to improve the project initiation process and ensure the quality of project applications development, thus resulting in an effective and rational use of taxpayers' money.

By supply a certain funding available to identified target groups in a fair competition is meant (like, for example, via grant schemes). Such supply would have a number of requirements posed on its disbursement in a form of guidelines and other instructions ensuring that certain goals set by the donor organization are achieved. At the same time the funding organization has to make sure that the requirements are realistic and appropriate to the capacities of the target groups.

By demand an interest of potential beneficiaries in putting forward their projects as responding to the calls for proposals is understood. This can be estimated both by the quality as



well as the number of the projects received. The quality of the projects proposed would lead to achievement of the goals, whereas their number would indicate at whether the supply side has taken account of the expectations and capacities of the demand side.

The Concept of Project

Would it be development of a program for intervention as a whole or a single project the point of reference is the project. It can be defined as a unique activity/measure performed to create a unique product or service. It is a unique activity/measure since it has a certain beginning and certain ending. The products or services created by the project are unique in a sense that they are different from any other products or services delivered elsewhere.

At the same time program is a set of projects anticipated to achieve certain program specific goals. From that respect program as such could also be seen and analysed from the project cycle management aspects as a project that is of another scale than the project.

The project might involve from one to thousands of persons and can last from just a few hours to several years. It can involve from a single unit of one organization to a number of organizations world-wide.

Beginning and end are one of the characteristics of the project that allows segregating it from the regular activities whether in professional or private life. Thus we can speak about the project life is a time span from the project idea to its finalization. During the project life its activities and consumption of necessary resources might become very intense at certain times. The peak time is usually the implementation phase. This allows for further dividing the project life into certain periods altogether referred as a project life cycle.

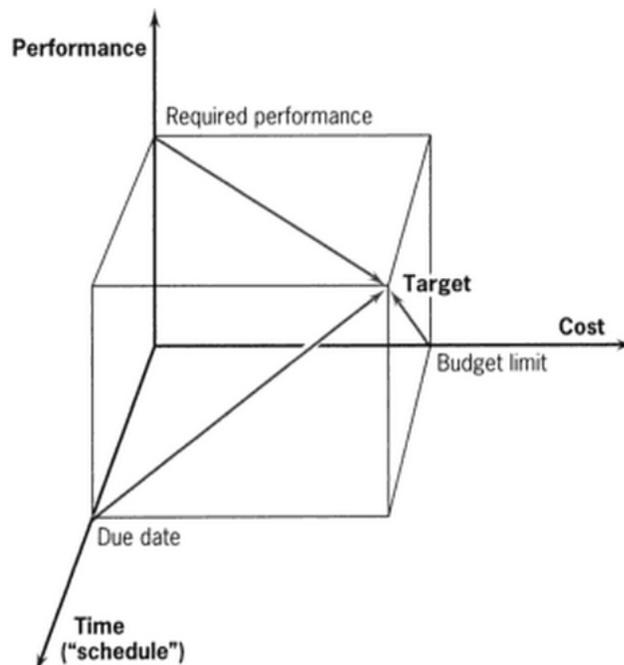

Figure 1. Project scope. Direct project goals – time, cost, performance [1]



The basic parameters characterizing the project are: *time*, *resources* and *quality*. Shenkar, Levy, and Dvir (1997) have concluded that project successes have four dimensions (see Figure 1) [1].

Project Cycle Management (PCM) is an important point of exit for planning both programs and projects. The session covers the aspects of PCM that are common for both as well as that are different. Patel and Morris have stated that "The life cycle is the only thing that uniquely distinguishes projects from non-projects" [2]. PCM is a participatory approach which enables stakeholders to undertake joint and transparent planning, decision taking and control of a project as well as a program as a whole.

The method provides for:

- systematic analysis of the situation in which the intervention is to occur, to provide an understanding of the context and the inter-relationships involved;
- transparent identification and assessment of alternative measures, leading to the selection of the preferred interventions;
- scheduling of measures and the provision of the necessary resources leading to the attainment of the intended objectives.

Provided it is applied flexibly and on the basis of genuine participation, this planning method can provide a framework within which to achieve:

- active involvement of stakeholders through team working and a clearly structured and transparent cycle of consensus building and decision taking;
- identification of significant factors and rational allocation of responsibilities, leading to realistic planning, accountability, ownership and sustainability;
- tools for feedback through monitoring and evaluation. It is hence dynamic, adjustable, and capable of steering a project to a successful conclusion in changing circumstances.

The method provides tools for four stages of the project development and implementation cycle:

- Analysis (sectors, participants, problems)
- Decision taking (analysis of alternatives, decision taking)
- Planning synthesis (Project Planning Matrix)
- Implementation (Plan of Operations)

PCM principles:

- Project cycle stages – structural decision making, based on sufficient information
- Client – oriented approach – involvement of stakeholders in the decision making process
- Logical approach to planning – comprehensive and integrated analysis
- Sustainability – a mechanism to ensure a lasting positive impact
- Integrated approach – vertical integration and standardized documentation



The main documents in the PCM are [3]:

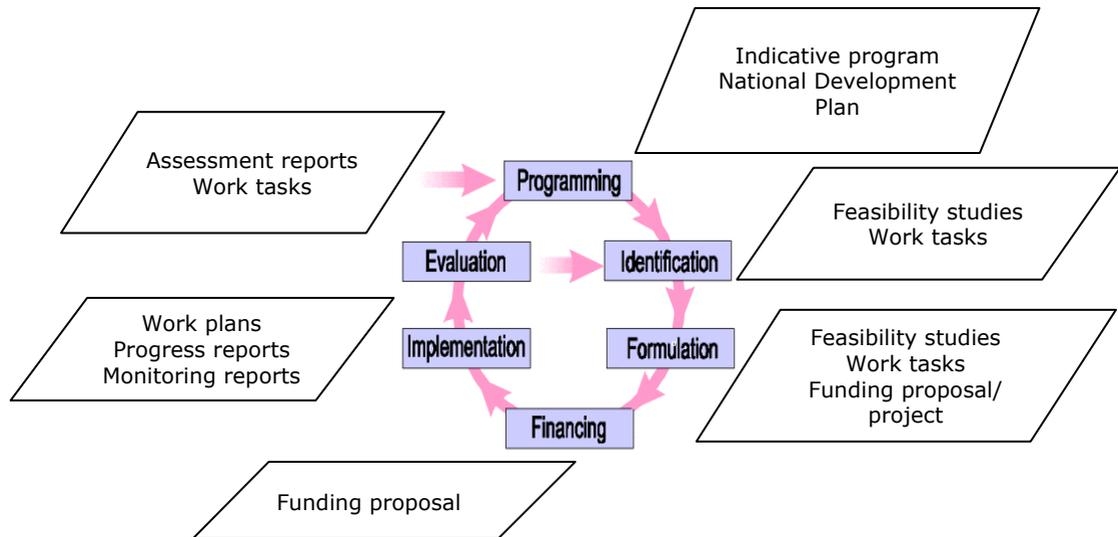

Figure 2. EU funded project life cycle [3]

Programming Period 2007-2013

Latvia as the Member State of the European Union (EU) implementing the EU regional policy uses financial assistance provided by the EU for economic and social development. Largest financial instruments within the framework of which Latvia receives financial assistance are the EU funds: European Regional Development Fund (ERDF), European Social Fund (ESF) and Cohesion Fund (CF), the management of which in Latvia is ensured by the Ministry of Finance. In addition, Latvia also receives financial resources within the framework of the European Community initiatives EQUAL and INTERREG, as well as other EU financed programmes. In the programming period 2007-2013 the assistance to agriculture and fisheries sectors is coordinated by the Ministry of Agriculture by means of administrating European Agricultural Guidance and Guarantee Fund (EAGGF) and European Agricultural Fund for Rural Development (EAFRD). According to the decision of the Council of the EU on long-term financial framework for 2007-2013, Latvia has received EUR 4.53 billion (EUR 4'530'447'634) for achievement of Cohesion Policy² goals through acquisition of the EU funds (ERDF, ESF and CF) [4].

The capacity of member states and their regions to absorb such large-scale transfers in a productive way is in fact an issue occasionally investigated and questioned. Different evaluation studies and reports have been prepared and published by the European Commission or by consultants working in charge of the Commission that focus on the question whether the main goal of EU structural policy – economic and social cohesion, real convergence between Member States and their regions – is taking place at all.



Project Management Development – Practice and Perspectives

First International Scientific Conference on Project Management in the Baltic Countries
February 8-9, 2012, Riga, University of Latvia

Absorption problem is usually defined as the case when any recipient country/ region fails to achieve 100 percent of its target value programmed *a priori*. That means the administrative capability of a country or a region to deliver and implement the given operational program is not perfect. Certainly, this approach is strictly input-oriented, ignoring the original idea behind regional policy with the goal of economic convergence.

Key national medium-term programming document for 2007-2013 is the National Strategic Reference Framework prescribing common EU fund acquisition strategy, but programming documents are made of three Operational Programmes and Operational Programme Complements with the help of which EU fund investments are managed in Latvia.

The efficient use of these funds requires that effective and reliable management and financial control structures are in place to foster sound implementation throughout the entire Project cycle – from the feasibility assessment and project design to tendering and contracting until *ex ante* and *ex-post* control and evaluation. Latvia is not able to reap the full benefits of this assistance because of critical weaknesses in administrative and judicial capacity, be it at local, regional or central level. The Bulgarian public administration suffers from a high turnover of staff, unattractive salaries which create opportunities for corruption, and outdated, centralized procedures. In particular hesitation to use enforcement powers to remedy irregularities and fraud by immediate recoveries or other protective measures and the *de facto* non-independence of the national audit authority.

In the programming period 2007-2013 the EU fund assistance is mainly directed to public education, technological distinction and flexibility of enterprises, as well as development of science and research to facilitate knowledge-based national economy and strengthen other pre-conditions for sustainable economic development and living conditions in Latvia in general (to achieve average development indicators in the EU Latvia through acquisition of the EU funds has to implement national development strategy prescribed in the National Development Plan. Priority of the national development strategy is educated, creative and enterprising man, but the key goal is national economy based on education, science and competitive enterprises) [5].

Research

The study was conducted from August 2011 until 2011 December through interviews and discussion techniques. The study shows Latvian local municipality specialists who are involved in the elaboration and implementation of EU funded projects opinion on the practical aspects of project implementation, problems and possible solutions to improve the management of EU funds. Study results were discussed with the specialists of EU fund administering authorities, and complemented with new solutions.

The study aims to identify challenges and find the best solutions for the administration of EU funds:

- identify best practices and operational improvement opportunities;
- define the potential challenges and best practices to address them;
- prepare proposals for EU funds management process improvement for responsible authorities and the managing authority.



Guidelines, methodologies, procurement

The research reveals that EU funds Managing Authority of the Republic of Latvia needs to develop a clear and unambiguous guidelines and methodologies in order to avoid a discussions and interpreting provisions. Simplification to avoid the situation (performance) options that do not provide guidance to the objective – to clarify legislative framework for the application, the same guidelines need to be explained and interpreted.

There is urgent need to develop guidelines or a methodology for evaluation of public procurement, which is under the Law on Public Procurement thresholds:

- a brief explanation;
- sample documentation.

Although the legislation does not require the application of procurement which are below the thresholds set out in the Public procurement law, meanwhile in the Audit Authority audit reports has been included suggestions to assess the requirements below threshold procurements and ask for documentation of actions. At the same time, now each of the liaison bodies have a different evaluation approach of "below threshold" procurement documentation, because there is no common methodology or guidelines that provide a clear description of the conduct of such procurement evaluation. The Managing Authority has developed the methodology and guidelines explained solely by public procurement law, but does not clearly define the procedure in cases where the procurement not covered by the Public procurement law.

Non-compliances. Inappropriate recovery of expenditure

- it is necessary to disclose and publish the audit reports so the beneficiaries also may be aware of mistakes and failures, which could serve as a deterrent to reduce non-compliance (possible to publish the results in EU funds information system and webpages of EU funds administration institutions).
- audit plans should be made public or sent to the intermediate bodies and responsible institutions to plan their work. There is often the five audits at the same time, or even more (National Audit Authority, the State Treasury's certification audit, controls of State Audit Office, EU audits, etc.) for a single project.
- at the same time it is essential to ensure the application of the Administrative Procedure Act, for example, a decision of non-compliance and non-conforming recovery of expenses is being developed as a by-law (as opposed to correspondence letter), together with the appeal procedure and deadlines.
- the decision on non-compliance and non-conforming recovery of expenses can be combined with an inspection report, if the discrepancy is detected on-the-spot checks at the time.

Payment requests and reports evaluation, detail of inspection and audits

- it is necessary to unify the form of payment request submission plan by including it in the Cabinet of Ministers Regulations as attachment, at the same time there is subject to different forecasts of payment claims (payment requests to the schedule) forms and approaches to filling it, which confuses the beneficiaries;
- encourage certifying authority as a payment institution to enable the adoption of intermediate bodies submitted payment requests with electronic signatures, today the authorities received requests for payment should be printed and then submitted to the



Project Management Development – Practice and Perspectives

First International Scientific Conference on Project Management in the Baltic Countries
February 8-9, 2012, Riga, University of Latvia

certifying authority. At the same time the certification authority does not rely on management information system in addition to the information available and requested to submit the draft agreement and copies of amendments;

- during the discussion with intermediate bodies and responsible institutions, and also with the recipient of representatives emphasized the role of electronic communication and the importance of communication with the beneficiaries, by providing a small correction of deficiencies by means of electronic communication. It is recommended to support the payment request and attachments submission with a secure electronic signature, which is currently still reluctant to use in administration institutions. Such good practice should be encouraged in all institutions involved in the EU funds project management;
- for maximum ease of monitoring and control process, the inspection may be carried out in collaboration with other institutions (the State Administration Structure Law paragraph No. 54) [6];
- if the beneficiary shall submit a VAT reports it's necessary that State income service collaborate with the intermediate bodies and carry out a joint inspection on the project implementation site.

Communication with the Managing Authority

- it is essential to ensure productive dialogue where both parties are sufficiently informed of the nature of the problem.
- provide a “one stop” principle for the introduction of Managing Authority, to promote the function and continuity of knowledge when staff are replaced or sacked.
- as a result of discussions, liaison bodies pointed out that often Managing Authority requires urgent information previously already given to another employee or has repeatedly analysed on quarterly or semi-annual monitoring reports of the EU funds.
- staff competence and professionalism in information requests. Often, information must be redundant or doubled (data table format, the staff lack of understanding about what exactly information is needed).
- requests of information are often used by incorrect terminology.
- encourage Managing Authority coordination processes more developed to ensure the leading role, rather than coordinating.
- responsibility to evaluate attracted managing specialist expertise, qualifications and experience in project supervision and/or the administration in determining the desirable experience in project management at least 5 years.
- ensure appropriate communication and information coordination between the managing authority departments, avoiding the point of view of interpretation.

Communication with the society

Given the fact that the quarterly and annual EU funds monitoring reports are voluminous, hidden and not easily found in the public domain, it is necessary to communicate with the society, explaining the contribution of EU funds in the Latvian economy, providing a short and understandable information published in the EU funds administration institutions web pages about the EU funded projects results once a month (quarter, half of the year?):

- each institution has an A4 page;



- positive Examples;
- the main results;
- analysis;
- regular publication at the national level, such as annexes to the newspaper once a year.

Construction process

Administration process requires careful construction works and the quality of supervision in the building inspection disposal is rapidly falling in the construction and repair quality. According to the Construction Law Section No. 7 [7], and the Local Governments law section No. 15 [8], municipality are responsible for construction control and participants involved (customer, builder, contractor, etc.) comply with building laws and regulations governing the construction process and ensure the rule of law in its administrative territory within the local autonomous function. Unfortunately, local government has lack of financial resources for additional building inspectors, if the project has already been purchased building inspection service. There is need for an independent construction quality and process control.

Construction quality control assurance:

- certification question: State the solution to be developed, how it is possible to withdraw the certificate issued within the scope, work with associations, encourage beneficiaries to use the contractual right to report poor quality deliverables, eg. detail design, and require the performer responsibilities, including financial issues;
- liability Insurance: update the issue of compulsory insurance for civil designers;
- municipal construction management expertise and interest in responsibility: Building Inspection liquidation remains a matter of control problems must be addressed as a separate restoration;
- the dialogue with the contractors: an urgent meeting with the cooperation of all industry professional organizations (discussions need to be artificially as there is unfounded increase of construction work costs);
- resume negotiations on the renewal of Building Inspection to help arrange the construction market.

When analysing the results of the discussions on the construction and infrastructure projects administration, it was concluded that the responsible authorities need to provide obligatory request that infrastructure projects technical documentation (detail design) must be submitted along with the project application to ensure the evaluation from the outset (including a provision in the legislative framework of the activity implementation):

- if there are exceptions, they must be clearly defined, such as technologically complex objects, which are realized by combining the design and construction (FIDIC Yellow Book) or standard projects, which clearly predictable “unit cost” is necessary to fund technical assistance (project preparation Fund) or a separate financing of project preparation costs;
- in the new programming period of 2014-2020, evaluate the possibility exclude from financing cost of the project preparation.

As there is lack of competencies and knowledge’s in project management especially in local government institutions it’s necessary to provide technical assistance to ensure project



Project Management Development – Practice and Perspectives

First International Scientific Conference on Project Management in the Baltic Countries
February 8-9, 2012, Riga, University of Latvia

quality. There is already possible to get technical assistance at the European level. Three instruments have been developed by the European Commission together with the European Investment Bank (EIB), the European Bank for Reconstruction and Development (EBRD) and the Council of Europe Bank (CEB). Through these financial instruments technical assistance will be offered in the management of large projects or financial engineering, ensuring that the investments maintain their impact and contribute to the long-term development of regions.

The three new instruments are:

JASPERS (Joint Assistance in Supporting Projects in European Regions) – Projects falling under this instrument are transport and energy infrastructure projects and energy efficiency and renewable energy initiatives, particularly in the assessment of public-private partnerships.

JEREMIE (Joint European Resources for Micro to Medium Enterprises) – Products to be developed under this instrument include equity, venture capital, guarantees, loans and technical assistance which allow a multiplier effect of the EU funds by using revolving financial products instead of grants. Tailored schemes will be designed for SMEs in all sectors in order to address access to financial capital.

JESSICA (Joint European Support for Sustainable Investment in City Areas) – This instrument will promote sustainable investment in urban projects through the transfer of resources from operational programmes and co-financing can come from local councils, banks, pension funds or investment funds.

These three new instruments can be a way forward of accelerating the modernisation process of the Latvia. With these financial instruments, community projects can be realized through public-private partnerships which are necessary for developing the competitive edge for Latvia and assisting it in claiming its place in the knowledge-based driven EU and global markets [9].

Conclusion

In one of the most scathing documents of its type ever drawn up by the European Commission, the EU executive arm lists a litany of administrative and judicial failings at the local, regional and national levels in Latvia. Latvia itself has to make the commitment to cleanse its administration and ensure that the generous support it receives from the EU actually reaches its citizens and is not siphoned off by unskilled, unprofessional officials. The study research reveals that:

- There is still lack of professional project managers at local and national levels;
- There is lack of cooperation between institutions involved in EU funds administration;
- Audit and monitoring process has been served by too much bureaucracy, as well as auditors has different understanding of project management principles in EU funds co-financed projects;
- The guidelines and methodical documentations not always correspond to the project management theory or they are unclear and have interpreting provisions.
- The EU funds administrating institution internal and external communication is ineffective.



Project Management Development – Practice and Perspectives

First International Scientific Conference on Project Management in the Baltic Countries
February 8-9, 2012, Riga, University of Latvia

To put it simply, the recipient country or region may lack administrative capacity (sufficient number of personal and staff) and experienced management capacity. As a result, they cannot devote all the external funds for actual productive capital investment.

These problems can be solved in the longer term by improvements in bureaucratic efficiency (increased technical efficiency program administration, training, exchange and networking of fund management experiences and good practices, etc.). Nevertheless, programmers may not forget that such improvements are cost- and time-consuming measures.

References

1. Jack R. Meredith, Samuel J. Mantel, *Project Management: A Managerial Approach*, John Wiley & Sons Ltd., 2009, 616. p.
2. Patel, M. B. & Prof. P.G. W. Morris, *Guide to the Project Management Body of Knowledge*, Centre for Research in the Management of Projects, University of Manchester, UK, 1999, 52 p.
3. *Project Cycle Management*, European Commission, 1999, 79 p.
4. *Draft National Strategic Reference Framework 2007-2013*, Ministry of Finance of Republic of Latvia, 2007, 116 p.
5. *The Latvian National Development Plan 2007-2013*, Ministry of Regional Development and Local Government of the Republic of Latvia, 2006, 56 p.
6. *State Administration Structure Law*, The Parliament of the Republic of Latvia, 06.06.2002 ("LV", 94 (2669), 21.06.2002.
7. *Construction Law*, The Parliament of the Republic of Latvia ("LV", 131 (414), 30.08.1995.
8. *Local Governments law*, The Parliament of the Republic of Latvia, ("LV", 61 (192), 24.05.1994.
9. George Kolivas, DG REGIO -D3, *EU Cohesion Policy JEREMIE and JESSICA 2007-2013*, European Commission, Jessica and Jeremie conference, 2009.

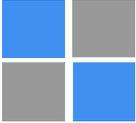

SELF-EVALUATION MODEL OF ORGANIZATIONAL BEHAVIOR IN HIGHER EDUCATION QUALITY DEVELOPMENT PROJECTS¹

PhD Associate Professor Mariann Somosi

Head of Institute, vice-dean

Institute of Management Sciences

Faculty of Economics

Miskolc University

Egyetemváros, 3515 Miskolc, Hungary

Phone: +362 04586909

E-mail: szvvs@uni-miskolc.hu

Keywords: Self-Evaluation Model of Organizational Behaviour, EFQM model, RADAR evaluation, quality assurance

Abstract

In a turbulent age, the key to permanent organizational/institutional success can increasingly be measured by the ability to recognize new challenges in time and to react to them in a quick and flexible way. As a consequence of this, the changes in our environment are forcing organizations to reconsider and change their strategies and structures in a short space of time. Nevertheless, very often the management does not make use of reliable tools or methodological knowledge. Such knowledge could be of use when considering how to implement complicated organizational change, structured and frequent mapping, and the logical restructuring of the organization – especially the restructuring of areas which are in a critical situation. Unfortunately, however, decisions are very often made based on intuition and personal viewpoints. A critical element in the successful accomplishment of organizational change is the effectiveness of the analyzing phase. This paper, therefore focuses on a methodology which supports the effective implementation of this activity.

1. “Effective” Organizational Analysis

Which are the most important characteristics of the analyzing process? Such a process should begin with the precise demarcation of the object or situation to be examined. Then the parameters of the situation-and-operation analysis can be established. The actual structure of all organizations – as a result of either conscious or spontaneous organizing interventions – basically determine their mode of operation, its efficiency and – at the same time – its limits. The recognition of this fact is a precondition for finding successful solutions. Any error factors can be revealed as a result of implementing the effective

¹ “This research was carried out as part of the TAMOP-4.2.1.B-10/2/KONV-2010-0001 project with support by the European Union, co-financed by the European Social Fund.”

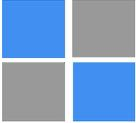

organizational solutions appropriate for the given area. Depending on their types, such solutions could be used as organizational reserves. Accordingly, situation analysis concentrates on the contrast between the actual situation and the “ideal” position. In addition to this, the operations of all sub-systems contain several perceivable segmental or persistent errors. At first glance, such recognizable so-called operational errors include the frequent problems caused by the people, in their everyday work, not following the directions, rules, and working methods which have been determined by the way a particular system operates. These operational errors could be categorized as losses. Such errors can be recognized via a comparison of the official ‘planned’ method of operation and the way the operation works in reality. By evaluating the appropriateness and the efficiency of the objective-task-tool procedure, operational analysis can provide information on the effectiveness of regulations and changes in motivational systems. Operational analysis can also lead to the elimination of temporary problems and other limitations. At the same time, we can examine whether the objectives of the system designers have failed because of segmental or structural factors. After decisions have been made concerning the aims and objectives of the organizational analysis, the appropriate methods can then be selected. The criteria used to choose such methods can include, for example, the size of the task, whether a formal system of evaluation is in place, the aims of the organizational analysis, the method which has been formulated to analyze parameters, the means of evaluation to be employed, the conditions in which the analysis will be implemented, the accessories to be used, the contents of the system of evaluation and so on.

Considering the factors mentioned above, the following statements can be made with regards to the methodology of operational analysis:

- The methods used should meet the demands made on them in different ways.
- The users can be offered different approaches. This enables any necessary adjustments to be made to the decisions, increasing the effectiveness of the decision-making process. In addition, any decisions taken can be aligned with the users’ interests, as well as the users’ roles, mentalities and patterns of communication.
- With regards to all methods, one must consider how effective they are in a given situation.

2. The Self-Evaluation Model of Organizational Behaviour

Below, I will deal with organizational self-evaluation as a method of organizational analysis. I will especially focus on the Self-Evaluation Model of Organizational Behaviour, analyzing it in detail. I will discuss this model in its wider context, in addition to presenting a smaller, more specific version of the model that I have devised myself. I intend to examine how both these versions of the model can become part of a process of organizational change.

Self-evaluation basically includes a complex, system-based approach and the periodical examination of organizational activities and results. This makes it possible for the organization to recognize its strengths and those areas which could be improved. During organizational self-evaluation, a comparison takes place between the organization as it is and a model of an ideal organization. This is like “looking into a mirror”, although it should be stated that there is not “only one good solution” to the organization’s problems.

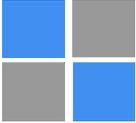

Table 1

Fields of self-evaluation according to the Model of Organizational Behavior

ENABLERS	RESULT
<p>LEADERSHIP: The model evaluates the behavior and activities of all managers and management groups without giving names. It investigates how the persons in management positions support, inspire and help to reach the organization’s goals. Internal and external communication is responsible for the transmission of values, and for the presentation of expectations and orientations. The answers found during the investigation can be used to judge specific solutions and the standard of operations. The connections between the organization’s strategy, structure and culture, and its day-to-day existence; and the relationship between the company’s formal structures and its more informal culture are important areas with regards to the judgment of managerial activity. A more ‘hands-on’ kind of leadership – and the systems of evaluation and motivation related to it – are important pillars of quality, excellence and corporate culture. These also need to be taken into consideration.</p>	<p>EMPLOYEES’ SATISFACTION: The model investigates what kind of results the organization has attained with regards to the satisfaction and motivation of its employees. Performance evaluations and methods of remuneration provide information about the employees’ satisfaction in an indirect way. Other indirect indicators are whether there is career planning or if professional development is encouraged. A high staff turnover is evidence of the absence of satisfaction.</p>
<p>HUMAN RESOURCE MANAGEMENT: The model investigates how the organizations of the examined company/institution utilize the skills, knowledge and competencies of its personnel (or human resources). By using questions, the model can review how the organization manages, develops and utilizes its employees’ knowledge and skills on individual, group and organizational levels. The model also looks into how such activities are organized to support the fulfillment of short and long-term objectives. The model aims to show how the identification and development of the employees’ skills and competencies occur, in addition to identifying the means of dialogue between the organization and its employees. The examination of certain elements of performance management is also important.</p>	<p>CUSTOMER SATISFACTION: The model investigates how the organization identifies, segments and measures its different groups of external customers. It evaluates those indicators and results which mark the level of customer satisfaction and loyalty. By doing this, the model seeks to determine the true level of customer satisfaction.</p>
<p>HUMAN STRATEGY AND PARTNERSHIPS: The model investigates what kind of human strategy the organization accomplishes, and how the organization’s resources are managed in order to promote efficiency and effectiveness. The model asks what kind of actions ensure that the organization uses and develops its key partnerships in order to utilize the organization’s knowledge to the highest possible level.</p>	<p>SOCIAL RESPONSIBILITY: The model examines the organization’s activities which have an influence on its community, general society and the wider environment. This all depends on the size and type of the organization.</p>

Source: own editing

Therefore, organizational self-evaluation offers a well-structured approach – which gives an overall picture – for the manager using it. Placing organizational behavior in the spotlight is a

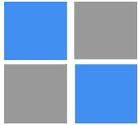

consequence of the fact that a considerable part of an organization's success depends on the actions of its members. The best organizational structure and the most professional strategy cannot by themselves lead to success. The organization's staff are also needed for its accomplishment. It is evident that motivation, effort, decisions, cooperation ability and the notions held by the employees are the most important components of organizational performance. Therefore, it is useful to perform a detailed analysis of the behavior of organizations and the factors that influence it. In my opinion, the self-evaluation model of organizational behavior is appropriate for doing this.

The Self-Evaluation Model of Organizational Behavior can be seen as a smaller, more focused version of the more developed EFQM model. The relevant fields from the perspective of organizational behavior – and interpretations of them – are listed in Table 1.

The considerations outlined above can be used to evaluate the level of operational efficiency with regards to the human factors within the organization. All similar selfevaluation systems use two different methods for the quantitative research:

- tests (internal and external public opinion research materials)
- textual self-evaluation (teams comprising professionally competent persons from the organization.)

The normative character of the model derives from the evaluation scale and its extension. According to this model, the maximum values of the fields of organizational behavior are as seen in Figure 1.

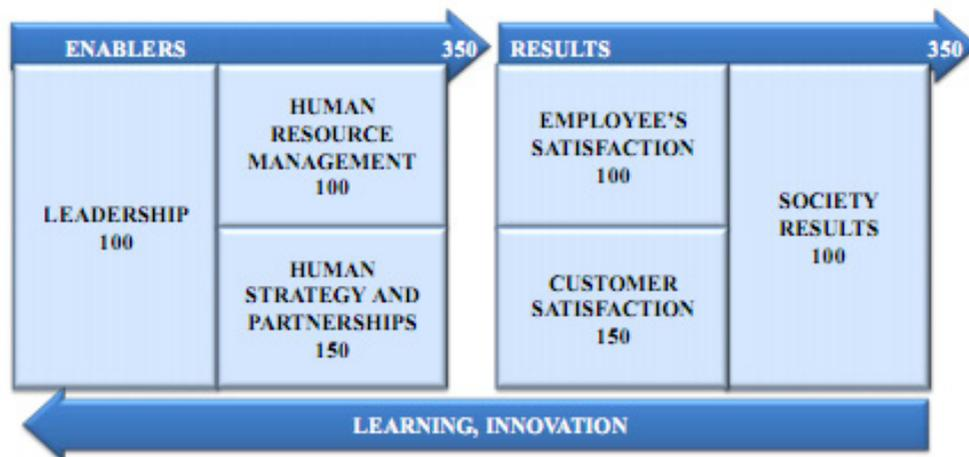
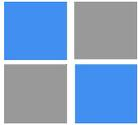

Figure 1. Self-Evaluation Model of Organizational Behavior

Source: own editing

The procedures by which the six fields are evaluated are not uniform. The evaluation of the fields of Leadership, Human Resource Management, Human Strategy and Partnerships, and Employee Satisfaction are based on the same logic. This involves, on one hand, public opinion research in the form of tests. (These tests are based on an internal, representative sample of the organization's employees.) On the other hand, textual self-evaluation is carried out by an internal professional team.



With regards to the results for Customer Satisfaction and Social Responsibility, we can only rely on the data of external public opinion surveys. The basis of these surveys is a test containing fixed topics and questions. The main evaluation subgroups for the 6 fields can be structured in the following way, as presented in Tables 2 and 3.

Table 2

Subgroups of Enablers in the Self-Evaluation Model of Organizational Behavior

Leadership	Human Resource Management	Human Strategy and Partnerships
<ul style="list-style-type: none"> • The management’s scale of values • The identification and validation of the organization’s mission and values • Internal communication • Role modeling • Conflict management • Participation • Organizational structure 	<ul style="list-style-type: none"> • Competence requirements • Performance requirements • Motivation • Performance evaluation • Personal development • Career planning • Organizational culture • Measuring intellectual capital 	<ul style="list-style-type: none"> • The relations between strategy and human strategy • Personal development • The process of human strategy development • Knowledge of strategy • Supporting achievement • Monitoring and correcting strategy • National professional partnerships and development • International professional partnerships and development • Labor market partnerships • Influencing sectors

Source: own editing

Table 3

Subgroups of Results in the Self-Evaluation Model of Organizational Behavior

Employee’s Satisfaction	Customer Satisfaction	Social Responsibility
<ul style="list-style-type: none"> • Participation Internal communication • Satisfaction with the work • Feeling appreciated • Loyalty to the organization • Interest claiming • Receiving support 	<ul style="list-style-type: none"> • Judgment of products and services • Image of the organization • Behavior of the organization’s employees • Customer service activities • External communication 	<ul style="list-style-type: none"> • Environmental awareness • Relationships with social organizations • Opinions of civil rganizations • Judgments of the underprivileged • Supporting, and cooperating with, external partners

Source: own editing

The criteria of textual self-evaluation, in the case of the first four fields, can be met by further detailing and grouping the above mentioned phenomena in the way described in the EFQM model. The process of self-evaluation is presented in Figure 2.

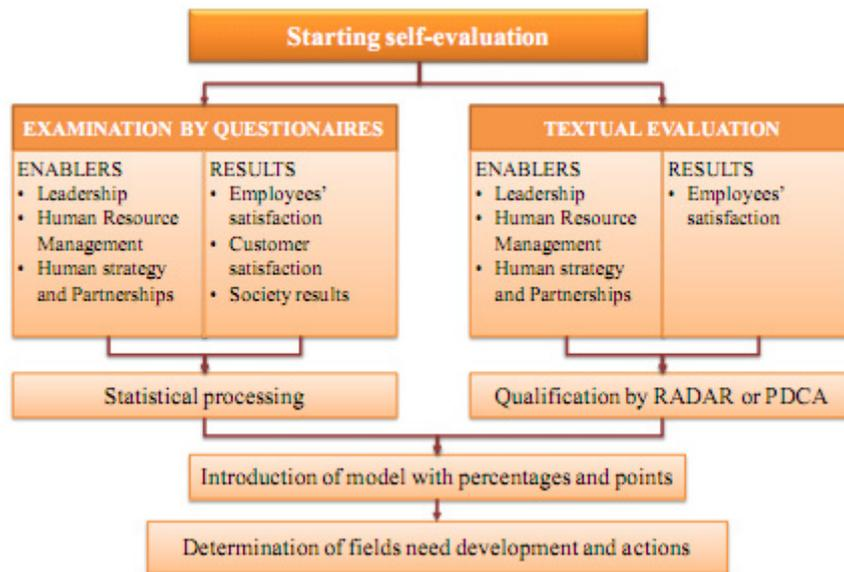

Figure 2. Process of organizational self-evaluation

Source: own editing

As seen in the flow diagram, a separate phase of implementation is necessary for the evaluation of the information gained and its transformation into evaluating points. In order to carry out the evaluation, the tests use a 5-grade scale. If the total number of points given by the respondents is divided by the maximum number of points, the percentage we get is already appropriate for calculating the point value. This represents the exact ratio from the maximum number of points on the field test. In order to carry out the entire procedure mentioned above, first a decision has to be made concerning the ratio of test and textual points, for which I propose the ratio of 66/34. For the quantification of the textual evaluation, I suggest the RADAR or PDCA cycle. In the former cycle, the evaluation of the Enablers and Results elements are different; in the latter, there is no relevant difference with regards to these elements.

3. The Evaluation Methodology of the Self-Evaluation Model of Organizational Behavior

The methodological criteria-system of evaluation – based on the Self-Evaluation Model of Organizational Behavior – can be divided into a primary and a secondary part. Both of them are based on the test results, as well as on the textual evaluation. The primary evaluation contains the overall values of the whole model, as well as the enablers and results elements. In addition, it also analyses the extremities within each of the elements. The secondary part investigates groups within the elements, and the interrelations within and between the elements. The primary evaluation covers the following fields:

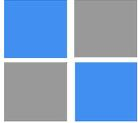

Project Management Development – Practice and Perspectives

First International Scientific Conference on Project Management in the Baltic Countries

February 8-9, 2012, Riga, University of Latvia

Criteria of evaluation:

- Total number of points;
- RADAR %;
- Incidence rate with regards to the maximum and minimum number of points available;
- The range of analysis in connection with the opinions of customers and the wider society;
- The highest and lowest average scores, with regards to the Enablers and the Employees' Satisfaction.

In case of all the criteria – with the exception of the RADAR % – the resources used were based upon the data from the completed tests. During the first stage of processing, the total number of points can be determined through analyzing the tests filled in by the employees. The areas of Leadership, Human Resource Management, Human Strategy and Partnerships, and Employees' Satisfaction made up 66% of the total number of points available in the element concerned. Customer Satisfaction and Social Responsibility – with regards to the appropriate element – made up 100% of the total available points (it should be emphasized that there is not any textual evaluation in these cases.)

The textual evaluation is based on the RADAR technique, according to which firmly validated methods and approaches have to be planned and established. Through these the desired objectives can be reached, and then the methods used can be systematically examined in detail. The methods applied have to be analyzed and evaluated through the analysis of the results obtained, and the results have to be weighed up with regard to organizational performance and the satisfaction of the expectations of the interested parties. Following this, as a result of the RADAR evaluation – which will have been prepared by the managerial teams – the number of points obtained in the textual evaluation can be revealed. According to the RADAR logic, all organizations need to:

- have a precise idea of the results they wish to achieve;
- plan and establish the methods to be applied;
- ensure the methods are systematically applied;
- evaluate and refine the methods;
- establish and develop their objectives, and finally implement them.

During the analysis, the professional team carrying out the evaluation takes into consideration whether the organization have clearly defined aims and objectives, and whether these meet the needs of the interested parties. They also consider the integration of – and the support provided by – the organizational strategy, as well as considering the expected results. The practical side of the evaluation examines the putting of the organization's methods into practice. The evaluation and refinement is related to the measurement and interpretation of the method. The effectiveness and efficiency of the approach and its application also have to be examined, as well as the learning process of the organization, the analysis and use of actions and information, and the developments accomplished. All of this is concisely stated in the RADAR acronym (Results, Approach, Deployment, Assessment, and Refinement). Following the above mentioned logic, 33% of points can be gained for all the elements of Enablers, and 3% of points for Employees' Satisfaction.

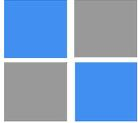

With regards to all the elements examined by the tests, the incidence rate of maximum (5) or minimum (0 or 1) points can be quantified. By doing this, any extremes which emerge during the evaluation can be investigated.

In the case of the results for Customer Satisfaction and Social Responsibility, it is practical to make a range analysis. This can provide information about the location of the points gained within the margin 0 to 5. If we also perform a deviation calculation, we can get a picture of the homogeneity of opinions.

Regarding the 4 elements evaluated by employees (3 for Enablers and one for Employees' satisfaction), the highest and lowest average points are examined in order to eliminate extremes. The lowest average points are normally used to determine the potential fields for improvement. Secondary processing covers the evaluation of the following fields:

Evaluation criteria:

- evaluation of the elements by statistical groups (expressed in %);
- evaluation of the consistency of assessment among the elements that differ from the averages of the textual and test evaluation;
- verification of consistent opinions (by using questions to check the validity of previous responses);
- evaluation of elements by using the ratio of the number of points available and the number of points gained (expressed in %);
- analysis of the links between the Enabler elements and the Results – range analysis and average-point calculations for the main groups (training, communication, cooperation, management systems, culture) – correlation analysis of the elements through the evaluation criteria.

During the % evaluation of the elements by the statistical groups it can be investigated whether there is a relevant difference in opinions between managers and employees, or men and women. If necessary, a clausal analysis may follow.

The evaluation of the consistency of assessment among the elements which are different from the average of the textual and test evaluation is appropriate to reveal the relevant difference of opinions in the dual evaluation. The evaluation can also reveal “convergence” between the two types of evaluation. It is advisable for all companies to analyze the consistency of opinions by using questions which aim to check the reliability of previous responses.

The next step is the evaluation of the elements' characteristics based on tests. Here, groups can be formed within each element in order to perform an evaluation which is even more differentiated. This evaluation could enable the identification of clearly defined crosssections within elements. It could also help to highlight those fields which could be improved. Below are some examples:

- strategic approach;
- participation;
- managerial role modeling;
- team-work.

Table 4 contains information about characteristics in relation to the elements discussed above.

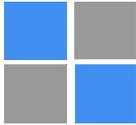

Table 4

Introduction of characteristics according to the elements

E N A B L E R S	<p>LEADERSHIP</p> <ul style="list-style-type: none"> - strategic approach, - role modeling of management, - participation, team-work orientation, - professional competence 	<p>HUMAN STRATEGY AND PARTNERSHIPS</p> <ul style="list-style-type: none"> - strategic approach, - feedback on the strategy, - participation, - integrated management, - partnerships 	<p>HUMAN RESOURCE MANAGEMENT</p> <ul style="list-style-type: none"> - determination of requirements, - personal advancement, - supportive conditions, - evaluation, - development
R E S U L T S	<p>EMPLOYEES' SATISFACTION</p> <ul style="list-style-type: none"> - management, - leadership, - motivation, - participation and team-work, - culture, - supportive conditions. 	<p>CUSTOMER SATISFACTION</p> <ul style="list-style-type: none"> - customer loyalty, - customer registration system, - comparison analysis, - analysis of customer groups, - routine methods, - external communication. 	<p>SOCIAL RESPONSIBILITY</p> <ul style="list-style-type: none"> - protection of direct and wider environment, - supporting the community, - the firm's reputation.

Source: own editing

Besides the isolated examination of the elements, it is advisable to analyze the links between the enabler and result elements. These can show the weaknesses and imbalances of each element. A multilateral approach could also be useful to point out the areas that need to be considered here.

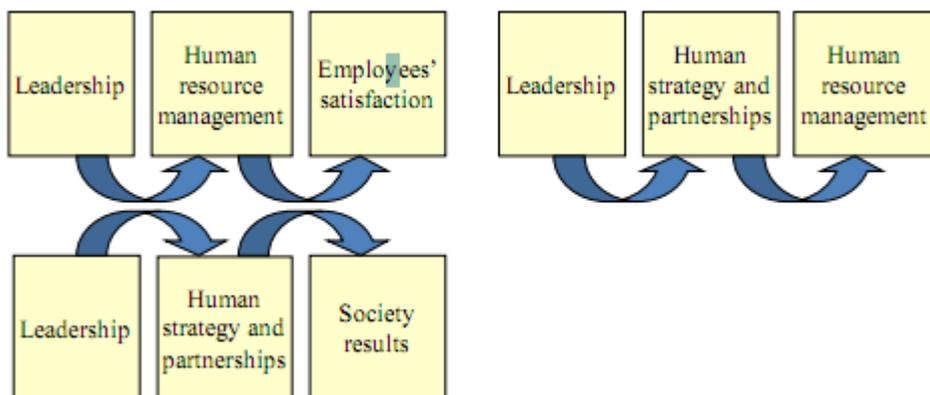
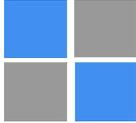

Figure 3. Strong connections (links) in the model

Source: own editing



Project Management Development – Practice and Perspectives

First International Scientific Conference on Project Management in the Baltic Countries
February 8-9, 2012, Riga, University of Latvia

References

1. Bakacsi Gy.: Szervezeti magatartás és vezetés (Organization behavior and leadership) KJK 1996.
2. A munkatársak irányítása és elégedettsége a szervezeti önértékelésen keresztül. (Management and satisfaction of employees through organizational selfevaluation) In: Harvard Businessmanager, 2005. 11. sz.
3. A Research Project – Performance Measurement of a Crisis Region in Hungary by Adapting a Method of Organization Evaluation. Társz.: Szintay I., Hoga O. “Sixteenth Annual Conference of POMS, Chicago, Il.” April 29 May 2, 2005. 12 p. [CD]
4. Organisational Self-Evaluation as a Possible Tool of Organisational Analysis. “Sixteenth Annual Conference of POMS, Chicago, Il, April 29 – May 2, 2005.” 14 p.
5. Az értékalapú szervezetfejlesztés egy új megközelítése. (A new approach of valuebased organization development) In: GVV Gazdálkodás Verseny Vezetés, [2. évf.] 2010. 1. sz. 13-21. p. ISSN 2061-3539.
6. A felsőoktatás belső és külső minőségirányítási rendszerének sajátosságai. Az intézményfejlesztési és a minőségfejlesztési terv kapcsolata. (Characteristics of internal and external quality management systems in higher education. The relations between plans of institution development and quality improvement) Társz.: Szintay I. In: Magyar Minőség, 2007. 6. sz. 21-28. p.



SPECIALITIES OF TECHNOLOGY TRANSFER PROJECTS IN KNOWLEDGE BASED ECONOMY¹

*PhD Associate Professor **Dezso Szakaly***

Head of Department, vice-dean

Department of Innovation and Technology Management

Faculty of Economics

Miskolc University

Egyetemváros, 3515 Miskolc, Hungary

Phone: +362 04586909

E-mail: szvszad@uni-miskolc.hu

Keywords: knowledge based economy, technology transfer, transfer models, knowledge centres – knowledge regions

Abstract

The factor to what extent a country can join the more and more intensive international technology transfers is one that has a decisive impact on the development of the national economy.

In the past few years it has been possible to observe two characteristic phenomena in the efforts of the countries undertaking dominant roles in the transfers completed for making the knowledge flow more intensive. One is the result of globalisation and company activities becoming more international, which can be shown in the steady growth of transfer traffic. The other is an effort manifested in the countries taking specific steps to balance their transfer balance and to ensure that it is in the black.

With the exception of the simplest cases, transfer means both imparting and taking over knowledge and experience. Imparting the knowledge accumulated in the course of R+D can only be successful if the previous qualifications of the receiving party make it possible to implement organised transfer of knowledge.

Role of Technology Transfer in the Economy

The factor to what extent a country can join the more and more intensive international technology transfers is one that has a decisive impact on the development of the national economy.

In the past few years it has been possible to observe two characteristic phenomena in the efforts of the countries undertaking dominant roles in the transfers completed for making the knowledge flow more intensive. One is the result of globalisation and company activities becoming more international, which can be shown in the steady growth of transfer traffic. The

¹ “This research was carried out as part of the TAMOP-4.2.1.B-10/2/KONV-2010-0001 project with support by the European Union, co-financed by the European Social Fund.”



other is an effort manifested in the countries taking specific steps to balance their transfer balance and to ensure that it is in the black.²

An OMFB study (1998) relying on an analysis of OECD statistics highlights some important tendencies in this context:

- Technology supply is much more concentrated than demand. The largest users are the service industries, while the majority of R+D expenditures are concentrated on narrow industrial fields.
- In evaluating technology diffusion, the expenditure on technology purchase is to be taken into account beyond direct R+D expenditures.
- The significance of imported technology has steadily increased in the past one and a half decades. In smaller, moderately developed countries like Hungary, its extent is over 50%.
- Global, relatively barrier-free technology diffusion played a decisive role in the global increase in the efficiency of Information Communication Technology (ICT) sectors.
- Technology diffusion has an efficient supporter in strengthening the transfer processes and their methodology and infrastructure support. This is of particular importance for small countries and for countries conducting intensive international trade.

The Concept of Technology Transfer

The term technology is derived from the Greek language. The word used today is made up by connecting the words 'techne' and 'logos'. The word 'techne' was used to mean manual skills or, in a more general sense, skills and ability. The word 'logos' corresponds to the content knowledge, science. And accordingly, the word made up of the two corresponds to skills, competence, aptitude for something in a broad sense of the word, and the knowledge required for it. (Shane, 1982)

In a more general sense in today's interpretation technology is a result of the synergic combination of four factors (knowledge elements) (Figure 1).

The four knowledge carriers identified above can at the same time be regarded as the objects of technology transfer. In a general sense the concept technology is used to mean the elements of knowledge concerning the implementation of something, which includes the product and/or service to be created, the process of implementation (production – distribution) and the related additional knowledge (management, experience, competence). And technology transfer means the flow of all these technical and knowledge components between the various organisations and persons.

Today technology is defined in a broader sense as a specific 'know-how', a sum of knowledge (Shane, 1982). This interpretation has the essential feature that it does not narrow the concept down to the level of knowledge concerning specific production processes or manufacturing technology, but treats it as a complex set of knowledge necessary for creating an enterprise, organising and operating the systems of production and distribution.

² The international flow of knowledge is surveyed by OECD primarily using the data of the technological balance of payments quantifying the foreign trade in brands, licences, know-how, patents, and intellectual services. Some analyses also study the data of investment capital including technology transfer. /Papanek, 2002/

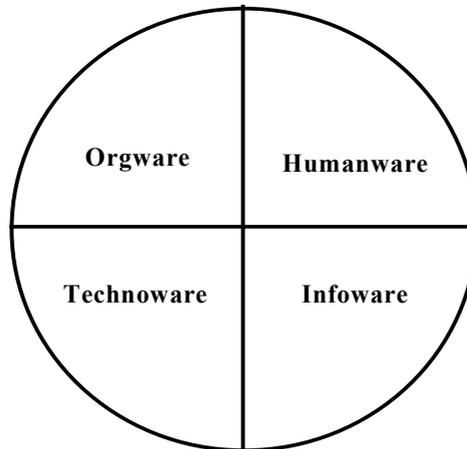

Figure 1. Components of technology

If the term technology is used as an attribute of a transfer process, then we can accept the interpretation that it is indeed nothing else but a sum of the technical competences and immaterial knowledge that makes people and organisations capable of:

- perceiving new problems,
- elaborating new conceptions,
- elaborating new solutions,
- creating a new division of labour for people and organisations,

as a result of which a new product and/or service is created. Transfer is passing on knowledge to those who do not have it (national economy, companies, organisations, and individuals). This new, ideal technology transfer also includes innovation, namely the innovation of the new, adapted system, which obviously satisfies a market demand on the side of end users, while it renews several social and economic potentials of the receiving party.

Transfer is always implemented in connection with some direct or indirect economic activity. It results in a special, targeted re-distribution of the outputs of the general development process. Today it's clearly presentable feature is the effort aimed at imparting systemised knowledge.

Technology transfer and adoption is not simply imitation of a particular idea (knowledge), but adaptation of the original so that it can best suit the typical sociological, political, technology, climatic, economic and education environment of the receiving party (Figure 2).

Technology transfer is implemented in various fields of production and services through the imparting and takeover of innovations and development results.

Technology transfer makes it possible that:

- the receiver starts using the R+D results of others fast,
- the donor who has taken on the risky investments of R+D requiring large expenditures is able to share the burdens with others through the rapid economic exploitation of the results.

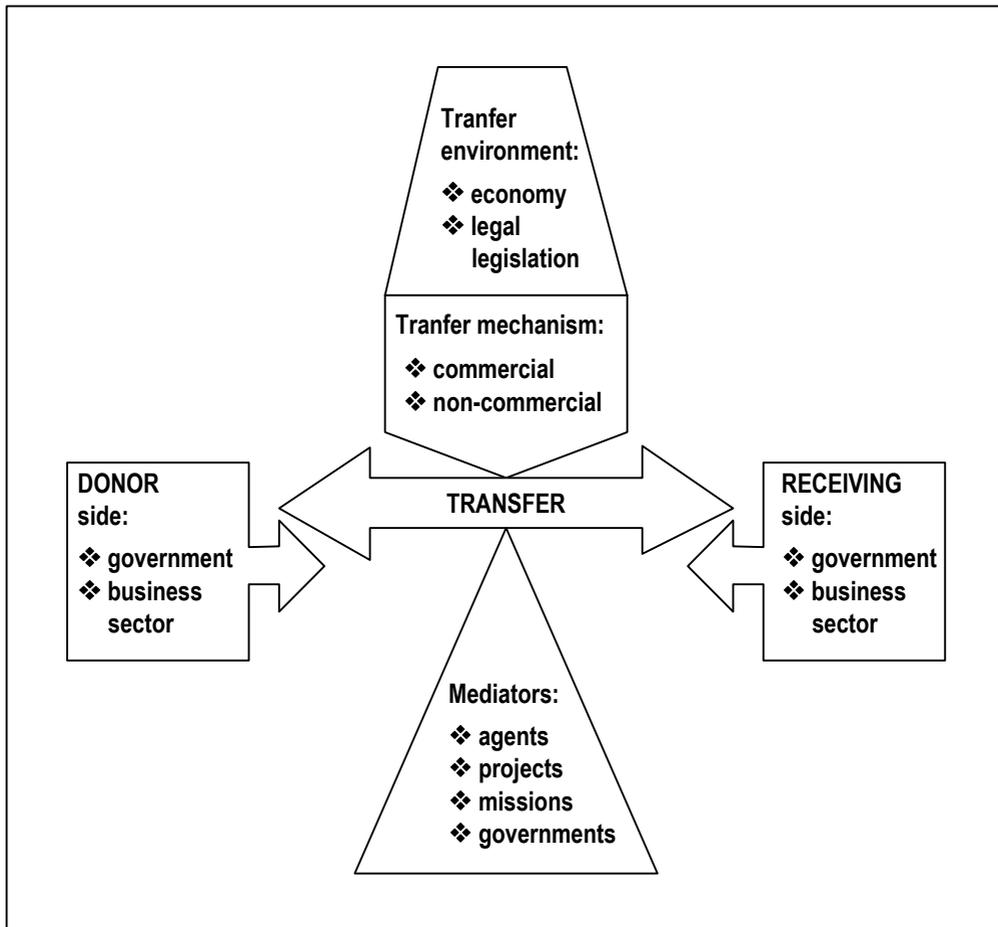

Figure 2. Process and players of technology transfer

The technology gap and the resulting asymmetry (difference in knowledge) is the starting impulse and driving force of technology transfers. The reason for this is that scientific and technical resources show a highly concentrated distribution in terms of the world or individual countries. The imbalance activates and keeps the potential players in action who are trying to solve the imbalance. It is technology transfer through which – in the various moments of the innovation processes – the division of labour is also achieved, both on sector scale and at international level.

Concerning its content, technology transfer also includes the passing on and taking over of free knowledge as well as that owned by the proprietor (confidential – restricted). Free and thus public information generally ensures access to scientific research results. On the other hand, protected information contains specialist elements of technological knowledge and can be learned by methods controlled by its owners (patent, licence, etc.). Their extents and proportions are essential for the receiving side, for the decision makers stating their opinions here are frequently faced with tasks that can often hardly be solved.



This general problem is referred to in the professional literature as ‘transfer paradox’ or ‘knowledge controller’. The essence is that

“the technology that we want to obtain is basically the information that would be necessary in order to make reasonable decisions on the issues of purchasing or rejecting”. (Ambrosio, 1995)

Decisions concerning transfer carry perceivably high risks, particularly when public information is available to a limited extent. This is a frequently repeated basic situation in defence areas and in actions with an economic initiative. It is a well-known fact that innovative companies consciously raise the barriers to entering the market to a high level. One means of doing so is making the information on the novelty confidential, providing legal protection for it and embedding it in a way that allows movement only in a complete form (complete know-how.)

Transfer models

The processes of delivery and reception take place in highly different structures according to the intentions, interest enforcement methods and the integration extent of the cooperation of the players involved in the transfer, the donors and the recipients. In the following some models comprising the relations between the players and demonstrating specialist transfer strategies will be presented (Figure 3 and Table 2). Familiarisation with the models is essential because initial transfers are always established in the frameworks of the simpler models, and after a successful cooperation the adoption of more complex forms can begin. The experience gained in the transfers can provide a solid foundation for the conscious development of the embedding potentials of the receiving side, and through that for awakening the force of attraction. This may result in the establishment of cooperation according to more complex models, which may provide a sound framework for more intensive interest enforcement by the receiving party, and for the development of the active position. The models to be presented also represent a historical development series, which may serve as an informative framework for the evaluation of transfers in Hungary in the past ten years.

Five types of the models describing the behaviour of the players of the process can be differentiated:

‘Contact building model’:

It highlights the role of bridge-forming institutions ensuring information flow between the sources and the utilisers. These institutions bring about the connection between the demand and supply sides through enabling the potential partners to find each other while orientating them – through offering custom-made programs – in order to find the expedient mechanism.

‘Diffusion model’:

It concentrates on connecting appropriate technologies and diffusion potentials. It finds the players interested in an expedient division of labour for the various moments of research, development and adaptation. Regarding its character, it is also able to embrace more complex mechanisms and makes it possible for the receiving side to utilise its diffusion potentials more efficiently. The contact-building model is first of all useful for starting or occasional transfers, for it ensures cooperation between a small number of players in a transparent system. The diffusion model is the expedient model for mass, fast, spatially widely spread diffusion, where the presence and coordinated cooperation of a great number of players can be ensured on the recipient side.



Project Management Development – Practice and Perspectives

First International Scientific Conference on Project Management in the Baltic Countries

February 8-9, 2012, Riga, University of Latvia

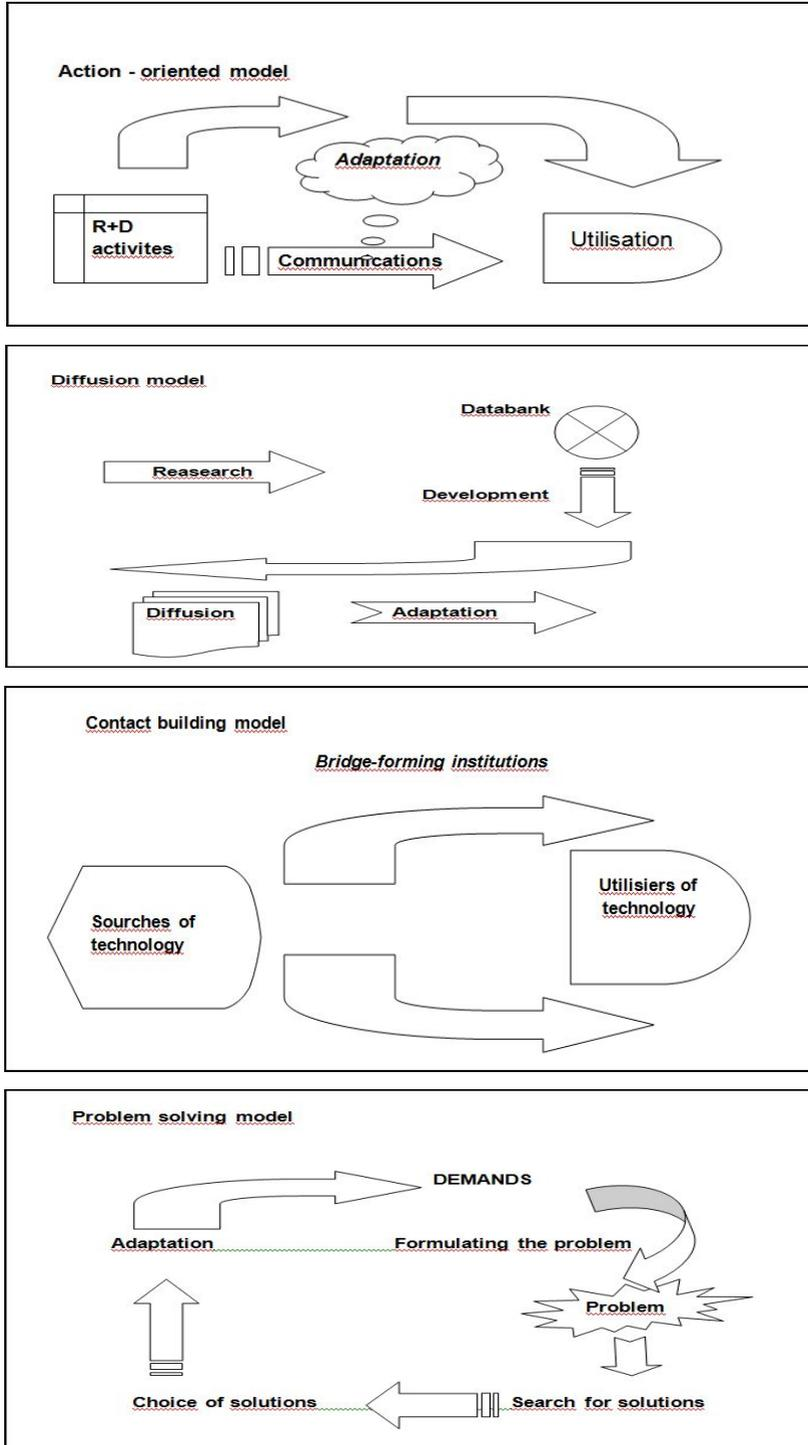

Figure 3. Technology transfer models



‘Problem solving model’:

It starts from clarifying the requirements accurately. It looks at the requirements as technology deficiencies to be solved and from this starts a problem solving process. In its framework it comes to the final solution through determining the directions of adaptation from the potential solutions. It is an important element of this logical system that it is not satisfied with a simple examination and qualification of the supply, but in the course of selection also qualifies the adaptation willingness of the donor. This way of thinking does not simplify transfer through a simple putting over of the possible technologies offered, but regards the optimum possible satisfaction of the fundamental demand as its main objective. In formulating the problem and searching for a solution it relies on the active participation of the prospective recipient organisation. Regarding its character, the model exceeds simple commercial transactions and fits supplementary developments ensuring the complete satisfaction of the demand on the recipient side into the system. This latter feature may ensure the development of products and technologies meeting the specialist demand of the local markets.

‘Action-oriented model’:

It combines the elements of the process on the basis of economically established utility. This thinking starts from the fact that a decisive moment of active marketing arrives in the lifecycle of every novelty. This occurs under competitive conditions. The innovative diffuser enjoys an advantage in this competition if he can cooperate in the early stages of diffusion with adaptors who are prepared and forced to loyalty by contracts. This adaptation does not mean simply passing over and increasing mass, but improvement matching the local requirements also appears in it. It is not by chance that this model is well-spread in the practice of international companies primarily when the parent company (donor) has to cooperate with a recipient country and target market with a culture very different from the culture of the donor’s country (e.g. the European projects of Japanese companies, large US companies in African countries). Each of the companies thinking in terms of a global strategy has applied similar solutions in the early stages of its internationalisation.

‘Model Built on Knowledge Exchange’:

The model is closed in one direction through the donor party monitoring consciously in a pre-planned manner and, in many cases, encouraging and assisting the improvement efforts of the recipient party. In order to compensate for the efforts and expenditure in this, it supports transfer towards a third party as well. In addition, it takes over these development results and after appropriate analysis, builds them into its own new programs. In the new transfer cycles then it becomes possible to disseminate these novelties globally. This model is clearly observable in transfers within international companies and in projects aimed at the transfer of production means and methods. In the first case the interpersonal relations within the companies and the off-site R+D departments are the driving forces of the process. In the second area it is primarily the customer service organisations that do the necessary information collecting through their monitoring system. The model is actually an



efficient means for implementing external and internal ‘techno partition’, which is nothing but a conscious sharing and moving of knowledge, technology and resources between the appropriate transfer players while maintaining mutual benefits.

Table 2

Comparison of technology transfer models

(based on Mogavero-Shane, 1982)

FEATURE	CONTACT BUILDING MODEL	DIFFUSION MODEL	PROBLEM SOLVING MODEL	ACTION ORIENTED MODEL	MODEL BUILT ON KNOWLEDGE EXCHANGE
1. Basic idea of the model	Connecting supply and demand	Creating the conditions for rapid diffusion	Eliminating technology problems	Preparing many channels of utilisation	Exploiting the advantages of mutual learning
2. Key players	Bridge-forming institutions	Communicators	Requirement-oriented adaptors	Specialist adaptors	Developing recipients
3. Crucial process elements	<ul style="list-style-type: none"> – finding supply-demand – partner mediation 	<ul style="list-style-type: none"> – loading a databank – surveying diffusion potentials – communication 	<ul style="list-style-type: none"> – exploring requirements – formulating problems – searching for solution methods – setting adaptation directions 	<ul style="list-style-type: none"> – predicting utilisation directions – searching for partners – building adaptation bases 	<ul style="list-style-type: none"> – developing embedding programs – building bases for improvement – analysing knowledge content
4. Typical transfer mechanisms	<ul style="list-style-type: none"> – building turnkey systems – wedging in technology 	<ul style="list-style-type: none"> – licence trade – embedded technology trade – training programs 	<ul style="list-style-type: none"> – patent transfer – know-how transfer – technology service purchase 	<ul style="list-style-type: none"> – joint ventures – internal techno partition – affiliated companies 	<ul style="list-style-type: none"> – external techno partition – reciprocate and cross licence transfer – Joint venture – joint R+D programs

The model based on Knowledge exchange including feedback as well is today becoming more and more prevalent (Figure 4).

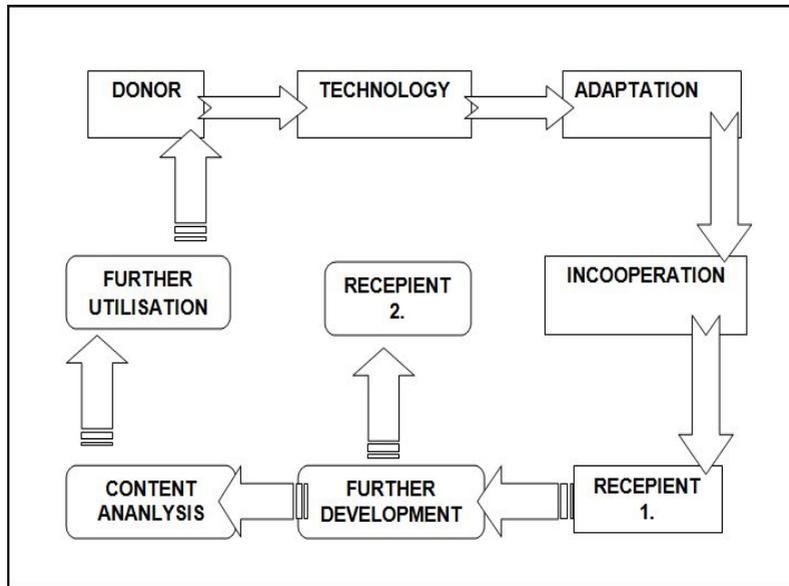

Figure 4. Model Built on Knowledge Exchange

Technology Transfer as a Means of Creating Knowledge

When creating technical knowledge, the transfer of knowledge can be performed at different levels. One extreme is when the process is simplified to the physical takeover of a machine, equipment, or device, while the other is when technology is learned to be operated with the best degree of efficiency in a process of up to several years (von Hippel, 1988; Ray, 1969) and in the meantime significant adaptive modifications are implemented on the original system. The events and outputs of this process also depend on the extent the innovation can be regarded as competence destroying or competence enhancing. In such a complex technology transfer program both individual and corporate learning is required. Individual learning begins with collecting experience related to the technology and the understanding of this experience creates the individual knowledge modifying individual abilities and knowledge. Corporate knowledge is a sum of the individual knowledge of persons. Here synergic effects prevail on the one hand, and, on the other, the organisation learns only to the extent that the persons are able to change the results of individual learning to corporate routine (elements building the culture).

In the transfer process of complex systems the exchange of knowledge takes place at two levels:

- Level one: A knowledge package summed up by the creators of the technology and connected to the operation foreseen. This assists the widening of the knowledge of the recipient directly.
- Level two: A knowledge package created at the recipient of the technology in the course of use and adaptation. This may have very intensive creative and innovative elements (reinvention). The knowledge created by the user also moves in the reverse direction and the information important for the innovator may provide initial impulses for planning the next generation or concrete solutions.



Four levels of the transfer of technology competences can be differentiated:

- Level 1: copying the activity;
- Level 2: complex adaptation of the activity;
- Level 3: transfer of the scientific knowledge behind the technology;
- Level 4: interactive cooperation between donor and recipient.

The levels denoted here also mark in general the development stages in the cooperation of the lasting transfer partners and represent the borders of the frameworks that can be gradually developed.

Limits and characteristics of knowledge transfer:

1. Technical knowledge is highly differentiated and immobile, for it also includes user experience. This experience also carries in itself innovative elements, for taking over a technology involves the incorporation of new inventions.
2. The central task of the potential donors and recipients of advanced technology is to deconstruct the limits of knowledge. This cannot be an isolated activity, but presupposes a specialist cooperation network of the various participants.
3. Mediating institutions are wedged in between the donor and the recipients. The tasks of these institutions are diverse:
 - mediating know-how from the donor to the recipient;
 - flowing back user knowledge from the recipients to the donor;
 - providing methodologies for accelerating individual learning processes;
 - documenting experience gained in the course of individual learning, formulating it in a way suitable for passing on;
 - methodological support for corporate learning, accelerating it and initiating the changes required for this purpose.
4. The work of mediating institutions is efficient because the benefits resulting from an economy of scale appear in them. Each of the recipients experiences every moment of receiving and incorporation as an individual event. They cannot draw generalisable conclusions from these phenomena that appear to them as individual. The mediator on the other hand obtains unique experience and institutionalisable knowledge bases through synthesising the ‘individual’ phenomena and evaluating the repetitions.

References

1. Hippel, E. A. (1977): Has a customer already developed your next product? *Sloan Management Review*, Vol. 18, No. 2, pp. 63-74.
2. Korean Science and Engineering Foundation (1994): Science and Engineering Research Centre. Daejeon City. Korea.
3. Papanek, G. (1999): Az innovatív vállalatok illetve a K+F intézetek, egyetemek és hídképző intézmények együttműködése. GKI Gazdaságkutató Rt.
4. OMFB (1998): Technológia, foglalkoztatottság, versenyképesség az OECD országokban. OMFB, Budapest.
5. Shane, R. D. (1982): *About Technology Transfer*. Dekker E. N. York.
6. Szakály D. (2001): Transfer of Technology – Transfer of Knowledge. (In: *Business Studies. A Publication of the University of Miskolc.*) Vol 1, Number 1. Miskolc. Miskolc University Press. 2001. pp. 179-191.
7. Szakály D. (1999): Technológia transzfer – tudás transzfer. Felzárkózás, értékrend változás a vállalati és intézményi gyakorlatban c. konferencia. 1999. május 12-14. Miskolci Egyetem. Miskolc-Lillafüred. pp. 264-279.



FROM CRITICAL PATH TO CRITICAL FIELD

Wolfgang Tysiak

University of Applied Sciences Dortmund

Faculty of Business Administration

Emil-Figge-Straße 44, D-44227 Dortmund

Phone: +0231-755-4996

E-mail: Wolfgang.Tysiak@FH-Dortmund.de

Keywords: project management, risk management, PERT, Monte Carlo simulation

Abstract

Every project contains risks in at least one of the dimensions costs, time, and quality. Therefore in project management there is the strong need to perform an elaborated risk management. Especially the calculations with the stochastic estimates (probabilities, densities, distributions etc.) often cause problems in the quantitative risk analysis. Since 50 years the well-known PERT technique has been applied frequently, but there has never been any evaluation of this method. In this article we want to show the disadvantages, errors, and obstacles that occur if using PERT. The way to show this and to correct it is the use of the Monte Carlo simulation.

1. Introduction

In every project there is the need to implement some kind of risk management (cf. [1], [2]), which normally contains the following phases:

- (1) risk management planning,
- (2) risk identification,
- (3) qualitative risk analysis,
- (4) quantitative risk analysis,
- (5) risk response planning, and
- (6) risk monitoring and control.

Especially in the steps (3) and (4) some analytical/statistical methods are needed because you have to deal with uncertainties/insecurities and therefore with densities and distributions.

Risks in projects can occur in different dimensions, such as time, costs, quality etc. A risky event that may happen is normally characterized by two aspects: The probability of occurrence and the impact that is a consequence of this event. Both will have some probability distributions that have to be estimated in advance.

In this contribution we will only consider uncertainties related to time. A commonly used approach to deal with this is PERT (cf. [3], [4]), which has been developed 50 years ago. But there are some disadvantages, errors, and obstacles in using this method. We will discuss them and show how to overcome them by using the Monte Carlo simulation (cf. [5], [6]). We will do this by analyzing an example of a concrete project plan.



2. The Pert Approach

Let us look at the following example of a network plan and consider uncertainties in time. We assume that these uncertainties in time are already characterized in the steps (2) and (3) by estimating optimistic (OD), most likely (MD), and pessimistic (PD) durations:

Table 1

Project plan

Activity	Predecessors	OD	MD	PD
A	-	2	3	4
B	-	3	6	9
C	-	2	5	10
D	-	4	6	9
E	A, B, C	3	7	10
F	C, D	2	7	9
G	E	2	3	4
H	E, F	3	6	8
I	F	3	6	9
J	F	2	7	10
K	G, H, I	2	6	8
L	I, J	3	5	8

First of all we will solve the problem by using the well-known standard PERT method (cf. [3]).

PERT uses beta-distributions with the density f_b given by (1)

$$f_b(x|a,b,p,q) = \frac{(x-a)^{p-1}(b-x)^{q-1}}{B(a,b,p,q)} \quad (1)$$

with B being the beta-function

$$B(a,b,p,q) = \frac{\Gamma(p)\Gamma(q)}{\Gamma(p+q)}(b-a)^{p+q-1} \quad (2)$$

and Γ being the well-known gamma-function:

$$\Gamma(x) = \int_0^{\infty} t^{x-1} e^{-t} dt \quad (3)$$



In order to fit a beta distribution in the way that $\min = OD$, $\max = PD$, and $\text{mode} = MD$, estimates for the expected duration (ED) and the standard deviation (STD) of the beta distribution are needed. They can be obtained by

$$ED = \frac{OD + 4 \cdot MD + PD}{6} \quad STD = \frac{PD - OD}{6} \quad (4)$$

which leads to the transformations

$$a = OD$$

$$b = PD$$

$$p = \frac{ED - OD}{PD - OD} \cdot \left[\frac{(ED - OD)(PD - ED)}{STD^2} - 1 \right] \quad (5)$$

$$q = \frac{PD - ED}{ED - OD} \cdot p$$

Figure 1 shows three examples of beta distributions with different combinations of values for OD, MD, and PD (1/3/20, 1/8/15, and 2/18/20).

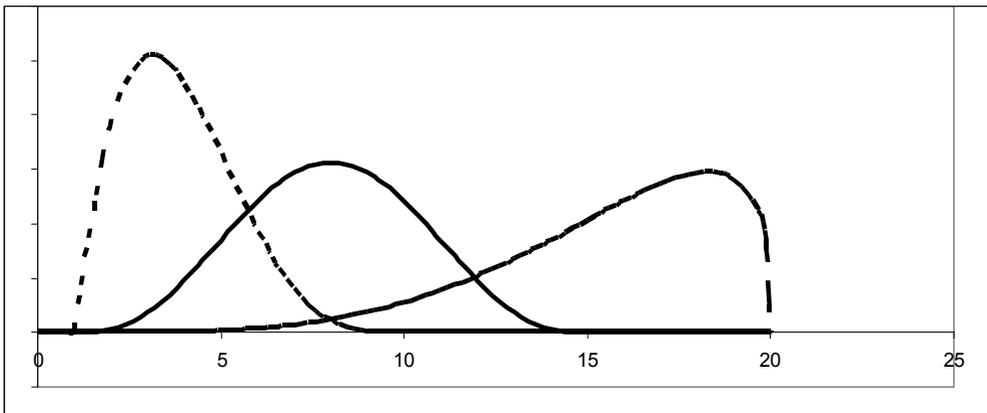

Figure 1. Different beta distributions

In fact all this mathematical background is primarily necessary to generate the individual distributions in the Monte Carlo approach. They are needed to create the random numbers in the following Monte Carlo simulation, but not in the application of PERT. The original PERT approach only uses the formulas (4) and then creates the critical path based on the EDs of the individual activities. Table 2 shows the given means (EDs) and variances of the individual tasks. Figure 2 gives us the critical path that follows.



Table 2

Project Plan with expected durations and variances assuming Beta distributions

Activity	Predecessors	OD	MD	PD	ED	VAR
A	-	2	3	4	3.000	0.111
B	-	3	6	9	6.000	1.000
C	-	2	5	10	5.333	1.778
D	-	4	6	9	6.167	0.694
E	A, B, C	3	7	10	6.833	1.361
F	C, D	2	7	9	6.500	1.361
G	E	2	3	4	3.000	0.111
H	E, F	3	6	8	5.833	0.694
I	F	3	6	9	6.000	1.000
J	F	2	7	10	6.667	1.778
K	G, H, I	2	6	8	5.667	1.000
L	I, J	3	5	8	5.167	0.694

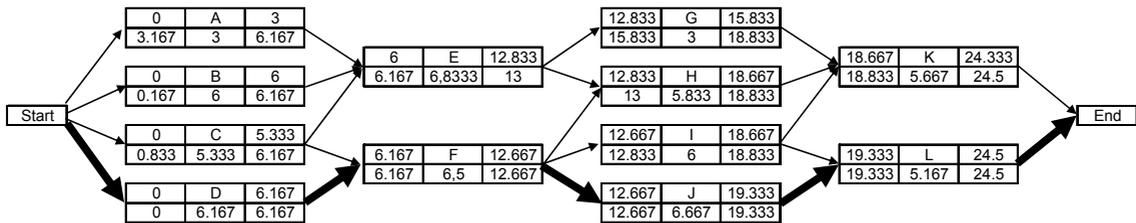

Figure 2. Critical path (bold arrows) of the project

In the first row of each task we see the values of the early start time (EST), the label, and the early finish time (EFT) of each activity, whereas the second row shows the late start time (LST), the duration, and the late finish time (LFT). So we get the indicated critical path (bold arrows) with a total length of 24.5 days.

Then the cumulated distribution (convolution) along the critical path is observed. Because all the distributions are assumed to be independent, due to the Central Limit Theorem, the result tends to a normal distribution with mean and variance as the sum of the individual values on the critical path. In our example we get a mean of 24.5 and a variance of 4.528. The resulting density is shown on the left side in Figure 3.

Although this approach has been widely used in the last 50 years, Harvey Maylor [7] says: "Moreover, many of the traditional methods of project planning such as PERT [...] have never been the subject of any evaluation – not least because, until recently, there was no alternative." But today – we want to add here – we have a very powerful alternative: Monte Carlo simulation.

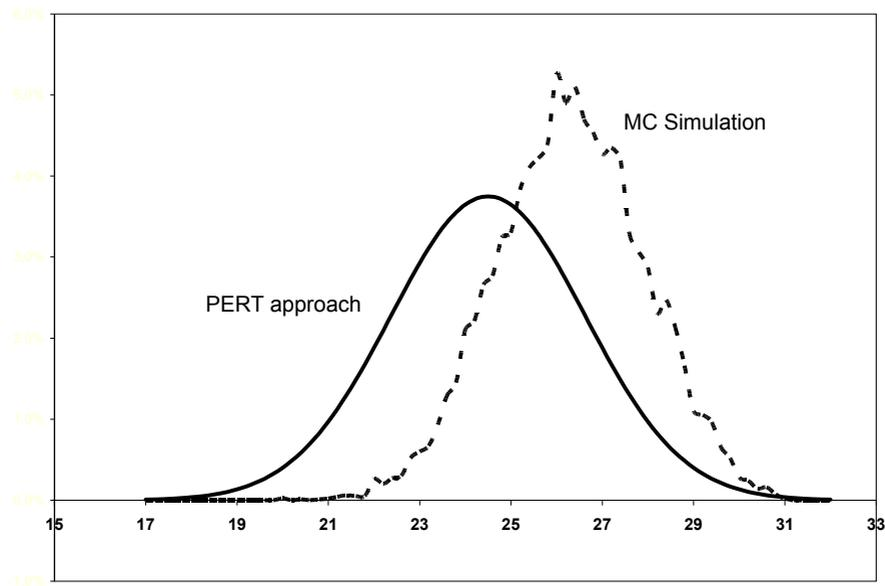

Figure 3. Results of MC simulation with beta distributions versus PERT results

3. Monte Carlo Simulation

As commonly known Monte Carlo simulation is a method that relies on repeated random sampling from given distributions [6]. Because of their reliance on repeated computations and random or pseudo-random numbers, Monte Carlo methods are most suited to calculations by computers. The main idea in applying Monte Carlo methods with computers lies in the fact that one has to model the problem just for one instance and can then create as much instances as you want by creating a loop or by copying it (like in Excel). In our case we create 10,000 instances.

In this section we solve the given example with the Monte Carlo method. The simulation will be performed with the familiar EXCEL tool (cf. [8], [9]). Using the transformations given in (5), you can easily use the built-in function BETAINV to generate beta distributed random numbers. We perform a Monte Carlo simulation by exactly simulating the given beta distributions for each activity. The result is shown in the graph on the right hand side of Figure 3.

The continuous line is the already mentioned normal distribution that resulted out of the original PERT approach with a mean of 24.5 and a variance of 4.528. The dotted line shows the distribution of the results of the Monte Carlo simulation with a mean of 26.308 and a variance of 2.633. It is obvious that the Monte Carlo simulation leads to averages that are about 2 units higher than those of the original PERT approach, but with a smaller variance. The reason will be shown in the following simple illustrative example.

4. A Simple Illustrative Example

To illustrate the above effect in Figure 3 we create a very simple example: Let us assume that we only have two parallel and independent tasks with estimated durations that are normally



distributed with a mean of 20 and a standard deviation of 4 for both tasks. The distribution function of that normal distribution shall be denoted by Φ , the corresponding density by φ . Then the PERT approach would lead to two parallel critical paths with both having a normal distribution with the given parameters. Since in fact the duration of the whole project is nothing else than the maximum of the two independent tasks, the real distribution function is just Φ^2 , with the corresponding density function $[\Phi^2]' = 2 \cdot \Phi \cdot \varphi$. In Figure 4 the two distributions are compared and the similarity of this chart and Figure 3 is quite obvious.

To understand the problem of PERT more clearly, imagine you have one distribution with a mean of 20 and the other with a mean of 20.000001. Then PERT gets a unique critical path, whereas in practice you will still have two parallel paths.

Since in the analytic determination of the critical path one always has to use the operation of building the maximum. Therefore if only distributions for the duration are known, this will not lead to only one unique critical path, but to different parallel critical paths that occur with some probability. And as always the maximum characterizes the real final end of the project, the theoretical end will always be later than that of the PERT approach. This shifts the whole distribution to the right. On the other hand the upper extremes of the final end (the right tail of the distribution) will be almost the same in the PERT and the theoretical approach. Therefore the variance is reduced. In the example, the mean of the theoretical distribution rises to about 22 and the standard deviation reduces to about 3.2. The increase of the mean and the reduction of the variance obviously depend on the individual structure of the given project plan.

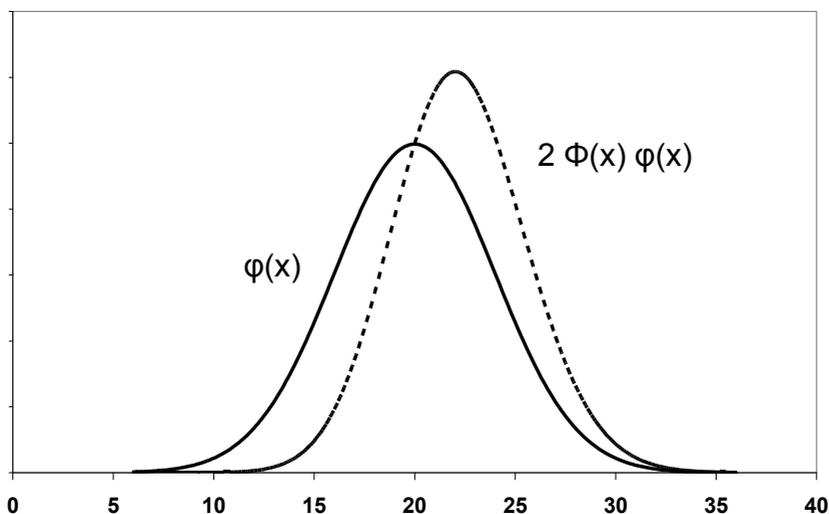

Figure 4. PERT and theoretical result of the 2-task-example

5. The Critical Field

As seen in this simple example we get the same effect when moving from PERT to the “real” distribution created by Monte Carlo simulation, with a higher mean and a lower variance. This relies in the fact that the PERT approach is a little inconsequential: Although it is a stochastic approach, it uses the deterministic approach for the construction of the critical path



(cf. Figure 5). But as soon as you move from the stochastic approach to the deterministic one, there is only little chance to get a valid result.

The main reason for this can be seen in the simple example: **There is no unique critical path** – we have two parallel critical paths. And we have the same in our main example: We will get critical paths that vary from case to case. Figure 6 shows in how many of the 10,000 cases the individual tasks belong to the critical path.

In Figure 6 the shading indicates the probability of a task to be critical: The darker the shading, the higher is the probability that the activity belongs to the critical path. It can be seen that we have tasks that are never critical (like A and G), some are sometimes critical (like B, C, E, I, J, and L) and some are quite often critical (like D, F, H, and K). But a comparison with Figure 2 shows that the latter are not identical with the critical path of the deterministic approach that was used by PERT. Therefore in the stochastic approach it is no longer reasonable to use the term “critical path” – we always have **critical fields**.

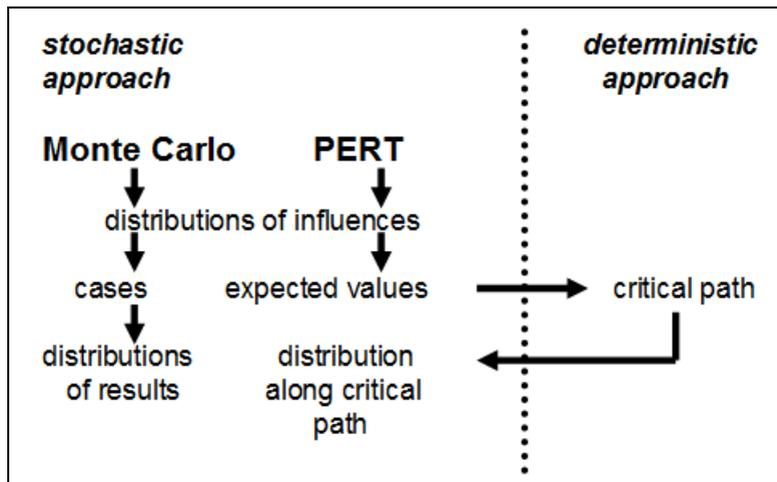

Figure 5. Stochastic versus deterministic approach

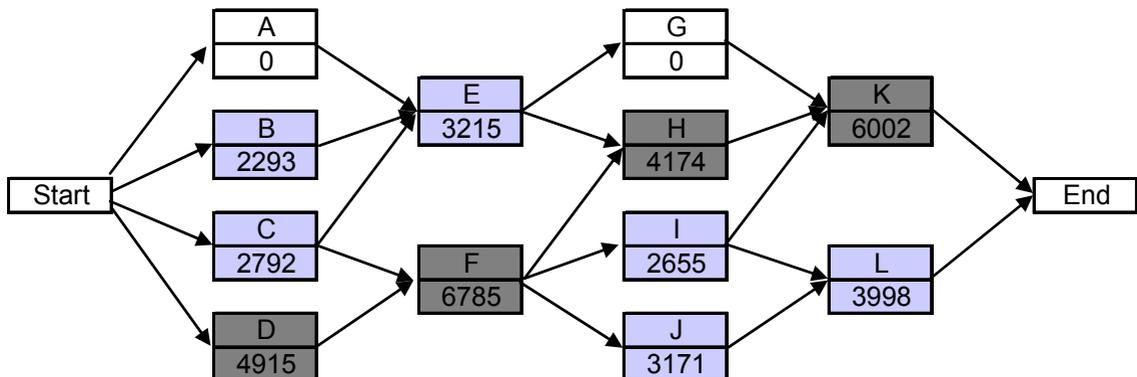

Figure 6. How often is an activity critical in the main example?



6. Conclusion and Remarks

PERT can only be seen as a first step of introducing insecurities in the time planning process within projects. In using the critical path method, PERT implies parts of the deterministic approach and therefore the results are distorted. In the stochastic approach there is **no unique critical path**, we only have a **critical field**. Therefore the whole process of buffer allocation has to be seen in a total different way and has to be performed similar to the critical chain approach. Monte Carlo simulation is a technique to overcome these failures of PERT.

Apart of this the Monte Carlo approach additionally offers the opportunity to implement more flexibility into the models. For example the use of other distributions than the beta distribution has to be mentioned. Also the shape of the resulting distribution is created empirically and not assumed to be normal. It is also possible to consider correlations or other dependencies/conditions between individual activities. Here you may think of the case that if an activity starts in a given period, the probability for a longer duration increases (c.f. [8], [9], [10]). These possibilities cover almost everything that is part of any simulation language or tool box.

References

1. PMI (ed.): *A guide to the project management body of knowledge*, (PMBOK®Guide) PMI 2010.
2. Schell/Ottmann/Pfeiffer: *Project Manager*, GPM German Association for Project Management, 2006.
3. Kerzner: *Project Management*, John Wiley & Sons, Hoboken, New Jersey, 2009.
4. Taylor: *Introduction to Management Science*, Pearson, Prentice Hall, 2010.
5. Garlick: *Estimating Risk*, Aldershot, Gowen 2007.
6. Rubinstein/Kroese: *Simulation and the Monte Carlo Method* (2nd ed.) New York: John Wiley & Sons 2007.
7. Maylor: *Project Management*, Pearson, Harlow, 2010.
8. Tysiak/Sereseanu: *Monte Carlo Simulation in Risk Management in Projects Using Excel*, Proceedings of the Fifth IEEE Workshop on Intelligent Data Acquisition and Advanced Computing Systems, Technology and Applications (IDAACS'2009), Rende, Italy, IEEE Service Center Piscataway 2009.
9. Tysiak/Sereseanu: *Project Risk Management Using Monte Carlo Simulation and Excel*, International Journal of Computing, Vol. 9, 2010, Issue 4.
10. Tysiak: *Risk Management in Projects: The Monte Carlo Approach versus PERT*, Proceedings of the Sixth Conference on Intelligent Data Acquisition and Advanced Computing Systems: Technology and Applications (IDAACS'2011), Prague, Czech Republic, IEEE Service Center Piscataway, 2011.



PROJECT MANAGEMENT MATURITY AND RISK MANAGEMENT DOCUMENTATION

Juris Uzulāns

University of Latvia

Aspazijas bulv. 5, Riga, LV-1050, Latvia

Phone: +371 29283194

E-mail: jouris@latnet.lv

Keywords: Project, Maturity Model, Project Risk

Abstract

Risk management constitutes an important part of the project management process. Risk management process includes identifying, analysing, and planning activities to control potential events within the project. Respectively all risk management activities are documented.

Project management maturity models (for example, Organizational Project Management Maturity Model (OPM3) from the Project Management Institute, or Portfolio, Programme & Project Management Maturity Model (P3M3)) from the Office of Government Commerce, UK) provide a path for organizations to assess themselves against the criteria defined for the current project management maturity level and for improvement plans.

The criteria defined for project management maturity evaluation are also useful for risk management documentation evaluation and provision for an effective documentation development process. The author analyses risk management documentation according to the maturity levels.

Research Objective

The research objective is to assess the project risk management documents publicly available in the Internet in accordance with the project management maturity model levels and to design recommendations for risk management documentation in accordance with the maturity levels.

Theoretical Foundation of the Research

The theoretical foundation of the research is the project management maturity model OGC (Office of Government Commerce) Portfolio, Programme, and Project Management Maturity Model or P3M3 model that comprises three individual models – Portfolio Management Maturity Model (PfM3), Programme Management Maturity Model (PgM3) and Project Management Maturity Model (PjM3) [3, p. 7]. The research dealt with the analysis of risk management project documents therefore only one of the three models was used – the project management maturity model (PjM3) [9]. Like the other two models, the project



management distinguishes five maturity levels and 7 processes, including the risk management process [2, p. 2]. The P3M3 model maturity levels are as follows: Awareness of Process (respectively level 1), Repeatable Process (2), Defined Process (3), Managed Process (4) and Optimized Process (5) [2, p. 7].

The maturity level is characterized by specific and general attributes. In order to analyze risk management project documents the author created a table where he grouped the attributes that can be used for the assessment of risk documentation in accordance with the maturity levels.

As the first maturity level, Awareness of Process, is in project management described as project management without standardized processes [2, p.8], the author did not analyze the compliance of risk management project documentation with the first level of maturity assuming that there are insufficient criteria to establish the compliance of the documents to the first level of maturity, i.e. any risk management project document can comply with the first level of maturity (see table 1).

Table 1

Maturity level attributes that can be used for the assessment of risk management project documentation

Maturity level	Attributes	Corresponding risk management documentation attribute
2	Uniqueness of the Project processes and procedures Minimal connection of the Project processes with the standards Documenting and control of the Project status and deliverables in relation to the milestones. Fragmented involvement of the organization management	Documents do not contain references to other processes or procedures that are not the processes or procedures of a specific project (attribute 2.1.). Documents do not mention standards or if the standards are mentioned the way of using the standards cannot be identified (2.2.) Risk analysis might involve the using of the term ‘milestones’ (2.3.) The role of the organization management in risk management is not described (2.4.)
3	Integrated control of the project processes Processes and procedures have certain aims, starting criteria, action steps, checking steps, results and finalizing criteria Project processes are documented, standardized and integrated with other processes Process owners are responsible for the process progress, compliance and improvement Permanent participation of the organization management	Reference to the risk management process having an integrated control with other project management processes. (3.1.) Risk management process description that comprises the aims, starting criteria, action steps, checking steps, results and finalizing criteria (3.2.) Reference to the processes that are not the project processes (3.3.) The responsibility scope of the process owners is described (3.4.) The kind of the permanent participation of the organization is described (3.5.)



Project Management Development – Practice and Perspectives

First International Scientific Conference on Project Management in the Baltic Countries

February 8-9, 2012, Riga, University of Latvia

Maturity level	Attributes	Corresponding risk management documentation attribute
	<p>Standard templates and methods are applied in risk management</p> <p>Risk management comprises all project lifecycle</p> <p>Risks are divided in categories</p> <p>Risk escalation process</p> <p>Both the risk impact on the project objectives as well as larger influence of risks is assessed</p>	<p>References to the standard template and method, examples of the standard templates, descriptions of methods (3.6.)</p> <p>Risk management description in accordance with the project lifecycle (3.7.)</p> <p>Risk category description (3.8.)</p> <p>Risk escalation process description (3.9.)</p> <p>Description of the risk impact on the project objectives (3.10.)</p>
4	<p>Application of metrics and quantitative methods in the process control</p> <p>Certain process measurement results are summarized and compared to the measurements of organizational processes</p> <p>Permanent and active involvement of the organization management</p> <p>The effect of risks on the resources over the project lifecycle is assessed</p> <p>The audit of risk management effectiveness</p> <p>The risk management process has the process owner</p> <p>Possible existence of the risk manager</p> <p>Adoption of decisions by considering the assessment of risks</p>	<p>Description and examples of the application of metrics and quantitative methods in the process control (4.1.)</p> <p>Description of the measurement of risk management processes and comparison of the measurements (4.2.)</p> <p>Description of the kind of the organization management involvement (4.3.)</p> <p>Description of the risk effect assessment on the resources over the project lifecycle (4.4.)</p> <p>Description of the effectiveness of the risk management audit or description when the audit of risk management effectiveness is made (4.5.)</p> <p>Description of the risk management process owner's role (4.6.)</p> <p>Possible existence of the risk manager's role description (4.7.)</p> <p>Application description of the results of risk analysis in the adoption of decisions (4.8.)</p>
5	<p>Continuous process improvement and optimization</p> <p>Active use of the previous experience and active distribution of knowledge</p> <p>Organization management is involved in risk management</p> <p>All decisions are adopted by considering the risk assessment</p> <p>Close integration of the risk management process with other processes of project management</p>	<p>Description of the risk management process improvement and optimization (5.1.)</p> <p>References to the previous experience in risk management, description of the way of the risk management experience accumulation (5.2.)</p> <p>Description of the organization management roles and ways of involvement (5.3.)</p> <p>Description of the risk analysis results in the adoption of decisions and description of control (5.4.)</p> <p>Description of the integration of the risk management process with other project management processes (5.5.)</p>

The most appropriate kind of the risk management documents to be assessed with the attributes of maturity levels is the risk management plan. Project management literature does not present a unanimous opinion on the contents of the risk management plan. For



example, A Guide to the Project Management Body of Knowledge risk management plan is a document that describes how risk management will be structured and performed within the project. In general the risk management plan includes the following parts of the document – methodology, roles and responsibilities, budgeting, timing, risk categories, definitions of risk probability and impact, probability and impact matrix, revised stakeholder's tolerances, reporting formats, and tracking [1, pp. 279-282]. Risk Management Guide For DoD Acquisition risk management plan contains introduction, program summary, risk management strategy and process, responsible/executing organization, risk management process and procedures, risk identification, risk analysis, risk mitigation planning, risk mitigation implementation, and risk tracking [4, p. 23]. Tasmanian Government Project Management Guidelines, Version 6.0 - March 2005 risk management plan includes the process for identification, analysis, evaluation and treatment of risks, both initially and throughout the life of the project, including estimated costs, the process for transferring approved risk costs into the project budget, the process for transferring risk mitigation activities into the project Work Breakdown Structure, how often the Risk Register will be reviewed, the process for the review and who will be involved, how Risk Status will be reported and to whom, who will be responsible for which aspects of risk management, and include, as an appendix, a snapshot of the major risks, current gradings, planned mitigation strategies and costs, and who will be responsible for implementing any mitigation strategies [5, p. 52].

If we compare the risk management plans from the indicated project or risk management descriptions (manuals) with table 1 it can be concluded that full-fledged risk management is possible only at a high degree of maturity – the fourth or fifth one. However, it is useful to assess what risk management plans publicly available in the Internet are.

Research Description

For the research purposes the author used the risk management plan documents publicly available in the Internet. Search was made in June, 2011 by using the Google search engine. The search request was “"risk management plan" +"project" site: gov” and the author examined the first 400 links which were found.

All together 31 documents were selected. 21 of the documents were analyzed as regarding the rest the compliance with the attributes was not assessable (3 were document templates containing just the titles of document sections and a short explanation of the section contents, 3 documents did not contain sufficient amount of information for the analysis (the size of the documents was between 1 and 3 pages), 2 documents did not correspond to the contents of the risk management plan (the documents were risk registers), 1 document was a methodical material for composing a risk management plan).

The author assumed that the attributes of one maturity level are also referable to the next level unless they contradict with the attributes in the next level. Table 2 summarizes the attributes of risk management documentation by comprising the non-contradictory attributes of the previous levels.



Table 2

Risk management documentation attributes by the maturity level

Maturity level	Corresponding attribute of risk management documentation, number of attributes
2	2.1 – 2.4, total – 4 attributes
3	3.1 – 3.10, total – 10 attributes
4	3.1 – 3.4, 3.6 – 3.10, 4.1 – 4.8, total – 17 attributes
5	3.1 – 3.4, 3.6 – 3.10, 4.1 – 4.2, 4.4 – 4.8, 5.1 – 5.5, total 21 attributes

Consequently, the risk management plan that has ideal compliance with the maturity level must contain from 4 to 21 attributes. The compliance of the 21 selected documents with all attributes of the respective level of maturity has been summarized in table 3. It was assumed that a document complies with the maturity level if it corresponds to all of the maturity level attributes, including the attributes of the previous level (if the maturity exceeds level 2). When assessing the document compliance the author also took into account the attributes in the cases when unanimous identification of an attribute was not possible.

Table 3

Compliance of risk management documents with maturity level attributes

Maturity level	Number of documents
2	2
3	2
4	--
5	--

The total number of documents that comply with all attributes of the respective maturity level is 4 or 19% of the total number of documents. The total number of the necessary attributes 28, or 13%.

Table 4 summarizes the number of the identified attributes.

Assuming that all of the selected documents comply with the highest maturity level makes the total number of attributes account for 441. Thus the total number of the identified attributes (both unanimously identifiable and the ones that cannot be unanimously identified) represent 48% of the total number of attributes.

If the number of the non-unanimous attributes is subtracted from the number of the identified attributes, the number of documents with unanimously identified attributes corresponding to the respective maturity level is two and both of the documents represent the second maturity level, i.e., the total number of identified attributes is 8, or 6% of the number of the unanimously identified attributes.

Considering the total number of the identified attributes and the number of attributes by maturity level it is useful to carry out the analysis of the relation between the attributes and documents disregarding the maturity levels. The overall distribution of attributes has been



summarized in table 4. The documents listed in the table also include the ones that not only had all the attributes of the respective maturity, but also the attributes of the next level disregarding their mutual contradiction.

Table 4

Distribution of identified attributes

Attribute	Number of identified attributes	Number of identified attributes in cases when the attribute cannot be unanimously found in the document
2.1.	14	2
2.2.	16	1
2.3.	7	0
2.4.	10	5
3.1.	1	2
3.2.	9	10
3.3.	3	1
3.4.	1	7
3.5.	3	4
3.6.	11	4
3.7.	0	2
3.8.	8	0
3.9.	7	6
3.10.	7	6
4.1.	7	8
4.2.	0	2
4.3.	3	4
4.4.	4	3
4.5.	1	0
4.6.	2	6
4.7.	7	2
4.8.	2	0
5.1.	1	0
5.2.	3	2
5.3.	3	1
5.4.	2	0
5.5.	1	3
Total	133	81
Percentage of the total number of the identified attributes	62%	38%



Table 5

Number of documents by the number of attributes

Number of attributes	Number of documents
1 to 4 attributes	0
5 attributes	4
6 to 7 attributes	0
8 attributes	2
9 attributes	4
10 attributes	1
11 attributes	2
12 attributes	1
13 attributes	3
14 attributes	1
15 attributes	1
16 to 19 attributes	0
20 attributes	1
21 attributes	0
22 attributes	1
More than 22 attributes	0

If we assess the number of attributes according to the number of documents by the number of attributes presented in table 5, it can be concluded that the number of documents complying with a specific maturity level exceed 4.

Conclusions

1. The compliance of the selected documents with the maturity levels is to be considered low as only 4, or 19%, of the documents comply with all the attributes of the respective maturity level;
2. The total number of the identified attributes would correspond to 4 documents of the second maturity level and one document of the fifth maturity level if only the unanimously identified attributes were listed or 7 documents of the second level, 2 of the third one, 1 of the fourth level and one of the fifth level of maturity if all attributes were listed;
3. The total number of the identified attributes is sufficient for the compliance of all, i.e., 21 documents, with the 2nd and the third level maturity level, 14 documents with the fourth level and 10 documents with the fifth level;
4. In average 13.6 second maturity level attributes were identified among all the identified attributes, 9.2 third level, 6.4 fourth level and 3.2 fifth level attributes.



Project Management Development – Practice and Perspectives

First International Scientific Conference on Project Management in the Baltic Countries

February 8-9, 2012, Riga, University of Latvia

Recommendations

1. Based on the maturity model attributes criteria of project risk management documentation should be designed that could be unanimously identified and would success ively change in compliance with the maturity level;
2. 10 unanimously identifiable attributes must be chosen in compliance with the maturity levels as well as corresponding attributes of risk management documentation;
3. Project risk management documentation should be created in compliance with the attributes of risk management documentation following the maturity level of risk management.

References

1. A Guide to the Project Management Body of Knowledge. (PMBOK® Guide), Fourth Edition, Project Management Institute, 2008.
2. P3M3® – Project Model, version 2.1, OGC, s.a.
3. Portfolio, Programme and Project Management Maturity Model (P3M3®) Introduction and Guide to P3M3®, OGC, © Crown copyright 2010.
4. Risk Management Guide For DoD Acquisition, Sixth Edition (Version 1.0), August, 2006, Department of Defense.
5. Tasmanian Government Project Management Guidelines, Version 6.0, March 2005, © 2005 Crown Copyright.

List of documents used in the research

1. Risk Management Plan, Interoperability Montana, 2007. interop.mt.gov/content/docs/IM_Risk_Management_Plan_v4_0.pdf.
2. Risk Management Plan, bp.gsfc.nasa.gov/pub/BP-RMP-1.0.pdf.
3. OSI Risk Management Plan Template, [www.bestpractices.osi.ca.gov/sysacq/documents/Risk%20Management%20Plan%20\(3283\).doc](http://www.bestpractices.osi.ca.gov/sysacq/documents/Risk%20Management%20Plan%20(3283).doc).
4. Risk Management Plan Template, www2.cdc.gov/cdcup/library/templates/CDC_UP_Risk_Management_Plan_Template.doc.
5. Project Risk Management Plan for Department of Energy BMIS-FM Project, www.cfo.doe.gov/corpsyst/i-manage/STARS/ENG503-7RiskManagementPlan.pdf.
6. Risk Management Plan – WSDOT, www.wsdot.wa.gov/projects/projectmgmt/RiskAssessment/Risk_Management_Plan.xls.
7. Risk Management Plan – EmpowHR Home, www.empowhr.gov/9.0/Risk%20Management%20Plan%20v%201%20042408.pdf.
8. Risk Management Plan, www.hhs.gov/ocio/eplc/EPLC%20Archive%20Documents/05%20-%20Risk%20Management%20Plan/eplc_risk_management_template.doc.
9. Risk Management Plan – DoIT, doit.maryland.gov/SDLC/Documents/Project%20Risk%20Management%20Plan.doc.
10. Risk Management Plan, www.goes-r.gov/syseng/docs/RMP_V1-2-RO-5.pdf.
11. Risk Management Plan, www.phe.gov/about/amcg/toolkit/Documents/risk-management.pdf.
12. Sample Risk Management Plan Risk Management, www.nd.gov/itd/files/services/pm/risk-management-plan-sample.pdf.
13. Risk Management Plan for the EMD Project, edhs1.gsfc.nasa.gov/waisdata/emd/pdf/206emd001.pdf.
14. Risk Management, wiki.nci.nih.gov/download/attachments/8169221/1.1.1_RiskMgmtPlan_caAERS_version1-5.doc?version=2&modificationDate=1213391259000.



Project Management Development – Practice and Perspectives

First International Scientific Conference on Project Management in the Baltic Countries

February 8-9, 2012, Riga, University of Latvia

15. ABT Program Risk Management Plan, www.kingcounty.gov/operations/ABT/Programdoc/~/_media/operations/ABT/documents/DIPdocument/Appendix_P__Risk_Management_Plan.ashx.
16. Risk Management Methodology – Colorado.gov, www.colorado.gov/cs/Satellite%3blobcol%3Duardata%26blobheadername1%3DContent-Disposition%26.
17. ERA Risk Management Plan, www.archives.gov/era/recompete/risk-management-plan.pdf.
18. Risk Management Plan.doc – Nassau County, www.nassaucountyny.gov/agencies/IT/Docs/pmo_docs/Risk_Management_Plan.doc.
19. Risk Management Plan, www.ceba.gov/fm/construction/UIM/CD-1/Management/RMP_2_Aug_10.pdf.
20. IT Transformation [Insert Project] Risk and Issue Plan, www.cio.noaa.gov/NOAALink/docs/NOAALink_Risk_Mgt_Plan.doc.
21. Risk Management Plan for, www.ofm.wa.gov/edd/docs/edd_coa_risk_plan.pdf.



PROJECT RISK ASSESSMENT USING QUANTITATIVE METHODS

Agnese Vaivade

Faculty of Economics and Management

University of Latvia

Aspazijas bulv. 5 – 332, Riga, LV-1050, Latvia

Phone: +371 27842737

E-mail: vaivade.agnese@gmail.com

Dr.oec. Edgars Brēķis

Faculty of Economics and Management

University of Latvia

Aspazijas bulv. 5 – 332, Riga, LV-1050, Latvia

Phone: +371 67034746

E-mail: edgars.brekis@lu.lv

Keywords: project management, risk management, risk assessment, qualitative choice models, probabilities

Abstract

Risk management is one of the main factors that improve project results in each phase of its implementation. Quantitative methods of risk management give opportunities to evaluate numerically different aspects of a project and to find causes of risks. Mostly, these methods are based on expert judgments, their previous experience or historical data.

The aim of this paper is to propose an approach to project risk management based on the application of quantitative methods to projects that may differ in size and belong to various economic sectors, but which are similar in their main objectives.

The paper considers an example of data analysis of project approval of the European Regional Development Fund Program “Business and Innovations” (activity no. 2.3.2.2). The main objective of the activity is to promote business development in underdeveloped territories. The paper will explore the application of the LOGIT model to estimate probabilities of project approval in Latvia. Qualitative choice model is used to estimate factors that influence project approvals in the first project phase – submission of project proposal. The result shows that the probability of project approval is mostly affected (1) by the development index of underdeveloped territories and (2) by the intensity of structural funding that is planned within project submission, and this is consistent with the main objective of the named activity of the European Regional Development Fund Program “Business and Innovations”.

Introduction

Risk management is a process that is used to evaluate potential risks and to allocate them in categories, followed by a definition of action to reduce these risks. [1]. Risk management is a



systematic approach – risk management methods must be used during project preparation and all implementation phases. [2]. The higher the costs of the project and more people or departments involved, the higher risks are expected. Risk management helps to avoid risks before their occurrence; it locates resources to reduce probability of risks to the minimum. Risk management is an identification process of potential hazards and unwanted events; it helps to understand the probability and consequences of risks and, if necessary, starts managing measures for highest risks. [3].

One of the main objectives of risk management implementation is transition to preventive reactive mode when hazards are avoided before their occurrence, so that minimal risks appear. Project risk management process can be divided into three major groups: identification, analysis and evaluation, and action:

1. Identification:
 - a. Of project characteristic factors;
 - b. Of risk types;
 - c. Of the project risk level influencing criteria etc.
2. Analysis and evaluation:
 - a. Evaluate risk probability and consequences (effect on the project);
 - b. Determine the level of risk;
 - c. Analyze the causes of risk;
 - d. Choose the best solution etc.
3. Action:
 - a. Operations with risks;
 - b. Implementation of action plan;
 - c. Controlling and monitoring the results etc.

Risk awareness and its quantitative evaluation helps to make the necessary decisions related to execution of the plan at the prerequisite level of quality, time and cost. [4]

There are three main methods of risk analysis: (1) the simplified risk analysis, (2) the standard risk analysis and (3) the model-based analysis.

- (1) The simplified risk analysis is more qualitative and informative procedure that creates a risk picture using the “*Brain Storm*” meetings or discussions in groups. The initial level of risks is presented as low, medium or high risks, it also states what preventive actions should be implemented. No further risk analysis methods are used in this method.
- (2) The standard risk analysis is more formalized procedure which uses recognized risk analysis techniques such as *HAZOP* and *Coarse risk analysis*, both qualitative and quantitative analysis methods are used. Matrices of risks are widely used to present results of the risk analysis.
- (3) The model-based risk analysis for risk evaluation and estimation includes such techniques or methods as an “*Event Tree*” analysis, “*Lac and Error Tree*” analysis. Variety of mathematical or statistical methods or simulations can be used. All of them are quantitative analysis methods.

The aim of this paper is to propose an approach to project risk management based on the application of quantitative methods to projects that may differ in size and belong to various economic sectors, but these projects are similar in their main objectives.



This paper considers an example of data analysis for project approval of the European Regional Development Fund Program “Business and Innovations” (activity no. 2.3.2.2). The main objective of the activity is to promote business development in underdeveloped territories. In the first section of this paper primary data analysis is used – the project activity is characterized and qualitative data analysis is carried out before using quantitative methods. In the second section of the paper the application of the LOGIT model is explored to estimate probabilities of project approval in the program mentioned above. In the 3rd section there is a description of the simulation and factors that influence project approvals in the first project phase – submission of project proposal, using estimates of project approval probabilities. [5]

1. Data Description and Primary Data Analysis

The aim of the empirical part was to analyze results of the first two rounds of European Regional Development Fund (ERDF) Operational Program “Entrepreneurship and Innovations” additional sub-program activity no.2.3.2.2 by LOGIT [6] model. The project proposal results (whether it is approved or not) are analyzed.

The responsible institution of the program: Ministry of Economy.

The monitoring institution: Latvian Investment and Development Agency.

The aim of the activity is to promote business development in specially supported territories, thereby reducing unacceptable differences among regions and regional areas, to improve balanced development of the country (from the Cabinet of Ministers regulations No.197 in Riga, 24 February, year 2009, protocol No. 14.57§).

The foundation is provided for the following long-term investments:

1. Investments in fixed assets:
 - a. Purchase of new techniques and equipment;
 - b. Renovation and construction of industrial production buildings (for start-up businesses this activity cannot exceed 50% of total project costs);
2. Investments in intangible assets as patents and license purchase.

The maximum funding available per one project is 150 000 Latvian Lats (the project proposal can be prepared by one person or a group of persons). The maximum co-financial intensity is 55%. The implementation time of the project should not exceed 24 months.

One company can submit more than one project proposal but each next proposal may be submitted when the previous project has finished and the final report is submitted or after the first proposal rejection.

There were other criteria estimated in monitoring institution:

- a. When implementing the project will / will not the load on the environment be reduced;
- b. When implementing the project will / will not economic energy resources be used;
- c. When implementing the project will / will not the production and processing methods that reduce the impact on the environment in all product life cycle be initiated;
- d. When implementing the project will / will not “green procurement” principles be used;
- e. The project has a positive / neutral impact on the target priority – information for society;
- f. There will be an IT solution developed in the project;
- g. There will be an IT service etc. developed in the project.



At the beginning results of the first and second program rounds were summarized (they were two separate project proposal competitions and were not one by one following rounds for one project proposal). In the summary number of approved and rejected projects is listed, as well as number of signed contracts (this is due to the fact that project acceptance doesn't mean that contract must be signed, the person can choose whether to do the project or not), and few other characteristic variables: total eligible costs; co-financing from structural fund; project implementation time in months and the territory where project will be implemented.

In addition to the primary information more variable characteristics were obtained and overall following variables in LOGIT model were used:

1. The distance between territory where project will be implemented and Riga in kilometers (the site *map.google.lv* was used);
2. Total eligible costs of project;
3. The Structural Fund co-financing;
4. Duration of project implementation in months;
5. The project result “approved / rejected” is defined as:
 - 5.1. 0 – rejected;
 - 5.2. 1 – approved;
6. During the modeling additional variables were added:
 - 6.1. Co-financing of total eligible costs in percent (or the co-financial intensity);
 - 6.2. Depending on the co-financing intensity – assigned score for project from the monitoring institution (Cabinet of Ministers Regulations No. 197 Article No. 25);
 - 6.3. Territory development index (for undeveloped territories it is negative);
 - 6.4. The population in the particularly supported territory.

After the variable preparation, but before use of the quantitative method, it is necessary to do the quality analysis of data, which means to evaluate the compliance for statistical models and to see if data matrices do not contain fictive data. For the qualitative data analysis the data was grouped by the project location in planning regions.

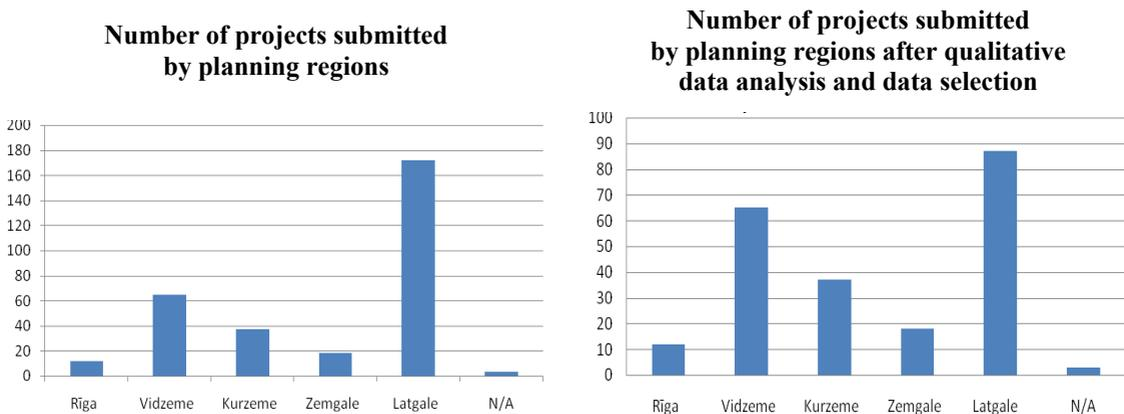

Figure 1. Number of Submitted Projects by Planning Regions before and after Data Correction

The numbers of project proposals by the planning regions are shown in the Figure 1. As it can be seen in Figure 1, Latgale region is dominating in this field of study, there are almost



three times more project proposals than in Vidzeme (Latgale region is most undeveloped region in Latvia) and even more than other regions. As the result of qualitative data analysis 76 observations were removed, as they could be considered to be fictive data: 90% of these project proposals by groups had the same project indicators (for example, the same implementation time, total cost of project, the same project target, territory of project implementation etc.), it shows that one and the same project submitters had written many proposals thinking that at least one of the projects will be accepted.

After the correction of data one can see changes in total number of projects by planning regions. Latgale still has the dominant role but the difference between numbers of submitted projects compared to Vidzeme is only 20.

2. Estimation of Probabilities of Project Approval

Symbols used in statistical programs and modeling:

1. P – the project is approved (1) or rejected (0);
2. C – constant (with no economical interpretation, only to know the model coordinates);
3. KOP – total eligible project cost (in Latvian Lats);
4. STRUKT – requested co-financing from structural funds (in Latvian Lats);
5. T – the project implementation duration in months;
6. KM – the project location distance from Riga (in kilometers);
7. INDEX – development index of specially supported territory where the project is located;
8. PROC – structural fund intensity required as a percentage of KOP;
9. 18-PUNKTI – maximum number of points (18) minus points attained during the project evaluation process depending on PROC;
10. IEDZ – population in the project location.

Before the modeling starts it is necessary to understand economical interpretation of each variable and to determine, which sign (positive or negative) is expected.

It is expected that factor – the project total eligible costs – will be negative. It describes that increase in the total eligible project cost reduce the probability of project to be approved, a negative coefficient with a similar interpretation can be expected for another variable – structural co-funding.

There is no one logic about relationship between the project implementation period in months and the possibility for project to be approved, but most probably the relationship is positive – probability for project to be approved increase if the project implementation period is longer (risk for the project to be extended decreases).

For project location evaluation the KM variable was created (location distance from Riga in kilometers). As the program is focused on particularly supported areas that mostly are in countryside, it should be approved that KM coefficient will be positive – the further project location from Riga, the higher probability for project to be approved.

For each particularly supported territory the development index has been assigned that is negative for these territories. From economical interpretation it is expected that the coefficient of variable INDEX will be negative – the probability of the project to be approved increases, as the INDEX is more negative (variable decrease).



When evaluating the intensity percentage of structural co-financing, the coefficient of variable is expected to be negative – the increase in intensity (percentage) decreases the probability for project to be approved. It is also associated with the first and second variables – the higher the total eligible costs or requested structural fund co-financing, the lower the probability of approval.

From the project evaluation methodology in the monitoring institution projects with lower requested co-financial intensity have attained more points (18 points are maximum). It means that increase in points gives lower co-financing intensity. So the variable (18-PUNKTI) is created and the coefficient of this variable is expected to be positive.

As one of the targets for year 2013 is to reach 32 economically active businesses to every 1000 inhabitants, it is expected that the larger the population in project location is, the higher is the probability for project to be approved.

The first basic model is prepared that includes all eight variables. McFadden determination coefficient is relatively high but it is acceptable because it is a binary model, although five of the eight variables in this model are not statistically significant at the 90% confidence level; it shows that the model contains insignificant variables and still it is possible that explanatory variables are missing. There is also a multi-co-linearity problem in the model, ie., when several variables correlate with each other. In this case they are variables (18-PUNKTI) and PROC, as well as KM and INDEX because, if one looks at the situation of Latvia, locations further from Riga have a lower development level (more negative INDEX).

Table 1

Comparison of Models Parameters

Variables	First model		Second model		Third model		Fourth model		Fifth model	
	Coefficient	P-stat	Coeff.	P-stat	Coeff.	P-stat	Coeff.	P-stat	Coeff.	P-stat
C	-0.03759	0.9891	-0.367327	0.5285	-0.323678	0.3261	-1.751716	0.0686	-1.02065	0.0719
KOP	-2.47E-06	0.6528								
KOP/T			-1.51E-05	0.0986	-1.82E-05	0.0529	-1.53E-05	0.1087	-1.58E-05	0.0937
STRUKT	-1.85E-06	0.8975								
T	0.0826	0.0013								
KM	0.000323	0.9066	0.001017	0.6916						
INDEX	-0.400552	0.0692			-0.357588	0.0887	-0.393841	0.0583	-0.383052	0.0664
18-PUNKTI	0.133071	0.1083	0.094214	0.0060	0.085035	0.0135				
PROC	-0.033566	-0.6406					0.042984	0.0522		
PROC^2									0.000609	0.0312
IEDZ	0.000129	0.0016	0.000142	0.0003	0.000129	0.0011	0.000124	0.0016	0.000126	0.0014
McFadden	0.129478		0.090227		0.100862		0.08998		0.093691	
Prob. LR stat.	1.44E-05		3.82E-05		1.03E-05		4.29E-05		2.64E-05	
H-L stat.	4.3131		5.7303		6.8197		3.6485		5.7835	
Andrews stat.	5.7106		5.8079		7.5278		5.4988		6.2241	

Due to the multi-co-linearity problem, it is necessary to find which variables of these are more statistically significant to the project approval result. Two models are prepared that both have variables: KOP/T (during analysis it was found out that variables KOP and T are not statistically significant but variable KOP/T is statistically significant); (18-PUNKTI) and IEDZ,



but in first model the fourth variable is KM while in the second model – INDEX. All in all more than 20 models were estimated in empirical analysis but only statistically significant models are evaluated and analyzed in this paper, it is also important that the economical interpretation is appropriate.

As *Table 1* shows, for the model that contains all explanatory variables the parameters are statistically significant within 90% confidence level, except parameter KM, whose influence to the result is not straightforward. Since the LR statistical probability is practically zero, the hypothesis that all coefficients are zeroes simultaneously is rejected. Goodness-of-fit test shows: a hypothesis that the specification of the model is adequate cannot be rejected (low HL and Andrews statistics values).

The next model uses the same variables, except INDEX is used instead of KM. It is visible that within 90% confidence level all coefficients are statistically significant, including the variable INDEX. It can be concluded that the INDEX is better characterizing variable than KM. It can be explained that the location development level regardless how far they are from Riga, is different: there are several regional interest or local interest centers (larger cities) with higher development levels than rural territories. For example, Valka is 160 km far from Riga and the INDEX is -0,796 but 150 km from Riga there is another city called Rujiena with development index -1,104 (Valka is larger city than Rujiena). The LR statistics is close to zero – all coefficients are not zeroes simultaneously. Although both HL and Andrews statistics have increased, their values are still low, that tells us that specificity of model cannot be rejected.

The second problem could be that the intensity percentage of structural fund co-financing is probably not linearly related to the project approval result but there could be a parabolic relation: it is possible that there is a maximum percentage level that gives the highest probability for the project to be approved but when the co-financial intensity is lower or higher the probability decreases. So it is necessary to analyze model with a variable PROC² and evaluate if it is better than the model with variable PROC (linear relationship). In those models the variable (18-PUNKTI) is not included since, as previously mentioned, there is a tight correlative relation between (18-PUNKTI) and PROC.

The model with linear relationship (variable PROC) consists of three statistically significant variables within 90% confidence level, including PROC, but the variable KOP/T is not statistically significant. LR statistical probability is close to zero. If the variable T is used instead of KOP/T, the statistical significance level increases, McFadden determination coefficient reaches 0.11 but HL and Andrews statistics are relatively high. It shows that the specification of model is not chosen correctly, for this reason even the variable KOP/T is not statistically significant (within 90% confidence level), it gives a better specification and better describes the model than variable T does. The model with variable PROC has low HL and Andrews statistics, it indicates that the error of chosen specification may be rejected.

During the research a model that contains both PROC and PROC² was also analyzed but the variable PROC within 90% confidence level is not statistically significant, also Goodness-of-fit test has very high HL and Andrews statistical coefficients, so it was decided to dismiss the variable PROC. The combined interpretation of variables PROC and PROC² denotes a peak in the frame of reference, but as the PROC is not statistically significant and specification of model is not adequate, then it can be concluded that the peak is not shifted far away from the ordinate axes. Only the model with PROC² is compared to the previous model (see *Table 1*): LR statistical probability is close to zero, so the hypothesis that all coefficients are simultaneously



zero is rejected; within 90% confidence level all coefficients are statistically significant; the HL and Andrews statistical values are low so the hypothesis about adequate specification of the model cannot be rejected.

3. Analysis of Project Approval Probability by Different Factors

The two best models were chosen that both have variables KOP/T, INDEX and IEDZ, while one model contains a variable (18-PUNKTI) and the other PROC². The comparison is shown in *Table 2*.

Table 2

Comparison of Two Best LOGIT Models

Variable	First model		Second model	
	Coefficients	P-statistic	Coefficients	P-statistic
C	-0.323678	-1.82E-05	-1.020650	0.0719
KOP/T	0.3261	0.0529	-1.58E-05	0.0937
INDEX	-0.357588	0.085035	0.383052	0.0664
18-PUNKTI	0.0887	0.0135		
PROC ²			0.000609	0.0312
IEDZ	0.000129	0.0011	0.000126	0.0014
McFadden	0.100862		0.093691	
Prob. LR stat.	1.03E-05		2.64E-05	
H-L stat.	6.8197		5.7835	
Andrews stat.	7.5278		6.2241	

Using the results obtained to evaluate the effect of explanatory variables on the project approval probability, four different situations were investigated, as it is shown in *Table 3* and *Table 4*. For each situation one of the variable values has been reduced by half compared to the first basic assumption data values. When variable has been changed curves shift down or up and show, how probability of project approval has changed.

Table 3

The First Model Interpretation

Assumptions	Coefficients	1	2	3	4
C	-0.3236780				
IEDZ	0.0001290	1000.00	1000.00	1000.00	500.00
18-PUNKTI	0.0850350	18.00	18.00	9.00	18.00
INDEX	-0.3575880	-1.50	-0.75	-1.50	-1.50
KOP/T	-0.0000182	variable (not fixed)	variable	variable	variable



Table 4

The Second Model Interpretation

Assumptions	Coefficients	1	2	3	4
C	-0.3236780				
IEDZ	0.0001290	1000.00	1000.00	1000.00	500.00
PROC^2	0.0006090	0.20250	0.20250	0.10125	0.20250
INDEX	-0.3575880	-1.50	-0.75	-1.50	-1.50
KOP/T	-0.0000182	variable (not fixed)	variable	variable	variable

In *Figure 2 and Figure 3* the previously mentioned assumptions are shown. The figure does not show probability changes in absolute values that are the probability to get 1 or 0 in the result, but it shows changes from different variable values, as well as the effect when one variable has two different values. In particular, in the *Figure 2*, when the variable named (18-PUNKTI) decreases by half its value (1st Model, 3rd Assumption), the curve shifts down significantly, significant shifts are also shown when variable INDEX changes, but the other variables do not significantly change the project approval probability. Changes are also visible depending on population in territory.

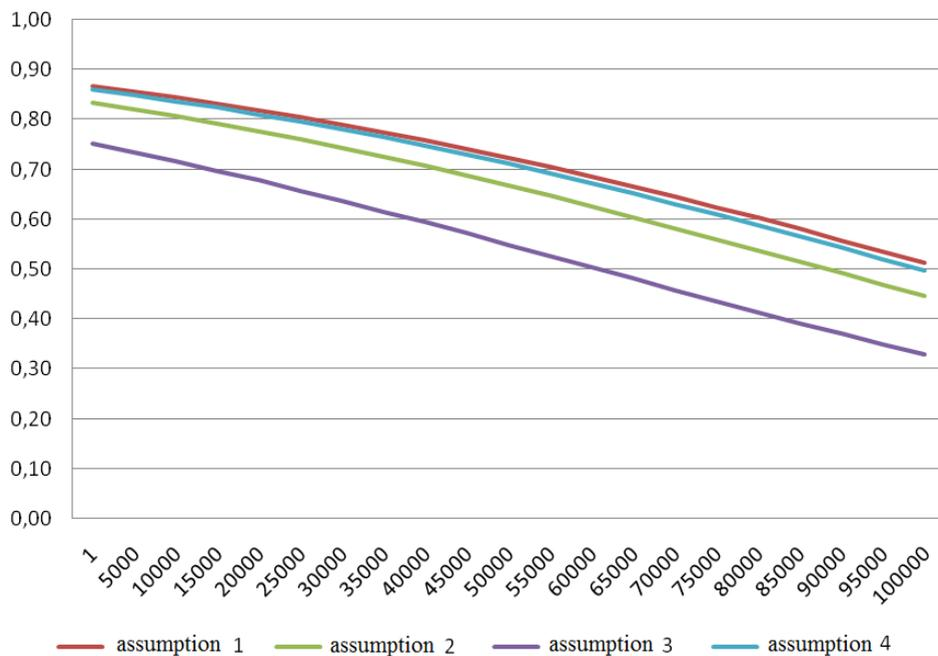

Figure 2. Graphical Interpretation of First Model

From the *Figure 3* it can be seen that the most significant changes have occurred when the development index of specially supported territories (INDEX) has been reduced by half (2nd



Model, 2nd Assumption). Both 1st and 3rd assumptions (2nd model) almost overlap, which means that the percentage reduction does not significantly affect the project approval probability. The changes also can be seen when the population of territory decreases.

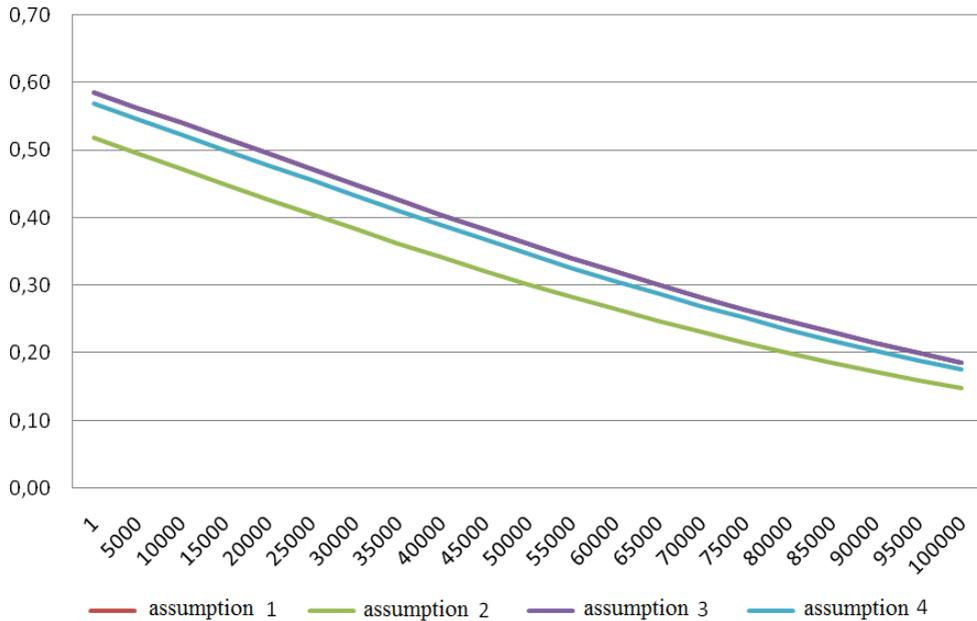

Figure 3. Graphical Interpretation of Second Model

Both the first and the second model show that (1) the development index of specially supported territories has the greatest impact on the probability of project approval, as well as (2) requested co-financing of structural funds that is evaluated according to point scale. Lower, but also visible effect is for (3) population in the territory.

Summary

This paper considers an example of project approval data analysis of the European Regional Development Fund Program “Business and Innovations” (activity no. 2.3.2.2). The paper explores application of the LOGIT model to estimate probabilities of project approval for projects that may differ in size and belong to various economic sectors, but their main objectives are similar. Qualitative choice model is used to estimate factors that influence project approvals in the first project phase – submission of project proposal. The result shows that the probability of project approval is mostly affected by

(1) the development index of underdeveloped territories and

(2) the intensity of structural funding that is planned within project submission and estimated in percent,

and this is consistent with the main objective of the named activity of the European Regional Development Fund Program “Business and Innovations”.



Project Management Development – Practice and Perspectives

First International Scientific Conference on Project Management in the Baltic Countries
February 8-9, 2012, Riga, University of Latvia

There is no statistically significant effect to the project approval result from total eligible costs and the period of the project duration time, but there is one statistically significant variable: the total eligible costs per one project duration month.

We can indicate that for government institutions that manage Fund Distribution Programs, it would be necessary to expand the database about proposed and approved project papers. It would give an opportunity for applicant to assess the previous results and to reduce the risk of not approving the project; it also improves the quality of future projects and gives more appropriate distribution of funds to better projects.

It is possible to extend the model with other criteria that could affect project quality evaluation and therefore it could be used to estimate project approval probability, for example, if it would reduce the impact to environment in all product life cycle; if economical energy resources would be used in project; if the project would contain IT solution etc. (mentioned in first section of this paper).

References

1. R. Jones, *Basics in Project Management. A practical guide for Project management and execution*. New York: Business Information Service, 2008. pp. 131-142.
2. State Education Development Agency, „*Guidelines for the management of Project risks*”. Department of Structural Funds Projects, operational programme „Human Resources and Employment” activity no. 1.1.1.2. „Attraction of human resources in science”. Riga. 2 p.
3. Latvian Rural Tourism Association, „*Country Traveller*” Chapter 2.7. „*Risks in business and Project implementation and management*”. Riga. 1 p.
4. Lionel Galway, *Quantitative Risk Analysis for Project Management*; Working paper, RAND Corporation 2004. 52 p.
5. European Regional Development Fund Program “Business and Innovations” (activity no. 2.3.2.2). Data resource: Latvian Investment and Development Agency who are institution responsible for the program and the data are available on personal request.
6. Damodar N. Gujarati, Dawn C. Porter *Basic Econometrics*. McGraw-Hill: International Edition, 2009.

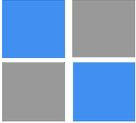

CONFIGURATION MANAGEMENT IN MULTI-SITE PROJECTS – AN APPROACH FOR COLLABORATIVE WORK

Carsten Wolff

Research Focus Group PIMES

University of Applied Sciences and Arts

Department of Computer Science

Emil-Figge-Str. 42, 44227 Dortmund, FH Dortmund, Germany

E-mail: carsten.wolff@fh-dortmund.de

Keywords: configuration management, collaborative work, multi-site projects, version control systems

Abstract

Multi-site development creates several challenges for project teams. One focus is the concurrent development and the integration of results from teams spread over distant locations. The coordination and the consistent provision of deliveries between teams are more complex in multi-site projects than in teams located in the same place. This is mainly due to the limited possibilities for communication and synchronization, especially informal communication [1]. In addition, it is a challenge for data management and configuration management. An effective configuration management has to ensure, that teams in different locations don't interfere with the work of other teams, e.g. by changing the same files in a different way. In addition, it has to take care, that the teams are using consistent versions of the results of the other teams. To coordinate who is using which versions of results and to make the necessary data available in the different sites is a complex task. Modern configuration management systems help with this task. Still, a proper configuration management strategy has to be developed for the specific needs of each project [2]. This contribution deals with recommendations and ideas for setting up such a strategy.

1. Introduction

Today, many large projects are executed by projects teams spread over different departments and different fields of work. The complexity of such projects is increased if they are conducted in different locations at the same time. These multi-site projects require additional effort for coordination and collaboration [3]. Many aspects of project management for such distributed projects are concerned with knowledge sharing approaches [4] and the organization of virtual teams. The challenge is to achieve a similar degree of collaboration amongst the team members compared to teams located in one site. To foster collaboration, IT tools are used to support the sharing and exchange of information and to organize the communication processes.

One important source of problems in dispersed project teams is caused by a lack of version control. The typical case is a team member in one site working on the same result or deliverable as another team member at a different site. Accidently, they create two different



results. It may happen that other team members use the one or the other result and try to integrate them into new results. The outcome is not very likely to work. A consistency problem is created. Other examples are two team members changing the same deliverable in different ways, e.g. correcting two different mistakes. The results are two deliverables; each has one mistake corrected and one mistake left. Integration of such results into further deliverables multiplies the mistakes.

Configuration management addresses these issues and it can help to organize projects, especially if different locations are involved. The creation, provision and exchange of data is structured and controlled. This allows the definition of rules about who is seeing which data and who is allowed to change which data at what time. Configuration management is highly connected to other disciplines like change (request) management, project management, requirements management and other areas of systems engineering [5]. In connection with these disciplines and based on the size of project and the area of industry, the configuration management strategy has to be defined. Sometimes aspects of configuration management are addressed by version or data management. Configuration management is not limited to the management of data, e.g. in engineering projects, but in the context of this contribution the focus is IT based configuration management for development data (e.g. software source code).

2. Configuration Management

Configuration management [6][7][8] tells each team member which deliverables and which versions of the deliverables he is allowed to touch. Configuration management aligns when the things are touched and when the results are integrated.

This is done by the creation of a new version if a development data file is created or changed. A *version management system* records the time when the new version was created and the user who created it. The sequence of versions of a file generated during the development process is called the *version tree*. If the tree has only one consecutive sequence, the latest file is usually the valid version. But that is not true in all cases. If different people work on the same file, different recent versions of that file can exist. All versions can be *valid*, but they are not *consistent*. E.g., different people are fixing different bugs in the same software source file. After creating the different valid versions, somebody has to merge the files into one file to have all bug fixes collected. The merged file is the valid version after that procedure. Another case is the usage of different versions from a version tree for different purposes. E.g., the software designer is working on the most recent version in the sequence, while the software tester is testing an older but more stable version. An even older tested version could be part of a software release, where a stable and tested version is needed, while some new features are still missing. For all three purposes, the same file is used but different versions with different content.

A collection of versions of different files (each file in only one version) forms a *configuration*. Since these files in a development project are forming a system (e.g. a software system) they are dependent and connected. Some configurations collect file version content that does not fit together, some configuration form a consistent system or sub-system. The collection of the correct version of each file forming a system is a main task of configuration management.

Consistent versions of parts of the system or the complete system are managed with *baselines*. A baseline is a collection of the file versions that form a consistent system. The baseline is created in a project at certain stages of the development process, e.g. when a release



of the software system is done. The baseline defines which version of each relevant file is used for the consistent release of the system. Choosing file versions for a baseline can be done by defining a certain time or a time stamp, meaning, the last version of a file created before that time is the version used for that baseline. This is a simple process, but it can be risky in multisite projects. Another way of marking the file versions belonging to a baseline is labeling. Each file version connected to the baseline gets a unique label. There is only one file with this label in each version tree. Therefore, the file version belonging to that baseline can be identified exactly.

Version management systems used for configuration management offer the possibility to create views. A *view* is a file system containing all files belonging to a configuration, meaning, there is a certain version of each file visible in the file system provided by the view. A view can be used to display all files connected to a baseline. E.g. the version management system displays only files with a certain label. If all files belonging to the baseline have been labeled, the view displays the system configuration connected to that baseline. With this mechanism, the user can easily switch between different development stages of a software system. The software design engineer can display the latest consistent version of all files and do his changes on that version. At the same time the test engineer can test an older set of consistent files, e.g. by simulating the system. He is not interfered by the changes done at the same time by the software design engineer. In a system design based on several sub-systems, one sub-system can be modified while the rest of the overall system is displayed in a stable version. Teams working on different sub-system can do their development work without interfering with the work of other teams. After some time, the baselines of the different sub-systems are moved (e.g. by creation of a new label) and a new consistent overall system is formed.

A change (request) management system, e.g. for bug tracking or issue tracking [9] can be part of the configuration management. It can be easily identified, in which version of a file a bug or issue is fixed or a change is implemented. Since the baseline identifies which versions are contained in it, it is possible to identify which consistent release of a software system contains which changes and fixes.

3. Adaptation to Multi-Site Projects

Multi-site projects are specifically affected by configuration management issues, since results from one site are visible at another site with time latency. Communication on which parts of the deliverables are to be used may be difficult between different sites. This leads to specific adaptations for multi-site configuration management. The strategies to address the topics are supported by software tools.

A main feature of multisite-configuration-management systems (e.g. Rational Clearcase [10]) is the provision of synchronized design databases at each development site. The team at one site works on a copy of the database and this copy is synchronized over all sites from time to time (usually overnight). If the team changes a file, it is changed in the local copy of the database. After synchronization the new file version is available at all sites. Dependent on how often synchronization is done this can lead to pretty long delays until a change to a file is visible at all sites. It could be that a change to one file at one site leads to a working and consistent overall software system. Another change to another file (or even to the same file) at another site may result in a working and consistent system, too. But after synchronization the two changes



add up to an inconsistent software system that does not work. Since there is a time lag, many changes can add up and the problem is destroying a whole day's work. To avoid that, a more rigid approach in configuration management has to be taken.

First of all, each site uses an own site specific branch for their changes. Meaning, if site "munich" changes a file, a branch named "munich" is generated for that file. Each new version generated by people from "munich" is generated as part of that branch. If another site changes that file, they use another branch, e.g. "hamburg". Due to this, the results of the different sites can be easily distinguished. Version management systems offer the possibility to display files version from a specific branch only.

In addition, each file is assigned to one site, and only that site is allowed to change that file. Meaning, only one branch per file can exist, if two branches of the same file exist, somebody has touched a file that he was not allowed to touch. That can be easily detected by tools. The "one-branch-per-site" policy helps to control that if a huge number of files are generated during a development project. The assignment of files to a site can be simplified, if complete sub-systems are assigned to a site. This is anyway a common approach in structuring multi-site projects [11].

During synchronization first all results from all sites are collected at one site (main site). After synchronization all branches of files can be merged back to the main branch, but that is not necessary. Based on the synchronized set of files, tests are done (e.g. an overnight regression test) to find out if the different file versions form a consistent and working overall system. Of course, before synchronization the different sites have tested if their sub-systems are consistent and working and if their sub-system works with the old versions of the other sub-systems. Meaning, after synchronization the only task is to check if the different new sub-systems work with each other.

All files of a working overall system are labeled to form a new baseline. If one sub-system does not work with the others, there are two possibilities. First, the new-subsystem can be excluded from the release of a new baseline. Instead an older version is included in the baseline. Second, the delivering site of the sub-system can be asked to do an update. The work of generating a consistent new overall baseline is simplified if the sub-systems are labeled before synchronization with a sub-system specific label. By using that label to create a view on that sub-system the correct file versions are displayed automatically. With this sub-system-labeling, the delivering site can decide which file versions to use in their sub-system release. By changing a view to a different label, the user can easily switch between different baselines (or versions) of the sub-system. After labeling the overall system, the user can switch between different baselines (or versions) of the overall system by changing the view to a different label. After labeling the overall system (meaning creating a baseline or a release) the database is synchronized back to the remotes sites. They can use the new baseline by setting their views to the respective label.

Using time stamps instead of labels can be dangerous. If for example a time stamp for a specific set of files is defined at one side by doing tests with these files, it can happen that after synchronization one of the files has a newer version, but still within the range of the time stamp. Meaning, accidentally a newer and not tested version is used. Careful use of time stamps will not lead to that issue, but dealing with large number of files carries the risk of doing something wrong.



To communicate a baseline, a release or just a specific configuration of all files (or of the files of a sub-system) to teams, it is just necessary to communicate the respective labels. A naming convention for the labels can help with this (e.g. DSP_SUBSYSTEM_ALPHA_RELEASE). Configuration management can deal with these label names. E.g. people will know that a certain feature or bug fix is contained in DSP_SUBSYSTEM_ALPHA_RELEASE. The creation a provision of baselines and release can be scheduled and controlled, e.g. by running regression tests on the baseline.

Another advantage is that different stages of the design process can be performed on the same file database. E.g. while the design engineers work on the beta release, the test engineers are performing their testing with the alpha release. The specification team may perform their work on an even newer version. While at site A the test team work on the alpha release, at site B the test team may work already on the beta release. Therefore, configuration management is a basis for all types of concurrent engineering [11] [12]. The concept of delivering releases or baselines via database synchronization and labeling helps to establish principal-agent-relations between sub-teams [11]. A delivery specification can describe all content in a specific release of a sub-system and the receiving team can easily check this with an acceptance test.

Rational Clearcase [10] supports this configuration management strategy and was used for the respective experiments. Systems based on a single site database (e.g. svn [13]) can still use the same approach. They just don't do the database synchronizations. Other systems with mirrored databases, e.g. Git [14] just follow the same approach.

4. Results and Conclusion

The considerations explained in this contribution came up while reasoning about strategies for the project management for large HW/SW Codesign projects [11]. They were and are used in large digital design projects in semiconductor industry. With the application of sophisticated configuration management strategies it was and is possible to manage projects with more than 100 engineers is more than 5-10 different locations. The file databases can contain several thousand files.

Concurrent engineering is supported by working on 5-10 sub-systems at the same time and by working on 3-4 different development stages at the same time. Approaches like generating ASICs, FPGAs and virtual prototypes from the same design database [11] are supported. Frequent releases (e.g. one per day) help to implement iterative design processes.

Thinking about multi-site development while setting up the configuration management strategy is a necessary requirement in large projects. Even if the project may start in one location only, a spread to several locations may be necessary during the project runtime. A deep understanding of the possibilities and features of configuration management systems helps to develop an efficient and effective way to organize the development of large systems in large teams.

References

1. H. Kerzner: Advanced project management: best practices on implementation. 2nd Edition, John Wiley a Sons, pp. 461 ff., (2004).
2. IEEE Std. 828-1998 IEEE Standard for Software Configuration Management Plans (1998).



Project Management Development – Practice and Perspectives

First International Scientific Conference on Project Management in the Baltic Countries
February 8-9, 2012, Riga, University of Latvia

3. Keith C.C. Chan; Lawrence M.L. Chung: Integrating Process and Project Management for Multi-Site Software Development , Annals of Software Engineering, Volume 14, Numbers 1-4, pp. 115-143 (2002).
4. Hai Dong; Hussain, F.K.; Chang, E.: Multi-site Project Organisation Knowledge Sharing Ontology, ICWMC '07. Third International Conference on Wireless and Mobile Communications (2007).
5. C. Hood, S. Wiedemann, S. Fichtinger, U. Pautz: Requirements Management: Interface Between Requirements Development and All Other Systems Engineering Processes. Springer, Berlin, (2007).
6. ISO – International Standardization Organisation. ISO 10007:2003: Quality management systems – Guidelines for configuration management (2003).
7. IEEE Std. 1042-1987 IEEE Guide to Software Configuration Management (1987).
8. ANSI/EIA-649-1998 National Consensus Standard for Configuration Management (1998).
9. PMI: A Guide to the Project Management Body of Knowledge: PMBoK Guide Third Edition. Chapter 4.6, PMI, (2008).
10. B. A. White: Software Configuration Management Strategies and Rational ClearCase, Addison-Wesley, (2000).
11. C. Wolff, I. Gorrochategui, M. Bücker: Managing Large HW/SW Codesign Projects. In: Proceedings of the 6th IEEE International Conference on Intelligent Data Acquisition and Advanced Computing Systems: Technology and Applications, Prague, (2011).
12. H. Kerzner: Advanced project management: best practices on implementation. 2nd Edition, John Wiley a Sons, pp. 335 ff., (2004).
13. W. Nagel: Subversion Version Control: Using the Subversion Version Control System in Development Projects. Prentice Hall, (2005).
14. Git – Fast version control system: <http://git-scm.com/>, last visited on Dec 22, (2011).



PROJECT CRISIS MANAGEMENT

Professor, Dr.oec. Tatiana Yurieva

Head of Department of Project Management and Programs

International Institute of Public Service and Administration

The Russian Presidential Academy of National Economy and Public Administration

Vernadskogo prospect, 82, 119571, Moscow, Russia

E-mail: tyurieva@gmail.com

Keywords: project crisis management, volatility, crisis management, crisis management strategy

Abstract

Project management system is an effective means of solving the socio-economic problems. This method of management is the most powerful in changing and developing systems, in unstable and uncertain situations.

The Innovative socially oriented economy cannot be avoided in the development of unstable situations that are characteristic for a market economy as a socio-economic system. Therefore, the management companies are increasingly emphasis on need to create a system of protection of the business of negative factors. The most important prerequisite for the successful passage of the crisis is the readiness for it on the basis of project crisis management.

The main objectives of the project crisis management include: identification of signs of a crisis situation; estimate the probability of its occurrence and the potential consequences; the development of anti-crisis strategy; the elimination of negative socio-economic impact of the crisis; preventing it in the future.

The mechanism of project crisis management should be oriented not only to eliminate the impact of the crisis, but also on the tasks of post-crisis period related to the further development of the business, increasing its competitiveness in the long term.

The project crisis management doesn't have a standard set of approaches, methods and procedures. Its tools depend largely on the individual capabilities of the company, the trajectories and cycles of development, the impact of various external and internal factors. There are several types of project crisis management, based on the phase of the crisis.

As part of a project crisis management carried out pre-trial rehabilitation, judicial (arbitration and liquidation) and extra-judicial liquidation procedures. There is a need to enhance the rehabilitative nature of the modern crisis management.

The project crisis management has its own the object, subject and mechanism. The realization of functions of project crisis management requires specialists with specific professional competencies to enable them to effectively manage the business in a crisis situation as well as to develop and implement stabilization programmes, further development aimed at ensuring the continued competitiveness.



Project Management Development – Practice and Perspectives

First International Scientific Conference on Project Management in the Baltic Countries

February 8-9, 2012, Riga, University of Latvia

At the present time, the concept of project management is applied in many sectors of the economy. The world practice of project management system has proven its efficiency and created a real need for a significant number of highly qualified project managers. In the higher education system is preparing the relevant bachelors and masters. The project management system based on modern information technologies, actively developed and used by many companies. Project management system is an effective instrument for solving social and economic problems. This method of management is the most effective in changing conditions and developing systems, in unstable and uncertain situations. Place and role of project management in the modern economy requires further development and adaptation of its methods and tools, specialization, a more relationship with the processes of business management.

Any project operates in a certain socio-economic system. It should be noted that the evolution of the market economy as a socio-economic system is influenced by different factors, the importance of which changes as it develops.

Currently, the effective functioning of a market economy is determined by factors such as knowledge, innovation and the ability of entrepreneurs, flexibility of production, etc., which promotes the establishment and development of innovative socially oriented market economy. As a result production develops due to the greater use of innovation, allowing for continuous updating of the technical and technological base of production, development and production of new competitive goods, the effective penetration into world markets, as well as an effective system of social protection is guaranteed. Thus, an innovative socially oriented economy is based on the implementation of such principles like a balance of entrepreneurial freedom, social justice, and competitiveness. Therefore, in the “Concept of Long-Term Socio-Economic Development of the Russian Federation until 2020” tasked of transformation of the Russian economy from the export of raw materials to innovative socially oriented type of development [1]. A similar concept called “Europe 2020” (EU-2020) adopted and is realized within the European Union [2]. The analysis of these two documents shows that they are based on general assumptions, namely the sustainable economic growth on the basis of knowledge-economy, the transformation of innovations into a leading factor of economic growth in all sectors and spheres of the economy. Formation and development of a competitive knowledge economy in Russia and high technology is the strategic direction of development of country in the first half of the twenty-first century. The implementation of this task depends largely on the quality of human capital, social conditions, the ability to quickly introduce new technologies in the economy, the efficiency of foreign trade activities.

However, the innovative socially oriented economy, as today’s world practice shows, cannot avoid in the development of unstable situations, typical to a market economy as a socio-economic system. For the market economy crisis is a normal situation, due to the cyclical nature of its development. The risk of its there is constantly, so the managers of the organizations need to know the specific causes and signs of a crisis situation, to be able to find a strategy for action in its context and the transition to sustainable development.

The current economic crisis has affected many areas of the Russian economy. Despite the fact that the Government of the Russian Federation has developed and implemented a set of effective anti-crisis measures [3], the instability of the organization, which is expressed first of all in their insolvency, losses, is still a serious economic problem.

In particular, the total debt of organizations in Russia at the end of 2010 amounted to 37.2 trillion rubbles, or 8.3 times higher than 2000 level and more than in 3 times – 2005. Dur-



ing the period 2000-2010 there is a tendency of large-scale increase in all types of debt organizations (accounts payable – 5 times, on bank credits and loans – in 20 times; receivables – almost 7 times). Over the last decade the number of the unprofitable organizations varies from one third to half in a number of sectors of national economy [4]. In this regard, organizations increasingly focus on the need to establish a system for the protection of business from the effects of negative factors. One of the most important factors in sustainable evolution is the development and implementation of the project crisis management system.

The main purpose of the project crisis management is the identification of a crisis situation; the estimation the probability of its occurrence and the potential consequences; the operation of crisis management strategy; the elimination of negative socio-economic consequences of the crisis; the prevention it in the future. Thus, the project crisis management is the managerial decisions and activities on the diagnosis, neutralization and overcome the crisis and its causes, prevention in the future.

The mechanism of the modern project crisis management should be aimed not only at eliminating the social and economic consequences of the crisis, but also on the tasks of post-crisis period related to the further development of the business, increasing its competitiveness.

The concept of project crisis management can be interpreted ambiguously, that is connected with the dual nature of any crisis that simultaneously creates and destroys, i.e. forms the prerequisites and prepares the conditions for further development and release of the previous business strategy.

If we consider the crisis as a destructive function, then it should be understood as a situation that threatens the existence of the organization and requires immediate action to preserve its material basis for the continuation of economic activity with a deficit of circulating capital. If we consider the crisis as a phenomenon, oriented not only the struggle with the old, but also on the new development, it should be taken positively. With this approach, a project crisis management means not only the fight with the crisis, but also business restructuring, in accordance with the new realities.

Project crisis management operates on the following assumptions:

- crises can be foreseen, call, accelerate, precede, postpone, mitigate;
- necessary to prepare for crises;
- the crisis processes can be controlled to a certain limit;
- crisis management requires the special technologies;
- crisis management can reduce the negative socio-economic consequences.

Project crisis management doesn't have a standard set of approaches, methods, procedures; in each case, and at every stage of the development crisis is unique. Its instruments largely depend on the individual opportunities of the organization, development cycles, and the impact of different factors in the internal and external environment.

By its nature, project crisis management in a separate organization is part of the strategic management, whose main objective is to ensure its competitiveness in the long term. It must be noted that the use of anti-crisis instruments under stable conditions could have the negative consequences for business development.

Project crisis management, depending on the stage of the crisis can be divided into the following types:

- 1) *The early project crisis management* is carried out to prevent a crisis of profitability and capacity building in the event of slowing demand and the deterioration of the



company's position on the market or the possibility of its losing. Here, the regular management is complemented by a number of special functions.

- 2) *Outrunning project crisis management* is implemented with the weak signals about the threat of crisis, a loss of competitiveness of products and firms in general. It combines some features are equally a regular and crisis management. The main goal is to avoid the looming crisis of non-payment.
- 3) *The crisis project management during the insolvency* is carried out under conditions of financial instability associated with the appearance of insolvency and the loss of profitability. Here its own functions are complemented by a number of operational functions of a regular management. The aim is to restore the sustainability of the organization, the ability to save business, etc.
- 4) *Crisis management project at the stage of bankruptcy* occurs under conditions of chronic instability and loss of ability to pay. This form is introduced by arbitration court at recognition of the organization as bankrupt. There is no regular management, and implemented only the functions of crisis management. The main objective is to maximize the satisfaction of creditors' claims, the preservation of the property complex of the organization, workplaces that will allow to the new owner to resume business.

In Russia, the crisis management is implemented on the legal foundations, laid in the early 1990s by Law of Russian Federation of 19.11.1992 № 3929-1 "On insolvency (bankruptcy) of enterprises" [5]. Then, was developed and put into effect Federal Act from 08.01.1998, № 6-FZ „On Insolvency (Bankruptcy)” [6]. This law was more perfect, but its implementation in practice has revealed a number of shortcomings. As a result, a new Federal Act had introduced from 26.10.2002 № 127-FZ „On Insolvency (Bankruptcy)” [7]. There is a Federal Act “On Insolvency (Bankruptcy) of Credit Institutions” from February 25, 1999, № 40-FZ [8].

Project crisis management performs the following procedures at the level of the organization:

- 1) The pre-trial (prevention of bankruptcy by own forces; pre-trial rehabilitation, transformations).
- 2) Judicial (arbitration and liquidation).
- 3) Extra-judicial liquidation (winding up the organization of the owners).

Pre-trial (using the internal mechanisms of stabilization, restructuring of business, etc.) and extra-judicial liquidation procedures are implemented on a voluntary basis by organizations or external consultants.

The arbitration management has compulsory character and includes the following procedures:

- 1) *Observation*. The main objectives of this procedure are: preservation of the debtor's property; financial analysis; roster of creditors; holding the first meeting of creditors.
- 2) *Financial recovery*. This procedure is used to restore the solvency of the debtor and the debt repayment in accordance with the schedule.
- 3) *External administration*. It is introduced in order to restore the solvency of the debtor. During this process, the restoration of stability is achieved by the organization of the following activities:
 - Conversion of production.
 - The closure of unprofitable sections.
 - Debt collection.



Project Management Development – Practice and Perspectives

First International Scientific Conference on Project Management in the Baltic Countries

February 8-9, 2012, Riga, University of Latvia

- The sale a part of property.
 - Placement of additional ordinary shares of the organization.
 - Increase of the share capital through contribution by the participants and other third parties replacement of assets.
- 4) *Bankruptcy proceedings*. This procedure is applied to a debtor declared bankrupt, for the proportional satisfaction of creditors.
 - 5) *Settlement Agreement*. The procedure is applied on the any stage of the insolvency. Its purpose is to stop a bankruptcy by an agreement between the debtor and creditors. Settlement agreement includes activities such as the exchange of requirements on the stocks and bonds, innovations of obligations, the liquidation of debt, etc. This process is the most cost effective way to restore the stability of the organization. But the settlement agreement may be dissolve in case of default or a material breach of its terms.

The analysis of data published by Supreme Commercial Court of the Russian Federation for the period 2000-2010, reveals the tendency of growth nearly twice the debtor's organizations in respect of which the bankruptcy proceedings were opened. In 2010, the number of such organizations has exceeded 33 000. Settlement agreement been achieved in 255 organizations. The financial recovery carried out in more than 90 organizations, while financial debt was paid off in only 6 organizations. External control was carried out in 908 organizations, with the solvency has been restored in 14 cases. The twenty organizations could restore the solvency and stop the bankruptcy. Overall, more than 16 thousand organizations were declared as a bankrupt and the bankruptcy proceedings were opened in respect of them [9].

Thus, we can conclude that the arbitration methods of crisis management so far aren't effective. They focus on the elimination of organizations through the bankruptcy process. All this substantiates, there is a need for further improvement instruments of arbitration management, its greater focus on the rehabilitation rather than on the liquidation character.

The system of project crisis management, as and any other management system consists of several elements, which include: the object, subject, mechanism and the process of management. It is a subsystem of the organization's management system as a whole, and must have the following special properties:

- flexibility and adaptability;
- orientation to the informal methods of the impact;
- a high degree of decentralization (in large organizations), which is required for rapid response to emerging problems and changing situations;
- promoting of integration processes, which allows concentrate the efforts and better use of the potential competence.

The subject of a project crisis management is a set of departments and offices, which are formed temporarily or permanently for guiding, coordinating and controlling the relevant activities. This structure can be created by the organization on a voluntary basis in order to prevent the onset of the crisis, or in accordance with the decision Arbitration Court to deal with it, and in case of failure – for the bankruptcy process.

In organizations the direct object of the project crisis management is the activities, relating with the implementation of various anti-crisis measures that refer:

- to assets (liabilities);
- stages of business – process (sales, production, supply);



- protection of property and business security;
- HR (the formation of human resources policy, social processes);
- interaction with stakeholders;
- informational support (bringing to the organization's personnel and the public information about the plans, methods and principles of management), etc.

The process of project crisis management is based on a system of general rules (principles), as well as the special techniques and methods of implementation of relevant actions and procedures.

Project crisis management includes the following basic principles:

1. The earliest diagnostics of crisis manifestations, especially in the financial sphere. Taking into account that a crisis is a threat to the existence of the organization and is associated with the loss of its capital, it should be determined at an early stage.

2. The differentiation of the crisis's factors on their degree of danger to a stable position of the organization. This makes it possible establish the certain sequence of actions to combat it.

3. Appropriate management decisions are taken promptly. Versions of these decisions and actions for the typical situations should be developed in advance. It should be borne in mind that not only tends to increase with each new economic cycle, but also creates new phenomena that related to it. Therefore, the earlier crisis instruments will be used in the organization, the greater its ability to restore business. Responsiveness is particularly important to solve the problem of insolvency, recovery, stability and changes in financial strategy.

4. The adequacy of the response to the degree of real threat, particularly the financial equilibrium. Impossible to save to restore solvency organization (since it cannot be achieved the desired effect), but also unnecessary expense not advisable especially in conditions of lack of funds.

5. Using internal financial resources organization that maintains its independence.

6. Creation of effective system of personnel motivation.

Realization of the functions of project crisis management requires the specialists with specific professional competencies that enable them to effectively conduct the business in a crisis situation develop and implement a program for stabilization and the further development to ensure continuous competitiveness. Preparation of such specialists is an important goal of contemporary higher education.

These professionals must have the following key professional competencies:

- the ability to identify preconditions of occurrence and development of crisis, the crisis processes, situations and events;
- the knowledge of the methodological apparatus of diagnostics of signs the crisis situation, based on the study of internal and external environment of socio-economic system;
- the ability to apply methods of analysis of financial accounting to determine the signs of insolvency of the organization;
- the ability to apply the risk management;
- the knowledge of approaches and methods of estimate the market value of the business;
- the ability to participate in the development and implementation of activities of a financial recovery;



Project Management Development – Practice and Perspectives

First International Scientific Conference on Project Management in the Baltic Countries
February 8-9, 2012, Riga, University of Latvia

- the readiness to develop activities for the prevention of crises, reducing its impact;
- the ability to participate in the development and implementation of activities that can bring the organization out of the crisis.

It seems that the presence of managers who can effectively manage in crisis situations is an important issue in terms of basic national interests and national security. Recent global crises show that the level of crisis vulnerability of many countries is still extremely high.

References

1. Concept of Long-Term Socio-Economic Development of the Russian Federation until 2020. URL: <http://npaumejibcm6o.pf/gov/results/1173/>.
2. Europe 2020. URL: http://ec.europa.eu/europe2020/index_en.htm.
3. Anti-crisis measures of the Government of the Russian Federation. URL: <http://www.economy.gov.ru/minec/activity/sections/strategicPlanning/crisis/doc124842999317>.
4. Russia in figures // Russian Federation. The Federal State Statistics Service. URL: <http://www.gks.ru>.
5. Law of Russian Federation “On insolvency (bankruptcy) of enterprises” from 19.11.1992, № 3929-1. URL: <http://nalog.consultant.ru/doc1250>.
6. Federal Act „On Insolvency (Bankruptcy)” from 08.01.1998, № 6-FZ. URL: <http://www.consultant.ru/online/base/?req=doc;base=LAW;n=17408;p=8>.
7. Federal Act “On Insolvency (Bankruptcy)” from 26.10.2002, № 127 – FZ.: URL: <http://www.consultant.ru/popular/bankrupt/>.
8. Federal Act “On Insolvency (Bankruptcy) of credit organizations” from 25.02.1999, № 40- FZ. URL: <http://base.consultant.ru/cons/cgi/online.cgi?req=doc;base=LAW;n=78925>.
9. Certificate on the review of Arbitration Courts of the Russian Federation insolvency (bankruptcy) in 2000-2010. // The Supreme Commercial Court of the Russian Federation. URL: <http://www.arbitr.ru>.