

Schich, Sebastian T.

Working Paper

Dependencies between European stock markets when price changes are unusually large

Discussion Paper Series 1, No. 2002,12

Provided in Cooperation with:

Deutsche Bundesbank

Suggested Citation: Schich, Sebastian T. (2002) : Dependencies between European stock markets when price changes are unusually large, Discussion Paper Series 1, No. 2002,12, Deutsche Bundesbank, Frankfurt a. M.

This Version is available at:

<https://hdl.handle.net/10419/19569>

Standard-Nutzungsbedingungen:

Die Dokumente auf EconStor dürfen zu eigenen wissenschaftlichen Zwecken und zum Privatgebrauch gespeichert und kopiert werden.

Sie dürfen die Dokumente nicht für öffentliche oder kommerzielle Zwecke vervielfältigen, öffentlich ausstellen, öffentlich zugänglich machen, vertreiben oder anderweitig nutzen.

Sofern die Verfasser die Dokumente unter Open-Content-Lizenzen (insbesondere CC-Lizenzen) zur Verfügung gestellt haben sollten, gelten abweichend von diesen Nutzungsbedingungen die in der dort genannten Lizenz gewährten Nutzungsrechte.

Terms of use:

Documents in EconStor may be saved and copied for your personal and scholarly purposes.

You are not to copy documents for public or commercial purposes, to exhibit the documents publicly, to make them publicly available on the internet, or to distribute or otherwise use the documents in public.

If the documents have been made available under an Open Content Licence (especially Creative Commons Licences), you may exercise further usage rights as specified in the indicated licence.



Dependencies between
European stock markets when
price changes are unusually large

Sebastian T. Schich

(OECD, Paris)

Discussion paper 12/02
Economic Research Centre
of the Deutsche Bundesbank

April 2002

The discussion papers published in this series represent
the authors' personal opinions and do not necessarily reflect the views
of the Deutsche Bundesbank.

Deutsche Bundesbank, Wilhelm-Epstein-Strasse 14, 60431 Frankfurt am Main,
Postfach 10 06 02, 60006 Frankfurt am Main

Tel +49 69 95 66-1

Telex within Germany 4 1 227, telex from abroad 4 14 431, fax +49 69 5 60 10 71

Please address all orders in writing to: Deutsche Bundesbank,
Press and Public Relations Division, at the above address or via fax No. +49 69 95 66-30 77

Reproduction permitted only if source is stated.

ISBN 3-935821-10-7

Abstract

The present paper studies dependencies between European stock markets when returns are unusually large, using daily data on stock market indices for Germany, the United Kingdom, France, the Netherlands and Italy from 1973 to 2001. Dependency is measured by the conditional probability of an unusually large return in one market given an unusually large return in another and is estimated using an approach from multivariate extreme value theory. The paper finds the following. First, dependencies between markets in situations of unusually large returns have become closer over time. Second, they are generally higher for large negative returns than for large positive ones. Third, dependencies differ depending on the country pair considered. For example, stock markets in the Netherlands and France are more closely and those in the United Kingdom and Italy less closely linked to the German market. Fourth, overall dependencies are quite symmetric, in the sense that the conditional probability for an unusually large change given a large change in the other country is similar irrespective of which of the two countries the probability is conditioned on.

Keywords: Multivariate extreme value analysis, International equity market linkages, Integration of European equity markets.

JEL Classification System-Numbers: G15.

Zusammenfassung

Der vorliegende Beitrag untersucht die Abhängigkeiten zwischen Europäischen Aktienmärkten in Situationen ungewöhnlich grosser Kursschwankungen anhand von täglichen Daten der Aktienmarktindices für Deutschland, Großbritannien, Frankreich, die Niederlande und Italien von 1973 bis 2001. Abhängigkeit wird dabei gemessen anhand der bedingten Wahrscheinlichkeit einer ungewöhnlich grossen Preisveränderung auf einem Aktienmarkt, wenn eine ungewöhnlich grosse Preisveränderung auf einem anderen Markt gegeben ist. Diese Wahrscheinlichkeit wird geschätzt mit Hilfe eines Ansatzes aus der multivariaten Extremwerttheorie. Die Ergebnisse können folgendermaßen zusammengefaßt werden: Erstens sind die geschätzten Abhängigkeiten im Laufe der Zeit stärker geworden. Zweitens sind sie ausgeprägter im Falle negativer als im Falle positiver Kursbewegungen. Drittens sind sie unterschiedlich je nach betrachtetem Länderpaar. So stehen die Aktienmärkte in Frankreich und den Niederlanden in jeweils relativ starker gegenseitiger Abhängigkeit in Bezug auf den deutschen Aktienmarkt, während die Aktienmärkte in Grossbritannien und Italien weniger eng mit dem deutschen Aktienmarkt verbunden sind. Viertens sind die Abhängigkeiten zwischen zwei Märkten generell symmetrisch in dem Sinne, dass die geschätzte bedingte Wahrscheinlichkeit weitgehend unabhängig davon ist, auf welchen der beiden Märkte die Wahrscheinlichkeit konditioniert wird.

Table of contents

I.	Motivation	1
II.	Methodology	4
III.	Empirical application	7
	1. The data and some descriptive statistics	7
	2. Results	9
IV.	Conclusions	17
	Bibliography	20

List of tables and figures

Table 1	Conditional probability of unusually large returns	16
Figure 1	Simplified illustration of the spectral measure	5
Figure 2	Scatter plots of positive and negative return pairs	8
Figure 3	Density estimates for unusually large returns	10
Figure 4	Conditional probabilities of unusually large returns	11
Figure 5	Density estimates fo unusually large negative returns	14
Figure 6	Conditional probabiliets of unusually large negative returns	15
Appendix 1	The data	18
Appendix 2	Summary statistics of daily stock returns	19

Dependencies between European stock markets when price changes are unusually large *)

I. Motivation

Unusually large changes in equity price indices merit specific attention. If they are negative, they are particularly important as they have a potentially more severe impact on balance sheets than changes of normal size. Moreover, if they are not confined to a single market, but affect several markets in the same direction, the adverse effects may be important even for internationally diversified portfolios. A prominent example of such an event is the stock market crash in October 1987, where unusually large equity price changes occurred simultaneously in several emerging and mature markets. Or, more recently, the Russian crisis in August 1998 not only generated a sequence of stock market collapses in emerging markets, but also accelerated the fall in equity prices in several mature markets at the same time. For the investor, this implies that in situations when it would be most needed, international diversification may not be sufficient to prevent major losses. For the regulator, who has to set regulatory minimum capital standards, this implies that his settings may not be sufficient if he does not take into account the possibility of a sudden simultaneous deterioration of conditions in several markets.

The present paper studies the dependencies between European stock markets when stock index returns are unusually large. Analysing dependencies between European markets is interesting, because they are likely to be quite closely linked as a result of the process of integration and the continuous removal of various barriers to cross-border investment in the European Union. Most *direct barriers*, such as various forms of capital controls and withholding taxes had already disappeared by the early 1990s. Several *indirect barriers*, such as the obligation of pension funds and insurance companies to hold large parts of their portfolio in domestic currency effectively disappeared for euro area countries with the introduction of the single currency in January 1999. The costs of hedging intra-European *currency risk*, while being important around the time of the EMS crisis, became less and less important in the run-up to European Monetary Union and disappeared for all countries that joined the euro area with the introduction of the single currency. To the extent that this

*) I am grateful to Pedro de Lima, Florian Pelgrin, Catalin Stărică and participants at seminars at the Deutsche Bundesbank and the Annual Conference of the European Economic Association for helpful discussions and comments. The usual disclaimer applies. The author works at the OECD and is on leave of absence from the Deutsche Bundesbank.

process has led to stronger dependencies in situations of unusually large returns, the benefits of diversification may be unavailable exactly when most needed. Consequently, the benefits of portfolio diversification across these markets may have been largely reduced. To shed light on this issue, this paper analyses bivariate extreme value dependencies among the five largest stock markets in the European Union, those in the United Kingdom, Germany, France, Netherlands and Italy, using daily data of stock market indices from January 1973 to July 2001.¹ Specifically, the paper presents estimates of bivariate dependencies between Germany on the one hand and the United Kingdom, France, the Netherlands and Italy on the other, where dependency is measured by the conditional probability of an unusually large return in one market given an unusually large return in another.

Dependence is measured by a statistical measure from *multivariate extreme value theory* (MEVT) which allows us to estimate the conditional probability we are interested in.² Extreme value theory (EVT) provides tools to analyse unusually large returns, where unusual means that there are none, or, as in our application, only a few observations of that size (extreme events). MEVT is the extension of univariate EVT to the multivariate case and is concerned with the tail behaviour of *multidimensional* marginal distributions. While applications in the engineering literature, especially in the field of hydrology are widespread, MEVT has only recently been used to analyse financial data. Applications to stock market returns include Hartmann, Straetmans and de Vries (2001), Longin and Solnik (2001), and Poon, Rockinger and Tawn (2001). Longin and Solnik estimate conditional correlations between returns on different equity markets beyond given thresholds, using monthly data for the United States, Japan, Germany, France and the United Kingdom (henceforth G-5) from 1959 to 1996. They find that in the case of negative returns, correlation of returns beyond those thresholds is higher than would be consistent with assumption of multivariate normality. Poon *et. al.* confirm this. Using daily stock index return data for the G-5 from 1968 to 2000, they find that correlation of extremes are higher for negative rather than positive returns. They also find that correlations within

1 These are relatively large and liquid markets, accounting together for more than a fifth of total world stock market capitalisation. Another advantage of this choice of markets is that the daily data reflect market conditions at about the same time. Including data for markets from time zones that differ more substantially (*e.g.* United States or Japan) would raise the problem of non-synchronous data collection which complicates the comparison of daily data for the different markets. While this problem could be reduced by looking at weekly data (*e.g.* Hartmann *et. al.*), such an approach would not allow us to focus on the very short-term, *i.e.* daily dependencies, and reduce the efficiency of our estimators which require very large data samples.

2 A standard approach to measuring dependencies between stock markets has been to calculate the correlation coefficient for pairs of stock market index returns. This has the advantage that the calculations are straightforward and that dependency can be expressed in a single number. However, it may not fully capture the dependencies at issue, which may well go beyond linear relations.

Europe are higher than correlations between Europe, the United States and Japan, though it is not clear to what extent this may reflect the effects of the substantial non-synchronicity in the collection of data for the three regions rather than differences in dependencies. Hartmann *et. al.* criticise that the previous studies do not provide the information that has more direct meaning for analysing dependencies, such as the likelihood of a joint crash or a crash spill-over. Instead, Hartmann *et. al.* use a non-parametric approach to measuring stock market dependencies, which, unlike the previous correlation-based approaches, allows them to leave the probability law of the joint return process unspecified. They estimate directly the number of crashes, given that at least one market crashes. Using weekly data on returns for the G-5 stock markets from February 1987 to November 1999, they find that on average stock markets realise a co-crash in one out of five crashes. The present paper uses a similar approach as Hartmann *et. al.*, but focuses on conditional probabilities of market booms and crashes.³

To measure dependency we follow Stărică (2000) who suggests a *spectral measure* to describe how the extremes of the univariate components of a bivariate vector are related to each other. Consider (squared) return pairs in the first quadrant. Loosely speaking, the approach consists of “rescaling” the observations, which are far away from the origin, so that they lie on the unit circle. Dependence is then measured by the distribution of the thus rescaled observations on that circle. As the location of each observation on that circle is defined by an angle between 0 degrees and 90 degrees, the distribution can be measured on the line with values between zero and $\pi/2$. Dependence is measured by the concentration of observations that lie in the “middle”, *i.e.* close to the 45 degree line or to $\pi/4$. These dependency estimates allow us to calculate conditional probabilities and thus address questions such as: - how likely is it to observe an unusually large return in a specific market given that a large return is observed for another? – which markets are most closely linked in such situations? We separately analyse the joint extreme events in either absolute, positive or negative returns. And we divide the sample into two sub-samples. This allows us to address questions such as: - are dependencies different depending on whether both markets crash or boom? and – have dependencies become stronger over time?

We find the following. First, market links in situations of unusually large returns appear to have become closer over time. Second, links are generally higher for large negative returns than for large positive ones. Third, the links differ somewhat depending on which pair of countries is considered. Stock markets in the Netherlands and France are more closely linked to the German market than the markets in the United Kingdom and in Italy are.

3 It also uses a different sample of countries and markets, daily rather than weekly data and a much longer time period.

Fourth, links are relatively symmetric in the sense that the conditional probability of an extreme event in one country given an extreme event in the other is similar irrespective of which of the two countries is the conditioning one. For example, the likelihood of a crash in Germany given a crash in the Netherlands is similar to the likelihood of a crash in the Netherlands given a crash in Germany. Section II describes the technique used, section III presents the results and section IV concludes.

II. Methodology

We suggest to measure dependency between two markets by the probability of an unusually large return in one market given an unusually large return in the other market, $P(r_1^2 > x \mid r_2^2 > y)$, where r_1^2 and r_2^2 are squared returns and x and y are given thresholds. To estimate this probability, we use a non-parametric approach, i.e. the *spectral measure* suggested by Stărică (2000) which only assumes *regular variation* of the tails. Regular variation means that one allows for geometric decay of the tails at the rate α ,⁴ rather than (faster) exponential decay as in the case of a normal distribution. Stărică has shown that under the assumption of multivariate regular variation of the random vector of returns, knowledge of the spectral measure allows one to calculate empirical conditional probabilities of extreme events, such as those that we are interested in. The spectral measure ν is defined on the interval $[0, \pi/2]$. Its density at the angle θ can be interpreted as the probability that the $\arctan(r_2^2/r_1^2) = \theta$ given that (at least) one of the returns was extreme. If most of the mass concentrates around $\pi/4$ then the occurrences of extreme movements in the two components are strongly linked, i.e. an extreme return in one equity market is almost surely matched by an extreme movement in the other. If most of the mass concentrates around 0 or $\pi/2$, then the occurrences of extreme returns on the two markets are independent of each other, i.e. extreme returns in one market are not matched by extreme movements in the other market (see for a graphical illustration Figure 1).

4 The distribution of a one-dimensional variable r_i is said to be *regularly varying* at ∞ with index $\alpha > 0$ if the tail probabilities can be written as $P(r_i > x) = x^{-\alpha} L(x)$, for all $x > 0$, where L is a function converging to a positive constant as x goes to infinity. Intuitively, the index α means that the probability of the random variable r_i larger than a given value x decreases as $x^{-\alpha}$, for x large. See Embrechts *et. al.* (1997). For the multivariate case see Stărică (2000).

Figure 1: Simplified illustration of the spectral measure

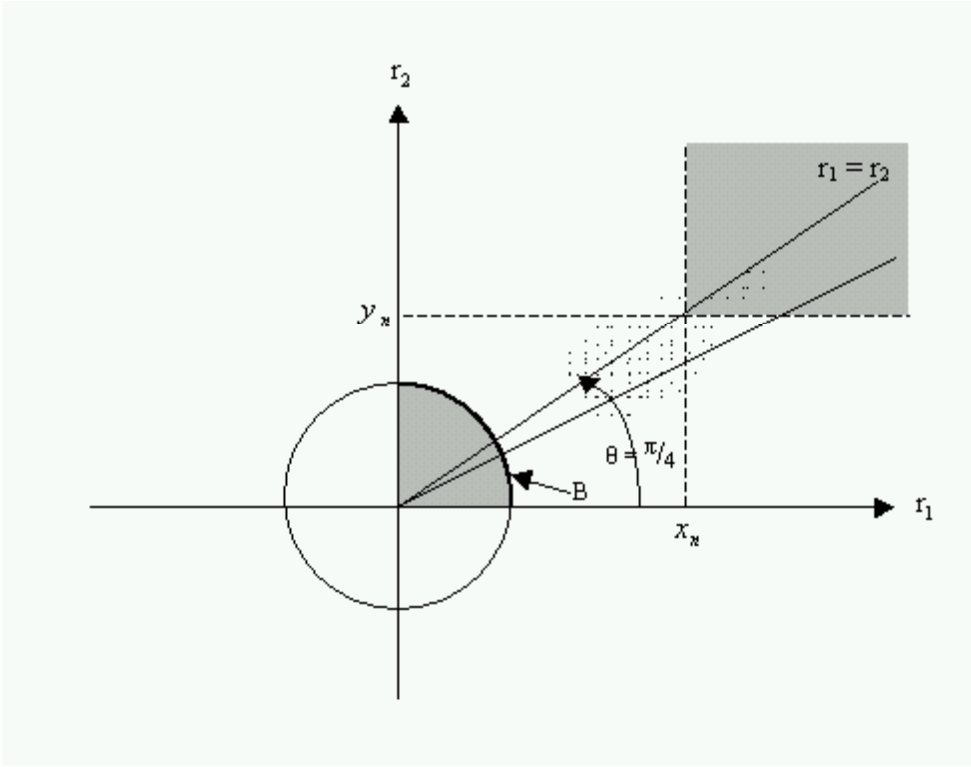

Explanation: Consider a bivariate vector of squared returns $r = (r_1^2, r_2^2)$. Focusing on squared returns has the advantage that they can be analysed in the first quadrant, defined by $[0, \infty)^2$. Our measure of extreme value dependence focuses on those pairs of (squared) returns where at least one of them is considered extreme, i.e. exceeding x_n or y_n , the x -th and y -th quantiles of the distribution of r_1^2 and r_2^2 , respectively. In this context, we consider a pair as extreme if the return in that market on which the probability is conditioned on is extreme. The dependency measure used here scales down the observations far away from the centre, so that they lie on the unit circle (denoted by B). Then it measures the distribution of the thus scaled observations on B . The exact location of the scaled observations on B is defined by the angle θ from the origin, which can take on values between 0 (intersection of B with x -axis or zero degrees) and $\pi/2$ (intersection of B with y -axis or 90 degrees), with the “middle” of the distribution being given by values around $\pi/4$ (or 45 degrees). Remember that $\arctan(r_2^1/r_1^2)$ takes the slope r_2^1/r_1^2 of a right-angled triangle and returns the angle of a straight line with that slope. Thus, intuitively the density of the *spectral measure* at $\theta \in [0, \pi/2]$ can be interpreted as a measure of the likelihood that $\arctan(r_2^1/r_1^2) = \theta$ given that at least one of the returns was extreme.

We estimate the measure ν by the *empirical* tail measure $\hat{\nu}_n$, given as

$$(1) \quad \hat{\nu}_n = \frac{1}{k} \sum_{i=1}^n \mathbb{1}_{\hat{r}_i}, \quad \text{with} \quad \hat{r}_i = \frac{r_i}{\left(\frac{n}{k}\right)^{1/\hat{\alpha}}}$$

and where n is a bivariate vector of squared returns, $r_t = (r_1^2, r_2^2)$, with time index t , and $\mathbb{1}_{\hat{r}_i}$ is an indicator function taking the value of 1 if one of the elements of r_t was extreme,

and otherwise 0. $\hat{\alpha} = \frac{1}{k} \sum_{i=1}^k \log \frac{|r_{i,n}|}{|r_{k,n}|}$ is the standard Hill (1975) estimator,⁵ with $r_{k,n}$ being

the k -th largest order statistic of the sample of n pairs, or, loosely speaking the k -th largest return pairs.⁶ The parameter k defines extreme events. Following widespread practice,⁷ we choose k by plotting the estimators as a function of the threshold and select k in the region over which the estimates of the spectral measure tend to be constant. Within that region we tend to choose a rather low value of k to ensure that the estimates capture only the tail behaviour and are not biased by the mass in the centre of the distribution.

We estimate the conditional probability

$$(2) \quad P(r_2^2 > y_p / r_1^2 > x_p) = \frac{P(r_2^2 > y_p, r_1^2 > x_p)}{P(r_1^2 > x_p)},$$

where x_p and y_q are the $(100 - p)\%$ and $(100 - q)\%$ quantiles of the distribution of r_1^2 and r_2^2 , respectively, for given p and q . Our estimates are based on the following:

$$(3) \quad P(r_2^2 > y_p, r_1^2 > x_p) \approx \frac{k}{n} \hat{\nu}_n \left(\left\{ (s, t) : s > \frac{y_q}{r_{2,k,n}^2}, t > \frac{x_p}{r_{1,k,n}^2} \right\} \right).$$

5 Stărică shows that this is a consistent estimator of α for a wide range of time series processes, including those of the GARCH and constant conditional correlation type.

6 Note that unlike in the one-dimensional case, concepts such as order statistics do not have natural definitions and, instead, several different concepts of ordering are possible. Here, we choose an ordering according to the return in that country on which the probability is conditioned on.

7 See e.g. Embrechts *et. al.* (1997) and De Haan and de Ronde (1998), cited after Hartmann.

III. Empirical application

The data and some descriptive statistics

The data consist of closing prices of daily stock market indices for Germany (DAX), France (CAC 40), Italy (ITSMBANC), United Kingdom (FTSE) and Netherlands (CBS) from January 2, 1973 to July 10, 2001 (see for details appendix 1). Daily rates of return are calculated as the natural logarithm of the ratio of two consecutive daily prices.⁸ Thus, the full sample consists of 7440 observations. Dividing the latter into two sub-samples of equal length (January 2, 1973 to April 7, 1987 and April 8, 1987 to July 10, 2001) means that each sub-sample has 3720 observations, which is still large compared with several other studies.⁹

We use a bivariate framework, looking at the dependencies between the German market and the other four markets separately. Hence, we have four different country pairs: Germany-United Kingdom, Germany-Italy, Germany-France and Germany-Netherlands. For each of the two sub-samples, we look at absolute, positive and negative return pairs, where positive (negative) return pair denotes those return pairs where both returns are positive (negative). Thus, we estimate (i) the conditional probability of an (any) unusually large return, given an unusually large return in the other market, (ii) the conditional probability of a an unusually large positive return in one country given an unusually large positive return in the other (joint boom) and (iii) the conditional probability of a an unusually large negative return in one country given an unusually large negative return in the other (joint crash).¹⁰

Scatterplots of positive and negative return pairs for the two sub-samples are shown in Figure 2, each row showing four plots for one country pair. In some instances, specifically negative German-French and German-Dutch return pairs in the recent sub-sample, the data exhibit a V- rather than a U-shape, indicating pronounced tail dependence, that is the tendency to have unusually large values of the two series simultaneously.

8 Summary statistics of the univariate index return series are reported in Appendix table 1. The (excess) kurtosis measures and the Jarque-Bera statistics are generally highly significantly different from zero. This confirms earlier findings that the returns are not normal, but have more mass in the tails than would be predicted by a normal distribution. Thus, their *joint* distribution will not be normal either.

9 Danielsson and De Vries (1997) suggest that 1000 observations may be sufficient for the application of EVT. However, some empirical applications have used fewer observations, *e.g.* Hartmann *et al.* (2001), Longin and Solnik (2001) and Bae *et al.* (2000) use samples with 623, 456 and 880 observations, respectively.

10 We require both returns to be positive (negative) to avoid that squared negative (positive) returns are mixed with squared positive (negative) returns when estimating the spectral measure. This implies a loss of observations, *i.e.* we loose those pairs where one return is positive and the other negative, but there are only very few such observations when (German) returns are unusually large, which is our primary interest.

Figure 2: Scatter plots of positive and negative return pairs

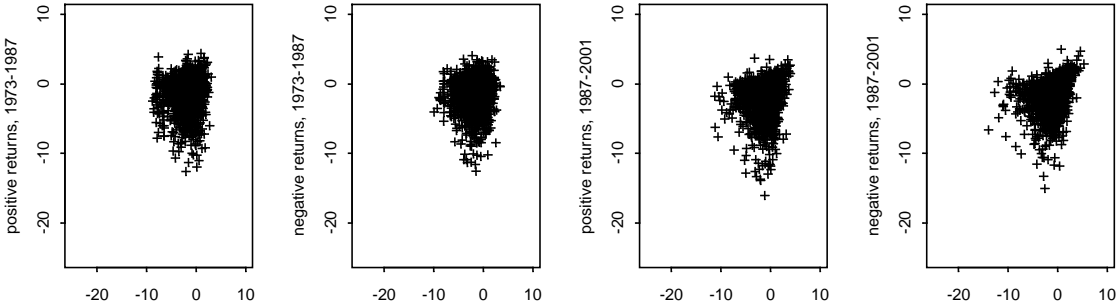

Germany and the United Kingdom

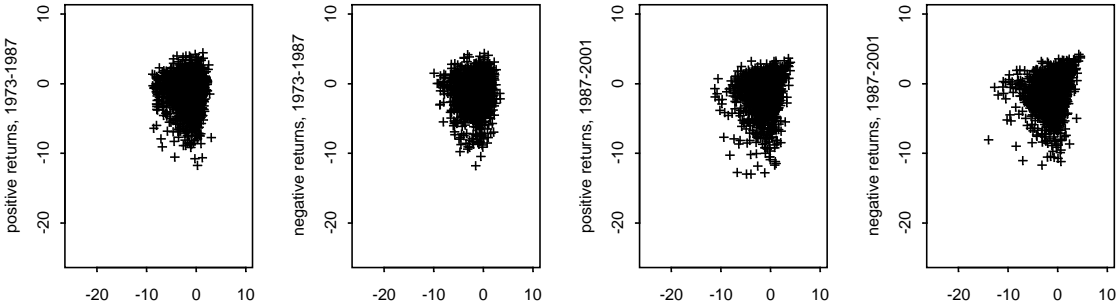

Germany and Italy

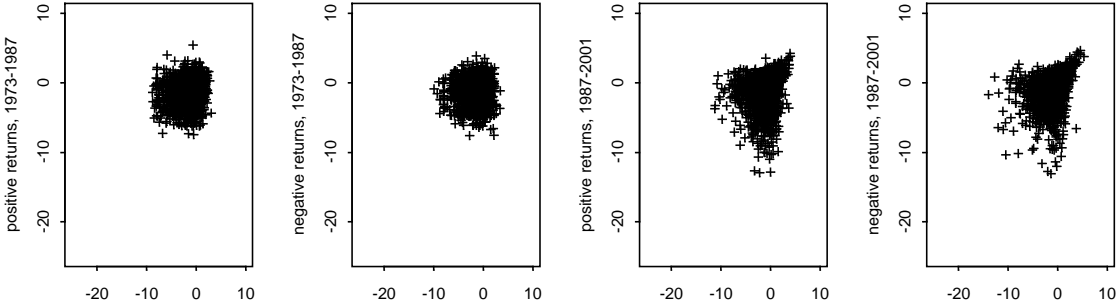

Germany and France

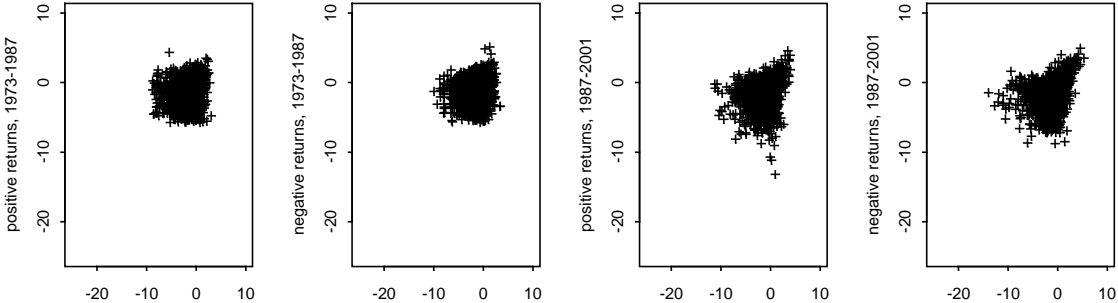

Germany and the Netherlands

Results

Four results are singled out for special attention.¹¹ First, we find that European stock market dependencies have become stronger over time, as evidenced by the very noticeable differences in estimates between the two sub-samples. Dependencies during the first sub-sample are generally weak, as reflected in the clear U-shape of density estimates for θ with peaks around 0 and $\pi/2$ shown in the left column of figure 3 (where θ is denoted by „theta“, with values from 0 to $\pi/2$, or approximatively 1.57). Figure 4 shows the associated estimated conditional probabilities for different quantiles. For example, the value shown at -1.0 is the estimated conditional probability of a 99 per cent quantile event in the other country given a 99 per cent event in Germany and the value shown at -2.0 is the estimated conditional probability of a 98 per cent quantile event in the other country given a 99 per cent quantile event in Germany, and so on. The left column of figure 4 shows that the estimated conditional probability of a 99 per cent quantile absolute return in a country given a similar return in Germany never exceeds 20 per cent. In other words, an unusually large absolute return in Germany is only accompanied by a return in the same quantile in the other country in less than one out of five cases. In contrast, looking at the more recent sub-sample, estimated densities change noticeably. Specifically, they have more mass in the middle (Figure 3, right column) and conditional probabilities of extreme events are much higher, ranging from 0.33 to 0.50 (Figure 4, right column).

Identifying increasing European stock market dependencies, our first result confirms those obtained by other studies using different techniques (*e.g.* Hardouvelis *et. al.*, 1999 and Fratzscher, 2000). We concur with those authors that the increase in dependencies likely reflects the continuous removal of various barriers to intra-European investment. However, our estimates do not allow us to distinguish whether the dependencies reflect direct bilateral links or the joint response of the two markets to developments in a third market. While an interesting additional issue, this is beyond the scope of the present paper which focuses on dependency in an arbitrage sense without attempting to explain the underlying mechanisms for the dependency. Against this background the interpretation of our results in the remainder of this section have to be regarded as tentative.

¹¹ Estimates are made using S-Plus procedures, building on those kindly obtained from Catalin Stărică.

Figure 3: Density estimates for unusually large returns

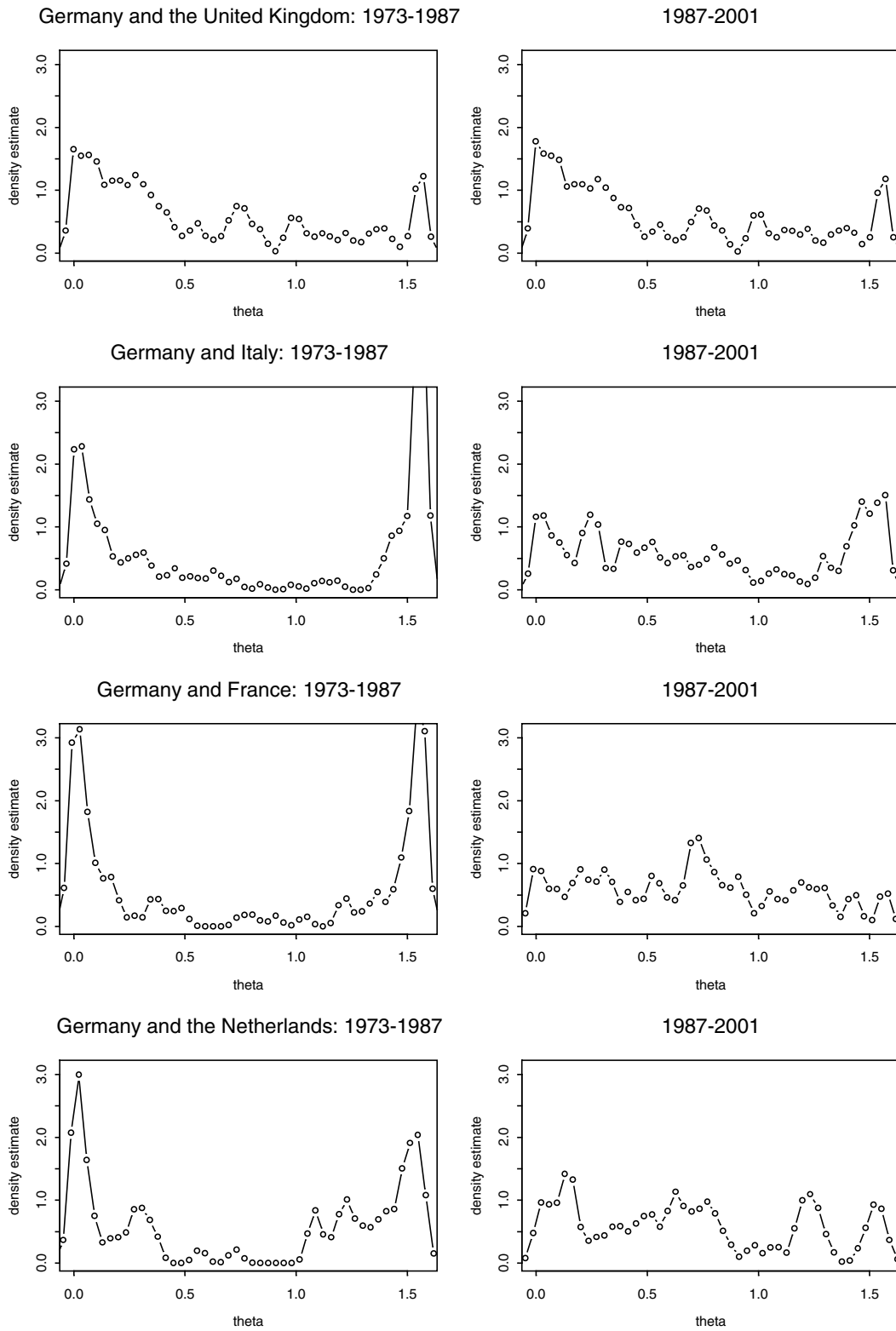
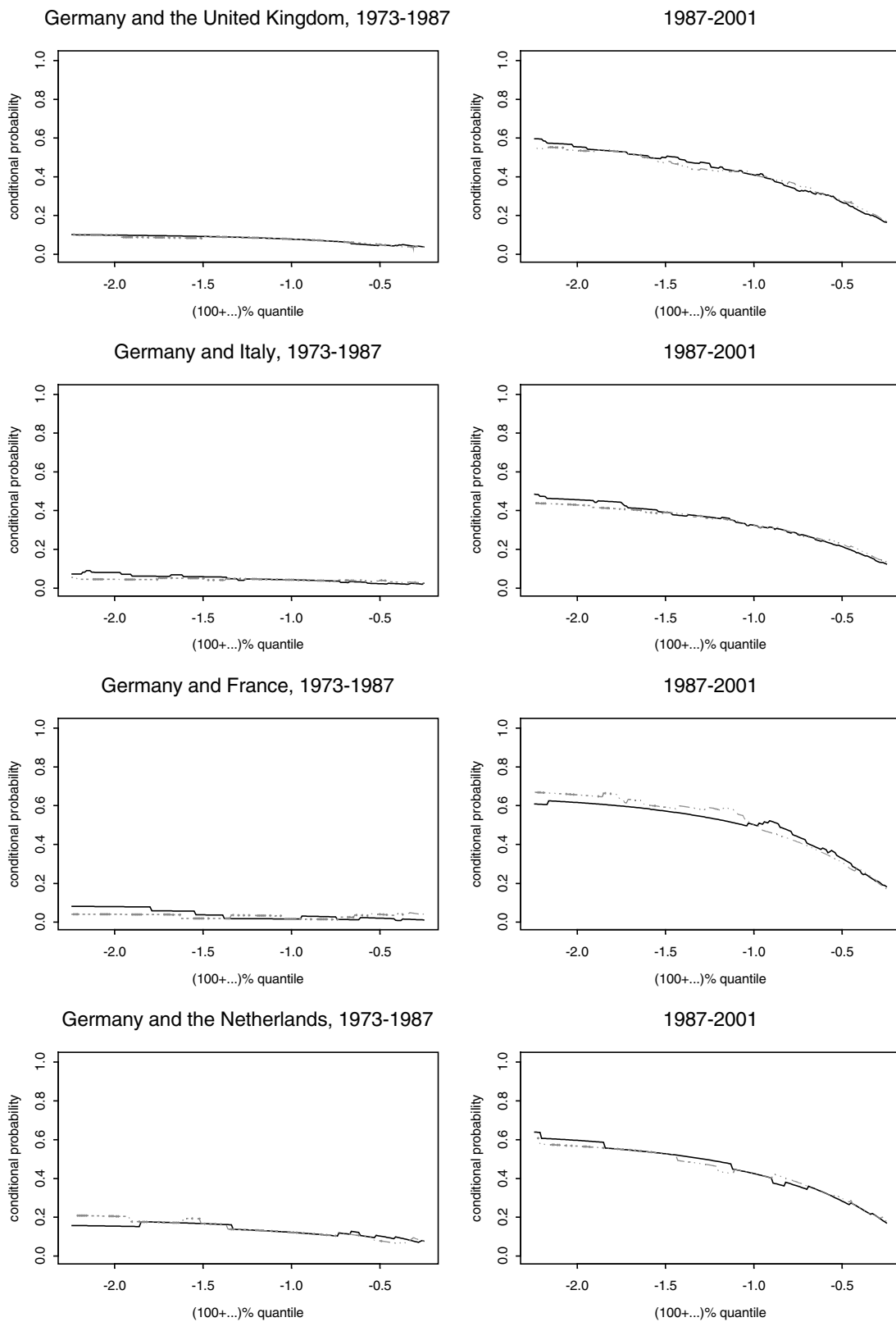

Figure 4: Conditional probabilities of unusually large returns



Note that our estimates suggest that linkages are far from perfectly tight.¹² This would be reflected in very pronounced peaks in the middle of the distribution with little mass on the left-hand and right-hand sides. However, our estimates generally show that considerable mass is spread over the full support, even for the more recent sub-sample as will be discussed below. If anything, the shape of the distribution in the cases with relatively high estimated linkages is more similar to a uniform distribution than to one, which has most mass right in its middle. Two tentative explanations are suggested here. First, this may partly reflect the remaining obstacles to full integration. For example, while the costs for domestic investors for hedging inflation in the foreign (EMU) country has become smaller as inflation rates converged during the 1990s, divergences remain. Second, and more likely, this may reflect that even our most recent sub-sample may go too far back in history, thus possibly mixing observations from periods of low with those of very high stock market integration. For example, the results by Fratzscher (2001) suggest that European equity markets have become significantly more integrated only since 1996. Unfortunately, looking at shorter sub-samples of only a few years is problematic on the basis of the present technique, as smaller samples could imply inconsistent estimates. Future research could experiment with shorter sub-samples using intra-day data.

Second, we find that dependencies differ between the pairs of countries chosen. For example, dependencies between Germany and Italy do not seem to be strong. The typical density function has a more or less pronounced U-shape with very little mass in the middle and most mass concentrated around 0 and $\pi/2$, even for the more recent sample (Figure 3). This means that an extreme return in one country is generally not accompanied by an extreme return in the other country. This is reflected in a conditional probability estimate for 99 per cent quantile absolute returns close to zero for the first and just above 30 per cent for the most recent sample (Figure 4). By contrast, for example, dependencies between Germany and France are much stronger. Especially during the recent period the distribution is overall more equal and peaks in the middle at around $\pi/4$. The estimated conditional probability of a 99 per cent quantile absolute return is equal to 0.50. In other words, unusually large absolute returns are as often shared by both countries as they are confined to just one of them. Dependencies for the other two country pairs lie in between the two described above.

¹² The latter result is similar to Hartmann *et al.* (2001), though our estimates suggest nevertheless a much higher degree of integration than these authors using data over a similar period (from 1987 to 1999 in their case, as compared with 1987 to 2001 here). This difference may reflect the different data frequency. While Hartmann *et al.* use weekly data, we use daily data. Indeed, looking at average weekly average data instead of daily data, we find much lower conditional probabilities, similar to those reported in Hartmann *et al.* (2001).

We suggest that exchange rate uncertainties go a long way explaining the differences in estimated cross-border stock market linkages. Specifically, such uncertainties were particularly important during the EMS crisis for the United Kingdom and Italy, which left the EMS in September 1992. Another explanation for the estimated cross-country differences in dependencies may be trade links: High trade dependence and business cycle integration is likely to lead to more homogenous cash flow expectations across borders, as companies' profits are more dependent on area-wide business cycles. Indeed, among the countries considered here, Germany is the most important trading partner for the Netherlands, and France the most important one for Germany. However, while this may explain the differences in estimated linkages among the different country pairs, it cannot explain the increase in stock market dependencies over time. Relative trade links among the countries under consideration have hardly changed between the two sub-periods. If anything, German-Dutch as compared to the other trade links have become slightly less important during the second as compared to the first sub-sample. We conclude that the reduction in currency risk is the most important explanation for the much stronger increase in dependencies between Germany and France or the Netherlands than between Germany and the United Kingdom or Italy.

Third, distinguishing between positive and negative returns shows that dependencies are stronger for negative than positive returns (Table 1). Also, the cross-country differences in estimated dependencies are more noticeable in the case of the former. For example, while the density estimates for Germany-United Kingdom and Germany-Italy have a more or less pronounced U-shape with peaks at the ends even for the more recent sub-sample, the estimated densities for Germany-France and Germany-Netherlands for the more recent period peak in the middle at $\pi/4$ (Figure 5). This indicates pronounced tail dependence. This is reflected in estimates of conditional probabilities of negative returns in the 99 per cent quantiles, which are equal to 0.61. Thus, if there is an unusually large negative return in Germany, in three out of five cases there is also an unusually large negative return in both France and the Netherlands.

Figure 5: Density estimates for unusually large negative returns

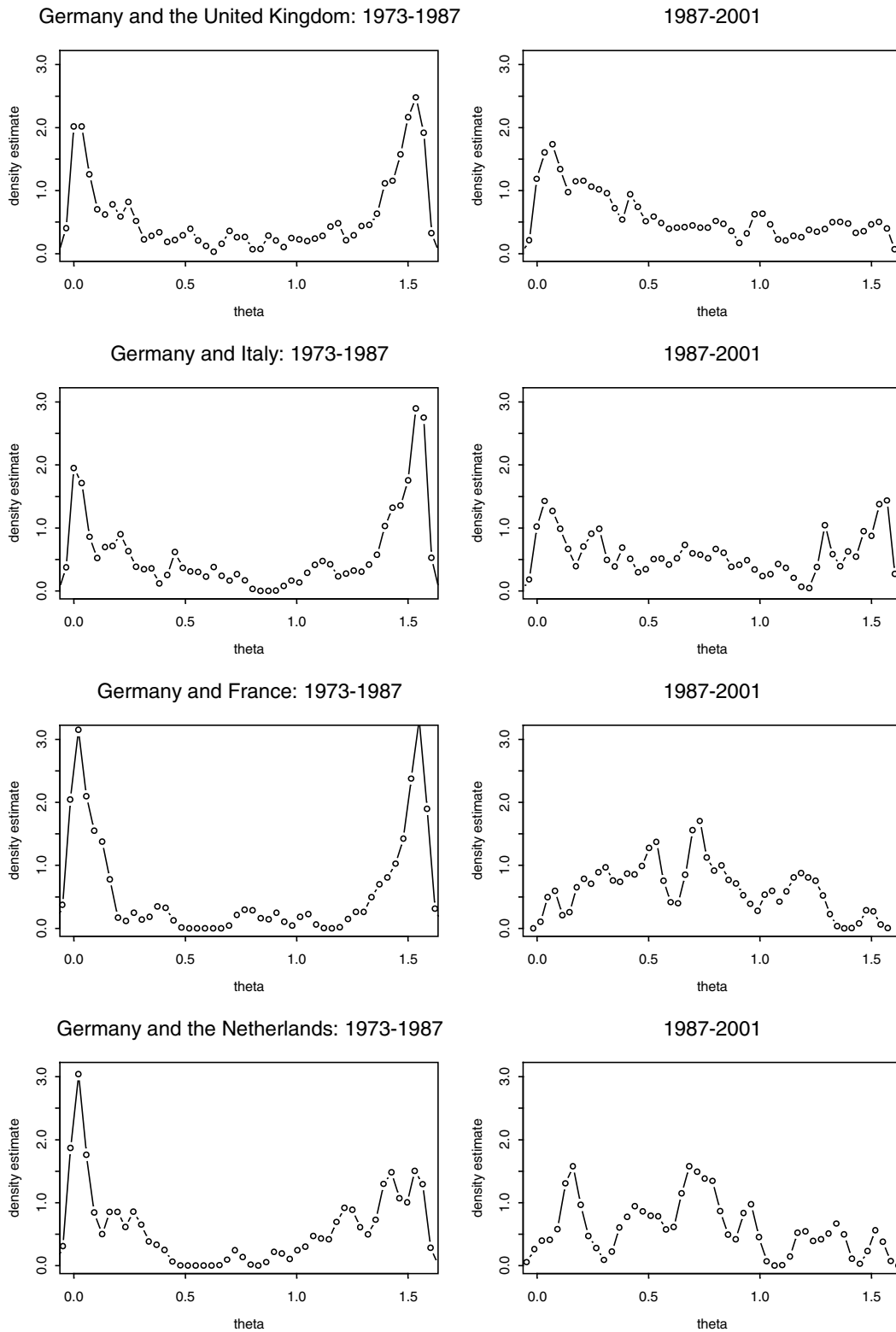

Figure 6: Conditional probabilities of unusually large negative returns

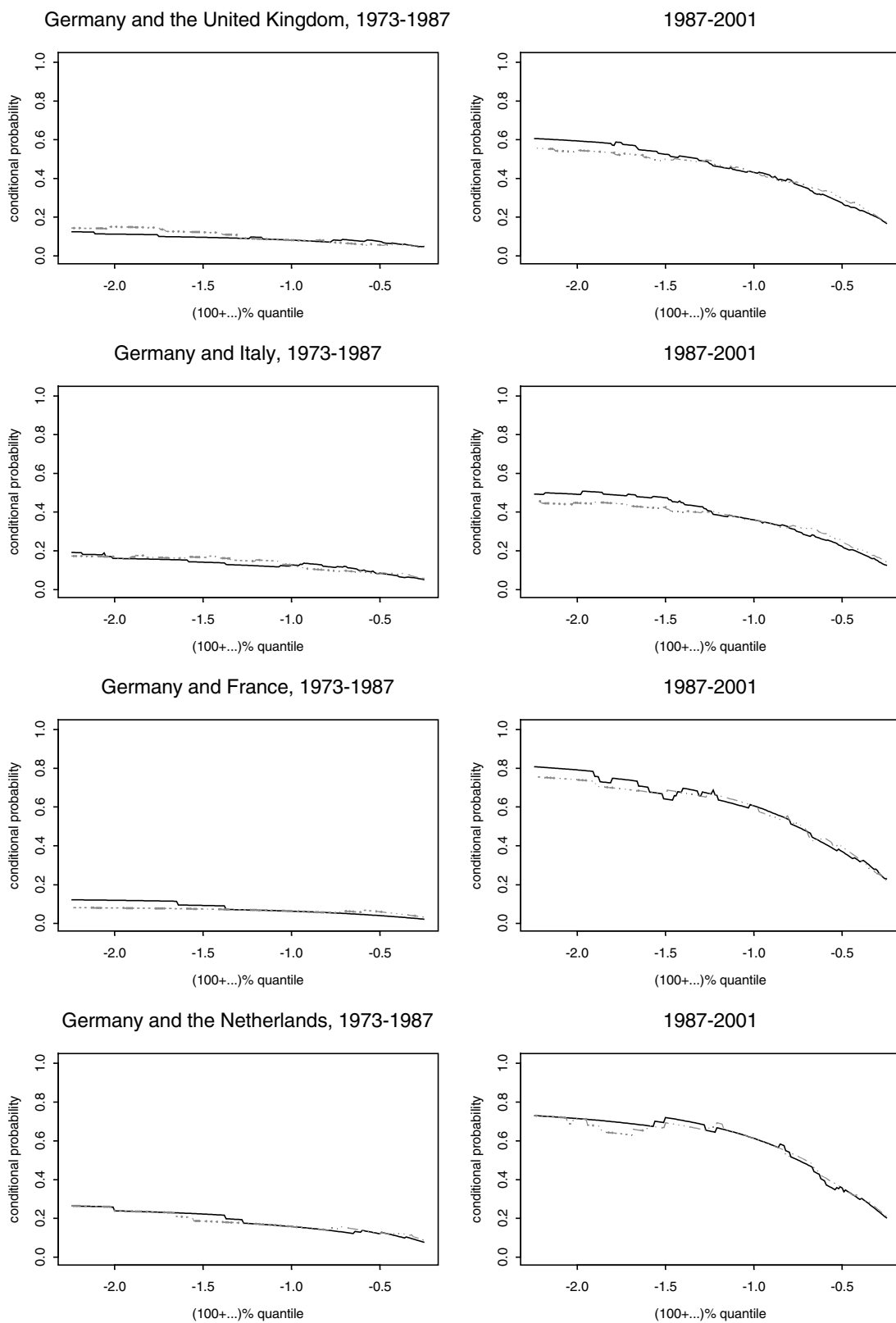

Table 1: Conditional probability of unusually large returns
(probability of return in 99 [98] per cent quantile in ...
given a return in 99 per cent quantile in Germany)

Type of return in Germany	Sample period	Return in 99 [98] quantile in...			
		United Kingdom	Italy	France	Netherlands
Absolute	1973-1987	0.07 [0.09]	0.04 [0.08]	0.02 [0.08]	0.12 [0.15]
	1987-2001	0.41 [0.56]	0.33 [0.46]	0.50 [0.62]	0.42 [0.60]
Positive	1973-1987	0.13 [0.21]	0.10 [0.12]	0.06 [0.09]	0.13 [0.23]
	1987-2001	0.38 [0.46]	0.21 [0.34]	0.41 [0.50]	0.40 [0.56]
Negative	1973-1987	0.08 [0.11]	0.13 [0.16]	0.06 [0.12]	0.16 [0.24]
	1987-2001	0.43 [0.59]	0.36 [0.49]	0.61 [0.79]	0.61 [0.72]

Explanation: Each probability estimate is based on a specific choice of k , the number of upper-order statistics. The choices of k are (column wise) as follows: 95, 95, 95, 95, 95, 95 for the United Kingdom; 100, 100, 100, 100, 100, 100 for Italy; 45, 45, 50, 45, 45, 35 for France and 35, 30, 50, 35, 45, 30 for Netherlands. As the k 's differ for positive, negative and any returns for each country, the three estimated probabilities for each country are not necessarily systematically related each one to another. Testing for robustness of the conditional probability estimates with respect to the choice of k , we find the estimates mostly stable when k is varied by plus and minus 10. In almost one out of two instances did the maximum variation in the estimated probability (from either a reduction or increase in k) not exceed one per cent. In all but three instances was this variation smaller than five per cent. The three exceptions are the case of all returns for Germany-Netherlands and the cases of negative returns for Germany-Netherlands and Germany-France. In the case of the latter, reducing k lowers the estimated probability and increasing k raises it, in each case by about 0.09. In the other two cases the maximum variation could attain plus 0.09 (absolute returns) and minus 0.15 (negative returns). Controlling for the stock market crash in 1987 (by excluding data for October and November 1987), the estimated parameters change slightly, but the qualitative results remain unchanged.

The third result confirms those obtained by Koutmos and Booth (1995), Longin and Solnik (2001) and Poon, Rockinger and Tawn (2001), while Bae, Karolyi and Stulz (2000) find only mixed evidence in favour of the hypothesis that cross-country financial market links are stronger in bear rather than bull markets. Several factors may explain our results. To the extent that significantly large negative returns are associated with more a wide-spread drying up of liquidity, investors will find it harder to fund themselves because of liquidity shortages and the ensuing rebalancing of their portfolio is likely to trigger a spill-over between markets. The trend towards portfolio retrenchment is reinforced when individual fund managers have powerful incentives to produce returns that do not deviate

too much on the downside from average. In addition, in situations when prices turn against them, highly leveraged financial institutions are required to provide more collateral or close out their positions (“marking to markets”). In the face of daily marking to markets this may lead to rapid adjustments of positions and, if other positions are closed to free up collateral, to spill-overs to other markets within the same day. Prudential ratios and self-imposed “stop-loss limits” have similar effects. All these factors suggest that markets may be closer linked during bull rather than bear markets.

Fourth, the estimated conditional probabilities are *symmetric* in the sense that they are broadly similar irrespective of which one of the two markets is chosen as the one on which the probability is conditioned on. This is evidenced by the small differences between the straight line (conditional probability of extreme return in other country given an extreme return in German market) and the dotted line (conditional probability of extreme return in German market given extreme return in the other market). If anything, there is a small divergence between the two estimated probabilities to the left of the 98.5 per cent quantiles in the case of negative returns. This would suggest that the German market exhibit more inertia. However, the evidence is at best very limited and we cannot identify substantial asymmetries. This differs from the results of studies including the US market, which is generally found to significantly influence other markets (*e.g.* Hamao, Masulis, Ng, 1990). Our results can be seen as consistent with the hypothesis that there is no single most influential stock market in Europe.

IV. Conclusions

Our estimates show that MEVT is a useful tool to analyse cross-border market links in situations of unusually large price changes. We find considerable dependencies between some stock markets, especially in the case of extreme negative returns. Moreover, using two sub-samples each of fourteen years we find that dependencies have increased noticeably in the more recent period as compared with the earlier one. This likely reflecting the continuous removal of various barriers to intra-European investment. Thus, our results point to the limits to which international portfolio diversification can reduce risks. In particular, where dependencies of extreme returns are very tight (as for Germany-France and Germany-Netherlands), the diversification of international portfolios may fail to deliver exactly when its benefits are needed the most.

Appendix 1: The data

The sample consists of daily stock market indices (closing quotes) for Germany, France, Italy, the United Kingdom and Netherlands from January 2, 1973 to July 10, 2001. When collecting the data, recourse had to be made to various sources. The DAX index for Germany has been obtained from the Bank for International Settlements (BIS) Macro Databank up to November 11, 1999. Recent updates were made using Bloomberg (ticker symbol DAX). Data for United Kingdom's FTSE All Shares index before April 1, 1986 has been obtained from FTSE and thereafter from Bloomberg (ticker symbol ASX). Data on the Italian ITSMBANC has been extracted from Bloomberg (ticker symbol ITSMBANC). For France two indices had to be appended. Before July 16, 1987 the CAC Général index - obtained from Paris Bourse - was used and from that date the CAC40 - obtained from Bloomberg (ticker symbol CAC). The former was linearly transformed so that the last observation for the CAC Général index exactly matched the first observation for the CAC40. The Dutch CBS All Shares Index since January 1980 has been obtained from the Nederlandsche Bank in electronic form and from January 1973 to December 1979 in paper form. The series had to be rebased twice (up to November 1, 1974 and up to January 2, 1980) to a common base of 100 for December 29, 1983. Recent updates were made using Bloomberg (ticker symbol CBSA). As bank holidays differ between countries, observations for all countries were not available at some dates. In those cases, the missing observation was replaced by the data from the last trading day before the bank holiday (an option called "carry over last price" in Bloomberg).

Appendix 2: Summary statistics of daily stock returns

	DAX	FTSE	ITSM	CAC	CBS
January 2, 1973 to July 10, 2001					
Mean	0.03	0.04	0.04	0.04	0.03
Minimum	- 13.71	- 11.91	-0.02	-15.11	-13.05
Maximum	7.29	8.94	8.30	8.23	1.13
Std. dev.	1.12	1.01	1.30	1.10	1.02
Kurtosis	9.04	9.73	5.28	0.34	14.54
Skewness	- 0.64	- 0.33	- 0.48	- 0.70	- 0.48
Jarque Bera	25843 *	29499 *	8917 *	33751 *	65807 *
January 2, 1973 to April 7, 1987					
Mean	0.02	0.04	0.05	0.04	0.02
Minimum	- 5.46	- 7.56	-0.02	-15.11	-13.05
Maximum	4.69	8.94	8.30	7.35	1.13
Std. dev.	0.88	1.11	1.36	0.93	9.84
Kurtosis	2.03	5.79	6.35	22.96	17.27
Skewness	- 0.13	0.20	- 0.50	- 1.29	- 0.21
Jarque Bera	646*	5229 *	6408 *	82713 *	46236 *
April 8, 1987 to July 10, 2001					
Mean	0.04	0.03	0.02	0.03	0.04
Minimum	-13.71	-11.91	- 8.47	-0.14	-11.99
Maximum	7.29	5.70	6.53	8.23	9.84
Std. dev.	1.31	9.08	1.23	1.25	1.05
Kurtosis	8.71	16.96	3.47	5.17	12.36
Skewness	- 0.77	- 1.30	- 0.45	- 0.42	- 0.69
Jarque Bera	12123 *	45641 *	1991 *	4245 *	23975 *

Note : * denotes significance at the 1% level; *i.e.* rejection of the null hypothesis of normality.

BIBLIOGRAPHY

- BAE, K., G.A. KAROLYI and R.M. STULZ (2000), “A new approach to measuring financial integration”, *mimeo*.
- BOYER, B. H., M. S. GIBSON and M. LORETAN (1999), “Pitfalls in tests for changes in correlations”, Federal Reserve Board, *IFS Discussion Paper No. 597R*, March.
- DANIELSSON, J. and C.G. DE VRIES (1997), “Beyond the sample: Extreme quantile and probability estimation”, *mimeo*, Tinbergen Institute Rotterdam.
- DE HAAN, L. and J. DE RONDE (1998), “Sea and wind: multivariate extremes at work”, *Extremes*, Vol. 1, pp. 7-45.
- EMBRECHTS, P., C. KLÜPPELBERG and T. MIKOSCH (1997), “Modelling extremal events for insurance and finance”, Springer Verlag, Berlin.
- FRATZSCHER, M. (2001), “Financial market integration in Europe: on the effects of EMU on stock markets”, *ECB Working Paper No. 48*, March.
- HAMAQ, Y., R.W. MASULIS and V. NG (1990), “Correlations in price changes and volatility across international stock markets”, *Review of Financial Studies* Vol. 3, No. 2, pp. 281-307.
- HARDOUVELIS, G., D. MALLIAROPULOS and R. PRIESTLEY (1999), “EMU and European stock market integration”, Paper presented at the Seminar of the Fondation Banque de France, 21-22 October.
- HARTMANN, P., S. STRAETMANS and C.G. DE VRIES (2001), “Asset market linkages in crisis periods”, *ECB Working Paper No. 71*, July.
- JONDEAU E. and M. ROCKINGER (1999), “The tail behavior of stock returns: emerging versus mature markets”, *Notes d’Etudes et de Recherche*, Banque de France, NER# 66, June.
- KOUTMOS, G. and G.G. BOOTH (1995), “Asymmetric volatility transmission in international stock markets”, *Journal of International Money and Finance*, Vol. 14, No. 6, pp. 747-762.

- LONGIN, F. and B. SOLNIK (2001), “Extreme correlation of international equity markets”, *The Journal of Finance* Vol. LVI, No. 2, April, pp. 649-676.
- McNEIL, A.J. (1999), “Extreme Value Theory for Risk Managers”, *mimeo*, ETH Zürich, Department of Mathematics, May, 17.
- POON, S., M. ROCKINGER and J. TAWN (2001), “New Extreme-Value Dependence Measures and Finance Applications”, *CEPR Discussion Paper* No. 2762, April.
- SCHEICHER, M. (2001), “The comovements of stock markets in Hungary, Poland and the Czech Republic”, *International Journal of Finance and Economics* Vol. 6, No. 1, pp. 27-39.
- STĂRICĂ, C. (2000), “Multivariate extremes for models with constant conditional correlations”, Department of Statistics, The Wharton School, University of Pennsylvania and Chalmers University of Technology.

The following papers have been published since 2001:

January	2001	Unemployment, Factor Substitution, and Capital Formation	Leo Kaas Leopold von Thadden
January	2001	Should the Individual Voting Records of Central Banks be Published?	Hans Gersbach Volker Hahn
January	2001	Voting Transparency and Conflicting Interests in Central Bank Councils	Hans Gersbach Volker Hahn
January	2001	Optimal Degrees of Transparency in Monetary Policymaking	Henrik Jensen
January	2001	Are Contemporary Central Banks Transparent about Economic Models and Objectives and What Difference Does it Make?	Alex Cukierman
February	2001	What can we learn about monetary policy transparency from financial market data?	Andrew Clare Roger Courtenay
March	2001	Budgetary Policy and Unemployment Dynamics	Leo Kaas Leopold von Thadden
March	2001	Investment Behaviour of German Equity Fund Managers – An Exploratory Analysis of Survey Data	Torsten Arnswald
April	2001	The information content of survey data on expected price developments for monetary policy	Christina Gerberding
May	2001	Exchange rate pass-through and real exchange rate in EU candidate countries	Zsolt Darvas

July	2001	Interbank lending and monetary policy Transmission: evidence for Germany	Michael Ehrmann Andreas Worms
September	2001	Precommitment, Transparency and Monetary Policy	Petra Geraats
September	2001	Ein disaggregierter Ansatz zur Berechnung konjunkturbereinigter Budgetsalden für Deutschland: Methoden und Ergebnisse *	Matthias Mohr
September	2001	Long-Run Links Among Money, Prices, and Output: World-Wide Evidence	Helmut Herwartz Hans-Eggert Reimers
November	2001	Currency Portfolios and Currency Exchange in a Search Economy	Ben Craig Christopher J. Waller
December	2001	The Financial System in the Czech Republic, Hungary and Poland after a Decade of Transition	Thomas Reininger Franz Schardax Martin Summer
December	2001	Monetary policy effects on bank loans in Germany: A panel-econometric analysis	Andreas Worms
December	2001	Financial systems and the role of banks in monetary policy transmission in the euro area	M. Ehrmann, L. Gambacorta J. Martinez-Pages P. Sevestre, A. Worms
December	2001	Monetary Transmission in Germany: New Perspectives on Financial Constraints and Investment Spending	Ulf von Kalckreuth
December	2001	Firm Investment and Monetary Trans- mission in the Euro Area	J.-B. Chatelain, A. Generale, I. Hernando, U. von Kalckreuth P. Vermeulen

* Available in German only.

January	2002	Rent indices for housing in West Germany 1985 to 1998	Johannes Hoffmann Claudia Kurz
January	2002	Short-Term Capital, Economic Transformation, and EU Accession	Claudia M. Buch Lusine Lusinyan
January	2002	Fiscal Foundation of Convergence to European Union in Pre-Accession Transition Countries	László Halpern Judit Neményi
January	2002	Testing for Competition Among German Banks	Hannah S. Hempell
January	2002	The stable long-run CAPM and the cross-section of expected returns	Jeong-Ryeol Kim
February	2002	Pitfalls in the European Enlargement Process – Financial Instability and Real Divergence	Helmut Wagner
February	2002	The Empirical Performance of Option Based Densities of Foreign Exchange	Ben R. Craig Joachim G. Keller
February	2002	Evaluating Density Forecasts with an Application to Stock Market Returns	Gabriela de Raaij Burkhard Raunig
February	2002	Estimating Bilateral Exposures in the German Interbank Market: Is there a Danger of Contagion?	Christian Upper Andreas Worms
February	2002	Zur langfristigen Tragfähigkeit der öffentlichen Haushalte in Deutschland – eine Analyse anhand der Generationenbilanzierung *	Bernhard Manzke
March	2002	The pass-through from market interest rates to bank lending rates in Germany	Mark A. Weth

* Available in German only.

April

2002

Dependencies between European
stock markets when price changes
are unusually large

Sebastian T. Schich

Visiting researcher at the Deutsche Bundesbank

The Deutsche Bundesbank in Frankfurt is looking for a visiting researcher. Visitors should prepare a research project during their stay at the Bundesbank. Candidates must hold a Ph D and be engaged in the field of either macroeconomics and monetary economics, financial markets or international economics. Proposed research projects should be from these fields. The visiting term will be from 3 to 6 months. Salary is commensurate with experience.

Applicants are requested to send a CV, copies of recent papers, letters of reference and a proposal for a research project to:

Deutsche Bundesbank
Personalabteilung
Wilhelm-Epstein-Str. 14

D - 60431 Frankfurt
GERMANY