

Al-Hroot, Yusuf Ali

Article

The Influence of Sample Size and Selection of Financial Ratios in Bankruptcy Model Accuracy

Economic Review: Journal of Economics and Business

Provided in Cooperation with:

Faculty of Economics, University of Tuzla

Suggested Citation: Al-Hroot, Yusuf Ali (2015) : The Influence of Sample Size and Selection of Financial Ratios in Bankruptcy Model Accuracy, Economic Review: Journal of Economics and Business, ISSN 2303-680X, University of Tuzla, Faculty of Economics, Tuzla, Vol. 13, Iss. 1, pp. 7-19

This Version is available at:

<https://hdl.handle.net/10419/193842>

Standard-Nutzungsbedingungen:

Die Dokumente auf EconStor dürfen zu eigenen wissenschaftlichen Zwecken und zum Privatgebrauch gespeichert und kopiert werden.

Sie dürfen die Dokumente nicht für öffentliche oder kommerzielle Zwecke vervielfältigen, öffentlich ausstellen, öffentlich zugänglich machen, vertreiben oder anderweitig nutzen.

Sofern die Verfasser die Dokumente unter Open-Content-Lizenzen (insbesondere CC-Lizenzen) zur Verfügung gestellt haben sollten, gelten abweichend von diesen Nutzungsbedingungen die in der dort genannten Lizenz gewährten Nutzungsrechte.

Terms of use:

Documents in EconStor may be saved and copied for your personal and scholarly purposes.

You are not to copy documents for public or commercial purposes, to exhibit the documents publicly, to make them publicly available on the internet, or to distribute or otherwise use the documents in public.

If the documents have been made available under an Open Content Licence (especially Creative Commons Licences), you may exercise further usage rights as specified in the indicated licence.



<https://creativecommons.org/licenses/by-nc-nd/4.0/>

THE INFLUENCE OF SAMPLE SIZE AND SELECTION OF FINANCIAL RATIOS IN BANKRUPTCY MODEL ACCURACY

Yusuf Ali Al-Hroot *

ABSTRACT

This paper aims to clarify the influence of changing both the sample size and selection of financial ratios in bankruptcy models accuracy of companies listed in the industrial sector of Jordan. The study sample is divided into three sub-samples counting 6, 10 and 14 companies respectively; each sample is composed of bankrupt companies and the solvent ones during the period from 2000 to 2013.

Financial ratios were calculated and categorized into two groups. The first group includes: liquidity, profitability, debt, and activity, while the second group includes ten most popular financial ratios found to be useful in earlier studies and expected to predict financial distress.

The results show that when 18 models built using discriminant analysis, the model based on most popular financial ratios, found to be useful in earlier studies, has the highest classification accuracy with 100% and consistently for all the samples before bankruptcy. The prediction accuracy varies among models when increasing the sample size from 6 to 14 companies for the models that developed from the financial ratios of the first group.

Keywords: Financial ratios, sample size, bankruptcy, discriminant analysis, Jordan.

JEL: G33

1. INTRODUCTION

Statistical prediction models such as discriminant analysis, logistic regression and neural network can predict business failure with a high accuracy rate within a few years before bankruptcy. Proper statistical bankruptcy prediction models can reduce losses for the users of financial statements, both internal and external, by sending a good alert signal before bankruptcy.

Since the late middle of the last century, researchers have been working to design bankruptcy prediction models using statistical techniques. Impressive results in many models accuracy achieved 100%. Researchers did not discuss the influence of selected financial ratios and the size of the sample of the same statistical method on bankruptcy prediction model accuracy.

The aims of our research are:

1. To assess the effect of changing financial ratio selection for the same statistical method to build bankruptcy prediction models.
2. To assess the effect of changing the size of the sample of the same statistical method to build bankruptcy prediction models.
3. To assess impact model accuracy by changing the size and the selected financial ratio for the same statistical method to build bankruptcy prediction models.

This study is organized as follows. The first section provides an introduction and literature review. In section two, we discuss research questions and specify the research hypothesis. Section three describes the research methodo-

logy. Section four discusses empirical results, and the last sections conclude the paper and summarize the findings of the study.

2. LITERATURE REVIEW AND HYPOTHESES DEVELOPMENT

2.1 LITERATURE REVIEW

The almost common statistical prediction models are Beaver’s (1966) model, Altman Z-Score 1968, Deakin’s (1972), Ohlson’s (1980), Zmijewski’s (1984) and Kida’s (1998) model. Studies have shown that the statistical prediction models and their variants have high accuracy in predicting corporate financial bankruptcy in the US and European countries.

Studies conducted outside Jordan concentrated in Europe and the United States tried to build a model to predict bankruptcy or to classify companies into two groups, and they were mostly

they only analyzed the differences between the models in terms of accuracy over different prediction time-frames (one, two or three years).

This study contributes to the literature on bankruptcy in several things. Firstly, the previous studies were built in developing economies, but this study was built from an emerging economy, namely Jordan. Secondly, prior studies in Jordan are limited and based on data from 1980 to 2005 (see for example Gharaibeh & Yacoub, 1987; Al-Omari, 2000).

This study uses a recent set of data that reflect the major changes that have taken place in Jordan economy. Finally, the findings expected to be obtained from the current study may be significant and useful to financial institutions, external auditors, internal auditors, investors and creditors as they may help to identify corporations that are likely to experience bankruptcy. The previous studies conducted by researchers in Jordan can be summarized in Table 2.1 below:

Table 2.1. The common statistical prediction model studies in Jordan

Author	Year	Number of factors	Sample size	Statistical techniques	Accuracy of the model
Gharaibeh and Yacoub	1987	30	20	Discriminant analysis	100%
Alawi & Gharaibeh	2008	24	46	A Multidimensional Scaling Approach	100%
Badawi	2004	An Empirical Study		Altman z-score	92.3%
Alomari	2000	25	24	Discriminant analysis	100%
Jahmani & Dawood	2004	23	40	A Multidimensional Scaling Approach	75%
Khalid Alkhatib	2011	An Empirical Study	32	according to Altman and Kida models	93.8
Abu Orabi	2014	An Empirical Study	10	according to Altman and Sherrod	77%

* Prepared by author

successful. Altman Z-Score (1968) reached in his model accuracy up to 95% and the model built by Altman et al. (1977) reached accuracy to 92%. Koh & Tan’s (1998) study that used neural networks reached accuracy to 98%, and it shows that the accuracy of bankruptcy models cannot be disregarded.

To the best of our knowledge, two studies (Back et al., 1996 and Jardin, 2012) have compared a pair of sets of variables optimized with many statistical techniques: discriminant analysis, logistic regression and neural network, but

As seen in Table 2.1, all studies used discriminant analysis or a multidimensional scaling approachability of each model without taking into consideration the size of the sample or the financial ratios involved in building formula models.

A number of studies that have been done in Jordan to test statistical prediction models are limited when compared with other countries such as the U.S.A, the U.K, and Australia.

2.2 QUESTIONS AND RESEARCH HYPOTHESES

This study is trying to answer three questions:

- Regarding to group one and group two models, which models have the highest accuracy?
- Does the accuracy increase or decrease when increasing the number of sample size?
- Does the accuracy increase or decrease when using different financial ratios (factors)?

The following hypotheses attempt to answer the following two research questions:

Hypothesis 1: There is a difference among three samples of different size when using different financial ratios (factors) in predicting bankruptcy.

Hypothesis 2: Group two model acts more accurately in bankruptcy prediction than group one.

3 SAMPLES AND METHODS

3.1 SAMPLES AND VARIABLES

First, we selected companies in the industrial sector because in Jordan this sector traditionally accounts for the largest percentage of failed firms. Table 3.1. and Figure 1 show that industrial companies have the largest percentage of bankruptcy or failed firms with a rate of 70.37%.

Table 3.1. Failure companies distributed by related sectors

Sector	Number of companies		Distressed companies percentage
	Distressed (bankruptcy)	Merged	
Industrial	19	10	70.37%
Financial and Banks	1	1	3.70%
Services	5	12	18.52%
Insurance	2	-	7.41%
Total	27	23	100%

After the selection of companies, we selected firms with available financial statements and asset structure as homogeneous as possible in order to control for the size effect (Gupta, 1969) and to allow comparisons of ratios. Bankrupt companies for which accounting data were available were also selected; the sample

comprised 7 failed companies and 7 successful companies during the period 2000-2013. We then selected accounting data and computed financial ratios.

To achieve the objectives of the research, discriminant analysis is used related to two groups of financial ratios. The first group includes 13 financial ratios and these ratios are from the disclosure requirements of the companies listed in the Amman Stock Exchange (ASE), while the second group includes ten most popular financial ratios found to be useful in earlier studies and expected to predict financial distress (Jodi, Don and Michael, 2007, p.42).

The ratio of Net Income to Total Assets (Return on Assets) is the most common ratios used in studies, and it was included in 54 studies (Jodi, Don and Michael, 2007, p.42). The second most common ratio is the ratio of Current Assets to Current Liabilities (Current Ratio), found in 51 studies (Jodi, Don and Michael, 2007). Six studies (Coats and Fant, 1992; Guan, 1993; Nour, 1994; Wilson and Sharda, 1994; Serrano-Cinca, 1996; Lee, 2001) used the five variables included in Altman's (1968) original multivariate model. The average has remained fairly constant, around eight to ten factors (Jodi, Don and Michael, 2007).

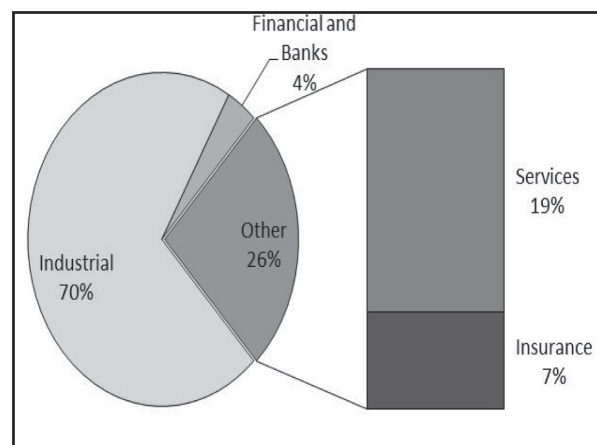

Figure 3.1. Distribution of failure companies

Table 3.2. shows the details of the two groups and the financial ratios in each group.

Table 3.2. Two groups and the financial ratios in each group

Group 1		Group 2	
Variable code	Financial ratios	Variable Code	Financial ratios
X1	Gross Margin	X1	Current Ratio
X2	Margin Before Interest and Tax	X2	Return on Assets
X3	Profit Margin	X3	Cash/Total Assets
X4	Return on Assets	X4	Debit Ratio
X5	Return on Equity	X5	Cash Flows from Operating Activities/Total Liabilities
X6	Debit Ratio	X6	Current Assets to Total Assets Ratio
X7	Equity Ratio	X7	Long -term Debt/Total Assets
X8	Interest Coverage Ratio	X8	Net Income before Tax and Interest
X9	Total Assets Turnover	X9	Sales /Total Assets
X10	Fixed Assets Turnover	X10	Working Capital /Total Assets
X11	Working Capital Turnover		
X12	Current Ratio		
X13	Working Capital		

The financial ratios included in group 1 are grouped into four categories: Profitability, Activity ratios, Liquidity ratios and Debt ratios.

Tables 1 and 2 in the appendix show Normality test and z-value for bankruptcy and non-bankruptcy related to group 1 and group 2 variables in Table 3¹. As a consequence, we must divide the measure (statistic) by its standard error (Std. Error). This will give us the z-value, which should be somewhere between -1.96 and +1.96.

In conclusion, regarding skewness and kurtosis in appendix Tables 1 and 2: our data are a little skewed and kurtotic for most financial ratios related to both groups (bankruptcy and non-bankruptcy), but they do not differ significantly from normality. We can assume that our data are approximately normally distributed, in term of skewness and kurtosis. The normality test shows that most financial ratios are approximately normally distributed at 5% significance level.

4. MODELING AND VARIABLE SELECTION METHODS

4.1 MODELING METHODS

We chose the discriminant analysis to classify groups (bankruptcy and non-bankruptcy) on the basis of a set of variables. The discriminant function analysis, also known as: discriminant analysis (DA), is used to classify cases into the

¹ Normality test and z-value for bankruptcy and non-bankruptcy related to group 1 and group 2 variables in the appendix.

values of a categorical dependent, usually used when the dependent has two categories, consequently the classification table of correct and incorrect estimates will yield a high percentage correct. Discriminant analysis (DA) is found in SPSS under Analyze, Classify, Discriminant dialog box.

4.2 SAMPLE SIZE

Once the financial ratios (group 1 and group 2) are calculated and then entered into the SPSS program, we can build several models for each group with a different sample size that include 6, 10 and 14 companies. A half of each samples are bankrupt companies, which is shown in Figure 4.2. below.

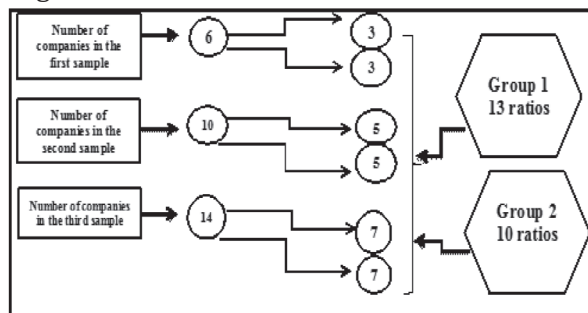

Figure 4.2. Samples size

4.3 DISCRIMINANT ANALYSIS (DA)

The main goal of discriminant analysis is to classify objects in two or several groups (in our case bankruptcy and non-bankruptcy) by a set of variables. The equation formula is:

$$DA = W_1 X_1 + W_2 X_2 + W_3 X_3 \dots W_i X_i + A$$

Where **DA** =discriminate function or score

W =the discriminant coefficient or weight for that variable

X =the independent variables (e.g., financial ratios)

A =a constant

i =the number of predictor variables

Each company receives a single composite discriminant score which is then compared to a cutoff value, which determines the group the company belongs to.

Discriminant analysis is a robust, parametric statistical technique that relies on several assumptions being met: the explanatory variables within each group must follow a multi variate normal distribution, the variance-covariance matrices of the groups must be equal and the correlation of the explanatory variables must be as low as possible. But these assumptions are sometimes difficult to meet.

Moreover, the assumption of linearity between function output and the input variables does not always apply and the groups being considered are often non-linearly separable.

5 RESULTS

Tables 4.3., 4.4., 4.5. show that all groups of financial ratios have a predictive accuracy of 100% when the sample was 6 companies and the general model that has 13 financial ratios (group 1 ratios) also showed the predictive ability of 100%. But when the sample size increased to 10 companies, the productivity accuracy decreased except for Probability ratios model (Table 4.5.) and all ratios – General Model (Table 4.5.) with stable productivity accuracy. The amazing result was observed when the sample increased to 14 companies. The accuracy declined on all models except for the model that used most popular financial ratios found to be useful in earlier studies with stable productivity accuracy rate (Norlida Abdul Manab et al, 2015, p.302).

On the other hand, figures 3, 4, 5, 6 and 7 show a significant decrease in prediction accuracy with increasing sample size.

Table 4.3. Classification results for the first sample size (6 companies)

One Year Prior to Bankruptcy	Group	Predicted Group Membership			Accuracy Rate	Type I error	Type II error
		Bankrupt	Solvent	Total			
Probability ratios model	Bankrupt	3	0	3	100%	0	0
	Solvent	0	3	3			
Activity ratios model	Bankrupt	3	0	3	100%	0	0
	Solvent	0	3	3			
Liquidity ratios model	Bankrupt	3	0	3	100%	0	0
	Solvent	0	3	3			
Debt ratios model	Bankrupt	3	0	3	100%	0	0
	Solvent	0	3	3			
All ratios – General Model	Bankrupt	3	0	3	100%	0	0
	Solvent	0	3	3			
Model that used most popular financial ratios found to be useful in earlier studies (Group 2 ratios)	Bankrupt	3	0	3	100%	0	0
	Solvent	0	3	3			

As indicated in Table 4.3., all models have the same accuracy rate, the models produced 100% accuracy rate for classifying solvent and bankrupt firms.

As depicted in Table 4.4., the results are unsettled. The probability ratios model, activity ratios model, liquidity ratios model, general model and model that used most popular financial

Table 4.4. Classification results for the second sample size (10 companies)

One Year Prior to Bankruptcy	Group	Predicted Group Membership			Accuracy Rate	Type I error	Type II error
		Bankrupt	Solvent	Total			
Probability ratios model	Bankrupt	5	0	5	100%	0%	0%
	Solvent	0	5	5			
Activity ratios model	Bankrupt	5	0	5	90%	0%	10%
	Solvent	1	4	5			
Liquidity ratios model	Bankrupt	5	0	5	90%	0%	10%
	Solvent	1	4	5			
Debt ratios model	Bankrupt	4	1	5	90%	10%	0%
	Solvent	0	5	5			
All ratios– General Model	Bankrupt	5	0	5	100%	0%	0%
	Solvent	0	5	5			
Model that used most popular financial ratios found to be useful in earlier studies (Group 2 ratios)	Bankrupt	5	0	5	100%	0%	0%
	Solvent	0	5	5			

ratios found to be useful in previous studies accurately predict 100% of bankrupt firms for one year before bankruptcy, with an accuracy of 100% using the prediction group data. The same models produced 100% accuracy rate for classifying solvent firms except for Activity ratios model and Liquidity ratios model that have type II error of 10%. However, the activity ratios model, liquidity ratios model and debt ratios model accuracy rate dropped to 90%.

els presented in table 7 and 3 models in table 10) are presented, built in this study under two groups of financial ratios (group 1 and group 2 as in Table 4.3.). The first group includes 13 ratios issued in the financial statements and related to companies in the samples (Table 4.3.), and the second group includes original variables obtained by selecting those variables that in have proved to be good predictors of bankruptcy previous central studies.

Table 4.5. Classification results for the third sample size (14 companies)

One Year Prior to Bankruptcy	Group	Predicted Group Membership			Accuracy Rate	Type I error	Type II error
		Bankrupt	Solvent	Total			
Probability ratios model	Bankrupt	5	2	7	71.428%	14.286%	14.286%
	Solvent	2	5	7			
Activity ratios model	Bankrupt	7	0	7	85.7%	0%	14.3%
	Solvent	2	5	7			
Liquidity ratios model	Bankrupt	4	3	7	78.6%	21.4%	0%
	Solvent	0	7	7			
Debt ratios model	Bankrupt	7	0	7	85.7%	0%	14.3%
	Solvent	2	5	7			
All ratios– General Model	Bankrupt	7	0	7	92.9%	0%	7.1%
	Solvent	1	6	7			
Model that used most popular financial ratios found to be useful in earlier studies (Group 2 ratios)	Bankrupt	7	0	7	100%	0%	0%
	Solvent	0	7	7			

As stated in Table 4.5., the variables in the model that used most popular financial ratios found to be useful in previous studies (group 2 ratios in table 3) add bankruptcy prediction value to the model. The prediction accuracy rates for bankrupt firms are 100% for all the samples (6, 10 and 14 companies) and this result is consistent with the prediction accuracy rates of Gharaibeh & Abdalateef (1987) and the prediction accuracy rates of Al-Omari (2000), 100% and 100% respectively. But the probability ratios model, activity ratios model, debt ratios model, and the general model accuracy rate dropped from 90% to 71.428 with type II error of 14.286%, 14.3%, 14.3% and 7.1% respectively.

6 DISCUSSIONS AND CONCLUSION

The main purpose of the study is to test the selection of financial ratios and its impact on prediction accuracy when increasing the sample size The results of 18 different models (15 mod-

The results are presented in Tables 4.1., 4.2., and 6.1. The results show that the model that used most financial ratios in previous studies achieved the highest overall classification accuracy for all the samples.

In summary, the following conclusions can be made. First, the best accuracy of the models was obtained from the model that developed from the second group (as shown in Table 6.2.), where accuracy remained constant in all three samples. This is contrary to the models that developed from the financial ratios of the first group that dropped when increasing the sample size. Second, prediction accuracy varies among models when increasing the sample size from 6 to 14 companies for the models that developed from the financial ratios of the first group. Finally, the selection of financial ratios impacts prediction accuracy when increasing the sample size.

Table 6.1. Group 1 Discriminant Analysis Model Summary

Model Name	Sample Size	Model Variables	Accuracy Rate
Profitability Model	6	$=8.614X1-2.242X2+18.353X3-43.931X4+14.173$	100%
	10	$=-1.673X1+1.276X2-0.233X3+6.33X4-0.095X5+1.115$	100%
	14	$=7.41X1-3.147X2-3.118X3+9.707X4+0.044X5-3.306$	71.4%
Debt Model	6	$=1.048X6-0.001X8-0.857$	100%
	10	$=1.21X6-0.002X8-0.527$	90%
	14	$=1.202X6-0.002X8-0.729$	92.9%
Activity Model	6	$=14.859X9+3.725X10+0.003X11-9.049$	100%
	10	$=2.474X9+1.44X10+0.001X11-1.737$	90%
	14	$0.88X9+2.215X10+0.0001X11-1.955=$	85.7%
Liquidity Model	6	$=0.1X12+0.0001X13+0.103$	100%
	10	$=-0.046X12+0.0001X13+0.308$	90%
	14	$=0.297X12+0.0001X13-0.667$	78.6%
General Model	6	$=8.614X1-2.242X2+18.353X3-43.931X4+14.173$	100%
	10	$=0.397X1+2.387X2+8.589X3-86.933X4 +1.278X5$ $+1.254X6+0.025X8+8.627X9-12.286X10 +0.001X11$ $+1.366$	100%
	14	$=24.115X1-4.737X2-7.291X3+32.72X4-0.123X5$ $+5.772X6-0.002X8+0.0001X13 -11.379$	92.9%

Table 6.2. Group 2 Discriminant Analysis Model Summary

Model Name	Sample Size	Model Variables	Accuracy Rate
Model that used most popular financial ratios found to be useful in earlier studies	6	$= 0.448X1-1.952X2-33.6X3+2.451X4+2.232$	100%
	10	$= 5.348X1+19.402X2-89.405X3+18.416X4-18.990X5 +$ $63.539X6-118.034X7+37.370X8-6.008$	100%
	14	$=0.249X1+3.917X2-8.897X3 +9.937X4-7.458X5-8.584X6$ $+0.774X7+7.616X8-5.954X9+1.947X10+4.288$	100%

7 RECOMMENDATIONS

Ten most popular financial ratios found to be useful in earlier studies should be in the forefront of professional attention so to be used as successfully as possible in bankruptcy prediction of Jordanian companies. Another recommendation for the researchers is to do similar studies using different models, such as neural networks (NN) and regression analysis (RA). Increasing the sample size and doing a similar study in other countries is another recommendation. We can recommend studying the possibility of using models from the auditors in their work to assess the company as a continuous company.

8 RESEARCH LIMITATIONS

The study was not free of limitations. There were two limitations; the first limitation is related to the small sample size because the number of bankrupt companies in Jordan is not as large as in the United States, U.K and other countries.

In addition to the sample size, some bankrupt company's financial data were not available. Another limitation of the models in this study is the period of one year prior to bankruptcy and company managers believe that this period is certainly not enough time to recover.

9 ACKNOWLEDGEMENTS

The author would like to extend its thanks and deep gratitude to Philadelphia University for help with the follow-up. The author also acknowledges the role of the Ministry of Trade and Industry for providing the study with the needed information. The research author gratefully acknowledges the Editor and the team of the Journal.

REFERENCES

1. Alawi, Samar and Gharaibeh, Fawzi. (2008). Predicting Corporate Distress in Jordan: A Multidimensional Scaling Approach, Dirasat: Administrative Sciences, Vol 35, No 2.
2. Alkhatib, Khalid and Al Bzour, Ahmad Eqab.

- (2011). Predicting Corporate Bankruptcy of Jordanian Listed Companies: Using Altman and Kida Models, *International Journal of Business and Management*, Vol. 6, No. 3.
3. Alomari, Ahmad. (2000). Using financial ratios to predict in the field of hotel industry in Jordan, Unpublished MA Thesis, Al-albayt University, Irbid, Jordan.
 4. Altman, E. I. (1968). Financial Ratios, Discriminant Analysis and the Prediction of Corporate Bankruptcy, *Journal of Finance*, 23(4): pp. 589-609.
 5. Altman, E., Haldeman, R., & Narayanan, P. (1977). Zeta analysis: A new model to identify bankruptcy risk of corporations. *Journal of Banking and Finance*, 6, pp. 29-54.
 6. Back, B., Laitinen, T., Sere, K. and Van Wezel, M. (1996), "Choosing Bankruptcy Predictors Using Discriminant Analysis, Logit Analysis, and Genetic Algorithms", Turk Center for Computer Science, Technical Report No.40.
 7. Badawi, M. (2004), External auditor report versus Altman's (z-score) and the predication of business in Jordan, Unpublished MA Thesis, Al-Yarmouk University, Irbid, Jordan.
 8. Beaver, W. (1967). Financial ratios as predictors of failure. *Journal of Accounting Research*, 4, pp. 71-111.
 9. Deakin, E. (1972). A discriminant analysis of predictors of business failure. *Journal of Accounting Research*, 10, pp.167-179.
 10. Du Jardin, P. (2012). The influence of variable selection methods on the accuracy of bankruptcy prediction models. *The Munich Personal RePEc Archive (MPRA)*, No. 116, pp. 20-39.
 11. Gharaibeh, F. & Yacoub, R. (1987), "Use of the Financial Rates in Predicting the Joint Stock Industrial Companies in Jordan". *Dirasat: Administrative Sciences*, Vol. 14, No. 8 pp.33-66, University of Jordan, Amman, Jordan.
 12. Gupta, M. C. 1969. The effect of size, growth, and industry on the financial structure of manufacturing companies. *Journal of Finance* 24(3): 517-529.
 13. Jahmani, O., & Dawood, A. (2004). Predicting the failure of Jordanian industrial publicly held firms using A multidimensional scaling approach. *Dirasat: Administrative Sciences*, 31(2), pp. 209-232.
 14. Jodi L. Bellovary, Don E. Giacomino and Michael D. Akers, A Review of Bankruptcy Prediction Studies:1930-Present. *Journal of Financial Education*, Vol. 33 (Winter 2007): pp.1-42.
 15. Kida, C.Y. (1998). Financial Ratios as Predictors of Bankruptcy in Japan: An Empirical Research. *Journal of Finance*, 123, pp. 589-609.
 16. Koh, H. C. and S. S. Tan (1999). "A neural network approach to the prediction of going concern status." *Accounting and Business Research* 29(3): pp.211-216.
 17. Norlida Abdul Manaba, Ng Yen Theng, Rohani Md-Rus, The Determinants of Credit Risk in Malaysia, *Procedia. Social and Behavioral Sciences* 172 (2015) pp.301 - 308.
 18. Ohlson, J., A. Financial Ratios and the Probabilistic Prediction of Bankruptcy. *Journal of Accounting Research*, Vol. 18, No. 1. (Spring, 1980).
 19. Orabi, Marwan Mohammad Abu. (2014). Empirical Tests on Financial Failure Prediction Models Interdisciplinary. *Journal of Contemporary Research in Business*, Vol. 5 Nbr. 9.
 20. Zmijewski, M. E. (1984). Methodological issues related to the estimation of financial distress prediction models. *Journal of Accounting Research*, 22, pp.59-82.

APPENDIX

Table A1. Normality test and z-value for group 1 variables

Descriptives						
Variables	Groups	Description	Statistic	Std. Error	Skewness z-value	Skewness (Yes or No)
x1	1	Mean	0.107	0.217		
		Skewness	-0.626	0.794	-0.788	Yes
		Kurtosis	0.028	1.587	0.018	Yes
	2	Mean	0.242	0.060		
		Skewness	-0.161	0.913	-0.176	Yes
		Kurtosis	-1.962	2.000	-0.981	Yes
x2	1	Mean	-0.676	0.334		
		Skewness	-1.502	0.794	-1.892	Yes
		Kurtosis	3.081	1.587	1.941	Yes
	2	Mean	0.064	0.181		
		Skewness	0.631	0.913	0.691	Yes
		Kurtosis	0.459	2.000	0.230	Yes
x3	1	Mean	-1.069	0.719		
		Skewness	-0.522	0.794	-0.657	Yes
		Kurtosis	-0.531	1.587	-0.335	Yes
	2	Mean	0.036	0.180		
		Skewness	0.674	0.913	0.738	Yes
		Kurtosis	0.395	2.000	0.198	Yes
x4	1	Mean	-0.222	0.134		
		Skewness	-1.868	0.794	-2.353	No
		Kurtosis	3.720	1.587	2.344	No
	2	Mean	-0.002	0.054		
		Skewness	0.470	0.913	0.515	Yes
		Kurtosis	-2.837	2.000	-1.419	Yes
x5	1	Mean	-4.248	5.058		
		Skewness	-2.550	0.794	-3.212	No
		Kurtosis	6.656	1.587	4.194	No
	2	Mean	-0.008	0.064		
		Skewness	0.487	0.913	0.533	Yes
		Kurtosis	-2.763	2.000	-1.382	Yes
x6	1	Mean	0.933	0.390		

		Skewness	1.938	0.794	2.441	No
		Kurtosis	4.322	1.587	2.723	No
	2	Mean	0.166	0.039		
		Skewness	0.473	0.913	0.518	Yes
		Kurtosis	-3.177	2.000	-1.589	Yes
x7	1	Mean	0.066	0.390		
		Skewness	-1.937	0.794	-2.440	No
		Kurtosis	4.321	1.587	2.723	No
	2	Mean	0.834	0.039		
		Skewness	-0.473	0.913	-0.518	Yes
		Kurtosis	-3.177	2.000	-1.589	Yes
x8	1	Mean	-1.296	0.329		
		Skewness	-0.027	0.794	-0.034	Yes
		Kurtosis	-0.645	1.587	-0.406	Yes
	2	Mean	140.322	134.633		
		Skewness	2.186	0.913	2.394	No
		Kurtosis	4.812	2.000	2.406	No
x9	1	Mean	0.154	0.038		
		Skewness	-0.081	0.794	-0.102	Yes
		Kurtosis	-2.005	1.587	-1.263	Yes
	2	Mean	0.563	0.168		
		Skewness	1.215	0.913	1.331	Yes
		Kurtosis	1.533	2.000	0.767	Yes
x10	1	Mean	0.258	0.067		
		Skewness	0.166	0.794	0.209	Yes
		Kurtosis	-1.737	1.587	-1.095	Yes
	2	Mean	1.263	0.247		
		Skewness	-1.489	0.913	-1.631	Yes
		Kurtosis	2.253	2.000	1.127	Yes
x11	1	Mean	-0.928	1.285		
		Skewness	-2.359	0.794	-2.971	No
		Kurtosis	6.031	1.587	3.800	No
	2	Mean	-523.465	524.474		
		Skewness	-2.236	0.913	-2.449	No
		Kurtosis	5.000	2.000	2.500	No
x12	1	Mean	5.478	4.676		

		Skewness	2.627	0.794	3.309	No
		Kurtosis	6.925	1.587	4.364	No
		Mean	4.445	1.457		
	2	Skewness	0.470	0.913	0.515	Yes
		Kurtosis	-2.463	2.000	-1.232	Yes
x13	1	Mean	-1425346.570	1023174.244		
		Skewness	-1.837	0.794	-2.314	No
		Kurtosis	3.402	1.587	2.144	No
	2	Mean	1289906.400	838703.420		
		Skewness	2.089	0.913	2.288	No
		Kurtosis	4.510	2.000	2.255	No

Table A2. Normality test and z-value for group 2 variables

Descriptives						
Variables	Groups	Description	Statistic	Std. Error	Skewness z-value	Skewness (Yes or No)
x1	1	Mean	5.478	4.676		
		Skewness	2.627	0.794	3.309	No
		Kurtosis	6.925	1.587	4.364	No
	2	Mean	5.038	1.117		
		Skewness	-0.128	0.794	-0.161	Yes
		Kurtosis	-1.952	1.587	-1.230	Yes
x2	1	Mean	-0.222	0.134		
		Skewness	-1.868	0.794	-2.353	No
		Kurtosis	3.720	1.587	2.344	No
	2	Mean	0.001	0.037		
		Skewness	0.366	0.794	0.461	Yes
		Kurtosis	-1.179	1.587	-0.743	Yes
x3	1	Mean	0.097	0.074		
		Skewness	2.449	0.794	3.084	No
		Kurtosis	6.101	1.587	3.844	No
	2	Mean	0.127	0.058		
		Skewness	1.677	0.794	2.112	No
		Kurtosis	2.878	1.587	1.813	Yes
x4	1	Mean	0.933	0.390		
		Skewness	1.938	0.794	2.441	No
		Kurtosis	4.322	1.587	2.723	No
	2	Mean	0.139	0.033		
		Skewness	0.710	0.794	0.894	Yes
		Kurtosis	-0.919	1.587	-0.579	Yes

x5	1	Mean	0.007	0.088		
		Skewness	1.805	0.794	2.273	No
		Kurtosis	3.877	1.587	2.443	No
	2	Mean	0.625	0.202		
		Skewness	0.447	0.794	0.563	Yes
		Kurtosis	-1.617	1.587	-1.019	Yes
x6	1	Mean	0.346	0.070		
		Skewness	0.230	0.794	0.290	Yes
		Kurtosis	-0.939	1.587	-0.592	Yes
	2	Mean	0.317	0.090		
		Skewness	0.744	0.794	0.937	Yes
		Kurtosis	-1.116	1.587	-0.703	Yes
x7	1	Mean	0.090	0.051		
		Skewness	1.288	0.794	1.622	Yes
		Kurtosis	0.102	1.587	0.064	Yes
	2	Mean	0.060	0.039		
		Skewness	1.271	0.794	1.601	Yes
		Kurtosis	-0.580	1.587	-0.365	Yes
x8	1	Mean	-0.676	0.334		
		Skewness	-1.502	0.794	-1.892	Yes
		Kurtosis	3.081	1.587	1.941	Yes
	2	Mean	0.057	0.125		
		Skewness	0.744	0.794	0.937	Yes
		Kurtosis	1.807	1.587	1.139	Yes
x9	1	Mean	0.154	0.038		
		Skewness	-0.081	0.794	-0.102	Yes
		Kurtosis	-2.005	1.587	-1.263	Yes
	2	Mean	0.476	0.130		
		Skewness	1.596	0.794	2.010	No
		Kurtosis	2.625	1.587	1.654	Yes
x10	1	Mean	-0.497	0.387		
		Skewness	-1.370	0.794	-1.725	Yes
		Kurtosis	1.838	1.587	1.158	Yes
	2	Mean	0.367	0.098		
		Skewness	-0.190	0.794	-0.239	Yes
		Kurtosis	-1.713	1.587	-1.079	Yes

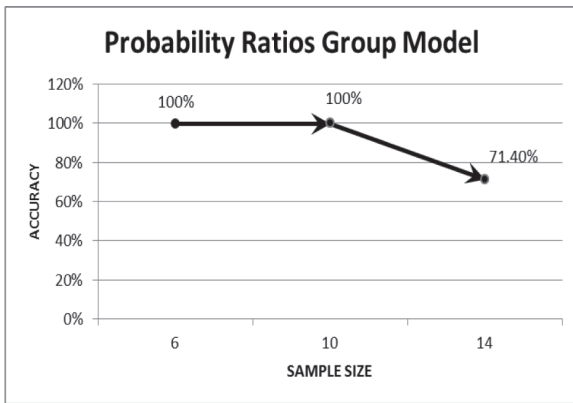

Figure 3

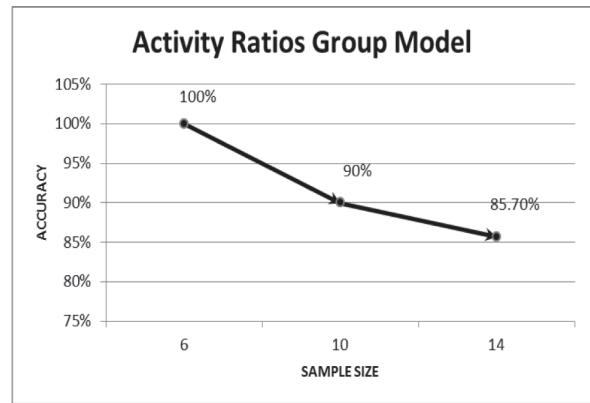

Figure 4

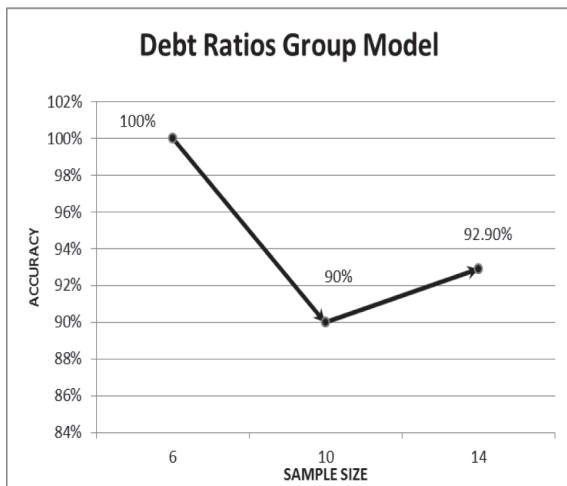

Figure 5

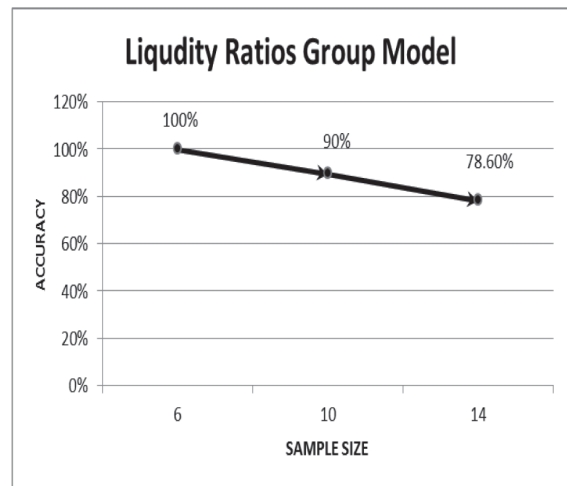

Figure 6

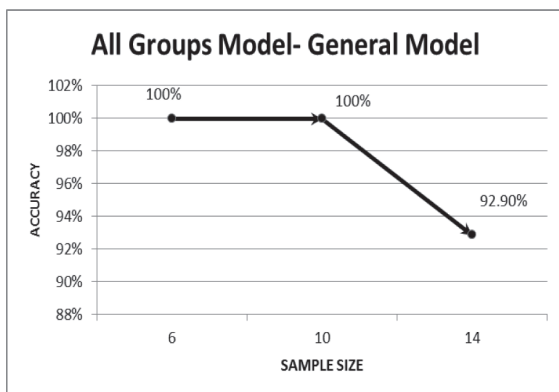

Figure 7

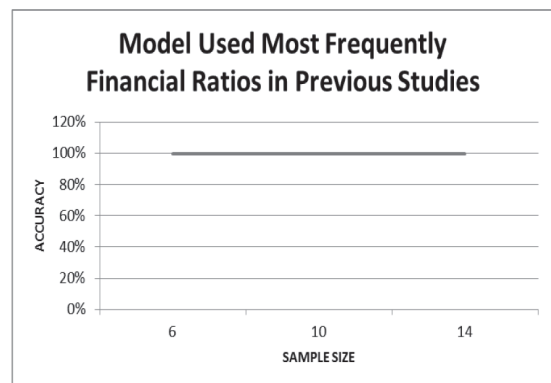

Figure 8