

Ferlito, Carmelo

Conference Paper — Published Version

The Malaysian Property Boom and Bust Cycle: History Repeating?

Suggested Citation: Ferlito, Carmelo (2018) : The Malaysian Property Boom and Bust Cycle: History Repeating?, World Economics Association (WEA) Conferences, No. 2 2018, The 2008 Economic Crisis Ten Years On, 15th October to 30th November, 2018, World Economics Association, Bristol,
<https://the2008crisistenyerson.weaconferences.net/papers/the-malaysian-property-boom-and-bust-cycle-history-repeating/>

This Version is available at:

<https://hdl.handle.net/10419/190772>

Standard-Nutzungsbedingungen:

Die Dokumente auf EconStor dürfen zu eigenen wissenschaftlichen Zwecken und zum Privatgebrauch gespeichert und kopiert werden.

Sie dürfen die Dokumente nicht für öffentliche oder kommerzielle Zwecke vervielfältigen, öffentlich ausstellen, öffentlich zugänglich machen, vertreiben oder anderweitig nutzen.

Sofern die Verfasser die Dokumente unter Open-Content-Lizenzen (insbesondere CC-Lizenzen) zur Verfügung gestellt haben sollten, gelten abweichend von diesen Nutzungsbedingungen die in der dort genannten Lizenz gewährten Nutzungsrechte.

Terms of use:

Documents in EconStor may be saved and copied for your personal and scholarly purposes.

You are not to copy documents for public or commercial purposes, to exhibit the documents publicly, to make them publicly available on the internet, or to distribute or otherwise use the documents in public.

If the documents have been made available under an Open Content Licence (especially Creative Commons Licences), you may exercise further usage rights as specified in the indicated licence.

2018, WEA On Line Conference

The 2008 Economic Crisis Ten Years On

in Retrospect, Context and Prospect

Discussion Forum: from October 15th to November 30th, 2018

The Malaysian Property Boom and Bust Cycle: History Repeating?¹

Carmelo Ferlito

Abstract

According to Mark Thornton, we could be very close to another major economic crisis. Ten years have passed from the so-called Great Recession and Thornton's prediction confirms my view according to which business fluctuations are pervasive, and the crisis that emerged in the Western world in 2007 is just the latest and most evident manifestation of such dynamics. I have expressed the idea that business cycles are unavoidable by developing the doctrine of the *natural cycle*. In the present paper I used that framework in order to describe the evolution of the Malaysian property market in the last decade in the context of the general development of the national economy. In fact, it seems that this evolution presents many features of the cyclical dynamic that brought about the Great Recession after a ten year delay.

Institute for Democracy and Economic Affairs (IDEAS), Kuala Lumpur, Malaysia

and

INTI International College Subang, Subang Jaya, Malaysia

carmelo@uow.edu.au

¹ The present paper is an extended and revised version of Ferlito (2018); while there I focused more on the issue of affordable housing, here I mostly analysed the cyclical dynamics involving the Malaysian property market in the last decade. I would like to thank IDEAS (www.ideas.org.my), and Ali Salman in particular, for having asked me to work on the topic, and Adli Amirullah for the research support.

1. Introduction: business cycles cannot be avoided

According to Thornton (2018), we could be very close to another major economic crisis. Ten years have passed from the so-called Great Recession and Thornton's prediction confirms my view according to which business fluctuations are pervasive, and the crisis that emerged in the Western world in 2007 is just the latest and most evident manifestation of such dynamics. As mentioned in Ferlito (2016a, pp. 202-203), which develops the view brought out in Ferlito (2014a), capitalism without fluctuations does not exist. We are in good company in believing that cyclical waves are the reality of economic development in a capitalistic system. Marx was the first to realize this.

This same awareness is seen in Schumpeter's view (1939), which was influenced by Spiethoff (1925, p. 112), who concluded that "the cyclical upswings and downswings are the evolutionary forms of the highly developed capitalist economy and their antithetic stimuli condition its progress". In turn, the Austrian economist influenced his student Paolo Sylos Labini (1954, 1984), and similar considerations can be found in Lachmann (1956, pp. 110-112). The realization that capitalist development is typically cyclical is also echoed in the words of another Italian economist Marco Fanno (1931, pp. 248-249; Nardi Spiller 2000). Cowen and Tabarrok (2015, p. 8), in their economics textbook, stressed the importance of economic fluctuations by mentioning them as one of the big ideas in economics: "Big Idea Eight: Economic Booms and Busts Cannot Be Avoided but Can Be Moderated", adding that "[b]ooms and busts are part of the normal response of the economy to changing economic conditions" (see also Nardi Spiller 2016 and Romano and Lucarelli 2017).

I have expressed the idea that business cycles are unavoidable by developing the doctrine of the *natural cycle* (see in particular Ferlito 2016b, Chapter 3). I will now summarize that framework in order to describe the evolution of the Malaysian property market in the last decade in the context of the general development of the national economy. In fact, it seems that this evolution presents many features of the cyclical dynamic that brought about the Great Recession after a ten year delay.

There is no lack of studies on the Malaysian property market. However, what seems to be the main deficit of the most recent analyses is the lack of a sound interpretative key, which is the necessary prerequisite for reading statistical findings; without such an interpretative framework we are merely blindly reading numbers. Econometrics is a branch of statistics, and statistics is simply a useful tool for properly dealing with history; but, as Huerta de Soto observed (2008, p. 72), history "is simply the systematic gathering and study of the facts of experience concerning human action. Therefore it deals with the specific content of human action in the past". Therefore, in order to practice their discipline, "the historians must first have at their disposal a body of theory which enables them to interpret reality. Moreover the historian needs a special judgment of relevance to determine which factors most heavily influenced the past events they study (*verstehen* or understanding), and this judgment of relevance makes their discipline a true art".

History, thus, is not enough, and must be accompanied by economics as a *science of meaning* (Storr 2017, Ferlito 2019). According to Ludwig von Mises (1949, p. 233), the task of economics is "to investigate the market phenomena, that is, the determination of the mutual exchange ratios of the goods and services negotiated on markets, their origin in human action and their effects upon later action". What is human action, then? Mises (1949, p. 11), explains that "[h]uman action is purposeful behaviour. Or we may say: Action is will put into operation and transformed into an agency, is aiming at ends and goals, is the ego's meaningful response to stimuli and to the conditions of its environment, is a person's conscious adjustment to the state of the universe that determines his life". But if economics is the science of human action, and if human action is purposeful behaviour, it becomes obvious

that the task of the economist is to interpret those actions and try to understand their meaning, since every action is meaningfully connected to the final end it tries to achieve.

However, even recent interesting studies such as Yip, Woo *et al.* (2017) and Yip, Choong *et al.* (2017), when looking for a bubble or a cycle in the Malaysian property market, limit their analyses to its price dynamics. Of course, by taking this approach they are limited by the cage of econometric analysis, which cannot take into account the kaleidic complexity of the real world and the necessarily qualitative nature of the processes of understanding. In doing so they miss the chance for greater enlightenment over the present scenario. This paper attempts to fill that gap. Section 2 presents the theory of the natural cycle, which will be used in section 3 for the analysis of the Malaysian property market over the past decade. In section 5 I present some policy suggestions. Section 5 concludes the paper.

2. The theoretical framework

The key elements in my analysis are profit expectations (combined with time flow), which are at the very root of any investment decision, and monetary policy. Expectations are what guide people's actions. Such action happens in time and is determined by the intensity of the time preferences in a given moment. As regards consumers, it defines the relationship between consumption and saving. In the case of investors, it measures their propensity towards the future and their desire to undertake long-term projects in the investment goods sector, which makes the production structure more roundabout and the production period longer.

In a future-oriented system consumers are more savings-oriented, thereby encouraging the accumulation of loanable funds that can be used by entrepreneurs in long-term projects. A present-oriented society, in contrast, has a greater propensity towards consumption on the consumer side, and investors do not lengthen the production process. While it might seem obvious that there could be discoordination between consumer and investor choices, we should stress the importance of market forces operating for a higher degree of coordination.

In a nutshell: expectations generate action plans that are carried out in time and eventually revised in order to cope with new information acquired via market interactions; these are then transformed into new knowledge by interpretative processes, which in turn can force expectations to change. Expectations also define the time preference of an economic system; action plans set the intertemporal structure of the production process, which, as a process, is subject to continuous revision. Such a framework brings out the idea that genuine uncertainty is a necessary element for economic action, and therefore we face an "inherent instability of all possible outcomes resulting from a course of action" (O'Driscoll and Rizzo 1985, p. 100).

At the beginning of a cyclical movement we encounter a distortion of the production structure defined by the intertemporal system of preferences (Hayek 1929, p. 123), and we need to study the reasons behind such a modification. A boom is generally initiated when entrepreneurs see unexploited profit opportunities and take advantage of them, i.e. they have positive expectations, or, otherwise, they are future-oriented and ready to make the production process more roundabout. Some are prepared to take risks on real innovations that can create a competitive advantage for them, others by merely imitating in the wave of enthusiasm that follows, and still others by launching poorly grounded economic initiatives. Such a situation encourages the onset of major investments in production assets, or capital goods, whereby the economy becomes, in general, more capital-intensive, i.e. the production period is extended (Hayek 1931, pp. 35-36). However, even if entrepreneurs become more future-oriented, such a change does not necessarily bring with it a modification of preferences

on the consumer side, and we encounter a difference between entrepreneurial decisions and consumer choices (Hayek 1933, pp. 143-148).

In this situation, as consumers are not necessarily saving more in order to finance new investment decisions, entrepreneurs need to resort to their own financial resources or, as is usually the case, to a general expansion of the capital supply from the credit system, which thus becomes crucial in supporting an emerging boom. Most investments are made in the expectation that the supply of capital will continue for some time at a level consistent with the new demand for loanable funds. In other words, entrepreneurs regard the present supply of capital and the present rate of interest as a symptom that approximately the same situation will continue to exist for some time (Hayek 1933, p. 142).

While entrepreneurs invest in new processes for the production of capital goods, savers are frustrated in their desire to consume, because what they want is not being produced. A forced saving phenomenon thereby develops; as a consequence of the fact that production resources were diverted from sectors close to consumers, there is a gradual reduction in the production of consumer goods and therefore an involuntary limitation of consumption (Hayek 1933, pp. 145-146).

The entrepreneurial impetus towards new investments, on the other hand, initially involves an increase in raw material prices and consequently of the capital goods produced with them. The impetus becomes particularly forceful when the wave of the first innovative entrepreneurs is joined by the pressure of imitators, who grasp profit opportunities only in a second stage and attempt to benefit by following the trend. On a closer look, imitative speculation waves are typical of every boom stage described in history.

At the same time, demand for labour increases and is drawn towards the new investments, with a relative increase in wages: this in turn encourages demand for consumer goods, and prices in that sector also increase. It is therefore evident that the increase in non-monetary income will not be matched by an increase in real incomes because of the inflationary effect exerted by unsatisfied demand for consumer goods.

In order to be sustained, this process requires credit expansion without respite – which would bring about a cumulative increase in prices that sooner or later would exceed every limit. The conflict becomes evident when demand for consumer goods exceeds the funds available for investment in terms of absolute value. At this point, the interest rate cannot but rise, frustrating demand for capital goods precisely when their prices have also risen. A considerable part of the new plant installed, designed to produce other capital goods, remains unused since the investments required to complete production processes cannot be made (Hayek 1933, p. 148). As a result, in an advanced stage of the boom, growth in demand for consumer goods brings down demand for capital goods (Hayek 1939, p. 31).

At the peak of the boom, the economy discovers itself unable to sustain production oriented over and above its possibilities. Demand for capital goods runs out, taking with it the over-production in the particular sector where the boom started, and it is here where problems arise. Many economic initiatives set up through excessive reliance on profit expectations, on speculation fever or on credit cannot be completed, although the debts still must be paid. Many companies are driven out of the system. Capital becomes scarce, and banks raise interest rates. A period of adjustment and return to equilibrium begins, only it has the appearance of a depression.

To summarize, this is how I identify the first two stages in my model (called the *natural-cycle* model): primary expansion, generated by a change in the structure of time preferences and expectations (the system becomes more future-oriented), and secondary expansion, characterized by imitative investments (speculation fever). If, therefore, the reality of imitative speculations cannot be eliminated, it outlines the character of the growth process by emphasizing development above the initially imagined level. Like the primary wave of

investments, the second wave is generated by profit expectations, particularly the expectation that the current situation will not change (Schumpeter 1939, p. 145). From a quantitative point of view, moreover, imitation (secondary) investments might even be greater than the first cycle of investments since they involve a larger number of individuals, whose expectations are 'over-excited' by the boom (Schumpeter 1939, p. 146). These secondary investments will need to be liquidated through an adjustment crisis.

In fact, the secondary wave of investments generates new demand for loanable funds in order to insert a more roundabout production process into an expansion cycle. This means an attempt to extend the expansion process temporarily, thereby also increasing the degree of uncertainty. Taking more time implies that more things can happen, providing the possibility of greater productivity but also of greater uncertainty. Since the value of higher order (capital) goods depends on the prospective value of the consumer goods they are expected to produce, the elapse of time, and with it the arrival of unexpected events, implies that some production plans are bound to be disappointed and thus the value of specific capital goods will be affected (Lewin 2005, p. 151).

Moreover, during the secondary wave, the positive sentiments, the positive profit expectations, that become 'red-hot' at the end of the primary expansion stage also play a role regarding banks' action. In fact, precisely because of what happens during expansion, it is highly likely that banks will make available 'virtual funds' that are not backed up by real savings, driven by expectations that the adaptation of consumer preferences (further savings) cannot but occur, precisely because of the enthusiasm generated by the boom. As explained by Minsky's financial instability hypothesis (Minsky 1982, 2008), during the boom following a tranquillity period "innovative debt practices and speculative excesses" are encouraged and an "unrecognized system fragility evolved" (Prychitko 2010, p. 206).

On the other hand, it is more than likely that the long-awaited realignment will not happen, and the likelihood that savings may increase is limited by two factors. The most obvious one is of course that consumers must also consume, hence their capacity for saving (and realignment) is objectively limited by the necessity to consume. In addition, in all likelihood, consumers will also be influenced by the general enthusiasm of the boom stage and consequently change their preferences in the opposite direction, i.e., by increasing their propensity for consumption. This is all the more true given the fact that real wages grow during the boom in order to attract workers into the new investment areas or to employ formerly unemployed workers.

So, while the first wave of investments can in most cases result in successful initiatives, due to its limited quantitative intensity and time frame, the second wave will be frustrated by a change in consumer preferences and a banking policy influenced by profit expectations. What will follow is a crisis (the third stage of the natural cycle). The deepening of the crisis and the emerging of an eventual depression (the fourth stage) will depend on the general reaction to the crisis from the public and from policymakers.

3. The Malaysian property market boom and bust cycle (2007-2018)

In Ferlito (2016a) I applied this model to the Great Recession. I will now attempt to apply the same model to the evolution of the property industry in Malaysia, with reference especially to the last decade, although, as will soon be clear, the expansion trend for the Malaysian property market had already started after the 1997-98 Asian crisis, following a path which resembles what we have seen in the Western world before the Great Recession. The attempt of the present section is to show how the industry path followed, and is still following, a natural dynamic cycle.

First, we should note the close connection between the housing market behaviour and general economic crises. In the American economy between the Great Depression and the Great Recession (1929-2008), Gjerstad and Smith (2014, pp. 268-269) found that

[m]ost of the twelve smaller recessions between the Great Depression and the Great Recession also were preceded by declines in housing investment. Housing decline is a consistently superior indicator of both the duration and the depth of recession than declines in firms' fixed investments. By our reckoning, housing has been a leading indicator and implicated as proximal cause in eleven of the past fourteen recessions, starting with the Great Depression. Even more impressive, thirteen of the past fourteen recession recoveries were accompanied by rapidly increasing expenditures on construction of new housing. The single exception is the Great Recession, from which (in 2013) the recovery has been weak, exhibiting neither a customary recovery surge in growth nor a return to previous long-term growth trends.

Hence, based on the past fourteen recessions, we conclude that if there is no recovery in housing, then there is either no recovery or, unusually, an extended period of substandard economic growth.

To accurately study the behaviour of the property market therefore means keeping an attentive eye on the possibility of wider global economic turmoil. The first thing to be done in order to check if our framework is a good one for explaining the recent evolution of the property industry in Malaysia is to compare the dynamic of business confidence (as a measure of profit expectations) with some indicators from the industry itself.

Table 1: Property transactions (volume and value) in Malaysia – 1990-2016.

Property Transactions - Total						
Year	Volume ('000)	Value (RM Bil)	Year	% Change (Volume)	% Change (Value)	
31/12/90	148.2	RM 15.16	31/12/90			
31/12/91	164	RM 17.32	31/12/91	10.66%	14.25%	
31/12/92	168.27	RM 20.27	31/12/92	2.60%	17.03%	
31/12/93	178.05	RM 22.44	31/12/93	5.81%	10.71%	
31/12/94	217.54	RM 29.70	31/12/94	22.18%	32.35%	
31/12/95	251.89	RM 39.85	31/12/95	15.79%	34.18%	
31/12/96	270.53	RM 48.99	31/12/96	7.40%	22.94%	
31/12/97	274.75	RM 53.21	31/12/97	1.56%	8.61%	
31/12/98	186.08	RM 27.90	31/12/98	-32.27%	-47.57%	
31/12/99	225.89	RM 34.42	31/12/99	21.39%	23.37%	
31/12/00	240.06	RM 41.31	31/12/00	6.27%	20.02%	
31/12/01	242.63	RM 38.63	31/12/01	1.07%	-6.49%	
31/12/02	231.39	RM 38.64	31/12/02	-4.63%	0.03%	
31/12/03	243.38	RM 43.43	31/12/03	5.18%	12.40%	
31/12/04	293.21	RM 59.96	31/12/04	20.47%	38.06%	
31/12/05	276.51	RM 56.78	31/12/05	-5.70%	-5.30%	
31/12/06	283.9	RM 61.60	31/12/06	2.67%	8.49%	
31/12/07	309.46	RM 77.14	31/12/07	9.00%	25.23%	
31/12/08	340.24	RM 88.34	31/12/08	9.95%	14.52%	
31/12/09	337.86	RM 81.00	31/12/09	-0.70%	-8.31%	
31/12/10	376.59	RM 107.44	31/12/10	11.46%	32.64%	
31/12/11	430.4	RM 137.83	31/12/11	14.29%	28.29%	
31/12/12	427.52	RM 142.84	31/12/12	-0.67%	3.63%	
31/12/13	381.13	RM 152.37	31/12/13	-10.85%	6.67%	
31/12/14	384.06	RM 162.97	31/12/14	0.77%	6.96%	
31/12/15	362.11	RM 149.90	31/12/15	-5.72%	-8.02%	
31/12/16	320.43	RM 145.41	31/12/16	-11.51%	-3.00%	

Table 2: Business Confidence Index – 1998-2016

Date	Business Confidence Index
31/3/1998	88.5
30/6/1998	79.1
30/9/1998	80
31/12/1998	80.5
31/3/1999	84
30/6/1999	101.6
30/9/1999	111.3
31/12/	117.7

1999	
31/3/2 000	120.7
30/6/2 000	121
30/9/2 000	126
31/12/ 2000	115.6
31/3/2 001	105.7
30/6/2 001	96.2
30/9/2 001	98.7
31/12/ 2001	93.8
31/3/2 002	104.4
30/6/2 002	109
30/9/2 002	108.9
31/12/ 2002	112.8
31/3/2 003	105.2
30/6/2 003	106.9
30/9/2 003	112.8
31/12/ 2003	115.5
31/3/2 004	117.5
30/6/2 004	112.4
30/9/2 004	113.9
31/12/ 2004	109.3
31/3/2 005	120.9
30/6/2 005	109.8
30/9/2 005	102.5
31/12/ 2005	116.1
31/3/2 006	90.1
30/6/2 006	104.2
30/9/2 006	107.5

31/12/ 2006	110.9
31/3/2 007	124.1
30/6/2 007	115.9
30/9/2 007	117.5
31/12/ 2007	110.7
31/3/2 008	115.4
30/6/2 008	70.6
30/9/2 008	88.9
31/12/ 2008	71.4
31/3/2 009	78.9
30/6/2 009	105.8
30/9/2 009	105.4
31/12/ 2009	109.6
31/3/2 010	124
30/6/2 010	119.6
30/9/2 010	104.9
31/12/ 2010	99.5
31/3/2 011	113.3
30/6/2 011	114
30/9/2 011	104.5
31/12/ 2011	96.6
31/3/2 012	116.5
30/6/2 012	111.5
30/9/2 012	96
31/12/ 2012	94.1
31/3/2 013	92.6
30/6/2 013	114.2
30/9/2 013	98.6

31/12/2013	92
31/3/2014	103.1
30/6/2014	113
30/9/2014	95.9
31/12/2014	86.4
31/3/2015	101
30/6/2015	95.4
30/9/2015	86.4
31/12/2015	87.1
31/3/2016	92.9
30/6/2016	106.4
30/9/2016	83.9
31/12/2016	81.2

These two dynamics are compared in the following graph.

Graph 1: Property Transaction Volume and Business Confidence Index

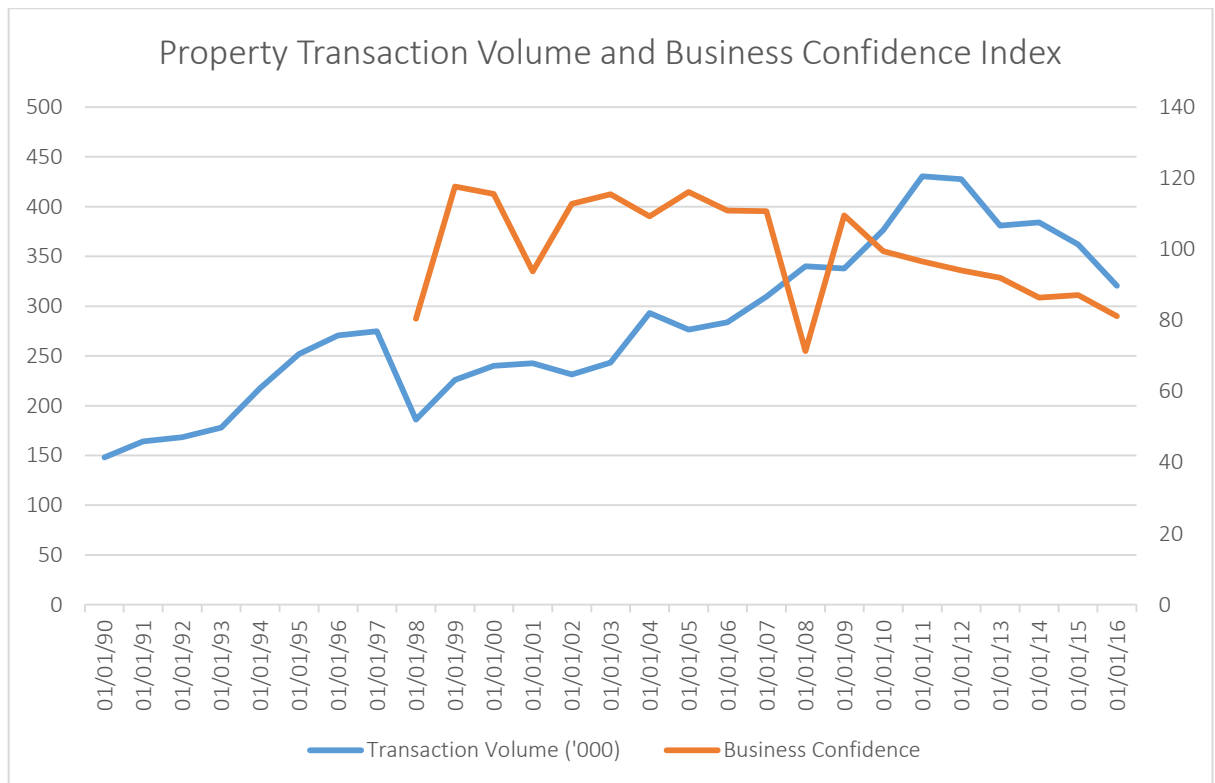

Source: elaborations on JPPH data.

The graph shows us that indeed business confidence and property transactions are related: the rising dynamic in property transactions after the Asian financial crisis (1997-1998) is linked to greater business confidence. There are two moments clearly identifiable as exceptions. We can see a sharp decline in business confidence in 2001 and 2008 that is not linked with the movements in the property market; those years should be considered special cases, as they are both linked to world level economic crises (the dotcom bubble in 2001 and the Great Recession in 2008). However, the property market also recorded a transaction decline during those years, as shown in Table 1.

Thus, as expected, rising profit expectations played a role in generating an industry boom, a boom that seems to have reached its peak between 2011 and 2012, after which the number of transactions has steadily declined. In a way, as demonstrated in Graph 1, the business confidence dynamics anticipated the inversion in the property cycle and the two lines are currently moving together. This is not the only proof that profit expectations actively moved investment into the housing market; the fact that in recent years their trends are more and more moving together demonstrates that property dynamics came to play an increasing role in shaping the general business mood, due to their increasing influence on the Malaysian economy. In fact, as reported by the Malaysian department of statistics, between 2010 and 2015 the construction sector output grew at a compound annual growth rate of 14.3%. In line with the rapid growth in gross output, the value of intermediate input also increased by RM 55.4 billion to a record RM 114.8 billion with a compound annual growth rate of 14.1%, thus resulting in an added value of RM 63.2 billion in 2015. In 2015, the civil engineering sub-sector contributed the most to gross output in the construction sector with a share of 27.0% (RM48.1 billion), as compared to 27.2% (RM 24.9 billion) in 2010. This was followed by the construction of non-residential buildings, which recorded RM 46.1 billion of gross output as compared to RM 27.0 billion in 2010. In the graph below we show the growing impact of the construction sector on the Malaysian economy.

Graph 2: Malaysian GDP from construction.



Returning to the housing market, we have observed that from 2012-2013 the number of transactions declined. Moreover, since 2015 the decline is also visible in the value of the transactions and not only in their volume. Such a decline in the volume and value of property

transactions is sharper for residential units when compared to total transactions (see Table 3). The trend is confirmed in 2017: according to preliminary data, in the first half of the year the number of residential transactions declined by 7% (JPPH, 2017, p. 6), while the global decline in transactions was 6%, with an increase in volume of 5% (JPPH, 2017, p. 4). Gjerstad and Smith (2014, p. 268) noted that in the USA both the Great Depression and the Great Recession “were preceded by three-year substantial declines in new houses expenditures”, and therefore we should look at such a slowdown in Malaysia as an indicator of a potential economic crisis risk.

Graph 3: Property Transactions in Malaysia, Volume and Value – 1990-2016

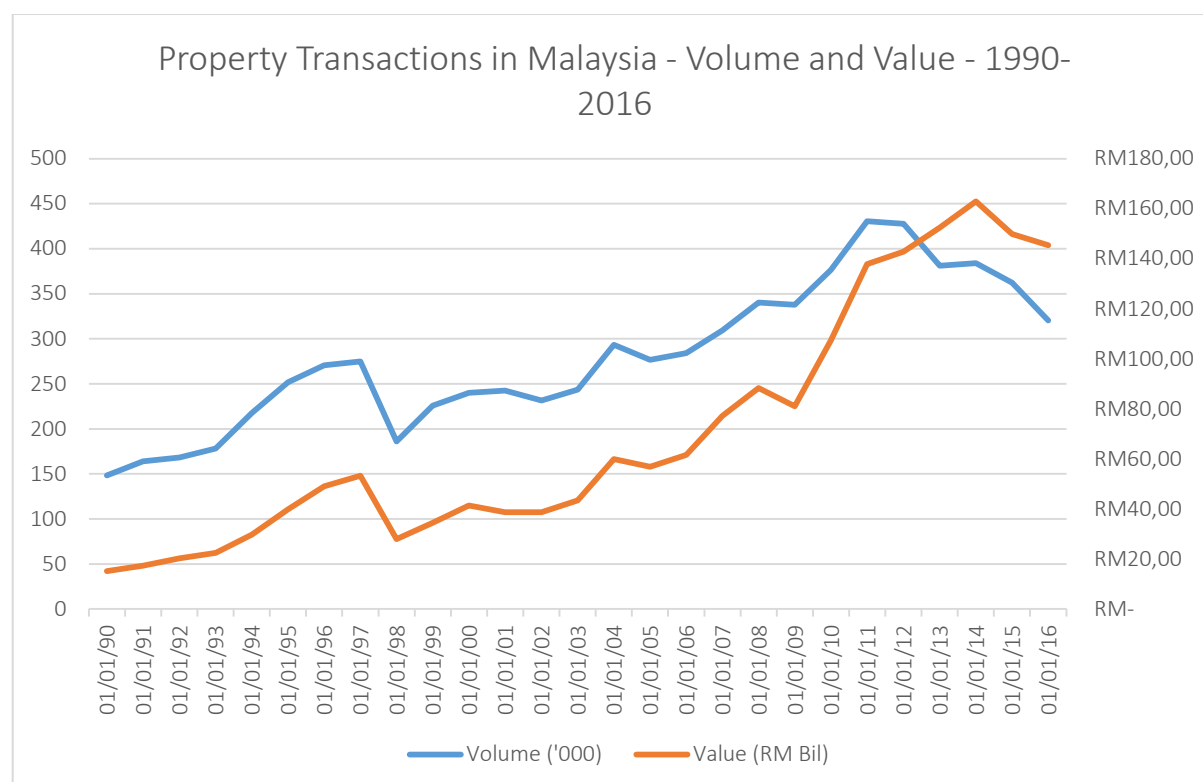

Source: Elaborations on JPPH data.

Table 3: Total and residential transactions in Malaysia, percentage of change – 2001-2016.

	Residential	Residential	Total	Total
Year	% Change (Volume)	% Change (Value)	% Change (Volume)	% Change (Value)
31/12/2001				
31/12/2002	-7.91%	-4.79%	-4.63%	0.02%
31/12/2003	1.51%	8.87%	5.18%	12.40%
31/12/2004	18.53%	27.31%	20.48%	38.05%
31/12/2005	-6.90%	-3.03%	-5.70%	-5.31%
31/12/2006	0.44%	3.66%	2.67%	8.48%

31/12/2007	9.27%	23.92%	9.00%	25.23%
31/12/2008	8.63%	13.19%	9.95%	14.52%
31/12/2009	-2.33%	1.32%	-0.63%	-8.29%
31/12/2010	7.19%	21.04%	11.39%	32.62%
31/12/2011	18.92%	22.07%	14.28%	28.28%
31/12/2012	1.07%	9.59%	-0.67%	3.64%
31/12/2013	-9.70%	6.34%	-10.85%	6.67%
31/12/2014	0.42%	13.88%	0.77%	6.96%
31/12/2015	-4.56%	-10.47%	-5.72%	-8.02%
31/12/2016	-13.94%	-10.75%	-11.51%	-3.00%

Source: Elaborations on JPPH data.

Now that we have confirmed the role on profit expectations in generating the boom in the property sector, together with the rising influence of the housing market on the global Malaysian economy and therefore its increasing role in shaping business mood, we shall analyse the price dynamics and their relationship to monetary policy.

Graph 4: Malaysian house price index – 2008-2016.



Graph 4 shows us that, as expected, the price dynamics are ‘hotter’ during the years in which the volume of transactions reached its peak between 2012 and 2014, while the recent dynamics seem to move toward stabilization. It should be noted that Graph 4 does not show that prices are decreasing: what is shown is the annual variation of the price index, therefore we can observe that since 2014 prices have continued to grow, although at a slower pace, and after 2016 the pace is constantly oscillating around 5%. The house price peak in 2013 is

confirmed by the econometric elaborations in Yip, Woo *et al.* (2017) and Yip, Choong *et al.* (2017). What we have said can be shown in Graph 5 below: prices are still growing but at a slower pace.

Graph 5: Malaysian house price index – 2002-2017.

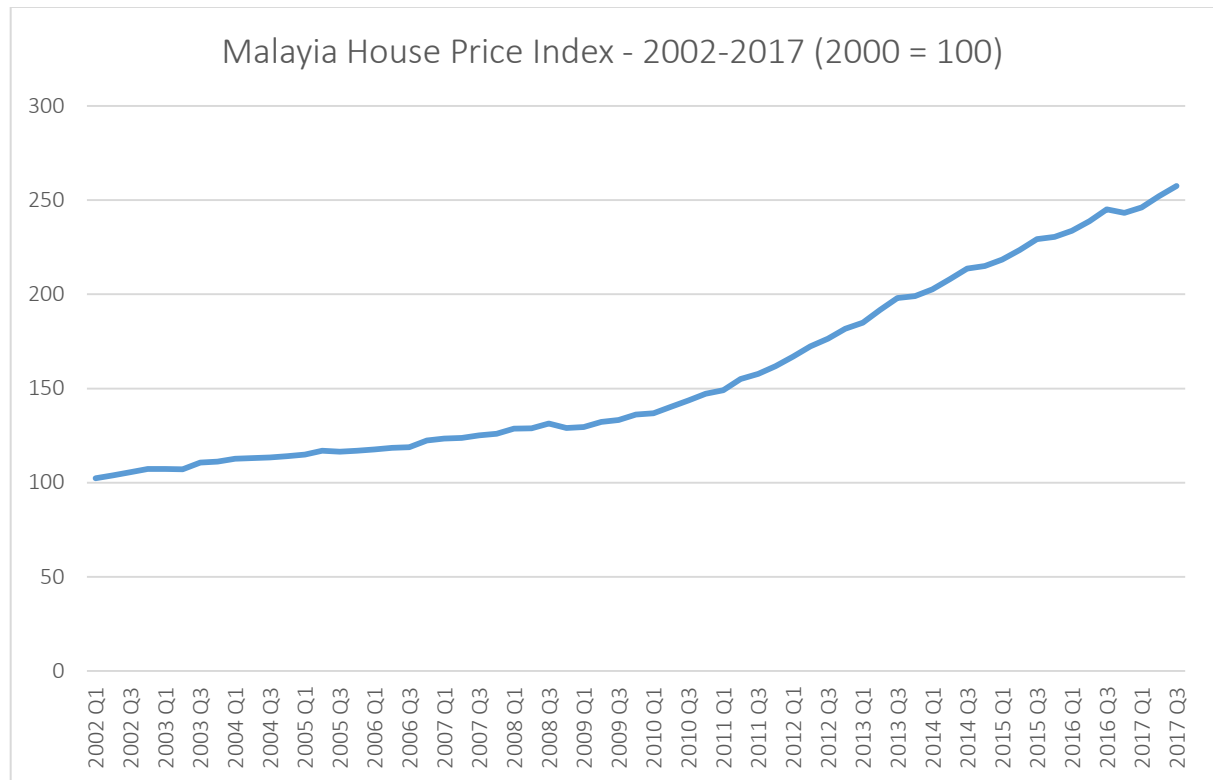

Source: Elaborations from Tradingeconomics.com.

It is normal to observe a time lag between the movements in the real sector and the monetary sector. The sharp dynamics we observe between 2008 and the end of 2013 reflect the strongest growth in property transactions that indeed, as we saw, reached its peak in 2012. The slower pace and the recent decline in property transactions is reflected in less heated price movements. Shouldn't we expect a price decline? Not immediately. In fact, although the number of unsold units has reached a decade high (130,690 residential units in the first quarter of 2017, according to Bank Negara Malaysia, 2017, p. 27, which rose to 146,497 units in the second quarter) and market operators have a constantly growing awareness that the tide is turning, the number of ongoing and planned projects is still high. Graph 6 shows us the boom dynamic as reflected in the construction output (variation index): the growth pace is particularly significant in the first years of the boom and reached its peak between 2012 and 2013; since 2013, we observe a stabilization in the price dynamics, with growth rates constantly oscillating around 10%.

Graph 6: Malaysian construction output – 2008-2018.

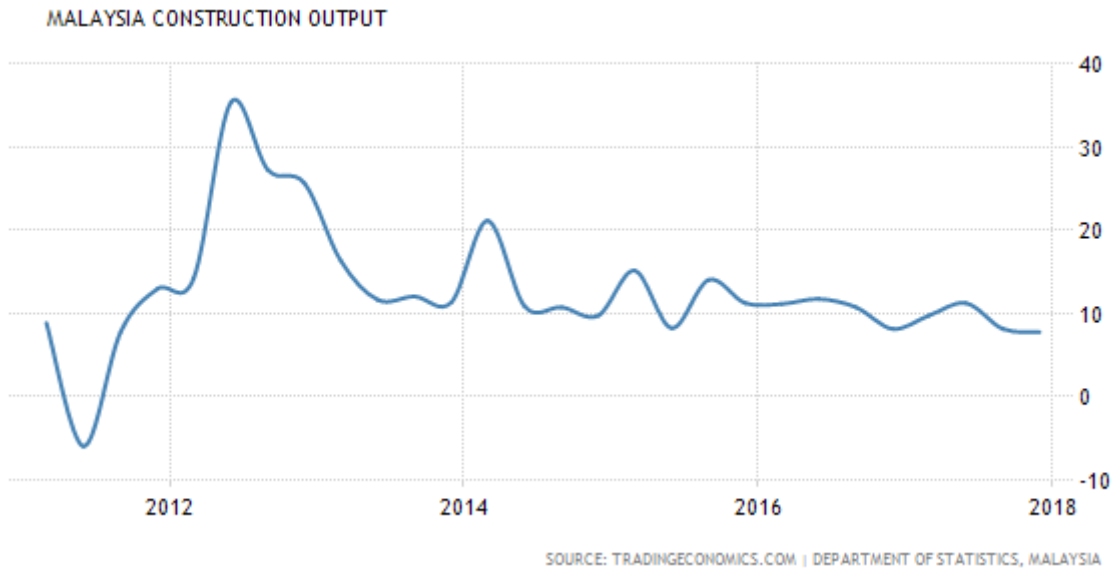

The fact that construction activity is still going on and that a decline in the volume of transactions is still accompanied by a relative increase in value (selling less but selling better) are key factors in supporting a still rising price dynamic. In fact, as observed by Yip, Choong *et al.* (2017, p. 249), statistical elaborations confirm the presence of a bubble, which has not yet collapsed.

Graph 7: ADF and RHP indexes.

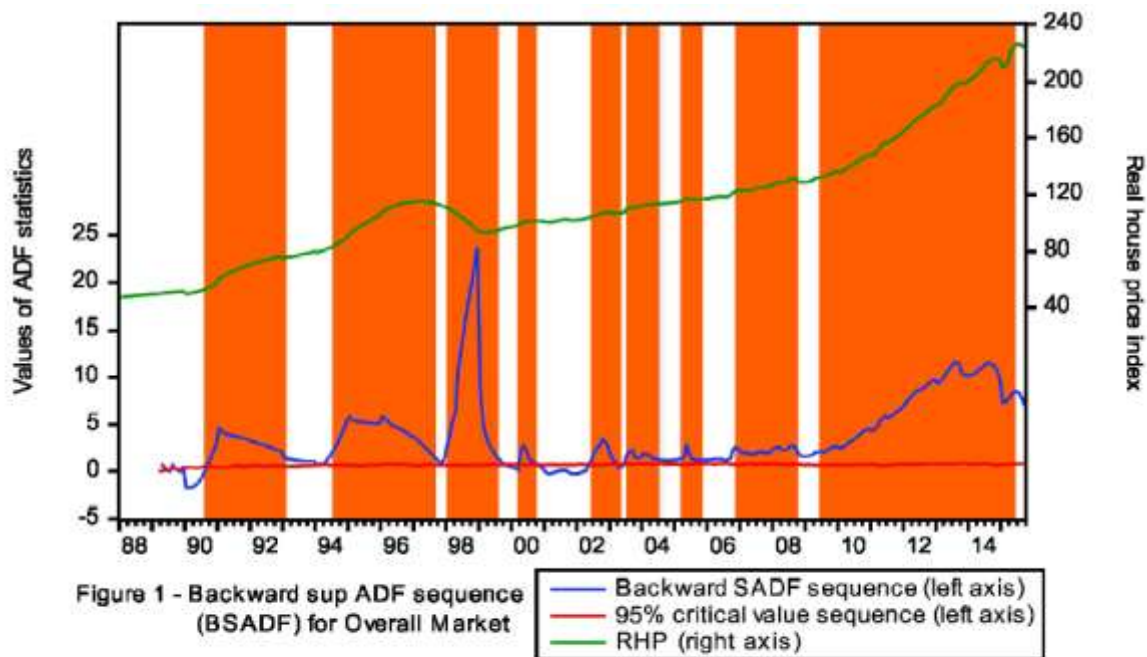

Figure 1 - Backward sup ADF sequence (BSADF) for Overall Market

Note: The ADF statistic values (blue line) above 95% critical value (red line) indicate bubble. The last bubble starting from 2010 has not collapse yet

Source: Yip, Choong *et al.* (2017, p. 249).

A more substantial price adjustment will happen only when the declining trend that seems to have begun deepens even further, if the monetary players will allow such a process to happen. In fact, as shown in Graph 8, although it cannot be considered as an element to

generate a boom by itself, a declining lending rate has played a role in supporting and eventually prolonging it. Yip, Choong *et al.* (2017, p. 249) have found data suggesting a correlation between the lending rate and overconfident investor behaviour between 2007 and 2009. The years in which the sharpest declines in the bank lending rate happened are the ones following the onset of the Great Recession, 2008-2009. This downturn influenced the business community, which stimulated business sentiment and facilitated the emergence of positive profit expectations, which, in turn, favoured the appearance of the property market upswing.

Graph 8: Malaysian bank lending rate.



At the same time, a significant expansion of credit is found in the period between 2013Q2 and 2016Q4; Mohd Daud, Ahmad and Podivinsky (2017, pp. 112-113) identify a Type 2 credit boom (understood as a deviation from the standard) for the above mentioned period, which is indeed following the transaction peak and therefore playing a role in sustaining a further expansion of the industry.

Graph 9: Credit growth and credit boom.

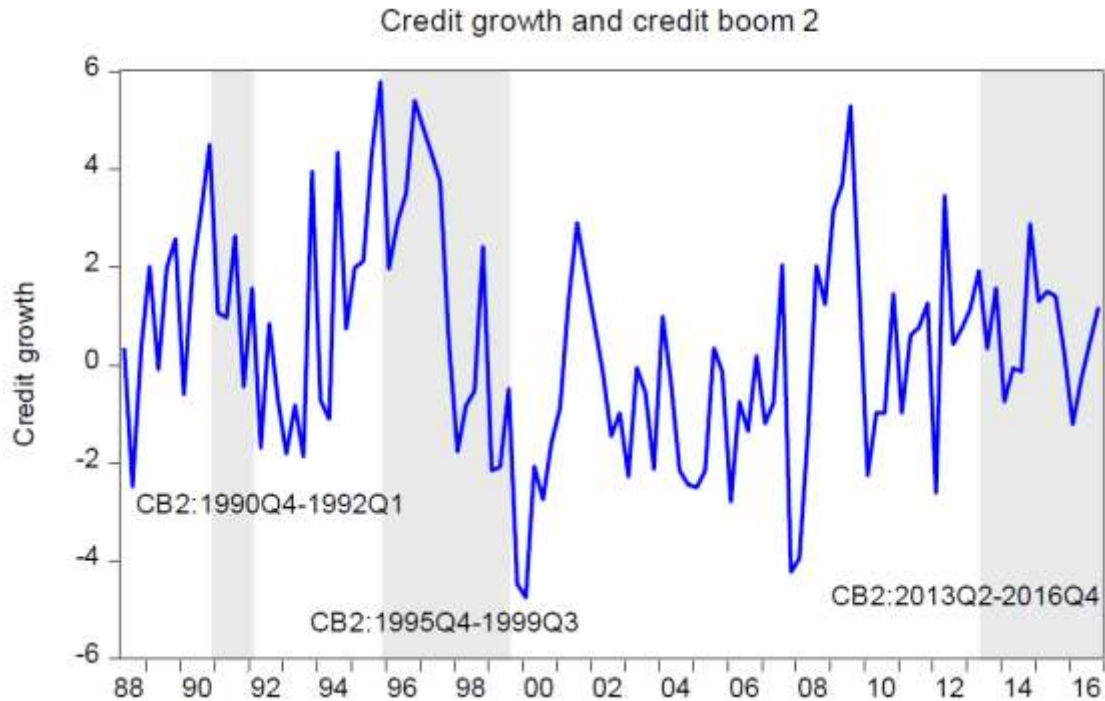

Source: Mohd Daud, Ahmad and Podivinsky (2017, p. 113).

Recently Bank Negara has raised the reference rate, and some policymakers have suggested promoting an opposite movement in the lending rate referred to the property market, in order to support an industry which is about to face trouble.

Graph 10: Malaysian interest rate.



We must hope for the opposite. In fact, if we recognize that the property boom has reached its physiological peak and is still expanding beyond the capacity for consumers to respond to such development, thanks also to a credit expansion to further artificially support the market with a favourable lending policy, this would mean impeding a readjustment that

seems not only unavoidable but also necessary for the production structure to be reshaped in order to meet consumer intentions. Moreover, the risk is not confined to the property sector. In fact, Malaysia is now listed by the Bank of International Settlements (BIS) as one of the top 15 countries with the highest household debt as percentage of GDP (Mohd Daud, Ahmad and Podivinsky 2017, p. 111). Malaysian household debt accounted for 84.3% of the country's nominal GDP in December 2017, compared with a ratio of 88.3% in the previous year. The data reached an all-time high of 89.0% in December 2015 and a record low of 60.4% in December 2008. In 2012 property financing was already 41% of the total loans in the banking system (Yip, Woo *et al.* 2017, p. 133). This means that household debt constantly grew precisely during the housing boom period under observation. In fact, by favouring a positive economic cycle, the profit expectations that brought in the property boom improved consumer confidence, bringing additional spending with it, often financed by the credit bubble mentioned above. Again, from the graph below we can also see how consumer preference started to deteriorate after the property boom reached its peak.

Graph 11: Malaysian consumer confidence.



Household debt dynamics as a percentage of GDP are shown in the graph below. A further support to credit would not only prolong the bubble beyond its physiological peak, but it would also put the overall economic stability of Malaysia at risk, due to the high level of household financial exposure, as I previously argued a few years ago in Grant (2014).

Graph 12: Household debt as percentage of Malaysian nominal GDP.

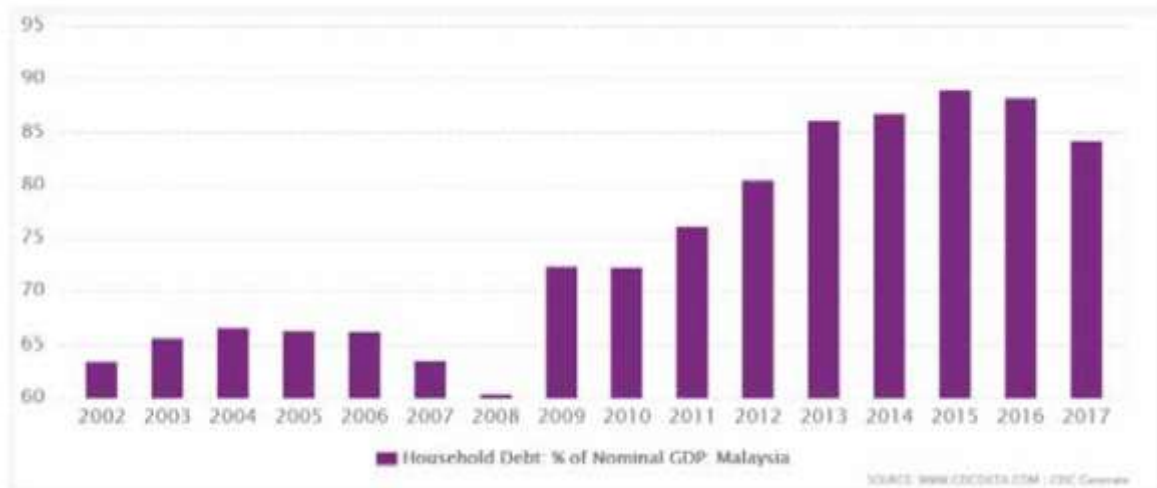

Let us try to summarize. The Malaysian property market, which has constantly expanded since the 1990s (see Mohd Daud, Ahmad and Podivinsky 2017 for a detailed analysis of the different cyclical moments), has experienced a boom after the Great Recession, a boom which was ignited by positive profit expectations and supported by a favourable lending policy. That boom did not simply bring about an increase in construction output, but also a rising price dynamic, and, as was to be expected, rising consumer confidence, which resulted in more consumption and a higher level of household debt. The industry expansion reached its peak in 2012-2013. Since then, construction output has grown at a slower pace, transactions have started to decline, and the price index has decelerated.

All these signals, which find their most significant synthesis in the number of unsold units, attest that the ‘wind changed direction’ and that the market started to experience a readjustment. Market observers are still reluctant to talk of a crisis, but a crisis does not necessarily take the shape of negative percentage changes. A slowdown is already the emergence of a crisis, which is more appropriately labelled as a ‘readjustment process’, a process in which the different market players exchange information and try to understand each other’s behaviours in an attempt to increase the degree of mutual consistency of their plans. Such a process cannot happen overnight, and it might take several years to complete; indeed, readjustment means reshaping the production structure, with resources that need to be diverted from certain uses towards others; it is easy to understand that such dynamics are not straightforward. Capital resources cannot be simply moved away. Indeed, some capital combinations have simply been wasted, and resources have been destroyed.

It should not be forgotten that, as hinted in paragraph 2, during the boom demand for labour increases and is drawn towards new investments, with related wage increases; this in turn encourages demand for consumer goods, and prices in the sector also increase. It is therefore evident that the increase in monetary income will not match an increase in real income, because of the inflationary effect exerted by unsatisfied demand for consumer goods. The conflict between the demand for consumer goods and the production of investment goods seems to be evident when demand for consumer goods exceeds the funds available for investment in terms of absolute value. At this point, the interest rate cannot but rise, frustrating demand for capital goods precisely when their prices have also risen. This is the situation the Malaysian property market is in now: Bank Negara has shown its will to tighten the monetary policy at the moment when property prices are at their peak. Consumer and producer prices index are shown below. As explained by my model, consumer prices rise during the boom, while producer prices reach a peak after the boom has reached its apex,

which is when the returns come in on previously started investments. However, such a peak is close to the inversion of the cycle.

Graph 13: Malaysian consumer price index.

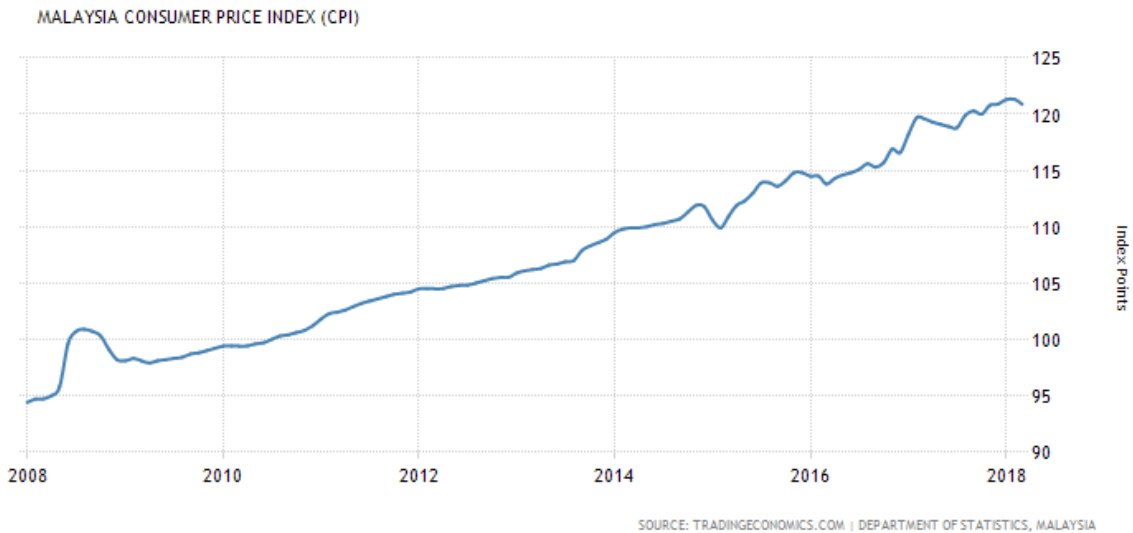

Graph 14: Malaysian producer prices.



A considerable part of the new plant capacity installed, which is designed to produce other capital goods, must remain unused since the additional investments required to complete new construction might not be available. As a result, in an advanced stage of the boom, growth in demand for consumer goods reduces the demand for capital goods. As stressed by Hayek (1933, pp. 148-149), the “increase of the prices of all those factors of production that can be used also in the late stages of production will raise the costs of, and at the same time the rise in the rate of interest will decrease the demand for, the capital goods which they produce. And a considerable part of the newly created equipment designed to produce other capital goods will stand idle because the expected further investment in these other capital goods does not materialise. This phenomenon of a *scarcity of capital* making it

impossible to use the existing capital equipment appears to me the central point of the true explanation of crises”.

This is the direction towards which the Malaysian property market is moving.

4. Policy suggestions

As mentioned above, the property bubble consequences could extend to the general economic system, and it is therefore time to consider some policy suggestions that may be able to confront the particular moment that is about to come. In particular, I will focus on four points: general management of the burst which is approaching, directing resources toward the affordable housing issue, the importance of improving financial literacy, and the possibility of further opening the market to foreign investors.

a. The property bubble and its burst

Over the past decades, the outbreak of an economic crisis was always confronted with a mix of monetary and fiscal policies, focused on monetary easing and fiscal stimuli. However, as experience in the USA demonstrated particularly in reference to the Great Recession (Gjerstad and Smith 2014, p. 279), traditional policies failed to properly address the problems faced after the housing bubble. First of all, in fact, monetary easing should be recognized as one of the factors that fuelled the bubble, and therefore it cannot be used as a potential remedy. This was true for the American case, which was characterized by the development of special financial instruments which increased household risk, but it is also true for the Malaysian situation, as observed in the above analysis. Moreover, the high level of Malaysian household debt suggests that there is a balance sheet crisis, such as the one analysed by Gjerstad and Smith (2014), where we find “large inventories of homes on the market” and the central bank possibly losing “control over housing and mortgage markets”, having therefore “limited ability to stimulate a recovery” (p. 279). Government deficit spending could be ineffective for the same reason: “Too many households [...] are mired in negative equity, and the financial system stalls in the slow process of diverting income into debt reduction” (p. 279).

Koppl (2014, p. 129) suggested that we need “to restore the rule of law and economic liberalism. We need to take what I will call the ‘constitutional turn’”. However, this perspective “does not tell us much directly about specific policies” (p. 131). In general, we may say that, while it will be difficult to manage the outbreak of the crisis, it will be important to prepare the institutional ground in order to reduce the consequences from future boom and bust cycles and to manage the period separating the housing market from the bust. Gjerstad and Smith (2014, pp. 281-282) first suggested restructuring property rights in the direction of limiting the consequences of financial imbalances to borrowers and lenders; one measure would be to introduce stricter down-payment rules. “When down payments are too small, borrowers and lenders place other parties at risk, including depositors and other investors who are not informed of the decision made by lenders. Even if the borrower and lender agree on the terms of the loan, third parties are affected”. The authors remind us of the tradition, backed by experience, according to which “mortgage, property insurance, and property taxes should not exceed 30 percent of income”. Moreover, “whereas the loan originator compensation fee should be determined by the market, its time distribution must be geared to the time profile of borrower payments. Any upfront component of the fee must be proportional to the cash down payment, with the remainder proportioned to principal payments and impounded in escrow payments to the originator. Under these fee rules, an originator cannot off-load the risk to a third-party lender; loan default must have

consequences for the originator of the loan and induce due diligence in the originator's own self-interest. Under this proposed distribution rule, it may or may not be efficient to separate lending from origination; however, if such separation occurs, the lending and origination functions would be incentive-compatible" (p. 231).

Moreover, although I am not keen on suggesting a higher level of government intervention when taking exceptional situations into account, like a deep crisis, I agree with Gjerstad and Smith (2014, p. 283) when they suggest that in such cases public policy should target homeowners' negative equity. Gjerstad and Smith (2014, pp. 236-237) suggest doing "for households what the fed sought for the banks [...], seek[ing] to reboot homeowners' damaged balance sheets in an effort to arrest a prolonged deleveraging process and more quickly restore household demand to levels no longer dominated by negative home equity". Among bad options, this might be the one with less damaging consequences.

From a fiscal perspective, it might be useful to follow what Irving and Herbert Fisher proposed regarding a shift from income to consumption tax.

Their proposal provides incentives for work, saving, economic growth, and investment. The underlying principle derives from Fisher's elementary insight that there is no unambiguous definition of society's income in the current period other than society's consumption withdrawals from the total production of goods and services. An individual's gross income is the market value – that is, wages, interest, rents, and profits – of what the individual supplies for the economic betterment of all others in the economy. All nonconsumption uses of output necessarily remain in the economic system to enhance future output and are not taxed until they are withdrawn from the circular flow to be consumed. A tax on any income receipts that continues to supply goods and services to the economy is necessarily a tax on future output and human economic betterment.

Under Fisher's proposal, income from all sources – including capital gains minus losses – would be calculated as it is today. No distinction is made between income and capital gains in listing income sources; neither is a distinction needed. Deductible from such income are all forms of saving regardless of whether it is held in bank deposits, invested in new capital goods, or used to buy common stocks or bonds. The residue after all of these savings-investment deductions is taxed as consumption, regardless of what form the consumption takes – buying a Ford, a yacht, hamburgers, clothing, or groceries, or making a down payment on a home. We note that capital gains are not taxed if reinvested because the resources continue to work in the economy and are taxed only if consumed, as with any other income source (Gjerstad and Smith 2014, pp. 284-285).

Applying this argument to the Malaysian case, as I argued in Ferlito (2014b) with specific reference to the introduction of GST in Malaysia, a tax reform that propagates a shift from an income tax toward a consumption tax might bring about positive effects. A consumption tax could play a balancing role. A consumption tax, which tends to shift consumer orientation to the future and favours saving, could be the best remedy for more sustainable long-term investments. This could further enrich Malaysia's economic system. A consumption tax should replace, or partially replace, the present income tax – not simply add to it. Simply adding new taxes could dramatically frustrate economic activity. A shift of the fiscal burden from income to consumption could instead drive better quality growth.

With regard to the possibility of tax reform, Garrison (2001, pp. 102-106) also considers the possibility of replacing the income tax with a consumption tax. Such a shift would lead to a modification of the structure of intertemporal preferences, thereby facilitating the creation of savings. The structure of preferences becomes more future oriented, thereby generating resources for private investment thanks to increased savings.

Graph 15: Tax reform – from income tax to consumption tax (Garrison, 2001, p. 103).

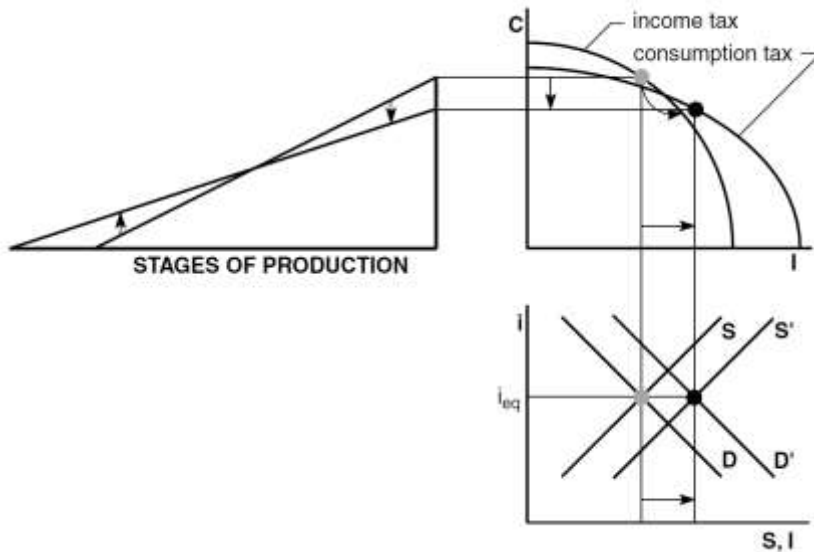

The key item here is not the tax reform *per se* but the possibility of reducing consumption without changing the interest rate, while allowing a natural change in the structure of time preferences. Garrison (2001, p. 104) emphasises that “it is precisely the reduction of consumption that makes a higher growth rate possible”.

Following the logic of Fisher and Fisher, “business income would be taxed only once at the individual-household level and only insofar as it is consumed. Hence, all business taxes would be abolished. Because corporations commonly retain a portion of their profits for reinvestment, this represents the recycling of resources into the generation of future output and would not be taxed. Corporate retained earnings are savings until reinvested by the firm and would not be taxed. To the extent that businesses incur food and entertainment expenditures for employees and customers, they would be taxable for the same reason that room and board would be taxable while attending college” (Gjerstad and Smith 2014, p. 285).

The suggestion to “remove tax- and transactions-cost barriers to the formation of new businesses” (Gjerstad and Smith 2014, p. 245) goes in the same direction. This would help the economic system find a path toward a new equilibrium or, more properly, toward a capital reorganization consistent with the new economic scenario, which would avoid keeping resources locked into industries which do not offer profit opportunities.

From the perspective of the government, it would be important to work more on the importance of “fiscal discipline. Uncertainty over how deficits will be financed creates regime uncertainty. It is not clear how a large current and predicted government debt will be financed. Will there be inflation, price controls, default or surtaxes? What will be taxed? Will ‘excess’ profits be taxed? And so on [...]. Regime uncertainty tends to depress the state of confidence and to make optimism fragile” (Koppl 2014, p. 133). Fiscal discipline moves on a path toward “monetary stability and confidence that such stability will not suddenly evaporate” (Koppl 2014, p. 135).

b. *Favouring the affordable housing market*

In Ferlito (2018, pp. 17-23), I explained in detail how the Malaysian property boom happened mainly in the high-end segment, while unexploited profit opportunities seem to be now present in the affordable housing market. Affordable housing provision is currently fragmented over 20 national and state-level agencies are involved in the provision of affordable housing (see table below).

Graph 16: Agencies providing affordable housing in Malaysia.

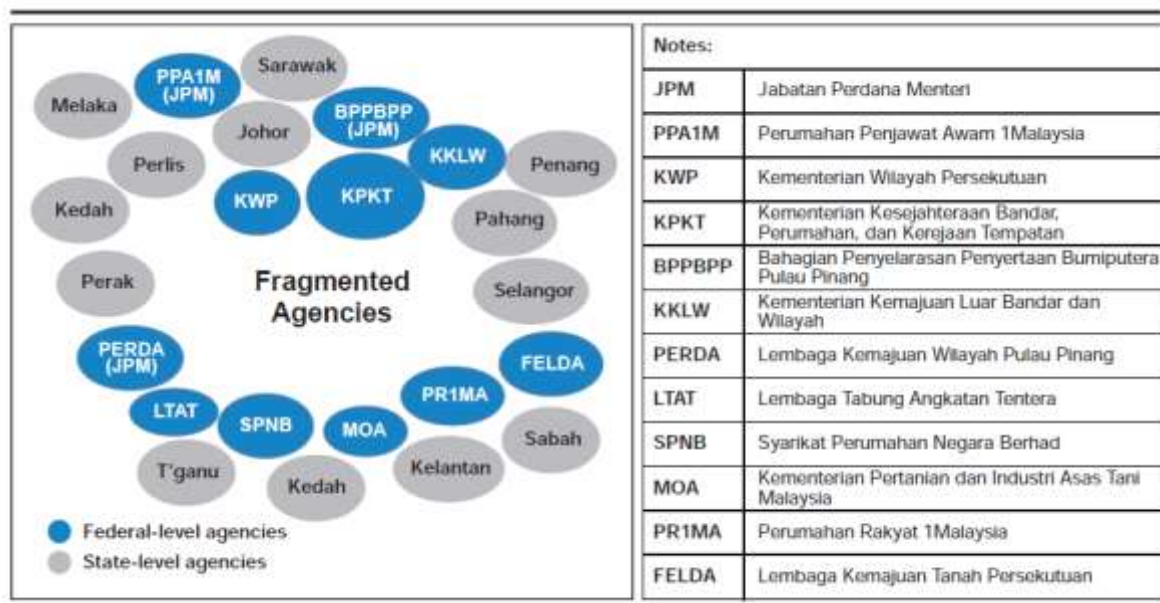

Source: Su Ling, Almeida and Su Wei (2017, p. 21).

Su Ling, Almeida and Su Wei (2017) suggested that a “consolidation will improve efficiency in planning, implementation and execution. Other strategic benefits of establishing such an entity include the acceleration of construction activities and reduced development cost due to economies of scale. The affordable housing initiatives could be consolidated first at the federal level, where the single entity can then leverage on the integrated database to plan affordable housing supply across the nation. Once this is successful, state authorities would be encouraged to be partners of the entity”.

Such a solution, which might sound reasonable, fails to recognize the difficulties implied in central planning, which can be summarized in the calculation (Mises 1920) and knowledge problem (Hayek 1937, 1945). Lavoie (1985a, 1985b) and Huerta de Soto (1992) have more recently built upon Mises’ and Hayek’s legacies to demonstrate how the calculation and the knowledge problems raise serious issues for any attempt at central planning. In particular, Huerta de Soto (1992) combined the two aspects into a brilliant synthesis (see Ferlito (2013, chapter 4). Moreover, central planning will not be useful in helping the market to recover from a crisis.

My proposal goes in the opposite direction. First of all, it should be recognized that the property bubble grew in the high-end sector due to rising profit expectations, and investors cannot be blamed for this. However, at the moment in which the tide is turning and it is becoming all the more clear that profit opportunities are shifting from the high-end segment toward the affordable housing market, the very presence of government action in these markets will discourage private initiatives; this will be gradually more true as the gap between supply and demand decreases. As a consequence, government action in the medium run will halt private initiative, not only limiting the supply of affordable housing but at the same time prolonging the effects of an eventual property crisis. In fact, by discouraging the shift of investment towards the affordable property segment, government action keeps capital stuck in unprofitable initiatives, impeding a readjustment process in capital allocation.

The best alternative would be for government agencies to gradually step back from direct intervention in the market, allowing private capital to move toward segments where

unexploited profit opportunities are perceived. In this way, the government would obtain the doubly good effect of attracting capital into an industry considered strategic and at the same time creating opportunities for capital reallocation that will help absorb the effect of the bubble bursting.

In addition, as a compromise solution, government could maintain an active role in promoting investment in the affordable housing sector by *nudging*. In particular, I have in mind fiscal incentives for new affordable housing initiatives, which would further attract investors without altering market interaction and the working of the price mechanism.

c. Financial literacy

I agree, instead, with the fourth suggestion in Su Ling, Almeida and Su Wei (2017, p. 24), when they talk about enhancing financial literacy. The need for a higher degree of economic and financial understanding is attested by the high level of household debt, as observed above. Gjerstad and Smith (2010) have already demonstrated the correlation between household expenditure cycles and economic cycles; therefore it becomes very important to understand that household consumption behaviour can have dramatic consequences on the general economic system. It is worth quoting the final passages from Gjerstad and Smith (2010, p. 30).

Housing has led eleven of the last fourteen recessions whereas investment has only led the declines in 1990 and 2001. Magnitudes of movements in housing reinforce its role in what is universally referred to as the “business cycle.” During post-war recessions the average percentage decline in housing – at 32.5 percent – was $2\frac{3}{4}$ times as large as the 11.8 percent average decline in investment. When we aggregate households’ interest rate sensitive expenditure on housing and durables, their declines (in dollar amounts) have been 38.3 percent larger than investment declines, and their timing strongly indicate that the investment cycle is a delayed response to downturns in interest rate sensitive elements of household expenditures.

Monetary policy has left a clear imprint on developments in the real economy. In the immediate aftermath of most recessions, housing expands more rapidly than any other component of GDP, and inflation falls. Through the first part of the expansion, housing increases and inflation remains low. In the latter part of expansions, housing ceases to respond to loose monetary policy, but inflation starts to develop. In response to developing inflation, the Fed tightens monetary policy in order to rein in inflation, housing begins a sharper decline, and the economy enters a recession. In most cases, declines in consumer durable goods expenditures begin to fall soon after the decline in housing, yet the decline in investment comes several quarters later, coincident with the start of the recession. Tightened monetary policy, and the general contraction that follows, eases inflationary pressures. As inflation subsides, the Fed returns to a looser monetary policy. At that point, housing begins a rapid resurgence, and the economy emerges from recession. As a recovery gains momentum, businesses respond to growing demand by increasing their capacity with investments in structures and equipment. This general pattern has played out in most post-war recessions, with only minor variations in the sequence of events. A genuine understanding of economic fluctuations must recognize these basic facts of household expenditure cycles and investment cycles.

It is necessary for Malaysian consumers to increase their degree of prudence regarding their consumption behaviour, not only with reference to their housing strategy. In fact, not only are expenditure cycles related to economic cycles, but a high degree of financial exposure can make a recession more painful for the same consumers who are over-exposed. Every educational initiative would be welcome, both from government and consumer associations. One of the key points to stress would be that owning a house is not a ‘fundamental human right’, but an opportunity that may or may not happen over the course of an individual’s life.

The other key point regards the necessary, basic understanding that saving is a virtue and only saving can bring about, in the medium to long run, a virtuous economic cycle. In fact, self-financed investment decisions can stand during a crisis, and at the same time they require saving in order to be put into place. Moreover, saving represents the best form of

intergenerational pact, in which one generation is linked to another via created, rather than consumed, resources. And created resources can be transformed into new opportunities.

d. Opening the market to foreigners

As it is well known, Malaysia, although a business-friendly country, has developed over the years a restrictive policy with regard to the possibility for foreigners to purchase property in the country. In particular, in order to own a property foreign individuals must spend a minimum amount that varies according to State, as shown in the graph below.

Graph 19: Minimum threshold for foreign residential property purchases.



Source: <https://www.edgeprop.my/content/1045775/minimum-property-purchase-prices-foreign-buyers>.

Even if the reason behind such regulation is clear, it is also clear that, as a property crisis is approaching, opening the market to new potential buyers might help to ease the pain. However, recognizing government concern about foreign entities moving toward aggressive Malaysian ‘shopping’, my proposal goes in the direction of a critical opening of the market.

In fact I suggest considering as ‘local buyers’ those foreigners who are in possession of a regular working visa (or similar, i.e. TalentCorp visa) for at least five years and have regularly paid taxes in Malaysia during the same period. In this way the market would be open not to general speculators but to those individuals who can be considered as persons who have decided to ‘settle down’ in Malaysia. Such a measure would move in the same direction as the TalentCorp program, which allows foreigners to be considered as local workers for ten years, if they meet certain conditions. Similar requirements might be suggested in order to be considered ‘local buyers’.

In this way the government would obtain the double result of keeping foreign speculators away, but at the same time opening the market to new potential buyers, which would help the industry in a crucial moment of difficulty.

5. Concluding remarks

The present paper has analysed the evolution of the property market in Malaysia over the past ten years in light of the *natural cycle* analytical framework. We observed how positive profit expectations ignited the boom, generating an important wave of investments and transactions in the housing industry. That wave was further propagated by credit expansion. We observed that in 2012-2013 the expansion reached its peak and was followed by a period of stabilization, while recent indicators suggest that a tidal reversal might be close.

My analysis suggests that the coming crisis should be confronted with the will to carry out structural reforms that aim to redefine the credit market and to restore household balance sheets. Such reforms should be accompanied by a shift toward consumption taxes rather than income taxes, fiscal discipline, and monetary certainty, together with the removal of barriers for new business opportunities. The present study also suggests that opening the housing market to foreign investors might help limit the damage in the crisis.

Regarding the affordable housing market, this paper argues that a gradual government pullback could drive private initiative toward an unexploited segment, reaching the double goal of increasing the number of available affordable housing solutions and of helping private investors restructure their capital structure in light of the coming crisis.

References

Bank Negara Malaysia (2017), *Quarterly Bulletin – Third Quarter 2017*, https://www.bnm.gov.my/files/publication/qb/2017/Q3/p3_ba2.pdf.

Cowen, T. and Tabarrok, A. (2015), *Modern Principles: Microeconomics*, New York, NY, Worth Publishers.

Fanno, M. (1931) [2002], *Production Cycles, Credit Cycles and Industrial Fluctuations*, in H. Hagemann (ed.), *Business Cycle Theory. Selected Texts 1860-1939*, Volume II: *Structural Theories of the Business Cycle*, Pickering and Chatto, pp. 225-261.

Ferlito, C. (2013), *Phoenix Economics. From Crisis to Renaissance*, New York, Nova Science Publishers.

Ferlito, C. (2014a), *The Natural Cycle: Why Economic Fluctuations are Inevitable. A Schumpeterian Extension of the Austrian Business Cycle Theory*, “Journal of Reviews on Global Economics”, 3, pp. 200-219.

Ferlito, C. (2014b), *The opportunity of a consumption tax*, “The Malaysian Insider”, 6 April.

Ferlito, C. (2016a), *At the root of economic fluctuations: theoretical framework and empirical evidences*, in V. Beker and Beniamino Moro (eds.), *The European Crisis*, Bristol (UK), World Economics Association, pp. 201-250.

Ferlito, C. (2016b), *Hermeneutics of Capital. A Post-Austrian Theory for a Kaleidic World*, Hauppauge, NY, Nova Science Publishers.

Ferlito, C. (2018), *Affordable Housing and Cyclical Fluctuations: The Malaysian Property Market*, Policy IDEAS Series, 51.

Ferlito, C. (2019), *A meaning discovery process: the unique contribution of the Austrian School of Economics and its relevance for contemporary economics curricula*, “International Journal of Pluralism and Economics Education”, forthcoming.

Garrison, R.W. (2001), *Time and Money. The macroeconomics of capital structure*, London and New York, Routledge.

Gjerstad, S.D. and Smith, V. (2010), *Household expenditure cycles and economic cycles, 1920 – 2010*, Working Paper, <https://www.researchgate.net/publication/277289722>.

Gjerstad, S.D. and Smith, V. (2014), *Rethinking Housing Bubbles. The Role of Household and Bank Balance Sheets in Modeling Economic Cycles*, New York, Cambridge University Press.

Grant, J. (2014), *Comfortably off but ‘squeezed’*, “Financial Times”, 17 April, p. 4.

von Hayek, F.A. (1929) [1966], *Monetary Theory and the Trade Cycle*, New York, Kelley.

von Hayek, F.A. (1931) [1967], *Prices and Production*, New York, Kelley.

von Hayek, F.A. (1933) [1975], *Price Expectations, Monetary Disturbances and Malinvestments*, in F.A. von Hayek, *Profits, Interest and Investment and Other Essays on the Theory of Industrial Fluctuations*, Clifton, Augustus M. Kelley, pp. 135-156.

von Hayek, F.A. (1937), *Economics and Knowledge*, “Economica”, 4, 13, pp. 33-54.

von Hayek, F.A. (1939) [1975], *Profits, interest and Investment*, in F.A. von Hayek, *Profits, Interest and Investment and Other Essays on the Theory of Industrial Fluctuations*, Clifton, Augustus M. Kelley, pp. 3-71.

von Hayek, F.A. (1945), *The Use of Knowledge in Society*, “American Economic Review”, 35, 4, pp. 519-30.

Huerta de Soto, J. (1992) [2010], *Socialism, Economic Calculation and Entrepreneurship*, Cheltenham and Northampton, Edward Elgar.

Huerta de Soto, J. (2008), *The Austrian School. Market Order and Entrepreneurial Creativity*, Cheltenham and Northampton, Edward Elgar.

JPPH – Jabatan Penilaian & Perkhidmatan Harta (2017), *Preliminary Property Market Brief 2017*.

Koppl, R. (2014), *From Crisis to Confidence. Macroeconomics after the Crash*, London, The Institute of Economic Affairs.

Lachmann, L.M. (1956) [1978], *Capital and Its Structure*, Kansas City, Sheed Andrews and McMeel.

Lavoie, D. (1985a) [2015], *Rivalry and Central Planning: The Socialist Calculation Debate Reconsidered*, Arlington, VA, Mercatus Center.

Lavoie, D. (1985b) [2016], *National Economic Planning: What is Left?*, Arlington, VA, Mercatus Center.

Lewin, P. (2005), *The Capital Idea and the Scope of Economics*, "The Review of Austrian Economics" 18 (2), pp. 145-167.

Minsky, H.P. (1982) [2016], *Can "It" Happen Again? Essays on Instability and Finance*, London and New York, Routledge.

Minsky, H.P. (2008), *Stabilizing an Unstable Economy*, New York, McGraw-Hill.

von Mises, L. (1920) [1990], *Economic Calculation in the Socialist Commonwealth*, Auburn, AL, Ludwig von Mises Institute.

von Mises, L. (1949) [1998], *Human Action. A Treatise on Economics*, Auburn, AL, Ludwig von Mises Institute.

Mohd Daud, S.N., Ahmad, A.H. and Podivinsky, J. (2017), *Credit and the housing boom in Malaysia: A comeback?*, "Economics and Business Letters", 6, 4, pp. 110-115.

Nardi Spiller, C. (2000), *Affinità e distinugo nell'analisi delle fluttuazioni cicliche tra Fanno e Hayek*, "Nuova Economia e Storia", VI, 1-2, pp. 73-94.

Nardi Spiller, C. (2016), *Fluttuazioni cicliche e nuovi orientamenti del consumo*, in C. Nardi Spiller and P. Savi, *Nuovi orientamenti del consumo e "rinascita" della manifattura*, Verona, QuiEdit, Chapter I.

O'Driscoll, G. and Rizzo, M. J. (1985) [2002], *The Economics of Time and Ignorance*, London and New York, Routledge.

Prychitko, D.L. (2010), *Competing Explanations of the Minsky Moment: The Financial Instability Hypothesis in Light of Austrian Theory*, "The Review of Austrian Economics", 23, pp. 199-221.

Romano, R. and Lucarelli, S. (2017), *Squilibrio. Il labirinto della crescita e dello sviluppo capitalistico*, Roma, Ediesse.

Schumpeter, J.A. (1939) [2005], *Business Cycles: A Theoretical, Historical and Statistical Analysis of the Capitalist Process*, Chevy Chase and Mansfield Centre, Bartleby's Books and Martino Publishing.

Schumpeter, J.A. (1964) [2008], *Business Cycles: A Theoretical, Historical and Statistical Analysis of the Capitalist Process*, 2008 digital abridged edition edited by Didier Lagrange.

Spiethoff, A. (1925) [2002], *Business Cycles*, in H. Hagemann (ed.), *Business Cycle Theory. Selected Texts 1860-1939*, Volume II: *Structural Theories of the Business Cycle*, London, Pickering and Chatto, pp. 109-205.

Storr, V.H. (2017), *Ludwig Lachmann's peculiar status within Austrian economics*, "The Review of Austrian Economics", DOI: 10.1007/s11138-017-0403-2.

Su Ling, C., Almeida, S.J. and Su Wei, H. (2017), *Affordable Housing: Challenges and the Way Forward*, in *Bank Negara Malaysia Quarterly Bulletin – Fourth Quarter 2017*, pp. 19-26.

Sylos Labini, P. (1954) [1977], *Il problema dello sviluppo economico in Marx e Schumpeter*, in P. Sylos Labini, *Problemi dello sviluppo economico*, Bari, Laterza, pp. 19-73.

Sylos Labini, P. (1984), *The Forces of Economic Growth and Decline*, Cambridge and London, MIT Press.

Thornton, M. (2018), *The Skyscraper Curse. And How Austrian Economists Predicted Every Major Economic Crisis of the Last Century*, Auburn, AL, Ludwig von Mises Institute.

Yip, C.Y., Woo, K.H., Oon, K.H., Nabihah, B.A. and Nurfadhilah, B.A.H. (2017), *Boom-Bust Housing Price Dynamic: The Case of Malaysia*, "International Journal of Economics and Financial Issues", 7, 4, pp. 132-138.

Yip, C.Y., Choong, C.K., Woo, K.H., Tan, Y.T. and Au Yong, H.N. (2017), *Housing Dynamic and Bubbles – A Statistical and Economic Investigation – (The Case of Malaysia)*, "International Journal of Applied Business and Economic Research", 15, 7, pp. 241-253.