

Prachuab Peerapong; Bundit Limmeechokchai

Article

Optimal electricity development by increasing solar resources in diesel-based micro grid of island society in Thailand

Energy Reports

Provided in Cooperation with:

Elsevier

Suggested Citation: Prachuab Peerapong; Bundit Limmeechokchai (2017) : Optimal electricity development by increasing solar resources in diesel-based micro grid of island society in Thailand, Energy Reports, ISSN 2352-4847, Elsevier, Amsterdam, Vol. 3, pp. 1-13, <https://doi.org/10.1016/j.egyr.2016.11.001>

This Version is available at:

<https://hdl.handle.net/10419/187876>

Standard-Nutzungsbedingungen:

Die Dokumente auf EconStor dürfen zu eigenen wissenschaftlichen Zwecken und zum Privatgebrauch gespeichert und kopiert werden.

Sie dürfen die Dokumente nicht für öffentliche oder kommerzielle Zwecke vervielfältigen, öffentlich ausstellen, öffentlich zugänglich machen, vertreiben oder anderweitig nutzen.

Sofern die Verfasser die Dokumente unter Open-Content-Lizenzen (insbesondere CC-Lizenzen) zur Verfügung gestellt haben sollten, gelten abweichend von diesen Nutzungsbedingungen die in der dort genannten Lizenz gewährten Nutzungsrechte.

Terms of use:

Documents in EconStor may be saved and copied for your personal and scholarly purposes.

You are not to copy documents for public or commercial purposes, to exhibit the documents publicly, to make them publicly available on the internet, or to distribute or otherwise use the documents in public.

If the documents have been made available under an Open Content Licence (especially Creative Commons Licences), you may exercise further usage rights as specified in the indicated licence.



<https://creativecommons.org/licenses/by-nc-nd/4.0/>



Optimal electricity development by increasing solar resources in diesel-based micro grid of island society in Thailand



Prachuab Peerapong, Bundit Limmeechokchai *

Sirindhorn International Institute of Technology, Thammasat University, Pathum Thani 12121, Thailand

ARTICLE INFO

Article history:

Received 19 April 2016
 Received in revised form
 3 November 2016
 Accepted 11 November 2016
 Available online 25 November 2016

Keywords:

Hybrid energy system
 Photovoltaic
 Diesel generator
 Sensitivity analysis
 Costs of electricity

ABSTRACT

Isolated grid diesel-based systems have been a basic electricity system in islands in developing countries. Nevertheless, the increasing diesel price and the higher cost of diesel transport to a long distance to the remote islands make the diesel-based systems unsustainable. This study analyzes the viability to increase solar photovoltaic (PV) resources in the existing diesel-based systems. The hybrid PV/diesel system is not only reducing the cost of electricity generation but also decreasing the harmful emissions from fossil fuels. This study uses net present cost (NPC) to evaluate the optimum PV/diesel system configurations for installation in isolated island in Thailand. The results of analyses show that the optimal case PV/diesel system can decrease COE from \$0.429/kWh to \$0.374/kWh when compared to the existing diesel-based system and can decrease emissions both carbon dioxide of 796.61 tons/yr and other gases of 21.47 tons/yr. The hybrid PV/diesel system also reduces diesel fuel consumption of 302,510 liters per year as a result from an optimal of 41% PV resource shares in this system.

© 2016 The Authors. Published by Elsevier Ltd.
 This is an open access article under the CC BY license
 (<http://creativecommons.org/licenses/by/4.0/>).

1. Introduction

Electricity consumptions in Thailand from 2013 to 2035, is approximately forecast with annually increasing rate of 3.8% (IEA, 2013), that it will increase to 346,767 GWh in 2030 (EGAT, 2010). Historical electricity consumptions in Thailand is shown in Table 1. The electricity consumption per capita in Thailand in 2013 was 2536 kWh (DEDE, 2013). This consumption per capita is very high when compared to other Southeast Asian countries. For example, when compares to Malaysia's consumption according with economic growth base, Thailand's GDP per capita in 2011 was only half of Malaysia's (IEA, 2013) but electricity consumption per capita in Thailand is the same as of Malaysia's. The domestic power installation in 2013 was only 33,618 MW, however it is not to meet the higher electricity demand, Thailand needs to import electricity from Laos PDR, Malaysia. Therefore, Thailand is the net import electricity in Southeast Asian countries. Electricity capacity, electricity demand, power plant efficiency, and national grid losses in Thailand are shown in Table 2.

The Ministry of Energy has come up with a policy to develop the renewable energy (RE) and setup the Alternative Energy Development Plan (AEDP) for period 2012–2021 (DEDE, 2012).

The objective of AEDP Plan is to increase the portfolio of renewable energy to 25% in final energy consumption in 2021. The updated AEDP plan aims at increasing renewable electricity generation in Thailand to 13,924 MW by 2021. The AEDP plan is expected to be integrated higher renewable energy in electricity generation. However the updated AEDP in 2015 called AEDP 2015 (DEDE, 2015), is aiming to increase shares of renewable energy penetration in electricity generation in Thailand to 20%, which is equivalent to 19,635 MW by 2036, the new AEDP plan is expected to be integrated renewable energy in electricity generation. Power capacity will increase from 4279 MW in 2014 to 19,635 MW in 2036. Since Thailand is an agricultural-based country and high solar irradiation potential, Thailand set high targets of renewable electricity capacity for solar power (6000 MW), biomass (5570 MW), hydro power (3282 MW), wind power (3002 MW), biogas (600 MW), municipal solid waste (501 MW), and electricity from energy crops (680 MW). The details of distribution of renewable energy is shown in Table 3.

The electricity accessibility level in islands in Thailand is very low due to the difficulty of grid extensions, and the higher costs of grid accessibility in remote areas when compared to the whole areas in country with the rate of 99% electricity accessibility (IEA, 2013). In remote islands, electricity is mainly supplied by diesel generators. Though diesel systems have their distinctive advantages of electricity generation in remote areas, but higher diesel costs, especially at the uncertain demands and load fluctuation, and the costs of battery storage, and

* Corresponding author.

E-mail address: bundit@siit.tu.ac.th (B. Limmeechokchai).

Table 1
Final energy consumptions by energy type in Thailand.
Source: DEDE (2013) and EGAT (2013).

Final energy consumption (ktoe)						Growth (%)	Shares of energy type (%)
	2009	2010	2011	2012	2013	2013	2013
Petroleum products	31,661	32,096	33,078	34,881	35,948	3.1	47.8
Electricity	11,521	12,724	12,671	13,783	14,002	1.6	18.6
Renewable energy	4,134	4,534	13,138	12,976	13,978	7.7	18.6
Coal & Its products	7,493	8,240	7,190	6,582	5,947	-9.6	7.9
Natural gas	3,568	3,769	4,485	5,094	5,339	4.8	7.1
Total	66,698	70,248	70,562	73,316	75,214	2.6	100

Table 2
Electricity generation, consumption and power system efficiencies and losses in Thailand.
Source: DEDE (2013).

	2009	2010	2011	2012	2013
Installed capacity (MW)	30,607	31,485	31,773	33,177	33,618
Peak power generation (MW)	23,064	25,094	23,388	24,825	26,598
Electricity power generation (GWh)	148,390	159,518	155,986	168,178	169,593
Electricity consumption (GWh)	135,209	149,320	148,700	161,750	164,323
Population (1000 person)	63,525	63,878	64,076	64,457	64,786
Electricity consumption per capita (kWh/person)	2128	2338	2321	2509	2536
Average thermal power efficiency (%)	38.3	38.3	37.9	38.4	39.8
National electricity grid loss (%)	5.9	6.3	6.9	5.6	6.1

Table 3
Accumulated installed capacity of renewable energy in Thailand, MW.
Source: DEDE (2013).

Renewable energy	Accumulated installed capacity					Growth rate
	2009	2010	2011	2012	2013	2012–2013
Solar	37.0	48.6	78.7	376.7	823.5	118.6%
Wind	5.1	5.6	7.3	111.7	222.7	99.4%
Small hydro	55.7	58.9	95.7	101.8	108.8	6.9%
Biomass	1618.1	1650.2	1790.2	1959.9	2320.8	18.4%
Biogas	69.8	103.4	159.2	193.4	265.7	37.4%
MSW	6.6	13.1	25.5	42.7	47.5	11.2%
Total	1792.3	1879.8	2156.6	2786.2	3788.5	35.9%

This installed capacity including off-grid power generation; MSW stands for Municipality Solid Waste.

with the transportation cost of diesel fuels to the islands, are also prohibitively to sustainable development. In Thailand, the application of renewable energy technologies (RETs) for islands has been increasing in recent years, but it is not very widespread. Therefore, the concept of PV–diesel hybrid electricity system is an alternative sustainable energy solution because it uses abundant solar resources combined with diesel fuels to create a kind of hybrid energy sources to provide electricity in islands.

PV/diesel hybrid electricity system is an effective sustainable energy development in many islands. It uses diesel with solar resources, so it can reduce air pollutant emissions. Thailand is located in the hot tropical zone. Geographical distribution of annual solar radiation map indicated that 45% of total areas of overall country receiving solar energy of 17–18 MJ/m²/day, which can produce electricity 4.72–5.0 kWh/m²/day (DEDE, 2010). With the abundance of solar resources PV farms have been already installed in Thailand with a capacity of 989.7 MW (in the first quarters of 2015). Thai government has promoted the small scale solar PV installations such as solar rooftops in the residential, and in the commercial buildings. In terms of hybrid PV/diesel system, or PV/Wind/diesel system, Thailand has already successful experiences of installation hybrid systems in some islands. The hybrid PV/diesel in Koh-jig island in Thailand was studied (Phuangpornpitak and Kumar, 2011), and the system in this island was installed. This island located in Chantaburi province on the eastern coast of Thailand. This hybrid PV/diesel installed with the battery storage; the system comprises of 7.5 kW PV arrays, 60 kW diesel generator capacity, and 60 units of battery capacity of 2100 Ah. The system is more cost-effective than the stand-alone diesel generation (the cost varied

with \$0.315–\$0.526 per kWh), and significantly reduces pollutant emissions and noise problem from diesel generators. The study of economic feasibility of decentralized hybrid PV/diesel with the battery storage in Northern part of Nigeria and indicated that the COE varying between \$0.348/kWh and \$0.378/kWh (depending on the interest rates) which its cost was cheaper than the stand-alone diesel generation (the cost varying between \$0.417/kWh and \$0.423/kWh) (Adaramola et al., 2014b). The optimal sizing of hybrid wind/diesel/battery in isolated system in Portugal using Mixed-Integer Linear Programming formulation (MILP) (Malheiro et al., 2015). They found that wind/solar PV/diesel/batteries was the most cost effective options. The electricity cost in this system was \$0.2499/kWh when compared to the standalone diesel generation system with its cost of \$0.6256/kWh. With regard to the minimized cost and CO₂ emissions consideration, the study of the hybrid PV/diesel with the battery storage in a remote resident area shows that the hybrid system was more cost-effective than both diesel-only system. The share of renewable energy in optimal case was 27%, with 2.5 MW solar PV and 4.5 MW diesel generator installations (Shaahid and El-Amin, 2009). The hybrid PV/diesel with battery storage in isolated island in Malaysia with the varying of load demand consumptions, diesel prices and interest rates, and they found that at low interest rates of less than 3% would be a desirable solution for the hybrid PV/diesel with the battery storage over the diesel-only generation system, with regardless of any load sizes. The study found that when diesel price was \$1.22/l or higher, the hybrid PV/diesel with battery storage was more feasible than the case of diesel-only system, in terms of COE consideration (Lau et al., 2015).

2. HOMER model

The analyses in this paper employs HOMER model (HOMER energy, 2016). The Hybrid Optimization of Multiple Energy Resources (HOMER) software was introduced by the National Renewable Energy (NREL) USA. HOMER is a micro-power optimization model (Manwell et al., 2006). HOMER is a powerful simulation tool, considering sustainability factor inputs such as system efficiency, meteorological data, fuel costs, operation and maintenance costs. In simulation process, HOMER model balances between demand and supply and calculates the feasibility of any configurations and it optimizes the least cost of electricity generated in the system. In the optimal process, HOMER model simulates the various proposed system configurations and selects the best optimal system configuration. The optimized solution is to satisfy the technical constraints at the lowest total net present cost (NPC). HOMER can perform a sensitivity analysis which can help to investigate the effects of uncertainty or the changes of input variables. HOMER software is considered the most widely used in hybrid electricity systems. Many researchers use HOMER to study the feasibility of solar PV and wind resources to penetrate in conventional diesel generation systems. The hybrid power system was studied in a remotely located population. There are many authors used HOMER software to investigate renewable potentials for electricity generations (Bahramara et al., 2016). The estimation the potential of renewable energy resources including solar PV, wind energy, biomass, and hydro power for electricity generation by using HOMER in Bangladesh was investigated with different technologies (Mondal and Denich, 2010). The optimal renewable energy systems design in Maldives and in Malaysia, were created and analyzed the electricity cost with renewable fractions penetration in isolate islands (Lau et al., 2015; van Alphen et al., 2007). The simulation off-grid electricity generation which integrating solar PV and micro hydro as renewable sources with diesel generators was investigated for remote villages in Cameroon (Ayompe and Duffy, 2014). The analysis of the potentials of hybrid PV/diesel/battery storage in a remote residential area in Malaysia was investigated and also studied the effects of the higher diesel prices in this system (Lau et al., 2010). An economic assessment in optimization of the hybrid distributed generation system and compared in different technologies was presented and studied in isolate communities in the Brazilian Amazon (Silva et al., 2010).

3. Methodology

The average global solar energy falling during the day on per square meter of the solar modules, in the south oriented at the optimal angle in relation to the horizontal surface was developed and studied (Idowu, 2013; Ayodele and Ogunjuyigbe, 2015), can be calculated in Eq. (1);

$$G(\beta) = G_{opt} = \frac{G_o}{1 - 4.46 \times 10^{-4} \times \beta - 1.19 \times 10^{-4} \times \beta^2} \quad (1)$$

where β is the optimal angle of the solar modules installation, G_{opt} is the total amount of the global solar energy falling during the day per square meter of solar PV modules (Wh/m^2), and $G(0)$ is the total amount of the global solar energy falling during the day per square meter of a horizontal surface (Wh/m^2). In order to obtain optimal inclination angle in this site with fixed solar angle in this case study, Koh Mak. However, the monthly adjustment tilted angle is recommended as shown in Table 4, where θ represents the latitude of the location under consideration.

The cost of electricity (COE) is defined as the average cost per kWh of useful electrical energy produced for a whole lifetime by a facility installation. It helps enable an investor to decide in

different technologies. There are various methods to determine the economic feasibility of any configurations in electricity generation. The COE method is one of the most frequently used and can be compared in different renewable technologies. The NPC is the main simulation criteria to determine the optimization of the hybrid PV/diesel system. A didactic optimal of hybrid PV/diesel system can be described in Fig. 1. The present value for establishing and operating the system is used in this calculation. This method uses the discount cash flow (DCF) techniques (van Alphen et al., 2007). DCF is achieved by calculating the net present value cash flows using a discount rate. Annual interest rate is determined in Eq. (2);

$$\text{Annual real interest rate } i = \frac{i' - f}{1 + f} \quad (2)$$

where i' is the nominal interest rate, while f is the annual inflation rate and the real interest rate used in this study is 6.3%. HOMER software ranks the optimized systems based on the total net present cost to find the least cost of total net present of the renewable-integrated system, the net present cost is in Eq. (3);

$$\text{NPC} = \frac{C_T}{\text{CRF}(i, n)} \quad (3)$$

where NPC is the total annualized cost, C_T is the sum of annual capital cost, including annual operating maintenance cost while $\text{CRF}(i, n)$ is the capital recovery factor, which takes account the effect of the annual real interest rate and the project lifetime year n , in Eq. (4);

$$\text{CRF}(i, n) = \frac{i(1+i)^n}{(1+i)^n + 1} \quad (4)$$

The output power of a PV array can be calculated from the PV specification (Adaramola et al., 2014a; Shaahid et al., 2014) as in Eq. (5);

$$P_{pv} = Y_{pv} f_{pv} \left(\frac{\bar{G}_T}{G_{T,STC}} \right) [1 + \alpha_p (T_c - T_{c,STC})] \quad (5)$$

where Y_{pv} is the rated capacity of the PV array (kW), that is the power output under standard test condition; f_{pv} is the PV derated factor (%), \bar{G}_T is the solar radiation incident on the PV array in the current time step (kW/m^2), $G_{T,STC}$ is the global radiation at standard test conditions ($1 \text{ kW}/\text{m}^2$), α_p is the PV module maximum temperature coefficient ($\%/^{\circ}\text{C}$), T_c is the PV cell temperature in the current time step ($^{\circ}\text{C}$) and $T_{c,STC}$ is the operation PV module temperature under standard test conditions (STD) at 25°C .

In a case where the effect of temperature on the PV array performance is neglected, α_p can assume to be zero and output power of a PV array can be reduced as in Eq. (6);

$$P_{pv} = Y_{pv} f_{pv} \left(\frac{\bar{G}_T}{G_{T,STC}} \right) \quad (6)$$

4. Solar resources assessment and site location

The resource assessment in this study of the solar energy integrated system is investigated. The Koh Mak island is located at $11^{\circ}49'$ in N latitude and $102^{\circ}29'$ in E longitude (Fig. 2). The solar irradiation, and surface annual solar radiation data have been obtained from NASA website. The scaled average annual of daily solar radiation in this region is $4.93 \text{ kWh}/\text{m}^2/\text{day}$. The clearness index used at the input parameter for HOMER. The average clearness index in this island is annually of 0.504 (Fig. 3). Solar radiation is available throughout with about 12 h of sunshine

Table 4Recommended optimum tilt angle (β) for maximum solar tracking for the location.

Source: Idowu (2013) and Ayodele and Ogunjuyigbe (2015).

Jan	Feb	Mar	Apr	May	Jun	Jul	Aug	Sep	Oct	Nov	Dec
$\theta + 25$	$\theta + 25$	θ	θ	$\theta - 25$	$\theta - 25$	$\theta - 25$	$\theta - 15$	$\theta + 15$	$\theta + 15$	$\theta + 25$	$\theta + 25$

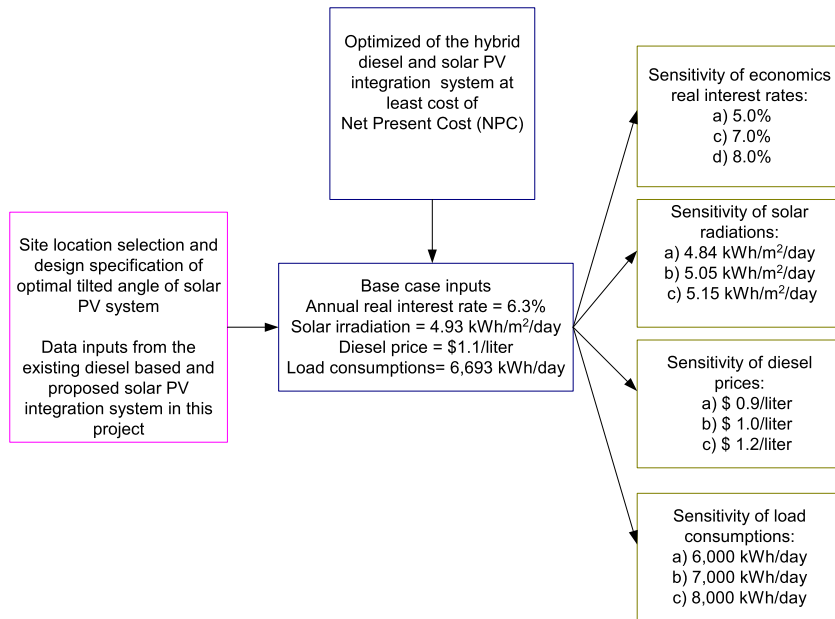
**Fig. 1.** Optimal methodology of diesel/PV hybrid system.

per day, however, it varies in each season. Considerably, this island has potential to install solar panels for hybrid energy system with diesel-based installation. This island, with the areas of 16 km², is located 35 km far from the mainland in Trat province, eastern coast of Thailand. So the electricity is only supplied by micro-grid diesel generators. This island is famous for tourist destinations where the activities mostly including diving, water sports and bicycling around this island are the most activity for tourists. The permanent habitants are only 350–400 persons, but a large number of visiting tourists are high in summer season, therefore the electricity consumption in this island is increasing every year. The main load demands of energy consumptions are in hotels, resorts and bungalows. The electricity loads are air conditionings, hot water electric-makers, cooking preparation processes, lightings, and other electricity equipment. The load has been historically statistically estimated at 6693 kWh/day with the peak demand at 850 kW. Electricity supply mostly comes from four units of diesel generators. The existing two units of 500 kW and with two units of 300 kW of diesel generators consumed 829,005 l/yr of diesel fuels at the average fuel consumption rate of 2.962 kWh/l (PEA, 2014). Figs. 4 and 5 show daily energy and monthly average load consumptions profiles in Koh Mak island.

5. The case study of electricity generation in Thailand's remote island

5.1. Electricity system assessment

The existing electricity generation is a diesel-based system. The system consists of four diesel generators with total capacity of 1600 kW (2 × 500 kW, and 2 × 300 kW), to meet peak demand in this island. The system supply electricity demand for nearly 365 days a year. Four sets of diesel engines have been installed since 2010, the initial cost of generators and the replacement

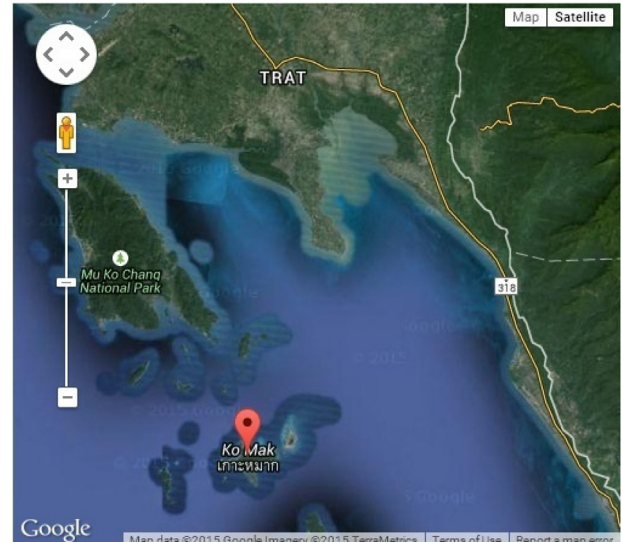
**Fig. 2.** Koh Mak island located in eastern coast of Thailand. Source: Google maps, 2015.

cost is approximately \$500/kW (Lau et al., 2015). The lifetime of diesel engines was 60,000 operating hours. Two old diesel engines with each rated capacity of 500 kW have operation and maintenance costs of \$0.02/h/kW, while the new two diesel engines with each rated capacity of 300 kW have operation and maintenance costs of \$0.015/h/kW. The cost of diesel fuel price in this island is statistically averaged of \$1.0–1.1/l. This includes the transportation cost of diesel fuel from the mainland of Trat province to this island. Fig. 6 shows proposed hybrid diesel/PV with battery storage. Table 5 shows detailed components and cost of hybrid diesel/PV with battery storage.

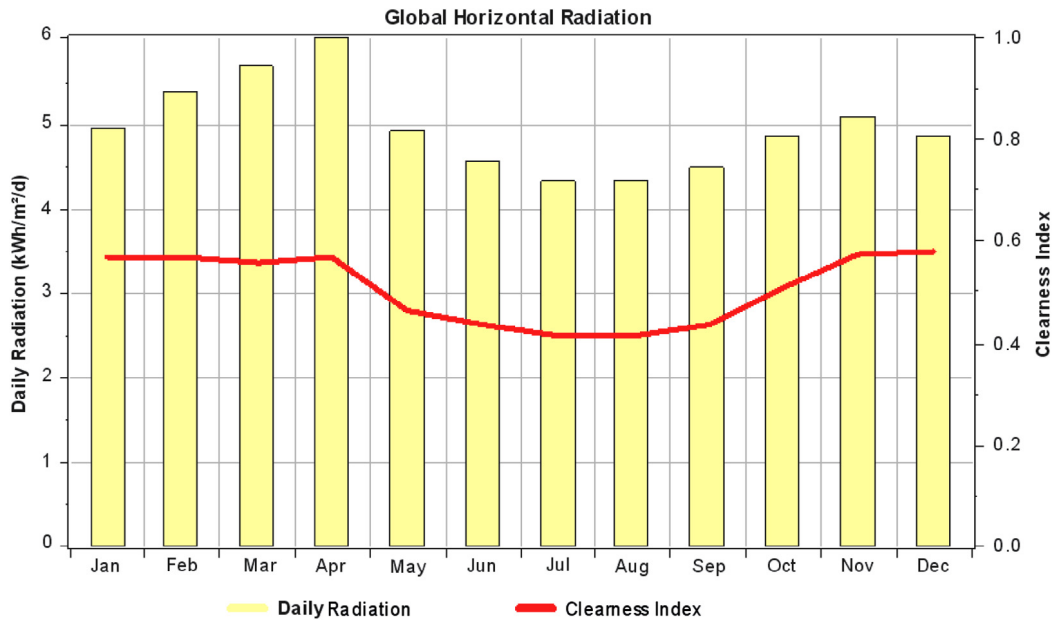

Fig. 3. Solar irradiation and cleanness index in Koh Mak island. Source: HOMER software.

Table 5 Data of selected system components.

Description	Data
PV panel	
Size	100–1000 kW with step sizes of 50 kW
Capital cost/replacement cost	\$2200/kW
Operating and maintenance cost	\$10/yr
Lifetime	25 yr
Inverter	
Size	100–800 kW with step sizes of 50 kW
Capital cost/replacement cost	\$550/kW
Operating and maintenance cost	\$10/yr
Lifetime	15 yr
Efficiency	90%
Battery	
Battery type	Surrette 6CS25P
Nominal voltage (2 batteries per string)	6 V (12 V)
Size	40–400 batteries with step sizes of 40 batteries
Nominal capacity	1156 Ah
Minimum state of charge	40%
Capital cost/replacement cost	\$1100/kW
Operating and maintenance cost	\$10/yr
Lifetime throughput	9645 kWh
Diesel generator	
Number of generators	4 units
Size	2 units of 500 kW, 2 units of 300 kW
Capital cost/replacement cost	500/kW
Operating and maintenance cost	\$0.02/h/kW for 500 kW units (old units) and \$0.015/h/kW for 300 kW units (new units)
Lifetime	60,000 h

5.2. PV panels and cost of the system

The PV array sizes varied from 100 to 1000 kW with a 50 kW-step sizes inputs in HOMER model. This proposed hybrid system is to be ensured that HOMER software can optimize the least net present cost. The PV system cost and its replacement cost are set to \$2200/kW. However, the cost of hybrid diesel/PV is varied from many literature reviews from \$3500/kW (Li and Yu, 2016) to \$2500/kW (Brandoni and Bo, 2016), or as low as \$1400/kW (Baneshi and Hadianfard, 2016). The cost of PV system in residential solar rooftop in Thailand is varied between \$2960/kW and \$2120/kW (Tongsopit, 2015). However, in a small scale of solar PV rooftop (with the capacity less than 10 kW) the PV system cost can be invested as low as \$2020/kW (Chaianong and Pharino, 2015). The cost of solar PV system in off-grid configuration

in remote areas is expected higher than the cost of residential solar rooftop configuration. In this study also proposed the variation of the cost of PV system with the capital multiplier cost factors of 0.8–1.1. The solar module type is polycrystalline PV panels used in this study. The characteristics of solar panels are shown in Table 6. The system cost includes PV module cost, balance of system cost, installation cost and labors cost. The de-rating factor and the ground reflectance are taken as 80% and 20%, respectively. To ensure reliable electricity supply, the solar energy output and the operating reserve as a percentage of hourly loads in this system were set at 25% and 10%, respectively (Lau et al., 2015). Fig. 7 shows electricity generation and electricity cost with variation of PV capital cost multipliers (the multiplier varying 0.8–1.1 means the capital cost of the system varying with \$1760/kW–\$2420/kW).

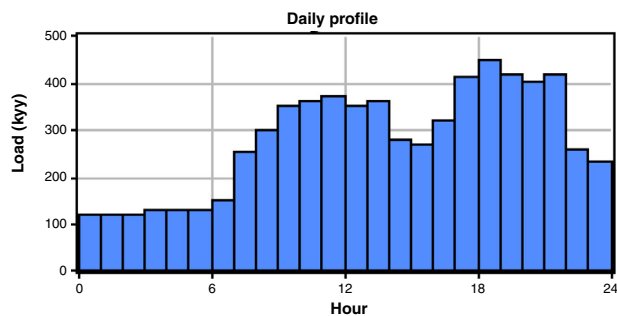

Fig. 4. Daily average energy load consumption profiles at Koh Mak island. Source: PEA (2014).

Table 6

Specification of PV module.

Source: Photovoltaic module Suntech (2015).

Item	Specification
Manufacturer	SUNTECH
PV model	STP275–24/Vd, Polycrystalline
Maximum power at STC (Pmax)	275 Wp
Module efficiency	14.2%
Maximum power voltage (Vpm)	35.1 V
Maximum power current (Ipm)	7.84 A
Open circuit voltage (Voc)	44.7 V
Short circuit current (Isc)	8.26 A
Temperature coefficient (Pmax)	−0.47%/°C
Temperature coefficient (Voc)	−0.34%/°C
Temperature coefficient (Isc)	0.045%/°C
Maximum system voltage	1000 V DC
Power tolerance (−/+)	0/+5 W
Module area	1.94 m ²
Dimension L × W × H	1956 mm × 992 mm × 50 mm
Weight	27 kg
Operating temperature	−40 °C to +85 °C

5.3. DC–AC inverters

The function of an inverter is to convert electric power from direct current (DC) to alternative current (AC). Both the initial cost and the replacement cost of inverter in this study are set to \$550/kW, with its operation and maintenance costs of \$10/yr (Lau et al., 2015). The efficiency of an inverter is 90% with its lifetime of 15 yr. The size of inverter in the hybrid diesel/PV system is varied according to PV arrays sizes, i.e. 100–800 kW with a 50 kW-step sizes.

5.4. Batteries

The Surrete 6CS25P batteries by Rolls Battery Engineering are used in HOMER simulation as in the proposed hybrid diesel/PV system. It is a 6 V battery with a nominal capacity of 1156 Ah (6.94 kWh). The lifetime of battery is 9645 h. The size of battery in the hybrid diesel/PV system is varied according to PV array size, i.e. 40–400 units with a 40 unit-step sizes. The battery efficiency is 80%, and a minimum state of the charge of 40%. The battery cost in each unit is estimated at \$1100 (Lau et al., 2015).

5.5. Economic parameters

The lifetime electricity production of this system is 25 yr (Das et al., 2016). The determinant factors to evaluate the economic feasibility optimal of hybrid diesel/PV are net present cost (NPC) and the cost of electricity (COE). PV modules which are the keys component of PV systems and warranted for the minimum of 25 yr through the lifetime of this project (Maatallah et al., 2016). The discount rate for this study is set to 6.3% (World bank, 2015).

However, in sensitivity analysis, the real annual interest rate is set varying from 5% to 8%. The infrastructure costs and other costs for hybrid diesel/PV system are expected with an additional initial installation cost of \$12,000. The extent cost is due to its various civil construction cost, land and transportation cost, administration and other miscellaneous costs.

6. Results

6.1. Stand-alone diesel system

A system simulation was performed from the aforementioned assumptions. The diesel-only system is not sustainable when compared to hybrid diesel/PV system. From existing diesel-only case, it uses 805,587 l of diesel fuels (diesel price at \$1.1/l) for four diesel generators to supply daily load demand of 6693 kWh/day with the peak at 850 kW. The COE and NPC for this case are \$0.429/kWh and \$13,044,926 respectively. Consequently, this leads to the harmful environmental pollutant missions. The emissions of carbon dioxide are 2385.42 ton/yr and emissions of other pollutant gases are 64.31 ton/yr. Diesel consumption, energy production and pollutant emissions in the base case are shown in Table 7.

6.2. Hybrid diesel/PV system without battery

In the Hybrid diesel/PV without battery is meant that the excess electricity produced in this configuration cannot be stored. Consequently, the four diesel engines are therefore necessary supplying electricity for the whole demands at the night time. The PV panels produce electricity at a share of 38% or 1,071,903 kWh/yr, and the additional electricity of 1,733,190 kWh/yr is supplied by diesel generators. For this optimization scenario the system consists of 800 kW of PV, 400 kW power inverter and the system consumes diesel fuel of 680,050 l/yr for four diesel engines as the most techno-economical configuration. In this optimization scenario, the minimized total NPC is investigated as presented in Table 8. From this scenario, it generated excess electricity with 282,414 kWh/yr, or 10.1% of total electricity generation. The COE and NPC for this case are \$0.402/kWh and \$12,217,181 respectively. It reduces diesel consumption of 225,807 l/yr, or 24.9% lower than the existing diesel-only system. It also decreases emissions of carbon dioxide of 594.624 ton/yr, and other pollutant gases of 16.032 ton/yr.

6.3. Hybrid diesel/PV system with battery

The optimization scenario of hybrid diesel/PV system with battery is proposed to this island. This system consists of 850 kW PV, 1600 kW of four diesel engines with fuel cost of \$1.1/l (Shezan et al., 2016; PEA, 2014), and 500 kW power inverter, and 80 units of battery bank. This system produces electricity from solar energy at a share of 41% or 1,138,905 kWh/yr, and the additional electricity 1,645,452 kWh/yr is supplied by diesel generators. This optimal case has total NPC \$11,377,457 and the excess electricity of 221,391 kWh/yr or 7.95% of total electricity generation. In case of increase of battery storage to 160 units, the excess electricity reduces to 134,585 kWh/yr or 4.91% of total electricity. However, it has higher costs for both NPC and COE due to the increasing cost of battery storage compared to the optimal case of using 80 units of battery storage. The COE for this optimal hybrid system is \$0.374/kWh, and it is the lowest cost of electricity compared to diesel-only system and diesel/PV system without battery system. Consequently, this scenario can generates electricity with the least cost of diesel consumptions in four diesel engines. It consumes diesel fuel only 603,347 l/yr, and it can reduce

Table 7

Monthly diesel consumption, load and electricity generation, in diesel based generation.

Source: PEA (2014).

Month	Demand load (kW)	Diesel consumption (l)	Electricity generation (kWh)	Fuel rate consumption (kWh/l)	Carbon dioxide emissions (kg)
January	650	85,415	281,600	3.296	247,732.8
February	650	81,430	235,976	2.898	207,595.9
March	650	93,855	267,311	2.848	235,162.4
April	850	87,875	290,392	3.305	255,467.5
May	680	76,145	241,387	3.170	212,356.2
June	350	47,060	148,387	3.153	130,541.0
July	460	46,185	146,372	3.169	128,768.3
August	310	49,065	145,549	2.966	128,044.3
September	320	44,660	149,553	3.348	131,566.7
October	470	63,865	138,678	2.171	121,999.6
November	560	76,200	207,274	2.720	182,345.8
December	630	77,250	203,095	2.629	178,669.4
Total (annual)		829,005	2,455,574	2.962	2,160,250.0

Table 8

Techno-economic details in optimal scenarios in comparisons.

Source: PEA (2014).

Items	Unit	Diesel-only	Diesel/PV system	Diesel/PV/battery system
Solar PV	kW	–	800	850
Diesel generators (each unit)	kW	2 × 500 and 2 × 300	2 × 500 and 2 × 300	2 × 500 and 2 × 300
Batteries-Surrette 6CS25P	–	–	80	80
Converter	kW	–	400	500
Total capital cost	\$	550,000	1,992,000	2,245,000
Total NPC	\$	13,044,926	12,217,181	11,377,457
Total annual capacity cost	\$/yr	Existing system	159,998	180,319
Total annual replacement cost	\$/yr	4446	54,118	63,974
Total O&M cost	\$/yr	54,612	52,664	43,663
Total fuel consumption	L/yr	905,857	680,050	603,347
Total fuel cost	\$/yr	996,442	748,054	663,682
Total annual cost	\$/yr	1,047,769	981,284	913,838
Operating cost	\$/yr	1,047,769	821,287	733,519
LCOE	\$/kWh	0.429	0.402	0.374
PV production	kWh/yr	0	620,057	1,138,905
Diesel Gen production	kWh/yr	2,451,367	1,733,190	1,645,452
Total electricity production	kWh/yr	2,451,367	2,805,093	2,784,357
AC primary load served	kWh/yr	2,442,939	2,442,939	2,442,939
Renewable fraction	%	0	38	41
Unmet load	%	0	0	0
Excess electricity	kWh/yr	8425	282,414	221,391

Table 9

Pollutant emissions summary in optimal scenarios in comparisons.

Pollutant emissions	Unit	Diesel-only	Diesel/PV system	Diesel/PV/battery system
Carbon dioxide	kg/yr	2,385,419	1,790,795	1,588,813
Carbon monoxide	kg/yr	5,888	4,420	3,922
Unburned hydrocarbons	kg/yr	652	490	434
Particulate matter	kg/yr	444	333	296
Sulfur dioxide	kg/yr	4,790	3,596	3,191
Nitrogen oxides	kg/yr	52,540	39,443	34,994

diesel fuel consumption of 302,510 l/yr, or 33.4% lower than the diesel-only system. The system can decrease emissions of carbon dioxide of 796.61 ton/yr and other pollutant gases emissions of 21.47 ton/yr. Table 8 shows the results of techno-economic details in the optimal cases for comparisons, in three scenarios (diesel/PV with and without battery storage systems, and diesel-only system). Table 9 shows pollutant emissions in this hybrid diesel/PV system with battery storage compared with the two other scenarios. Fig. 8 shows the cash flow summary of optimal hybrid diesel/PV with battery storage system as a function of different cash flows. In this hybrid PV/Diesel with battery, the additional capital cost comes from an increasing PV array installation such as inverters, PV panels, and battery storage, while fuel cost comes from fuel consumption of diesel generators. Fuel cost is the most cost as high as 73% of total NPC costs. The financial and economic results are more significant in case of variation of PV system costs.

7. Sensitivity analysis

In this section, various variation scenarios have been studied. The hybrid of diesel/PV with battery storage system is set from the previous diesel-only system. The variations in this study are global solar radiations, cost of diesel prices, real interest rates and load consumptions. The results of variations under any various assumptions calculated by authors with the simulation with HOMER software as presented in Figs. 7–15.

7.1. Solar radiations

Global solar radiation affects the variations of renewable energy penetration rates, and COE and NPC for hybrid diesel/PV with battery system. Thus, the harvesting of solar energy in the hybrid power system depends on the global solar radiation received and the efficiencies of the PV panels. In

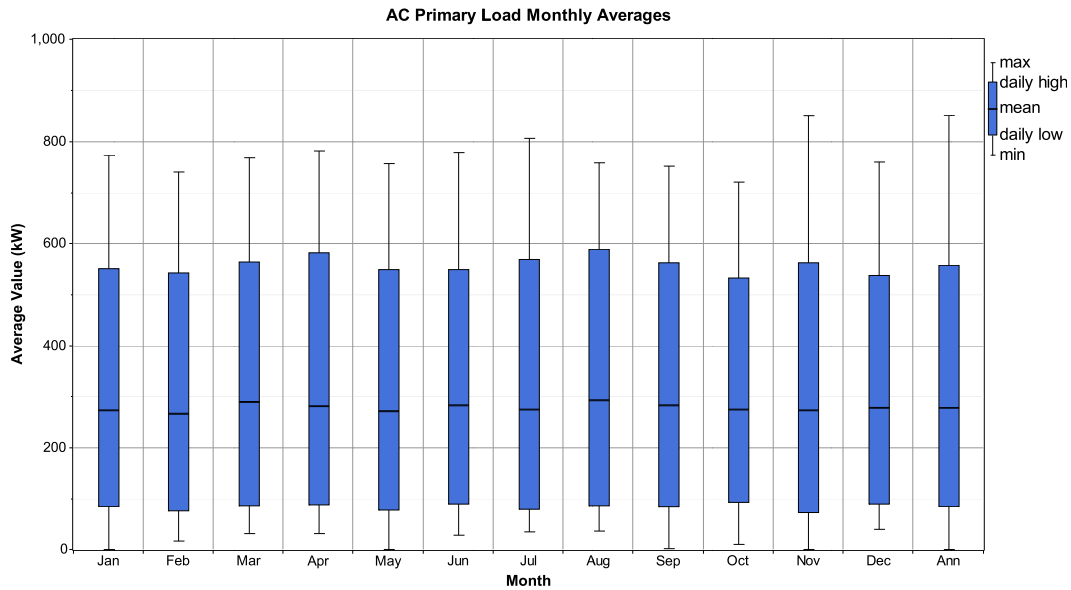

Fig. 5. Monthly average of AC primary load consumption in system. Source: PEA (2014).

this study, the variations of global solar radiation are set to 4.84, 4.93, 5.05, 5.15 kWh/m²/day, where solar radiation 4.93 kWh/m²/day used for the base case. Consequently, the increasing solar radiations makes renewable shares varying at 42%, 41%, 42%, 42% respectively. The PV installation system needs solar array of 900 kW with solar radiation of 4.84 kWh/m²/day. When solar radiation is as high as 4.93, 5.05, 5.15 kWh/m²/day, the PV array installation penetration in this system will decrease to 850 kW in hybrid system configurations. The NPC decreases with \$11,413,617, \$11,377,457, \$11,324,399, \$11,276,088 and also COE decreases with \$0.375/kWh, \$0.374/kWh, \$0.372/kWh, \$0.371/kWh respectively, when solar radiations vary from 4.84 to 5.15 kWh/m²/day. Fig. 9 shows the graph of total net present cost and the electricity cost, with the variation of solar radiations.

7.2. Diesel prices

The variations of diesel prices are set from \$0.9/l to \$1.2/l. Diesel price directly affects the NPC, COE, and renewable shares in the system. The COE increasingly varies with \$0.322/kWh, \$0.349/kWh, \$0.374/kWh, \$0.399/kWh respectively, when diesel price increases from \$0.9/l to \$1.2/l. The shares of renewable increase from 33% to 43% when diesel prices increase. The NPC also increases from \$9,806,956 to \$12,122,013 due to the costs of diesel. However, in the optimal condition of this system with solar radiation potential of 4.93 kWh/m²/day in this location when diesel price is at \$0.561/l or lower, the hybrid diesel/PV system with battery storage from PV system price of \$2200/kW cannot compete with the diesel-only existing system. In this diesel-only system, the total electricity generation 2,451,367 kWh/yr from four diesel generators needs for the demand load. The COE of diesel-only system when diesel price at \$0.561/l are \$0.229/kWh and its NPC \$6,966,037, respectively. However, in this scenario at diesel price \$0.561/l leads to higher total pollutant emissions. The pollutant emissions mainly come from carbon dioxide 2,385.42 ton/yr, and from other pollutant gases emissions of 64.31 ton/yr due to the higher diesel consumption of 905,857 l/yr. Fig. 10 shows of the effect of variations of diesel prices and real interest rates on electricity cost and total annualized cost. Fig. 11 shows the plot of total annualized cost and real interest rate with variation of diesel prices.

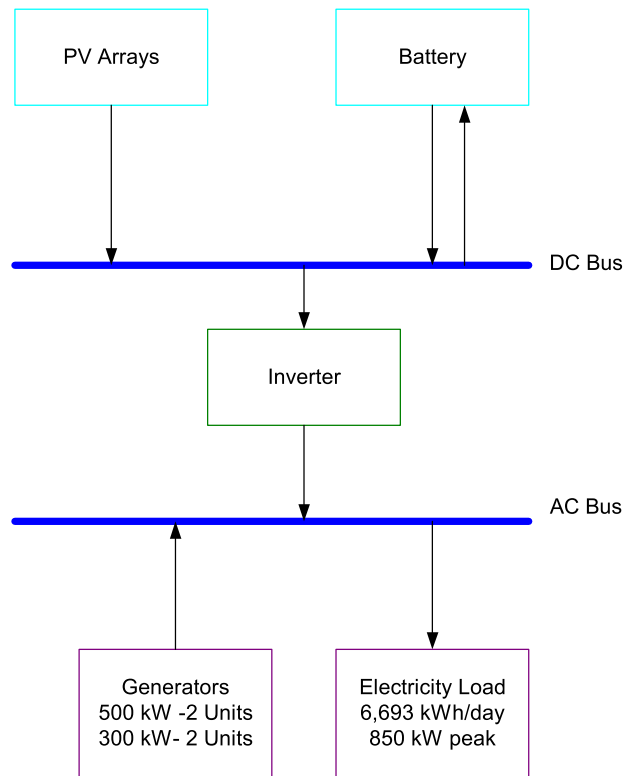

Fig. 6. Proposed of Hybrid diesel /PV /Battery system.

7.3. Real interest rates

The variations of real interest rates affect the NPC and COE linearly. In this study, the real interest rates have been set varying from 5% to 8%, where 6.3% using for the base case. The COE in this system increases from \$0.350/kWh to \$0.385/kWh, while a real interest rate increases. However, the net present cost in diesel/PV with battery storage system is inversely with the real interest rates. The net present cost decreases from \$12,565,31 to \$10,045,188, when a real interest rate increases. The renewable share also decreases when real interest rates increases. The renewable share

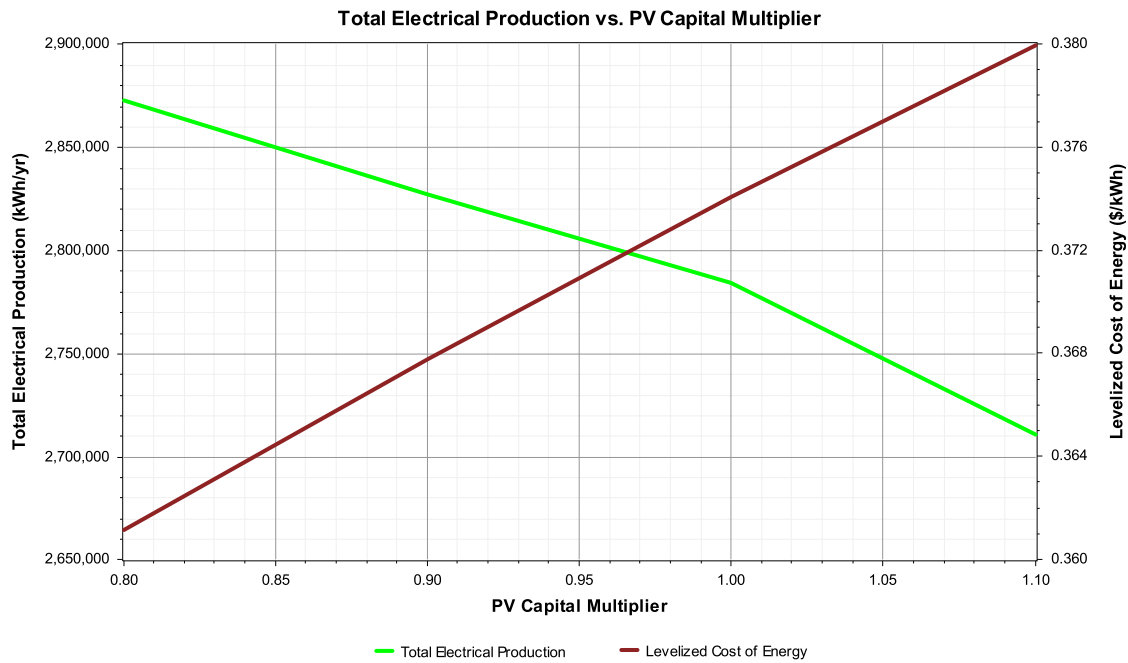

Fig. 7. Total electricity generation and electricity cost with variation of PV capital cost multipliers.

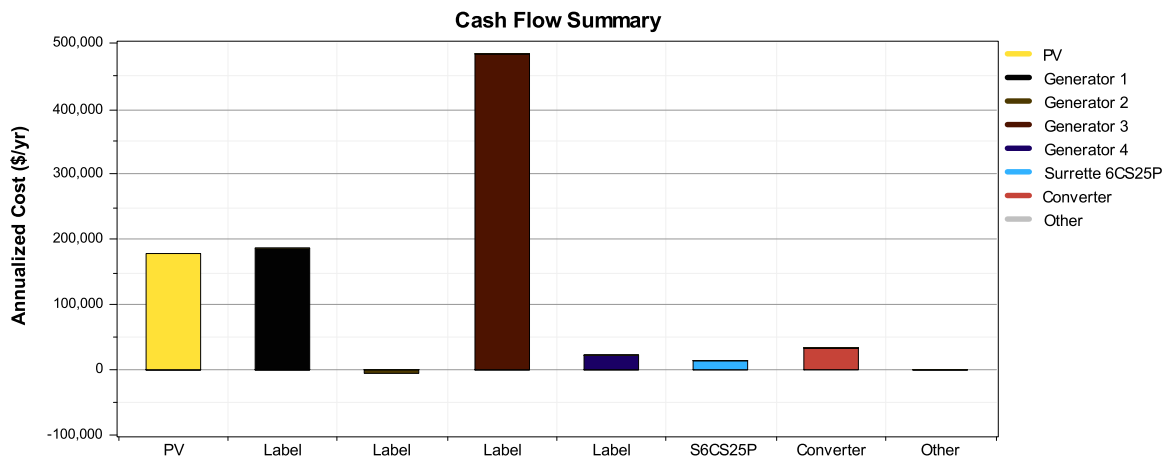

Fig. 8. Cash flow diagram of optimal hybrid Diesel/PV/Battery system.

decreases from 43% to 35%, when a real interest rate increases. Fig. 12 shows the plot of diesel price and electricity cost with variation of real interest rates. Fig. 13 shows the net present cost and electricity cost with the variation of interest rates.

7.4. Load consumptions

The electric load consumptions in this study are collected from site visiting data in 2014 and data from Provincial Electricity Authority (PEA, 2014). In this island, the load consumptions are varied with a number of visiting tourists. The load of energy demands are also varied in each season. The peak demand in the island occurred in April, while the lowest demand occurred in August. The low demand of electricity consumption occurs in low season of visiting tourists due to the rains from the southwest monsoon. In this study, the variations of load consumption affect the variation of solar PV installation between 850 and 950 kW in hybrid of diesel/PV with battery. The proposed load variations are 6000, 7000, and 8000 kWh/m²/day, where 6693 kWh/m²/day

is used for the base case. In case of higher load consumption, the hybrid diesel/PV system needs more diesel fuel for generate electricity. The total NPC cost of diesel/PV with battery system has increased from \$10,401,090 to \$13,280,304 when the load increases from 6000 kWh/m²/day to 8000 kWh/m²/day. Also, when the loads increase, the share of renewable energy decreases from 41% to 39%. Consequently when the load increases, the COE decreases from \$0.381/kWh to \$0.365/kWh, respectively. Figs. 14 and 15 show of the effect of various load consumptions with diesel consumption and total annualized cost respectively.

8. Conclusion

The study of viability of hybrid diesel/PV with battery system for isolated island in Thailand is feasible based on the net present cost (NPC) and cost of electricity (COE). This study shows that the hybrid system reduces NPC and COE. The hybrid system can also reduce all air pollutants for sustainable electricity in the rural island. The optimal hybrid diesel/PV with battery system

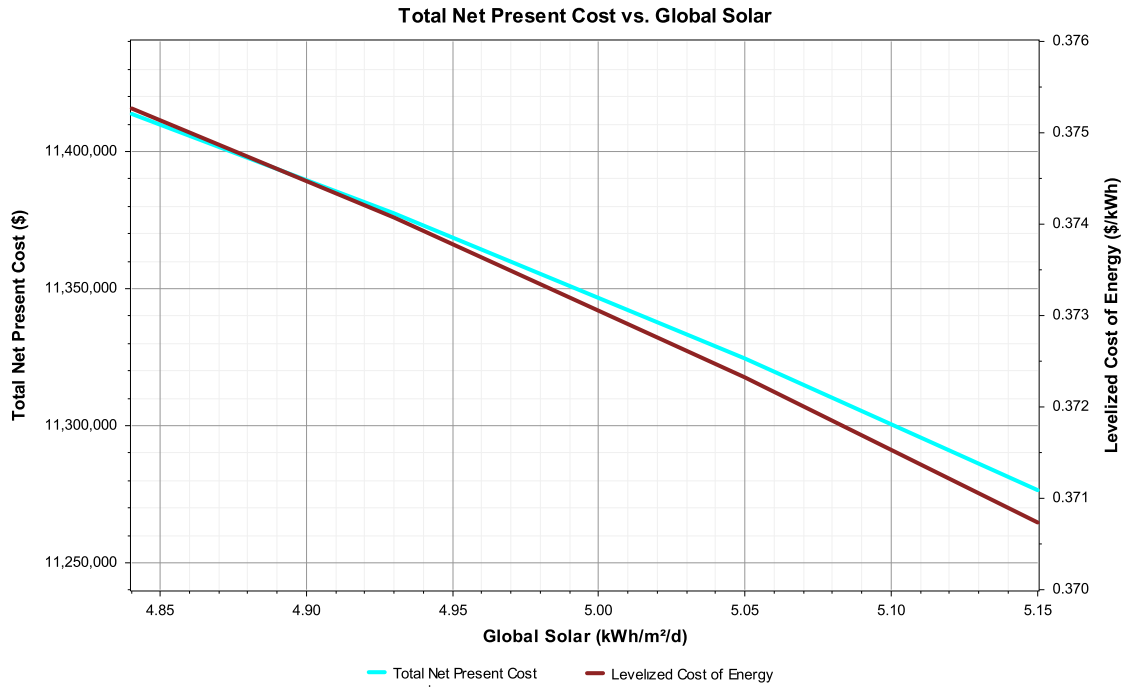

Fig. 9. Total net present cost and electricity cost with variation of solar radiations.

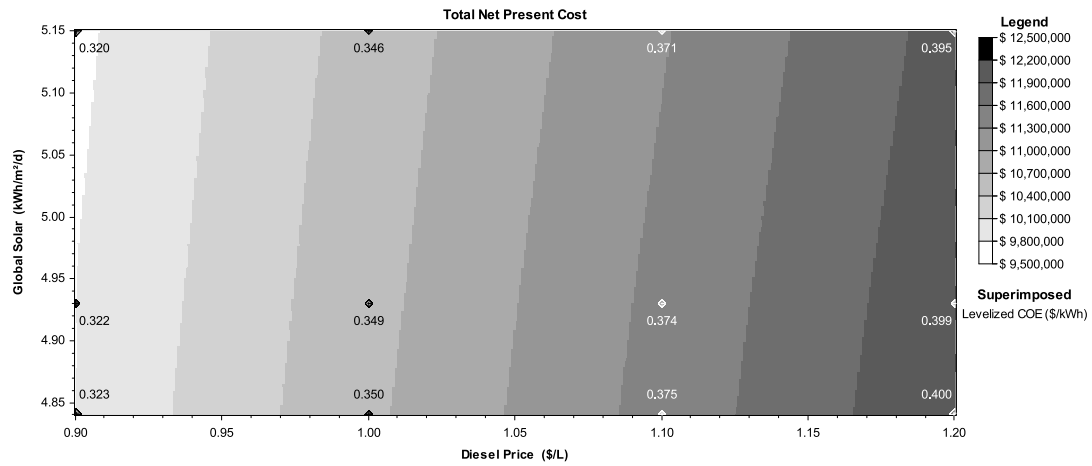

Fig. 10. Surface plot of total net present cost and solar radiation with variation of diesel prices.

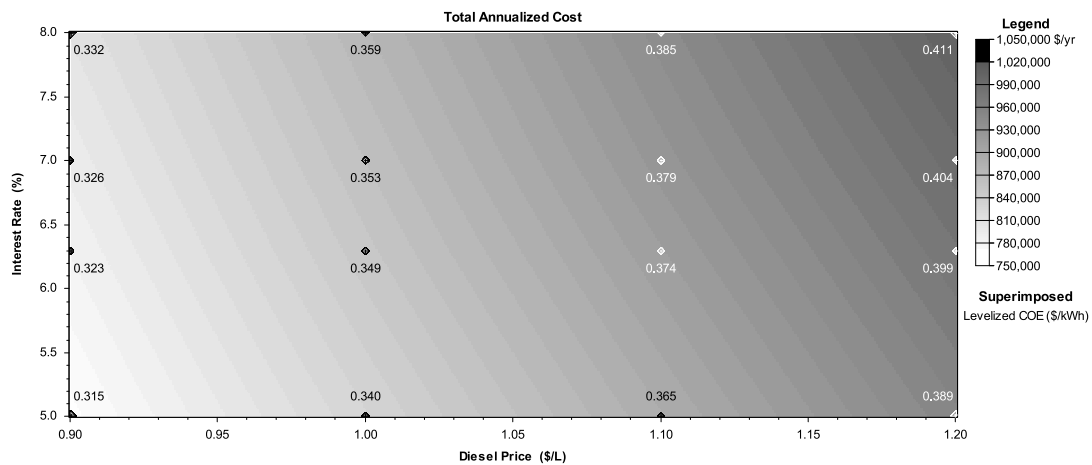

Fig. 11. Surface plot of total annualized cost and real interest rate with variation of diesel prices.

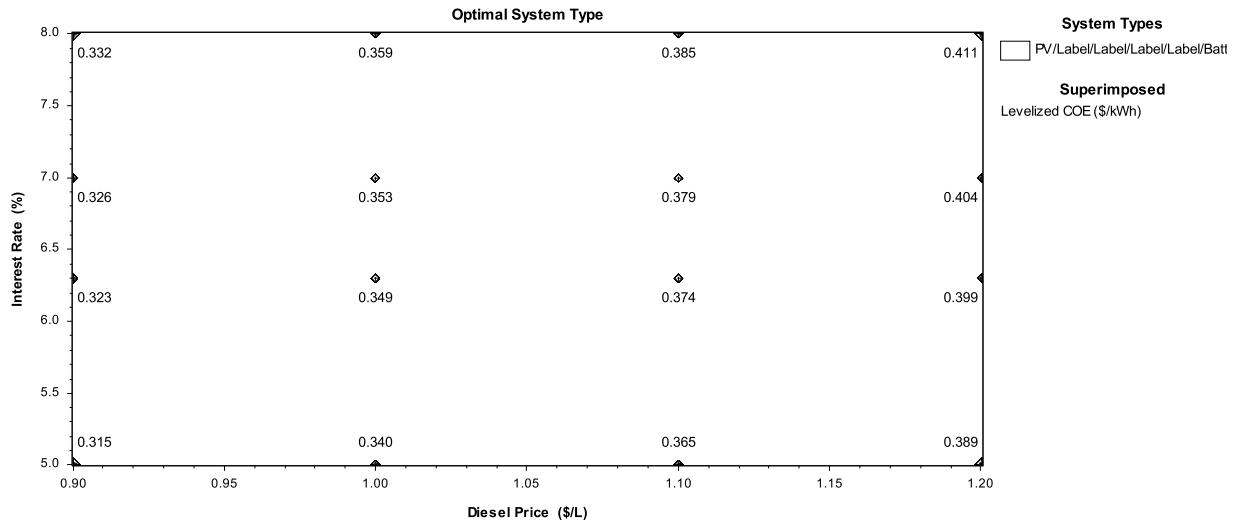

Fig. 12. Optimal system plot of diesel price and electricity cost with variation real interest rates.

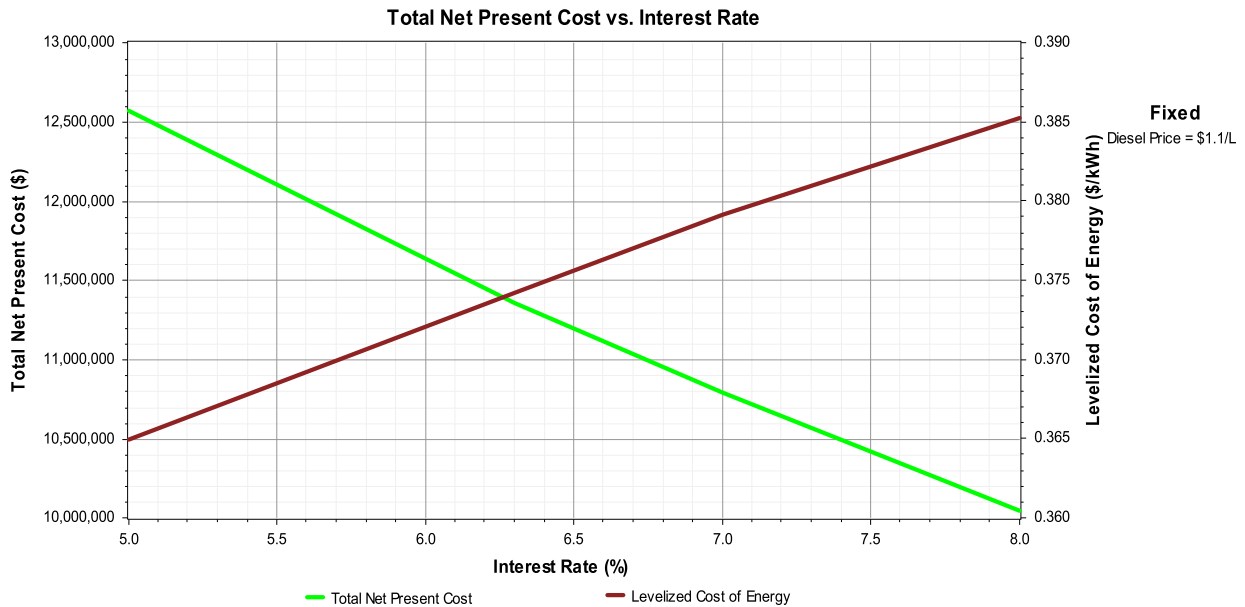

Fig. 13. Total net present cost and electricity cost with variation of interest rates.

shows that solar resources share as high as 41% in total electricity generation. The COE of this optimal case is \$0.374/kWh, reducing from \$0.429/kWh in the existing diesel-only system. The NPC of this optimal hybrid of diesel/PV with battery storage system is \$11,377,457, at the real interest rate of 6.3% and at solar radiation of 4.93 kW/m²/day. The effect of battery storage system has significantly increased PV share from 38% to 41% when using 80 units of battery compared with PV/diesel no battery system. Also, the system with battery storage can reduce excess electricity from 10.1% to 7.95% when compared with the system without battery storage. The additional of 80 units of more battery storage in this PV/diesel with battery system can reduce excess electricity from 7.95% to 4.91%, however it increases the capital cost of the system. The reduction of pollution emissions in this system is also a significant point of views. The hybrid diesel/PV system with battery decreases pollution emissions of 796.61 ton/yr of carbon dioxide,

and 21.47 ton/yr of other pollution emission gases compared with the diesel-only system. The diesel fuels consumption reduces 302,510 l/yr in the hybrid diesel/PV system with battery compared to the existing diesel-only system. So, the hybrid diesel/PV system is a sustainable energy development in the remote island because it combines solar energy resources with the conventional fuels, and it can reduce total emissions significantly.

Acknowledgments

Authors would like to thank the Joint Graduated School of Energy and Environment (JGSEE), King Mongkut's University of Technology Thonburi (KMUTT) (SIIT5522300101) for grant scholarship in this study. Authors also would like to acknowledge the Provincial Electricity Authority (PEA) for providing of valuable data in Koh Mak island in this study.

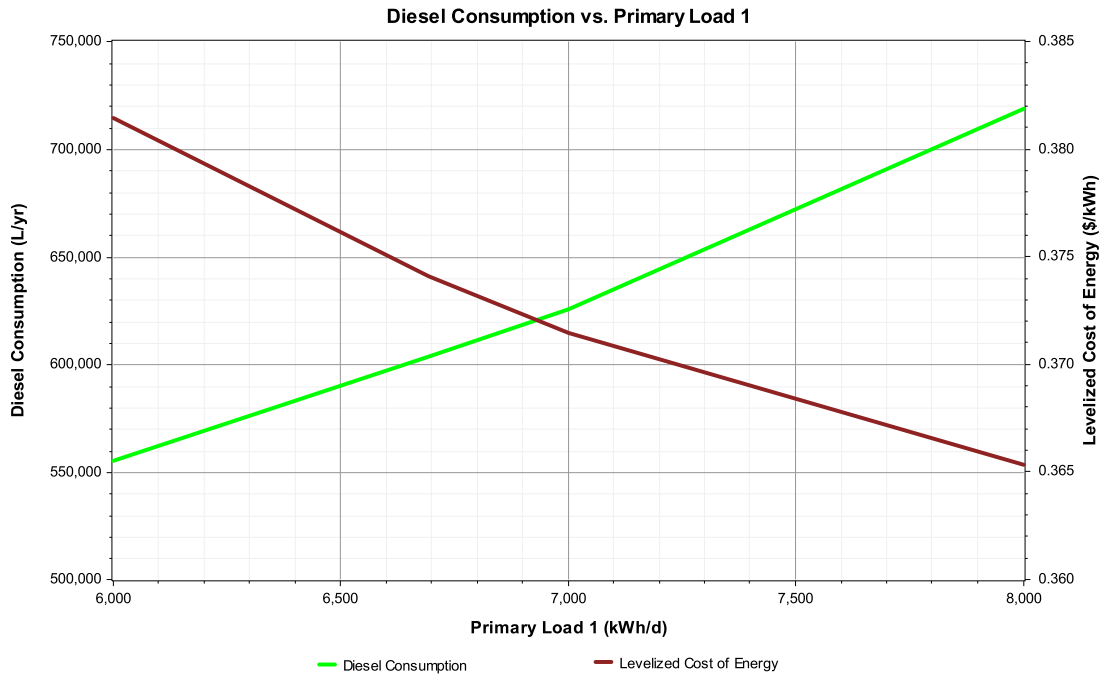

Fig. 14. Total diesel fuel consumption and cost of electricity with variation load consumptions.

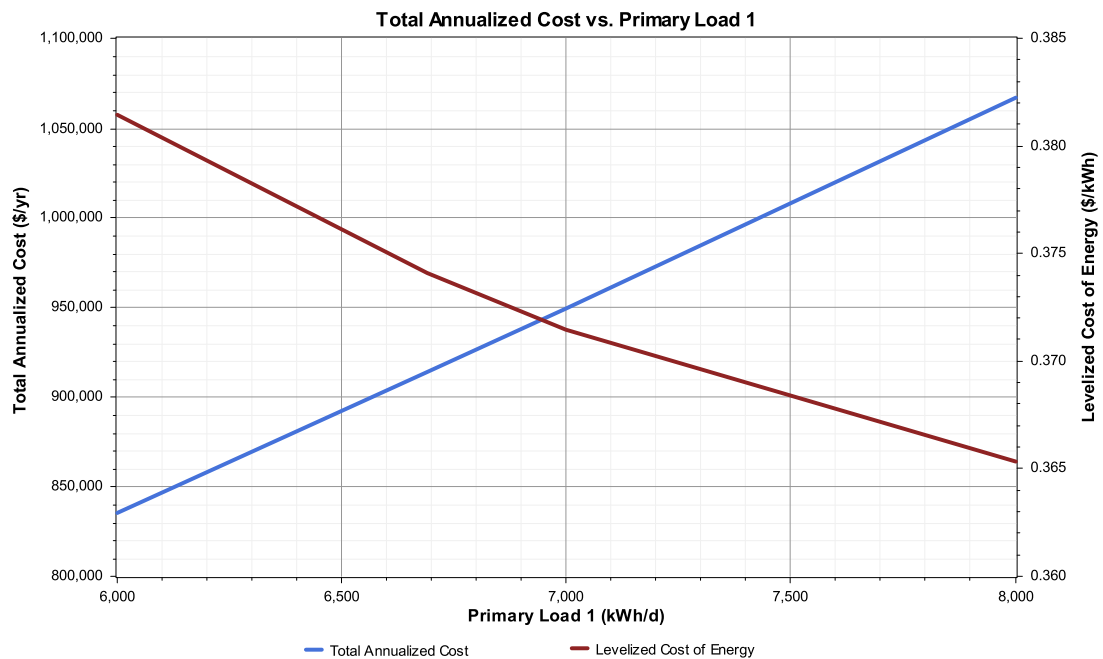

Fig. 15. Total annualized cost and cost of electricity with variation of load consumptions.

References

Adaramola, M.S., Agelin-Chaab, M., Paul, S.S., 2014a. Analysis of hybrid energy systems for application in southern Ghana. *Energy Convers. Manage.* 88, 284–295. <http://dx.doi.org/10.1016/j.enconman.2014.08.029>.

Adaramola, M.S., Paul, S.S., Oyewola, O.M., 2014b. Assessment of decentralized hybrid PV solar-diesel power system for applications in Northern part of Nigeria. *Energy Sustain. Dev.* 19, 72–82. <http://dx.doi.org/10.1016/j.esd.2013.12.007>.

Ayodele, T.R., Ogunjuyigbe, a.S.O., 2015. Increasing household solar energy penetration through load partitioning based on quality of life: The case study of Nigeria. *Sustain. Cities Soc.* 18, 21–31. <http://dx.doi.org/10.1016/j.scs.2015.05.005>.

Ayompe, L.M., Duffy, A., 2014. An assessment of the energy generation potential of photovoltaic systems in Cameroon using satellite-derived solar radiation datasets. *Sustain. Energy Technol. Assess.* 7, 257–264. <http://dx.doi.org/10.1016/j.seta.2013.10.002>.

Bahramara, S., Moghaddam, M.P., Haghifam, M.R., 2016. Optimal planning of hybrid renewable energy systems using HOMER: A review. *Renewable Sustainable Energy Rev.* 62, 609–620. <http://dx.doi.org/10.1016/j.rser.2016.05.039>.

Baneshi, M., Hadianfard, F., 2016. Techno-economic feasibility of hybrid diesel/PV/wind/battery electricity generation systems for non-residential large electricity consumers under southern Iran climate conditions. *Energy Convers. Manage.* 127, 233–244. <http://dx.doi.org/10.1016/j.enconman.2016.09.008>.

Brandoni, C., Bo, B., 2016. HOMER analysis of the water and renewable energy nexus for water-stressed urban areas in Sub-Saharan Africa, pp. 1–14. <http://dx.doi.org/10.1016/j.jclepro.2016.07.114>.

Chaianong, A., Pharino, C., 2015. Outlook and challenges for promoting solar photovoltaic rooftops in Thailand. *Renewable Sustainable Energy Rev.* 48, 356–372. <http://dx.doi.org/10.1016/j.rser.2015.04.042>.

Das, H.S., Yatim, A.H.M., Wei, C., Lau, K.Y., 2016. Proposition of a PV/tidal powered micro-hydro and diesel hybrid system: A southern Bangladesh focus. *Renewable Sustainable Energy Rev.* 53, 1137–1148. <http://dx.doi.org/10.1016/j.rser.2015.09.038>.

- DEDE, 2010. Department of Energy Development and Efficiency, Solar Radiation Maps from Satellite Data for Thailand.
- DEDE, 2012. Department of Alternative Energy Development and Efficiency, Ministry of Energy. The renewable and alternative energy development plan (AEDP 2012–2021), Bangkok, Thailand.
- DEDE, 2013. Department of Alternative Energy Development and Efficiency, Ministry of Energy. Thailand energy statistics (preliminary). Available from <http://www.dede.go.th> (accessed date 15.05.15).
- DEDE, 2015. Department of Alternative Energy Development and Efficiency, Ministry of Energy. Alternative Energy Development Plan (AEDP2015), Bangkok, Thailand.
- EGAT, 2010. Electricity generating Authority of Thailand, Thailand power development plan 2010–2030 (PDP 2010), Bangkok, Thailand.
- EGAT, 2013. Electricity Generating Authority of Thailand, Thailand power supply and peak Demand, Bangkok, Thailand.
- HOMER energy, 2016. Available at: <https://users.homerenergy.com/pages/homer/>.
- Idowu, O., 2013. Determination of optimum tilt angles for solar collectors in low-latitude tropical region. *Int. J. Energy Environ. Eng.* 4, 29. <http://dx.doi.org/10.1186/2251-6832-4-29>.
- IEA, 2013. World energy outlook special report: Southeast Asia energy outlook.
- Lau, K.Y., Tan, C.W., Yatim, a.H.M., 2015. Photovoltaic systems for Malaysian islands: Effects of interest rates, diesel prices and load sizes. *Energy* 83, 204–216. <http://dx.doi.org/10.1016/j.energy.2015.02.015>.
- Lau, K.Y., Yousof, M.F.M., Arshad, S.N.M., Anwari, M., Yatim, a.H.M., 2010. Performance analysis of hybrid photovoltaic/diesel energy system under Malaysian conditions. *Energy* 35, 3245–3255. <http://dx.doi.org/10.1016/j.energy.2010.04.008>.
- Li, C., Yu, W., 2016. Techno-economic comparative analysis of off-grid hybrid photovoltaic/diesel/battery and photovoltaic/battery power systems for a household in Urumqi, China. *J. Cleaner Prod.* 124, 258–265. <http://dx.doi.org/10.1016/j.jclepro.2016.03.002>.
- Maatallah, T., Ghodhbane, N., Nasrallah, S. Ben, 2016. Assessment viability for hybrid energy system (PV/wind/diesel) with storage in the northernmost city in Africa, Bizerte, Tunisia. *Renewable Sustainable Energy Rev.* 59, 1639–1652. <http://dx.doi.org/10.1016/j.rser.2016.01.076>.
- Malheiro, A., Castro, P.M., Lima, R.M., Estanqueiro, A., 2015. Integrated sizing and scheduling of wind/PV/diesel/battery isolated systems. *Renew. Energy* 83, 646–657. <http://dx.doi.org/10.1016/j.renene.2015.04.066>.
- Manwell, J.F., Rogers, A., Hayman, G., Avelar, C.T., MCGowan, J.G., Abdulwahid, U., Wu, K., 2006. Hybrid2 - a hybrid system simulation model: theory manual 267.
- Mondal, M.A.H., Denich, M., 2010. Assessment of renewable energy resources potential for electricity generation in Bangladesh. *Renewable Sustainable Energy Rev.* 14, 2401–2413. <http://dx.doi.org/10.1016/j.rser.2010.05.006>.
- PEA, 2014. Electricity generating data at Koh Mak island, 2014. The Provincial Electricity Authority, Bangkok Thailand.
- Phuangpornpitak, N., Kumar, S., 2011. User acceptance of diesel/PV hybrid system in an island community. *Renew. Energy* 36, 125–131. <http://dx.doi.org/10.1016/j.renene.2010.06.007>.
- Photovoltaic module Suntech, 2015. Available at: <http://sunelec.com/datasheet>.
- Shaahid, S.M., Al-Hadhrani, L.M., Rahman, M.K., 2014. Review of economic assessment of hybrid photovoltaic-diesel-battery power systems for residential loads for different provinces of Saudi Arabia. *Renewable Sustainable Energy Rev.* 31, 174–181. <http://dx.doi.org/10.1016/j.rser.2013.11.055>.
- Shaahid, S.M., El-Amin, I., 2009. Techno-economic evaluation of off-grid hybrid photovoltaic-diesel-battery power systems for rural electrification in Saudi Arabia—A way forward for sustainable development. *Renewable Sustainable Energy Rev.* 13, 625–633. <http://dx.doi.org/10.1016/j.rser.2007.11.017>.
- Shezan, S.K.A., Julai, S., Kibria, M.A., Ullah, K.R., Saidur, R., Chong, W.T., Akikur, R.K., 2016. Performance analysis of an off-grid wind-PV (photovoltaic) -diesel-battery hybrid energy system feasible for remote areas. *J. Cleaner Prod.* 125, 121–132. <http://dx.doi.org/10.1016/j.jclepro.2016.03.014>.
- Silva, S.B., de Oliveira, M.a.G., Severino, M.M., 2010. Economic evaluation and optimization of a photovoltaic-fuel cell-batteries hybrid system for use in the Brazilian Amazon. *Energy Policy* 38, 6713–6723. <http://dx.doi.org/10.1016/j.enpol.2010.06.041>.
- Tongsopit, S., 2015. Energy for Sustainable Development Thailand 's feed-in tariff for residential rooftop solar PV systems: Progress so far. *Energy Sustain. Dev.* 29, 127–134. <http://dx.doi.org/10.1016/j.esd.2015.10.012>.
- van Alphen, K., van Sark, W.G.J.H.M., Hekkert, M.P., 2007. Renewable energy technologies in the Maldives—determining the potential. *Renewable Sustainable Energy Rev.* 11, 1650–1674. <http://dx.doi.org/10.1016/j.rser.2006.02.001>.
- World bank, 2015. History of real interest rate of Thailand. Available at: <http://data.worldbank.org/indicator/>.