

Pouladi, Babak; Hassankiadeh, Mojtaba Nabipoor; Behroozshad, Flor

Article

Dynamic simulation and optimization of an industrial-scale absorption tower for CO₂ capturing from ethane gas

Energy Reports

Provided in Cooperation with:

Elsevier

Suggested Citation: Pouladi, Babak; Hassankiadeh, Mojtaba Nabipoor; Behroozshad, Flor (2016) : Dynamic simulation and optimization of an industrial-scale absorption tower for CO₂ capturing from ethane gas, Energy Reports, ISSN 2352-4847, Elsevier, Amsterdam, Vol. 2, pp. 54-61,
<https://doi.org/10.1016/j.egy.2016.03.003>

This Version is available at:

<https://hdl.handle.net/10419/187843>

Standard-Nutzungsbedingungen:

Die Dokumente auf EconStor dürfen zu eigenen wissenschaftlichen Zwecken und zum Privatgebrauch gespeichert und kopiert werden.

Sie dürfen die Dokumente nicht für öffentliche oder kommerzielle Zwecke vervielfältigen, öffentlich ausstellen, öffentlich zugänglich machen, vertreiben oder anderweitig nutzen.

Sofern die Verfasser die Dokumente unter Open-Content-Lizenzen (insbesondere CC-Lizenzen) zur Verfügung gestellt haben sollten, gelten abweichend von diesen Nutzungsbedingungen die in der dort genannten Lizenz gewährten Nutzungsrechte.

Terms of use:

Documents in EconStor may be saved and copied for your personal and scholarly purposes.

You are not to copy documents for public or commercial purposes, to exhibit the documents publicly, to make them publicly available on the internet, or to distribute or otherwise use the documents in public.

If the documents have been made available under an Open Content Licence (especially Creative Commons Licences), you may exercise further usage rights as specified in the indicated licence.



<https://creativecommons.org/licenses/by-nc-nd/4.0/>



Dynamic simulation and optimization of an industrial-scale absorption tower for CO₂ capturing from ethane gas



Babak Pouladi^a, Mojtaba Nabipoor Hassankiadeh^{b,*}, Flor Behroozshad^a

^a Research and Development Department, South Pars Gas Complex (SPGC), Assaluyeh, Iran

^b South Pars Gas Complex (SPGC), Phases 9&10, Assaluyeh, Iran

ARTICLE INFO

Article history:

Received 14 December 2015

Received in revised form

16 February 2016

Accepted 16 March 2016

Available online 29 March 2016

Keywords:

Absorption

Ethane gas

Diethanolamine (DEA)

Dynamic simulation

Optimization

ABSTRACT

This article considers a process technology based on absorption for CO₂ capturing of ethane gas in phase 9 and 10 of south pars in Iran using diethanolamine (DEA) as absorbent solvent. This CO₂ capture plant was designed to achieve 85% CO₂ recovery and obtain 19 ppm the CO₂ concentration in the outlet of absorber. ASPEN-HYSYS software was used for the dynamic simulation of a commercial-scale CO₂ capture plant and amine Pkg equation was chosen from the fluid property package for calculating the thermodynamic properties of the process. A static approach for optimization was used to evaluate the optimum conditions. This research revealed that pressure variation does not have any considerable changes in the absorption process, while both amine inlet temperature and volumetric flow rate increment enhance the absorption tower efficiency. The effect of temperature was very significant as shown in the dynamic study plots. The optimum condition for CO₂ absorption from a stream of ethane gas with molar flow rate of 2118 kg mol h⁻¹ was obtained 75 m³ h⁻¹ of amine at 53 °C and 24 bar. This optimized condition is acceptable from economical, safe as well as feasible point of view.

© 2016 The Authors. Published by Elsevier Ltd.

This is an open access article under the CC BY license (<http://creativecommons.org/licenses/by/4.0/>).

1. Introduction

The natural gas (NG) extracted from independent gas wells usually contains large percentage of methane gas, some quantity of ethane and with little quantity of other alkanes and small amount of impurities such as carbon dioxide (CO₂), nitrogen, hydrogen sulfide (H₂S) and etc. Mandal et al. (2004) and Alie et al. (2005). Among the non-hydrocarbon components existing in NG, CO₂ and H₂S may inflict severe damages on both environment and industrial equipments. These are as a result of the intrinsic properties of these substances. From economical point of view, dissolving CO₂ or H₂S in water contributes the production of acidic solution (Kent and Eisenberg, 1976) and consequently corrosion problems in pipelines and related equipment would occur during transportation of NG (Bhide et al., 1998; Campbell and Morgan, 1976). Moreover, H₂S has such toxicity that can poison various systems in the human body. Therefore, H₂S removal from natural gas is extremely crucial. Although this paper is not focused on the removal of H₂S, it should be noted that health and safety are key

drivers for removal of this highly toxic gas from sour gas streams. In the case of CO₂, in addition to the corrosiveness of this matter, some other reasons can be addressed to clarify the advantages of CO₂ removal from NG. For example, removal of CO₂ brings about the increase in both producing heat value and transportability of natural gas (Datta and Sen, 2006). From environmental point of view, the global warming has attracted worldwide attention in the last decade and scientists have sounded alarms about the vast emissions of greenhouse gases, especially CO₂, as the main cause of this issue.

Generally, natural gas does not always meet industrial requirements for using in energy generation, chemical and/or petrochemical industries due to the presence of the impurities (Kent and Eisenberg, 1976). Consequently, there is a necessity for refining natural gases to eliminate some of the impurities to enhance their usability.

1.1. Various methods of gas purification

1.1.1. Absorption in rigid phase

Adsorption in rigid phase is one of the gas purification methods in which the acidic gas and other impurities associated with it are transferred onto the solid surface due to concentration gradient. Absorption phenomenon occurs between absorbent and

* Correspondence to: South Pars Gas Complex, Phases 9&10, Assaluyeh, P.O.Box:85391-311, Iran. Tel.: +98 7731 317364; fax: +98 7731 317740.

E-mail address: mojtabanp@yahoo.com (M. Nabipoor Hassankiadeh).

impurities due to molecular attraction force. In this process, formation or breaking of chemical bond does not take place and therefore it is considered as a physical process. To avoid the disadvantage of utilizing liquid sorbent such as corrosion, CO₂ chemical adsorption using dry regenerable solid sorbents has been studied as an innovative concept for CO₂ recovery. The dry solid sorbents can be divided into amine-based and alkali (earth) metal-based sorbents (Yan et al., 2011; Zhao et al., 2009). Many researchers have investigated operating with various solid amine sorbents relying on supports such as silica gel, activated carbon, and etc. Yan et al. (2011) and Siriwardane et al. (2001). Low heat of regeneration is an advantage of amine-based sorbent over aqueous amines due to low heat capacity of solid sorbent. Nonetheless, these amine-based sorbents have poor mechanical property and thermal stability. Recently, dry alkali earth metal-based sorbents for CO₂ capture from flue gas have been also investigated. Alkali earth metal, such as CaO can reversibly react with CO₂ to form alkali earth metal-carbonate CaCO₃ in the absence of water vapor at high temperature (MacKenzie et al., 2007; Blamey et al., 2010).

1.1.2. Absorption in liquid phase

Contrary to the solid methods, that are suitable for separating small amounts of acid gases, absorption technologies, including physical and chemical processes can be employed to remove considerable amounts of acid gases (Korens et al., 2002; Burr and Lyddon, 2008). The most common method for gas sweetening process in refineries and gas treatment plants is absorbing the impurities in a liquid phase. Absorption processes in liquid are divided into two types, namely physical and chemical absorption. In physical absorption, gas flows through a liquid phase in which the impurities are absorbed into the bulk of a liquid that has affinity for the impurities; so, the gases can then be desorbed from the liquid phase easily. The important advantage of this method is low energy consumption, and in addition to that, the solvent used can be reused again (Dugas, 2006). The chemical absorption process is mostly used in commercial gas purification process with diethanolamine (DEA) and monoethanolamine (MEA) as the commonest absorbents. Triethanolamine (TEA) can also be used, but it is not commonly accepted because not only it has relatively higher molecular weight, less activity and stability but also TEA shows lower CO₂ loading at all temperature ranges as compared to other amines. MEA exhibits high reaction rate and high capacity of removal even at low concentration of CO₂. However, this process also has some disadvantages, including the uptake of water into the gas stream that imposes an additional drying process, the evaporation of water which increases the energy demand and the cost of the procedure and the degradation products which can be harmful to both human health and the natural environment (MacDowell et al., 2010). Beside these problems, MEA in contact with iron can form a crystalline complex called tris (ethanolamino)-iron. This compound can ignite when heated to 54–71 °C in the presence of air (Alie et al., 2005). In addition to MEA and TEA, DEA is also frequently used as absorbents for CO₂ removal from industrial gas streams. The DEA has been found to be an effective solvent for the simultaneous removal of acid gases (Mandal and Bandyopadhyay, 2005). Furthermore, DEA can be used at a high concentration without addition of a corrosion inhibitor. The other advantages of DEA as an absorbent in CO₂ capturing process include: (1) low vapor pressure of DEA, (2) the lower amounts of energy required for regeneration of the amine, (3) better thermal and chemical stability. However, DEA also has some drawbacks such as the relatively low CO₂ loading capacity requires high solvent circulation rates and large diameter, high-pressure absorber columns and the corrosive amine solutions induce high equipment corrosion rates (Collie et al., 1998; Morrow and Lunsford, 1997).

1.2. Process investigations

Process simulation is one of the tools used to predict the performance of the process. The computer-aided simulation has several advantages. It: (I) permits the designer to rapidly test the performance of projected flow sheet, (II) decreases experimental efforts and scale up issues, (III) helps in finding out an optimum integrated design, (IV) explores process sensitivity, (V) provides necessary information about process performance, (VI) can check the performance with different thermodynamic models, (VII) can estimate equipments operating costs, and (VIII) can investigate feed-stock flexibility (Kumar et al., 2010). Hence computer-aided process simulation, as a major tool in process engineering to scale up experimental results, can play an important role in the development of CO₂ capture technologies. Ebenezer has explored the proficiency of ASPEN-HYSYS process simulator to find out the CO₂ removal process functioning conditions at which hydrocarbon and chemical loss can be reduced (Ebenezer, 2005). From this investigation, he analyzed that: (I) CO₂ emissions and amine loss are directly proportional to amine circulation rate, (II) absorber should be operated at high pressure and low temperature in order to increase the amine loading capability, (III) amine solvent stay time in stripper should be reduced in order to minimize its degradation and, (IV) the stripper should be operated at atmospheric pressure and the reboiler temperature should be within the solvent stability conditions.

The use of diethanolamine (DEA) and MDEA (methyldiethanolamine) for natural gas sweetening has been investigated by Zare Aliabad and Mirzaei using HYSYS and ASPEN Plus process simulation programs (Zare Aliabad and Mirzaei, 2009). It was observed that CO₂ absorption for MDEA was less and with an increase in lean amine concentration and flow rate, CO₂ and H₂S absorption were increased. However, with an increase of inlet amine temperature in the absorber, the absorption of acid gases was decreased and therefore the concentrations of CO₂ and H₂S in sweet gas were increased. Similarly, the simulation and optimization of CO₂ capture, using commercial process simulators and amine solutions, from natural gas or coal power plants have been carried out by many investigators (Adams et al., in press; Mofarahi et al., 2008). Berstad et al. presented a low-temperature process for CO₂ removal from natural gas before liquefaction. Three low temperature columns reduced the CO₂ concentration from an initial 50.6% to 50 ppm through a combination of distillation and extractive distillation. They also considered different CO₂ concentrations of raw feed gas and different CO₂ content in the sweetened natural gas, either as the only means for CO₂ removal or in combination with other technologies. They reported that one of the advantageous of low-temperature concept is that sweetened natural gas feed has a temperature of –88 °C before entering the liquefier, and is therefore already partly pre-cooled for natural gas liquefaction (Berstad et al., 2012). Nittaya et al. proposed a step-by-step method to scale up an MEA absorption plant for CO₂ capture from a 750 MW supercritical coal-fired power plant. In addition, a dynamic mechanistic model of a commercial-scale CO₂ capture plant with a control scheme was developed in gPROMS and evaluated under several scenarios. The analysis revealed that this plant is able to reject various disturbances and switch between different operating points displaying prompt responses in the key controlled variables (Nittaya et al., 2014). A thermodynamic model to simulate the equilibrium and non-equilibrium models for CO₂ absorption from natural gas stream was developed by Nejad Ghaffar et al. using DEA-promoted potassium carbonate solution in a tray column. The Electrolyte NRTL thermodynamic model was utilized to calculate the activity coefficient in the liquid phase, and the SRK equation of state was used for the gas phase. Results of absorber column simulation showed that the non-equilibrium model gives a

better prediction of the temperature and concentration profiles as compared to the equilibrium model (Nejad Ghaffar Borhani et al., 2015). These studies provide valuable information on the effect of changing amine circulation rate, absorption column height, absorption temperature and reboiler temperature on CO₂ capturing. However, prior to simulate and design the absorption/stripping process with aqueous amines, a few studies had focused on the design of the absorber unit and calculating the operational conditions for commercial-scale plants.

1.3. Chemistry of the process

Acid gas removal from ethane gas by amine absorption is a well known industrial process and is still considered a state of the art technology (Li et al., 2013; Lin et al., 2012). The reactivity and availability of alkanol amines at low cost especially monoethanolamine (MEA), and diethanolamine (DEA), have made the solvent to achieve a pinnacle position in the gas processing industry. Aqueous solutions of the alkanol amines absorb acid gas at relatively low temperatures and release them at almost high temperatures. This process allows the separation of carbon dioxide from ethane gases. There are different reactions between amine and acid gases in different conditions. Generally in the first step, H₂S reacts with amines via H⁺ transfer, while CO₂ reacts with amine in two different reactions pathways; firstly, it reacts with amine to form an acid carbonic salt and secondly, reaction occurs when the CO₂ is dissolved in water and forms bicarbonate ion. The reactions are as follows (Kohl and Nielsen, 1997):

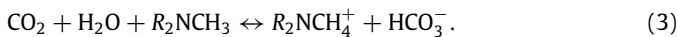
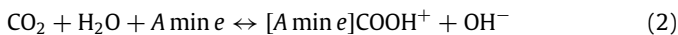
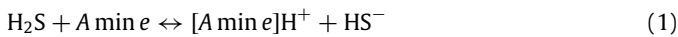

These above mentioned reactions in detailed form are as follows:

Carbamate formation:

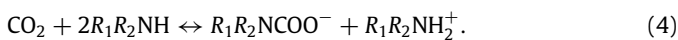

Hydrolysis and dissociation of dissolved CO₂:



Forward and backward reactions of amine carbamate formation:

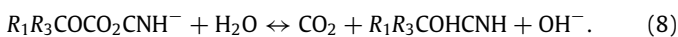
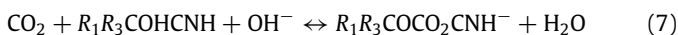

Dissociation of water:



H₂S reacts with the amine solution to give an amine hydrosulphide:

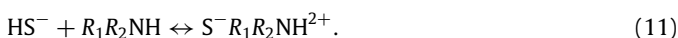

The reaction of CO₂ with amine is slow, but the reaction with H₂S is fast. Therefore, it is assumed that H₂S absorption occurs in gas phase while CO₂ absorption occurs in liquid phase (Blauwhoff et al., 1984). It should be noted that the reactions (4)–(11) are equilibrium reactions. In order to calculate the vapor–liquid equilibrium, heterogeneous approach has been used to determine the properties of both liquid and vapor phases (Berstad et al., 2012; Nejad Ghaffar Borhani et al., 2015). In the heterogeneous approach, which is also well known as γ - ϕ approach, an activity

Table 1
Parameters k , n , and E in the kinetic reactions rate.

Reaction	k	n	E (cal/mol)	Source
(5)	$4.32 \times 10^{+13}$	0	13,249	Pinsent et al., 1956
(6)	$2.38 \times 10^{+17}$	0	29,451	Pinsent et al., 1956
(7)	$6.48 \times 10^{+16}$	0	5072	Rinker et al., 1996
(8)	$1.43 \times 10^{+17}$	0	11,497	Rinker et al., 1996

coefficient model and an equation of state are utilized to represent the liquid phase and the vapor phase, respectively. The Electrolyte NRTL thermodynamic model and PR equation of state have been considered in both thermodynamic and process models for the liquid and gas phases, respectively. The adjustable parameters of Electrolyte NRTL thermodynamic model were determined by the data regression system (DRS) in ASPEN–HYSYS using the industrial data sets for CO₂ solubility over the DEA–H₂–CO₂ solution.

The following power law form is used as the kinetic reactions rate:

$$r_j = K_j \prod_{i=1}^N (x_i \gamma_i)^{\alpha_i} \quad (12)$$

which

$$K_j = k_j \left(\frac{T}{T_0} \right)^n \exp \left[\left(-\frac{E_j}{R} \right) \left(\frac{1}{T} - \frac{1}{T_0} \right) \right] \quad (13)$$

where r_j is the reaction rate of reaction j , k_j is the pre-exponential factor for reaction j , T is the absolute temperature of the system, T_0 is the reference temperature, E_j is the activation energy, n is the temperature exponent, and R is the gas law constant. In this equation, the concentration basis is Molarity. E and k which are derived from Pinsent et al. and Rinker et al. are illustrated in Table 1 (Pinsent et al., 1956; Rinker et al., 1996).

Ethane gas, which is a valuable component of natural gas for olefin plants, must be purged of CO₂ before it can be used. The purging process known as “sweetening process of ethane gas” can be achieved by absorbing the CO₂ into diethanolamine (DEA) solvent (Kent and Eisenberg, 1976). The aim of this work is to study the effects of operational variables in the removal of CO₂ from the ethane gas stream of Phases 9 and 10 of south pars absorption tower using ASPEN–HYSYS dynamic simulation to facilitate the determination of the feed optimal conditions. It has to be mentioned that Phases 9&10 in South Pars Gas Complex (SPGC) are a refinery gas plant. A total of 4 gas treating units are provided, two for each phase. The purpose of the gas treating units is to remove sour gas from the inlet sour gas feed. The absorption tower in each gas treating unit is a valve tray column. It has multiple solvent feed points to optimize the CO₂ slippage for feed gas turndown. The operational variables such as pressure, temperature and amine flow rate may change during operation; so, this dynamic behavior must be measured and that deviation from optimal condition should be removed. The plant’s performance under several scenarios, including a study on the static and dynamic behavior of this plant under process scheduling, is also presented in this research. A typical process flow diagram for the removal of acid gas from a sour gas feed using diethanolamine (DEA) is shown in Fig. 1. Ethane gas sweetening plant as shown in Fig. 1 includes an absorber and a heat exchanger.

2. Results and discussions

There had been two types of simulation in this study, static simulation and dynamic simulation. In the static simulation the process parameters such as amine temperature, amine inlet pressure and amine flow rate were optimized using the vapor–liquid equilibrium calculation and development of

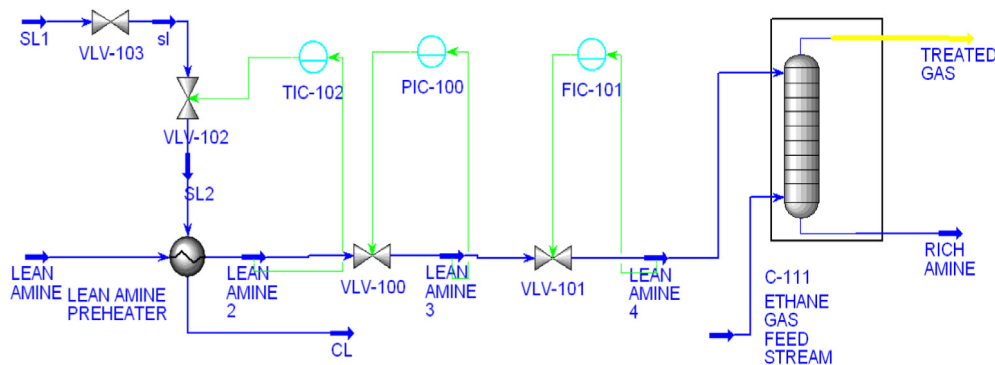

Fig. 1. Process flow diagram for the dynamic simulation of CO₂ absorption from ethane gas stream.

the thermodynamic model simultaneously. Then, the calculated optimized process parameters were applied in the dynamic simulation. The system responses to disturbance in the optimized parameters were investigated in the dynamic simulation.

2.1. Process simulation

The vapor–liquid equilibrium and liquid phase speciation of the DEA–H₂O–CO₂ aqueous solution are calculated using flash model in ASPEN–HYSYS software. The thermodynamic properties such as fugacity coefficient, enthalpy, entropy, free Gibbs energy, and gas volume were calculated using Peng–Robinson equation of state. On the other hand, the transport properties such as viscosity, thermal conductivity, diffusion coefficient, and surface tension were calculated using the physical property models.

2.2. Process modeling

Accurate and detailed process models can contribute to the evaluation of different operating conditions for process optimization purposes without the operation of the actual plant. Obviously, the appropriate modeling of reactive absorption column depends on the proper selection of column internals, sufficient knowledge of the process behavior, and details about the design of the column. In this study, the ASPEN–HYSYS 7.3 was used to simulate the process since this process simulator has suitable thermodynamic model and unit operations to simulate the processes related to electrolyte solutions. It can easily set up the acid gas treatment models as an integral part of a gas processing and this will help us to accelerate our projects. In this work, the rate-based modeling (Rate Frac.) for simulating multistage vapor–liquid fractionation operations in ASPEN–HYSYS was utilized. There are four different flow models in the Rate Frac, which determine the bulk properties required to evaluate the mass fluxes and reaction rates. The four flow models are Mixed, Counter-Current, VPlug, and VPlug-Pavg (Yan et al., 2011). Here, the mixed flow model is chosen because the mixed flow model has the most reliable results.

2.3. Process optimization

Though, there are many factors influencing on the process, the effects of amine inlet temperature, amine flow rate and amine inlet pressure are examined using a fixed number of actual stages in the system (Ghiasi and Mohammadi, 2014; Lawal et al., 2012). The simulation model is developed on ASPEN–HYSYS 7.3. The type of fluid package selected here, is Amine Package. DEA is used as an aqueous absorbent to absorb CO₂ from ethane gas stream. Specification of ethane gas, treated gas, lean DEA and rich DEA are shown in Tables 2, 3, 4, and 5 respectively.

Table 2

Absorbed feed gas composition.

Component	Flow rate (kg mol/h)	Mol fraction
CO ₂	113.735	0.0537
H ₂ S	0.1020	0.0000
H ₂ O	0.0000	0.0000
C ₁	19.4850	0.0092
C ₂	1947.3490	0.9194
C ₃	37.2760	0.0176
C ₄	0.0190	0.0000
DEA	0.0000	0.0000
Pressure (kPa)	2440	–
Temperature (C)	37.00	–
Total	2118.0000	1.0000

Table 3

Treated gas composition.

Component	Flow rate (kg mol/h)	Mol fraction
CO ₂	0.5464	0.0003
H ₂ S	0.0017	0.0000
H ₂ O	12.5039	0.0062
C ₁	19.4659	0.0097
C ₂	1945.7616	0.9654
C ₃	37.2538	0.0185
C ₄	0.0190	0.0000
DEA	0.0005	0.0000
Pressure (kPa)	2410	–
Temperature (C)	55.46	–
Total	2118.0000	1.0000

Table 4

Inlet DEA composition.

Component	Molar flow (kg mol/h)	Mole fraction
CO ₂	5.8620	0.0011
H ₂ S	0.3790	0.0001
H ₂ O	4645.8500	0.9035
DEA amine	490.2000	0.0953
Methane	0.0000	0.0000
Ethane	0.0000	0.0000
Propane	0.0000	0.0000
i-Butane	0.0000	0.0000
Total	5244.7383	1.0000

The absorption tower in this study has 28 valve trays. The tower feed gas flow rate is 2118 kg mol h⁻¹. The mole fraction of the feed gas is ethane, 0.9194; methane, 0.0092; H₂S, 0.000048 and CO₂, 0.054. The molar flow rate of CO₂ in the feed stream is 113.7 kg mol/h and represents the quantity to be absorbed by amine. The feed enters the tower at a temperature of 37 °C and a pressure of 24.4 bar. Diethanolamine (38% w/w) is used as the absorbent and it enters the tower at a temperature of 55.4 °C and a pressure of 24.1 bar with a flow rate of 5142.291 kg mol h⁻¹. It has to be mentioned that the maximum

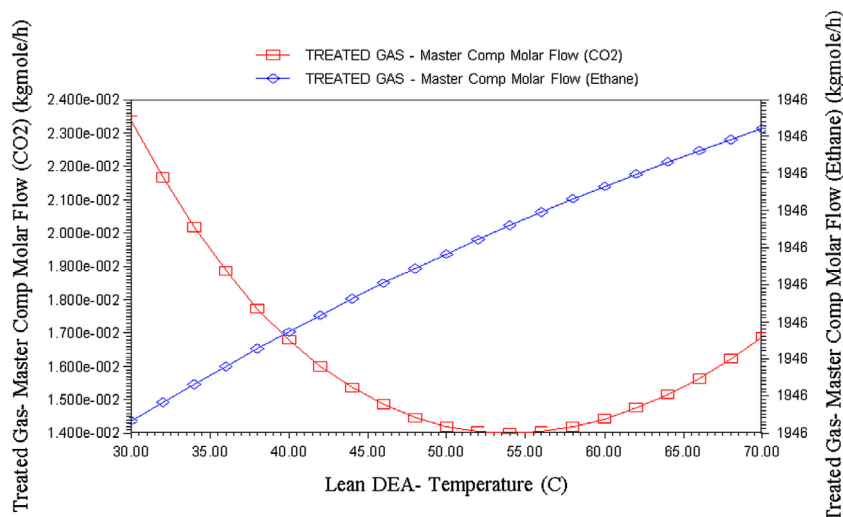

Fig. 2. Effect of amine inlet temperature on the tower performance.

Table 5
Rich amine composition.

Component	Molar flow (kg mol/h)	Mole fraction
CO ₂	119.0506	0.0227
H ₂ S	0.4793	0.0001
H ₂ O	4633.3461	0.8834
DEA amine	490.1995	0.0935
Methane	0.0191	0.0000
Ethane	1.5874	0.0000
Propane	0.0222	0.0000
i-Butane	0.0000	0.0000
Total	5244.7383	1.0000

concentration of diethanolamine in water is limited due to its corrosive behavior. With additives, which decrease corrosion, a concentration between 35 wt% and 45 wt% is feasible.

2.3.1. The effect of amine temperature on tower performance

The result of changing amine inlet temperature is shown in Fig. 2. Ethane and CO₂ molar flows were taken as the dependent variables, while the temperature was the independent variable. The minimum quadratic plot shows that the initial increase in temperature decreases the absorption rate up to the turning point and further increment beyond that point, increases the absorption efficiency of the tower.

Maximum absorption of CO₂ is observed at a temperature of 53 °C. Increase in the temperature from 30–53 °C shows an increase in the absorption of CO₂. Further increment in temperature above 53–70 °C progressively shows decrease in the absorption of CO₂. Similarly, a small increase (almost negligible) in the quantity of ethane gas was observed at the treated gas stream. The enhanced absorption efficiency observed in the temperature range of 30 to 53 °C might be due to thermal partition created by temperature increment that break the weak force of attraction between absorbed CO₂ and associated ethane molecules that are initially in equilibrium (Idem et al., 2006). The absorption efficiency between 53 and 70 °C is comparably lower than that at 53 °C, hence it can be concluded that the tower can be operated better at lower temperatures, which will not only save both initial and operational cost, but also reduces the risk of operation at elevated temperature.

2.3.2. The effect of amine flow rate on tower performance

The performance of the commercial-scale CO₂ capture plant in closed-loop was evaluated assuming sustained changes in the amine flow rate, which is the key external disturbance that affects

this process. Fig. 3 shows the effect of amine volumetric flow rate on the tower performance.

The amine volumetric flow rate is assigned as the independent variable, while the monitored molar flow rate of CO₂ and ethane in the treated gas stream are assigned as dependent variables. The volumetric flow rate was increased from 60 to 150 m³ h⁻¹ and the result showed that increment in the amine volumetric flow rate drastically increases the absorption rate of CO₂ from 60 up to 75 m³ h⁻¹. Beyond 75 m³ h⁻¹, there is no absorption of CO₂ gas anymore. At this condition, it can be concluded that the absorption process has attained equilibrium based on the prevailing operating conditions and the composition of the components. It is worthy of mention that the molar flow rate of ethane gas in the treated gas stream slightly reduced from 1947 to 1945.7 kg mol h⁻¹. This is due to equilibrium and solubility factors as part of the ethane gas which was transferred with the CO₂ into the amine stream during the absorption of CO₂. So, the optimal amine volumetric flow rate is 75 m³ h⁻¹.

2.3.3. The effect of amine inlet pressure on tower performance

The effect of Amine inlet pressure is studied in the pressure range of 24–26 bar in plant's performance condition and the response is plotted in Fig. 4. The result showed that pressure variation does not affect the absorption of CO₂ gas. The composition of both ethane and CO₂ was stable over the simulated range. This probably implies that amine has strong affinity for absorbing CO₂ gas without applying external pressure.

Therefore, it can be concluded that the reaction between amine and CO₂ (Eqs. (2)–(3)) occurs spontaneously. For the purpose of economy and safety, the optimum pressure can be the minimum allowable value namely 24 bar.

2.4. The effect of amine inlet temperature on absorption tower performance

In order to investigate the response of amine temperature on the process, the dynamic simulation was performed at different temperatures namely 44.97, 55.38 and 58.54 °C. The simulation results are shown in Figs. 5–7.

The results indicate that increase in the amine inlet temperature increases the outlet gas flow rate and consequently a higher degree of CO₂ removal from the ethane gas stream would be obtainable. In practice, a higher temperature will give a higher absorption and reaction rate. The amine flow rate at the three studied

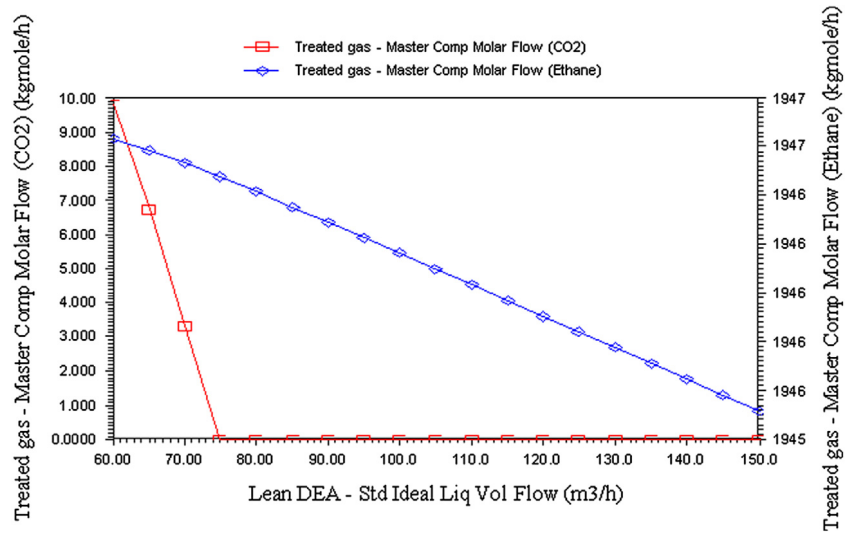

Fig. 3. Effect of amine volumetric flow rate on the tower performance.

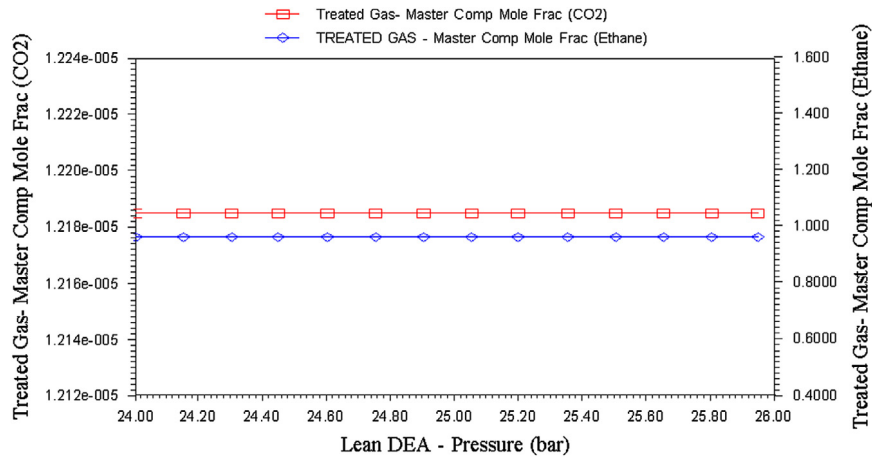

Fig. 4. Effect of amine inlet pressure on the tower performance.

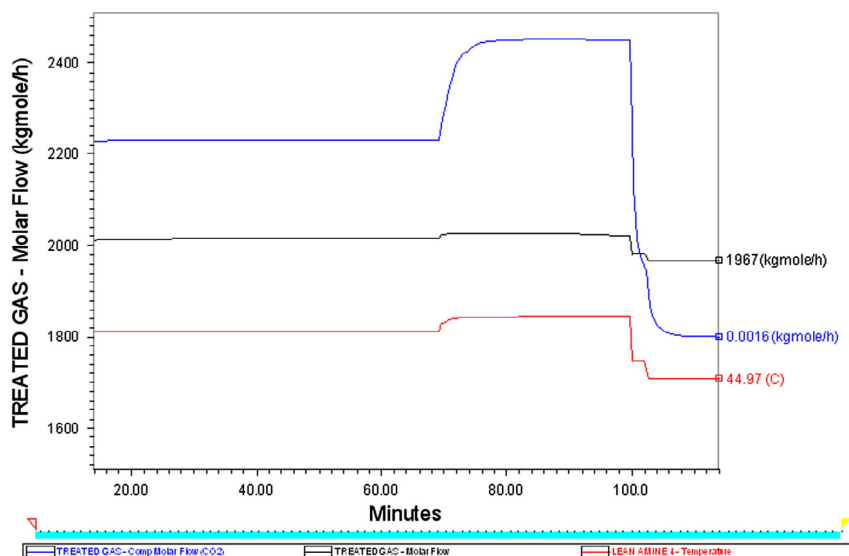

Fig. 5. Tower performance at amine inlet temperature of 44.97 °C.

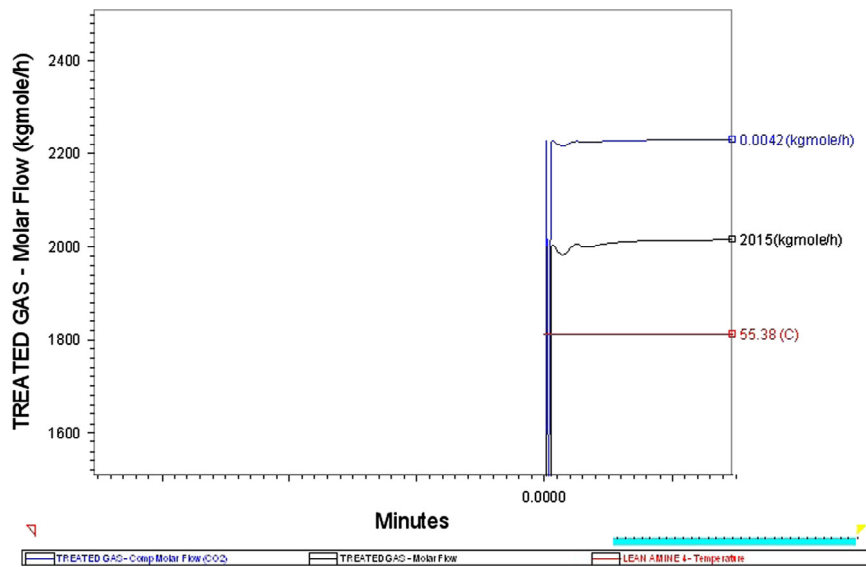

Fig. 6. Tower performance at amine inlet temperature of 55.38 °C.

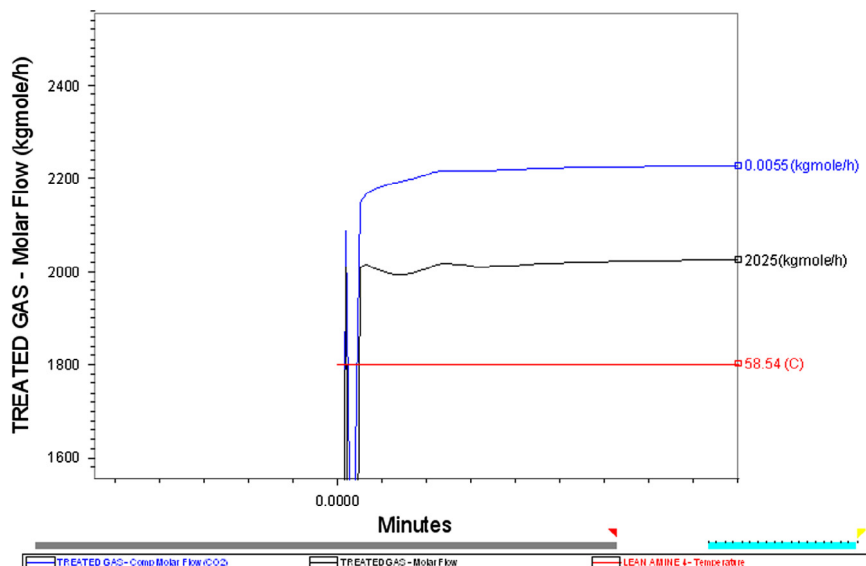

Fig. 7. Tower performance at amine inlet temperature of 58.54 °C.

temperatures is 1967, 2015, and 2025 kg mol/h, and the amount of CO₂ removal is 0.0016, 0.0042 and 0.0055 kg mol/h, respectively. This observation is due to the increase in the reaction rate between the amine and CO₂ gas as depicted in Eqs. (2)–(3). In practice, a higher temperature will give a higher absorption and reaction rate.

Fig. 5 includes three curves of the molar flow rate of carbon dioxide in sweetened gas flow rate (BLUE), molar flow rate of sweetened gas and input amine temperature. With a step change in time from 70 to 100 min, it is observed that primarily due to an increase in the temperature of the incoming amine, the amount of carbon dioxide increases tangibly and the amount of sweetened gas flow rate due to the entry of carbon dioxide increases. Then, after 100 min with decreasing temperature, the amount of carbon dioxide in sweetened gas reduces, so sweetened gas flow decreases due to lack of sour gas. Finally, further reduction in the temperature of input amine does not affect lines and the lines are fixed. Figs. 5–7 show the different incoming amine temperatures. Based on Fig. 2 the maximum flow rate of ethane and minimum amount of carbon dioxide along with ethane can be achieved at 55.38 °C. The highest incoming amine temperature (55.38 °C) and high ethane flow rate

up to 2015, the high amount of carbon dioxide removal 0.0042 can be resulted as it can be seen in Fig. 6.

3. Conclusion

In order to improve the CO₂ capturing from ethane gas in 9 and 10 phases of south pars, certain process variables like amine inlet temperature, pressure, and volumetric flow rate were simulated to evaluate the performance of the absorption tower. Both static and dynamic simulation results showed that temperature and volumetric flow rate increment enhance the absorption of CO₂, with observed optimal values of 55.38 °C and 75 m³ h⁻¹, respectively. The amine flow rate was decreased from 120 m³ h⁻¹ to 75 m³ h⁻¹ in optimal condition. It reduced the amount of amine circulation rate, amine losses and consequently the costs. The effect of pressure showed that the amine inlet pressure does not really affect the process. Therefore, the operation of the absorption tower handling a gas feed rate of 2118 kg mol h⁻¹ in a 28 valve trays with amine (38% w/w) feed rate of 75 m³ h⁻¹ at 55.38 °C and 24 bar is economical and technically viable.

References

- Adams, T.A., Khojasteh Salkuyeh, Y., Nease, J., 2014. Processes and Simulations for Solvent-Based CO₂ Capture and Syngas Cleanup, Reactor and Process Design in Sustainable Energy Technology. Elsevier, in press.
- Alie, C., Backham, L., Croiset, E., Douglas, P.L., 2005. Simulation of CO₂ capture using MEA scrubbing: a flow sheet decomposition method. *Energy Convers. Manage.* 46, 475–487.
- Berstad, D., Neksa, P., Anantharaman, R., 2012. Low-temperature CO₂ removal from natural gas. *Energy Procedia* 26, 41–48.
- Bhide, B.D., Voskericyan, A., Stern, S.A., 1998. Hybrid processes for the removal of acid gases from natural gas. *J. Membr. Sci.* 140, 27–49.
- Blamey, J., Anthony, J., Wang, E.J., Fennell, P.S., 2010. The calcium looping cycle for large-scale CO₂ capture. *Prog. Energy Combust. Sci.* 36, 260–279.
- Blauwhoff, P.M.M., Versteeg, G.F., Van Swaay, W.P.M., 1984. A study on the reaction between CO₂ and alkanolamines in aqueous solutions. *Chem. Eng. Sci.* 39, 207–225.
- Burr, B., Lyddon, L., 2008. A comparison of physical solvents for acid gas removal. In: Proceedings of the 76th Annual Meeting of the Gas Processors Association, GPA, Grapevine, Texas.
- Campbell, K., Morgan, J., 1976. *Gas Conditioning and Processing*, second ed. Norman, Oklahoma, USA.
- Collie, J., Hlavinka, M., Ashworth, A., 1998. An analysis of BTEX emissions from amine sweetening and glycol dehydration facilities. In: Proceedings of the Laurance Reid Gas Conditioning Conference. University of Oklahoma Foundation, pp. 175–193.
- Datta, A.K., Sen, P.K., 2006. Optimization of membrane unit for removing carbon dioxide from natural gas. *J. Membr. Sci.* 283, 291–300.
- Dugas, E.R., 2006. Pilot plant study of carbon dioxide capture by aqueous monoethanolamine (M.S.E. thesis), University of Texas at Austin.
- Ebenezer, S.A., 2005. Removal of Carbon Dioxide from Natural Gas from LNG Production. Institute of Petroleum Technology, Norwegian University of Science and Technology, Trondheim, Norway.
- Ghiasi, M.M., Mohammadi, A.H., 2014. Rigorous modeling of CO₂ equilibrium absorption in MEA, DEA, and TEA aqueous solutions. *J. Nat. Gas Sci. Eng.* 18, 39–46.
- Idem, R., Wilson, M., Tontiwachwuthikul, P., Chakma, A., Veawab, A., Aroonwilas, A., Gelowitz, D., 2006. Pilot plant studies of the CO₂ capture performance of aqueous MEA and mixed MEA/MDEA solvents at the University of Regina capture technology development plant and the boundary Dam CO₂ capture demonstration plant. *Ind. Eng. Chem. Res.* 45, 2414–2420.
- Kent, R.L., Eisenberg, B., 1976. Better data for amine treating. *Hydrocarbon Process* 2, 87–96.
- Kohl, A., Nielsen, R., 1997. *Gas Purification*, fifth ed. Gulf Publishing Company, Houston, Texas.
- Korens, N., Simbeck, D.R., Wilhelm, D.J., 2002. Process screening analysis of alternative gas treating and sulfur removal for gasification (Revised Final Report). US Department of Energy by SFA Pacific, Inc.
- Kumar, S., Cho, J.H., Moon, I., 2010. Ionic liquid-amine blends and CO₂BOLs: Prospective solvents for natural gas sweetening and CO₂ capture technology-A review. *Int. J. Greenhouse Gas Control* 20, 87–116.
- Lawal, A., Wang, M., Stephenson, P., Obi, O., 2012. Demonstrating full-scale post-combustion CO₂ capture for coal-fired power plants through dynamic modeling and simulation. *Fuel* 101, 115–128.
- Li, L., Zhao, N., Wei, W., Sun, Y., 2013. A review of research progress on CO₂ capture, storage, and utilization in Chinese academy of sciences. *Fuel* 108, 112–130.
- Lin, Y., Wong, D.S., Jang, S., 2012. Control strategies for flexible operation of power plant with CO₂ capture plant. *AIChE J.* 58, 2697–2704.
- MacDowell, N., Florin, N., Buchard, A., Hallett, J., Galindo, A., Jackson, G., 2010. An overview of CO₂ capture technologies. *Energy Environ. Sci.* 3, 1645–1669.
- MacKenzie, A., Granatstein, D.L., Anthony, E.J., Abanades, J.C., 2007. Economics of CO₂ capture using the calcium cycle with a pressurized fluidized bed combustor. *Energy Fuels* 21, 920–926.
- Mandal, B.P., Bandyopadhyay, S.S., 2005. Simultaneous absorption of carbon dioxide and hydrogen sulfide into aqueous blends of 2-amino-2-methyl-1-propanol and diethanolamine. *Chem. Eng. Sci.* 60, 6438–6451.
- Mandal, B.P., Biswas, A.K., Bandyopadhyay, S.S., 2004. Selective absorption of H₂S from gas streams containing H₂S and CO₂ into aqueous solutions of N-methyldiethanolamine and 2-amino-2-methyl-1-propanol. *Sep. Purif. Technol.* 35, 191–202.
- Mofarhi, M., Khojasteh, Y., Khaleidi, H., Farahnak, A., 2008. Design of CO₂ absorption plant for recovery of CO₂ from flue gases of gas turbine. *Energy* 33, 1311–1319.
- Morrow, D.C., Lunsford, K.M., 1997. Removal and disposal of BTEX components from amine acid gas streams. In: Proceedings of the 76th Annual Meeting of the Gas Processors Association, GPA, Tulsa, Oklahoma, pp. 248–250.
- Nejad Ghaffar Borhani, T., Akbari, V., Afkhamipour, M., Abd Hamid, M.K., Abdul Manan, Z., 2015. Comparison of equilibrium and non-equilibrium models of a tray column for post-combustion CO₂ capture using DEA-promoted potassium carbonate solution. *Chem. Eng. Sci.* 122, 291–298.
- Nittaya, T., Douglas, P.L., Croiset, E., Ricardez-Sandoval, L.A., 2014. Dynamic modeling and evaluation of an industrial-scale CO₂ capture plant using monoethanolamine absorption processes. *Ind. Eng. Chem. Res.* 53, 11411–11426.
- Pinsent, B.R.W., Pearson, L., Roughton, F.J.W., 1956. The kinetics of combination of carbon dioxide with hydroxide ions. *Trans. Faraday Soc.* 52, 1512–1520.
- Rinker, E.B., Ashour, S.S., Sandall, O.C., 1996. Kinetics and modeling of carbon dioxide absorption into aqueous solutions of diethanolamine. *Ind. Eng. Chem. Res.* 35, 1107–1114.
- Siriwardane, R.V., Shen, M.S., Fisher, E.P., Poston, J.A., 2001. Adsorption of CO₂ on molecular sieves and activated carbon. *Energy Fuels* 15, 279–284.
- Yan, X.L., Zhang, L., Zhang, Y., Yang, G.D., Yan, Z.F., 2011. Amine-modified SBA-15: effect of pore structure on the performance for CO₂ capture. *Ind. Eng. Chem. Res.* 50, 3220–3226.
- Zare Aliabad, H., Mirzaei, S., 2009. Removal of CO₂ and H₂S using aqueous alkanolamine solutions. *Int. J. Chem. Biomol. Eng.* 2, 78–87.
- Zhao, C.W., Chen, X.P., Zhao, C.S., Liu, Y.K., 2009. Carbonation and hydration characteristics of dry potassium-based sorbents for CO₂ capture. *Energy Fuels* 23, 1766–1769.