

Jaunaux, Laure; Lebourges, Marc

**Conference Paper**

## Zero rating and end-users' freedom of choice: An economic analysis

29th European Regional Conference of the International Telecommunications Society (ITS): "Towards a Digital Future: Turning Technology into Markets?", Trento, Italy, 1st - 4th August, 2018

**Provided in Cooperation with:**

International Telecommunications Society (ITS)

*Suggested Citation:* Jaunaux, Laure; Lebourges, Marc (2018) : Zero rating and end-users' freedom of choice: An economic analysis, 29th European Regional Conference of the International Telecommunications Society (ITS): "Towards a Digital Future: Turning Technology into Markets?", Trento, Italy, 1st - 4th August, 2018, International Telecommunications Society (ITS), Calgary

This Version is available at:

<https://hdl.handle.net/10419/184947>

**Standard-Nutzungsbedingungen:**

Die Dokumente auf EconStor dürfen zu eigenen wissenschaftlichen Zwecken und zum Privatgebrauch gespeichert und kopiert werden.

Sie dürfen die Dokumente nicht für öffentliche oder kommerzielle Zwecke vervielfältigen, öffentlich ausstellen, öffentlich zugänglich machen, vertreiben oder anderweitig nutzen.

Sofern die Verfasser die Dokumente unter Open-Content-Lizenzen (insbesondere CC-Lizenzen) zur Verfügung gestellt haben sollten, gelten abweichend von diesen Nutzungsbedingungen die in der dort genannten Lizenz gewährten Nutzungsrechte.

**Terms of use:**

*Documents in EconStor may be saved and copied for your personal and scholarly purposes.*

*You are not to copy documents for public or commercial purposes, to exhibit the documents publicly, to make them publicly available on the internet, or to distribute or otherwise use the documents in public.*

*If the documents have been made available under an Open Content Licence (especially Creative Commons Licences), you may exercise further usage rights as specified in the indicated licence.*

# Zero rating and end-users' freedom of choice: An economic analysis

Laure JAUNAUX & Marc LEBORGES\*

Orange, Regulatory Department, Paris, France

**Abstract:** According to Open Internet Regulation, commercial practices of Internet access Service Providers (ISP) should not restrict end-users' rights regarding services, applications or contents. This paper analyses specifically if zero rating (ZR) enhances or restricts end-users' choice translating this regulatory criterion into a formal expression: providing a zero rating offer on a content or application provider (CAP) will be considered as restricting end-users' choice if it has the direct or indirect effect of reducing the usage or provision of other CAP's non-zero rated services, all other things being equal. This article shows that in the short term, with the ISP offer unchanged, adding a zero rating service tends not to directly restrict end-users' choice, increasing both zero rated and non-zero rated usages. In the long term, ISPs may adapt their offer to support the cost of zero rating and it could in principle have a negative indirect impact on the usage of non-zero rated services if the zero rated traffic is financed by the ISP. However, in practice any such negative effects of zero rating are diluted or compensated by competitive forces in the absence of dominance in the ISP and CAP markets or if the volume of zero rated traffic is small compared to the data allowance available to the end user. A contrario, in the case of sponsored data, the corresponding traffic cost is covered by the CAP. It prevents any need for cross-subsidies and therefore protects end-users' freedom of choice, to the extent that the ability to sponsor data is opened to all content and application providers on equivalent terms.

**Key words:** Telecoms regulation, Net neutrality, Zero rating.

## I. Introduction

Zero rating is a commercial practice by which an Internet access Service Provider does not charge the user for the internet traffic related to specific contents or applications, or categories of contents or applications, available on the Internet. The practice generally concerns mobile ISPs which propose limited or metered data plans. If an end-user has an unlimited data allowance, a zero rating offer has no additional benefit. Therefore, this practice is mostly found in mobile broadband services which, owing to underlying bandwidth constraints, are more likely to have data caps.

The provisions of European Regulation 2015/2120 concerning Open Internet do not explicitly mention zero rating, but provide general principles which guarantee an Open Internet, in particular concerning commercial practices and prices.

Article 3 paragraph 1 provides that: « *End-users shall have the right to access and distribute information and content, use and provide applications and services, and use terminal equipment of their choice, irrespective of the end-user's or provider's location or the location, origin or destination of the information, content, application or service, via their internet access service.* ». Article 3 paragraph 2 specifies « *Agreements between providers of internet access services and end-users on commercial and technical conditions and the characteristics of internet access services such as price, data volumes or speed, and any commercial practices conducted by providers of internet access services, shall not limit the exercise of the rights of end-users laid down in paragraph 1.* »

The Body of European Regulators for Electronic Communications (BEREC) guidelines adopted pursuant to article 3 of the European Regulation mention zero rating practices in recitals 40 to 48 as a commercial practice which may impact the freedom of choice of end-users in the Internet.

---

\* All opinions expressed are those of the authors and may not represent those of Orange.

According to the BEREC Guidelines, a zero rating offer where all applications are blocked (or slowed down) once the data cap is reached, except for the zero rated application(s), would infringe the principle of equal treatment between all internet traffic (Article 3 (3) of the Open internet regulation) and thus should be prohibited. Indeed, such types of offers which include differentiated traffic management in addition to zero rate pricing schemes have recently been banned on the Hungarian and Swedish markets.

However, when zero rating is purely a pricing practice and is not associated with differentiated traffic management, BEREC recommends a case by case analysis. It is up to National Regulatory Authorities (NRAs) to complete a multi-criteria analysis in order to assess the extent to which end-users' choice is restricted by the commercial practices of the ISP.

The objective of this article is to propose a single formal criterion characterizing whether or not such zero rating offers materially restrict end-users' freedom of choice in practice as defined in the open internet Regulation. In practical terms, it is the case when a zero rating offer favouring the usage of a content or application has the direct or indirect effect of significantly reducing the volume of usage of any other content or application. Indeed, freedom of choice of end-users cannot be considered to have been materially restricted if no content or application usage is significantly reduced.

The impact analysis will be based on economic reasoning enabling the formalization of how this criterion is directly or indirectly impacted by zero rate offers. To that end, this article makes a systematic analysis of the impact of zero rating offers on end-users' usage of contents and applications for a given ISP, on the characteristics of the ISP's offer and on the supply and availability of content and applications.

The analysis is limited to net neutrality regulatory concerns. Potential antitrust issues related to zero-rate offers are not addressed. It also does not address ISPs' motivations to offer zero rating as the analysis is focused on the impact on consumers after they subscribe to a zero rating offer.

The analysis is made in two steps. As a first step, the paper will analyze the direct impact on all end-users' usages of adding zero rating for specific contents and applications to a given internet access offer (other characteristics of the ISP offer remaining unchanged). Whether or not such an addition has the effect of reducing the volume of usage of certain CAP will be assessed.

As a second step, the paper analyses the potential knock-on effect in the long run of introducing zero rating offers, as defined in the first step, on the ISP offer and the supply of content and applications. For this purpose, we will distinguish different forms of economic models supporting zero rated traffic: "pure zero rating", when the cost of zero rated traffic is supported by the internet access service provider, or "zero rating with sponsored data", when the cost of zero rated traffic is borne by the content or application providers. Situations of dominance or of vertical integration are also addressed.

This two-step approach will allow us to study the short-term or long-term impact of zero rated traffic on the volume of usage of content and applications, and therefore to assess the circumstances in which our formal translation of the regulatory criterion of safeguarding end-users' rights is satisfied.

The remainder of the paper is organized as follows: Section II reviews the limited existing literature on zero rating. Section III analyses the impact on end-users' behavior of the introduction of zero rating for a specific CAP on top of a given IAS offer, all other things being equal. At this first step, the economic wholesale model underlying zero rating will not be addressed. Section IV assesses the long run effects of zero rating on IAS offers (impacts on prices and on volumes) and on the supply of content and applications. In this section, two economic models of zero rating are analyzed: "pure

zero rating” or “zero rating with sponsored data”, following the terminology explained above. Section V concludes.

## II. Literature review

The available literature on the analysis of zero rating can be divided into 2 sets: legal and regulatory, and economic.

In the legal and regulatory domain, the main sources are paragraphs 40 to 48 of the BEREC guidelines and the Belgian Institute for Postal services and Telecommunications (BIPT), the Belgian National Regulatory Authority (NRA) decision authorizing the “Tuttimus” offer of Proximus (a Belgian mobile network operator (MNO)). The BEREC report (2017) on the implementation of European Net Neutrality rules (BoR 17 (240)) underlines that most Net Neutrality cases addressed by National Regulatory Authorities concern zero rating offers. For the record, there is also the document by which the Federal Communications Commission (FCC) expressed concerns over AT&T and Verizon ZR offers in the USA and at the same time gave the green light to T-Mobile US ZR proposals. Although the new FCC Chair stopped this proceeding, the reasoning is still worth reading. However, our work differs from these sources in terms of substance because we attempt to define a formal criterion for assessing the impact on end-users’ rights, whereas the authorities use a case by case analysis with an informal approach depending on the authority and the context.

In the economic domain, the literature is relatively scarce.

B. Jullien and W. Sand-Zantman (2015), in their early working paper, analyze the specific case of sponsored data, and explain how sponsored data may improve welfare by solving the problem of the “missing price” when end-users consume services knowing neither their value nor the network resources they occupy. In their published paper (2018), Jullien and Sand-Zantman address a slightly different question and demonstrate that zero rating enables ISPs to screen contents and applications. This allows more traffic to be directed towards more valuable contents and applications. Due to the two-sided nature of the market and the fact that C&A are often free for consumers, the ISP internalized the consumer surplus in its decision: the potential negative impact of discrimination in the content side, if any, may be balanced with welfare benefits on the consumer side.

Robert Somogyi (2017) focuses its analysis on the impact of ZR on network congestion, considering network capacity as fixed. Axel Gautier and Robert Somogyi (2018) analyze two business practices, paid prioritisation and zero rating when there is capacity constraint. They find that, when the value of traffic for CAP is limited, ISP’s optimal policy is zero rating whereas when the traffic is high, the optimal practice is paid prioritisation which is also beneficial for consumers.

Roslyn Layton and Silvia Monica Elaluf-Calderwood (2015) compares empirically the variety of applications available and used by consumers in countries where zero rating is banned and in countries where it is used. They observe that end-users’ choice appears richer in the latter case.

Krämer and Peitz in a CERRE report (2018) focus their analysis on the case for which zero rated traffic is throttled.

A broader literature on data caps offers a new explanation for why it is in the interest of ISPs to offer plans with download limits. Economides, N. and B. E. Hermalin (2015) demonstrate that ISPs, by

offering Zero Rating, cause CAPs to lower prices or improve quality. This generates a higher consumer surplus, captured by ISPs via higher consumer prices.

Our approach is distinct from those of these academic papers as they assess the need for regulation in general, without being bound by a specific regulation, and using the classical academic benchmark of social or consumer welfare instead of the Regulation-specific criterion of material restriction in end-users' choice.

Finally, our paper does not address the reasons why zero rating offers emerge. In the field, the motivations for an ISP to offer pure zero rating without sponsored data differ from its motivation to provide zero rating subject to sponsored data. The motivation of an ISP to offer pure zero rating is to differentiate itself from competitors. Zero rating with sponsored data enables ISPs to provide to CAPs an instrument to develop the use of their service on the basis of their own confidential information on its value and costs. Our paper adopts the point of view of regulation i.e. analyses the effects of zero rating on end-users once the ISP decides to offer this service.

### **III. Zero rating and end-users' behavior and freedom of choice : the short term effects in a given unchanged offer**

This section first defines the framework in which the direct impact of zero rating will be analyzed and then studies how the introduction of zero rating impacts the usages of zero rated or non-zero rated applications for a given IAS offer, differentiating between non-zero rated applications which may or may not compete with zero rated applications.

#### **3.1. Analytical framework**

This sub-section presents the modeled situation and underlines the importance for the analysis of which party selects the zero rated application, either the end-user or the ISP.

##### **a) Modeling the inclusion of zero rated applications in a given IAS offer**

As mentioned in the European Commission report (2017) on "zero-rating practices in broadband markets", zero rating practices can be divided into three main categories following the current practices in Europe:

- "Bundled free": zero rating of applications that are generally free to access, with the charge for data usage bundled into a tariff. If there is a subscription for an application, it is not bundled into the tariff;
- "Bundled subscription": zero rating of applications for which a subscription is required. Subscription and data charges are bundled into the tariff;
- "Add-on": for an additional fee, the customer is given the option of zero rating certain contents or applications with unlimited usage. In some countries such as Bulgaria, operators offer add-ons that provide a finite data package. Strictly speaking, these offers are not considered as zero rating.

In this paper, without loss of generality, zero rating is defined more schematically as the fact that the data allowance is not reduced by the internet access provider when its clients use the zero rated application, as the different retail forms of zero rating trigger the same economic mechanisms on end users' freedom of choice.

In this first step, we analyze the introduction of zero rated traffic for an application or a set of applications in an IAS offer, all other things being equal: all other characteristics of the IAS offer, such as price or data allowance, remain unchanged. The knock-on impact of this introduction on IAS offers will be analyzed in a second step, in chapter IV of this paper, to obtain a comprehensive view of the direct and indirect effects of zero rating on end users usages and choices.

The situation which is considered is summarized in Figure 1 below. The end-user in this model does not pay for the extra traffic of the zero rated service which corresponds to the in-bundle zero rating offers previously mentioned. According to the EC report on zero rating practices (2017), add-on offers are used by ISPs when the data allowances are small or where the zero rated service has a high-data usage such as mobile TV, justifying the extra cost. As we will see, the fact that the zero rating is free or a paid service will have no incidence in the reasoning used in this section.

Figure 1: Zero rated traffic introduced in a given offer

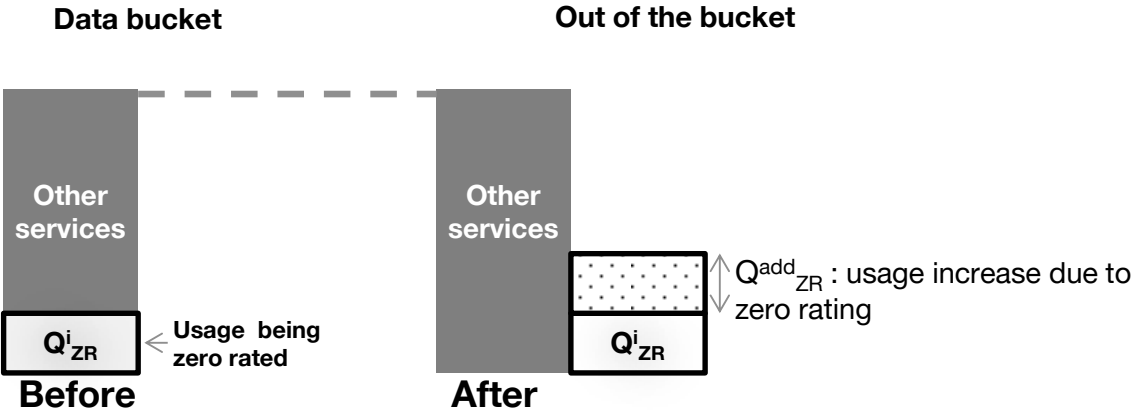

Once the zero rated traffic for the ZR application is introduced, the traffic corresponding to the consumption of the ZR application is not taken into account in the end-user’s data allowance consumption. This may increase the data usage of this application.

The underlying economic model of zero rating (pure zero rating or sponsored data) is not considered in the first step of the analysis because it has no direct impact on the end-user behavior.

b) The choice of the zero rated application

Whether the zero rated service is chosen by the end-user or by the ISP appears to be critical when the criterion to be analyzed is the end-user’s freedom of choice.

If the ISP lets the end-user freely choose the ZR application or if the choice of the potentially ZR application results from an objective selection process based on end-users’ choices (e.g. choice of most-used applications by end-users, as in Proximus’s proposal with its Tuttimus offer), customers cannot be considered as being restricted in their choices. The ISP does not directly distort end-users’ choices, which are on the contrary reflected in the choice of the zero rated applications.

But if the ISP selects a specific ZR application, this may influence end-users’ choices: for instance, if the ISP proposes to zero rate the use of Spotify, customers who were using Deezer may wish to change their music and video provider as a consequence. But does this restrict end-users’ freedom of choice, as compared to a situation where Spotify is not zero rated? This is what we are going to analyze.

Therefore, the following paragraph discussing the impact of ZR offers on the volume of usage of ZR and non ZR applications only concerns the cases for which the choice of the ZR application is under the ISP’s control.

3.2 Impact on usage of introducing ZR in a given offer

This sub-section analyses the impact of introducing a zero rated application in a given offer on ZR and non ZR usage.

To this end, we model the situation before and after the introduction of the zero rated application in the following way:

- Before the introduction of the zero rated offer, the customer has an allowance of x Gbytes. She consumes this data bucket for the usage of the service which will be zero rated,  $Q_{ZR}^i$ , for the services competing with the service which will be zero rated,  $Q_{CZR}^i$ , and for other services not competing with the service which will be zero rated,  $Q_{NCZR}^i$  (cf. figure 2).

Figure 2: Situation before the introduction of the Zero Rated offer

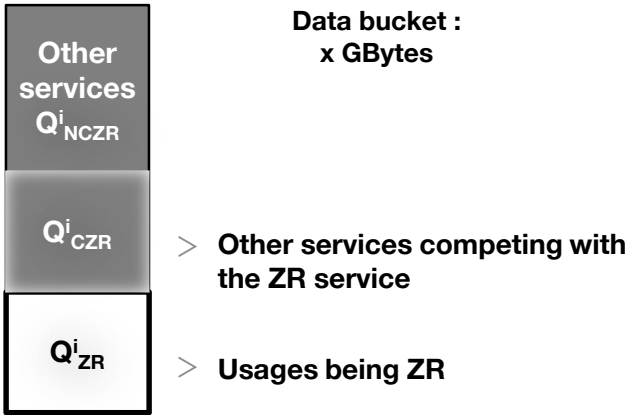

- After the introduction of the zero rated offer, the customer has the same allowance of X Gbytes. The consumption of the zero rated application may increase  $Q_{add}^i$ , as there is no longer any opportunity cost: consuming the zero rated application no longer reduces the allowance available for the use of other applications. As the consumption of the Zero Rated application is no longer taken into account, the volume of data consumed when the ZR application was used is now available for other usages, which may be competing or not competing with the zero rated application (cf. Figure 3).

Among the competing usages, we distinguish between usages equivalent to those of ZR app  $Q_{CZR}^E$  and differentiated usages  $Q_{CZR}^D$ . For instance, using again the Spotify – Deezer example, Deezer competes with Spotify, however the offer is not fully substitutable:

- o  $Q_{CZR}^E$ : pieces of music available both on Spotify and Deezer are considered as equivalent usages;
- o  $Q_{CZR}^D$ : pieces of music available only on Spotify or on Deezer are considered as differentiated usages.

The user may also prefer an application to another in absolute terms or face switching costs to adapt to another C&A when she is accustomed to a C&A providing a substitutable service. Such

circumstance would have the effect of reducing any potential impact of zero rating on end-users usage, as it would stand against and limit the impact of pricing on end-users' behavior.

Figure 3: Situation after the introduction of zero rated applications

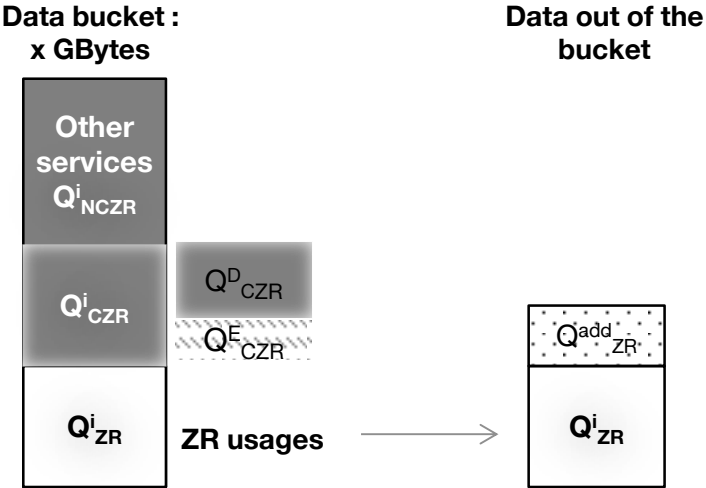

The primary impact of the introduction of zero rating in a given offer is to reduce the unit data price as the customer pays the same price for more consumption. Not only is usage of the zero rated application increased, but so is usage of other applications in general, as they can benefit from the data previously consumed by zero rated service and made available in the allowance for other usages.

The following paragraphs will assess in more details the impact of zero rated offers for a specific application on ZR and non ZR usages (competing and non-competing usage) for a given IAS offer.

The unit price is a priori reduced for all applications. This should lead to higher consumption and therefore cannot be seen as a restriction of consumer choice (at least from a usage point of view). So the presumption before any detailed analysis should be that the introduction of zero rating does not restrict end-users' freedom, at least from the point of view of the direct impact on usages at ISP offer unchanged (before analyzing the impact of ISP offer in chapter IV). We will see in the following paragraph if this first presumption is effectively confirmed.

a) Impact of the zero rating offer on zero rated usages

The introduction of ZR has the following effects on zero rated usages:

- Using the zero rated application no longer generates an opportunity cost, as it does not reduce the data allowance available for alternative applications;
- Therefore the usage of zero rated applications is likely to increase by a certain amount, called  $Q^{add}_{ZR}$ , if the opportunity cost was previously a factor limiting the usage of that application. (cf. Figure 4).



Figure 4: Impacts on ZR usages

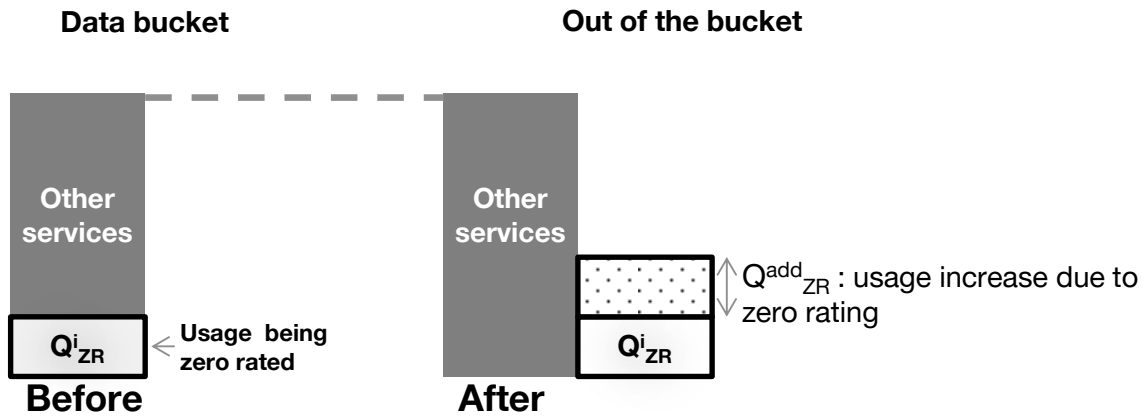

This effect positively impacts the end-user's freedom of choice as it increases zero rating usage.

b) Impact of zero rating on other non-competing non ZR usages

The direct effect of the ZR offer on the non-zero rated usages which do not compete with it is that part of the data allowance which was consumed by the ZR application becomes available for alternative usages (cf. Figure 5). The end-user has more data allowance available for these usages for the same price and can therefore increase their consumption. In that respect, the introduction of ZR has the same effect as a price reduction in a first step considering ISP offer unchanged (data allowance and price unchanged).

Another way of interpreting the same effect is that the introduction of ZR reduces the opportunity cost of the usage of these non-competing non ZR usages: using these services no longer reduces the possibility of using ZR services. The effect on end-users' freedom of choice is positive, as it leads to an increase in these usages.

If the zero rating offer consists of an add-on service, the result is the same, as the end-user can use more data from the general bucket for other services than the zero rated service, at the same price. The consumer chooses to pay to obtain unlimited data on the zero rated services but the reasoning remains the same, the consequences of the zero rating offer on non-competing non ZR services is to increase their usages.

Figure 5: Impact on non competing non ZR usages

Data bucket



c) Impacts on the usage of competing non ZR applications

This paragraph analyses the impact of introducing zero rating for an application of a given category (e.g. music streaming) on the usage of a competing application belonging to the same category (e.g. another music streaming service) which does not benefit from ZR. Our analysis distinguishes between equivalent usages shared by the two applications (e.g. identical pieces of music available on both applications) and differentiated usages between the two applications (e.g. music pieces available only on one platform) before analyzing the impact on the total usage of the competing application, including equivalent and differentiated usages.

*Impact of zero rating on equivalent usages of a competing application*

The introduction of zero rating may potentially have a negative effect on equivalent usages, as there is no need for example to use both Deezer and Spotify to listen to the same piece of music, except if there were differences in the quality of the recording (in which case, usages would not be equivalent, but differentiated).

The end-user arbitrates between her possible preference for the non-zero rating application and the gain resulting from the release of data consumptions thanks to zero rating offer.

If the ZR application is used, equivalent usages in competing applications, which we note here  $Q_{CZR}^E$ , may then be reduced to zero. This reduction frees data consumption for other usages, as shown Figure 6.

Figure 6: Impact on usages of a competing non ZR application

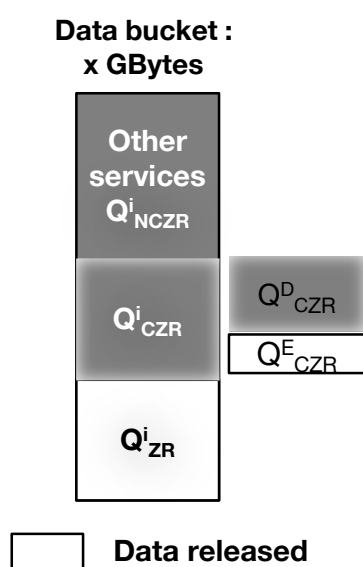

*Impact of ZR on differentiated usages of competing applications*

The introduction of zero rating has a direct positive impact on differentiated usages of competing applications: reduced average price of data or in other words, increase of potential usage thanks to the data allowance released. In that case, any transfer of equivalent usages from non-ZR to ZR can only increase the proportion of data allowance freed for differentiated usages of competing applications. If  $Q_{CZR}^E$  tends to zero, as suggested in the previous paragraph, then the data allowance available for alternative use will be equal to  $Q_{ZR}^i + Q_{CZR}^E$ .

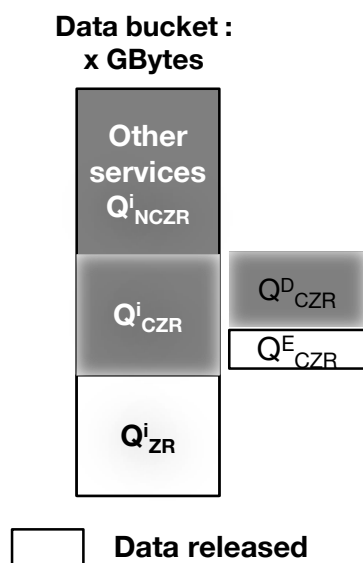

Overall, the impact on the consumption of application in competition with ZR application is neutral or positive if the ZR offer enables the end-user to increase her consumption of differentiated usages of applications in competition with ZR applications post ZR offer ( $Q^D_{CZR}$ ) up to the initial consumption of usages which are equivalent between the Zero Rated application and non-zero Rated applications ( $Q^E_{CZR}$ ).

The outcome for competing application providers will be positive if applications are sufficiently differentiated: in that case, the gain for differentiated usages will be larger than the loss for equivalent usages. It may be negative if applications are not significantly differentiated, as equivalent usages will be larger than differentiated usages, the negative impact on the former will be larger than the positive impact for the latter.

However, the global direct impact on the end-user's choice is positive, as she will be able to have a quantitatively higher and qualitatively more diversified usage of contents and applications. The allocation of usages between providers may however be modified if the data allowance is reduced post ZR offer, the consequences of which will be addressed in the second part of the analysis, dedicated to the indirect long term effects of the supply side of access and C&A.

Finally, it should be noticed that any possible switching cost from the end-user's point of view can only mitigate all the effects described above: negative on equivalent usages and positive on differentiated usages for the non ZR application, positive on equivalent and differentiated usages for the end-user.

d) General conclusion on the short term impact of ZR on end-users' choice

Therefore the detailed analysis of the effects of introducing ZR on a given offer confirms the first presumption: it has a positive direct effect on all end-user's usages and potentially on its differentiation. Therefore it enhances rather than restricts the end-users' freedom of choice. This is essentially due to the fact that excluding ZR consumption from the data allowance increases the data available for alternative usages.

#### IV. Impact of zero rating on IAS offers and on supply of content and applications

In the first chapter of this article, prices and volumes corresponding to the IAS offer including zero rating were considered as given and were not affected by the introduction of zero rating. In this second chapter, we will analyze how the introduction of zero rating may in the long run influence the characteristics of IAS prices and volumes in the market. In particular, we will assess whether zero rating may increase the price or reduce the allowance of data available for non ZR services, reducing their usage and hence restricting end-users' choice. Then we will also identify whether the introduction of a ZR offer may negatively affect the variety of contents and applications supplied by CAPs, reducing the usage of non ZR content or applications and thereby ultimately restricting end-users' choice.

In this chapter, two types of ZR will be studied: « pure ZR » for which the ZR data traffic is financed by the ISP, and « ZR with sponsored data » representing the case for which the CAP providing the ZR service fully pays the IAS for the data under ZR. We will study ZR impact on the ISP and the CAP supplies successively in those two cases.

Several parameters will be taken into account: whether the CAP and the ISP are vertically integrated, if the ISP or the CAP provider is dominant, and whether the sponsored data offer is open to all CAPs or not. A sponsored data offer is open if it is available without discrimination to all CAPs. It is closed if the ISP can decide which CAP may sponsor data and have its service zero rated.

##### 4.1. Impact of zero rating on the price and quantities of an IAS offer

The objective of this section is to study the potential impact of ZR offers on the price and the data volume of IAS offers. This analysis will depend on how ZR traffic is financed: by the ISP in the « pure ZR » case, or by the CAP in the « ZR with sponsored data » case.

###### a) Pure zero rating

With the introduction of zero rating, the initial consumption  $Q_{ZR}^i$  and the additional ZR consumption  $Q_{ZR}^{add}$  is given for free to the end-user when compared with the initial situation. This consumption outside the allowance, and therefore not directly financed by the end-user, still represents a cost which needs to be covered.

An operator does not launch zero rating offers to make losses, but to obtain a commercial benefit from this initiative. Let's consider two cases:

- 1) The operator launches this offer because it expects that it will better match market expectations but without any specific asset in this respect in comparison with its competitors. If this move actually provides a unilateral competitive advantage in the market, competitors will have both the incentive and the ability to replicate it. Ultimately the competitive balance between ISP will be restored together with the level of market power of each IAS provider, because providing a non-specific ZR service cannot in itself modify the market position of an IAS provider. Hence, as no element of market power can be attached to the introduction of ZR, this move will not change competitive intensity or market positions of IAS providers and as a consequence ISPs' margins will stay unchanged. As the ISP's total margin will stay unchanged, it will restore the margin lost on ZR traffic by increasing the price

or reducing the volumes available for non ZR usages, on the same offer or on other IAS offers available on the market. This will imply a reduction in the level of usage of non ZR services and therefore a restriction of end-users' choice.

- 2) The operator launches this offer to get an edge over its competitors, because the offer will be not replicable by other operators and because it increases the end-user's switching costs to change his ISP. This would typically happen in the case of an exclusive contract between the CAP and ISP. This would result in a reduction of competition and higher prices on the market. Depending on the circumstances and market positions of the CAPs and ISPs involved, it may also lead to competition law concerns which are out of scope of this paper.

Either way, the operator will compensate (case 1) or more than compensate in the long term (case 2) the cost of the zero rating offer by a relative price increase or a relative reduction of the data allowance available for other services. This can be interpreted as a cross-subsidy for the benefit of ZR services and to the detriment of non ZR services.

The above reasoning is illustrated below in Figure 7 by a numerical example exhibiting the mechanism of cross subsidy between ZR and non ZR services. Firstly to simplify, we will consider that the market situation stays the same with no gain of market power.

To keep the reasoning simple, we will consider that the operator provides only one IAS offer on the market, and therefore that the compensation effects are observed on this single IAS offer.

Let's take the example of a data allowance of 10 Gbytes at a price of 10€. This data allowance is consumed as follows:

- 3 Gbytes for the service about to be Zero Rated and ;
- 7 Gbytes for the other services.

Following the introduction of zero rating, the initial consumption of the ZR service of 3 Gbytes is no longer deducted from the data allowance. This allows an increase of the usage of the ZR services of, say, an additional 2 Gbytes. In addition, usages of non ZR services may also *a priori* increase up to 3 Gbytes within the data allowance, thanks to the fact that the initial 3 Gbytes of ZR service are no longer deducted from the allowance.

Figure 7: Sketch of the direct impact of ZR introduction

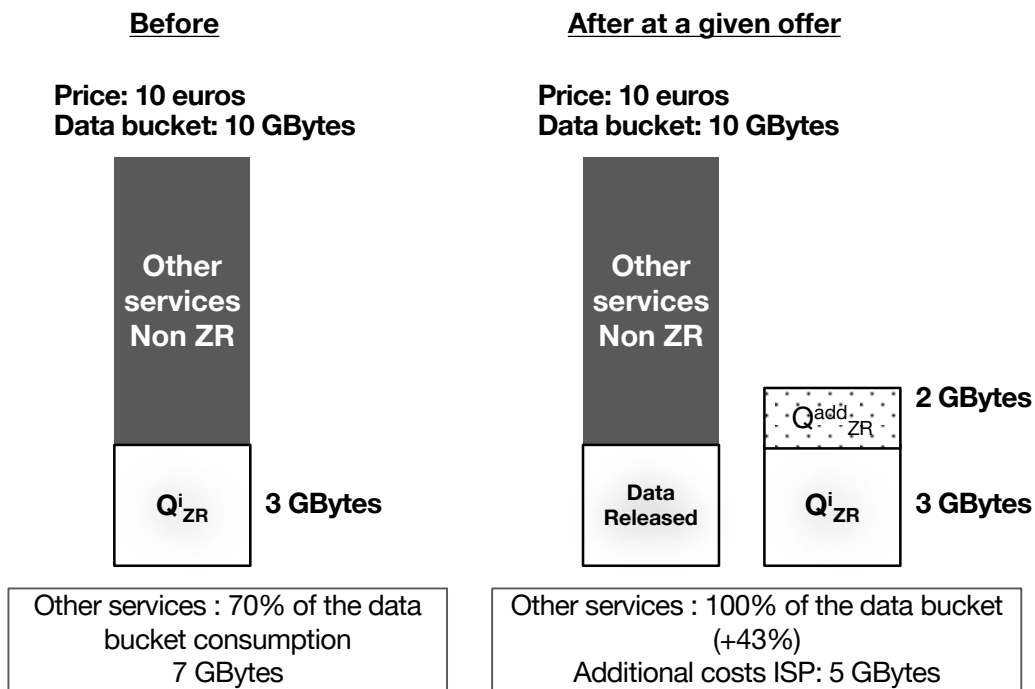

These increases of usages represent an additional cost for the ISP which has to be compensated, if the competitive intensity and therefore the margin remain constant in the IAS market.

The first step involves showing the modifications (volume and prices) to the IAS offer required in order to keep non ZR usages constant, to avoid extra costs.

Indeed, the ISP has two solutions to cover the extra costs of the implementation of the ZR offer:

- Decreasing the volume of the general data bucket;
- Increasing the price of the general bucket to take into account the extra costs. This option is economically rational even if it is an add-on ZR service where an additional fee is paid by the client for the ZR service. The add-on service generally offers a large discount in comparison with the current data price. So the ISP may be tempted to compensate for the low price attributed to ZR service in non ZR services.

Let's study, as a representative example, the case where the ISP decides to reduce the data bucket in order to compensate for the additional costs generated by a zero rating offer.

The first step involves defining what is the volume change which guarantees the same non ZR usage for the end-user. The former level of non ZR usage is unchanged if the data bucket is reduced from 10 Gbytes to 7 Gbytes for the same price (10 €) (see figure 8).

The end-user should be neutral to this change regarding his non ZR usages as she can keep the same consumption for the same price. She is, however, better-off in terms of global data consumption if ZR usage increases.

However, the ISP loses profits in this situation because the cost of the addition ZR usage freed up by the ZR offer is not covered, the ZR offer is free and the ISP market share stays the same. Therefore the ISP has no economic interest to stay in this situation.

Figure 8: Modification of ZR offer in order to keep non ZR usages constant

**AFTER IAS offer's evolution**  
**without impact on non ZR**  
**usages**

Price : 10 euros

30% decrease of the data bucket :

7 GBytes

Initial consumption of ZR financed

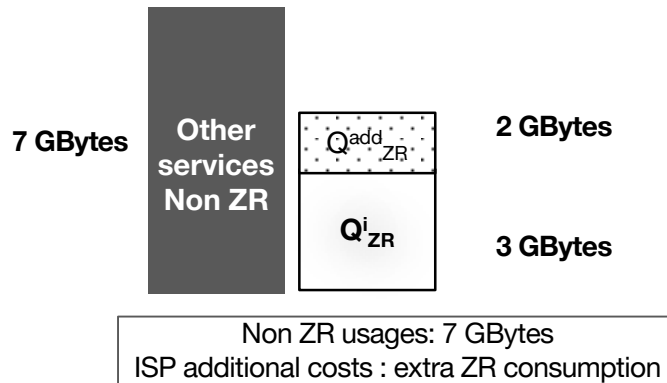

To fully compensate for the extra cost generated by the additional usage of the ZR service, the ISP would reduce the data bucket to 5 Gbytes which is less than the initial non ZR consumption as illustrated in Figure 9.

Figure 9: Impact of ZR on IAS offer to compensate additional ZR usages

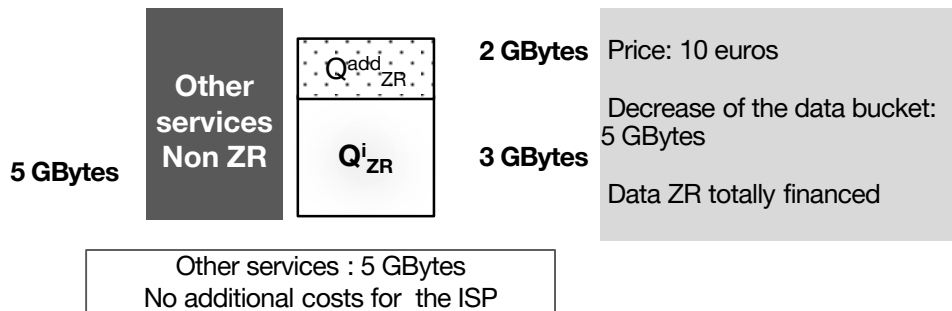

As Figure 9 illustrates it, the compensation by the ISP for the additional costs of the ZR offer is necessarily done to the detriment of other usages: in this case, data allowance becomes lower than the initial non ZR consumption.

In order to compensate for the cost of the extra traffic, the ISP may decide to implement an add-on service where the end-user pays an additional fee for zero rating certain applications with unlimited usage. Depending on the price of the zero rating add-on offer, the costs of the extra traffic may be fully or partially compensated, mitigating the negative impact on non ZR usages. But if the cost is fully compensated the ZR offer is no better for the client than asking and paying for a higher data allowance. As it is difficult for the ISP to fully predict the client's consumption, the client may pay less or more. In practice, some ISPs in Europe have opted for the implementation of an add-on service where the data unit price appears to be far less costly than for other usages. So in practice, the ISP

will finally also compensate by reducing the allowance for other usages or increasing the price of the general data bucket.

Illustrating the compensating effect on a single offer clearly demonstrates the negative impact for other usages. The effect would be the same from the point of view of compliance with the Open Internet obligations, if the compensation did take place on other IAS offers, even though it would be less visible.

The conclusion is the same whether it is the end-user or the ISP who selects the zero rated service. Even though pure ZR offers (in which the end-users choose the ZR application) do not raise concerns from the point of view of a limitation in end-users' choice (cf. section 2) they may, however, have restricting effects in the long run on the usage of non-zero rated services and ultimately on the supply of content and applications. These long run effects of ZR cannot be anticipated by individual users when they choose the ZR offer.

By negatively impacting the usages of non ZR services, the introduction of pure ZR therefore in principle may restrict end-users' freedom of choice. Hence it may not be compliant with the Open Internet provisions of EU Regulation 2015/2120, to the extent that this impact is quantitatively significant.

#### *Conditions for pure Zero Rating to have in practice a material impact on end users' choices*

This qualitative assessment should also take into consideration quantitative elements in application of the principle of proportionality of the EU electronic communications regulatory framework recalled in Recital (7) of Regulation 2015/2120 *"National regulatory and other competent authorities should be empowered to intervene against agreements or commercial practices which, by reason of their scale, lead to situations where end-users' choice is materially reduced in practice."* The actual impact of the above effects on the market may be benign or severe, depending on the market positions of the ISP and the CAP in their respective markets and of the volume of traffics concerned by Zero Rating relatively to the total traffic consumed by the end-user. The European Commission report (2017) illustrates this by stating that *"Detrimental effects from zero-rating would typically require there to be market power at some level, or an agreement or concerted practice that creates a network of agreements, and competitors being unable to replicate the underlying arrangement."* The fact that this statement is included in a report dedicated to competition law aspects of zero rating does not reduce its truth concerning the actual impact of zero rating and therefore its relevance for regulatory analysis.

If the IAS market is competitive, in the same circumstances, the client has the choice to switch to another ISP. The quantitative effects will be offset by the effects of competition and are likely not to be significant. Therefore prohibiting this practice would not comply with the principle of proportionality of regulation.

If the ISP is dominant and compensates for the extra costs of zero rating to the detriment of non ZR usages -ISP dominance implying that clients have *de facto* a reduced possibility to switch to another ISP, the negative impact on end-users' choice cannot be compensated by competitive forces in this case.

However, the impact will be material only to the extent that the level of data consumed by zero rated applications is significant compared to the typical data allowance of consumers. If this is not the case, the impact will not be significant and therefore prohibition would be disproportionate



notably considering that, as observed by the EC in its report (2017), zero rating is often applied for data-light applications.

#### b) Zero rating with sponsored data

In this section, we will suppose that there is no discrimination between CAPs in terms of access and conditions. This issue is treated in section 4.2..

Contrary to pure zero rating, zero rating with sponsored data provides revenues from CAPs to compensate the extra cost generated by the additional usage of ZR services. More precisely, as the market position of the ISP vis-à-vis end-users derives from its market position vis-à-vis content and application providers and vice-versa, its ability to price sponsored data above cost is equivalent to its ability to price IAS to customers above cost.

The wholesale price of sponsored data influences the competitive position of the IAS provider to the same extent as its retail IAS price.

If an IAS provider increases the sponsored data price for CAPs, the CAPs which provide paid on-line services with sponsored data will increase their prices for customers of this ISP. And CAPs which provide “free” on-line services with sponsored data financed by advertising will increase this ISP customers’ exposure to advertising. There is no need for those CAPs to have market power or to coordinate to act this way. It is just a trivial reaction to a variation of marginal cost in a competitive market. In both cases, paid or “free” on-line service, it reduces the CAP value for this ISP’s customers and therefore its competitiveness in the CA market. In other words, even though CAPs do not have direct bargaining power on ISP sponsored data price, they have both the ability and the incentive to pass-through sponsored data price variation in the price of their services to the ISP’s end users. Therefore any variation in the sponsored data price will be mirrored on the end users’ retail price (either monetary, or via personal data trading or through exposure to ads). As a consequence, sponsored data cannot be priced as a competitive bottleneck because price increases have a negative competitive effect on the ISP in the retail market.

Hence, neither a waterbed effect (related to insufficient price of sponsored data) nor an opportunity cost effect (related to excessive price of sponsored data) on non-zero rated services is likely to be observed. And at market equilibrium, the impact should be neutral on the IAS price for the use of non ZR applications.

In the case of market imperfection, implying that sponsored data is effectively priced above costs, regulation would be needed to require that sponsored data has to be priced at cost.

Consequently, zero rating with sponsored data should not have any negative impact on the data price for non-zero rated services. Therefore zero rating with sponsored data does not restrict end-users’ choice: neither by directly reducing their level of usage of non-zero rating services (as shown in section III), nor through a longer term increase in the price of data for non-zero rating usage (as shown in this section IV).

#### 4.2. Impact of zero rating on supply of content and applications

The impact of ZR on the supply of content and applications will be analyzed both in the case of pure zero rating and zero rating with sponsored data.

#### a) Pure zero rating

As developed in §3.1. pure zero rating implies cross-subsidies leading to relatively higher prices for the IAS traffic corresponding to non-zero rating usages and/or lower usages for non ZR services. The supply of non ZR service will be affected, which will restrict end-user choice. Hence pure zero rating may in principle restrict the end-users' freedom of choice.

In practice, the actual quantitative effect on end-users' choice may be benign or severe depending on the market position of the IAS and the Content and Application Providers.

If neither the ISP nor the CAP is dominant, the effects may be limited as competition takes place and the zero rating offers may involve different CAPs. There is little risk that the offer of contents and applications will be impacted.

If the CAP is dominant and the internet access market is competitive, all ISPs may need to replicate the ZR offer. This reinforces the dominance of the CAP and limits the offer of content and applications, which is detrimental for end-users' freedom of choice.

If the ISP is dominant and controls the choice of zero rated contents and applications, the cross subsidy effect is reinforced as the CAP chosen by the dominant ISP will have a significant comparative advantage on the market. This effect may also lead some CAPs to leave the market, reducing end-users' choice.

#### b) Zero rating with Sponsored data

Two cases are analyzed:

- Open sponsored data: the ISP offers the possibility to all CAPs to zero rate the usage of their services. All CAPs have the same non-discriminatory opportunity to pay to have their service Zero Rated for end-users.
- Closed sponsored data: the ISP selects CAPs which may pay to have the service zero rated for end-users. For the purpose of this analysis, the case of vertical integration between an ISP and a CAP is similar to the case of closed sponsored data agreements.

##### *ZR with open Sponsored data*

In the case of an open sponsored data offer, there is no discrimination between CAPs in terms of access and conditions. As shown in section §4.1, sponsored data should be neutral on the IAS traffic price for non ZR usage. There would be no restriction in usage or provision of non ZR services. Hence ZR with open sponsored data should be considered as compliant with the European Open Internet Regulation.

In addition, all things being equal, transferring network traffic costs from the end-user to the content or application provider improves market efficiency. This is because the content or application provider knows the service value and controls the amount of traffic as necessary to supply the service, whereas this is not the case for the end-user. Therefore the provider is better placed to select the optimal level of production, taking into account the network utilization and the service value. Hence, the possibility for the IAS provider to sponsor the data generated by its service improves the functioning of the market (**Cf. Jullien, Sand-Zantman (2015)**).

### *Closed sponsored data and vertical integration*

In the case where the ISP selects the CAPs which may sponsor the data generated by their services, non selected CAPs may be prevented from sponsoring data and thus deprived of the opportunity to develop the usage of their services. This restricts the development of such service and ultimately the freedom of choice of end-users by directing their choices. The impact on non-zero rated CAPs is all the more critical the more the selected CAPs are dominant. Indeed, if the CAP is dominant, it may impose excessively favorable terms on the ISP, which the ISP will have to compensate for at the expense of other CAPs.

In the same vein, in case of CAP – ISP vertical integration with dominance on the IAS market, the dominant ISP can cross subsidize its CAP activity to the detriment of the development of alternative CAPs and ultimately the choice of end-users. Therefore closed sponsored data restricts end-users' freedom of choice and is not compliant with the requirement of European Open Internet regulation.

## **V. Conclusion**

This article proposes formal criteria and reasoning to assess whether zero rating offers support or restrict end-users' freedom of choice and as such comply with the Open Internet provision of European Regulation 2015/2120. End-users' freedom of choice is considered as restricted if and only if the introduction of zero rating results in a reduction in the usage of non-zero rating services, through three channels: either directly through its impact on end-users' behavior, or indirectly through a relative increase in the IAS price for non-zero rated services, or through a reduction in the CA supply.

The main impact of the introduction of zero rated services in the short run for a given IAS offer is to increase the data allowance and to release consumption not only for ZR services but also for non ZR services. Detailed analysis of the impact on individual types of services does not modify this general conclusion. Therefore as such, zero rating does not have any negative short term impacts on end-users' choice.

Concerning the indirect impact on end-users' choice via the modification of IAS offers and the supply of content and applications, our analysis demonstrates that:

- Pure zero rating offers, where the cost of zero rated traffic is supported by the ISP, implies cross-subsidy for the benefit of zero rated services generating a relative price increase for non-zero rated traffic. This relative price increase can in principle limit non ZR usage, thereby restricting end-users' choice. The end user will be materially limited in her choices if ZR traffic represents a significant proportion of total traffic and if the ISP or the CAP is dominant in their respective markets as the user has little ability to switch to another ISP or CAP. However, if neither the ISP nor the CAP is dominant in their respective markets or if ZR traffic is small compared to the total traffic then these theoretical negative effects of Zero Rating will be diluted or compensated by competitive forces. In these cases, regulatory intervention would be disproportionate.
- Zero rating with open sponsored data is neutral on the price of non-zero rated services and therefore does not impact the usage of non ZR services. In addition, it improves the efficiency of market functioning compared to a counterfactual without sponsored data as the CAP is better-placed to know its service value and can better control the load it imposes on the ISP network than the end-user. Hence, ZR with open sponsored data does not restrict

end-users' freedom of choice, neither directly through impact on end-user's behavior, nor indirectly through supply restriction. Zero rating with closed sponsored data or vertical integration, could in principle hinder the supply of non-zero rated services and therefore in the long run restrict end-users' choice. However, if neither the ISP nor the CAP is dominant in their respective markets, or if ZR traffic is small compared to the total traffic, then again these theoretical negative effects of zero rating will be diluted or compensated by competitive forces and end-users' choice will not be materially restricted in practice. Therefore, regulatory intervention would be disproportionate as such material restriction is required by European Open internet regulation to justify intervention.

## References

Belgian institute for postal services and telecommunications (2017): *Report regarding the analysis of zero-rating of apps in the Proximus offers*. January 2017

BEREC (2017): *Report on the implementation of Regulation (EU) 2015/2120 and BEREC Net Neutrality Guidelines - BoR (17) 240*

European Commission (2017): *Zero-rating practices in Broadband market*  
<http://ec.europa.eu/competition/publications/reports/kd0217687enn.pdf>

Economides, N. & E. Hermalin (2015): *The Strategic Use of Download Limits by a Monopoly Platform*. The RAND Journal of Economics, Vol. 46, Issue 2.

Federal Communications Commission (2017): *Policy Review of Mobile Broadband Operators' Sponsored Data Offerings for Zero-Rated Content and Services*. 12th January 2017.

Gautier, A. and R. Somogyi (2018). *Prioritization vs zero-rating: Discrimination on the internet*. Working Paper. Available at [http://www.lcii.eu/wp-content/uploads/2015/01/IODE4\\_Somogyi\\_PrioritizationVsZeroRating.pdf](http://www.lcii.eu/wp-content/uploads/2015/01/IODE4_Somogyi_PrioritizationVsZeroRating.pdf).

Krämer, J. & Peitz, M. (2018): *A Fresh Look at Zero-rating*.  
[http://www.cerre.eu/sites/cerre/files/CERRE\\_ZeroRating\\_FinalReport.pdf](http://www.cerre.eu/sites/cerre/files/CERRE_ZeroRating_FinalReport.pdf)

JULLIEN B. & SAND ZANTMAN W. (2015): *Internet regulation, two-sided market and sponsored data*. IDEI working paper. <http://idei.fr/sites/default/files/IDEI/documents/wp/2016/supplementary.pdf>

JULLIEN B. & SAND ZANTMAN W. (2015): *Internet regulation, two-sided market and sponsored data*. International Journal of Industrial Organization, 58. pp. 31-62.

LAYTON R. & ELALUF-CALDERWOOD S. (2015): *Zero Rating: Do Hard Rules Protect or Harm Consumers and Competition? Evidence from Chile, Netherlands and Slovenia*. Mimeo.

REGULATION (EU) 2015/2120 OF THE EUROPEAN PARLIAMENT AND OF THE COUNCIL of 25 November 2015 laying down measures concerning open internet access and amending Directive 2002/22/EC on universal service and users' rights relating to electronic communications networks and services and Regulation (EU) No 531/2012 on roaming on public mobile communications networks within the Union.  
<http://eur-lex.europa.eu/legal-content/EN/TXT/?uri=CELEX%3A32015R2120>

SOMOGYI R. (2017). *The Economics of Zero-rating and Net Neutrality*. Core discussion paper, 1st March 2017

