

Renold, Ursula; Bolli, Thomas; Wolter, Stefan C.

Research Report

Does it pay for firms? Costs and benefits of the SkillsFuture Earn and Learn Programme in Singapore

KOF Studien, No. 115

Provided in Cooperation with:

KOF Swiss Economic Institute, ETH Zurich

Suggested Citation: Renold, Ursula; Bolli, Thomas; Wolter, Stefan C. (2018) : Does it pay for firms? Costs and benefits of the SkillsFuture Earn and Learn Programme in Singapore, KOF Studien, No. 115, ETH Zurich, KOF Swiss Economic Institute, Zurich, <https://doi.org/10.3929/ethz-b-000280711>

This Version is available at:

<https://hdl.handle.net/10419/184909>

Standard-Nutzungsbedingungen:

Die Dokumente auf EconStor dürfen zu eigenen wissenschaftlichen Zwecken und zum Privatgebrauch gespeichert und kopiert werden.

Sie dürfen die Dokumente nicht für öffentliche oder kommerzielle Zwecke vervielfältigen, öffentlich ausstellen, öffentlich zugänglich machen, vertreiben oder anderweitig nutzen.

Sofern die Verfasser die Dokumente unter Open-Content-Lizenzen (insbesondere CC-Lizenzen) zur Verfügung gestellt haben sollten, gelten abweichend von diesen Nutzungsbedingungen die in der dort genannten Lizenz gewährten Nutzungsrechte.

Terms of use:

Documents in EconStor may be saved and copied for your personal and scholarly purposes.

You are not to copy documents for public or commercial purposes, to exhibit the documents publicly, to make them publicly available on the internet, or to distribute or otherwise use the documents in public.

If the documents have been made available under an Open Content Licence (especially Creative Commons Licences), you may exercise further usage rights as specified in the indicated licence.



Report

Does it Pay for Firms? Costs and Benefits of the SkillsFuture Earn and Learn Programme in Singapore

Author(s):

Renold, Ursula; Bolli, Thomas; Wolter, Stefan

Publication Date:

2018-07

Permanent Link:

<https://doi.org/10.3929/ethz-b-000280711> →

Rights / License:

[In Copyright - Non-Commercial Use Permitted](#) →

This page was generated automatically upon download from the [ETH Zurich Research Collection](#). For more information please consult the [Terms of use](#).

KOF Swiss Economic Institute

Does it Pay for Firms?

Costs and Benefits of the SkillsFuture Earn
and Learn Programme in Singapore

Prof. Dr. Ursula Renold, Dr. Thomas Bolli and Prof. Dr. Stefan Wolter

KOF Studies, No. 115, July 2018

Does it Pay for Firms?

Costs and Benefits of the SkillsFuture Earn and Learn Programme in Singapore

KOF Swiss Economic Institute
Division Education Systems
ETH Zurich
Leonhardstrasse 21
CH-8092 Zürich

and

Economics Department
Centre for Research in Economics of Education
University of Bern
Schanzeneckstrasse 1
Postfach 8573
CH-3001 Bern

Authors:

Prof. Dr. Ursula Renold
Dr. Thomas Bolli
Prof. Dr. Stefan Wolter

Acknowledgements

This study is financed by SkillsFuture Singapore Agency (SSG). We are extremely grateful to the firms who helped us carry out the questionnaire. SSG was also key in identifying, contacting, and following up with the firms, whose responses are the foundation of this study.

The data has been gathered in the name of and on behalf of SSG. The content of the study reflects the view of the authors and may not represent the view of SSG. All mistakes remain our own.

Executive Summary

Research question and methodology

The SkillsFuture Earn and Learn Programme (ELP) targets graduates from the Institute of Technical Education (ITE) and Polytechnics. During the programme’s 12-to-18-month duration, ELP participants spend about 20% of their time in classroom education at the ITE and Polytechnics and 80% in structured workplace training. In order to introduce the programme in 2015, participation of both students and firms was subsidized. This raises the question of whether these subsidies are necessary in the long run, so this research project aims to measure the costs and benefits of the ELP from the perspective of firms. The methodology uses a mixed-method design that combines quantitative surveys of both participating and non-participating firms with qualitative interviews among firms that participate in the ELP.

Results

Figure I summarizes the results of the quantitative survey. The first column shows that firms incur costs of about S\$50,000 per year, mostly from participant labour costs and on-the-job training costs. The second column displays the benefits of firms, which amount to about S\$38,000 per year. The productive value is the most important benefit, followed by subsidies and saved adjustment costs. In total, the ELP yields the net costs. The black bar shows the net cost, which is about S\$12,000.

Figure I: Summary of costs, benefits and net costs

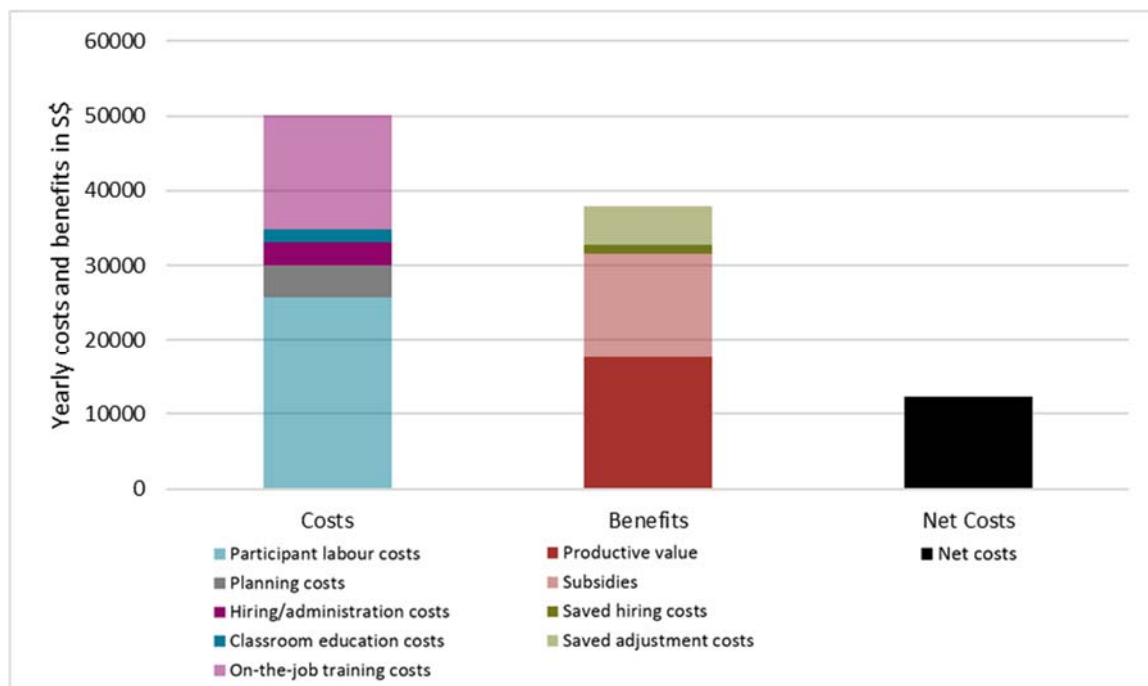

Notes: N=30

Policy options

The ELP is definitely a step forward for improving the transition from the education system to the labour market for Singapore's young generation. All interviewees value the ELP as a necessary and important contribution to solving the labour market shortages. That enthusiasm can already be seen as preliminary success for the ELP.

SkillsFuture Singapore Agency (SSG) is interested in evidence from the early stages of the ELP development and commissioned this cost-benefit study. One of the research questions concerns how the ELP can be improved. This gives SSG the opportunity to eliminate any problems while the programme is still new so that the ELP can be developed into a sustainable and attractive programme for all. Reform experience has shown that one cannot know from the outset how various actors will react in such a complex initiative. It is always necessary to identify what works and what the potential for improvement might be.

Conducting detailed research at this very early stage in the ELP is far-sighted on the part of SSG. If research were delayed, it would likely be much more difficult to make changes with more companies and students involved. With the present study, SSG has a strong foundation for evidence-based changes toward implementing a sustainable and attractive programme. We summarize some of the options for constructive change in the following.

1. Retain current ELP setup

The results suggest that average net costs are about S\$12,000 per participant per year, which is relatively high compared to average total costs of about S\$50,000. Since firms face net costs even after the deduction of substantial subsidies, retaining the current ELP setup limits the programme's potential to expand from two sides. First, a limited number of firms are willing to accept the net-costs. Second, the government is restricted in the ability to expand the number of firms receiving subsidies. Therefore, we do not recommend pursuing this variant further.

2. Change ELP parameters to decrease net costs

In the medium and long term, reducing the high net costs should be a focus. This would improve the programme's attractiveness for firms, therefore increasing the number of firms. This would be essential to reaching the long-term goals of the Industry Transformation Maps.

a. Decrease wages of ELP participants

ELP participants receive 84% of the wage of a skilled employee. For an education and training programme, this average wage is very high, particularly since ELP participants spend about 20% of their time in classroom education. Thus, a "fair" wage that accounts for the expenditures of firms for training and the non-productive time of ELP participants would be substantially lower. In comparison, trainee wages in countries with a long tradition of dual VET programmes are only a small fraction of skilled wages in the same occupation (Switzerland ca. 20%, Germany ca. 25% and Austria ca. 35%). Hence, decreasing the wage of ELP participants (*ceteris paribus*) is one possibility to decrease net costs to firms.

b. Increase ELP duration

Currently, the ELPs last between 12 and 18 months, which is relatively short compared to dual VET programmes in Austria, Germany and Switzerland (which last 3 to 4 years). Since ELP participants' productivity increases over

time, increasing the duration of the programme can make the ELP more attractive to firms. Alternatively, the ELP could be an integrated part of the Polytechnics or the ITE. Similarly, increasing commitment of students to firms reduces the risk that participants leave the firm after the ELP, thereby reducing ELP net costs. However, an increase of the duration would only improve the cost-benefit ratio for firms if it were combined with a reduction of participants' relative salaries (see a.) or an increase in their productivity (see c.).

c. Other measures to improve productivity

Regardless of the ELP duration, measures should be tested to increase the productive use of ELP participants. These can include extending the time in firms when ELP participants work productively, reducing the time used for un- or semiskilled tasks, and measures that increase the productivity of ELP participants while substituting skilled employees.

For example, net costs could be reduced by combining extended programme duration with digressive classroom time (for example 30%/20%/10% classroom education in the first/second/third part of an ELP, respectively). Even without classroom education in the final period, ELP participants would continue to receive workplace training and thereby further improve their skills and employability.

d. Streamline administrative processes

Net costs of ELP can be reduced by minimizing the administrative burden on firms and Polytechnics. This could be achieved, for example, through e-services or through cooperation of firms in the same sector (see 2e).

e. Foster cooperation among firms

Creating institutions (or using existing professional associations) that facilitate knowledge exchange and the development of standardized blueprints for the ELPs across firms decreases the ELP's net costs and induces spillovers across firms. This is a particularly important step in getting SMEs to offer the ELP.

3. Target subsidies more specifically

The section on theoretical foundations underlines that subsidies should only be distributed if there are no deadweight effects for the government. As the results and interviews show, the current ELP cannot rule out such windfall gain effects for firms. However, the situation varies from sector to sector and between small and large firms. Therefore, the distribution of subsidies should take this heterogeneity into account.

a. Focus subsidies on ELP preparation

High fixed costs of developing on-the-job blueprints can prevent firms from offering ELP places even if ELP participation is optimal. The entry barrier created by these fixed costs is particularly relevant for SMEs. Hence, focusing subsidies on covering fixed costs of implementation improves participation with lower risk of deadweight losses.

b. Focus subsidies on covering costs of classroom education

A potential drawback of subsidies is the potential incentive to accept subsidies as windfall gains while underinvesting in training quality. Focusing subsidies on covering the 4% of classroom education costs reduces this issue.

c. Make subsidies size- and sector-specific

The higher importance of fixed costs for SMEs illustrates that ELP net costs differ across ELP sectors and firm sizes. Therefore, the ideal scheme calculates subsidies based on ELP and firm characteristics. The results of this study support the claim that net costs are heterogeneous by firm size and provide first data to implement such a system, though the sample size remains insufficient to draw definite conclusions.

4. Increase attractiveness of ELP for students and firms

Potential revisions of the ELP should balance the incentives of firms and students, since reducing the attractiveness of the ELP for students diminishes either their willingness to participate at all or the ability level of interested students. Keeping student incentives in mind matters particularly because decreasing their wages or increasing the programme duration (*ceteris paribus*) might diminish attractiveness.

a. Clarify location of the ELP in Singapore's education system

The ELP currently has two separate strands for graduates of ITE and Polytechnics, respectively. Our interviews with firms have indicated that firms view these two types of ELP participants differently, with those from Polytechnics being deemed to have a more far-reaching career plan than their ITE counterparts.

Furthermore, firms are not always clear about the relationship between the ELP and other initiatives. For example, several firms compared ELP participants to interns from Polytechnics. Another firm compared ELP participants to employees who pursue continuing education in evening classes. Since the attractiveness of a programme partly depends on how well it can signal its value to future employees, sharpening the ELP profile helps improve its attractiveness to students and to firms.

Clarifying the location of the ELP in the education system might also help avoid differences in expectations between firms and ELP participants. Concretely, one firm coined the term "Learn and Earn" rather than "Earn and Learn", referring to its identification of ELP participants as students rather than employees. This kind of differences in expectations matters particularly because firms consistently consider motivation and attitude as key employee abilities.

In addition, firms complain that participants see the ELP as only an intermediate phase on the way to a university degree. Since the government uses a lot of money to attract both students and firms to the ELP and thereafter into the workforce, the ELP should not be an easy path to university. Permeability also is important for ELP students, but each programme should have a main purpose and clear additional requirements for moving on to further or alternative options.

In a broader context of creating Universities of Applied Sciences (UAS; a second type of university) in Singapore, the ELP could have better positioning for both ITE and Polytechnic students. One option is to make an ELP and 2-3 years of professional experience prerequisites for entry into a UAS, comparable to requirements in Switzerland or Germany. If such UASs would offer part-time study options, this would help individuals keep working in firms while studying at the university.

b. Improve signalling value

The workplace training component of the ELP follows a firm-specific on-the-job blueprint. In addition, participants must pass classroom education in Polytechnics to earn their ELP certificates but there is no corresponding performance requirement in workplace training. The power of an ELP certificate as a signal might be improved if programme content were more homogenous and if a specific level of workplace performance were required. An alternative would be to integrate the ELP as part of a formal diploma granted by the Polytechnics and/or the ITE. This would earn the ELP recognition from the Ministry of Education and position it as a “learn and earn” programme. In any case, the involvement of industry associations would be very important.

Regular surveys on the ELP’s value and firms’ satisfaction with it can help to highlight the programme’s particular benefits. Information campaigns and interviews with firms’ CEOs can also help raise awareness.

c. Improve awareness

The ELP only has been around for about three years and is not known well among firms and potential participants. Hence, raising awareness among these groups will help expand the project by attracting more participants.

Since there is not yet high demand among students or firms for the ELP, new policy directions need to account for both groups’ follow-on effects. Therefore, we recommend simultaneously introducing a combination of several above-mentioned measures.

Some measures can be implemented with immediate effect, while others require cooperation and interface management with other institutions. The latter should be considered in the medium or longer term.

We also recommend repeating a comparable study at regular intervals to measure whether new evidence-based measures are effective. In Switzerland for example, cost-benefit studies are carried out every four years.

Another option for SSG would be to simultaneously estimate the effects of a combination of measures using a simulation study. If reforms of occupations are carried out in Switzerland, a simulation study must be carried out before implementing the reform in order to show its effect on costs and benefits for training companies.

Table of contents

- Executive Summary ii
- List of Figures viii
- List of Tables viii
- List of Selected Abbreviations ix
- 1. Introduction 1
- 2. Education System of Singapore 2
 - 2.1. Overview of the Education System 2
 - 2.2. Description of ELP 4
- 3. Theoretical Foundations 6
- 4. Methodology and Data 9
 - 4.1. Stylized Illustration of Costs and Benefits 9
 - 4.2. Simple Accountancy Framework 11
 - 4.3. Limitations of the Methodology 13
 - 4.4. Quantitative surveys 14
 - 4.5. Qualitative interviews 17
- 5. Costs and Benefits of the ELP 20
 - 5.1. Costs of the ELP 20
 - 5.2. Costs and Benefits Components of ELP 23
 - 5.3. Total Benefits of the ELP 25
 - 5.4. Total Net Costs of the ELP 26
 - 5.5. Break-Even Analysis 27
- 6. Decisions of Firms to participate in ELP 29
 - 6.1. Why do Firms Participate in the ELP? 29
 - 6.2. ELP Characteristics 34
 - 6.3. Satisfaction 38
- 7. Discussion, Conclusions & Recommendations 44
- 8. References 49
- 9. Appendix I: Additional Tables 51
- 10. Appendix II: Biographies of Authors 62
- Imprint 64

List of Figures

Figure 1: Overview of the Singaporean education system.....	3
Figure 2: Location of the ELP in Singaporean education system.....	4
Figure 3: Stylized illustration of costs and benefits of ELP.....	11
Figure 4: Simple Accountancy Framework.....	13
Figure 5: Share of ELP cost categories.....	21
Figure 6: Costs of ELP.....	22
Figure 7: Costs and benefits of ELP during the programme by ELP sector.....	24
Figure 8: ELP benefits by category.....	25
Figure 9: Net costs of ELP.....	26
Figure 10: Relative wages.....	27
Figure 11: Relative wage and relative break-even wage.....	28
Figure 12: Relevance of qualification and turnover for firm competitiveness.....	30
Figure 13: Turnover rate.....	31
Figure 14: Quantity and quality of labour market supply.....	32
Figure 15: Number of applications per skilled position.....	33
Figure 16: Relevance of motives to participate in ELP.....	34
Figure 17: Most suitable ELP sector for non-participating firms.....	35
Figure 18: Barriers to participation.....	36
Figure 19: Relevance of ELP characteristics.....	38
Figure 20: Satisfaction with the ELP.....	39
Figure 21: Relationship between sector-averages net costs and satisfaction.....	41
Figure 22: Continuation of participation.....	42
Figure 23: Heterogeneity of continuation.....	43

List of Tables

Table 1: Overview of analysed ELPs.....	5
Table 2: Sample and response rates.....	15
Table 3: Costs and benefits of ELP.....	51
Table 4: Relationship between ELP participation and skill demand indicators.....	52
Table 5: Heterogeneity of skill demand indicators across ELP sectors.....	53
Table 6: Relationship between ELP participation and relevance of ELP characteristics.....	54
Table 7: Relationship between ELP participation and relevance of motives to participate in ELP.....	54
Table 8: Heterogeneity of relevance of ELP characteristics across ELP sectors.....	55
Table 9: Heterogeneity of relevance of motives to participate in ELP across ELP sectors.....	56
Table 10: Relationship between skill demand indicators and satisfaction with ELP.....	57
Table 11: Relationship between net cost determinants and satisfaction with ELP.....	58
Table 12: Relationship between skill demand indicators and continuation of ELP.....	59
Table 13: Relationship between net cost determinants and continuation of ELP.....	60
Table 14: Heterogeneity of barriers to participation in the ELP across ELP sector and firm size.....	61

List of Selected Abbreviations

- CVC.....Curriculum Value Chain
- ELP..... SkillsFuture Earn and Learn Programme
- SME.....Small and Medium Enterprises
- SSG..... SkillsFuture Singapore
- VET Vocational Education and Training

1. Introduction

Singapore's Industry Transformation Map aims to transform the country's economy in the face of a shifting and changing economic environment.. The SkillsFuture movement is an important piece of this transformation puzzle. It aims to help individuals make well-informed choices, provide high-quality education and training, promote merit-based career developments and foster lifelong learning. Furthermore, SkillsFuture is part of the solution to the lack of skilled employees in some sectors, which can affect sector growth.

To this end the SkillsFuture Singapore Agency (SSG) initiated the SkillsFuture Earn and Learn Programme (ELP) in 2015. It aims to give individuals a head start in their careers and to enhance employer ownership and participation in the skills development of the workforce. The ELP is a work-learn programme that targets fresh graduates from the ITE and Polytechnics. According to the official information on the SSG website, ELPs are managed by Polytechnics and the ITE (see Table 1). The programme currently covers 28 sectors and may expand to more in future. The programme lasts between 12 and 18 months, and combines structured workplace training with classroom education at Polytechnics.

The government subsidizes the ELP. Eligible Singapore citizens receive a sign-on incentive of S\$5,000 for completing the ELP. Mirroring these incentives, firms receive a grant of up to S\$15,000 for each individual they host as part of the ELP. The employer grant aims "to defray the costs of developing and providing structured on-job-training and to encourage them to set out career progression pathways" (SkillsFuture 2017b). Since the ELP is very new, it remains *a priori* unclear whether these subsidies are necessary and helpful to motivate firms in providing ELP places. This is particularly true because the combination of multiple learning places complicates a simple cost-benefit analysis. This study analyses whether subsidies are appropriate by exploring the following research questions:

- i. What is the financial net cost to firms who participate in the ELP?
- ii. What is the employer grant amount required to drive employer participation?
- iii. How does Singapore's model compare with those in other countries?
- iv. What are the success factors for the programme?
- v. How can the programme be enhanced further?

In order to answer these questions, the next section provides an overview over the education system in Singapore and locates the ELP within that framework. The following section develops the theoretical foundation of the report, followed by a description of the empirical methodology. Sections 5 and 6 discuss the empirical results regarding net costs and motives to participate in the ELP, respectively. The last section summarises our findings.

2. Education System of Singapore

2.1. Overview of the Education System

Figure 1 displays an overview of the education system in Singapore, including the location of the ELP (see MOE, 2017 for a detailed discussion). The education system can be separated into six years of primary education, between four and five years of secondary education, followed by post-secondary education. Compulsory education includes children aged between 6 and 15 (IBE, 2010/11).

Students enrol in secondary education at age of about 13 years. They have four main choices. Express programmes last four years and lead to the Ordinary Level of the Singapore-Cambridge General Certificate of Education (GCE O). Two Normal programmes last four years and end with GCE N(A) and N(T), denoting Normal (Academic) and Normal (Technical), respectively. Students in the Normal (Academic) programme and with good grades can take a fifth year of schooling and the GCE O examination. Hence, permeability between secondary programmes is high, and students have various options to change programmes. Finally, students in the Integrated Programmes take the pre-university examination after six years of study, the GCE A for Advanced Level (IBE, 2010/11; MOE, 2015a; MOE, 2015b; KOF 2015).

Students with a completed GCE N(T) have two options on the post-secondary level. They can pursue National ITE Certificate (Nitec) programmes at the ITE or a GCE N(A) (MOE, 2015a). GCE N(A) holders have even more options. This includes the one-year Polytechnic Foundation Programme, the two-year Direct-Entry Scheme to enter the Polytechnics, Higher Nitec programmes at the ITE, and taking the GCE O examination (MOE, 2015b). Students with a GCE O can also enter pre-university programmes at the ITE, Polytechnics or junior colleges (IBE, 2010/11). Additionally, participating in Integrated Programmes for two years allows one to attempt the GCE A, which grants access to universities (MOE, 2015a).

Figure 1: Overview of the Singaporean education system

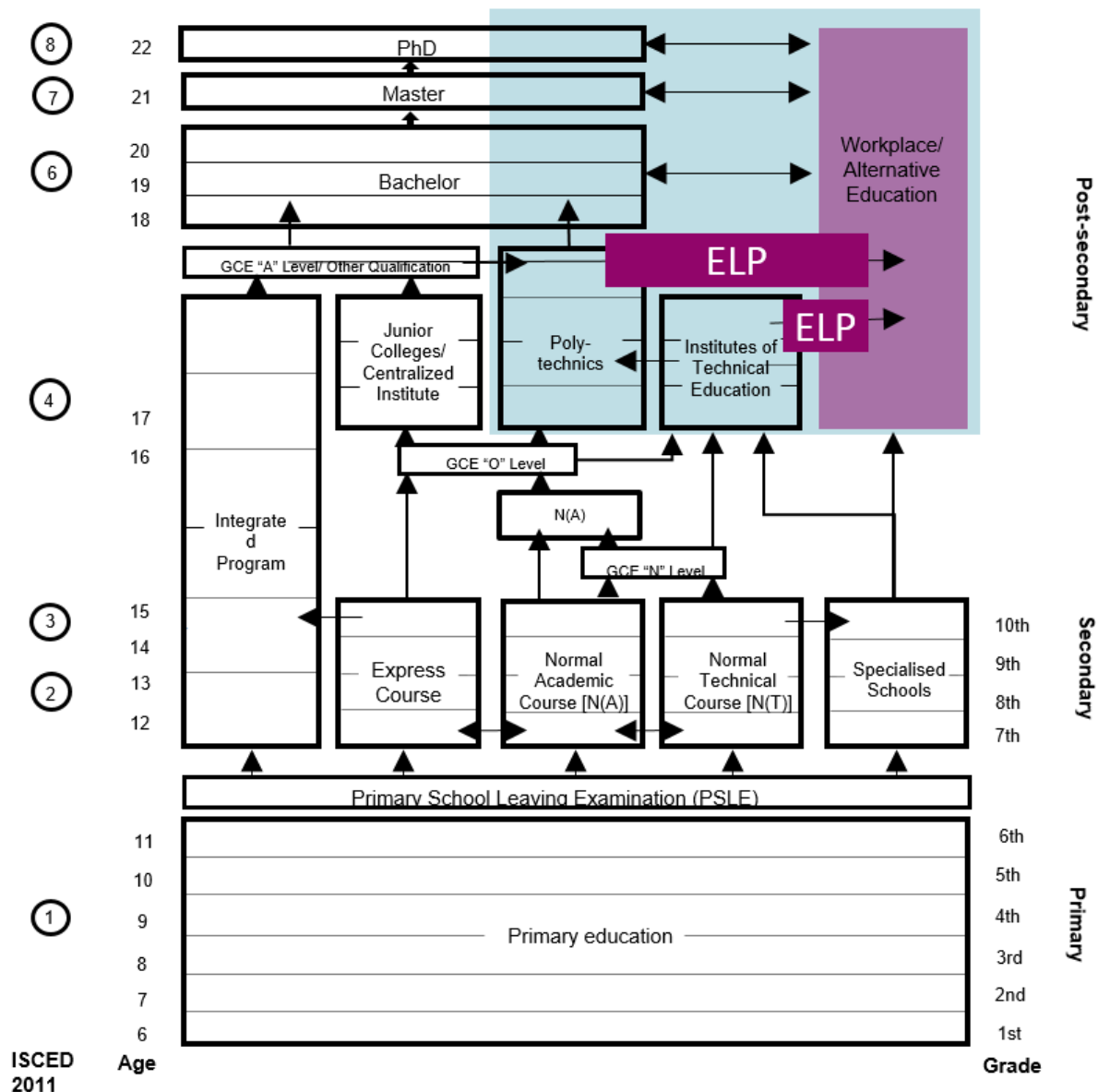

Source: Own depiction based on Renold et al. (2016) and MOE (2017)

Figure 2 focuses on the blue area in Figure 1, clarifying the options available to ITE and Polytechnic graduates. The first option for ITE graduates is to enter a Polytechnic, the second is to enter the workplace without returning to the formal education system, and the third option also leads into the workplace but returns to the formal education system after a short duration of work experience. Like the latter two options, entering the workplace through an ELP also offers the choice between joining the workforce indefinitely and continuing to study at a Polytechnic.

Polytechnic graduates face similar options, with the exception that the path in the formal education system continues with a Bachelor degree. However, like ITE graduates, the ELP for Polytechnic graduates can be either an entry ticket into the workforce or an interlude there.

Figure 2: Location of the ELP in Singaporean education system

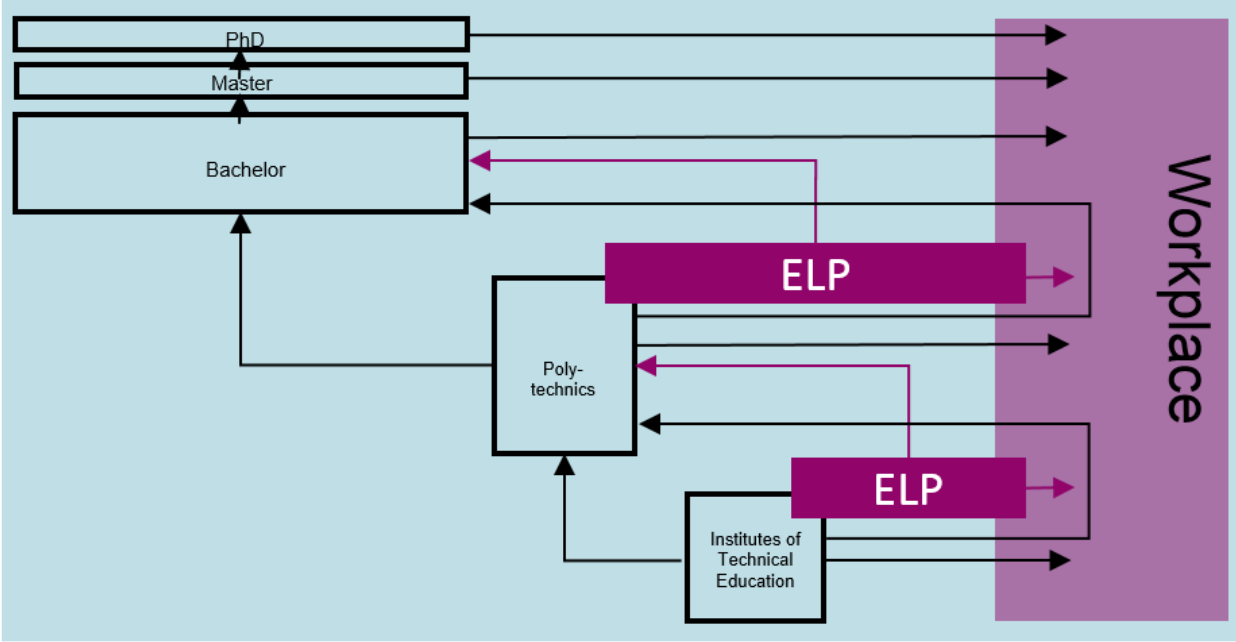

Source: Own depiction based on Renold et al. (2016) and MOE (2017)

2.2. Description of ELP

The ELP is a relatively new programme at the interface of the workplace and vocational education and training on the post-secondary level. Figure 1 shows that the ELP’s target group consists of graduates from Polytechnics or ITE, who are Singaporeans or Singapore permanent residents and who have graduated or finished national service within the previous three years. The first of these participants entered the programme in 2015.

The programme differentiates among what it calls ELP sectors, which roughly correspond to occupational fields. The number of ELP sectors has increased over time from 9 initially to 28 currently (SkillsFuture 2015, 2017a). Different ELP sectors lead to different qualifications (SkillsFuture, 2018). Most commonly, ELPs for ITE graduates lead to one or two Certificates that can be credited towards a Diploma. ELPs for Polytechnic graduates usually lead to a n Advanced Diploma, Specialist Diploma, or Qualification under the Singapore Workforce Skills Qualification framework (SkillsFuture, 2017b).

Table 1 shows an overview of the ELPs analysed in this study, revealing that most of the ELPs we included require participants to hold a Polytechnic diploma. The only exception is the Air Transport sector, which also allows entry for ITE graduates.

Table 1: Overview of analysed ELPs

ELP Sector	ELP Certificate	Programme Manager	ELP Duration (months)	Entry Requirement
Air Transport	WSQ Higher Certificate in Aerospace	Temasek Polytechnic	12	ITE/Polytechnic graduates
Biomedical Science	Specialist Diploma in Veterinary Clinical Practice	Ngee Ann Polytechnic	12	Polytechnic graduates
Design	Specialist Diploma in Visual Communication	Nanyang Polytechnic	12	Polytechnic graduates
Electronics	Specialist Diploma in Wafer Fabrication	Temasek Polytechnic	12	Polytechnic graduates
Facilities Management	Specialist Diploma in Sustainable Facilities Management	Ngee Ann Polytechnic	12	Polytechnic graduates
Food Manufacturing	Advanced Diploma in Applied Food Science	Singapore Polytechnic	18	Polytechnic graduates
Hotel	Specialist Diploma in Hospitality Business Management	Republic Polytechnic	12	Polytechnic graduates
ICT	Specialist Diploma in Information Systems Development	Nanyang Polytechnic	12	Polytechnic graduates
ICT	Specialist Diploma in Cyber Security	Singapore Polytechnic	12	Polytechnic graduates
Logistics	Specialist Diploma in Supply Chain Management	Republic Polytechnic	12	Polytechnic graduates
Media	Specialist Diploma in Games Development (Design)	Nanyang Polytechnic	14	Polytechnic graduates
Power Engineering	Specialist Diploma in Electrical Design & Operations	Ngee Ann Polytechnic	12	Polytechnic graduates

Source: SkillsFuture (2017b)

Table 1 further shows that the ELP lasts between 12 and 18 months depending on the ELP sector. The content of the programme varies across ELP sectors, but generally combines about one day of classroom education at a Polytechnic with about four days of work and on-the-job training in a firm.

In order to induce graduates and firms to participate in the programme, the SSG pays ELP participants S\$5,000. Similarly, firms receive up to S\$15,000¹ for each participant, which is intended to cover the costs of developing and providing a structured training programme and to encourage the setting-up of career progression pathways (SkillsFuture, 2017). These payments are independent of programme length.

¹ The cost-benefit analysis assumes that firms receive the full amount of subsidies.

3. Theoretical Foundations

Who should pay for the investment?

Investments in human capital not only increase individuals' wages and firms' profits, but also the competitiveness and the growth of nations (Hanushek and Woessmann 2012) and thereby the well-being of societies. Although many parties benefit from investments in human capital in the optimal situation, the answer to who should pay for the investment is not always straightforward. The economically efficient answer to this question is that those who benefit from the investment should pay the costs of education and training. However, it is not always clear who will benefit from investments in human capital as such investments can create positive externalities (benefits to those who did not invest) or help to prevent negative externalities (costs of non-education that are shifted to others).

Becker's theory adapted

In the context of firm-provided training, classical human capital theory (Becker 1962) stipulates that—in competitive labour markets—employees should cover all costs of investments in general human capital. For firm-specific human capital, employers and employees should share the investment costs. General human capital is defined as all skills and knowledge that an employee can use across many firms, whereas firm-specific human capital describes knowledge and skills that are not transferable from the current employer to other firms.

However, empirical observations show that firms invest quite frequently in general human capital. Since this contradicts the theory, adaptations of the theory are necessary to better fit reality.² Since the 1970s there have been many such extensions of the original theory. Most, but not all, have in some way or another loosened the assumption that labour markets are competitive. If labour markets have frictions, then these frictions allow firms to invest in their employees' general human capital without risking loss of the investment. They can recoup the investment later by paying wages below employees' marginal productivity. Aside from that, employers that invest in training can save money even in competitive labour markets by reducing turnover or by signalling better working conditions and thereby attracting more talented and motivated applicants.

Very often, however, labour market frictions come with a cost, for example higher levels of unemployment, and not all the firms can enjoy the same amount of training-investment protection from labour market frictions (e.g. Muehleemann et al. 2013). Therefore, in order to explain differences in the incidence of training provision between countries, economic sectors or individual firms, the focus has recently re-shifted to the question of the conditions under which and extent to which firms can provide general human capital without running into net costs.

These questions are of particular relevance in labour markets that come close to a competitive labour market³ or for SMEs. Small firms are more likely to lose their participants after training

² See Wolter and Ryan (2011) for an extensive overview of theories explaining the provision and the financing of firm based training.

³ Comparative analyses of the financing of apprenticeship training countries that run very similar apprenticeship programmes, Austria, Germany and Switzerland, show remarkable differences in the net-costs for firms depending on the labour market frictions and regulations (see Muehleemann et al. 2010 and Moretti et al. 2017).

than big employers who can offer internal labour markets. Therefore, SMEs have to rely on the productive contributions of participants during the training period to cover their training costs.

Net costs of training are important

Most firms are not able to rely completely on labour market frictions to cover their training investments. Hence, firms' expected net costs of training by the end of a training programme is one of the most important indicators in firms' decision process of whether or not to provide training places for a given programme. When firms expect to have uncovered net costs at the end of training, this does not automatically exclude the provision of training. Instead, expected net costs tell the firm how much benefit it will need to extract from participants either during or after the training programme⁴.

In the context of the present study, we employ a calculation method (see Section 4 for more details) that has been extensively used to measure the costs and benefits of apprenticeship training in German-speaking countries over the last three decades (see Muehlemann und Wolter 2014 for an overview). Although the ELP in Singapore is not directly comparable as a training scheme with the aforementioned apprenticeship programmes, the method of calculating its costs and benefits from the perspective of the training firm are the same.

The cost-benefit calculation framework we use covers all costs and expenditures for training as well as the productive contribution of participants during the training period. This yields the net-costs at the end of the training period. Additionally, we estimate post-training benefits that firms can accrue in the period after training through saved hiring and adjustment costs. This part of the calculation stems from the aforementioned cost-benefit surveys in German-speaking countries. Recent empirical research has shown that this part of the model is necessary to give a complete picture of the training decisions of firms (see Blatter et al. 2016), since firms may accept net costs at the end of the training period if they know they will have significant benefits afterwards.

Although the participation of firms in any firm-based training model is the *conditio sine qua non* for the functioning of such a system (without firms there is no firm-based training), such a training scheme cannot work properly if it does not generate a positive rate of return for its potential participants as well. If a firm were to try to maximize its return on a training programme at the expense of participants, it might not find sufficient or sufficiently talented applicants for its further programmes.

It is easily understandable that most of the parameters in the cost-benefit model for firms have a direct link to the individual rate of return for participants, although we cannot calculate these individual rates of return to training for the participants with the data we collected (discussed in section 4.3). If, for example, firms reduce participant wages in order to cut the costs of the training, it increases the net-benefit or decreases the net-costs of firms. At the same time, however, the wage cut also decreases the net-benefit for participants. Similarly, if the programme increases the time participants spend in off-site schooling, it reduces the productive contribution of participants to the firms and thereby increases the net-costs for firms, but might increase participants' later earnings because such programmes might develop higher-productivity graduates.

⁴ E.g. in the case of reputation effects, the benefit is not linked to the training of an individual participant, but rather to the fact whether the firm provides training at all.

One has to bear in mind that, although some linkages are straightforward in their consequences, some interventions or programme features may affect many parameters in the model simultaneously and it is therefore not always clear *ex ante* whether changes increase or decrease net costs for firms and the rates of return for programme participants.

Potential benefits for the state

The third partner to consider in our model is the state. The state potentially benefits in several ways from training investments by firms and individuals. Firms become more profitable, individuals earn more, and consequently both pay more taxes. Additionally, investments in training and education help to reduce social transfers paid by the government. In the absence of externalities to training investments, the government could tax the benefits of these investments without having to make investments on its own.

However, investments in education and training produce externalities that may lead to an underinvestment by firms and individuals. As a result, most governments try to incentivize firms and individuals to invest more in training and education by subsidizing these activities. The government can do this in different ways, for example by paying for educational services or directly paying subsidies to firms that are active in education. By thus reducing the costs of training and education for firms and individuals, the government increases the net benefit of training for firms and increases the rate of return to education for individuals, at the price of lowering the fiscal rate of return to education. As long as cost- and benefit-sharing between the three parties is such that all get a positive return to training and education, this sharing can lead to a win-win-win situation.

State investment should have causal impact on the behaviour of firms and individuals

From the perspective of the government it is important to recognize that an investment like a subsidy only generates more wealth if the investment has a causal impact on the behaviour of the other two actors—firms and individuals. If a firm would offer the same number of training places with or without subsidies, then government intervention would just change the cost-sharing but not produce a different outcome in terms of wealth created.

Although we cannot calculate the fiscal return to training in this analysis, the cost-benefit outcome for training firms helps the government decide whether additional public funds are needed to produce a better outcome. If that were the case, we would show that subsidies cause higher incidence of training. If a sufficiently high number of firms can offer training places without having to bear net costs at the end of the programme and training generates a positive rate of return to education for the participants, a government intervention might only produce a deadweight loss. Finally, we must note an inherent limitation to a static measurement of cost and benefits of training for firms. Because the net costs we measure are already the consequence of existing government subsidies, net costs prior to subsidy payments are a necessary but not a sufficient condition for government intervention. If firms expect the government to pay subsidies, they might have less inclination to search for ways of minimising the costs and maximising the benefits of the training programme. It could well be that in the absence of government subsidies, firms would find ways to reorganize the programme such that it would lead to a break-even situation even without subsidies. In other words, it is possible that the static view would not hold from a more dynamic perspective.

4. Methodology and Data

In order to analyse the costs and benefits of participating in the ELP, this study uses a simple accountancy framework based on the theoretical foundations described in the previous chapter. The data-gathering process follows a mixed-method design that combines quantitative online surveys with face-to-face interviews. This section discusses the empirical framework, followed by a description of the sample and the data-gathering process.

4.1. Stylized Illustration of Costs and Benefits

Before describing the accountancy framework employed in this study, the following paragraphs discuss a stylized illustration shown in Figure 3. The simplification allows us to highlight the various levers that can be used to change the costs and benefits of the ELP, thereby preparing the ground for our later holistic policy analysis.

Productive value and training costs over time

The horizontal dimension of Figure 3 represents time, while the vertical dimension captures firms' returns to training in terms of the development of the productive value and training costs. Starting on the left shows the time before the start of the ELP. Assuming perfect labour markets, individuals' productive value in this time is equal to wages they could earn before participating in the ELP. We label this the unskilled wage as opposed to a skilled wage though it refers to individuals with post-secondary education. During the ELP itself, the productive value of the participant increases as they become more and more skilled at the tasks of a skilled job. After the ELP, the participant receives the post-training wage. As discussed in section 3, this post-ELP wage can be equal to the individual's productive value under the assumption of perfect labour markets, but can also be lower if labour market imperfections exist.

During the ELP, wages of participants are not market-based but are largely defined by the ELP guidelines. While they often increase during the programme, the figure assumes constant wages for simplicity. Hence, the pink line showing training costs, of which participant wages are the most important part, remains constant.

Since the productive contribution of ELP participants is low at the beginning of the ELP, the wages of ELP participants are often higher than their productive value. Hence, the space marked in grey space is an investment period during which training costs exceed the participant's productive value. During the investment period, firms face net costs due to providing the ELP place. At some point, when the ELP participants become more productive and are entrusted with tasks that create a higher value-added for the firm, their productive contributions should exceed the firms' costs for training and the participant wage. In this period, the ELP participants create a net benefit to the firm.

If overall the net costs in the first period are lower than the net benefit in the second period, the programme already creates a net benefit to the firm by the end of the programme. If, however, the net costs in the first period are higher than the net benefits in the second, the

programme ends with a net investment on the part of the firm – an investment that has to be recouped after the programme has ended if the model is to work without modification.

Potential levers to stimulate net-cost changes

This illustration also helps us consider potential levers affecting the net costs of the ELP. The most obvious lever is training costs; reducing ELP wages would reduce net costs. Furthermore, other measures that reduce training costs—such as a reduction in the administrative burden on companies—also help balance the costs and benefits of the ELP.

Conversely, there are many opportunities to decrease net costs by increasing the productive value of ELP participants. Examples include reducing the time spent on classroom education and concentrating classroom education in the beginning of the ELP when participants are less productive. Another example is to concentrate content that provides the foundation for necessary workplace skills—for example safety procedures—at the beginning of the ELP. A less obvious determinant of participants' productive value is the social status of the ELP. Higher social status of the ELP means better participants will self-select into the programme, and better participants have higher productive value from the beginning without any training investment from the firm. Furthermore, the learning curve of such participants is steeper. Therefore, net costs diminish.

Another important lever is the ELP's duration. Increasing the duration of ELP increases the length of the return period, thereby decreasing net costs.

This discussion has assumed that costs and benefits need to balance out during the programme itself for the ELP to attract firms. However, if we allow for imperfect labour markets, there is a further option for firms to balance out their training costs. If ELP participants remain with the firm after the end of the programme, firms can accrue additional benefits by paying wages below workers' productive value.

The illustration also clarifies the differences in the perspectives of ELP participants and firms. Concretely, participants' productive value in the investment period is lower than their wages, which are the most important component of training costs. Therefore, ELP participants make a profit in the investment period. Conversely, in the return period, participants' productive value exceeds their wages and participants take a loss. ELP participants are willing to make this investment because they know that the increase in human capital improves their productive value in the time after the ELP. Put more simply, participants accept lower wages in the return period in order to 'pay' for their training. Hence, the future value of the gap trained and untrained wages is the payoff for ELP participants, due to which they are willing to accept a wage below their productive value during the ELP.

Figure 3: Stylized illustration of costs and benefits of ELP

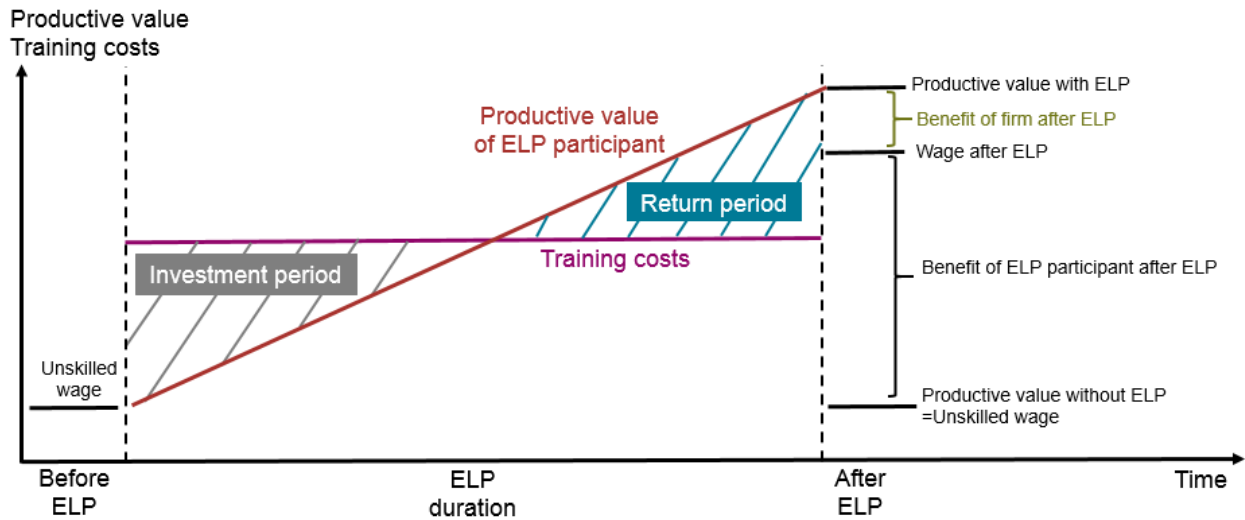

Notes: Own depiction based on Schweri et al. (2003, p. 29)

4.2. Simple Accountancy Framework

The methodology used in this study follows a simple accountancy framework (see Muehlemann and Wolter 2014) that compares costs and benefits of the ELP from the perspective of firms as summarized in Figure 4.

Five cost categories

Costs of the ELP can be placed in five cost categories. The first category is the **labour and material costs of planning the ELP**. This mainly includes developing the on-the-job training blueprint. Costs in this category arise primarily from the firm's first wave of ELP participants, even though the on-the-job blueprint may be adapted slightly to each specific position or ELP participant.

The second category of costs is for **management of the ELP**. This includes time used by personnel to select participants and to conduct job interviews. Material costs of the hiring process are relatively low for ELP participants since interested students are matched to firms by the Polytechnics. Hence, firms need to pay less for advertisements than in a system in which they compete for students in a marketplace, though some firms make substantial efforts to court potential students, for example by presenting the ELP in Polytechnic classes and going to roadshows. These firms aim to attract the best ELP participants, which goes on to affect their returns to training. Aside from the hiring process, this cost category also entails the personnel and material costs arising from ELP administration during the programme.

The third category is for **costs for classroom education**. First and foremost, this entails the payments of firms to Polytechnics for courses and teaching materials used during classes at Polytechnics. Classroom education costs also includes costs for other courses the ELP

participants attend, either provided by another education provider or conducted by the firm itself.

The main component of the **on-the-job training costs** is the time participants' co-workers are unable to do their usual tasks. Similar to these opportunity costs of personnel, the ELP might induce opportunity costs of capital. Concretely, training might require ELP participants to use a machine for training that could not be used for production during the time of training. Alternatively, the firm might buy equipment that is used only for training but not for the production of goods and services. In addition, on-the-job training costs include costs of training materials that are consumed during training.

Finally, costs of ELP also contain the **labour costs of the ELP participant**. Labour costs include four components. In addition to gross wages, they entail irregular payments such as annual bonuses, overtime pay, irregular bonuses and commissions. Labour costs further include allowances such as transportation costs, meal allowances and other allowances. Since labour costs evaluate costs of labour from the perspective of firms, they further entail employer contributions to CPF, pension funds and insurance premiums, the skills development levy and jobs credit pay-outs.

Benefits of ELP

Summing up planning, hiring/administration, classroom education, on-the-job training and participant labour costs yields the costs of the ELP. Net costs of the ELP during the programme duration are calculated as costs minus the benefits the firm receives from the ELP during the programme duration.

One component of these benefits are the **subsidies** that the firm receives from the government.

The second component stems from the **productive value of ELP participants**. This productive value arises when the ELP participant is neither attending courses nor doing exercises that produce no value. In that time, the ELP participant is working—either doing tasks that could be performed equally well by an unskilled employee or doing tasks for which training is necessary. Comparing the activities in the beginning and end of the ELP suggests that the share of skilled work increases and that the productivity of the skilled work goes up over time.

Net costs during and after the ELP

Knowing the costs and benefits during the programme duration allows us to calculate the net costs of the ELP during the programme's duration. However, in order to calculate the total net costs, we also need to take into account the benefits of the ELP after the programme's duration. These benefits arise if the participant remains in the firm after the end of the ELP. Therefore, the ratio of ELP participants a firm can expect to retain is a key element of the firm's benefits (see Blatter et al. 2016).

If an ELP participant remains in the firm, the firm saves the material and personnel costs of hiring a new employee. Similarly, ELP participants are familiar with firm specificities since they have been working in the firm for 12 to 18 months. Therefore, retaining an ELP participant further creates benefits in terms of saved adjustment costs. These adjustment costs include the initial reduced productivity of a newly hired employee, costs of any courses the newly hired

employee takes, and the opportunity costs of co-workers who cannot work because they need to show and explain the workflow to the newly hired employee (disruption costs).

Figure 4: Simple Accountancy Framework

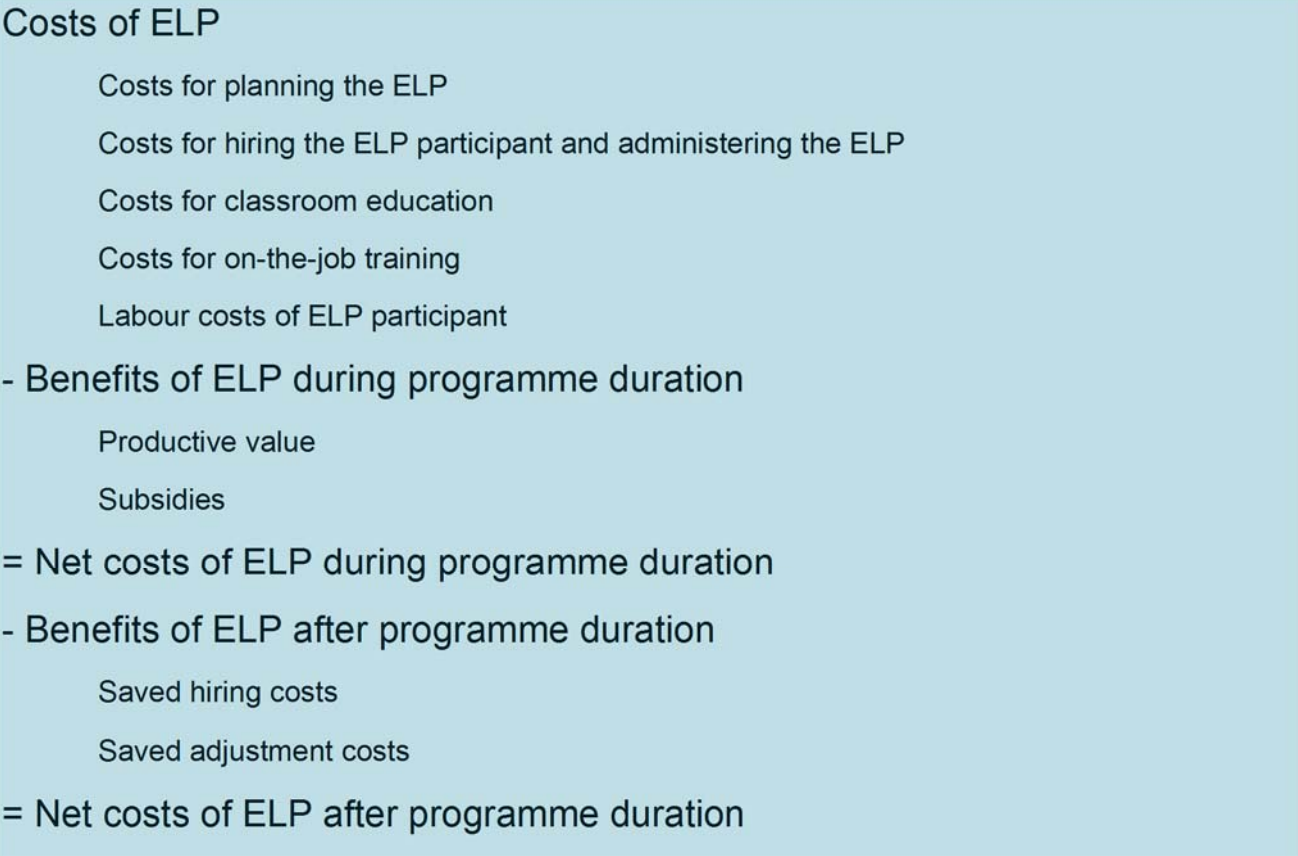

4.3. Limitations of the Methodology

The applied methodology has three limitations. The first limitation arises because the data stems from a survey of firms rather than access to detailed accounting data. As with all surveys, the reliability of the data depends largely on the sample size. Survey data is prone to measurement errors and might not to capture all cost categories in the necessary level of detail. However, it should be noted that no accounting scheme have been created to measure the costs and benefits of the ELP at this point, so any measurement of the ELP’s costs and benefits has to rely to a certain extent on qualitative survey data.

The second limitation arises because the study focuses only on the costs and benefits of the ELP for firms. Hence, the study fails to capture returns to individuals and furthermore does not account for the costs of teaching and administration at Polytechnics or administrative costs for the government. Additionally, wider individual, institutional and social benefits are not covered.

The third limitation of the study is its focus on the short-run effects of the ELP for individual employers only. In the long run, the ELP might increase the overall supply of skilled employees for the labour market, thereby alleviating negative effects arising from skill shortage. This type of general equilibrium effect is particularly important in a small country such as Singapore that

relies substantially on human capital for economic growth (Quah and Toh, 2012). Hence, it is important to note that firms that train ELP participants might create positive external effects for other firms. If the participating firms encounter net costs for training, this could lead to an underinvestment in training from a societal point of view (Quah and Toh, 2012). Hence, subsidies might be necessary to prevent underinvestment. However, analysing these externalities remains beyond the scope of this project, which focuses on the private costs and returns to firms in the short run.

4.4. Quantitative surveys

The quantitative part of the project can be further separated into two components. The first component is an extended survey among firms that have participated in the ELP.

The survey contains the detailed questions necessary to calculate the ELP's costs and benefits based on the accounting framework discussed in detail below. Furthermore, the questionnaire includes a number of questions that characterize the decision of firms to provide ELP places. Examples include the satisfaction of the firm with the ELP, the relevance of various ELP characteristics and the labour market shortage of skilled employees in specific ELP occupations. Finally, the survey concludes with a few general firm characteristics such as firm size.

Sample and response rate

The online survey was sent to all firms who had trained an ELP participant by the end of October 2017. This restriction ensures that participating firms are able to respond to the survey, which was sent out in the beginning of October 2017. The first email invitation was followed by an email reminder after two weeks. Importantly, SSG phoned non-responding firms to convince them to participate in the survey.

Based on these reminding mechanisms, 30 firms out of a population of 172 firms responded to the survey. Table 2 shows that this is a response rate of 17%, which is quite good for such an extensive survey. In order to analyse a potential non-response bias, Table 2 also reports response rates by firm size and ELP sector. The results show that the response rate of SMEs and large firms are similar. Furthermore, the response rate is relatively stable among ELP sectors with more than 10 firms. The only exception is the F&B Services sector, for which we have not received any responses. Nevertheless, these results provide suggestive evidence that non-response bias is negligible, implying that the results of the survey can be largely interpreted as representative for the whole population.

Table 2: Sample and response rates

	Population	Sample	Response rate (%)
Participating firms			
Total	172	30	17
Firm size			
Small or medium-sized firm	79	15	19
Large firm	93	15	16
ELP sector			
Aerospace	2	0	0
Air Transport	1	1	100
Biomedical Science	4	1	25
Design	25	2	8
Electronics	8	2	25
F&B Services	11	0	0
Facilities Management	8	3	38
Food Manufacturing	11	5	45
Hotel	24	6	25
ICT	16	2	13
Logistics	37	4	11
Marine	3	0	0
Maritime	1	0	0
Media	6	2	33
Power Engineering	12	2	17
Retail	3	0	0
Non-participating firms			
Declining firms	68	3	4
Non-declining firms	7501	178	2

Even though a response rate of 17% is quite high for such an extensive survey, the resulting sample of 30 firm surveys remains very small for statistical analysis. Hence, the results of this study are more akin to a case study analysis than to a multivariate statistical analysis. The small sample also suggests that the empirical results are prone to a higher degree of measurement error and should be considered with caution. Also, because heterogeneity across ELP sectors is quite large, averages over all firms should be treated with caution. Due to the small population of Air Transport firms, we do not show results for this ELP sector. Finally, the small sample size limits our findings' external validity. Therefore, although the results can be considered valid for the responding firms, an extension of these results to non-responding firms is certainly limited.

Data quality and imputation

Apart from the sample size problem, the data quality is limited by missing values because some firms refused to respond to particular questions such as employee wages or have not fully completed the survey. However, since the survey tool saved responses as respondents went to the next survey page, the study can use the responses of these incomplete surveys as well as additional information.

Since the final calculation of net costs is only possible for observations with data in all relevant variables, we had to impute missing values. Given the small sample, we choose to impute missing values using the average of the ELP sector. In the case of missing information on wages, we used statistical data regarding occupation-specific median gross wages for wages of unskilled employees in three ELP sectors (Ministry of Manpower, 2016a) for imputation. Concretely, we used median wages of hospital and clinic attendants in the ELP for Biomedical Sciences sector, median wages of cleaners in the real estate services industry for the ELP for Facilities Management sector, and median wages of cleaners and helpers in the accommodation industry for the ELP for Hotel sector. Similarly, the wages of human resource personnel in the ELP for Biomedical Sciences sector was imputed with the median gross wage of human resource and associate professionals in the business services industry (Ministry of Manpower, 2016a).

In order to correct for statistical outliers, we replaced the lowest/highest values within three occupational groups with the second-lowest/highest value. The three occupational groups were created based on a rough industry classification, namely, manufacturing/electricity production activities (Food Manufacturing, Electronics, Power Engineering), transportation and storage/accommodation/real estate activities (Logistics, Air Transport, Facilities Management, Hotel) and professional, scientific and technical activities (Biomedical Science, Media, Design, ICT). For the variables capturing the share of activities performed by the ELP participant, the replacement was based on the lowest/highest values of time spent in productive manner.

In order to ease responding, the survey questions refer to different periods, for example to hours per week or to total hours over the whole programme duration. Hence, the study needed to make additional assumptions regarding the average working days per month and average paid working hours per week. Concretely, we assume that employees are entitled to 11 public holidays (Ministry of Manpower, 2017a) and have the annual leave entitlement of 14 days per year, which is about the median of the population in 2016 (Ministry of Manpower, 2016b). Furthermore, we assume that normal working hours of employees is 44 hours each week (Ministry of Manpower, 2017b) divided across 5 working days, the most common working arrangement in 2016 (Ministry of Manpower, 2016b).

Finally, in order to ensure that costs and benefits can be compared across ELP sectors with varying programme durations, all calculations refer to yearly values.

Non-participating firms

The second component of the quantitative analysis covers non-participating firms, shown in the lower part of Table 2. We sent a substantially reduced part of the survey for participating firms to firms that had not (yet) participated in the ELP. The information provided by non-participating firms mirrors the motivation of participating firms and therefore helps us understand why some firms participate in the ELP and others do not (see also Wolter et al. 2006). The survey for non-participating firms focuses mainly on reasons for or against providing ELP places.

The sample of non-participating firms can be decomposed into firms that have been contacted regarding ELP but declined to participate (Declining firms) and firms that are involved in training but have not been registered as being contacted by the Polytechnics regarding the ELP (Non-declining firms). The population of declining firms is 68 firms, of which only three responded despite email reminders for a response rate of only 4%. The sample of non-declining firms is substantially larger (7,501). Nevertheless, we reduced the survey for these firms to the bare

minimum to account for the fact that these firms might never have heard about the ELP, which likely reduces the propensity to respond to the survey. Despite this measure, the response rate for non-declining firms was only 2%, or 178 observations.

4.5. Qualitative interviews

The qualitative interviews were conducted in two waves. The first wave of interviews took place after the first version of the quantitative survey had been developed but not sent to firms yet. The second wave took place after the quantitative survey had been conducted. The following paragraphs discuss the general direction of the interviews, while the insights stemming from the interviews enter the discussion of results throughout the study.

First wave: context and feasibility of survey

This first wave of interviews consisted of 13 interviews. Three of these interviews took place with the programme managers of the ELP. The other ten interviews were with human resource personnel, supervisors and mentors from firms participating in the ELP. Each interview at the firm premises took about an hour.

The **interviews with polytechnics** had three main goals: to develop a general understanding of the ELP, to discuss cooperation between Polytechnics and firms, and to test whether the survey formulations are comprehensible. Regarding the general understanding, an **important insight** was that some Polytechnics were **sceptical about a longer programme duration or lower wages of ELP participants** since attracting students into the programme is already difficult when students primarily desire a university degree. Furthermore, reaching male students is a challenge because of the military service creating a gap between Polytechnic attendance and ELP participation.

Some Polytechnics also mentioned that the **matching process** of students to firms is conducted manually at the Polytechnic and is hence very **time consuming**. This is also true regarding the cooperation of Polytechnics with firms. Apart from cooperation in terms of matching students and firms, Polytechnics also help firms write the on-the-job training blueprints in accordance with ELP requirements. Furthermore, cooperation appears very heterogeneous, as it focuses on the administrative requirements in some cases while including in-depth consultation in other cases, including regular visits to the firms.

Discussion of the survey suggested that the questions are generally comprehensible, though some definitions should be clarified based on examples. An example is the difference between practicing and on-the-job training. Furthermore, the distinction of unskilled and skilled work was not perfectly clear.

The **interviews with firms** during the first wave of interviews had similar goals, but with a particular focus on discussing survey item formulation. As did the Polytechnic interviews, firm interviews generally supported the survey design and helped clarify some definitions. In particular, the discussion helped us distil examples for unskilled work and practicing that could be used in the survey to clarify the meaning of the terms.

The firm interviews also demonstrated **heterogeneity in cooperation intensity between firms and Polytechnics**. While one firm was substantially involved in developing the teaching content

for classroom education at the Polytechnic, other firms only cooperated with Polytechnics for the matching process and the adjustment of the on-the-job training blueprints to administrative requirements.

Second wave: Data verification and improvement of ELP

The second wave of interviews consisted of eleven interviews with firms. These interviews aimed to develop further general understanding of the ELP and where firms see room for improvement, thereby providing the substantial background information necessary to interpret the results of the quantitative analysis. These interviews are also important inputs for our discussion of potential improvements.

Second-wave interviews also verified a number of responses that were statistical outliers in the data. This turned out to be important, as some apparent outliers accurately represent the situation in a firm and were not a misunderstanding of a question. For example, the interviews supported that the **development of the on-the-job training blueprints requires substantial time investment**. On the other hand, certain questions like the share of tasks conducted by the ELP participants turned out to be more difficult to answer and often implied an overly high amount of practice time.

General views

In general, the creation of the ELP is welcomed by all persons interviewed and is considered appropriate and necessary. Interviewees agreed on the fact that there are too many university graduates. Correspondingly, students' expectations for the speed of their career progression are not appropriate. Critical comments either come from very small companies for which net costs are too high or from companies that consider the ELP too isolated from the actual curriculum provided by the ITE or Polytechnics.

In all ELP sectors, the demand for well-trained professionals with good working attitudes and soft skills is very high. Graduates of Polytechnics are also credited with having the intellectual potential for rising through in-company careers. They are therefore preferred over participants recruited from the labour market for a particular position in the company. However, these companies simultaneously complain that most ELP students want to directly enter a university after finishing the ELP. Companies therefore hope that further development of the ELP will enable them to keep ELP participants in the company for at least a few years to show them their career opportunities on the company-internal labour market.

Company networks and professional associations

Cooperation with Polytechnics is received differently across companies. On one hand, it is perceived as somewhat bureaucratic and time-consuming, while on the other it is seen as an exclusive relationship between Polytechnics and single firms hoping for recruitment advantages for ELP students.

Some firms (especially in hotels or food manufacturing) wish to have an exchange with other companies in the same industry. They could also imagine that an industry association might take over certain tasks and thus relieve the burden on individual companies. For example,

such an association might develop a harmonized on-the-job blueprint for the ELP in each ELP sector.

Alignment of curriculum content between ITE/Polytechnics and ELP

Some interviewees see potential for improvement by better linking Polytechnics' curriculum content with that of the ELP. At present, companies find that some Polytechnic courses are not relevant, other interviewees said mandatory industry-level courses should be part of the curriculum, and some of company representatives think they should be involved in grading.

Furthermore, interviewees criticized that ELP participants are considered and treated as classical students. One interviewee said, 'ELP participants felt more like students than as staff; it should be a "Learn-and-earn-" not "Earn-and-learn programme"'. In this context, there is also the criticism of many interviewees that ELP participants are not sufficiently prepared to fulfil the expectations of companies. This is particularly evident in job interviews, where it is often not clear that ELP participants are interested in the position (lack of motivation) and will work with the **necessary attitude**. Schools could do more here to raise awareness that work ethics, motivation and soft skills are crucial to succeeding in the job market (e.g. through career guidance).

Interviewees state that it would be important for ELP participants to be received as adult learners who want to improve their daily work. This could be done, for example, by better linking theoretical content with practical examples from the companies, or by discussing practical projects at Polytechnics/ITE. Participants sometimes feel stressed when they are working and learning at the workplace, and that workplace activities have little to do with the classroom content.

Feedback on the preliminary results of the study

Reactions to our preliminary results varied. For some interviewees, the ELP's duration is too short. They prefer a longer **duration of 24 months**. That change would give them the opportunity to correct the cost-benefit ratio in the right direction. Likewise, it would improve their chances of attracting participants to further career steps on the company-internal labour market, which is one of companies' most important motivations to train.

On the question of whether the salary of students could be reduced, all respondents reacted hesitantly. Some mentioned that this is a regulation of the ELP, and therefore not changeable. Others see a danger of not attracting well-qualified participants. In particular, for those companies that highly value the intellectual potential of Polytechnic students, high wages play a minor role.

Subsidies are very welcome, although some companies have admitted that they would also train without the subsidies, because without any training they would not get the skills they need for business performance.

Last but not least, some companies can imagine sending their existing staff that are non-fresh graduates to an ELP for re-tooling. However, the ELP is not (yet) intended for this target group and it is also unclear whether there would be subsidies from the state.

5. Costs and Benefits of the ELP

This section presents the empirical results on how much participating in the ELP costs and benefits firms.

5.1. Costs of the ELP

The first step towards understanding net costs of the ELP is to analyse expenditures and costs firms incur in the course of the ELP. On average, firms have **costs of about S\$50,000** per ELP participant per year. Figure 5 displays how this breaks down into cost categories. Labour costs of participants are the most important cost category, accounting for S\$26,000 or 52% of total costs per student per year.

On average the **wages of ELP participants are about S\$2,000 per month**. This appears relatively high given that it is 84% of the wage earned by a skilled employee in the related occupation. Importantly, individual firms have limited influence on ELP participants' wages. Polytechnics make recommendations based on wages paid on the labour market. Firms generally follow these recommendations closely. As a result, wages remain relatively similar within ELP sectors, though they differ across ELP sectors as discussed in detail below.

Another yearly S\$15,000 or 30% of total costs stem from **on-the-job training costs**. This cost category includes some costs for buying training equipment, for consuming training materials and for opportunity costs of using equipment as training equipment rather than for production. However, the brunt of on-the-job training costs arises because mentors, supervisors and co-workers have to invest time into training the ELP participant.

Firms also require substantial **resources to plan the ELP**, specifically S\$4,200 per participant per year, or 8% of total costs. Most planning time is spent writing the on-the-job blueprint. Importantly, the interviews have revealed that even firms that essentially used an existing plan from other employees' training needed time to adapt existing documents to the templates provided by Polytechnics. This finding matters for two main reasons. First, in order to reduce administrative burden, Polytechnics should optimize the process of developing the on-the-job blueprint. Secondly, these costs mainly occur in the first generation of ELP participants in a firm. Since development is a fixed investment, costs per ELP participant may decrease over time. Hence, subsidies should focus on removing fixed costs that prevent firms from participating in the ELP.

Costs for hiring ELP participants and for administering the ELP make up 6% or S\$3,000 of each year's total cost. This category contains some material costs but mainly arises from personnel time devoted to the smooth functioning of the ELP.

Similarly, classroom education costs amount to 4% or S\$1,800 per year. About three-quarters of education costs arise from ELP courses at Polytechnics. Firms spend about one-quarter of total classroom education costs for courses delivered in-house by the company, while costs of courses at other providers is negligible. The **fees paid to Polytechnics** represent an important cost component because subsidizing Polytechnics can be less problematic than subsidizing firms. Subsidizing firms directly might create windfall gains for firms that would have trained regardless, and might induce firms to pocket the subsidies and shirk on their commitment to training since it is costly and difficult to assess such commitment.

Figure 5: Share of ELP cost categories

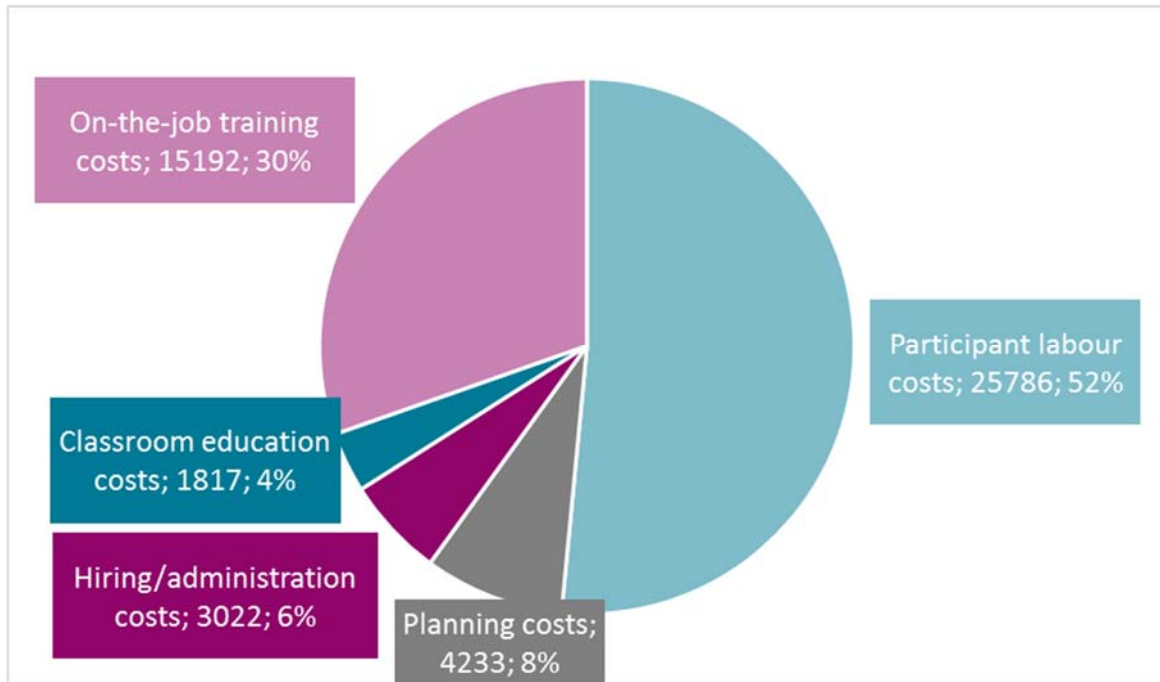

Notes: N=30. Absolute values display yearly costs per participant in S\$.

Comparison with Switzerland's VET system

It is very difficult to compare VET programmes in Switzerland to those in Singapore because the combination of learning and working at the workplace and learning at school is combined over three to four years (dual VET). Furthermore, sector professional associations (e.g. Swiss Manufacturing Association, Swiss Banking Association) play an important role in developing the framework curricula and training materials for specific occupations and in creating final exams for the workplace. This intermediary function helps to share costs among companies and allow SMEs to participate in the VET programme.

For comparative reasons, the allocation among cost components in a typical Swiss apprenticeship is 46% for participants' labour costs, 39% for on-the-job training costs and 15% for the rest including planning costs, classroom education costs and planning costs (see Strupler & Wolter 2012, p. 70). The somewhat-lower share of other costs than wages and on-the-job training costs has to do with the above-mentioned differences. It is most probably because Swiss programmes typically last for 3 or 4 years, which has an impact on the relative share of planning costs.

The fact that the share of participants' labour costs is lower is due to apprentices' age (around 16) being younger than ELP participants' and the wage of an apprentice being only about 20% that of a fully skilled employee. Although the relative wage of Swiss apprentices is considerably lower than that of ELP participants, the salary costs for apprentices are almost the same in relation to firms' training expenditures in Switzerland as in Singapore.

This does, however, not mean that the higher relative wages of ELP participants signal higher training expenditures by firms in Singapore. The total training expenditures of a Swiss firm is equal to that of a firm in Singapore because the programmes in Switzerland are more than twice as long as those in Singapore. The advantage of an average Swiss firm therefore is that they are able to compensate the same absolute amount of expenditures with higher productive

contributions from trainees because they work for the firm more than twice as long for the same programme costs.

Heterogeneity of costs across ELP sector

Figure 6 displays the heterogeneity of yearly ELP costs across ELP sector and firm size. The first column displays the same sample average as Figure 5, but as a stacked column measuring yearly costs in S\$. The following columns show the results by ELP sector and firm size, respectively.

The results suggest that the ELP costs the most by far in the ELP for Power Engineering sector at S\$86,000, followed with a substantial lag by ICT and Electronics at about S\$60,000. Conversely, the ELP costs remain lowest in the ELP for Food Manufacturing and Media sectors, where yearly total costs amount to about S\$35,000.

The light blue bar segments that represent the labour costs of each ELP participant are relatively similar across ELP sectors at around S\$25,000, though Electronics and Power Engineering are above S\$30,000 per year. Light pink on-the-job training costs are the most important determinant of heterogeneity across ELP sectors, ranging from S\$9,000 in the Food Manufacturing sector to S\$32,000 in the Power Engineering sector. Planning, hiring and administration costs are relatively low in all sectors, though highest in the ELP for Power Engineering, ICT and Hotel sectors.

The results further show that labour costs of participants are similar for SMEs and large firms, though large firms pay their participants slightly more. Similarly, large firms spend a little more on planning, hiring and administering the ELP, but the difference remains small. The largest difference arises from on-the-job training costs, which are higher for large firms. This suggests that large firms are ready to invest more into workplace training than are small firms.

Figure 6: Costs of ELP

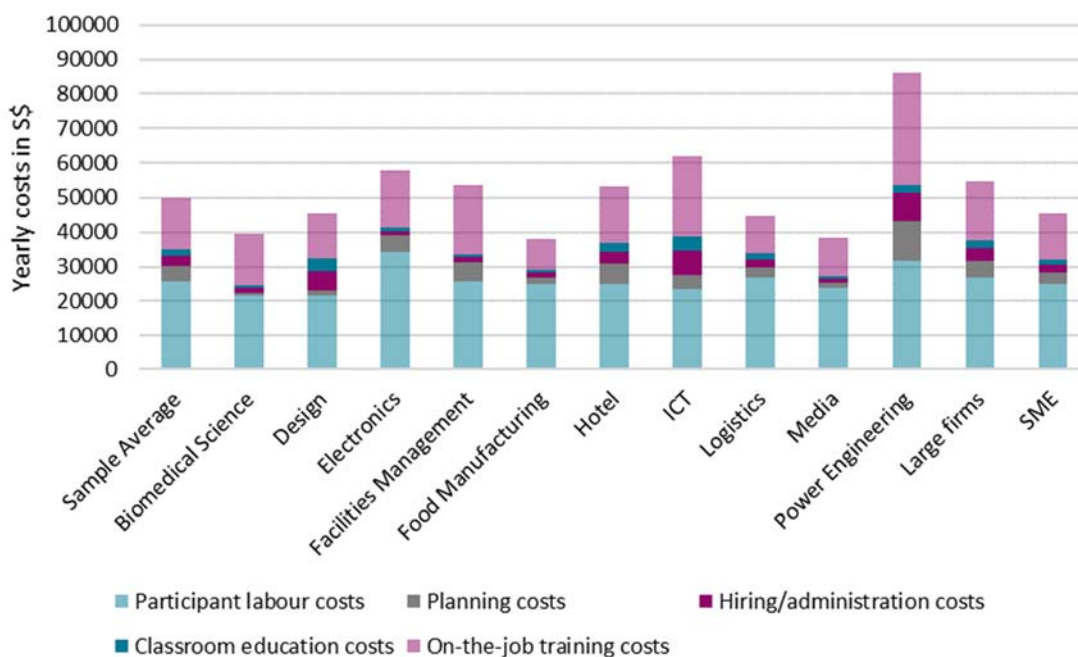

Notes: N (Sample Average)=30

5.2. Costs and Benefits Components of ELP

Complementing the last section on costs induced by the ELP, this section discusses the benefits arising during the duration of the ELP. Hence, Figure 7 displays the same upper part as Figure 6, but expands it by showing the benefits in red as negative benefits. The black line indicates net costs calculated as costs minus benefits.

The results suggest that the benefits during programme duration amount to about S\$32,000 per year. Of these, 56% reflect the S\$18,000 productive value the ELP participant generates. The calculation of the productive value has three components, namely the share of time ELP participants use for different activities, the wage of employees with corresponding skill level, and the lower productivity of ELP participants relative to skilled employees.

The results regarding the time use of ELP participants show that the average share of classroom education amounts to 20%. This share decreases from 21% in the first six months to 18% in months seven to twelve. During months 13 to 18, the share of classroom education decreases to 14%. Additionally, ELP students spend 19% of their time practicing at the workplace without producing valuable products or services. This share also decreases over the course of the ELP. After 23% in the first six months, it decreases to 15% in the second part of the first year and drops to only 8% after the first year. As a result, the share of time in which ELP participants produce valuable products or services increases from 57% in the beginning to 67% in the middle and 79% in the end.

The productive time further differentiates between skilled work and un- or semi-skilled work. Un- or semi-skilled work pertains to activities that can be performed without ELP training. On average, ELP participants spend 13% of their time doing un- or semi-skilled work and 49% doing skilled work. The share of un- or semi-skilled work decreases slightly from 16% to 11% and 10% over time. The share of skilled work increases from 41% to 56% and 69%.

When the ELP participant performs un- or semi-skilled work, the framework assumes that their productive value equals the labour costs of an unskilled employee, or S\$2,222 per month. Similarly, the labour costs of skilled employees in the ELP occupation serve as approximation of the productive value of time during which the ELP participant performs skilled work. These average labour costs of S\$3,300 per month are substantially higher than those of un- or semi-skilled employees.

The calculation of productive value during the time the ELP participant performs skilled work further needs to account for the reduced productivity of ELP participants compared to a skilled employee. During the first six months of the ELP, an ELP participant requires 50% more time than a skilled employee to create the same products or services. In the second part of the first ELP year, ELP participants require 29% more time and ELP participants still need 13% more time in months 13 to 18. We prorate ELP participants' skilled-work contributions using these productivity adjustments.

Hence, the value of goods and services produced by ELP participants increases over time, because they spend a larger share of time productively, increase the share of skilled work and become more productive. This shows empirically that increasing the duration of the ELP can potentially decrease net costs of the ELP.

Subsidies represent 44% of the benefits that arise during the programme duration. The average yearly value of subsidies amounts to S\$14,000 since the ELP lasts more than one year in some ELP sectors.

Yearly benefits stemming from subsidies differ relatively little across ELP sector. In contrast, yearly benefits in the form of productive value are highest in Power Engineering (S\$30,000) Media (S\$23,000) and ICT (S\$20,000). The productive value remains lowest at about S\$12,000 in Facilities Management and Hotels.

Heterogeneity across sectors

The black line represents costs minus benefits during the programme duration. On average, yearly net costs are S\$18,000. The highest net costs by far arise in Power Engineering (S\$41,000), followed by Electronics, Facilities Management, ICT and Hotel with net costs above S\$25,000. Logistics and Design rank in the middle at around S\$12,000, while net costs in Food Manufacturing, Biomedical Science and Media vary around S\$5,000. Hence, the results suggest that most firms participate in the ELP to make an investment in the human capital of their employees. However, the findings further highlight the heterogeneity of costs, benefits and net costs across ELP sectors.

Comparing large firms and SMEs reveals that benefits of the ELP during programme duration are largely independent of firm size. As discussed above, large firms have higher yearly ELP costs. Hence, large firms have larger net costs (S\$23,000) than SMEs (S\$14,000).

Figure 7: Costs and benefits of ELP during the programme by ELP sector

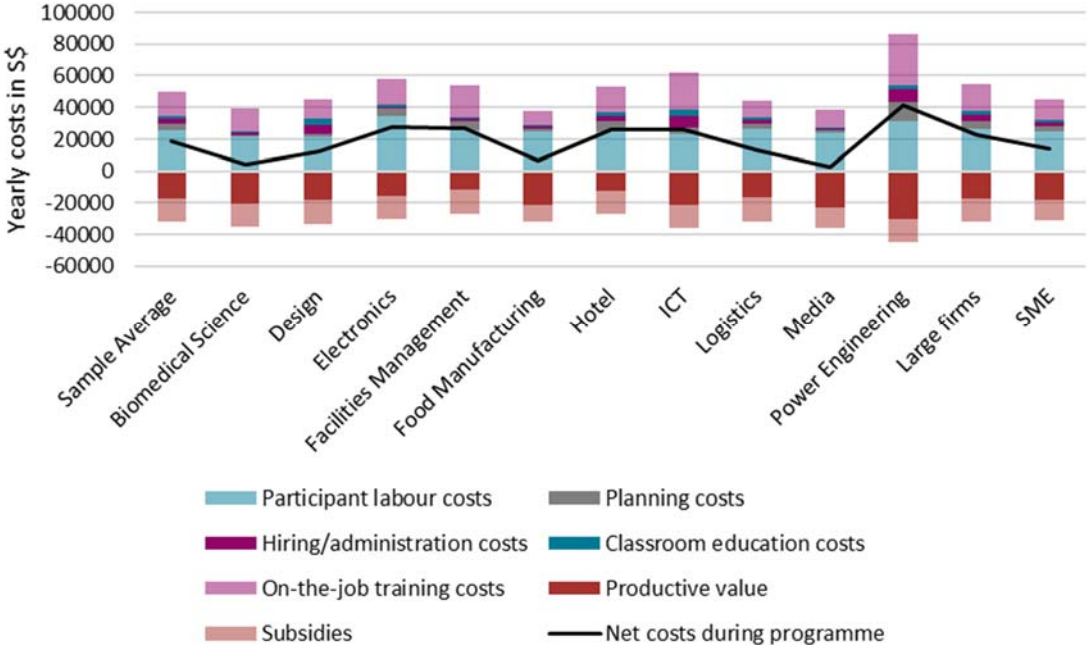

Notes: N (Sample Average)=30

5.3. Total Benefits of the ELP

The above net cost analysis focuses on costs and benefits during the programme duration but ignores benefits that accrue after the end of the ELP. These additional benefits arise for the 73% of ELP participants that stay with the training firm rather than leaving the firm. These ELP participants generate two types of benefits. The first benefit is saved hiring costs because no new employee needs to be hired. On average, these saved costs for advertisement and hiring procedures amount to S\$1,000.

Figure 8 shows that this represents merely 3% of the total benefits. However, it also shows that saved adjustment costs of S\$5,000 per year make up 14% of the total benefits. Saved adjustment costs capture how much it costs to adapt a skilled employee hired from the labour market to the firm-specific setting.

Benefits after the programme duration are relatively similar across ELP sector. The most notable exceptions are the high benefits in the ELP for Power Engineering sector (S\$11,000) and Electronics sector (S\$10,000). Conversely, benefits after the ELP are particularly low in Food Manufacturing (S\$3,000) because the retention rate, which measures how many ELP participants stay in the firm after the end of the ELP, drops below 50% in this sector. Comparing large firms and SMEs further shows that large firms benefit more after the end of the programme. This is unsurprising since the retention rate of 82% in large firms is substantially higher than in SMEs, where it is only 63%.

Figure 8: ELP benefits by category

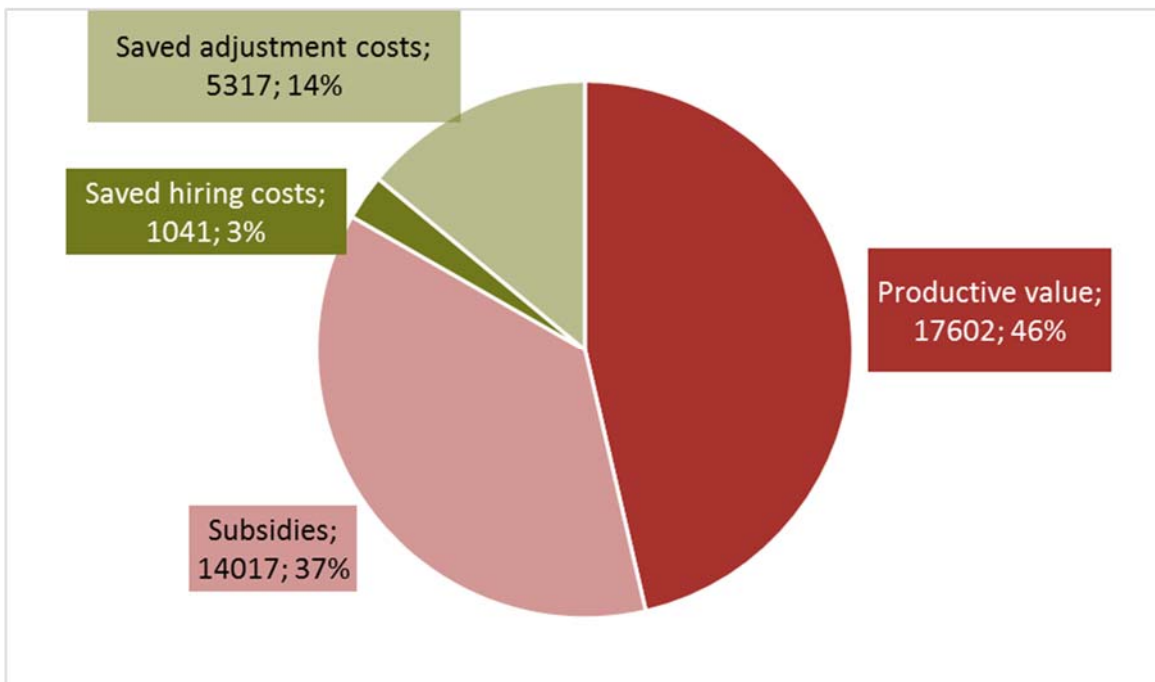

Notes: N=30. Absolute values display yearly benefits per ELP participant in S\$.

5.4. Total Net Costs of the ELP

This section combines the information about costs and benefits during and after the programme. Figure 9 shows that the average firm invests net costs of S\$12,000 per year into an ELP participant. Hence, firms mostly have an investment-oriented approach, meaning that they participate in the ELP in order to profit from the investment into human capital at a later stage.

The net costs after the programme have a similar pattern to the net costs during the programme duration. In particular, only two ELP sectors end up with **negative net costs**, namely Biomedical Science and Media with about - S\$2,000 each year. Hence, not even in these extreme cases would the firms make a profit if the subsidies were cut. Furthermore, net costs reach S\$30,000 for Power Engineering, followed by Hotel, ICT, Facilities Management and Electronics, where net costs take values around S\$20,000.

Figure 9: Net costs of ELP

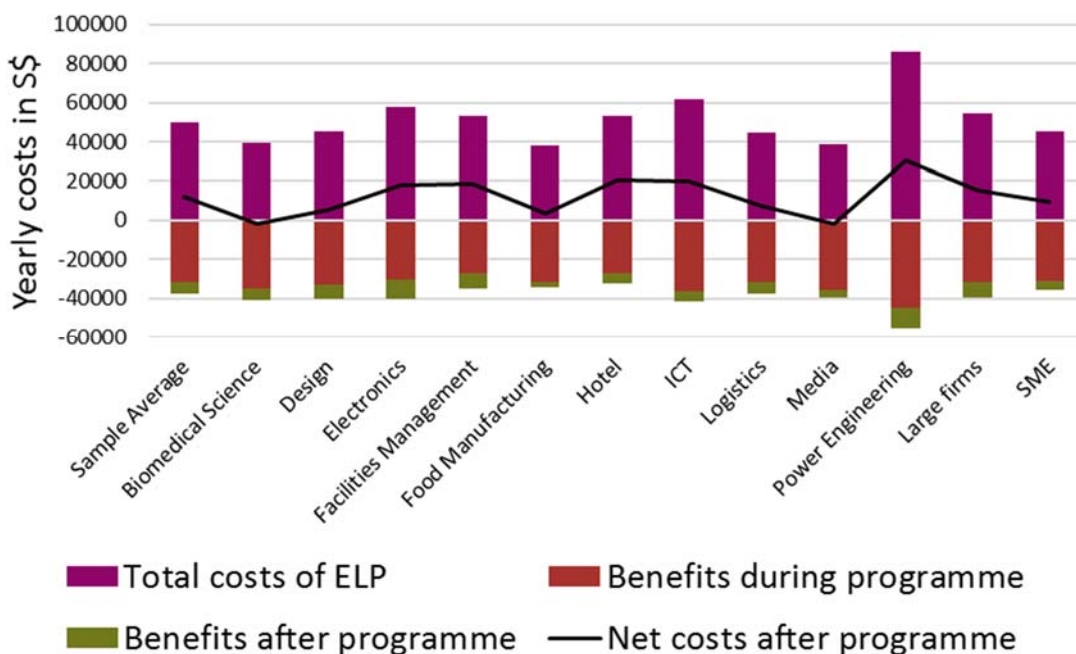

Notes: N (Sample Average)=30

5.5. Break-Even Analysis

In order to inform choices on potential levers to affect net costs of the ELP, this section presents a sensitivity analysis in the form of a break-even analysis. The lever we analyse is the **relative wage of ELP participants** compared to skilled employees in the same ELP occupation. An increase in the relative wage moves ELP participants' wages higher, and usually closer to skilled workers' wages. A relative wage of 100% means that the two groups have the same wage. Figure 10 shows that average ELP participants earn 84% of what their skilled co-workers do. In the average hotel, the relative wage is more than 100%. Conversely, the difference between the wage of ELP participants and their skilled counterpart is largest in Power Engineering (58%), ICT (64%) and Biomedical Science (70%). Rather surprisingly, we find little difference between large firms and SMEs.

Figure 10: Relative wages

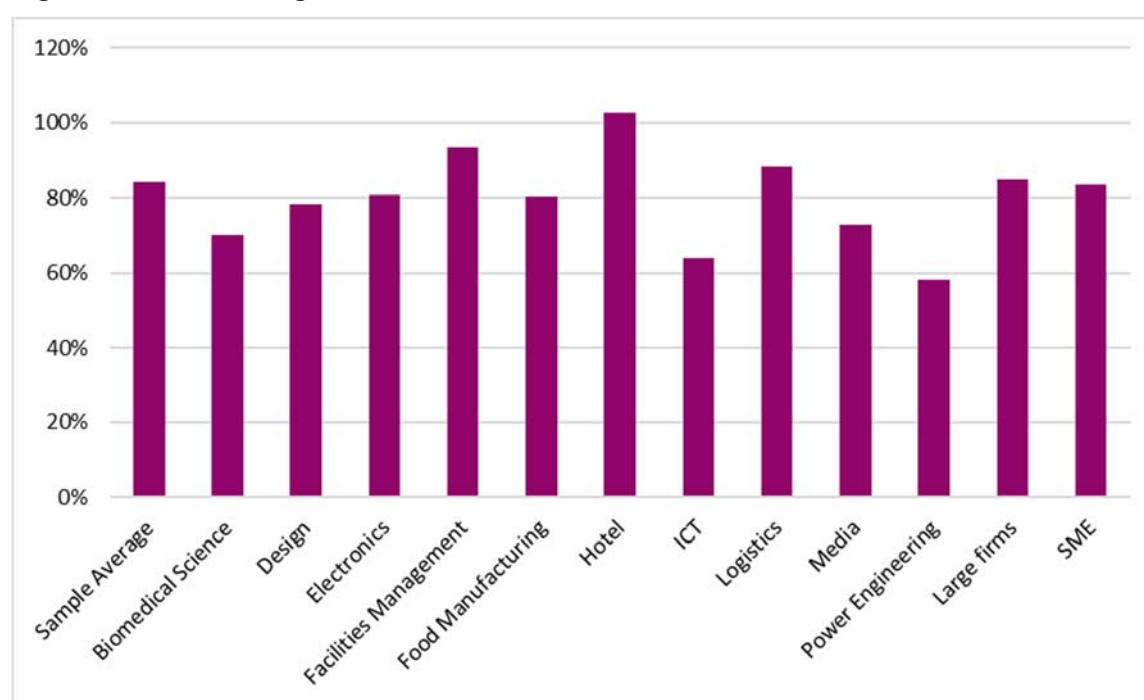

Notes: N (Sample Average)=30

These relative wages are the starting point for our break-even analysis. For the analysis, we calculate the hypothetical relative wage that reduces net costs after the programme to zero. Figure 11 displays the results based on two hypothetical experiments. The grey bar shows the break-even value of the relative wage for total net costs as calculated above. In contrast, the blue bar assumes that the government stops paying subsidies, showing the relative wage necessary to make firms break even without the subsidies.

The grey bar shows that a relative wage of 40% suffices to reach break-even in the current subsidy environment. This corresponds to the finding above that the current setup requires firms to **make an investment to run an ELP**, but that this investment is relatively small.

However, the blue bar drops substantially, reflecting how impactful subsidies are for limiting the net costs of participating firms. The relative break-even wage excluding subsidies is negative at -10%, or so low that it is unlikely ELP participants would accept such a low wage in the current constellation. While reducing the relative wage of ELP participants is an important lever to decrease net costs to firms, it cannot solve the situation by itself because ELP participants will want to be compensated for the reduction in the relative wage.

Figure 11: Relative wage and relative break-even wage

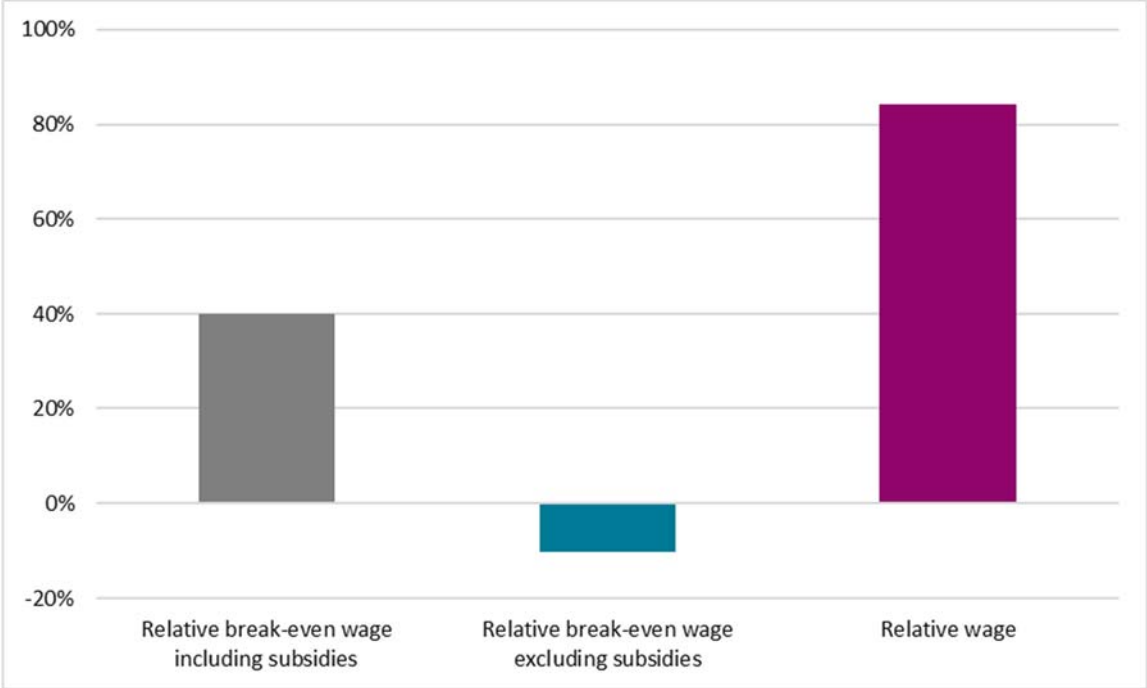

Notes: N (Sample Average)=30

6. Decisions of Firms to participate in ELP

This section discusses the empirical results on the demand for the ELP. These results can be broadly separated into three categories. The first category analyses the motives of firms to participate in the ELP. The second category provides insights on how firms assess the different characteristics of the ELP. Finally, the third category presents the results on firms' satisfaction with the ELP.

6.1. Why do Firms Participate in the ELP?

Since the cost-benefit analysis suggests that most firms have an investment-oriented motive to participate in the ELP, this section analyses the hypothesis that firms who face a more stringent shortage on the labour market are more likely to participate in the ELP (see e.g. Wolter et al. 2006 or Muehlemann et al. 2007). Labour market shortage is particularly high if a firm has high demand for skilled labour and/or if skilled labour is scarce.

In order to test the hypothesis empirically, this section compares indicators for the labour market shortage among two groups of firms. The first group is firms that participated in the ELP, and the second is firms that did not. Comparing the descriptive statistics of these two groups lets us conduct a simple empirical analysis of why some firms choose to participate in the ELP while others do not. In addition, Table 4 in the appendix displays estimations for the relationship between participation in the ELP and the indicators for labour demand after accounting for firm size and ELP sector. It should be noted however that the sample size is relatively small for both firm groups. Furthermore, the response rate for non-participating firms is very low, which means that we cannot exclude a response bias that would limit the external validity of the responses of non-participating firms to a certain extent. Table 5 shows the heterogeneity across ELP sectors.

The first indicator for labour shortage (see Figure 12) shows the importance of employee qualification and turnover for the competitiveness of the firm. It is measured on a five point Likert scale. The results show that the qualification of employees is regarded both by participating (4.4) and by non-participating firms (3.9) as an important determinant of firms' competitiveness. However, as expected, the qualification of employees is more important for participating firms. This difference is still there after statistically accounting for firm size and ELP sector.

The relevance of low employee turnover is also slightly higher for participating (4.0) than for non-participating (3.8) firms. However, the difference is insignificant and disappears almost completely after accounting for ELP sector.

Analysing the difference between ELP sectors⁵ suggests that qualification and low turnover are particularly critical in ELP sectors Biomedical Science, Power Engineering, Logistics and Hotels. Conversely, they matter least in Design, and, rather surprisingly, Electronics. Comparing small and medium to large firms shows that large firms consider qualification a

⁵ In order to increase the sample size, this analysis aggregates participating and non-participating firms.

more important determinant of firm competitiveness while low turnover matters for all firms similarly.

Figure 12: Relevance of qualification and turnover for firm competitiveness

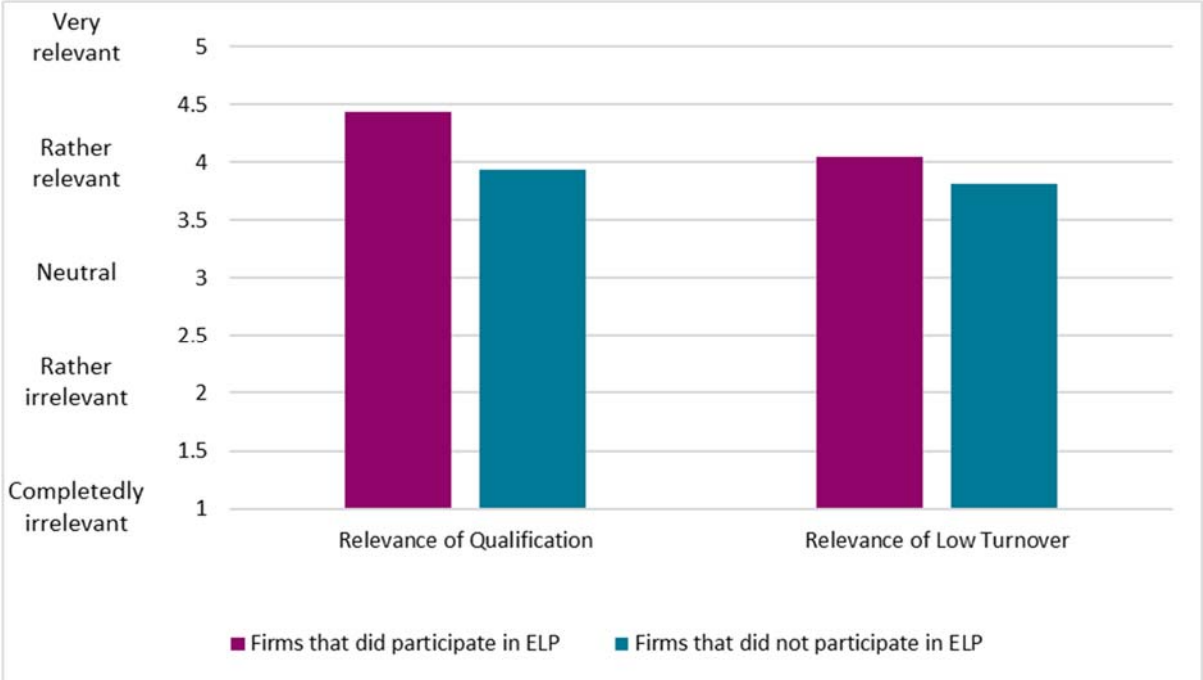

Notes: N (participating)≈23, N (non-participating)≈103

Figure 13 shows the turnover rate of responding firms, suggesting that the yearly turnover rate among participating firms is about 17%, while non-participating firms report an average turnover rate of only 11%. Although the difference is not statistically significant, it remains about the same after accounting for the ELP sector. Although turnover is relevant for both participating and non-participating firms, the small difference between participating and non-participating firms, given the net costs for participating firms during the ELP, is rather surprising. This unexpected result might arise because the turnover rate is an imperfect approximation of labour market shortage or because labour market shortage is not the key motive to participate in the ELP.

In order to shed further light on this question, the following paragraphs broaden the discussion by considering a range of other indicators for labour market shortage.

Figure 13: Turnover rate

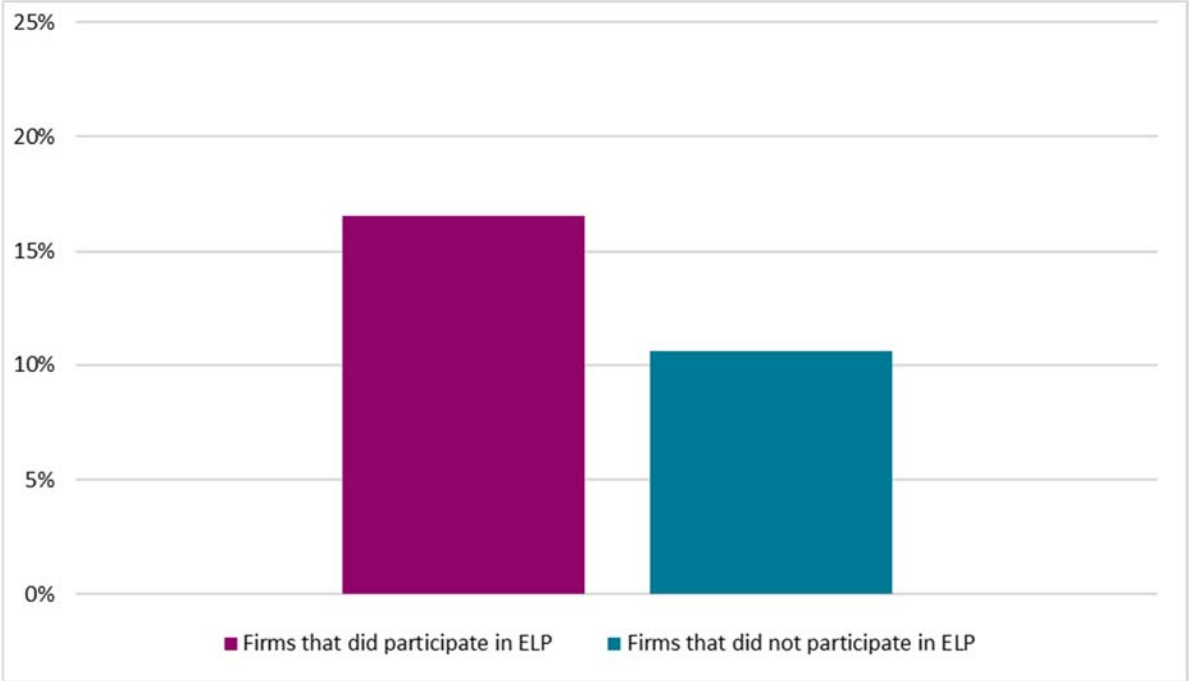

Notes: N (participating)=20, N (non-participating)=88

Another indicator of labour market shortage is the extent to which the quantity and quality of skilled employees available on the labour market satisfies the firms' needs. Figure 14 shows that firms are neither satisfied nor dissatisfied with both the quantity and the quality of available employees on the labour market.

Comparing participating and non-participating firms yields a surprising result. Satisfaction with the quantity of the skills supply is about the same (3.0) and satisfaction with the quality of supply is higher for participating firms (3.1) than non-participating firms (2.8). Furthermore, accounting for ELP sector increases this difference. While this unexpected result holds across most ELP sectors except for ICT, there might be measurement error due to the small sample size. Even when accepting the possibility of some measurement error, we are not able to find a skills shortage in quantity and quality that would explain participation or non-participation in the ELP.

Analysing the heterogeneity of the satisfaction across ELP sectors suggests that firms are most satisfied with the skills supply in the Electronics and Power Engineering sectors and that firms in the ICT sector are least satisfied. While large firms are more satisfied with the quantity of labour market supply than small and medium firms, there is little difference in satisfaction with labour market supply quality between firm sizes.

Figure 14: Quantity and quality of labour market supply

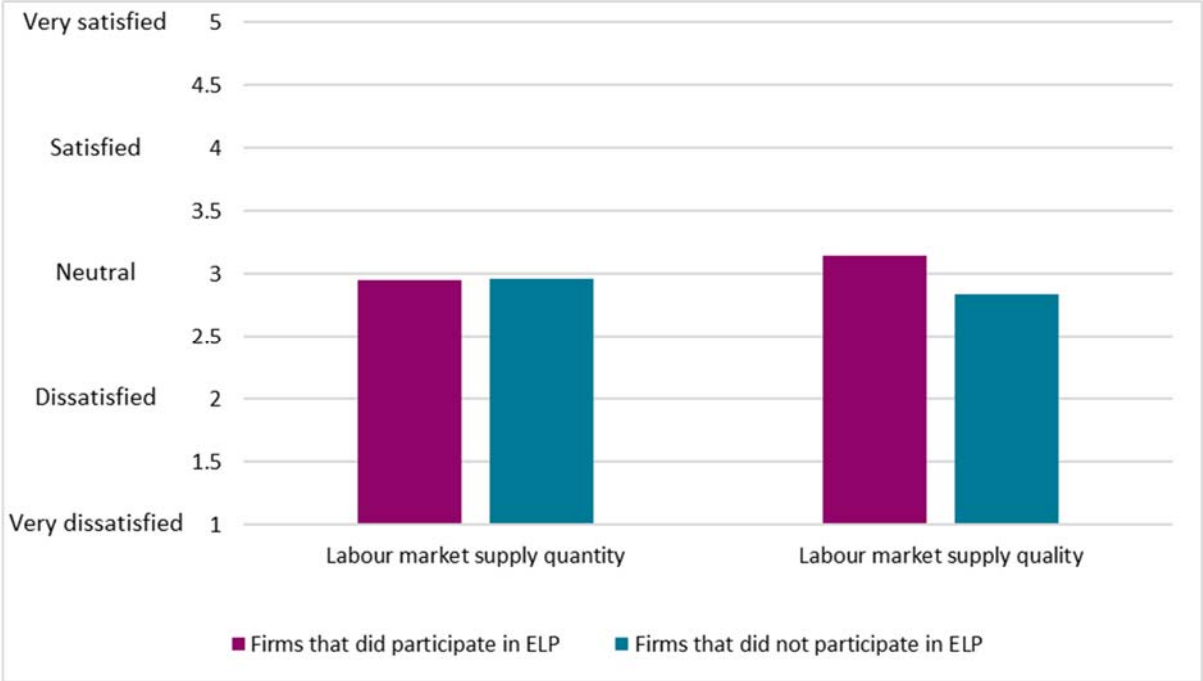

Notes: N(participating)≈21, N(non-participating)≈86

Figure 15 shows the number of applications a firm receives for each job vacancy in the occupation the ELP sector aims to fill. This alternative measure of labour market tightness shows that participating firms receive about 20 applications per position, while non-participating firms receive nearly 25 applications. Though accounting for ELP sector reduces this difference substantially, the results for this indicator support the hypothesis that labour market tightness increases the propensity of firms to participate.

The number of applications differs substantially across ELP sectors. It is particularly high in the Food Manufacturing sector, followed by the, ICT, Design and Logistics sectors with more than 20 applications per skilled position. In contrast, firms in the Media and Biomedical Science sectors receive less than 10 applications per skilled position. Rather surprisingly, the results suggest that SMEs receive slightly more applications per position. However, the number of applications does not tell us whether they are of satisfactory quality or not.

Figure 15: Number of applications per skilled position

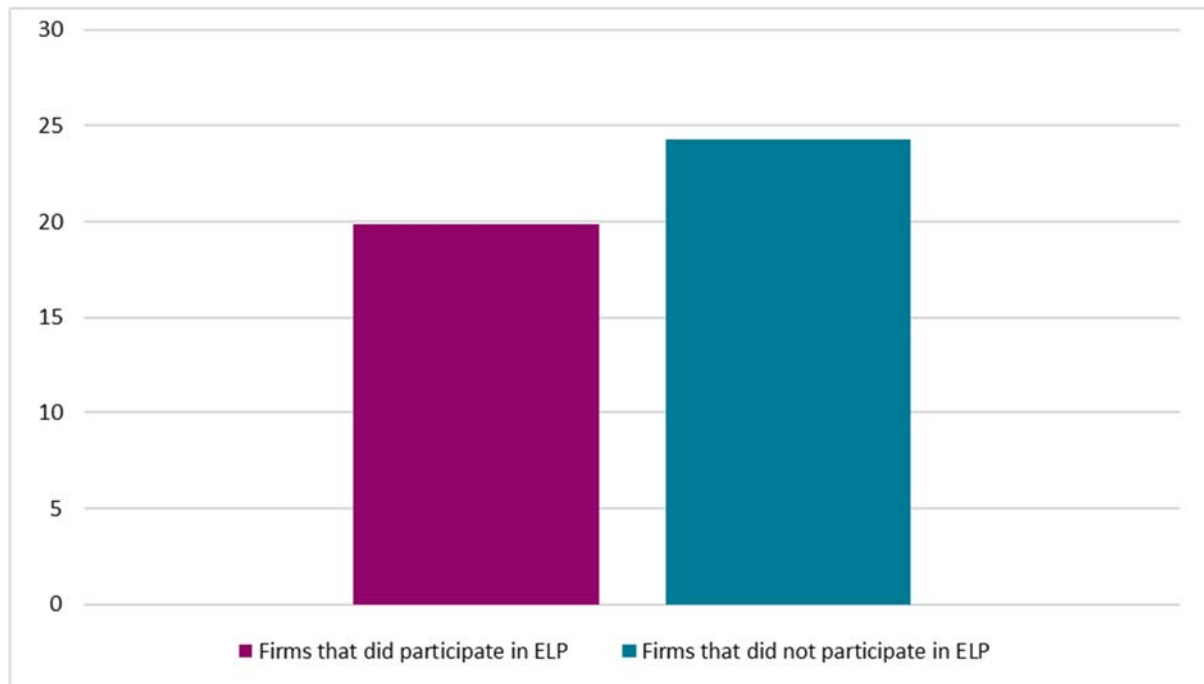

Notes: N (participating)=20, N (non-participating)=80

Taken together, the indicators regarding labour market shortage provide a mixed picture, though they tend to support the hypothesis that labour market tightness induces firms to participate in the ELP. This empirical finding is also consistent with several face-to-face interviews suggesting that a tight labour market and the **lack of available skilled employees as a key motive for participating in the ELP**.

In order to broaden our understanding of why firms participate in the ELP, Figure 16 shows how important a number of potential additional training motives are. Table 7 in the appendix shows our estimations testing whether responses differ between participating and non-participating firms. The results support the previous conclusion insofar that **securing skilled employees is an important motive** (3.8). Furthermore, this motive is somewhat more relevant for participating firms (4.0) than for non-participating firms (3.8), although the difference is insignificant and remains roughly the same after accounting for ELP sector.

However, more important than merely securing skilled labour are some closely related motives: reducing the turnover rate by increasing employees' commitment to the firm (3.9) and training junior employees to fit the specific needs of the firm (3.9). Furthermore, securing a supply of skilled employees for the sector and region is also a key motive (3.9). These motives are similar for participating and non-participating firms even after accounting for the ELP sector.

The least relevant motive is the desire to replace un- and semi-skilled employees with ELP participant(s) (3.3) – which is actually a good sign for the ELP programme. This motive is more relevant for participating firms (3.0) than for non-participating firms (3.4) and this difference remains after accounting for the ELP sector. Given how important it is for companies to fill specific skills needs it is rather surprising that saving adjustment costs for employees hired from other firms (3.4) is a less-relevant motive. The motives to save recruitment costs (3.6) and avoid wrong hiring decisions (3.6) seem to be less important drivers for both participating and non-participating firms as well.

These patterns are relatively stable across ELP sectors and firm size as shown in Table 9. A notable exception is the ELP for Food Manufacturing sector, for which obtaining skilled employees matters relatively less, but for which the motives of reducing turnover by increasing commitment to the firm and of replacing un- and semi-skilled labour with ELP participants are relatively more relevant motives.

Figure 16: Relevance of motives to participate in ELP

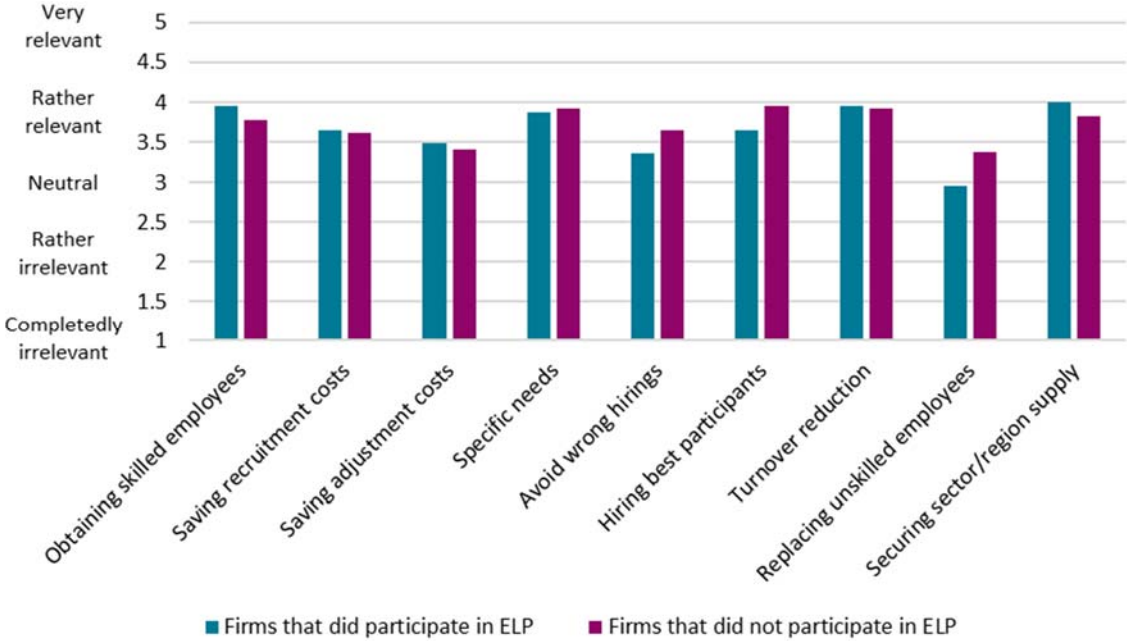

Notes: N (participating)≈23, N (non-participating)≈106

6.2. ELP Characteristics

While these results presented above suggest that the demand for skilled labour is an important determinant of participation, the suitability of the ELP also depends on the occupations in which firms need skilled labour. This can be empirically illustrated by the 42% of participating firms that state *none of the job roles in the existing ELP sectors are suitable for their firm*.

Figure 17 displays how well non-participating firms state ELP sectors would fit their needs. The results emphasize how important it is for ELP options to suit firms' needs, since the three most mentioned ELP sectors are Human Resources (17%), ICT (13%) and Accounting (8%) represent occupations that are suitable to a broad set of firms. Furthermore, the two industry-specific ELP sectors Food Services (8%) and Retail (7%) also score a high share, though this might represent differences in response behaviour rather than suitability.

Figure 17: Most suitable ELP sector for non-participating firms

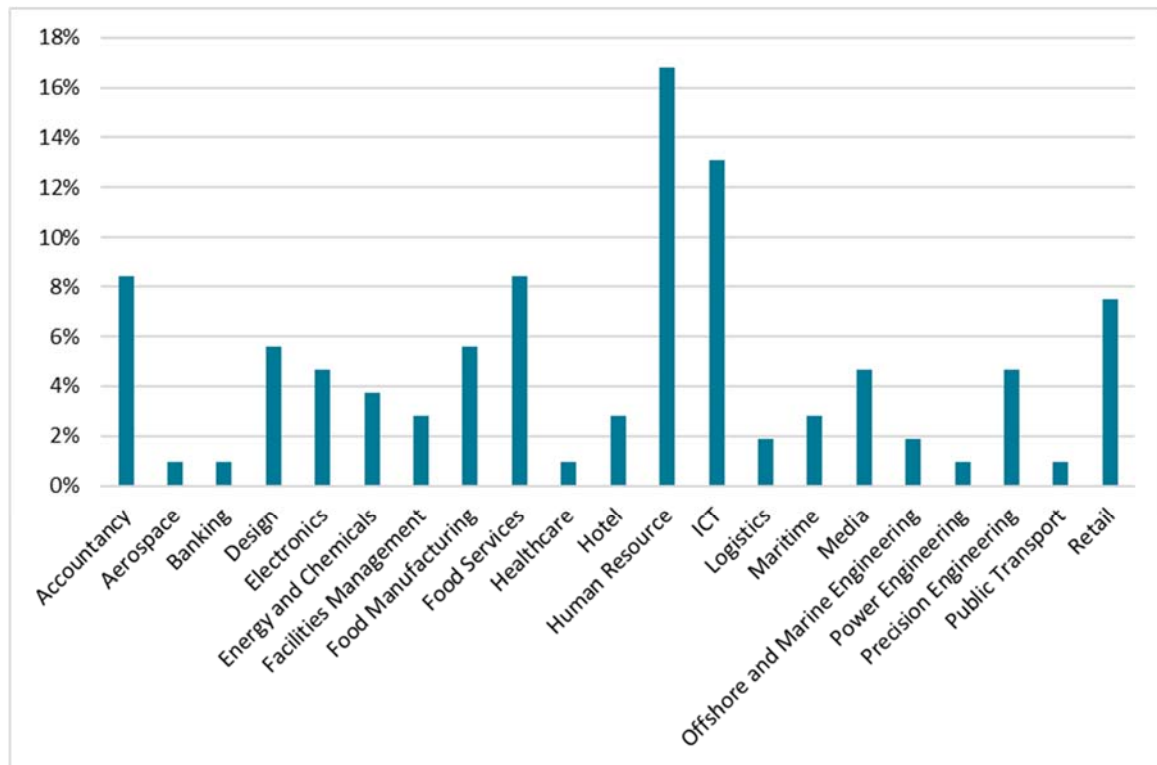

Notes: N=107

Even if an ELP sector provides education and training for a suitable occupation and the firm faces labour shortage on the labour market, participation requires the firm **to know about the existence of the ELP**. The responses from non-participating firms suggest that this is a major issue at this point in time. Only 24% of firms who found a suitable ELP occupation indicated that they were familiar with the ELP. The most-familiar firms are in the ELP sectors Precision Engineering (60%), Logistics (50%), Maritime (50%), Retail (43%), ICT (39%), Facilities Management (33%) and Human Resources (29%).

Low familiarity with the ELP is not particularly surprising given that the ELP is a very new programme and its scope remains limited. Nevertheless, the finding suggests that **increasing awareness among firms** of the ELP is an important issue. This also matters because the value of the ELP certificate for participants increases if other firms have a more adequate appraisal of its value. Hence, familiarity of firms with the programme is also an important determinant of the social status of ELP among participants and parents.

Figure 18 shows the assessment of various potential barriers to participation in the ELP. The results suggest that fulfilling skill demand through continuing education (4.1) and fear of poaching by other firms after the end of the ELP (3.9) are the most critical barriers. Given that, according to our results, most participating firms encounter net costs despite the government subsidies, the **fear of poaching seems to be a justified argument**. The third-most-relevant barrier is a lack of qualification among applicants, which goes back to the argument about the social status of ELP among potential participants and parents. As shown in the summary of the interviews, it may also be related to a less-than-ideal attitude among the ELP candidates. Conversely, neither a lack of need for skilled employees (2.5) nor a lack of ability to convey the ELP (2.6) are major barriers to companies' participation in the ELP.

Comparing the general pattern of responses across firm characteristics reveals a fairly similar picture across ELP sectors and firm size as shown in Table 14. An exception is the relatively high value for the lack of need for skilled employees in the Retail sector. Fulfilling skill demand through continuing education is more important in the ELP for Energy and Chemicals as well as Facilities Management sectors. Finally, the lack of qualified applicants is a bigger concern for SMEs than for large firms.

Figure 18: Barriers to participation

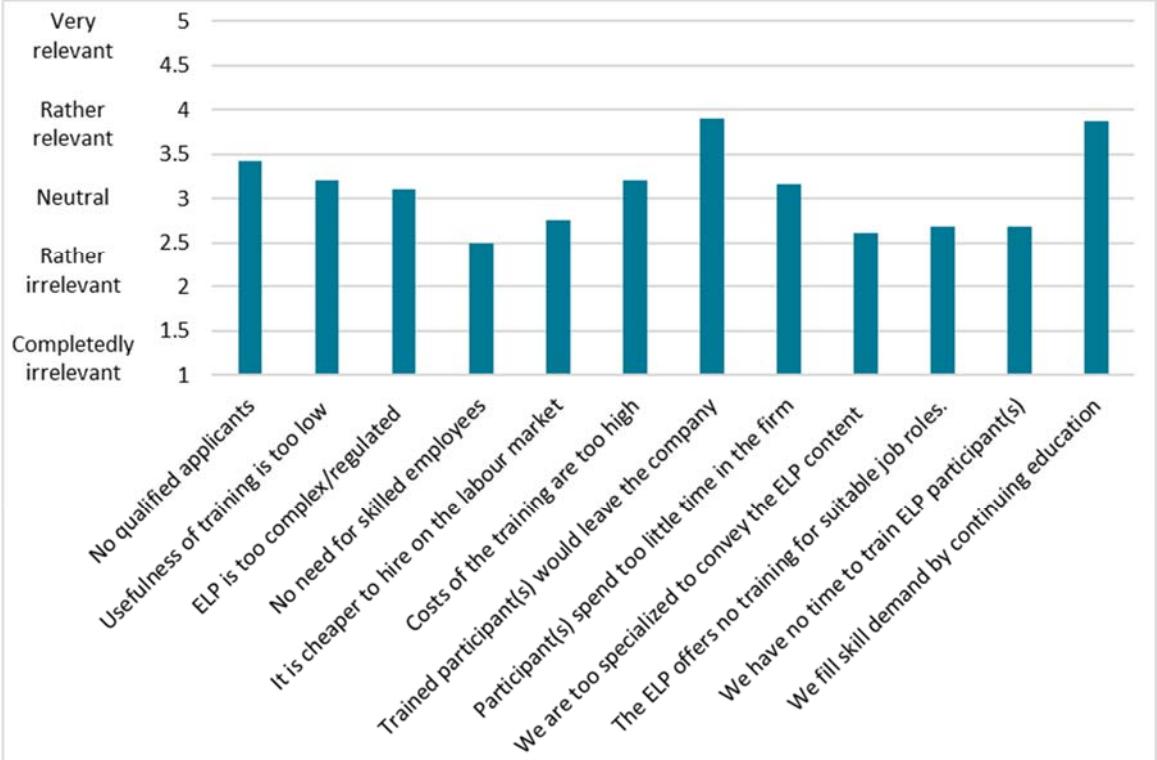

Notes: N≈21

Figure 19 also addresses the choice to participate in the ELP. Instead of focusing on firm characteristics, it shows how helpful changes in the characteristics of the ELP would be. Table 6 in the appendix displays regression results indicating whether the participating and non-participating firms differ in this respect. The results suggest that both participating and non-participating firms consider an **increase in subsidies** the most helpful potential change in the characteristics of the ELP (4.0). Furthermore, accounting for ELP sector suggests that this feature is even more relevant for participating than for non-participating firms. These findings underscore the importance of costs and benefits in determining the decision to participate in the ELP.

Furthermore, **freedom of the firm to shape ELP content** is an important characteristic of the programme for both participating (3.7) and non-participating firms (3.6). This corresponds to the previous finding that companies want to use the ELP for training junior employees to fit specific needs. Relatedly, improving the organization of classroom education is also important (3.6), as relayed by interviewees who suggested that the content of the classroom education is not particularly helpful for firms. Many interviewed firms were even largely unaware of the

content. Furthermore, Figure 19 suggests that decreasing the share of classroom education is desirable but not particularly important to firms (3.4).

As shown in section 4.5, the cooperation between ITE/Polytechnics and companies could be improved, better linking the workplace training and classroom education components of the ELP. One firm indicated that they worked closely with the Polytechnic to develop the curriculum of the classroom education, which could be a role model of cooperation for other firms. To make the process more efficient on a larger scale, [it might be ideal to motivate industry associations to play a larger intermediary role](#). Currently, industry associations are at best marginally involved.

Consistent with the results regarding participation barriers, Figure 19 further suggests that [increasing the quality of applicants](#) would improve the attractiveness of the programme for participating firms (3.8), though less for non-participating firms (3.4). This difference also remains significant after accounting for the ELP sector. This finding is also consistent with repeated interview findings that firms cannot find the participants they need, especially when it comes to attitude, motivation and passion. This is especially true when firms feel the ELP participant(s) primarily entered the ELP because of the financial incentives rather than because of an intrinsic motivation. One interviewee questioned whether ELP participants see the programme as [“Earn and Learn” or whether it is “Learn and Earn”](#) to them.

Because of the high [value of subsidies](#) to participating firms, one could hypothesize that increasing ELP duration and reducing the wages of participants would also encourage firm participation. Contrary to these expectations, Figure 19 suggests that these are the least-favoured ideas (3.2). However, this result has to be seen in the light of the current situation where participating firms can cover some of their training expenditures with subsidies and have less need to reduce costs. This could also partly explain why wages of participants can even be higher than the wages of skilled employees. Another explanation could be, and this has been corroborated by our interviews, that firms worry lower wages might deter able applicants and lower the quality of participants. However, since attitude, motivation and passion are key traits of ELP participants, it is [questionable whether high wages are the optimal tool for attracting good students](#).

The interview responses on an increase in the [ELP duration](#) were mixed. Some firms are open to increasing the duration of the ELP. In fact, some firms have *de facto* increased ELP duration by writing a contract with ELP participants that is longer than the intended ELP. However, some firms were concerned that the programme might become less attractive if it were longer because some participants would become bored. These discussions further revealed that the meaning of the ELP for firms differs between the two programme types: ELPs for ITE graduates are for less demanding positions, while ELPs for Polytechnics graduates are an important part of the talent pipeline.

Analysing the heterogeneity of these results shown in Table 8 suggests that the results are relatively stable across firms. An exception is that increasing applicants' quality is relatively less important in the ELP for Electronics and Hotel sectors as well as for SMEs. Furthermore, a reduction of participant wages appears more relevant in the ELPs for Facility Management, Hotel, Media and Power Engineering sectors.

Figure 19: Relevance of ELP characteristics

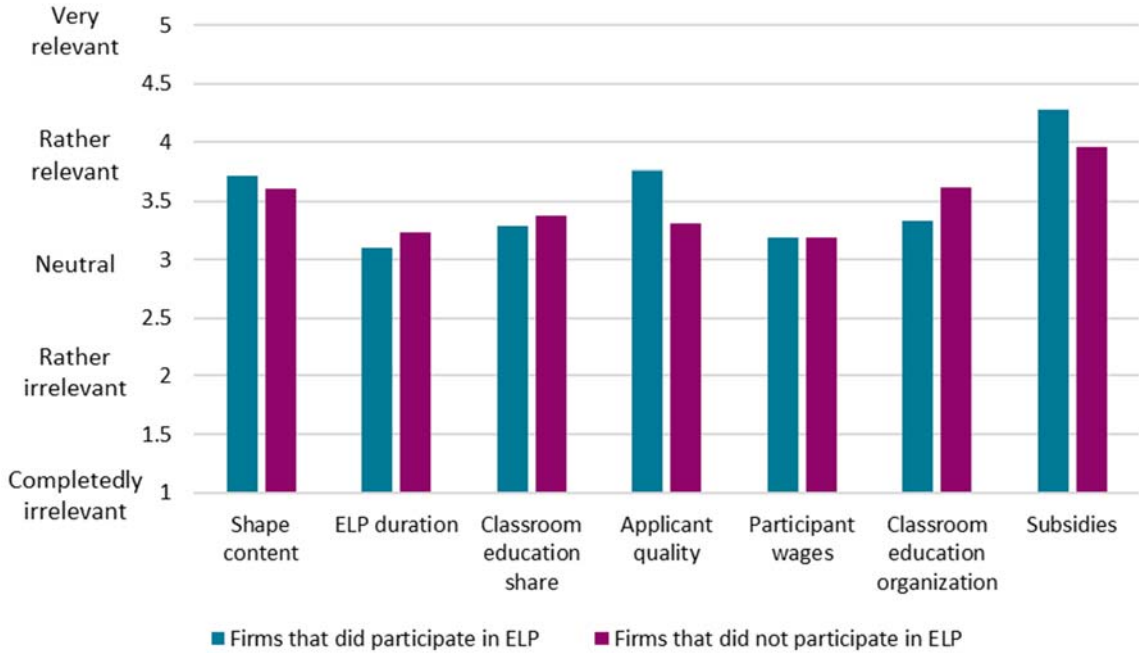

Notes: N(participating)≈21, N(non-participating)≈95

6.3. Satisfaction

Figure 20 shows firms’ satisfaction with the ELP overall, in terms of skill provision and in terms of net costs. The degree of satisfaction is again measured on a five-point Likert-scale. In addition to reporting the sample average, Figure 20 illustrates the heterogeneity of satisfaction across ELP sectors and firm size. Table 10 and Table 11 in Appendix I: Additional Tables display regression results that analyse the relationship between satisfaction and a number of potential determinants. However, the analysis of heterogeneity needs to be taken with a grain of salt due to the small sample size and should be used for starting a discussion rather than providing final evidence.

The average satisfaction with the ELP ranges between neutral and satisfied, where satisfaction is slightly higher overall (3.9) than regarding either skill provision (3.6) or net costs (3.7). This suggests that the existing form of the ELP has room to improve. Analysing heterogeneity suggests that average satisfaction across the three measures is highest in ELPs for Power Engineering (5.0) and Biomedical Sciences (4.3) sectors. Conversely, average satisfaction is particularly low in ELPs for Electronics (2.7), Design (3), Facilities Management (3.3) and Food Manufacturing (3.4) sectors.

Figure 20: Satisfaction with the ELP

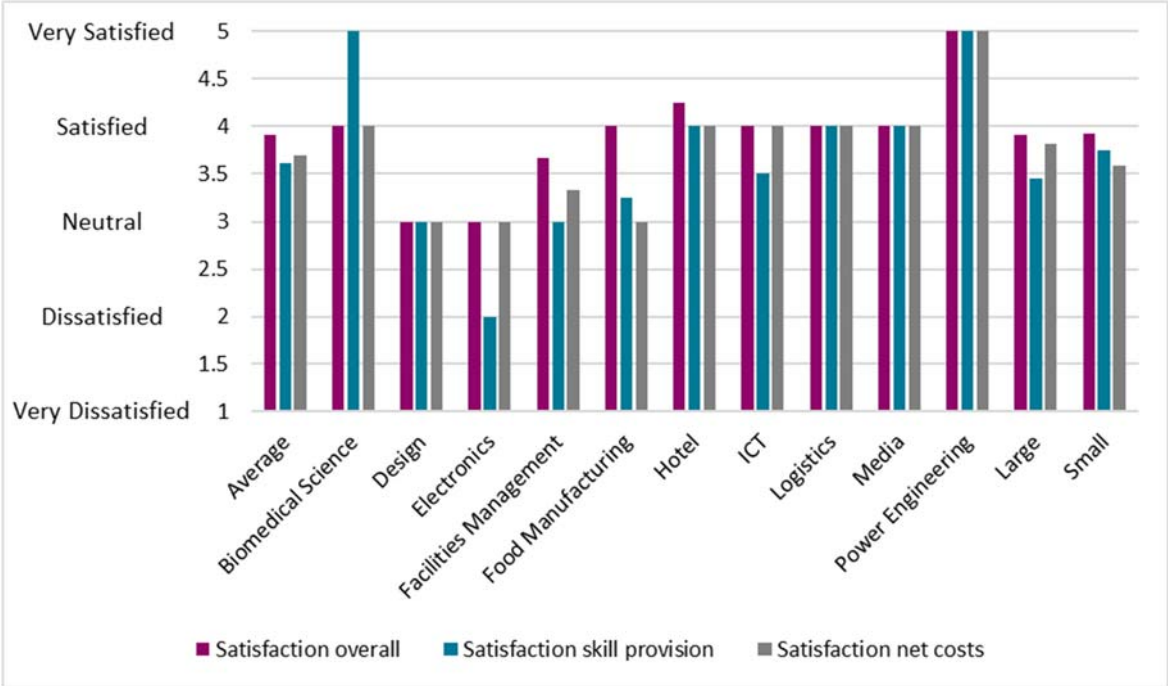

Notes: N(Average)=23

In comparing the satisfaction of SMEs and large firms, we find that satisfaction is independent of firm size, since average satisfaction is similar for SMEs (3.8) and large firms (3.7). However, these descriptive statistics are misleading because large firms tend to operate in ELP sectors that are generally more satisfied with the ELP. Table 10 and Table 11 in the appendix show that the relationship between firm size and overall satisfaction changes if we account for ELP sector. While the OLS estimations without control of the ELP sector (results in odd-numbered columns) confirm the descriptive results, controlling for the ELP (results in even-numbered columns) shows that the satisfaction of SMEs is about 0.5 points lower than the satisfaction of large firms.

Table 10 further analyses the relationship between the indicators of demand for skilled labour and overall satisfaction with the ELP. The results tend to support the hypothesis that **high demand for skilled labour is an important reason for firms to participate in the ELP**. However, while the correlations generally have the expected direction, the estimates remain statistically insignificant in most cases. This is not all too surprising given the small sample size. Concretely, firms are more satisfied with the ELP if skilled employees are a more important determinant of firm competitiveness. As with the comparison of participating and non-participating firms above, this also holds for the relevance of low turnover, albeit to a lesser degree. However, the results confirm that firms with high turnover rates are less satisfied with the ELP, which could be an indication that firms with high turnover rates also are more likely to lose their ELP participants after training, reducing the post-training benefits to zero.

Generally, firms that are more satisfied with labour market supply are less satisfied with the ELP. Similarly, firms with more applicants per open skilled position tend to be less satisfied. Hence, the results generally support the hypothesis that firms are more satisfied with the

programme when they have higher demand for skilled employees that cannot be met on the labour market.

Table 11 analyses the relationship between overall satisfaction and a number of potential determinants. The first two columns reveal that firms that spent more of their planning time in cooperation with polytechnics tend to be more satisfied with the ELP. This finding suggests that **improving cooperation between firms and polytechnics might increase satisfaction with the ELP**. Furthermore, columns three and four show that more retained ELP participants increases the satisfaction of firms. This finding corresponds to the finding above that **firms participate in the ELP to satisfy their need for skilled employees**. Hence, it is not surprising that firms are less satisfied with the ELP when participants leave the firm after completion.

The next six columns analyse the relationship between satisfaction and wages of ELP participants, wages of skilled employees in the ELP occupation and the relative wage of ELP participants and their skilled counterparts. The results suggest that **wages of ELP participants are largely unrelated to firms' satisfaction with the ELP**. In contrast, firms with higher wages of skilled employees in the ELP occupation display higher satisfaction. Correspondingly, increasing the relative wage of ELP participants and skilled employees decreases satisfaction. Finally, the last two columns reveal that **increasing net costs decreases satisfaction with the ELP**, thereby highlighting the relevance of net costs in determining the readiness of firms to participate in the ELP.

Substantial heterogeneity across ELP sectors

Even though firms with low net costs tend to be more satisfied with the ELP after accounting for firm size and ELP sector, Figure 21 reveals the substantial heterogeneity that exists across sectors. The figure shows the average values of ELP sectors for the net costs on the horizontal axis plotted against satisfaction with the ELP on the vertical axis. The dotted line shows that the expected negative relationship does not hold across sectors. Firms in the ELPs for **Power Engineering, Hotel and Facilities Management sectors are more satisfied with the ELP than the net costs would suggest**. Conversely, firms in the Design sector appear rather dissatisfied compared to their net costs.

This might reflect further specific characteristics of these sectors that have not been taken into account, but might also suggest that firms in some sectors have been implementing the ELP more successfully than others. In the latter case, successful firms might help other firms to adapt best practices, which is why digging deeper into why these firms are satisfied with the programme is an important course of action. For example, some hotels have contracts with the ELP participants that extend beyond the ELP duration, thereby reducing net costs by ensuring that ELP participants remain with the firm for an extended period.

Figure 21: Relationship between sector-averages net costs and satisfaction

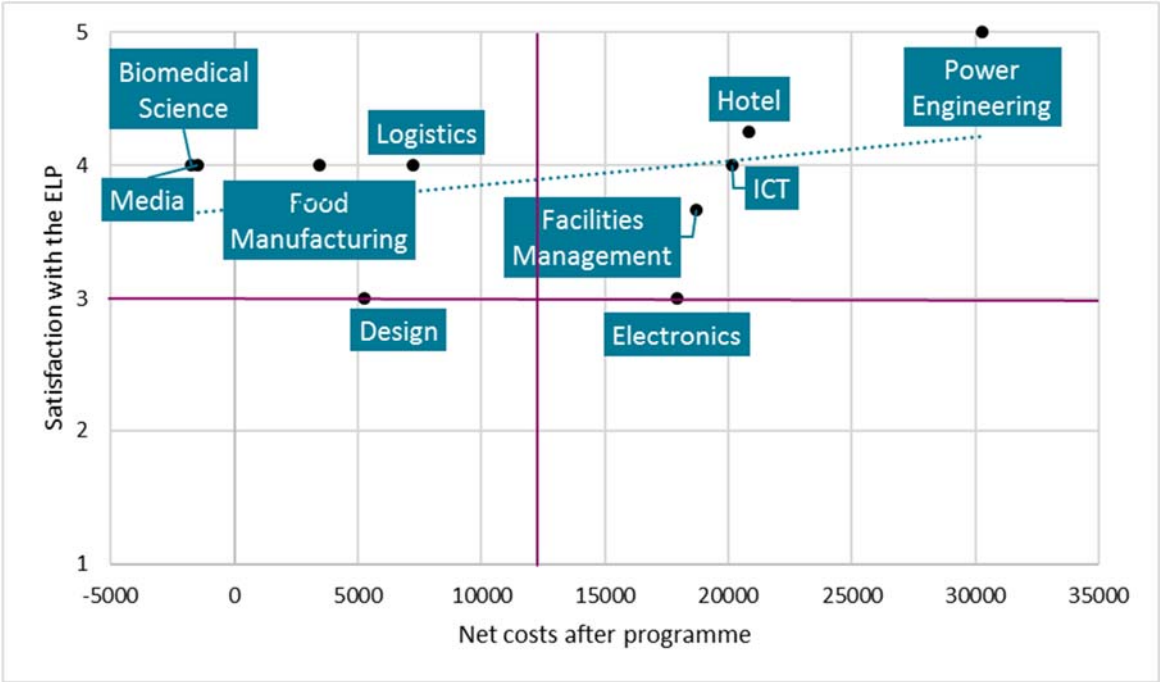

Notes: N=23

Figure 22 and Figure 23 show the results for whether firms’ intention to provide additional ELP places in the future is conditional on changes in the programme. As with the analysis of programme satisfaction, Table 12 and Table 13 in the appendix show the estimation results of the determinants of the readiness to continue providing ELP places. In order to simplify the presentation, the dependent variable of the OLS estimation is coded as a linear variable taking values one, two, three or four for each response category.

The readiness of firms to continue providing ELP places matters not only because of numbers. **These firms also represent important propagators and ambassadors of the ELP**, which is critical given the programme’s newness and current low visibility. Similarly, if currently active firms were to stop training, it would be a negative signal to potential but not yet active firms. Convincing firms to **continue the ELP across multiple waves also matters because of the entry costs into the programme**. Continuously active firms will be able to reduce the planning costs of starting the programme and thereby operate more efficiently.

The results show that only 13% of firms do not plan to provide ELP places in the future and 26% of the firms will only provide ELP place in the future if the characteristics of the ELP change. Hence, 39% of firms will not continue with the programme in its present form. On the other hand, 17% among the 60% of firms indicating that they will continue with the programme plan to increase the number of supplied ELP places. Hence, firms display a large amount of heterogeneity regarding the future plans for the ELP.

Heterogeneity is also visible across sectors. Food Manufacturing and Design are the sectors with the least enthusiastic firms, whereas firms in the ELPs for Power Engineering, Logistics and Hotel sectors are more optimistic to continue their engagement.

Differentiating the results according to firm size shows that only 50% of SMEs continue with the programme unconditionally, while more than 70% of large firms plan to continue or even expand their provision of ELP places. The estimation results in Table 12 and Table 13 in the appendix generally support that SMEs are less likely to continue with the ELP after accounting for sector and other variables. However, this result is only marginally significant and in one of the estimations only. When we include employee qualification importance and low turnover for competitiveness, the amount of cooperating planning time or the amount of retained ELP participants in addition to ELP sectors, we get different results. This highlights the limitations of multiple regression analysis with such a small sample. However, since none of these variables affects the estimates for SMEs alone, we conclude that SMEs are less likely to continue with the ELP than large firms are.

Figure 22: Continuation of participation

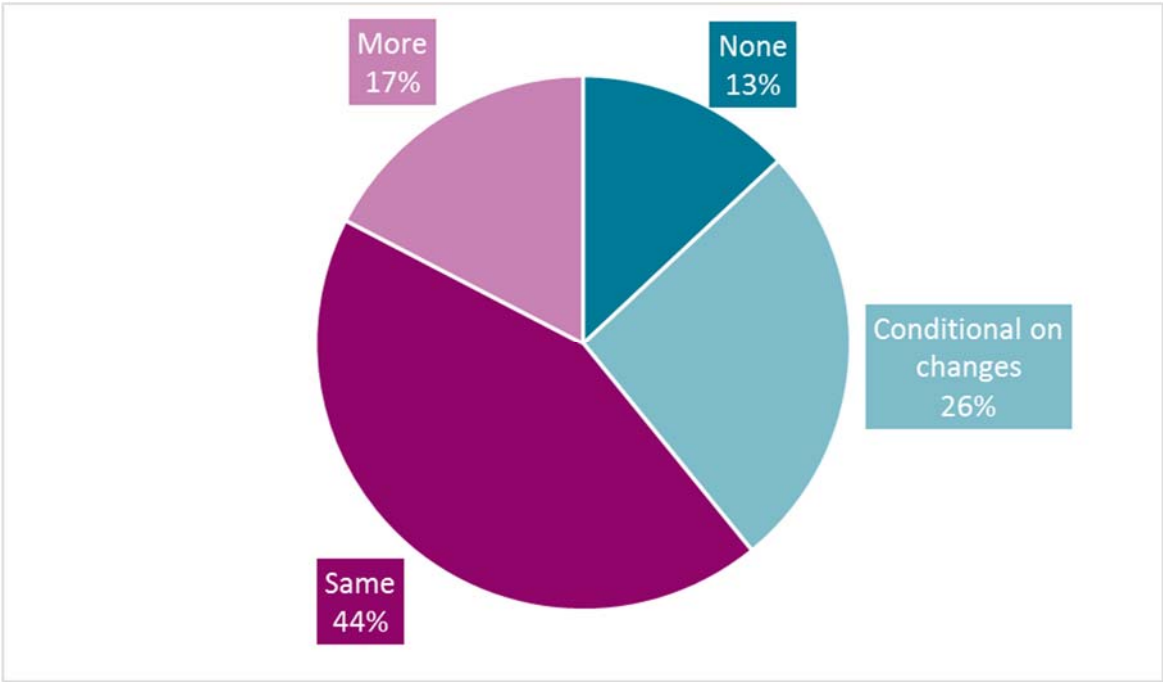

Notes: N=23

Figure 23: Heterogeneity of continuation

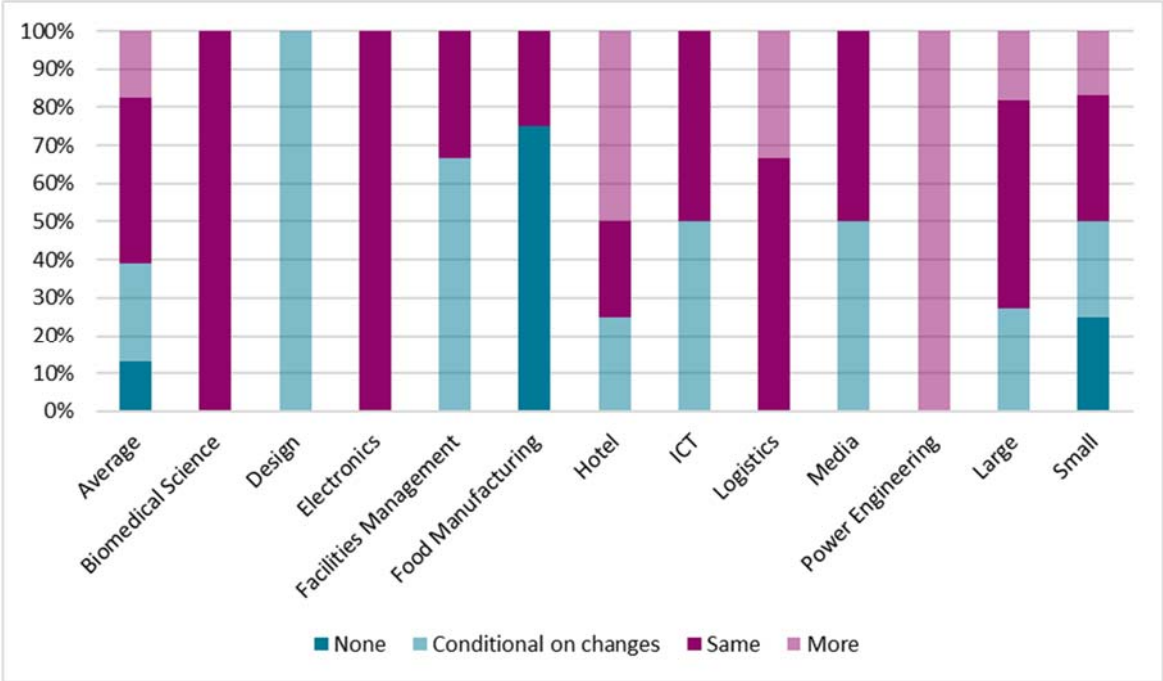

Notes: N(Average)=23

Finally, the results in Table 12 in the appendix support the hypothesis that **high programme net costs dissuade firms from continuing or expanding their supply of ELP places**. Table 12 further tends to support the hypothesis that firms with high demand for skilled employees are more likely to continue with the ELP. Concretely, the intention to continue is stronger for firms for which employee qualification or low turnover are more important determinants of competitiveness. Furthermore, higher turnover rates and better quantitative labour market situations decrease willingness to continue active participation in the programme. However, the last two indicators of demand for skilled employees appear to be unrelated to continuation with the ELP. In other words, the labour market situation in terms of the available quality and the number of applications per skilled position both seem to have no correlation with willingness to continue, after accounting for the ELP sector.

Table 13 displays a similar picture for ELP continuation to those for ELP satisfaction. Firms that spend more of their planning time in cooperation with Polytechnics are more likely to continue and so are firms that have been able to retain more ELP participants in the firm. The wage of ELP participants does not affect the continuation decision, while higher wages of skilled employees in the ELP occupation foster continuation. Hence, high relative wages between these two groups represent a hindrance to continuation.

7. Discussion, Conclusions & Recommendations

Results

Firms participating in the ELP incur **costs of about S\$50,000** per participant per year, of which participant labour costs and on-the-job training costs are the most important cost types. Firms reap **benefits of about S\$38,000** per year. Participants' productive value is the most important benefit, followed by subsidies and saved adjustment costs. Combining the ELP's costs and benefits yields the **net costs, which are about S\$12,000** per participant per year. These net costs are relatively high compared to the average costs.

Since firms face net costs even after the deduction of substantial subsidies, **the current configuration limits the programme's expansion potential** from two sides. Few of firms are willing to accept the net costs, and the government has limited resources to expand the number of companies receiving subsidies. Therefore, **we recommend to revise the ELP construct**.

This information is a major advantage for SSG because they come so early in the life of the ELP. These results are generated by the first implementation of the programme from the point of view of the companies. As with all innovations, improvements need to be implemented immediately after the first release, when the expectations of actors are not yet entrenched.

As shown by the detailed comments on granular results, there will be no simple solution applicable to all ELP sectors. Making and keeping the ELP attractive to both firms and students will require a combination of different measures. The following are possible measures to improve the ELP.

Discussion of Policy options

The ELP is definitely a step forward for improving the transition from the education system to the labour market for Singapore's young generation. All interviewees value the ELP as a necessary and important contribution to solving the labour market shortages. That enthusiasm can already be seen as preliminary success for the ELP.

SSG is interested in evidence from the early stages of ELP development and commissioned this cost-benefit study. One of the research questions concerns how the ELP can be improved. This gives SSG the opportunity to eliminate any problems while the programme is still new so the ELP can be developed into a sustainable and attractive program for all. Reform experience has shown that one cannot know from the outset of such a complex initiative how various actors will react. It is always necessary to identify what works and what the potential for improvement might be.

Conducting detailed research at this very early stage in the ELP is far-sighted on the part of SSG. If research were delayed, it would likely be much more difficult to make changes with more companies and students involved. With the present study, SSG has a strong foundation for evidence-based changes toward implementing a sustainable and attractive programme. We summarize some of the options for constructive change in the following.

1. Retain current ELP setup

The results suggest that average net costs are about S\$12,000 per participant per year, which is relatively high compared to average total costs of about S\$50,000. Since firms face net costs even after the deduction of substantial subsidies, retaining the current ELP setup limits the programme's potential to expand from two sides. First, a limited

number of firms are willing to accept the net-costs. Second, the government is restricted in the ability to expand the number of firms receiving subsidies. Therefore, we do not recommend pursuing this variant further.

2. Change ELP parameters to decrease net costs

In the medium and long term, reducing the high net costs should be a focus. This would improve the programme's attractiveness for firms, therefore increasing the number of training firms. This would be essential to reaching the long-term goals of the Industry Transformation Maps.

a. Decrease wages of ELP participants

ELP participants receive 84% of the wage of a skilled employee. For an education and training programme this average wage is very high, particularly as the ELP participants spend about 20% of their time in classroom education. Thus a "fair" wage that accounts for the expenditures of firms for training and the non-productive time of ELP participants would be substantially lower. In comparison, trainee wages in countries with a long tradition of dual VET programmes are only a small fraction of skilled wages in the same occupation (Switzerland ca. 20%, Germany ca. 25% and Austria ca. 35%). Hence, decreasing the wage of ELP participants (*ceteris paribus*) is one possibility to decrease net costs to firms.

b. Increase ELP duration

Currently, the ELPs last between 12 and 18 months, which is relatively short compared to dual VET programmes in Austria, Germany and Switzerland (which last 3 to 4 years). Since ELP participants' productivity increases over time, increasing the duration of the programme can make the ELP more attractive to firms. Alternatively, the ELP could be an integrated part of the Polytechnics or the ITE. Similarly, increasing commitment of students to firms reduces the risk that participants leave the firm after the ELP, thereby reducing ELP net costs. However, an increase of the duration would only improve the cost-benefit ratio for firms if it were combined with a reduction of participants' relative salaries (see a.) or an increase in their productivity (see c.).

c. Other measures to improve productivity

Regardless of the ELP's duration, measures should be tested to increase the productive use of ELP participants. These can include extending the time in firms when ELP participants work productively, reducing the time used for un- or semiskilled tasks, and measures that increase the productivity of ELP participants while substituting skilled employees.

For example, net costs could be reduced by combining extended programme duration with digressive classroom time (for example 30%/20%/10% classroom education in the first/second/third part of an ELP, respectively). Even without classroom education in the final period, ELP participants would continue to receive workplace training and thereby further improve their skills and employability.

d. Streamline administrative processes

Net costs of ELP can be reduced by minimizing the administrative burden on firms and polytechnics. This could be achieved, for example, through e-services or through cooperation of companies in the same sector (see 2e).

e. Foster cooperation among firms

Creating institutions (or using existing professional associations) that facilitate knowledge exchange and the development of standardized blueprints for ELPs across firms decreases the ELP's net costs and induces spillovers across firms. This is a particularly important step in getting SMEs to offer the ELP.

3. Target subsidies more specifically

The section on theoretical foundations underlines that subsidies should only be distributed if there are no deadweight effects for the government. As the results and interviews show, the current ELP cannot rule out such windfall gain effects for firms. However, the situation varies from sector to sector and between small and large firms. Therefore, the distribution of subsidies should take this heterogeneity into account.

a. Focus subsidies on ELP preparation

High fixed costs of developing on-the-job blueprints can prevent firms from offering ELP places even if ELP participation is optimal. The entry barrier created by these fixed costs is particularly relevant for SMEs. Hence, focusing subsidies on covering fixed costs of implementation improves participation with lower risk of deadweight losses.

b. Focus subsidies on covering costs of classroom education

A potential drawback of subsidies is the potential incentive to accept subsidies as windfall gains while underinvesting in training quality. Focusing subsidies on covering the 4% of classroom education costs reduces this issue.

c. Make subsidies size- and sector-specific

The higher importance of fixed costs for SMEs illustrates that ELP net costs differ across ELP sectors and firm sizes. Therefore, the ideal scheme calculates subsidies based on ELP and firm characteristics. The results of this study support the claim that net costs are heterogeneous by firm size and provide first data to implement such a system, though the sample size remains insufficient to draw definite conclusions.

4. Increase attractiveness of ELP for students and firms

Potential revisions of the ELP should balance the incentives of firms and students, since reducing the attractiveness of the ELP for students diminishes either their willingness to participate at all or the ability level of interested students. Keeping student incentives in mind matters particularly because decreasing their wages or increasing the programme duration (*ceteris paribus*) might diminish attractiveness.

a. Clarify location of the ELP in Singapore's education system

The ELP currently has two separate strands for graduates of the ITE and Polytechnics, respectively. Our interviews with firms have indicated that firms view these two types of ELP participants differently, with those from

Polytechnics deemed to have a more far-reaching career plan than their ITE counterparts.

Furthermore, firms are not always clear about the relationship between the ELP and other initiatives. For example, several firms compared ELP participants to interns from Polytechnics. Another firm compared ELP participants to employees who pursue continuing education in evening classes. Since the attractiveness of a programme partly depends on how well it can signal its value to future employees, sharpening the ELP profile helps improve its attractiveness to students and to firms.

Clarifying the location of the ELP in the education system might also help avoid differences in expectations between firms and ELP participants. Concretely, one firm coined the term “Learn and Earn rather than Earn and Learn”, referring to its identification of ELP participants as students rather than employees. This kind of differences in expectations matters particularly because firms consistently consider motivation and attitude as key employee abilities.

In addition, firms complain that participants see the ELP as only an intermediate phase on the way to a university degree. Since the government uses a lot of money to attract both students and companies to the ELP and thereafter into the workforce, the ELP should not be an easy path to university. Permeability also is important for ELP students, but each programme should have a main purpose and clear additional requirements for moving on to further or alternative options.

In a broader context of creating Universities of Applied Sciences (UAS; a second type of university) in Singapore, the ELP could have better positioning for both ITE and Polytechnic students. One option is to make an ELP and 2-3 years of professional experience prerequisites for entry into a UAS, comparable to requirements in Switzerland or Germany. If such UASs would offer part-time study options, this would help individuals keep working in firms while studying at the university.

b. Improve signalling value

The workplace training component of the ELP follows a firm-specific on-the-job blueprint. In addition, participants must pass classroom education in Polytechnics to earn their ELP certificates but there is no corresponding performance requirement in workplace training. The power of an ELP certificate as a signal might be improved if programme content were more homogenous and if a specific level of workplace performance were required. An alternative would be to integrate the ELP as part of a formal diploma granted by the Polytechnics and/or the ITE. This would earn the ELP recognition from the Ministry of Education and position it as a “learn and earn” programme. In any case, the involvement of industry associations would be very important.

Regular surveys on the ELP’s value and firms’ satisfaction with it can help to highlight the programme’s particular benefits. Information campaigns and interviews with firms’ CEOs can also help raise awareness.

c. Improve awareness

The ELP has only been around for about three years and is not known well among firms and potential participants. Hence, raising awareness among these groups will help expand the project by attracting more participants.

Since there is not yet high demand among students or firms for the ELP, new policy directions need to account for both groups' follow-on effects. Therefore, we recommend simultaneously introducing a combination of several above-mentioned measures.

Some measures can be implemented with immediate effect, others require cooperation and interface management with other institutions. The latter should be considered in the medium or longer term.

We also recommend repeating a comparable study at regular intervals to measure whether new evidence-based measures are effective. In Switzerland for example, cost-benefit studies are carried out every four years.

Another option for SSG would be to simultaneously estimate the effects of a combination of measures using a simulation study. If reforms of occupations are carried out in Switzerland, a simulation study must be carried out before implementing the reform in order to show its effect on costs and benefits for training companies.

8. References

- APEC Asia-Pacific Economic Cooperation (2010). Case Study on Institute of Technical Education (ITE) Singapore. Available at <http://hrd.apec.org/images/6/6b/77.1.pdf>.
- Becker, G. (1962). Investment in human capital: a theoretical analysis. *Journal of Political Economy*, 70 (5), 9–49.
- Blatter, M.; Muehlemann, S.; Schenker, S. & S.C. Wolter (2016). Hiring Costs for Skilled Workers and the Supply of Firm-Provided Training, *Oxford Economic Papers*, 68 (1), 238-257.
- Hanushek, R. & L. Woessmann (2012). Do better schools lead to more growth? Cognitive skills, economic outcomes, and causation, *Journal of Economic Growth*, 17:267–321
- IBE International Bureau of Education (2010/11). *World Data on Education*. Singapore. 7th edition. May 2011. Retrieved from: http://www.ibe.unesco.org/fileadmin/user_upload/Publications/WDE/2010/pdf-versions/Singapore.pdf.
- Ministry of Manpower (2016a). Table: Occupational Wages 2016, available at <http://stats.mom.gov.sg/Pages/Occupational-Wages-Tables2016.aspx> (accessed 13.12.2017).
- Ministry of Manpower (2016b). Conditions of Employment 2016, available at <http://stats.mom.gov.sg/Pages/Conditions-Of-Employment-2016.aspx> (accessed 13.12.2017).
- Ministry of Manpower (2017a). Public holidays: entitlement and pay. available at <http://www.mom.gov.sg/employment-practices/public-holidays-entitlement-and-pay> (accessed 13.12.2017).
- Ministry of Manpower (2017b). Hours of work, overtime and rest day. available at <http://www.mom.gov.sg/employment-practices/hours-of-work-overtime-and-rest-days> (accessed 13.12.2017).
- MOE Ministry of Education Singapore (2015a). *Bringing Out the Best in Every Child. Education in Singapore*. Retrieved from: <https://www.moe.gov.sg/docs/default-source/document/about/files/moe-corporate-brochure.pdf>.
- MOE Ministry of Education Singapore (2015b). *Education Statistics Digest 2015*. Singapore. Available at: <https://www.moe.gov.sg/docs/default-source/document/publications/education-statistics-digest/esd-2015.pdf> (accessed 11.12.2017).
- MOE Ministry of Education Singapore (2017). *Education Statistics Digest 2017*. Singapore. Available at: https://www.moe.gov.sg/docs/default-source/document/publications/education-statistics-digest/esd_2017.pdf (accessed 23.7.2018).
- Moretti, L.; Mayerl, M.; Muehlemann, S.; Schloegl, P. & S.C. Wolter (2017). So Similar and Yet so Different: A Comparative Analysis of a Firm's Cost and Benefits of Apprenticeship Training in Austria and Switzerland, *IZA DP 11081*.
- Muehlemann, S. & S.C. Wolter (2014). Return on investment of apprenticeship systems for enterprises: Evidence from cost-benefit analyses, *IZA Journal of Labor Policy*, 3:25
- Muehlemann, S.; Pfeifer, H.; Walden, G.; Wenzelmann, F. & S.C. Wolter (2010). The Financing of Apprenticeship Training in the Light of Labor Market Regulations, *Labour Economics*, 17(5), 799-809.

- Muehlemann, S.; Ryan, P. & Wolter S.C. (2013). Monopsony Power, Pay Structure and Training, *Industrial and Labor Relations Review*, 66(5), 1095-1112.
- Muehlemann, S.; Schweri, J.; Winkelmann, R. & S.C. Wolter (2007). An Empirical Analysis of the Decision to Train Apprentices. *LABOUR: Review of Labour Economics and Industrial Relations*, 21(3), S. 419-441.
- OECD (2011), "Singapore: Rapid Improvement Followed by Strong Performance", in *Lessons from PISA for the United States*, OECD Publishing. <http://dx.doi.org/10.1787/9789264096660-8-en>.
- Quah, E., and Toh, R. (2012). *Cost-benefit analysis: Cases and materials*. Routledge.
- Renold, U., Bolli, T., Caves, K., Bürgi, J., Egg, M. E., Kemper, J., & Rageth, L. (2016). *Feasibility Study for a Curriculum Comparison in Vocational Education and Training. Intermediary Report II: Education-Employment Linkage Index* (No. 80). KOF Studien, available at <https://www.research-collection.ethz.ch/bitstream/handle/20.500.11850/119252/eth-49542-01.pdf?sequence=1&isAllowed=y> (accessed 8.12.2017).
- Rupietta, C., & Backes-Gellner, U. (2012). High quality workplace training and innovation in highly developed countries. *Economics of Education Working Paper Series*, 74.
- Schweri, J.; Muehlemann, S.; Pescio, Y.; Walther, B.; Wolter, S.C.; Zuercher, L. (2003). *Kosten und Nutzen der Lehrlingsausbildung aus der Sicht der Betriebe*, Chur; Zürich: Rüegger Verlag.
- Singapore (2018). *Industrial Transformation Maps*, available at <https://www.mti.gov.sg/MTIInsights/Pages/ITM.aspx> (accessed 24.1.2018)
- SkillsFuture (2015) *SkillsFuture Earn and Learn Programme*, available at (<http://www.skillsfuture.sg/NewsAndUpdates/DetailPage/4fa69eb5-da9c-491e-890b-4f11e8602545>)
- SkillsFuture (2017a). *More Work-Learn Opportunities for Polytechnic and ITE Graduates*, available at http://www.ssg-wsg.gov.sg/new-and-announcements/18_Nov_2017.html (accessed 24.1.2018)
- SkillsFuture (2017b), *SkillsFuture Earn and Learn Programme*, available at <http://www.skillsfuture.sg/earnandlearn#whatisit> (accessed 24.1.2018).
- SkillsFuture (2018), *Singapore Workforce Skills Qualifications (WSQ)*, available at <http://www.ssg.gov.sg/wsq.html> (accessed 5.2.2018).
- Strupler, M.; Wolter, S.C. (2012). *Die duale Lehre: eine Erfolgsgeschichte – auch für die Betriebe*, Chur; Zürich: Rüegger Verlag.
- UNESCO. *United Nations Educational, Scientific and Cultural Organization* (2016). *ISCED Mappings*, Singapore. Retrieved from: <http://www.uis.unesco.org/Education/ISCEDMappings/Pages/default.aspx>.
- Wolter, S.C. & P. Ryan (2011): *Apprenticeship*, in: Hanushek, E.A., Machin, S. and Wössmann, L. (Eds.): *Handbook of Economics of Education*, Volume 3, Elsevier, S. 521-576.
- Wolter, S.C.; Muehlemann, S. & J. Schweri (2006). Why some firms train apprentices and many others not, *German Economic Review*, 7(3): 249-264.

9. Appendix I: Additional Tables

Table 3: Costs and benefits of ELP

	Participant labour costs	Planning costs	Hiring/administration costs	Classroom education costs	On-the-job training costs	Total costs of ELP	Productive value	Subsidies	Netcosts during programme	Saved hiring costs	Saved adjustment costs	Net costs after programme
Sample Average	25786	4233	3022	1817	15192	50051	17602	14017	18431	1041	5317	12368
Biomedical Science	21480	1053	1485	650	14678	39346	20215	15000	4130	533	5353	-1755
Design	21600	1525	5614	3850	12782	45372	18015	15000	12356	927	6142	5288
Electronics	34470	4722	1119	1115	16485	57911	15434	15000	27478	1056	8510	17912
Facilities Management	25828	5635	1448	706	19893	53509	11809	15000	26700	1159	6822	18719
Food Manufacturing	24805	1918	1440	867	8806	37836	21431	10000	6405	702	3731	3450
Hotel	24908	6065	3453	2475	16475	53376	12099	15000	26277	1087	4342	20848
ICT	23340	4288	7103	4025	23179	61935	21006	15000	25928	1304	4485	20138
Logistics	26714	3099	2257	1771	10762	44604	16637	15000	12966	1241	4478	7247
Media	23937	1280	1355	753	11123	38449	22993	12762	2693	667	4217	-1463
Power Engineering	31500	11778	8020	2444	32201	85942	29756	15000	41187	1413	9477	30296
Large firms	26674	4996	3822	2055	17228	54775	16960	15000	22815	1218	6418	15179
SME	24898	3470	2222	1579	13156	45326	18245	13035	14047	864	4215	9557

Notes: The table displays yearly values in S\$.

Table 4: Relationship between ELP participation and skill demand indicators

Including ELP sector	Relevance of qualification		Relevance of low turnover		Turnover rate		Labour market supply quantity		Labour market supply quality		Number of applications	
	No	Yes	No	Yes	No	Yes	No	Yes	No	Yes	No	Yes
Small or medium sized firm	-0.232 (0.153)	-0.189 (0.164)	-0.080 (0.175)	-0.075 (0.182)	-0.258 (0.182)	-0.136 (0.201)	-0.031 (0.184)	0.130 (0.196)	0.568 (8.648)	4.335 (11.095)	0.019 (0.032)	-0.015 (0.040)
Participating firm	0.489** (0.196)	0.462* (0.239)	0.233 (0.230)	0.057 (0.272)	-0.047 (0.227)	0.285 (0.282)	0.301 (0.228)	0.538* (0.273)	-4.380 (10.560)	-0.923 (15.111)	0.061 (0.040)	0.059 (0.054)
Constant	4.067*** (0.122)	3.973*** (0.285)	3.861*** (0.140)	4.278*** (0.327)	3.123*** (0.149)	3.283*** (0.316)	2.857*** (0.152)	3.165*** (0.302)	23.946*** (7.038)	26.073 (15.859)	0.095*** (0.026)	0.065 (0.059)
N	126	126	123	123	108	108	107	107	97	97	100	100
R ²	0.068	0.264	0.010	0.275	0.019	0.245	0.017	0.320	0.002	0.099	0.026	0.150

Notes: The dependent variables for the relevance of qualification and low turnover for firm competitiveness as well as for the quality and quantity of the labour market supply in the ELP occupation are measured on a five point Likert scale, while turnover rate refers to percentage and number of applicants is a count. The table displays OLS coefficients and standard errors in parentheses. *, ** and *** denote significance at the 10%, 5% and 1% level, respectively.

Table 5: Heterogeneity of skill demand indicators across ELP sectors

	Relevance of Qualification	Relevance of Low Turnover	Turnover rate	Labour market supply quantity	Labour market supply quality	Number of applications per skilled position
Accountancy	3.9	4.3	5.8	3.2	3.2	28.0
Aerospace	3.0	3.0	1.0	4.0	4.0	20.0
Banking	4.0	4.0	3.0	3.0	4.0	30.0
Biomedical Science	4.0	5.0	10.0	1.0	3.0	8.0
Design	3.6	3.5	6.0	3.0	2.9	26.4
Electronics	3.5	3.8	6.4	3.8	3.6	16.3
Energy and chemicals	3.5	3.5	3.3	2.7	2.7	75.3
Facilities Management	4.2	3.7	22.2	2.8	2.8	18.6
Food Manufacturing	4.0	4.1	13.4	3.0	2.8	27.9
Food services	3.3	2.4	11.3	3.1	3.0	14.8
Healthcare		3.0				
Hotel	4.6	4.1	16.0	2.8	3.2	10.0
Human resource	4.1	3.9	11.0	3.3	3.2	21.4
ICT	4.3	3.9	17.8	2.4	2.0	27.1
Logistics	4.4	4.3	4.0	3.0	3.0	24.0
Maritime	4.3	4.3	0.0	3.0	4.0	0.0
Media	4.0	3.8	17.0	3.0	3.3	5.8
Offshore and marine engineering	3.0	5.0	17.5	3.0	2.0	1.0
Power Engineering	4.5	4.5	10.0	3.5	3.5	10.0
Precision engineering	4.8	3.8	5.0	2.5	2.5	10.0
Public Transport	5.0		5.0	4.0	4.0	10.0
Retail	4.0	4.1	20.3	2.4	2.3	36.7

Notes: The variables for the relevance of qualification and low turnover for firm competitiveness as well as for the quality and quantity of the labour market supply in the ELP occupation are measured on a five point Likert scale, while turnover rate refers to percentage and number of applicants is a count.

Table 6: Relationship between ELP participation and relevance of ELP characteristics

	Shape content	ELP duration	Classroom education share	Applicant quality	Participant wages	Classroom education organization	Subsidies
Small or medium sized firm	-0.134 (0.180)	-0.324 (0.195)	-0.196 (0.180)	-0.100 (0.180)	-0.227 (0.186)	0.051 (0.183)	-0.118 (0.183)
Participating firm	0.011 (0.256)	-0.157 (0.279)	0.018 (0.253)	0.616** (0.256)	0.042 (0.264)	-0.166 (0.257)	0.643** (0.261)
Constant	3.675*** (0.308)	3.144*** (0.318)	3.448*** (0.304)	3.378*** (0.293)	3.212*** (0.304)	3.731*** (0.309)	3.941*** (0.303)
N	116	115	114	115	116	114	118
R ²	0.218	0.194	0.202	0.237	0.263	0.204	0.235
Including ELP sector	Yes	Yes	Yes	Yes	Yes	Yes	Yes

Notes: The dependent variables are measured on a five point Likert scale. The table displays OLS coefficients and standard errors in parentheses. *, ** and *** denote significance at the 10%, 5% and 1% level, respectively.

Table 7: Relationship between ELP participation and relevance of motives to participate in ELP

	Obtaining skilled employees	Saving recruitment costs	Saving adjustment costs	Specific needs	Avoid wrong hirings	Hiring best participants	Turnover reduction	Replacing unskilled employees	Securing sector/region supply
Small or medium sized firm	-0.160 (0.175)	0.018 (0.181)	0.098 (0.178)	0.135 (0.138)	0.065 (0.192)	-0.029 (0.168)	-0.103 (0.162)	-0.148 (0.192)	-0.118 (0.157)
Participating firm	0.219 (0.257)	0.135 (0.262)	0.232 (0.258)	-0.044 (0.201)	-0.384 (0.277)	-0.246 (0.244)	0.080 (0.235)	-0.357 (0.276)	0.182 (0.228)
Constant	3.405*** (0.309)	3.436*** (0.315)	3.067*** (0.310)	3.829*** (0.242)	3.304*** (0.333)	4.013*** (0.292)	4.046*** (0.283)	3.399*** (0.332)	3.941*** (0.274)
N	129	128	127	128	126	126	127	126	127
R ²	0.242	0.191	0.185	0.264	0.190	0.241	0.231	0.221	0.208
Including ELP sector	Yes	Yes	Yes	Yes	Yes	Yes	Yes	Yes	Yes

Notes: The dependent variables are measured on a five point Likert scale. The table displays OLS coefficients and standard errors in parentheses. *, ** and *** denote significance at the 10%, 5% and 1% level, respectively.

Table 8: Heterogeneity of relevance of ELP characteristics across ELP sectors

	Shape content	ELP duration	Classroom education share	Applicant quality	Participant wages	Classroom education organization	Subsidies
Biomedical Science	5.0	5.0	2.0	4.0	4.0	4.0	5.0
Design	3.7	3.3	3.3	3.4	3.3	3.7	3.7
Electronics	4.0	3.2	3.3	2.8	2.8	3.3	3.8
Facilities Management	3.6	3.0	3.6	3.6	3.4	3.0	3.8
Food Manufacturing	3.3	3.0	3.1	3.5	2.9	3.1	3.6
Hotel	3.7	2.7	3.3	3.0	3.3	3.9	4.3
ICT	3.3	3.1	3.1	3.4	2.7	3.4	3.9
Logistics	3.0	3.2	3.2	3.2	2.4	2.6	3.2
Media	3.8	3.2	3.4	3.4	3.2	3.2	3.8
Power Engineering	5.0	3.5	3.5	4.0	4.5	4.0	4.5

Notes: The variables are measured on a five point Likert scale (1=completely irrelevant, 2=rather irrelevant, 3=neutral, 4=rather relevant, 5=very relevant). *, ** and *** denote significance at the 10%, 5% and 1% level, respectively.

Table 9: Heterogeneity of relevance of motives to participate in ELP across ELP sectors

	Obtaining skilled employees	Saving recruitment costs	Saving adjustment costs	Specific needs	Avoid wrong hirings	Hiring best participants	Turnover reduction	Replacing unskilled employees	Securing sector/region supply
Biomedical Science	5.0	5.0	5.0	5.0	5.0	5.0	5.0	3.0	5.0
Design	3.6	3.6	3.6	3.4	3.4	3.5	3.6	3.0	3.6
Electronics	3.7	3.2	3.0	3.2	2.8	3.3	3.8	3.2	3.3
Facilities Management	3.8	3.3	3.2	3.8	3.2	3.2	3.2	3.2	3.8
Food Manufacturing	3.3	3.5	3.2	3.9	3.5	3.8	4.0	3.6	4.0
Hotel	3.9	3.6	3.1	3.7	3.7	3.9	4.1	3.1	4.0
ICT	3.9	3.9	3.3	3.9	3.6	3.9	3.9	2.9	3.8
Logistics	4.0	3.2	3.4	4.2	3.6	3.8	4.0	2.8	3.8
Media	3.7	3.0	3.0	3.6	3.3	3.4	3.3	3.1	3.4
Power Engineering	4.5	5.0	4.0	4.5	4.5	5.0	5.0	4.0	4.5

Notes: The variables are measured on a five point Likert scale (1=completely irrelevant, 2=rather irrelevant, 3=neutral, 4=rather relevant, 5=very relevant). *, ** and *** denote significance at the 10%, 5% and 1% level, respectively.

Table 10: Relationship between skill demand indicators and satisfaction with ELP

	Model 1		Model 2		Model 3		Model 4		Model 5		Model 6	
	No	Yes	No	Yes	No	Yes	No	Yes	No	Yes	No	Yes
Including ELP sector												
Small or medium sized firm	0.095 (0.303)	-0.347 (0.573)	-0.099 (0.335)	-0.692 (0.611)	0.088 (0.348)	-0.586 (0.800)	-0.042 (0.354)	-1.303** (0.534)	-0.037 (0.358)	-0.744 (0.636)	0.038 (0.355)	-0.736 (0.866)
Relevance of qualification	0.413* (0.233)	0.438 (0.333)										
Relevance of low turnover			0.182 (0.184)	0.108 (0.248)								
Turnover rate					-0.525 (0.883)	-0.950 (1.261)						
Labour market supply quantity							-0.114 (0.186)	-0.764** (0.300)				
Labour market supply quality									0.092 (0.215)	-0.233 (0.402)		
Number of applications											-0.007 (0.009)	-0.010 (0.014)
Constant	2.032* (1.082)	1.248 (1.524)	3.271*** (0.780)	2.677** (1.116)	3.893*** (0.291)	3.190** (0.949)	4.261*** (0.625)	4.528*** (0.897)	3.632*** (0.688)	3.465** (1.192)	3.961*** (0.323)	3.502** (1.170)
N	23	23	21	21	20	20	21	21	21	21	20	20
R ²	0.135	0.535	0.055	0.430	0.025	0.445	0.020	0.699	0.010	0.476	0.037	0.438

Notes: The dependent variable is the overall satisfaction with the ELP programme on a five point Likert scale (1=Very dissatisfied, 2=Dissatisfied, 3=Neutral, 4=Satisfied, 5=Very Satisfied). The table displays OLS coefficients and standard errors in parentheses. *, ** and *** denote significance at the 10%, 5% and 1% level, respectively.

Table 11: Relationship between net cost determinants and satisfaction with ELP

	Model 1		Model 2		Model 3		Model 4		Model 5		Model 6	
	No	Yes	No	Yes	No	Yes	No	Yes	No	Yes	No	Yes
Including ELP sector												
Small or medium sized firm	0.129 (0.333)	-0.427 (0.576)	0.131 (0.303)	-0.454 (0.540)	0.026 (0.303)	-0.585 (0.465)	0.061 (0.312)	-0.728 (0.503)	0.016 (0.321)	-0.733 (0.571)	-0.057 (0.331)	-0.550 (0.349)
Share of planning cooperation	0.026 (0.018)	0.036 (0.027)										
Share of retained participants			0.746* (0.399)	0.911 (0.685)								
ELP participant wage					0.001 (0.001)	0.003* (0.001)						
Wage of skilled employee							0.304 (0.241)	0.926 (0.609)				
Relative wage ELP									-0.393 (1.013)	-1.135 (3.043)		
Net costs after programme											-0.009 (0.013)	-0.063*** (0.016)
Constant	3.488*** (0.377)	2.281** (0.944)	3.279*** (0.399)	2.089* (1.009)	1.061 (1.823)	-1.519 (2.238)	3.115*** (0.668)	1.333 (1.314)	4.228*** (0.855)	4.103 (3.064)	4.048*** (0.305)	3.061*** (0.502)
N	22	22	23	23	23	23	23	23	23	23	23	23
R ²	0.093	0.544	0.149	0.536	0.110	0.623	0.074	0.557	0.007	0.462	0.023	0.787

Notes: The dependent variable is the overall satisfaction with the ELP programme on a five point Likert scale (1=Very dissatisfied, 2=Dissatisfied, 3=Neutral, 4=Satisfied, 5=Very Satisfied). The table displays OLS coefficients and standard errors in parentheses. Wages of ELP participants and skilled employees in the ELP occupation enter in S\$1,000. *, ** and *** denote significance at the 10%, 5% and 1% level, respectively.

Table 12: Relationship between skill demand indicators and continuation of ELP

	Model 1		Model 2		Model 3		Model 4		Model 5		Model 6	
	No	Yes	No	Yes	No	Yes	No	Yes	No	Yes	No	Yes
Including ELP sector												
Small or medium sized firm	-0.382 (0.370)	0.428 (0.525)	-0.505 (0.379)	0.115 (0.594)	-0.531 (0.373)	-0.553 (0.842)	-0.558 (0.373)	-1.045* (0.504)	-0.569 (0.374)	-0.349 (0.665)	-0.547 (0.403)	-0.622 (0.911)
Relevance of qualification	0.519* (0.285)	0.826** (0.305)										
Relevance of low turnover			0.389* (0.209)	0.365 (0.241)								
Turnover rate					-1.390 (0.945)	-0.592 (1.327)						
Labour market supply quantity							-0.168 (0.196)	-0.854** (0.283)				
Labour market supply quality									0.199 (0.224)	-0.047 (0.421)		
Number of applications											-0.005 (0.010)	-0.005 (0.015)
Constant	0.548 (1.323)	-0.304 (1.396)	1.332 (0.882)	1.904 (1.085)	3.145*** (0.312)	3.118** (0.998)	3.428*** (0.657)	4.708*** (0.847)	2.313*** (0.719)	3.093** (1.247)	3.021*** (0.367)	3.259** (1.231)
N	23	23	21	21	20	20	21	21	21	21	20	20
R ²	0.204	0.760	0.219	0.652	0.189	0.554	0.128	0.784	0.130	0.539	0.099	0.549

Notes: The dependent variable captures whether the firm continues providing ELP places in four categories (1=None, 2=Conditional on changes, 3=None, 4=More). The table displays OLS coefficients and standard errors in parentheses. *, ** and *** denote significance at the 10%, 5% and 1% level, respectively.

Table 13: Relationship between net cost determinants and continuation of ELP

	Model 1		Model 2		Model 3		Model 4		Model 5		Model 6	
	No	Yes	No	Yes	No	Yes	No	Yes	No	Yes	No	Yes
Including ELP sector												
Small or medium sized firm	-0.449 (0.364)	-0.017 (0.569)	-0.271 (0.333)	-0.003 (0.622)	-0.478 (0.385)	-0.078 (0.475)	-0.472 (0.396)	-0.265 (0.527)	-0.503 (0.394)	-0.315 (0.623)	-0.473 (0.410)	-0.098 (0.518)
Share of planning cooperation	0.038* (0.020)	0.047 (0.027)										
Share of retained participants			1.341*** (0.438)	0.795 (0.788)								
ELP participant wage					0.001 (0.001)	0.003** (0.001)						
Wage of skilled employee							0.117 (0.306)	1.256* (0.640)				
Relative wage ELP									0.485 (1.244)	-2.482 (3.320)		
Net costs after programme											0.003 (0.017)	-0.05* (0.024)
Constant	2.295*** (0.412)	2.051* (0.933)	1.775*** (0.438)	2.205* (1.161)	0.621 (2.316)	-2.854 (2.287)	2.605*** (0.848)	0.740 (1.379)	2.515** (1.049)	5.413 (3.343)	2.867*** (0.378)	3.048*** (0.745)
N	22	22	23	23	23	23	23	23	23	23	23	23
R ²	0.264	0.696	0.368	0.622	0.116	0.758	0.079	0.700	0.079	0.606	0.074	0.712

Notes: The dependent variable captures whether the firm continues providing ELP places in four categories (1=None, 2=Conditional on changes, 3=None, 4=More). The table displays OLS coefficients and standard errors in parentheses. Wages of ELP participants and skilled employees in the ELP occupation enter in S\$1,000. *, ** and *** denote significance at the 10%, 5% and 1% level, respectively.

Table 14: Heterogeneity of barriers to participation in the ELP across ELP sector and firm size

	No qualified applicants	Usefulness of training is too low	ELP is too complex/reg ulated	No need for skilled employees	It is cheaper to hire on the labour market	Costs of the training are too high	Trained participant would leave the company	Participant spend too little time in the firm	We are too specialized to convey the ELP content	The ELP offers no training for suitable job roles.	We have no time to train ELP participant	We fill skill demand by continuing education
Accountancy	3.5	3.0	3.0	3.0	3.0	3.0	4.0	3.0	3.0	3.0	2.5	3.0
Energy and Chemicals	3.0	2.0	2.0	1.0	2.0	1.0	2.0	2.0	2.0	2.0	1.0	5.0
Facilities Management	2.0	2.0	2.0	2.0	4.0	2.0	2.0	2.0	2.0	2.0	2.0	4.0
Food Services	3.5	3.0	3.0	2.5	2.5	3.0	4.5	2.5	2.0	1.5	2.5	4.0
Human Resource	2.8	3.3	2.8	2.0	2.4	3.8	4.3	2.8	2.0	2.5	2.6	3.6
ICT	3.5	3.3	3.3	2.7	2.7	3.0	3.8	3.5	2.7	3.0	2.8	3.8
Logistics	1.0	1.0	1.0	2.0	1.0	1.0	4.0	3.0	2.0	2.0	2.0	4.0
Maritime	4.0	3.0	5.0	2.0	3.0	3.0	4.0	5.0	3.0	3.0	3.0	5.0
Precision Engineering	4.5	4.0	4.0	2.0	3.0	5.0	4.0	3.0	4.0	3.0	3.0	4.0
Retail	4.7	4.3	3.7	4.0	3.7	4.0	4.3	4.0	3.7	3.7	3.7	4.0
Large	2.7	2.7	2.6	2.0	2.4	2.9	3.5	2.9	2.6	2.7	2.3	3.3
Small	3.8	3.5	3.4	2.8	2.9	3.4	4.2	3.3	2.6	2.7	2.9	4.1

Notes: The variables are measured on a five point Likert scale (1=completely irrelevant, 2=rather irrelevant, 3=neutral, 4=rather relevant, 5=very relevant).

10. Appendix II: Biographies of Authors



Prof. Dr. Ursula Renold is head of the research center for comparative education systems at the Swiss Federal Institute of Technology (ETH) in Zurich. In addition, she is Chairman of the University Board of the University of Applied Sciences and Arts, Northwestern Switzerland. She was a Visiting Fellow at the Harvard Graduate School of Education between September 2012 and March 2013. Prior to this, Renold was Director General of the Federal Office for Professional Education and Technology (OPET) until June 2012. In this position, she headed Switzerland's competence center for professional education, the universities of applied sciences, and led programme innovation starting in 2005. Before becoming Director General, she was head of OPET's Vocational Education and Training Division and Director of the Swiss

Federal Institute of Vocational Education and Training (teacher education). During her career, Renold has launched numerous key initiatives that have had great impact on the Vocational and Professional Education and Training system in Switzerland. She holds an honorary Professorship in Professional Education at the University of Applied Labour Studies in Mannheim (Germany).



Dr. Thomas Bolli is a postdoctoral researcher in the research center for comparative education systems at the Swiss Federal Institute of Technology (ETH) in Zurich. Before starting this position in April of 2013, he was awarded a Swiss National Science Foundation grant to visit the University of Lancaster as a postdoctoral researcher. He wrote his PhD thesis on the production and measurement of knowledge capital in the research centre for innovation at the Swiss Federal Institute of Technology (ETH) in Zurich. Building on this, his research interests consist of the statistical analysis of knowledge, in particular applying microeconometrics to questions regarding the economics of education, research, and innovation.



Prof. Dr. Stefan C. Wolter is a renowned expert in economics of education with a particular focus on vocational education and training. He is the executive director of the Swiss Coordination Centre for Research in Education, holds a professorship at the University of Bern, acts as permanent visiting professor at the University of Basel and serves in numerous expert boards on education. Among others, he is Chair of the Expert Group on Vocational Education and Training and Adult Education of the OECD and member of the board of the Centre for Educational Research and Innovation (CERI) of the OECD in Paris. He has published numerous books, more than 50 peer-reviewed scientific publications, in journals such as the *American Economic Review*, the *Journal of Public Economics* or the *Industrial and Labour Relations Review*.⁶ Most relevant for this project are his several large-scale surveys for the measurement of costs and benefits in dual vocational education in Switzerland, and his comparative studies with Austria and Germany, as well as a recent simulation studies for Italy, Spain and the UK.

⁶ See <http://www.skbf-csre.ch/en/about-us/team/stefan-wolter/> for a full list of publications.

Imprint

Editor

KOF Swiss Economic Institute, ETH Zurich

© 2018 KOF Swiss Economic Institute, ETH Zurich

Authors

Prof. Dr. Ursula Renold, Dr. Thomas Bolli, Prof. Dr. Stefan Wolter

KOF

ETH Zurich

KOF Swiss Economic Institute

LEE G 116

Leonhardstrasse 21

8092 Zurich, Switzerland

Phone +41 44 632 42 39

Fax +41 44 632 12 18