

Kholodilin, Konstantin Arkadieвич

Working Paper

Using the Dynamic Bi-Factor Model with Markov Switching to Predict the Cyclical Turns in the Large European Economies

DIW Discussion Papers, No. 554

Provided in Cooperation with:

German Institute for Economic Research (DIW Berlin)

Suggested Citation: Kholodilin, Konstantin Arkadieвич (2006) : Using the Dynamic Bi-Factor Model with Markov Switching to Predict the Cyclical Turns in the Large European Economies, DIW Discussion Papers, No. 554, Deutsches Institut für Wirtschaftsforschung (DIW), Berlin

This Version is available at:

<https://hdl.handle.net/10419/18447>

Standard-Nutzungsbedingungen:

Die Dokumente auf EconStor dürfen zu eigenen wissenschaftlichen Zwecken und zum Privatgebrauch gespeichert und kopiert werden.

Sie dürfen die Dokumente nicht für öffentliche oder kommerzielle Zwecke vervielfältigen, öffentlich ausstellen, öffentlich zugänglich machen, vertreiben oder anderweitig nutzen.

Sofern die Verfasser die Dokumente unter Open-Content-Lizenzen (insbesondere CC-Lizenzen) zur Verfügung gestellt haben sollten, gelten abweichend von diesen Nutzungsbedingungen die in der dort genannten Lizenz gewährten Nutzungsrechte.

Terms of use:

Documents in EconStor may be saved and copied for your personal and scholarly purposes.

You are not to copy documents for public or commercial purposes, to exhibit the documents publicly, to make them publicly available on the internet, or to distribute or otherwise use the documents in public.

If the documents have been made available under an Open Content Licence (especially Creative Commons Licences), you may exercise further usage rights as specified in the indicated licence.

Discussion Papers

554

Konstantin A. Kholodilin

**Using the Dynamic Bi-Factor Model with
Markov Switching to Predict the Cyclical Turns in
the Large European Economies**

Berlin, February 2006



DIW Berlin

German Institute
for Economic Research

Opinions expressed in this paper are those of the author and do not necessarily reflect views of the Institute.

IMPRESSUM
© DIW Berlin, 2006
DIW Berlin
German Institute for Economic Research
Königin-Luise-Str. 5
14195 Berlin
Tel. +49 (30) 897 89-0
Fax +49 (30) 897 89-200
www.diw.de

ISSN print edition 1433-0210
ISSN electronic edition 1619-4535

All rights reserved.
Reproduction and distribution
in any form, also in parts,
requires the express written
permission of DIW Berlin.

Using the Dynamic Bi-Factor Model with Markov Switching to Predict the Cyclical Turns in the Large European Economies

Konstantin A. Kholodilin*

January 31, 2006

Abstract

The appropriately selected leading indicators can substantially improve the forecasting of the peaks and troughs of the business cycle. Using the novel methodology of the dynamic bi-factor model with Markov switching and the data for three largest European economies (France, Germany, and UK) we construct composite leading indicator (CLI) and composite coincident indicator (CCI) as well as corresponding recession probabilities. We estimate also a rival model of the Markov-switching VAR in order to see, which of the two models brings better outcomes. The recession dates derived from these models are compared to three reference chronologies: those of OECD and ECRI (growth cycles) and those obtained with quarterly Bry-Boschan procedure (classical cycles). Dynamic bi-factor model and MSVAR appear to predict the cyclical turning points equally well without systematic superiority of one model over another.

Keywords: Forecasting turning points; composite coincident indicator; composite leading indicator; dynamic bi-factor model; Markov switching

JEL classification: E32; C10

*DIW Berlin, kkhodilin@diw.de

Contents

| | | |
|----------|-----------------------------|-----------|
| 1 | Introduction | 1 |
| 2 | Model | 2 |
| 3 | Data and Estimation | 7 |
| 4 | In-Sample Evaluation | 12 |
| 5 | Summary | 19 |
| | References | 20 |
| | Appendix | 23 |

List of Tables

| | | |
|----|--|----|
| 1 | Component series of the French CLI and CCI, monthly data 1992:1–2005:4 | 23 |
| 2 | Component series of the German CLI and CCI, monthly data 1991:1–2005:3 | 24 |
| 3 | Component series of the UK CLI and CCI, monthly data 1986:1–2005:3 | 25 |
| 4 | Estimates of the parameters of French single- and bi-factor linear and Markov-switching models, monthly data 1992:1–2005:4 | 26 |
| 5 | Estimates of the parameters of German single- and bi-factor linear and Markov-switching models, monthly data 1991:1–2005:3 | 27 |
| 6 | Estimates of the parameters of UK single- and bi-factor linear and Markov-switching models, monthly data 1986:1–2005:3 | 28 |
| 7 | Reference chronologies of the business cycle in France, Germany, and UK | 29 |
| 8 | The in-sample performance of alternative models with respect to the OECD’s and ECRI’s chronology (France, 1992:3–2005:4) | 30 |
| 9 | The in-sample performance of alternative models with respect to the OECD’s and ECRI’s chronology (Germany, 1991:3–2005:3) | 31 |
| 10 | The in-sample performance of alternative models with respect to the OECD’s and ECRI’s chronology (UK, 1986:3–2005:3) | 32 |

List of Figures

| | | |
|----|---|----|
| 1 | The British economic indicators classified using the cluster analysis | 33 |
| 2 | French GDP vs. alternative reference chronologies,1992:1-2005:4 | 34 |
| 3 | German GDP vs. alternative reference chronologies,1991:1-2005:3 | 35 |
| 4 | British GDP vs. alternative reference chronologies,1986:1-2005:3 | 36 |
| 5 | French CLI and CCI in levels,1992:1-2005:4 | 37 |
| 6 | Recession probabilities of the single- and bi-factor models for France vs. cyclical chronology of the OECD, 1992:1-2005:4 | 38 |
| 7 | Recession probabilities of the single- and bi-factor models for France vs. cyclical chronology of the ECRI (growth cycle), 1992:1-2005:4 | 39 |
| 8 | Recession probabilities of the single- and bi-factor models for France vs. cyclical chronology of the BBQ (classical cycle), 1992:1-2005:4 | 40 |
| 9 | German CLI and CCI in levels, 1991:1-2005:3 | 41 |
| 10 | Recession probabilities of the single- and bi-factor models for Germany vs. cyclical chronology of the OECD, 1991:1-2005:3 | 42 |
| 11 | Recession probabilities of the single- and bi-factor models for Germany vs. cyclical chronology of the ECRI (growth cycle), 1991:1-2005:3 | 43 |
| 12 | Recession probabilities of the single- and bi-factor models for Germany vs. cyclical chronology of the BBQ (classical cycle), 1991:1-2005:3 | 44 |
| 13 | British CLI and CCI in levels, 1986:1-2005:3 | 45 |
| 14 | Recession probabilities of the single- and bi-factor models for UK vs. cyclical chronology of the OECD, 1986:1-2005:3 | 46 |
| 15 | Recession probabilities of the single- and bi-factor models for UK vs. cyclical chronology of the ECRI (growth cycle), 1986:1-2005:3 | 47 |

| | | |
|----|--|----|
| 16 | Recession probabilities of the single- and bi-factor models for UK vs. cyclical chronology of the BBQ (classical cycle), 1986:1-2005:3 | 48 |
|----|--|----|

1 Introduction

The aim of this paper is to detect and forecast the turning points of the business cycles in the largest European economies during the last fifteen — twenty years. After the World War II the absolute declines in the output, which are a characteristic attribute of the classical cycle, had become rather a rare event. Instead, the business cycle researchers have concentrated on what is used to be called the growth cycles. The recessionary phases of the growth cycles are characterized by a deceleration of the growth rates and not necessarily by the decreases in the level of output. Therefore today the growth cycles are a much more common phenomenon than the classical cycles. The fact that the former are a typical feature of the contemporary economy and that swings of the business cycle affect the welfare of virtually all economic agents makes them an object of a vivid interest of the businessmen, policymakers, and even consumers. The prediction of troughs and peaks of the growth cycles, thus, is not only a purely academic exercise but is a matter of practical importance.

Now, what are the defining features of the business cycle? Burns and Mitchell (1946) defined business cycles as recurrent sequences of cumulative expansions and contractions diffused over a multitude of economic processes. Diebold and Rudebusch (1996) later translated these two key features into the modern economic language using the following terms: co-movements among many macroeconomic indicators and asymmetry between the cyclical phases. It is true that Burns and Mitchell (1946) were having in mind rather the classical cycle, since their work is based mainly on the data covering the first half on the 20th century, when the classical cycles were taking place. Nevertheless, the two above mentioned attributes are equally applicable to the growth cycle. We may also hope that by constructing a statistical model of the business cycle, which shares these features, one can achieve an improvement in its forecasting abilities.

Both features can be jointly analyzed within a single model thanks to the contributions of Stock and Watson (1991), who re-introduced the dynamic factor model in the econometric research, and Hamilton (1989), who proposed a model with Markov-switching dynamics. The resulting dynamic single-factor model with Markov switching was suggested by Kim (1994) and Kim and Yoo (1995) and implemented for the first time by Chauvet

(1998). It permits simultaneously capturing the co-movement and the cyclical asymmetry. This model has become already quite a standard tool of analyzing the business cycle. It has been successfully applied to the U.S. data by Chauvet (1998) and Kim and Nelson (1999), to the data of several European economies by Kaufmann (2000), to the Brazilian data by Chauvet (2002), to the Japanese data by Watanabe (2003), and to the Polish and Hungarian data by Bandholz (2005). The first such a model for Germany was estimated by Bandholz and Funke (2003), although with only two component series, which raises a question of its identifiability.

The first attempt, as far as we know, to build a dynamic bi-factor model with Markov switching, in which the CLI and CCI are estimated simultaneously, was undertaken in Kholodilin (2001) and Kholodilin and Yao (2005). Using this model the turning points can be measured and predicted simultaneously and in a more timely manner. Kholodilin (2001) and Kholodilin and Yao (2005) applied the model to the U.S. data, whereas this paper deals with the data of the three large European economies: France, Germany, and United Kingdom.

The paper is organized as follows. In section 2 a dynamic bi-factor model with Markov-switching is set up. Section 3 describes the data and the technique employed to select the appropriate component series of CLI and CCI as well as the results of estimation of the models presented in section 2. In section 4 the results of the in-sample prediction are evaluated. In the last section the conclusions are drawn.

2 Model

The dynamic factor model decomposes the dynamics of a group of observed time series into two unobserved sources of fluctuations: (1) the common factor or factors, which are common to all the component series or to the particular subgroups of them; (2) the specific, or idiosyncratic, factors — one per each observed series. In fact, the specific factors "explain" the remaining variation, which is left after the common factors were extracted.

The non-linear dynamic factor models, e.g. the model with Markov switch-

ing or with smooth transition autoregressive dynamics (see Kholodilin (2002)), in addition, take into account the possible asymmetries arising in the different states, or regimes. Here by the state we mean the phases of business cycle.

Moreover, the parametric dynamic factor models explicitly specify the dynamics of the latent (unobserved) factors. In the model examined in this paper both common and specific factors are modelled as autoregressive (AR) processes.

In the dynamic bi-factor model the set of the n observed variables is split in two disjoint subsets: n_{CLI} leading and n_{CCI} coincident indicators ($n = n_{CLI} + n_{CCI}$). The common dynamics of the time series belonging to each group are explained by a single common factor: CLI for the first group and CCI for the second group.

Thus, the complete dynamic bi-factor model with Markov switching can be written as a system of the three equations, where the first equation decomposes the observed dynamics into a sum of common and idiosyncratic factors and the last two equations specify the "law of motion" of the latent common and specific factors.

The decomposition of the observed dynamics:

$$\begin{aligned}\Delta y_t^{CLI} &= \Gamma_{CLI} \Delta f_t^{CLI} + \Delta u_t^{CLI} \\ \Delta y_t^{CCI} &= \Gamma_{CCI} \Delta f_t^{CCI} + \Delta u_t^{CCI}\end{aligned}\quad (1)$$

The dynamics of common factors:

$$\begin{aligned}\begin{pmatrix} \Delta f_t^{CLI} \\ \Delta f_t^{CCI} \end{pmatrix} &= \begin{pmatrix} \mu^{CLI}(s_t^{CLI}) \\ \mu^{CCI}(s_t^{CCI}) \end{pmatrix} + \begin{pmatrix} \phi_{1.11} & \phi_{1.12} \\ \phi_{1.21} & \phi_{1.22} \end{pmatrix} \begin{pmatrix} \Delta f_{t-1}^{CLI} \\ \Delta f_{t-1}^{CCI} \end{pmatrix} + \\ &\dots + \begin{pmatrix} \phi_{l.11} & \phi_{l.12} \\ \phi_{l.21} & \phi_{l.22} \end{pmatrix} \begin{pmatrix} \Delta f_{t-l}^{CLI} \\ \Delta f_{t-l}^{CCI} \end{pmatrix} + \begin{pmatrix} \varepsilon_t^{CLI} \\ \varepsilon_t^{CCI} \end{pmatrix}\end{aligned}\quad (2)$$

The dynamics of idiosyncratic factors:

$$\begin{aligned}
\begin{pmatrix} \Delta u_t^{CLI} \\ \Delta u_t^{CCI} \end{pmatrix} &= \begin{pmatrix} \Psi_1^{CLI} & O_{n_{CLI} \times n_{CCI}} \\ O_{n_{CCI} \times n_{CLI}} & \Psi_1^{CCI} \end{pmatrix} \begin{pmatrix} \Delta u_{t-1}^{CLI} \\ \Delta u_{t-1}^{CCI} \end{pmatrix} + \\
\cdots + \begin{pmatrix} \Psi_m^{CLI} & O_{n_{CLI} \times n_{CCI}} \\ O_{n_{CCI} \times n_{CLI}} & \Psi_m^{CCI} \end{pmatrix} \begin{pmatrix} \Delta u_{t-l}^{CLI} \\ \Delta u_{t-l}^{CCI} \end{pmatrix} + \begin{pmatrix} \eta_t^{CLI} \\ \eta_t^{CCI} \end{pmatrix} & \quad (3)
\end{aligned}$$

where Δy_t^{CLI} and Δy_t^{CCI} are the $n_{CLI} \times 1$ and $n_{CCI} \times 1$ vectors of the first differences of logarithms of the observed leading and coincident variables in the first differences; Δf_t^{CLI} and Δf_t^{CCI} are the latent common factors in the first differences; Δu_t^{CLI} and Δu_t^{CCI} are the $n_{CLI} \times 1$ and $n_{CCI} \times 1$ vectors of the growth rates of latent specific factors; ε_t^{CLI} and ε_t^{CCI} are the disturbances of the common factors, whereas η_t^{CLI} and η_t^{CCI} are the $n_{CLI} \times 1$ and $n_{CCI} \times 1$ vectors of disturbances of the specific factors. Γ_{CLI} and Γ_{CCI} are the $n_{CLI} \times 1$ and $n_{CCI} \times 1$ vectors of factor loadings linking the observed series to the common factors. $\mu^{CLI}(s_t^{CLI})$ and $\mu^{CCI}(s_t^{CCI})$ are the state-dependent intercepts of CLI and CCI. ϕ_i are the autoregressive coefficients of common factors; and Ψ_i^{CLI} and Ψ_i^{CCI} are the matrices of the autoregressive coefficients of the idiosyncratic factors. O_n and $O_{n \times m}$ are $n \times 1$ vector and $n \times m$ matrix of zeros, correspondingly. Finally, s_t^{CLI} and s_t^{CCI} are the unobserved state variables following a first-order Markov chain process, which is summarized by the transition probabilities matrix, whose characteristic element is $p_{ij} = \text{prob}(s_t = j | s_{t-1} = i)$, that is, the probability of being today in regime j given that yesterday's regime was i .

In the two-regime (expansion-recession, or high-low growth rate) case a state variable s_t is binary. Depending on the regime, the common factor's intercept assumes different values: low in contractions and high in expansions. Thus, the common factors grow faster during the upswings and slower (or even decline) during the downswings of the economy.

The dynamic bi-factor model with Markov switching described above is based on the following **assumptions**:

- *The common factors' disturbances, $\varepsilon_t = (\varepsilon_t^{CLI} | \varepsilon_t^{CCI})'$, and the specific factors' disturbances, $\eta_t = (\eta_t^{CLI} | \eta_t^{CCI})'$, are mutually and serially uncorrelated:*

$$\begin{pmatrix} \varepsilon_t \\ \eta_t \end{pmatrix} \sim NID \left(\begin{pmatrix} 0 \\ 0 \end{pmatrix}, \begin{pmatrix} \Sigma(s_t) & O_{2 \times n} \\ O_{n \times 2} & \Omega \end{pmatrix} \right) \quad (4)$$

where $\Sigma(s_t)$ is the diagonal 2×2 variance-covariance matrix of common factors, with the common factor residual variances on the main diagonal, $\sigma_{CLI}^2(s_t)$ and $\sigma_{CCI}^2(s_t)$, which may be state dependent; Ω is the diagonal $n \times n$ variance-covariance matrix of the idiosyncratic disturbances.

- *There is no Granger causality between the common factors:* $\phi_{i.12} = \phi_{i.21} = 0 \forall i \in [1, l]$. This restriction together with the previous assumption imply that the only way the CLI is linked to the CCI is through the intercept, when the state variables of both common factors are interdependent. There can also exist a relationship between the volatilities of two common factors when their residual variances are state dependent and their state variables are related. In principle, this assumption can be relaxed without changing much the outcomes of the model. Here it is used only for the sake of parsimony.
- This assumption specifies the *state variable dynamics*. In fact, we can consider three cases:
 - (a) there is a single state variable, s_t , such that $s_t^{CLI} = s_t^{CCI}$, in other words, the non-linear dynamics of the common factors are identical;
 - (b) s_t^{CLI} and s_t^{CCI} are completely independent;
 - (c) s_t^{CLI} and s_t^{CCI} are neither identical as in (a) nor independent as in (b) but interdependent.

Now let us consider in more detail the specification of the Markov switching in the non-linear dynamic bi-factor model under inspection. In the case (a) above there is only one state variable and it all boils down to the standard two-regime Markov switching model as in Hamilton (1989). The transition probabilities matrix then looks like:

$$\pi = \begin{pmatrix} p_{11} & 1 - p_{11} \\ 1 - p_{22} & p_{22} \end{pmatrix} \quad (5)$$

In the cases (b) and (c) there are two state variables: one per each common factor. This means that each composite indicator has its own recessions and expansions. Therefore to describe the whole process, a compound state variable, comprising both s_t^{CLI} and s_t^{CCI} , should be constructed as it is done in Phillips (1991). This compound variable will have four different states:

| Composite state variable | $s_t = 1$ | $s_t = 2$ | $s_t = 3$ | $s_t = 4$ |
|---------------------------|----------------------|----------------------|----------------------|----------------------|
| Leading state variable | $s_t^{CLI} = 1$ ↑ | $s_t^{CLI} = 2$ ↓ | $s_t^{CLI} = 1$ ↑ | $s_t^{CLI} = 2$ ↓ |
| Coincident state variable | $s_t^{CCI} = 1$ ↑ | $s_t^{CCI} = 1$ ↑ | $s_t^{CCI} = 2$ ↓ | $s_t^{CCI} = 2$ ↓ |

where the arrows show whether the economy goes up (expansion) or down (recession).

The dimension of the transition probabilities matrix is then 4×4 and its structure depends on which of the cases is assumed: (b) or (c). In the case (b), when both state variables are independent, the transition probabilities matrix of the compound state variable is a Kronecker product of the transition probabilities matrices of the individual state variables: $\pi = \pi^{CLI} \otimes \pi^{CCI}$. This is equivalent to:

$$\pi = \begin{pmatrix} p_{11}^{CLI} p_{11}^{CCI} & p_{11}^{CLI} (1 - p_{11}^{CCI}) & (1 - p_{11}^{CLI}) p_{11}^{CCI} & (1 - p_{11}^{CLI}) (1 - p_{11}^{CCI}) \\ p_{11}^{CLI} (1 - p_{22}^{CCI}) & p_{11}^{CLI} p_{22}^{CCI} & (1 - p_{11}^{CLI}) (1 - p_{22}^{CCI}) & (1 - p_{11}^{CLI}) p_{22}^{CCI} \\ (1 - p_{22}^{CLI}) p_{11}^{CCI} & (1 - p_{22}^{CLI}) (1 - p_{11}^{CCI}) & p_{22}^{CLI} p_{11}^{CCI} & p_{22}^{CLI} (1 - p_{11}^{CCI}) \\ (1 - p_{22}^{CLI}) (1 - p_{22}^{CCI}) & (1 - p_{22}^{CLI}) p_{22}^{CCI} & p_{22}^{CLI} (1 - p_{22}^{CCI}) & p_{22}^{CLI} p_{22}^{CCI} \end{pmatrix} \quad (6)$$

Under the hypothesis (c) the two individual state variables are assumed to be interrelated in the sense that the CLI is supposed to enter the recessions (expansions) several periods earlier than the CCI. This is a kind of intermediate case between completely independent and identical state variables corresponding to CLI and CCI.

As Phillips (1991) remarks, the model with an integer lag exceeding one period would require a Markov process with the order higher than 1. However, the real-valued (positive) lag can be modelled with a first-order Markov process by constructing the following transition probabilities matrix:

$$\pi = \begin{pmatrix} p_{11} & 1 - p_{11} & 0 & 0 \\ 0 & 1 - \frac{1}{\mathcal{A}} & 0 & \frac{1}{\mathcal{A}} \\ \frac{1}{\mathcal{B}} & 0 & 1 - \frac{1}{\mathcal{B}} & 0 \\ 0 & 0 & 1 - p_{22} & p_{22} \end{pmatrix} \quad (7)$$

where \mathcal{A} and \mathcal{B} are the expected leads in the recession and expansion, correspondingly. For example, the expected lead of CLI with respect to CCI

when entering the low-growth regime ($s_t = 2$) is obtained as:

$$\begin{aligned}
\mathcal{A} &= p(s_t = 4|s_{t-1} = 2) + 2p(s_t = 4|s_{t-1} = 2)p(s_t = 2|s_{t-1} = 2) + 3p(s_t = 4|s_{t-1} = 2)p(s_t = 2|s_{t-1} = 2)^2 + \dots \\
\mathcal{A} &= (1 - p(s_t = 2|s_{t-1} = 2)) + 2(1 - p(s_t = 2|s_{t-1} = 2))p(s_t = 2|s_{t-1} = 2) + 3(1 - p(s_t = 2|s_{t-1} = 2))p(s_t = 2|s_{t-1} = 2)^2 + \dots \\
\mathcal{A} &= (1 - p(s_t = 2|s_{t-1} = 2)) \sum_{k=0}^{\infty} k p(s_t = 2|s_{t-1} = 2)^{k-1} \\
\mathcal{A} &= (1 - p(s_t = 2|s_{t-1} = 2)) \frac{1}{1 - p(s_t = 2|s_{t-1} = 2)^2} \\
\mathcal{A} &= \frac{1}{1 - p(s_t = 2|s_{t-1} = 2)}
\end{aligned} \tag{8}$$

We are going to examine three models corresponding to the three above stated cases. By comparing these models one can test the underlying hypotheses. Model (c) is an unrestricted version of model (a). Thus, by imposing restrictions on the parameters \mathcal{A} and \mathcal{B} one can test the hypothesis of identical versus interdependent with lead non-linear cyclical dynamics, for example, using the Likelihood-ratio test. The null of identical state variable implies that $\mathcal{A} = \mathcal{B} = 1$. The formal testing of (a) versus (b) or (c) versus (b) is a more complicated enterprise. Under the null of identical or interdependent state variable the second state variable is not identified. It means that we are confronting the famous nuisance parameter problem similar, for instance, to testing the hypothesis of two regimes versus three regimes.

In order to estimate the above dynamic factor models with Markov switching, the linear part of the model is cast into the state-space form using the Kalman filter, whereas the Markov-switching part of the model is expressed using the Hamilton filter. The estimations are carried out with the maximum likelihood method.

3 Data and Estimation

The component series of both CLI and CCI for the three large European economies were taken from the various official publicly available sources like the data bases of central banks and statistical offices. The selection of the component series was based entirely on the empirical criteria. No economic theory has guided our choice. The following selection procedure was employed.

The first step was to determine the leading and coincident time series. The leading series are those with peaks and troughs occurring earlier than

the peaks and troughs of some reference series. Therefore their cross-correlation with the reference series is highest when they are shifted backwards. The coincident series have peaks and troughs coinciding with those of the reference series. Hence their cross-correlation with the reference series achieves its maximum at zero lag. As reference coincident series the index of industrial production was used. In many studies it is treated as a monthly proxy for the GDP, despite the fact that in the modern economy it accounts for less than a half of the whole output.

The second step has to do with the requirement that the components of a composite indicator should be high enough but not too much correlated among themselves. It is important to avoid collinearity of the components. Therefore a kind of cluster analysis is needed to identify the groups of indicators with common dynamics.

The technique applied here is alike to the tree clustering, or joining¹. As a distance measure the absolute value of contemporaneous cross-correlation is used. Shortly the algorithm runs as follows. For the whole data set a cross-correlation matrix is computed. Then a pair of variables having the highest absolute value of correlation is searched and united in a single group. Graphically it means that they are drawn as two subbranches of one branch. From these two variables a new variable is constructed as a simple mean. All the variables are initially standardized and hence have equal unit variances. The new variable replaces the old ones in the data set. For this new data set the correlation matrix is again estimated. The cycle repeats until all there remains only one variable in the data set, that is, the average of all the time series.

An example of such a tree can be seen on Figure 1. Three major groups of indicators are easily distinguishable there. The first group includes the financial indicators (stock exchange index FTSE100, interest rates AJRP, AJLX and Spread, currency exchange rates AUSS and THAP) as well as the real economy indicators (industrial production CKYW, number of property transactions FTAQ, and total passenger car production FFAO). The second group includes mostly the business survey indicators (various European commission economic sentiment indicators BS-CONS, BS-INDU,

¹For more details on cluster analysis see Everitt et al. (2001).

BS-UK-ESI, and so on, CBI industrial trends survey ETCU and ETDQ, retail sales index EAPS, and average earnings index LNMQ). The third group consist of a mix of money market indicators (money stock M4 AUYN) and labor market indicators (employment in manufacturing YEJA, total unemployment rate MGSX) and two other series.

Combining both the leading-coincident analysis and clustering we have identified the components of the CLI and CCI. The former are mainly the business survey indicators, whereas the latter are the real sector indicators like industrial production and retail trade. The complete list of component series for the UK see in Table 3.

The component series employed in this study are listed and shortly described in Tables 1 through 3 of Appendix.

All the series are tested for unit roots using the augmented Dickey-Fuller test. Each series is tested for random walk with drift and deterministic trend, random walk with drift, and random walk only. It turns out that all the series have unit root. All the series are also tested for cointegration. The cointegration between the leading as well as between the coincident series was detected. As in Stock and Watson (1991) and Kim and Nelson (1999), the first differences of the logarithms of the original time series are taken and then demeaned and standardized.

For each country we estimated two separate dynamic single-factor models for CLI and CCI (with linear and Markov-switching dynamics) corresponding to the hypotheses (b) and a dynamic bi-factor model with Markov-switching corresponding to the hypothesis (c) presented in the previous section. Recall that these hypotheses are defined by the following equations:

- (a) Hypothesis of identical Markov-switching dynamics of CLI and CCI — equations (1) – (4) and (5). The model, in which CLI and CCI enter the recessions and expansions simultaneously, without any leads.
- (b) Hypothesis of independent Markov-switching dynamics of CLI and CCI — equations (1) – (4) and (6). This model can be alternatively estimated as two separate dynamic single-factor models with two-regime switching based on coincident and leading indicators corre-

spondingly. Each of the separate dynamic single-factor models is identical to that of Chauvet (1998) and Kim and Nelson (1998).

- (c) Hypothesis of interdependent Markov-switching dynamics of CLI and CCI — equations (1) – (4) and (7). A dynamic bi-factor model with interdependent cyclical dynamics that results in four-regime switching: two regimes for the leading indicator and two regimes for the coincident indicator. The composite leading factor (or CLI) switches between its regimes earlier than the composite coincident indicator (or CCI).

We determined the lag structure by balancing two requirements: on the one hand, our composite indicators should have some dynamics, that is, the lag order must be higher than zero; on the other hand, due to the short sample the lag order cannot be too high. Therefore both the common and idiosyncratic factors are specified as AR(1). For the identification purposes, the first loading factor in all the models is normalized to 1.

The parameter estimates and their standard errors corresponding to single-factor models of CLI and CCI and to bi-factor models are reported in Tables 4 through 6. Both MS models of composite leading and coincident indicators clearly distinguish between two regimes of positive and negative growth rates.

The estimates of the non-switching parameters of the linear and Markov-switching models do not differ very much.

In the French and German case ΔCLI has a high positive autoregressive coefficient varying for different models in the interval between 0.693 and 0.823 for France and between 0.462 and 0.752 for Germany, whereas ΔCCI has a negative, not always significant autoregressive coefficient varying between -0.467 and -0.358 for France and between -0.228 and -0.131 for Germany. Correspondingly, as one can see on Figures 5 and 9, which compare the levels² of the French and German composite indicators estimated from the single- and bi-factor models, the CLI's profile is much smoother than that of CCI. In the case of UK autoregressive coefficients of

²The levels of CLI and CCI are constructed as cumulated sums of their estimated first differences. For example, $CLI_t = CLI_{t-1} + \Delta CLI_t$.

both ΔCLI and ΔCCI are not significantly different from zero suggesting that the common factors are not persistent. Hence, as can be seen on Figure 13, the profiles of British CLI and CCI are not so smooth.

Factor loadings are positive and in most cases significant. The values of the factor loadings are as a rule close to one and their dispersion is not very high which is an indirect indicator of the approximately equal weights of the components. Therefore no single component is overinfluencing any composite indicator.

Under the bi-factor model with Markov switching the expected lead times of CLI over CCI in recessions and expansions, A and B , can be computed. For France the expected lead in recessions is about 4 months and expected lead in expansions is 1 month, for Germany both these leads are roughly equal to 3 months, whereas for the UK the lead in recessions is approximately 1 month and lead in expansions is roughly 3 months.

For the French CLI estimated as a single-factor model with Markov switching the transition probability of being today in expansion given that yesterday was expansion, $p_{11} = 0.879$, is slightly lower than the transition probability of being today in recession given that yesterday was recession, $p_{22} = 1 - p_{12} = 0.898$, implying that the expected duration of expansions is approximately equal to 8 months and is lower than the expected duration of recessions, which is about 10 months. For Germany the expected durations of expansions and recessions of CLI are 12 and 4 months and for the UK these are 10 and 5 months respectively. The expected duration of the recessions of German and British CLIs are thus a bit too short. The estimates of the dynamic single-factor model with Markov switching for CCI (see Tables 4–6) imply that the expected duration of the expansions of French CCI is about 31 months and that of recessions is 15 months. The expected duration of the expansions and recessions of German CCI are 53 months and 8 months correspondingly, whereas the expected durations of expansions and recessions of the British CCI are 59 and 20 months respectively. Finally, according to the dynamic bi-factor model with Markov switching that corresponds to the hypothesis (c), the expected durations of expansions and recessions for France are 11 months both; the expected duration of expansions of German cycle is 17 months and the expected duration of recessions is about 4 months, while the expected durations of

expansions and recessions for the UK are 13 and 10 months respectively.

We can also test which of the two hypotheses, (a) or (c), fits the data best. For these two models the comparison the likelihood ratio test can be accomplished. The critical value of the test statistic with two degrees of freedom and significance level of 1% is equal to $LR_{0.01}(2) = 9.21$, at 5% it is $LR_{0.05}(2) = 5.99$, and at 10% it is $LR_{0.10}(2) = 4.61$. For France the test statistic is $LR = 2 \times (LR_c - LR_a) = 2 \times (-1592.6 + 1594.6) = 4$, for Germany it is $LR = 2 \times (-1592.6 + 1594.6) = 37.4$, and for UK it is $LR = 2 \times (-1817.7 + 1820.2) = 5$. Therefore the null hypothesis of equal goodness of fit of models (a) and (c) is rejected for Germany and UK and accepted for France, implying that in case of Germany and UK the model with identical Markov-switching dynamics fits data worse than the model with the CLI leading the CCI.

4 In-Sample Evaluation

Unlike for the USA, we do not have any generally accepted business cycle chronology for France, Germany, and UK. Among the few available alternative chronologies we chose two, to which the recession probabilities of our non-linear models will be compared, namely the reference cycle dates determined and published by the Organization for Economic Cooperation and Development (OECD) and by the Economic Cycle Research Institute (ECRI). The OECD's and ECRI's chronologies for the three countries are reported in Table 7.

The third chronology we use here is based on the quarterly version of the Bry-Boschan dating technique, which was suggested in Harding and Pagan (2002). This chronology is obtained for the quarterly GDP data and is represented in the last two columns of Table 7. For the analysis of the forecasting accuracy the quarterly dating is transformed into the monthly one: if in the quarterly chronology a quarter is recessionary (expansionary) then in the monthly chronology all the months belonging to this quarter are treated as recessionary (expansionary).

All these chronologies are plotted against the levels and year-on-year rates of the real GDP in Figures 2–4. The BBQ chronology is supposed to reflect

the classical business cycle and hence it is compared to the level of the GDP. The other two chronologies are more likely to describe the growth cycle and therefore they are superimposed on the annual growth rates, or fourth-order differences of logs of the GDP.

Over the last 15 years the OECD detects five recessions for France, four recessions for Germany, and three recessions for the UK. At the same time ECRI finds three recessions for France, four recessions for Germany, and four recessions for the UK.

The profiles of the French, German, and British CLI and CCI estimated from the dynamic single- and bi-factor models with and without Markov switching are plotted in Figures 5–13. The upper panels show the profiles of the composite indicators estimated with linear models, whereas the bottom panels depict the profiles of the CLI and CCI obtained with dynamic bi-factor models with Markov switching. It can be seen that the CLI has often the peaks and troughs that precede those of the CCI. This is especially true for Germany — see Figure 9.

The filtered and smoothed conditional probabilities of recessions corresponding to the Markov-switching dynamic factor models examined here are plotted in Figures 6–8 for France, Figures 10–12 for Germany, and Figures 14–16 for the United Kingdom. The top panels show the conditional recession probabilities for the dynamic single-factor models, whereas the conditional recession probabilities derived from the dynamic bi-factor model are shown on the bottom panel of each figure. The bold continuous lines correspond to the low-state probabilities of CLI, while the dashed lines to those of CCI. The shaded areas represent the recessionary phases of the corresponding reference chronology. In the bi-factor models with interdependent Markov-switching dynamics (two state variables), there are four regimes: two for the CLI and two for the CCI. The recession probabilities of the CLI are computed as the sum of the conditional probabilities of regimes 2 and 4 (“low leading factor and high coincident factor” and “low leading factor and low coincident factor”), while CCI’s recession probabilities are the sum of the probabilities of regimes 3 and 4. The recession probabilities stemming from the two models — (b) and (c) — are very different.

Under the hypothesis of the independent cycles of CLI and CCI (model (b)), the conditional recession probabilities of CLI are quite volatile even after smoothing — see the upper panels of Figures 6–14. For France — Figure 6 — the CLI’s recession probabilities signal six recessions (two of them in 2001–2002 are so close to each other that can be merged into a single recession). All of them fall into the shaded regions, the second, third, and fourth model-derived recessions significantly lead the OECD’s recessions. French CCI has only two recessions: one in the beginning of sample and another, longer one, in the end of it. They seem to start and end in accordance with the chronology of the OECD. For Germany — Figure 10 — five model-derived recessions of CLI can be observed. All of them belong to the shaded areas of the OECD’s dating. The CCI’s conditional recession probabilities give only two signals of downswings: in 1992 and in 2001. The second signal is rather weak being lower than 0.5. For UK — Figure 14 — the dynamic single-factor model of CLI detects two recessions coinciding with the first two recessions of OECD and three rather short-lived recessions in the end of the sample that fall into the shaded area. The model of British CCI allows detecting only two recessions: one long in the beginning and another shorter in the end of the sample. Both lag behind the model-derived recessions of CLI.

The picture changes substantially when model (c) is considered. The corresponding conditional recession probabilities can be seen on the bottom panels of Figures 6–14. In the case of France the probabilities of the low state of CLI became smoother, whereas those of CCI have undergone significant changes: there are six model-derived recession of CCI now that begin and finish later than the recession probabilities of CLI. One can see that the delay is longer at the beginning of recessions and shorter at the beginning of expansions, which perfectly accords with the values of the parameters A and B reported in Table 4 and discussed above. In the case of Germany the conditional recession probabilities of CLI underwent rather minor change. By contrast, the recession probabilities of CCI started resembling those of CLI with a clearly visible lag. Now both CLI and CCI signal five recessions. In the case of UK both the recession probabilities of CLI and CCI have been modified. The former now have eight peaks exceeding 0.5 margin but only six of them remain above 0.5 for a long enough time. The conditional recession probabilities of CCI under model (c) resemble those of CLI with a little lag, which is bigger when the shifts

from low- to high-state take place.

When the predicted reference chronology is known, the above comparison of the in-sample forecasting performance can be formalized using some criterion that measures the difference between the reference chronology and the model-derived dating. For this purpose we use the Quadratic Probability Score (QPS) proposed in Brier (1950), which is based on probabilities derived from each model. Let \mathcal{P}_t be the conditional probability that the economy is in recession, estimated from the model; let \mathcal{R}_t be a binary reference chronology (1 if recession, 0 otherwise), and the slightly modified version of QPS is given by:

$$QPS = \frac{1}{T - |\tau|} \sum_{t=0.5(|\tau|+\tau)+1}^{T-0.5(|\tau|-\tau)} (\mathcal{P}_{t-\tau} - \mathcal{R}_t)^2 \quad (9)$$

where τ is the integer denoting the time shift that accounts for the possibly leading ($\tau > 0$), coincident ($\tau = 0$) or lagging ($\tau < 0$) character of the recession probabilities and \mathcal{P}_t . QPS varies between 0 and 1, with a score of 0 corresponding to perfect accuracy. This is the unique proper scoring rule that is only a function of the discrepancy between realizations and model-derived probabilities (see Diebold and Rudebusch (1989) for further discussion).

The in-sample predicting performance of the non-linear models estimated in this paper is compared to that of the Markov-Switching Vector Autoregressions (MSVAR) with two regimes estimated using the Ox package of H.-M.Krolzig³ and is reported in Tables 8–10. The MSVARs include the component series of the dynamic bi-factor models: the "CLI" means that the components of CLI are employed, "CCI" — the components of CCI, and "All" — that both the components of CLI and CCI are used. Five types of the MSVAR model are considered: Markov switching with state-dependent intercept (MSI), Markov switching with state-dependent intercept and variance (MSIH), Markov switching with state-dependent mean (MSM), Markov switching with state-dependent intercept and autoregressive parameters (MSIA), and Markov switching with state-dependent intercept, variance, and autoregressive parameters (MSIAH).

³More details on the types of MSVAR models see in Krolzig (1997).

The in-sample performance is measured by the QPS computed with respect to the three alternative reference chronologies mentioned above. The in-sample performance is evaluated at different non-negative lags τ (see equation (9)) in order to account for the fact that the model-derived dating may lead the reference chronologies. Thus, in Tables 8–10 the minimum QPS for each model is reported along with the lag, at which its minimum is attained.

In order to test whether the QPS of each two models differ significantly or not, we propose a bootstrap test. It is motivated as follows. We need to compare the forecasting accuracy of any two models, i and j , over the comparable period:

$$QPS_i - QPS_j = \frac{1}{T - |\tau^*|} \sum_{t=0.5(|\tau^*|+\tau^*)+1}^{T-0.5(|\tau^*|-\tau^*)} [(P_{i,t-\tau_i} - \mathcal{R}_t)^2 - (P_{j,t-\tau_j} - \mathcal{R}_t)^2] \quad (10)$$

where

$$\tau^* = \begin{cases} \max\{\tau_i, \tau_j\}, & \text{if } \tau_i > 0, \tau_j > 0 \\ \min\{\tau_i, \tau_j\}, & \text{if } \tau_i < 0, \tau_j < 0 \\ |\tau_i| + |\tau_j|, & \text{if } \tau_i \times \tau_j < 0 \end{cases} \quad (11)$$

Then, letting

$$D_t = (P_{i,t-\tau_i} - \mathcal{R}_t)^2 - (P_{j,t-\tau_j} - \mathcal{R}_t)^2, \quad (12)$$

we can represent it as an autoregressive process:

$$D_t = \alpha_0 + \sum_{q=1}^Q \alpha_q D_{t-q} + u_t \quad (13)$$

where Q is the order of autoregression, which can be determined using some information criterion, and u_t are the serially uncorrelated disturbances.

Hence testing the null hypothesis of statistically equal forecasting accuracy of model i and model j , that is, $QPS_i = QPS_j$, is equivalent to testing the null of $\alpha_0 = 0$. However, we do not know the distribution of D_t and cannot be sure that the standard Student distribution is applicable. Therefore we obtain the distribution through the bootstrap. This is done as follows:

- (1) Estimate equation (13) and save the estimated parameters, $\hat{\alpha}' = \{\hat{\alpha}_0, \dots, \hat{\alpha}_Q\}$, and the vector of errors, $\hat{u}' = \{\hat{u}_{0.5(|\tau^*|+\tau^*)+1}, \dots, \hat{u}_{T-0.5(|\tau^*|-\tau^*)}\}$.
- (2) Generate a bootstrap sample of size $T - |\tau^*|$ using the vector of estimated parameters $\hat{\alpha}$ and the pseudo-disturbances drawn with replacement from the vector of errors \hat{u} :

$$\tilde{D}_t^r = \hat{\alpha}_0 + \sum_{q=1}^Q \hat{\alpha}_q \tilde{D}_{t-q}^r + \tilde{u}_t^r \quad (14)$$

where r denotes the r -th bootstrap replication.

- (3) Compute the estimates of α from the sample and save $\tilde{\alpha}_0^r$.
- (4) Repeat steps (2)–(3) R times (R should be sufficiently large that its further increases have no important effect on results) and find the bootstrap p -values as: if $\frac{1}{R} \sum_{r=1}^R \tilde{\alpha}_0^r > 0$, then compute the proportion of $\tilde{\alpha}_0^r$ that are lower than 0; otherwise compute the proportion of $\tilde{\alpha}_0^r$ that are greater than 0. If the proportion is higher than some chosen significance level, say 0.05, then the null of no difference between two QPSs is accepted, otherwise it is rejected.

We do not reproduce the p -values here because the corresponding tables would occupy too much space. However, we will heavily rely on them when discussing the results below. The number of bootstrap replications was $R = 2000$.

On average, for all the countries the in-sample forecasting performance of most of the models is not very satisfactory, since QPS is relatively high. In addition, most datings derived from the models based either on the subset of the leading indicators or on the whole set of data conform much

better with the OECD's and ECRI's chronologies than with that of BBQ. By contrast, the models including the coincident component series only are better forecasting the BBQ chronology. Thus, it appears that the leading series better reflect the growth cycles, whereas the coincident variables are less volatile and hence are proxies for the classical cycle.

For France, as Table 8 shows, the OECD is best predicted by the following three models: bi-factor model (a), the CLI in the bi-factor model (c) and the CLI in the bi-factor model (b). Recall that the LR-test gave preference to the model (a) over the model (c). The lowest QPS are achieved at leads equal to 2–6 months. The MSVAR models, for which the null of no difference in the forecasting accuracy could not be rejected, are: the models MSI and MSM of the components of CLI, MSM-CCI and several models including all the component series. The same picture is for the chronology of the ECRI, although the lead time is very small, varying from 0 to 2 months. Once more the closest rivals, for which the null cannot be rejected, are MSI-CLI, MSM-CLI, MSIAH-CLI, MSM-CCI, MSIA-All and MSIAH-All. However, the MSVAR models attain the minimum of QPS at the negative lags, which means that they are lagging behind the ECRI's growth cycle, whereas our objective is to find the models that forecast well and are leading. The three models having the highest conformity with the BBQ-chronology, however, are different. These are: single-factor model of CCI, MSIH and MSM models for the components of CCI. The in-sample performance of the first two models is not statistically different, but both of them significantly outperform MSM-CCI and all the other models.

The models that best of all detect the turning points of the OECD's chronology for Germany are: MSI, MSM, and MSIAH including all the component series. The corresponding model-derived probabilities lead the OECD's cycle by 1–2 months. The best performance among the dynamic factor models has model (c). Despite the fact that the QPS of the latter are higher than those of the best MSVAR models, there is no statistically significant difference between their forecasting accuracy. The best conformity with German ECRI's dating is displayed by MSI model based on the components of CCI as well as by the MSM and MSIA models including the components of CLI. Only MSIA model is leading the reference chronology by 2–5 months, the other model-derived chronologies coincide with the reference one, save the filtered recession probabilities of MSM that are even

lagging behind the ECRI's growth cycle. Again, according to our empirical p -values the difference between these models and dynamic bi-factor model (c) is not significant. The three models that are best at in-sample prediction of the turns of German classical cycle are: bi-factor model (c), bi-factor model (b), and bi-factor model (a). These do not differ (at 5% significance level) in accuracy from the MSVAR models based on the components of CCI.

Finally, the OECD's chronology for UK is best predicted within the sample by the dynamic bi-factor model (c) with lead equal to 1–3 months, MSIA model for the components of CCI (lead time is 1 month), and MSIH model for the components of CLI (lead time is 8 months). The hypothesis of the equal forecasting accuracy of these models cannot be rejected at 5% significance level. The three models having the highest conformity with ECRI's growth cycle are: dynamic bi-factor model (c) with lag up to 5 months, MSIA-CLI model with lag of 1 month, and MSM-CLI model with lag of 1 month for the filtered probabilities and lead of 2 months for the smoothed ones. These three models have equal in-sample performance. The classical cycle represented by the BBQ chronology is best of all detected by the dynamic single-factor model of CCI (that is, dynamic bi-factor model (b)) with lag of 2 months for filtered probabilities and lag of 6 months for smoothed ones, MSM-CCI and MSI-CCI models with the same lags. These models have statistically equal forecasting performance but are significantly different from most other models, save those MSVAR models that are based on the components of CCI.

Given the uncertainty about the reference chronology, the out-of-sample forecasting exercise is hardly possible. Of course, we can make the forecasts with our models but their eventual performance will be affected both by the forecasting errors and by the fact that it is not sure whether the selected reference chronologies reflect well the turning points of the business cycle in the three European countries under inspection.

5 Summary

In this paper a dynamic factor model with Markov-switching and two common factors, one of which is leading and another coincident, is esti-

mated for the three large European economies: France, Germany, and UK. The separation of the data set into the group of leading and the group of coincident indicators and estimation of one common factor per each group allows more efficient use of the available information. The predictive content of CLI permits detecting the turns of CCI in advance. As a rule the leading indicators composing the CLI are more readily available and subject to less important revisions than the coincident indicators.

Three alternative hypotheses concerning the temporal relationship between the CLI and CCI were examined: (a) switches between the recessionary and expansionary phases of CLI and CCI are identical; (b) these switches happen independently; and (c) the switches of the CLI precede those of CCI with some positive lead. In the latter case one of the outputs of the model are the estimates of the expected lead time of CLI over CCI both at peaks and troughs. The largest expected lead equal to 4 months was found for France and the smallest expected lead of 1 month, which virtually means that both composite indicators enter the same cyclical phase simultaneously, for the UK.

The test of in-sample performance of models examined in the paper is conducted relative to the turning points of the three reference chronologies: those of OECD and ECRI that reflect the growth cycle concept and that of BBQ describing the classical cycle. The measure of conformity between the model-derived and reference cycles is the QPS. In addition, the performance of the MSVAR models is computed. It appears that the ranking is highly dependent on the reference chronology. For France it is our dynamic bi-factor models that capture the turns of the growth cycles the best. For Germany the some MSVAR models perform better, whereas for the UK the first positions in the performance ranking are shared both by bi-factor and certain MSVAR models.

References

- Bandholz, H. (2005). New composite leading indicators for Hungary and Poland. *Ifo Working Paper No. 3*.
- Bandholz, H. and M. Funke (2003). In search of leading indicators of eco-

- conomic activity in Germany. *Journal of Forecasting* 22, 277–297.
- Brier, G. (1950). Verification of forecasts expressed in terms of probability. *Monthly Weather Review* 78, 1–3.
- Burns, A. and W. Mitchell (1946). *Measuring Business Cycles*. New York.
- Chauvet, M. (1998). An econometric characterization of business cycle dynamics with factor structure and regime switching. *International Economic Review* 39, 969–996.
- Chauvet, M. (2002). The Brazilian business and growth cycles. *Revista Brasileira de Economia* 56(1).
- Diebold, F. X. and G. D. Rudebusch (1989). Scoring the leading indicators. *Journal of Business* 62, 369–402.
- Diebold, F. X. and G. D. Rudebusch (1996). Measuring business cycles: A modern perspective. *The Review of Economics and Statistics* 78, 67–77.
- Everitt, B. S., S. Landau, and M. Leese (2001). *Cluster Analysis*. Oxford University Press.
- Hamilton, J. D. (1989). A new approach to the economic analysis of nonstationary time series and the business cycle. *Econometrica* 57(2), 357–384.
- Harding, D. and A. Pagan (2002). Dissecting the cycle: A methodological investigation. *Journal of Monetary Economics* 49(2), 365–381.
- Kaufmann, S. (2000). Measuring business cycles with a dynamic Markov switching factor model: An assessment using Bayesian simulation methods. *Econometrics Journal* 3, 39–65.
- Kholodilin, K. A. (2001). Latent leading and coincident factors model with Markov-switching dynamics. *Economics Bulletin* 3(7), 1–13.
- Kholodilin, K. A. (2002). Two alternative approaches to modelling the non-linear dynamics of the composite economic indicator. *Economics Bulletin* 3(26), 1–18.
- Kholodilin, K. A. and V. W. Yao (2005). Measuring and predicting turning points using a dynamic bi-factor model. *International Journal of Forecasting* 21, 525–537.

- Kim, C.-J. (1994)). Dynamic linear models with Markov-switching. *Journal of Econometrics* 60, 1–22.
- Kim, C.-J. and C. R. Nelson (1998). Business cycle turning points, a new coincident index, and tests of duration dependence based on a dynamic factor model with regime switching. *The Review of Economics and Statistics* 80(2), 188–201.
- Kim, C.-J. and C. R. Nelson (1999). *State-Space Models with Regime Switching: Classical and Gibbs-Sampling Approaches with Applications*. Cambridge: MIT Press.
- Kim, M.-J. and J.-S. Yoo (1995). New index of coincident indicators: A multivariate Markov switching factor model approach. *Journal of Monetary Economics* 36, 607–630.
- Krolzig, H.-M. (1997). *Markov-Switching Vector Autoregressions. Modelling, Statistical Inference and Application to Business Cycle Analysis*. Berlin: Springer Verlag.
- Phillips, K. L. (1991). A two-country model of stochastic output with changes in regime. *Journal of International Economics* 31, 121–142.
- Stock, J. H. and M. W. Watson (1991). A probability model of the coincident economic indicators. In L. K. and M. G. (Eds.), *Leading Economic Indicators: New Approaches and Forecasting Records*. Cambridge University Press.
- Watanabe, T. (2003, February). Measuring business cycle turning points in Japan with a dynamic Markov switching factor model. *Monetary and Economic Studies* 21(1).

Appendix

Table 1: Component series of the French CLI and CCI, monthly data 1992:1–2005:4

| Code | Description |
|--------------------------------|---|
| Composite leading indicator | |
| EC-NivCC | Niveau du carnet de commandes |
| EC-StockPFPPrevu | Stocks de produits finis prévus pour les prochains mois |
| THE | THE — Taux de rendement des emprunts d'état LT FM |
| CAC40 | Bourse Paris CAC 40 (adj. close) |
| Composite coincident indicator | |
| IPI | Index de la production industrielle |
| ip-agric | Index de la production — Industries agricoles et alimentaires |
| export-ocde | Exportations FAB; Valeur brute; OCDE; euro |
| import-ocde | Importation CAF; Valeur brute; OCDE; euro |

Sources:

- (i) Banque de France (http://www.banque-france.fr/fr/stat_conjoncture/series/series.htm);
- (ii) INSEE (<http://www.indices.insee.fr/bsweb/servlet/bsweb>);
- (iii) Yahoo! Finance (<http://fr.finance.yahoo.com/q/hp?s=%5EFCHI>).

Table 2: Component series of the German CLI and CCI, monthly data 1991:1–2005:3

| Code | Description |
|--------------------------------|--|
| Composite leading indicator | |
| IFO | Das Ifo Geschäftsklima für die Gewerbliche Wirtschaft, Erwartungen (R3), 2000=100, SA) |
| SU0253 | Geldmarktsätze am Frankfurter Bankplatz, Dreimonatsgeld, Monatsdurchschnitt |
| WU3141 | DAX-Index, 1987 = 1000 |
| YU0516 | HWWA-Rohstoffpreisindex "Euroland" |
| Composite coincident indicator | |
| UXNI63 | Produktion Industrie |
| UXA001 | Auftragseingang in Verarbeitendes Gewerbe, Werte, arbeitstäglich bereinigt |
| UXHK87 | Einzelhandelsumsatz, Volumen, kalenderbereinigt |
| UUCC04 | Offene Stellen Insgesamt |
| EU2001 | Außenhandel, Warenhandel, Ausfuhr (fob) |

Source:

Deutsche Bundesbank (http://www.bundesbank.de/statistik/statistik_zeitreihen.php).

Table 3: Component series of the UK CLI and CCI, monthly data 1986:1–2005:3

| Code | Description |
|--------------------------------|--|
| Composite leading indicator | |
| ETCU | CBI Industrial Trends Survey: Bus Vol Of Output Expec: next 4 months |
| BS-RETA | European Commission Business Survey indicator for UK retail trade |
| BS-UK-ESI | European Commission Economic Sentiment Indicator for UK economy |
| Composite coincident indicator | |
| CKYW | Industrial production index: CVMSA NAYear=100; constant 2002 prices |
| FTAQ | Number of property transactions in England and Wales: 1000; SA |
| EAPS | Retail Sales Index: Volume SA; constant 2000 prices |

Sources:

- (i) National Statistics (<http://www.statistics.gov.uk/statbase/tsdintro.asp>);
- (ii) The Directorate General for Economic and Financial Affairs (DG ECFIN) of the European Commission (http://europa.eu.int/comm/economy_finance/indicators/business_consumer_surveys/bcsseries_en.htm).

Table 4: Estimates of the parameters of French single- and bi-factor linear and Markov-switching models, monthly data 1992:1–2005:4

| Parameter | Model (a) LL=-1594.6 | | Model (b): Composite Leading Indicator | | | | Model (c) LL=-1592.6 | | |
|----------------------|-------------------------|----------|---|-------------------|---------------|--------------|-------------------------|----------|-------|
| | Coeff | St.error | Parameter | Linear, LL=-868.4 | MS, LL=-866.9 | Parameter | Coeff | St.error | |
| p_{11} | 0.901 | 0.041 | p_{11} | — | 0.879 | 0.069 | p_{11} | 0.908 | 0.043 |
| p_{12} | 0.094 | 0.044 | p_{12} | — | 0.102 | 0.057 | p_{22} | 0.912 | 0.042 |
| $\mu_{CLI,1}$ | 0.438 | 0.163 | $\mu_{CLI,1}$ | — | 0.241 | 0.072 | A | 3.740 | 2.870 |
| $\mu_{CLI,2}$ | -0.440 | 0.168 | $\mu_{CLI,2}$ | — | -0.215 | 0.072 | B | 1.310 | 1.470 |
| $\mu_{CCI,1}$ | 0.349 | 0.096 | $\gamma_{StPFPrevu}$ | 0.225 | 0.093 | 0.098 | $\mu_{CLI,1}$ | 0.252 | 0.083 |
| $\mu_{CCI,2}$ | -0.356 | 0.095 | γ_{THE} | 0.394 | 0.125 | 0.127 | $\mu_{CCI,2}$ | -0.212 | 0.068 |
| $\gamma_{StPFPrevu}$ | 0.215 | 0.095 | γ_{CAC40} | 0.226 | 0.132 | 0.141 | $\mu_{CCI,1}$ | 0.299 | 0.103 |
| γ_{THE} | 0.362 | 0.133 | ϕ_{CLI} | 0.823 | 0.071 | 0.115 | $\mu_{CCI,2}$ | -0.345 | 0.111 |
| γ_{CAC40} | 0.244 | 0.128 | ψ_{NivCC} | -0.201 | 0.105 | 0.102 | $\gamma_{StPFPrevu}$ | 0.181 | 0.097 |
| $\gamma_{IPI-Agr}$ | 0.488 | 0.111 | $\psi_{StPFPrevu}$ | -0.335 | 0.076 | 0.077 | γ_{THE} | 0.401 | 0.129 |
| $\gamma_{Exp-OCDE}$ | 1.080 | 0.101 | ψ_{THE} | -0.065 | 0.083 | 0.082 | γ_{CAC40} | 0.244 | 0.14 |
| $\gamma_{Imp-OCDE}$ | 1.090 | 0.105 | ψ_{CAC40} | 0.008 | 0.045 | 0.107 | $\gamma_{IPI-Agr}$ | 0.493 | 0.114 |
| ϕ_{CLI} | 0.310 | 0.270 | σ_{CLI} | 0.154 | 0.060 | 0.051 | $\gamma_{Exp-OCDE}$ | 1.080 | 0.106 |
| ϕ_{CCI} | -0.466 | 0.082 | σ_{NivCC} | 0.497 | 0.086 | 0.090 | $\gamma_{Imp-OCDE}$ | 1.090 | 0.111 |
| ψ_{NivCC} | -0.197 | 0.119 | $\sigma_{StPFPrevu}$ | 0.862 | 0.098 | 0.099 | ϕ_{CLI} | 0.693 | 0.126 |
| $\psi_{StPFPrevu}$ | -0.332 | 0.077 | σ_{THE} | 0.916 | 0.106 | 0.106 | ϕ_{CCI} | -0.467 | 0.078 |
| ψ_{THE} | -0.065 | 0.081 | σ_{CAC40} | 0.970 | 0.110 | 0.110 | ψ_{NivCC} | -0.186 | 0.099 |
| ψ_{CAC40} | 0.002 | 0.066 | Model (b): Composite Coincident Indicator | | | | $\psi_{StPFPrevu}$ | -0.323 | 0.076 |
| ψ_{IPI} | -0.400 | 0.093 | Parameter | Linear, LL=-737.8 | MS, LL=-737.0 | ψ_{THE} | -0.051 | 0.081 | |
| $\psi_{IPI-Agr}$ | -0.268 | 0.081 | p_{11} | — | 0.968 | 0.044 | ψ_{CAC40} | 0.015 | 0.065 |
| $\psi_{Exp-OCDE}$ | -0.386 | 0.097 | p_{12} | — | 0.067 | 0.086 | ψ_{IPI} | -0.413 | 0.090 |
| $\psi_{Imp-OCDE}$ | -0.409 | 0.099 | $\mu_{CCI,1}$ | — | 0.130 | 0.136 | $\psi_{IPI-Agr}$ | -0.259 | 0.081 |
| σ_{CLI} | 0.151 | 0.156 | $\mu_{CCI,2}$ | — | -0.308 | 0.255 | $\psi_{Exp-OCDE}$ | -0.386 | 0.100 |
| σ_{CCI} | 0.407 | 0.078 | $\gamma_{IPI-Agr}$ | 0.488 | 0.109 | 0.110 | $\psi_{Imp-OCDE}$ | -0.396 | 0.098 |
| σ_{NivCC} | 0.447 | 0.157 | $\gamma_{Exp-OCDE}$ | 1.060 | 0.101 | 1.070 | σ_{CLI} | 0.029 | 0.047 |
| $\sigma_{StPFPrevu}$ | 0.864 | 0.099 | $\gamma_{Imp-OCDE}$ | 1.070 | 0.105 | 1.080 | σ_{CCI} | 0.397 | 0.077 |
| σ_{THE} | 0.922 | 0.106 | ϕ_{CCI} | -0.358 | 0.086 | -0.401 | σ_{NivCC} | 0.563 | 0.095 |
| σ_{CAC40} | 0.962 | 0.109 | ψ_{IPI} | -0.416 | 0.093 | -0.410 | $\sigma_{StPFPrevu}$ | 0.876 | 0.100 |
| σ_{IPI} | 0.306 | 0.048 | $\psi_{IPI-Agr}$ | -0.270 | 0.081 | -0.269 | σ_{THE} | 0.925 | 0.106 |
| $\sigma_{IPI-Agr}$ | 0.750 | 0.086 | $\psi_{Exp-OCDE}$ | -0.367 | 0.098 | -0.371 | σ_{CAC40} | 0.969 | 0.109 |
| $\sigma_{Exp-OCDE}$ | 0.247 | 0.047 | $\psi_{Imp-OCDE}$ | -0.397 | 0.100 | -0.406 | σ_{IPI} | 0.298 | 0.047 |
| $\sigma_{Imp-OCDE}$ | 0.301 | 0.052 | σ_{CCI} | 0.532 | 0.094 | 0.489 | $\sigma_{IPI-Agr}$ | 0.751 | 0.087 |
| | | | σ_{IPI} | 0.296 | 0.048 | 0.300 | $\sigma_{Exp-OCDE}$ | 0.246 | 0.048 |
| | | | $\sigma_{IPI-Agr}$ | 0.747 | 0.086 | 0.748 | $\sigma_{Imp-OCDE}$ | 0.301 | 0.053 |
| | | | $\sigma_{Exp-OCDE}$ | 0.254 | 0.048 | 0.253 | | | |
| | | | $\sigma_{Imp-OCDE}$ | 0.305 | 0.053 | 0.301 | | | |

Note: LL is the log-likelihood function value

Table 5: Estimates of the parameters of German single- and bi-factor linear and Markov-switching models, monthly data 1991:1–2005:3

| Parameter | Model (a) LL=-2011.0 | | Model (b): Composite Leading Indicator | | | | Model (c) LL=-1992.3 | | | | |
|-------------------|-------------------------|----------|---|-------------------|----------|----------------|-------------------------|-------------------|-----------------|---------|-------|
| | Coeff | St.error | Parameter | Linear, LL=-909.9 | | MS, LL=-907.5 | | Parameter | Coeff | Sterror | |
| | | | | Coeff | St.error | Coeff | Sterror | | | | |
| p_{11} | 0.983 | 0.023 | p_{11} | — | 0.917 | 0.070 | p_{11} | 0.941 | 0.026 | | |
| p_{12} | 0.122 | 0.100 | p_{12} | — | 0.272 | 0.170 | p_{22} | 0.729 | 0.114 | | |
| μ_{CCL1}^1 | 0.008 | 0.031 | μ_{CCL1}^1 | — | 0.170 | 0.066 | A | 2.870 | 1.350 | | |
| μ_{CCL1}^2 | -0.058 | 0.130 | μ_{CCL1}^2 | — | -0.554 | 0.243 | B | 3.290 | 1.870 | | |
| μ_{CCI}^1 | 0.126 | 0.093 | γ_{SU0253} | 0.550 | 0.266 | 0.698 | 0.301 | μ_{CCL1}^1 | 0.153 | 0.052 | |
| μ_{CCI}^2 | -0.951 | 0.339 | γ_{WU3141} | 0.631 | 0.228 | 0.865 | 0.295 | μ_{CCL1}^2 | -0.483 | 0.142 | |
| γ_{SU0253} | 0.502 | 0.262 | γ_{YU0516} | 0.580 | 0.264 | 0.657 | 0.286 | μ_{CCI}^1 | 0.212 | 0.085 | |
| γ_{WU3141} | 0.662 | 0.236 | ϕ_{CCL1} | 0.752 | 0.081 | 0.443 | 0.319 | μ_{CCI}^2 | -0.574 | 0.170 | |
| γ_{YU0516} | 0.610 | 0.271 | ψ_{IFO} | 0.081 | 0.139 | 0.179 | 0.118 | γ_{SU0253} | 0.815 | 0.289 | |
| γ_{UXA001} | 0.819 | 0.208 | ψ_{SU0253} | 0.375 | 0.076 | 0.370 | 0.077 | γ_{WU3141} | 0.837 | 0.212 | |
| γ_{UXHK87} | 0.271 | 0.121 | ψ_{WU3141} | -0.162 | 0.090 | -0.211 | 0.085 | γ_{YU0516} | 0.645 | 0.252 | |
| γ_{UUC04} | 0.124 | 0.115 | ψ_{YU0516} | 0.294 | 0.078 | 0.305 | 0.077 | γ_{UXA001} | 0.802 | 0.180 | |
| γ_{EU2001} | 0.487 | 0.151 | σ_{CCL1} | 0.148 | 0.079 | 0.018 | 0.044 | γ_{UXHK87} | 0.235 | 0.117 | |
| ϕ_{CCL1} | 0.732 | 0.092 | σ_{IFO} | 0.648 | 0.127 | 0.737 | 0.109 | γ_{UUC04} | 0.100 | 0.099 | |
| ϕ_{CCI} | -0.253 | 0.142 | σ_{SU0253} | 0.749 | 0.088 | 0.747 | 0.086 | γ_{EU2001} | 0.508 | 0.138 | |
| ψ_{IFO} | 0.100 | 0.125 | σ_{WU3141} | 0.837 | 0.108 | 0.783 | 0.101 | ϕ_{CCL1} | 0.462 | 0.149 | |
| ψ_{SU0253} | 0.343 | 0.076 | σ_{YU0516} | 0.802 | 0.095 | 0.814 | 0.093 | ϕ_{CCI} | -0.228 | 0.131 | |
| ψ_{WU3141} | -0.167 | 0.090 | Model (b): Composite Coincident Indicator | | | | | | ψ_{IFO} | 0.184 | 0.084 |
| ψ_{YU0516} | 0.296 | 0.078 | Linear, LL=-1075.8 | | | MS, LL=-1071.0 | | | ψ_{SU0253} | 0.351 | 0.076 |
| ψ_{UXNI63} | -0.361 | 0.099 | Coeff | St.error | Coeff | St.error | Coeff | Sterror | ψ_{WU3141} | -0.198 | 0.083 |
| ψ_{UXA001} | -0.376 | 0.086 | — | — | 0.980 | 0.024 | — | — | ψ_{YU0516} | 0.301 | 0.075 |
| ψ_{UXHK87} | -0.383 | 0.072 | — | — | 0.123 | 0.094 | — | — | ψ_{UXNI63} | -0.359 | 0.098 |
| ψ_{UUC04} | 0.630 | 0.063 | — | — | 0.142 | 0.100 | — | — | ψ_{UXA001} | -0.389 | 0.082 |
| ψ_{EU2001} | -0.330 | 0.076 | — | — | -0.923 | 0.302 | — | — | ψ_{UXHK87} | -0.385 | 0.072 |
| σ_{CCL1} | 0.146 | 0.077 | γ_{UXA001} | 0.575 | 0.232 | 0.745 | 0.196 | ψ_{UUC04} | 0.664 | 0.071 | |
| σ_{CCI} | 0.359 | 0.140 | γ_{UXHK87} | 0.276 | 0.108 | 0.288 | 0.114 | ψ_{EU2001} | -0.373 | 0.064 | |
| σ_{IFO} | 0.661 | 0.121 | γ_{UUC04} | 0.124 | 0.100 | 0.167 | 0.118 | σ_{CCL1} | 0.017 | 0.032 | |
| σ_{SU0253} | 0.792 | 0.092 | γ_{EU2001} | 0.329 | 0.117 | 0.390 | 0.109 | σ_{CCI} | 0.364 | 0.112 | |
| σ_{YU0516} | 0.830 | 0.108 | ϕ_{CCI} | -0.165 | 0.155 | -0.276 | 0.141 | σ_{IFO} | 0.747 | 0.092 | |
| σ_{UXNI63} | 0.796 | 0.095 | ψ_{UXNI63} | -0.383 | 0.143 | -0.368 | 0.107 | σ_{SU0253} | 0.736 | 0.084 | |
| σ_{UXA001} | 0.447 | 0.129 | ψ_{UXA001} | -0.368 | 0.083 | -0.391 | 0.086 | σ_{WU3141} | 0.806 | 0.097 | |
| σ_{UXHK87} | 0.600 | 0.103 | ψ_{UXHK87} | -0.389 | 0.072 | -0.387 | 0.073 | σ_{YU0516} | 0.818 | 0.092 | |
| σ_{UUC04} | 0.810 | 0.091 | ψ_{UUC04} | 0.581 | 0.066 | 0.580 | 0.066 | σ_{UXNI63} | 0.438 | 0.116 | |
| σ_{EU2001} | 0.605 | 0.067 | ψ_{EU2001} | -0.523 | 0.069 | -0.531 | 0.068 | σ_{UXA001} | 0.599 | 0.096 | |
| | 0.803 | 0.094 | σ_{CCI} | 0.675 | 0.286 | 0.400 | 0.159 | σ_{UXHK87} | 0.813 | 0.090 | |
| | | | σ_{UXNI63} | 0.249 | 0.252 | 0.403 | 0.138 | σ_{UUC04} | 0.572 | 0.069 | |
| | | | σ_{UXA001} | 0.698 | 0.120 | 0.626 | 0.103 | σ_{EU2001} | 0.699 | 0.087 | |
| | | | σ_{UXHK87} | 0.791 | 0.088 | 0.799 | 0.090 | | | | |
| | | | σ_{UUC04} | 0.646 | 0.072 | 0.641 | 0.072 | | | | |
| | | | σ_{EU2001} | 0.656 | 0.076 | 0.647 | 0.075 | | | | |

Note: LL is the log-likelihood function value

Table 6: Estimates of the parameters of UK single- and bi-factor linear and Markov-switching models, monthly data 1986:1–2005:3

| Parameter | Model (a) LL=-1820.2 | | Model (b): Composite Leading Indicator | | | | Model (c) LL=-1817.7 | | |
|----------------------|-------------------------|----------|--|-------------------|---------------|-----------|-------------------------|----------|-------|
| | Coeff | St.error | Parameter | Linear, LL=-905.6 | MS, LL=-904.7 | Parameter | Coeff | St.error | |
| p_{11} | 0.709 | 0.112 | p_{11} | — | 0.901 | 0.122 | p_{11} | 0.923 | 0.042 |
| p_{22} | 0.305 | 0.185 | p_{12} | — | 0.197 | 0.233 | p_{22} | 0.902 | 0.042 |
| μ_{1}^{CLI} | 0.468 | 0.148 | μ_{1}^{CLI} | — | 0.202 | 0.198 | A | 1.220 | 0.326 |
| μ_{2}^{CLI} | -0.484 | 0.158 | μ_{2}^{CLI} | — | -0.406 | 0.352 | B | 3.130 | 1.480 |
| μ_{1}^{CCI} | 0.053 | 0.026 | $\gamma_{BS-RETA}$ | 0.492 | 0.107 | 0.106 | μ_{1}^{CLI} | 0.241 | 0.127 |
| μ_{2}^{CCI} | -0.058 | 0.032 | $\gamma_{BS-UK-ESI}$ | 1.350 | 0.192 | 0.190 | μ_{2}^{CCI} | -0.359 | 0.107 |
| $\gamma_{BS-RETA}$ | 0.489 | 0.107 | ϕ_{CLI} | 0.063 | 0.098 | -0.065 | 0.104 | 0.212 | 0.204 |
| $\gamma_{BS-UK-ESI}$ | 1.240 | 0.159 | ψ_{ETCU} | -0.255 | 0.074 | 0.075 | 0.141 | -0.234 | 0.141 |
| γ_{FTAQ} | 0.827 | 0.604 | $\psi_{BS-RETA}$ | -0.233 | 0.066 | 0.066 | 0.490 | 0.490 | 0.105 |
| γ_{EAPS} | 0.974 | 0.426 | $\psi_{BS-UK-ESI}$ | -0.395 | 0.150 | -0.373 | 1.290 | 1.290 | 0.171 |
| ϕ_{CLI} | -0.093 | 0.123 | σ_{CLI} | 0.434 | 0.085 | 0.363 | 0.853 | 1.240 | 0.853 |
| ϕ_{CCI} | 0.849 | 0.114 | σ_{ETCU} | 0.544 | 0.077 | 0.540 | 1.090 | 1.090 | 0.879 |
| ψ_{ETCU} | -0.263 | 0.079 | $\sigma_{BS-RETA}$ | 0.855 | 0.081 | 0.853 | 0.081 | -0.080 | 0.108 |
| $\psi_{BS-RETA}$ | -0.234 | 0.067 | $\sigma_{BS-UK-ESI}$ | 0.163 | 0.111 | 0.170 | 0.401 | -0.462 | 0.401 |
| $\psi_{BS-UK-ESI}$ | -0.331 | 0.125 | | | | | -0.256 | 0.079 | |
| ψ_{CKYW} | -0.379 | 0.062 | | | | | -0.242 | 0.066 | |
| ψ_{FTAQ} | -0.244 | 0.067 | | | | | -0.357 | 0.137 | |
| ψ_{EAPS} | -0.508 | 0.058 | | | | | -0.356 | 0.065 | |
| σ_{CLI} | 0.250 | 0.088 | | | | | -0.380 | 0.074 | |
| σ_{CCI} | 0.000 | 0.000 | | | | | -0.521 | 0.064 | |
| σ_{ETCU} | 0.506 | 0.073 | | | | | 0.375 | 0.074 | |
| $\sigma_{BS-RETA}$ | 0.847 | 0.082 | | | | | 0.008 | 0.032 | |
| $\sigma_{BS-UK-ESI}$ | 0.239 | 0.093 | | | | | 0.522 | 0.075 | |
| σ_{CKYW} | 0.831 | 0.079 | | | | | 0.845 | 0.081 | |
| σ_{FTAQ} | 0.920 | 0.088 | | | | | 0.202 | 0.100 | |
| σ_{EAPS} | 0.720 | 0.069 | | | | | 0.831 | 0.098 | |
| | | | | | | | 0.814 | 0.093 | |
| | | | | | | | 0.695 | 0.081 | |

Note: LL is the log-likelihood function value

Table 7: Reference chronologies of the business cycle in France, Germany, and UK

| | OECD | | ECRI | | BBQ | |
|---------|---------|---------|---------|---------|----------|----------|
| | P | T | P | T | P | T |
| France | 1990:01 | 1991:03 | 1988:02 | 1993:05 | 1992:III | 1993:II |
| | 1991:12 | 1993:08 | 1995:01 | 1996:09 | | |
| | 1995:03 | 1997:01 | 1999:11 | | | |
| | 1998:05 | 1999:04 | | | | |
| | 2000:11 | | | | | |
| Germany | 1992:02 | 1993:07 | 1991:01 | 1993:01 | | 1991:III |
| | 1994:12 | 1996:02 | 1994:12 | 1997:01 | 1992:I | 1993:I |
| | 1998:03 | 1999:02 | 1998:03 | 1999:02 | 1995:III | 1996:I |
| | 2000:05 | | 2000:05 | 2002:03 | 2001:II | 2002:I |
| | | | | | 2002:III | 2003:II |
| UK | 1985:01 | 1985:12 | 1985:05 | 1985:12 | 1990:II | 1991:III |
| | 1988:09 | 1992:05 | 1988:01 | 1991:04 | | |
| | 1994:09 | 1999:02 | 1994:07 | 1995:08 | | |
| | 2000:08 | | 1997:07 | 1999:02 | | |
| | | | 2000:01 | | | |

Note: "P" stands for peaks, "T" stands for troughs.

Sources:

- (i) Economic Cycle Research Institute (<http://www.businesscycle.com/>);
- (ii) Organization for Economic Cooperation and Development (http://www.oecd.org/document/41/0,2340,en_2825_293564_1891113_1_1_1_1,00.html);
- (iii) Own calculations using the code of Harding and Pagan.

Table 8: The in-sample performance of alternative models with respect to the OECD's and ECRI's chronology (France, 1992:3–2005:4)

| Model | OECD | | ECRI | | BBQ | |
|---------------|-------|-----|-------|-----|-------|-----|
| | QPS | Lag | QPS | Lag | QPS | Lag |
| p-fid | 0.163 | 2 | 0.222 | -1 | 0.342 | 5 |
| p-sid | 0.152 | 2 | 0.224 | 0 | 0.366 | 6 |
| p-fCLI | 0.173 | 2 | 0.214 | 0 | 0.338 | 7 |
| p-sCLI | 0.155 | 6 | 0.215 | 2 | 0.347 | 7 |
| p-fCCI | 0.246 | -3 | 0.231 | -6 | 0.116 | 2 |
| p-sCCI | 0.263 | 2 | 0.241 | -5 | 0.125 | 5 |
| p-bifCLI | 0.165 | 2 | 0.210 | 0 | 0.357 | 5 |
| p-bisCLI | 0.154 | 5 | 0.227 | 1 | 0.392 | 7 |
| p-bifCCI | 0.184 | 2 | 0.235 | -1 | 0.303 | 3 |
| p-bisCCI | 0.167 | 2 | 0.240 | -1 | 0.312 | 5 |
| pMSI-CLI-f1 | 0.194 | 2 | 0.234 | -1 | 0.339 | 3 |
| pMSI-CLI-s1 | 0.189 | 3 | 0.248 | 0 | 0.363 | 4 |
| pMSIH-CLI-f1 | 0.313 | 3 | 0.359 | 0 | 0.230 | 8 |
| pMSIH-CLI-s1 | 0.300 | 3 | 0.353 | 0 | 0.243 | 8 |
| pMSM-CLI-f1 | 0.194 | 2 | 0.234 | -1 | 0.339 | 3 |
| pMSM-CLI-s1 | 0.190 | 3 | 0.249 | 0 | 0.364 | 4 |
| pMSIA-CLI-f1 | 0.310 | 3 | 0.326 | -5 | 0.408 | -7 |
| pMSIA-CLI-s1 | 0.308 | 3 | 0.326 | -5 | 0.408 | -7 |
| pMSIAH-CLI-f1 | 0.274 | 3 | 0.303 | -5 | 0.380 | -7 |
| pMSIAH-CLI-s1 | 0.281 | 3 | 0.314 | -5 | 0.389 | -5 |
| pMSI-CCI-f1 | 0.398 | -8 | 0.391 | -9 | 0.330 | -9 |
| pMSI-CCI-s1 | 0.399 | -8 | 0.393 | -9 | 0.332 | -9 |
| pMSIH-CCI-f1 | 0.417 | -9 | 0.422 | 9 | 0.163 | 5 |
| pMSIH-CCI-s1 | 0.415 | -9 | 0.417 | 9 | 0.162 | 5 |
| pMSM-CCI-f1 | 0.239 | 2 | 0.227 | -9 | 0.200 | -9 |
| pMSM-CCI-s1 | 0.230 | 2 | 0.223 | -9 | 0.200 | -9 |
| pMSIA-CCI-f1 | 0.340 | -9 | 0.349 | -9 | 0.290 | -9 |
| pMSIA-CCI-s1 | 0.368 | -9 | 0.377 | -9 | 0.303 | -9 |
| pMSIAH-CCI-f1 | 0.366 | -9 | 0.359 | -9 | 0.321 | -9 |
| pMSIAH-CCI-s1 | 0.378 | -9 | 0.370 | -9 | 0.325 | -9 |
| pMSI-All-f1 | 0.199 | 2 | 0.253 | -1 | 0.334 | 2 |
| pMSI-All-s1 | 0.193 | 2 | 0.266 | 0 | 0.358 | 3 |
| pMSIH-All-f1 | 0.231 | 3 | 0.320 | 1 | 0.305 | 1 |
| pMSIH-All-s1 | 0.227 | 3 | 0.333 | 1 | 0.327 | 1 |
| pMSM-All-f1 | 0.216 | 2 | 0.279 | -1 | 0.322 | 3 |
| pMSM-All-s1 | 0.216 | 2 | 0.298 | 0 | 0.344 | 4 |
| pMSIA-All-f1 | 0.353 | 7 | 0.333 | -5 | 0.525 | -7 |
| pMSIA-All-s1 | 0.351 | 7 | 0.331 | -5 | 0.524 | -7 |
| pMSIAH-All-f1 | 0.227 | 3 | 0.236 | -5 | 0.510 | -4 |
| pMSIAH-All-s1 | 0.226 | 3 | 0.244 | -5 | 0.518 | -4 |

Table 9: The in-sample performance of alternative models with respect to the OECD's and ECRI's chronology (Germany, 1991:3–2005:3)

| Model | OECD | | ECRI | | BBQ | |
|---------------|-------|-----|-------|-----|-------|-----|
| | QPS | Lag | QPS | Lag | QPS | Lag |
| p-fid | 0.432 | -3 | 0.338 | -6 | 0.147 | 0 |
| p-sid | 0.456 | -1 | 0.338 | -9 | 0.149 | 1 |
| p-fCLI | 0.338 | -2 | 0.325 | 2 | 0.158 | 6 |
| p-sCLI | 0.325 | 1 | 0.317 | 3 | 0.134 | 6 |
| p-fCCI | 0.424 | -3 | 0.330 | -6 | 0.142 | 0 |
| p-sCCI | 0.448 | -1 | 0.331 | -6 | 0.145 | 1 |
| p-bifCLI | 0.328 | 0 | 0.320 | 2 | 0.153 | 6 |
| p-bisCLI | 0.309 | 2 | 0.294 | 2 | 0.122 | 6 |
| p-bifCCI | 0.253 | -2 | 0.257 | -2 | 0.131 | 0 |
| p-bisCCI | 0.273 | -2 | 0.256 | -1 | 0.124 | 1 |
| pMSI-CLI-f1 | 0.256 | 2 | 0.271 | -3 | 0.374 | 6 |
| pMSI-CLI-s1 | 0.258 | 3 | 0.268 | 1 | 0.372 | 6 |
| pMSIH-CLI-f1 | 0.354 | 3 | 0.390 | -9 | 0.226 | 7 |
| pMSIH-CLI-s1 | 0.365 | 6 | 0.401 | -9 | 0.265 | 7 |
| pMSM-CLI-f1 | 0.292 | -1 | 0.247 | -1 | 0.366 | -1 |
| pMSM-CLI-s1 | 0.318 | 2 | 0.239 | 0 | 0.376 | -1 |
| pMSIA-CLI-f1 | 0.329 | 3 | 0.226 | 2 | 0.292 | 7 |
| pMSIA-CLI-s1 | 0.338 | 3 | 0.221 | 5 | 0.289 | 8 |
| pMSIAH-CLI-f1 | 0.370 | 3 | 0.345 | -4 | 0.267 | 9 |
| pMSIAH-CLI-s1 | 0.370 | 7 | 0.349 | -4 | 0.260 | 9 |
| pMSI-CCI-f1 | 0.281 | -1 | 0.200 | -1 | 0.151 | 0 |
| pMSI-CCI-s1 | 0.283 | 0 | 0.177 | 0 | 0.171 | 1 |
| pMSIH-CCI-f1 | 0.475 | -7 | 0.367 | -5 | 0.188 | -3 |
| pMSIH-CCI-s1 | 0.480 | 1 | 0.363 | -4 | 0.187 | -3 |
| pMSM-CCI-f1 | 0.470 | -6 | 0.352 | -9 | 0.180 | 0 |
| pMSM-CCI-s1 | 0.492 | -5 | 0.365 | -5 | 0.217 | 1 |
| pMSIA-CCI-f1 | 0.349 | 9 | 0.449 | -9 | 0.623 | -7 |
| pMSIA-CCI-s1 | 0.349 | 9 | 0.449 | -9 | 0.623 | -7 |
| pMSIAH-CCI-f1 | 0.471 | -7 | 0.369 | -4 | 0.215 | -2 |
| pMSIAH-CCI-s1 | 0.473 | 1 | 0.366 | -4 | 0.219 | -2 |
| pMSI-All-f1 | 0.233 | 0 | 0.315 | -3 | 0.213 | 5 |
| pMSI-All-s1 | 0.208 | 2 | 0.329 | -3 | 0.216 | 6 |
| pMSIH-All-f1 | 0.278 | 1 | 0.296 | -4 | 0.262 | 7 |
| pMSIH-All-s1 | 0.276 | 1 | 0.314 | -3 | 0.269 | 3 |
| pMSM-All-f1 | 0.233 | 1 | 0.335 | -3 | 0.221 | 5 |
| pMSM-All-s1 | 0.243 | 2 | 0.352 | -3 | 0.227 | 6 |
| pMSIA-All-f1 | 0.297 | 1 | 0.329 | -3 | 0.349 | 3 |
| pMSIA-All-s1 | 0.291 | 1 | 0.331 | -3 | 0.348 | 3 |
| pMSIAH-All-f1 | 0.233 | 1 | 0.316 | 1 | 0.311 | 4 |
| pMSIAH-All-s1 | 0.227 | 1 | 0.319 | 1 | 0.303 | 6 |

Table 10: The in-sample performance of alternative models with respect to the OECD's and ECRI's chronology (UK, 1986:3–2005:3)

| Model | OECD | | ECRI | | BBQ | |
|---------------|-------|-----|-------|-----|-------|-----|
| | QPS | Lag | QPS | Lag | QPS | Lag |
| p-fid | 0.290 | -5 | 0.260 | -1 | 0.320 | 9 |
| p-sid | 0.287 | -4 | 0.247 | -1 | 0.323 | 7 |
| p-fCLI | 0.310 | -5 | 0.266 | -5 | 0.150 | 7 |
| p-sCLI | 0.306 | -4 | 0.244 | -4 | 0.155 | 7 |
| p-fCCI | 0.338 | -8 | 0.299 | -9 | 0.084 | -2 |
| p-sCCI | 0.377 | -2 | 0.295 | -9 | 0.101 | 6 |
| p-bifCLI | 0.269 | -5 | 0.204 | -5 | 0.217 | 9 |
| p-bisCLI | 0.274 | 2 | 0.184 | -2 | 0.238 | 9 |
| p-bifCCI | 0.223 | 0 | 0.174 | -5 | 0.287 | 6 |
| p-bisCCI | 0.217 | 1 | 0.168 | -5 | 0.297 | 9 |
| pMSI-CLI-f1 | 0.314 | -4 | 0.254 | -2 | 0.247 | 9 |
| pMSI-CLI-s1 | 0.322 | 3 | 0.243 | 2 | 0.259 | 9 |
| pMSIH-CLI-f1 | 0.256 | 8 | 0.247 | 3 | 0.460 | 9 |
| pMSIH-CLI-s1 | 0.250 | 8 | 0.238 | 3 | 0.472 | 9 |
| pMSM-CLI-f1 | 0.301 | -4 | 0.247 | -1 | 0.255 | 9 |
| pMSM-CLI-s1 | 0.311 | 7 | 0.235 | 2 | 0.270 | 9 |
| pMSIA-CLI-f1 | 0.288 | 3 | 0.237 | -1 | 0.303 | 9 |
| pMSIA-CLI-s1 | 0.283 | 8 | 0.225 | -1 | 0.310 | 9 |
| pMSIAH-CLI-f1 | 0.276 | 7 | 0.254 | -1 | 0.425 | 9 |
| pMSIAH-CLI-s1 | 0.264 | 8 | 0.247 | 2 | 0.435 | 9 |
| pMSI-CCI-f1 | 0.315 | -8 | 0.279 | -9 | 0.101 | -2 |
| pMSI-CCI-s1 | 0.353 | -2 | 0.285 | -9 | 0.112 | 6 |
| pMSIH-CCI-f1 | 0.414 | -9 | 0.376 | -9 | 0.332 | -9 |
| pMSIH-CCI-s1 | 0.393 | -9 | 0.346 | -9 | 0.369 | -9 |
| pMSM-CCI-f1 | 0.323 | -8 | 0.289 | -9 | 0.093 | -2 |
| pMSM-CCI-s1 | 0.367 | -2 | 0.293 | -9 | 0.106 | 6 |
| pMSIA-CCI-f1 | 0.223 | 1 | 0.261 | -1 | 0.504 | -9 |
| pMSIA-CCI-s1 | 0.219 | 1 | 0.263 | 6 | 0.514 | -9 |
| pMSIAH-CCI-f1 | 0.466 | -9 | 0.405 | -9 | 0.220 | -7 |
| pMSIAH-CCI-s1 | 0.474 | -9 | 0.405 | -9 | 0.239 | 5 |
| pMSI-All-f1 | 0.324 | 2 | 0.252 | -2 | 0.258 | 9 |
| pMSI-All-s1 | 0.338 | 1 | 0.248 | -1 | 0.267 | 9 |
| pMSIH-All-f1 | 0.474 | -9 | 0.413 | -9 | 0.262 | 3 |
| pMSIH-All-s1 | 0.519 | -9 | 0.444 | -9 | 0.284 | 4 |
| pMSM-All-f1 | 0.298 | 2 | 0.238 | -1 | 0.256 | 9 |
| pMSM-All-s1 | 0.310 | 1 | 0.232 | -1 | 0.269 | 9 |
| pMSIA-All-f1 | 0.439 | -6 | 0.403 | -5 | 0.224 | 4 |
| pMSIA-All-s1 | 0.439 | -6 | 0.403 | -5 | 0.224 | 4 |
| pMSIAH-All-f1 | 0.485 | -8 | 0.449 | -9 | 0.175 | 4 |
| pMSIAH-All-s1 | 0.485 | -8 | 0.447 | -9 | 0.174 | 4 |

Figure 1: The British economic indicators classified using the cluster analysis

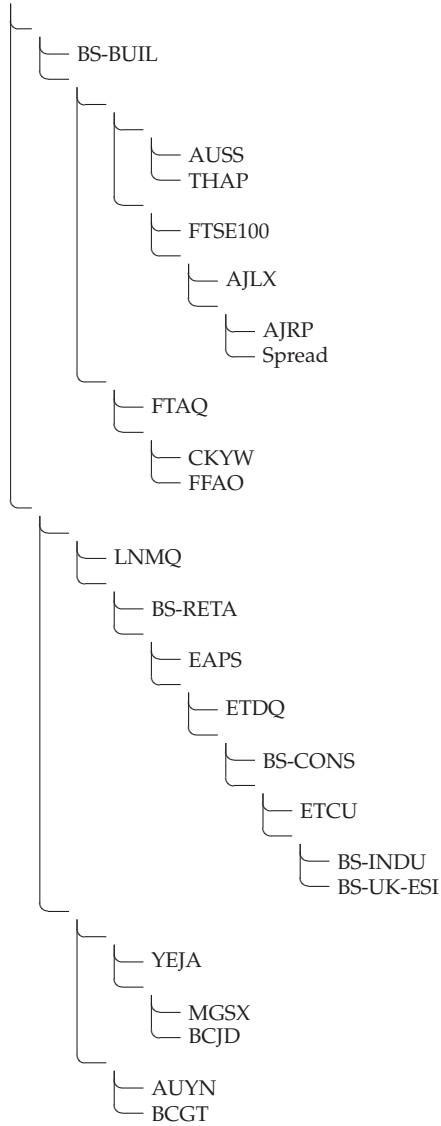

Figure 2: French GDP vs. alternative reference chronologies, 1992:1-2005:4

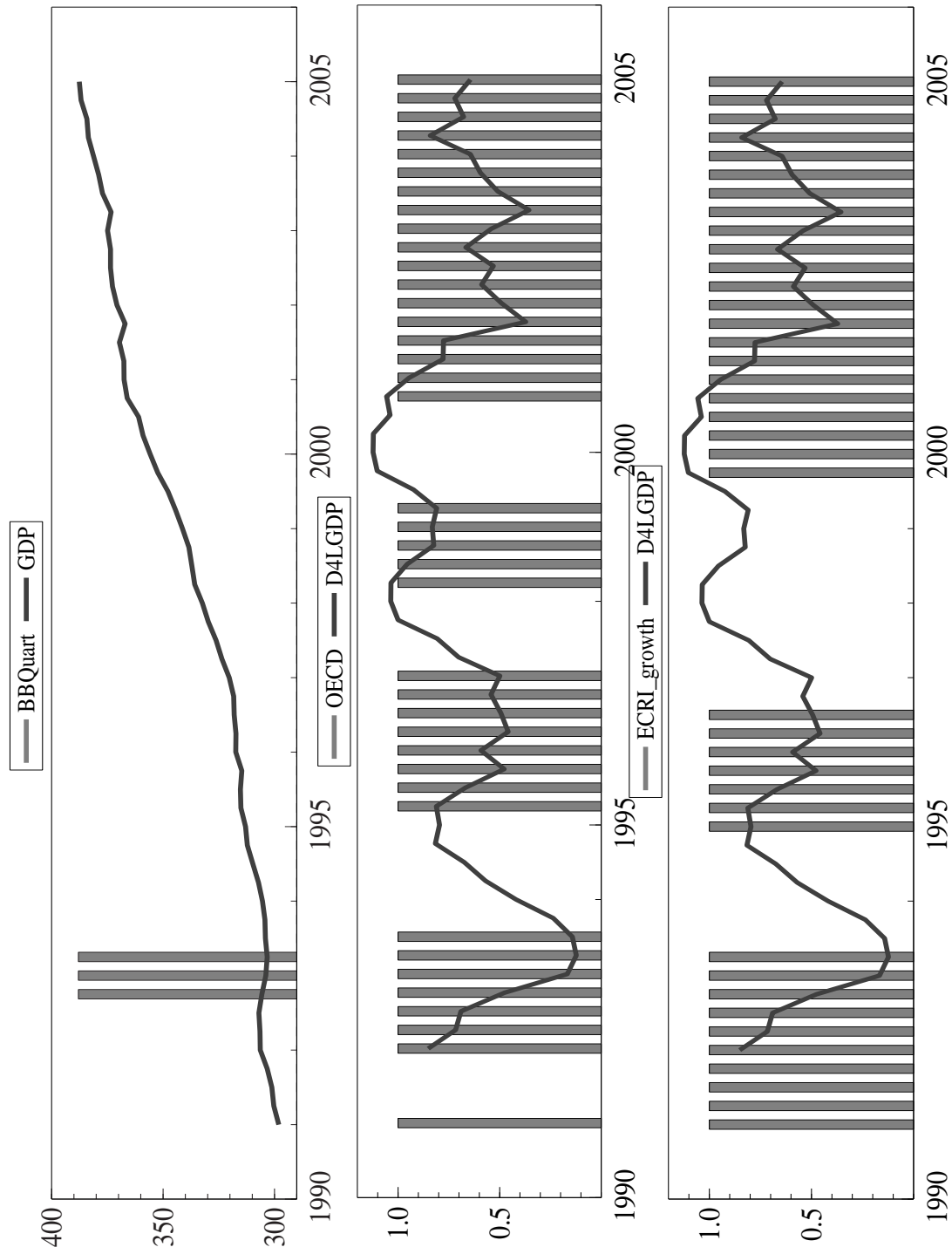

Figure 3: German GDP vs. alternative reference chronologies,1991:1-2005:3

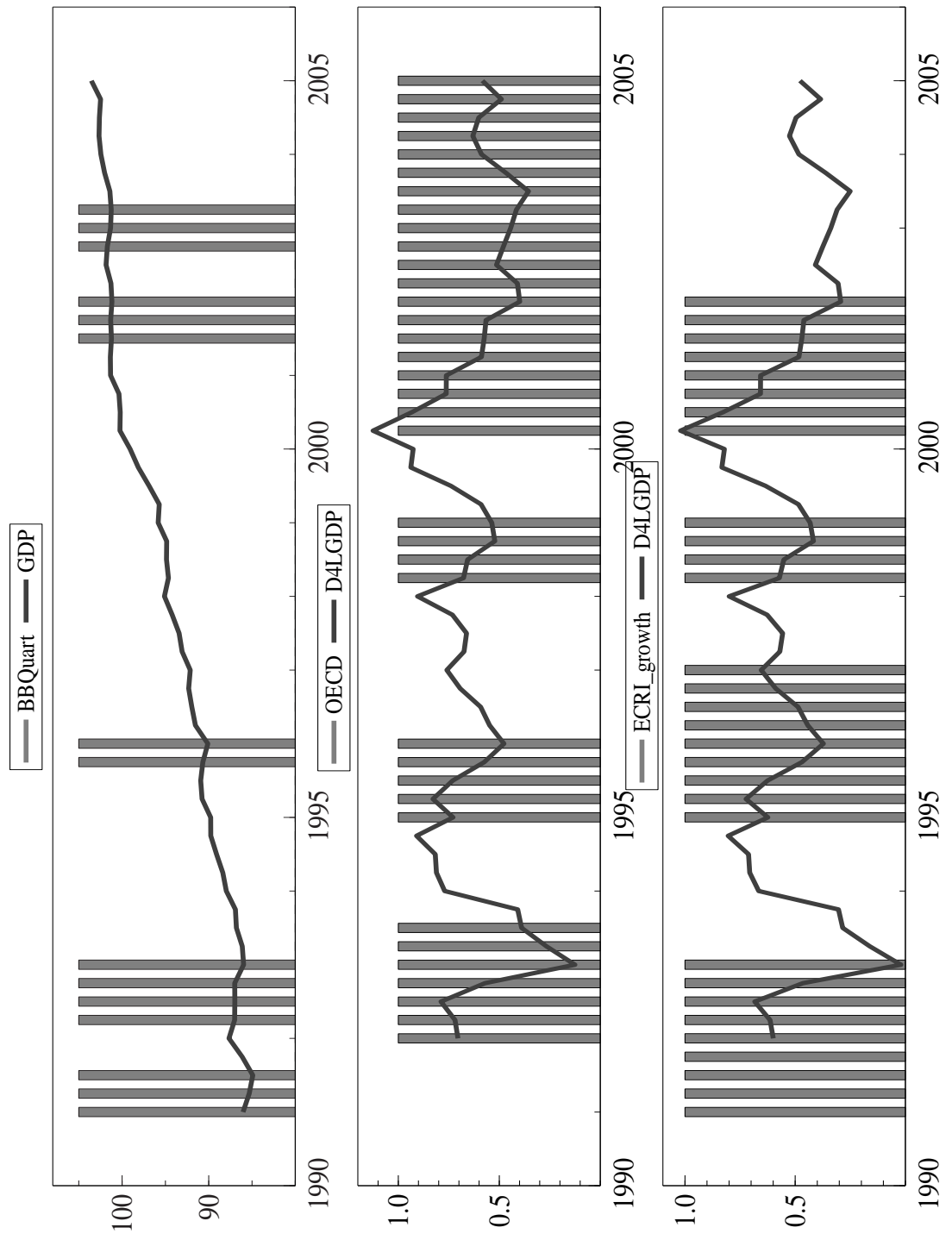

Figure 4: British GDP vs. alternative reference chronologies, 1986:1-2005:3

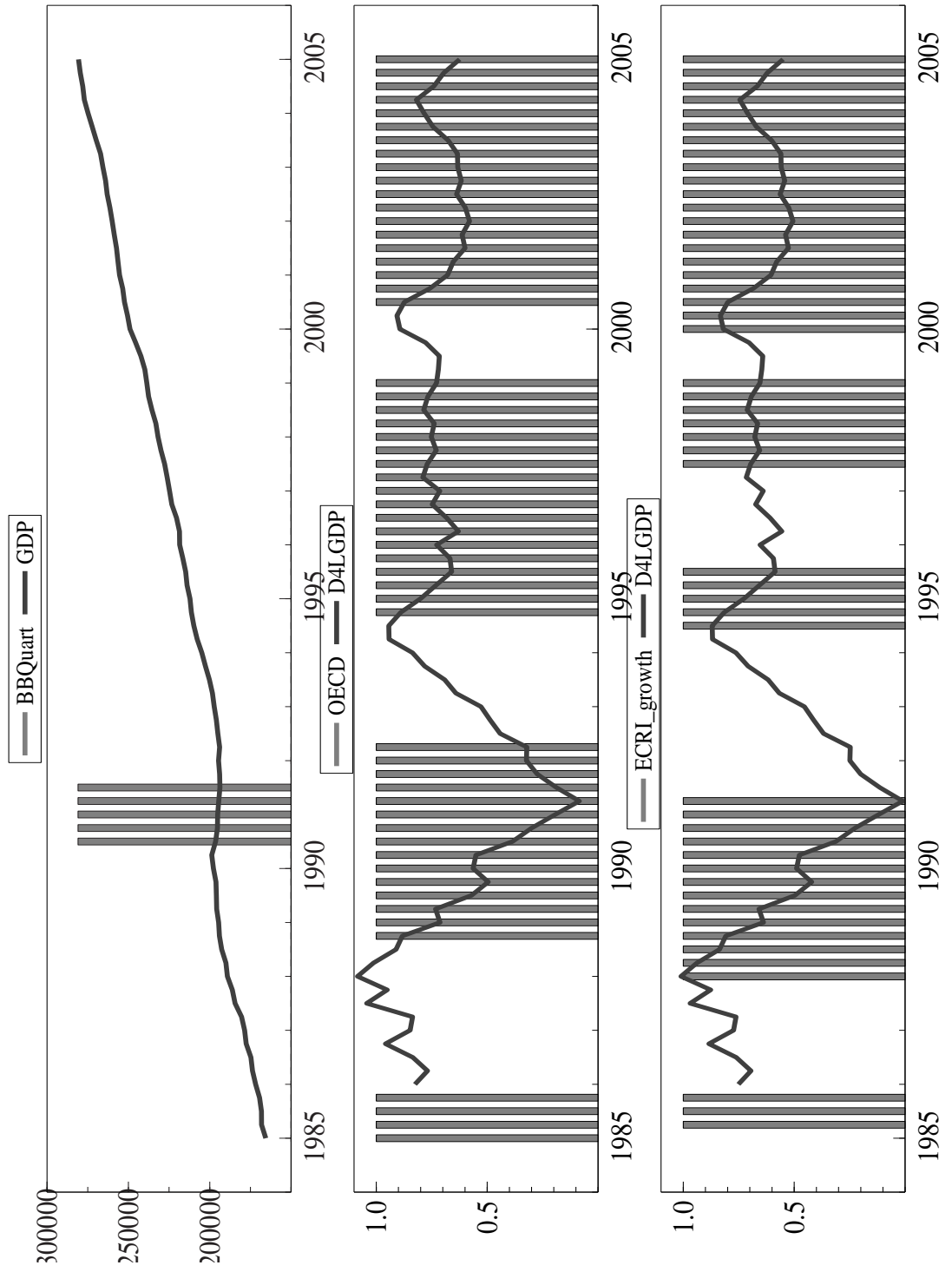

Figure 5: French CLI and CCI in levels, 1992:1-2005:4

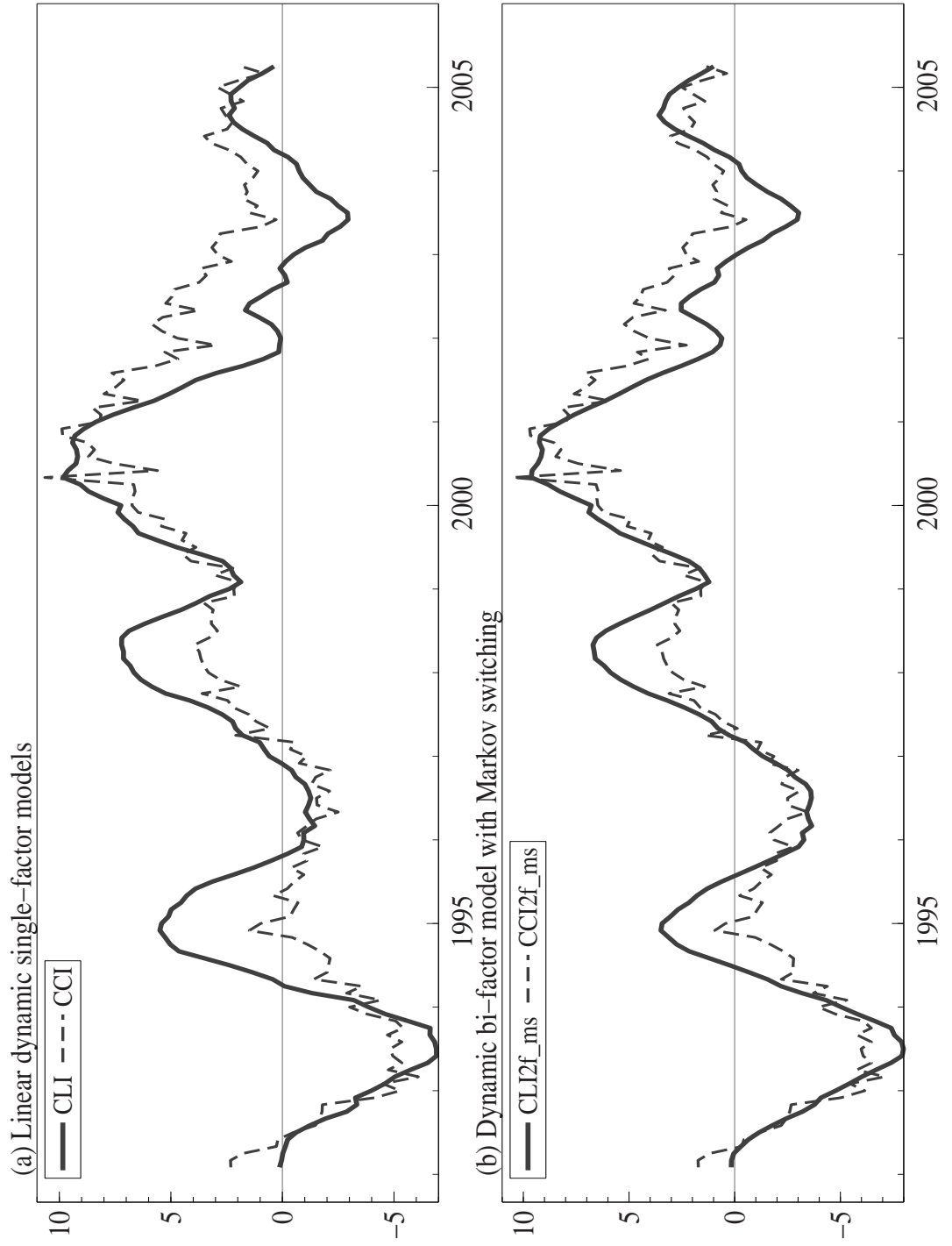

Figure 6: Recession probabilities of the single- and bi-factor models for France vs. cyclical chronology of the OECD, 1992:1-2005:4

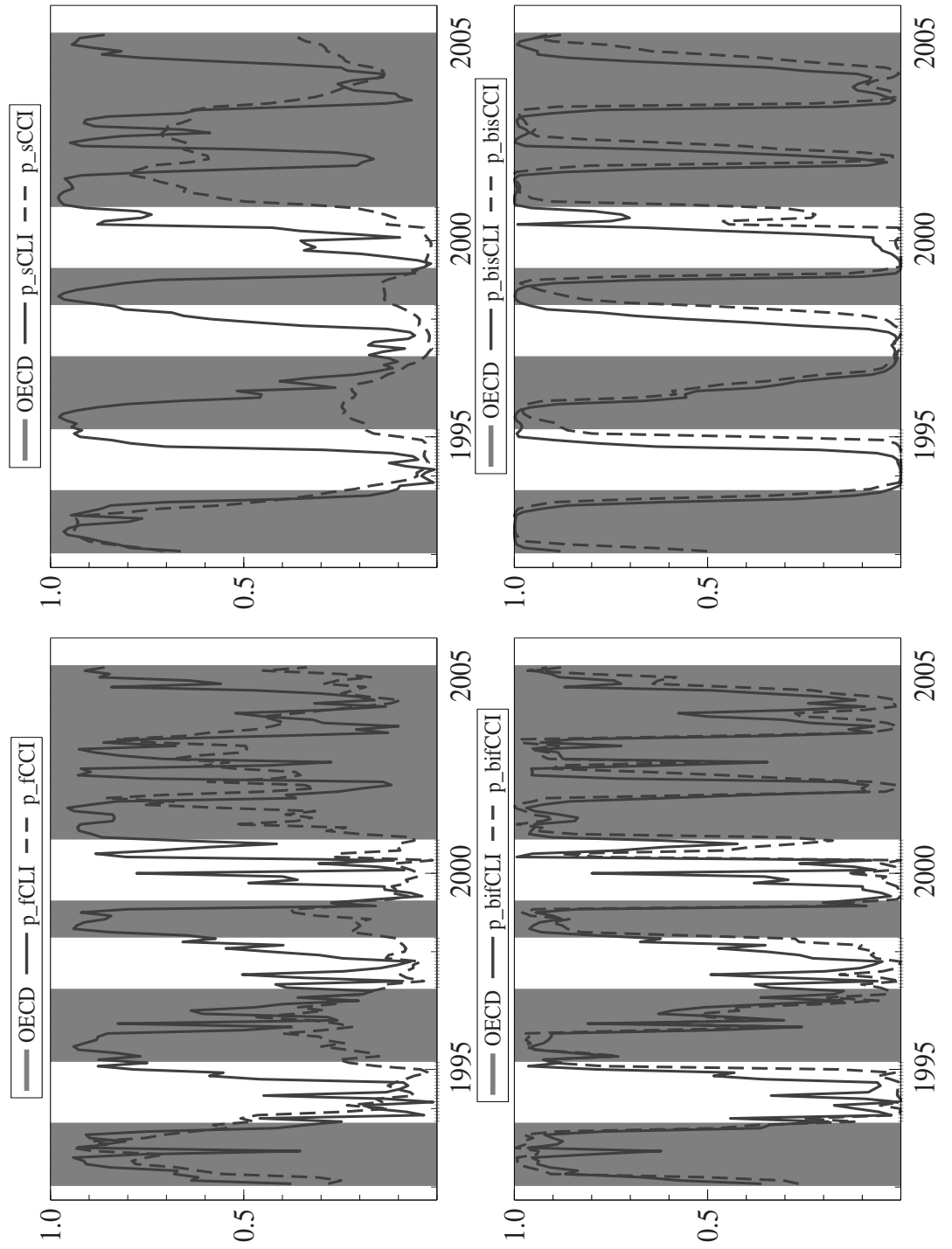

Figure 7: Recession probabilities of the single- and bi-factor models for France vs. cyclical chronology of the ECRI (growth cycle), 1992:1-2005:4

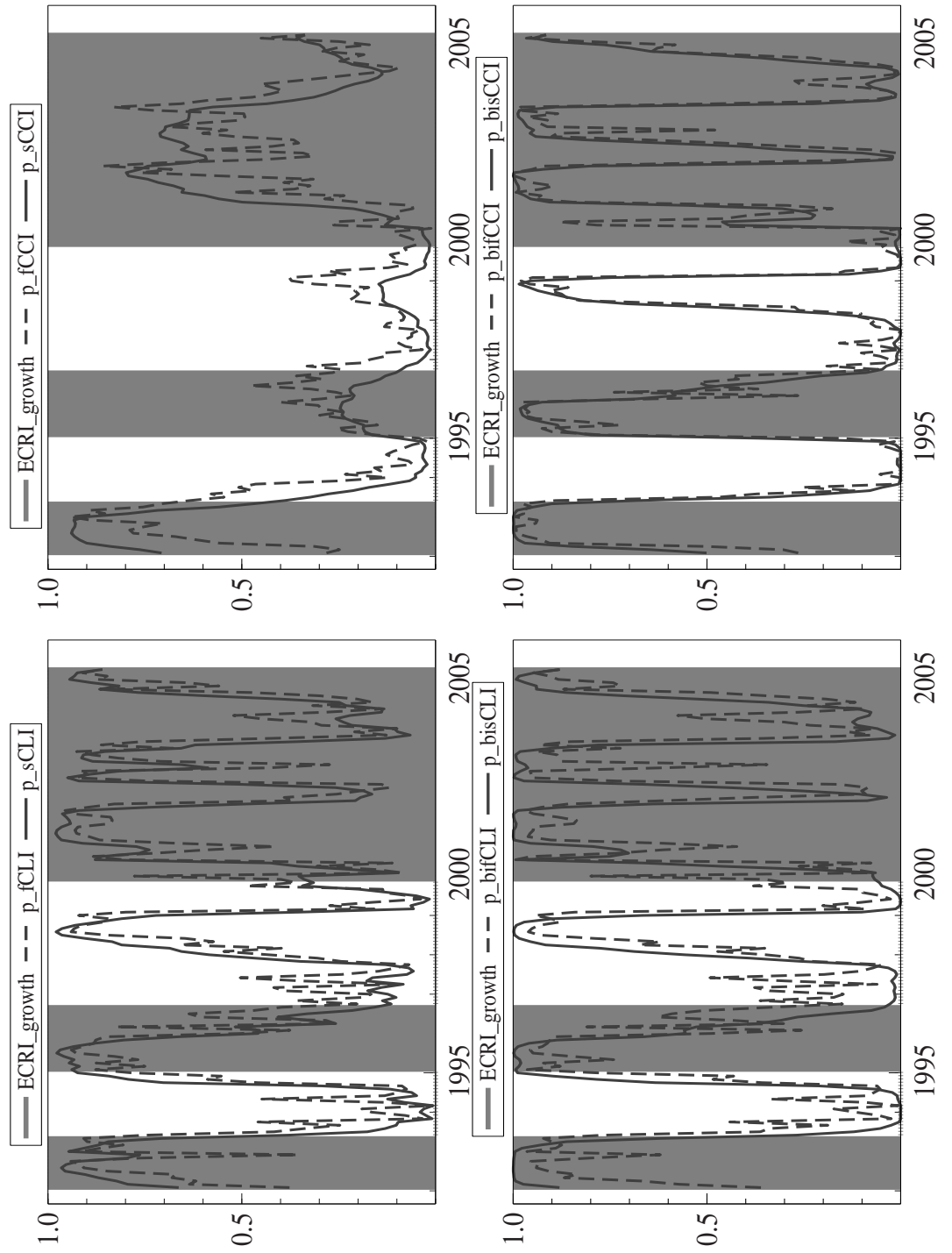

Figure 8: Recession probabilities of the single- and bi-factor models for France vs. cyclical chronology of the BBQ (classical cycle), 1992:1-2005:4

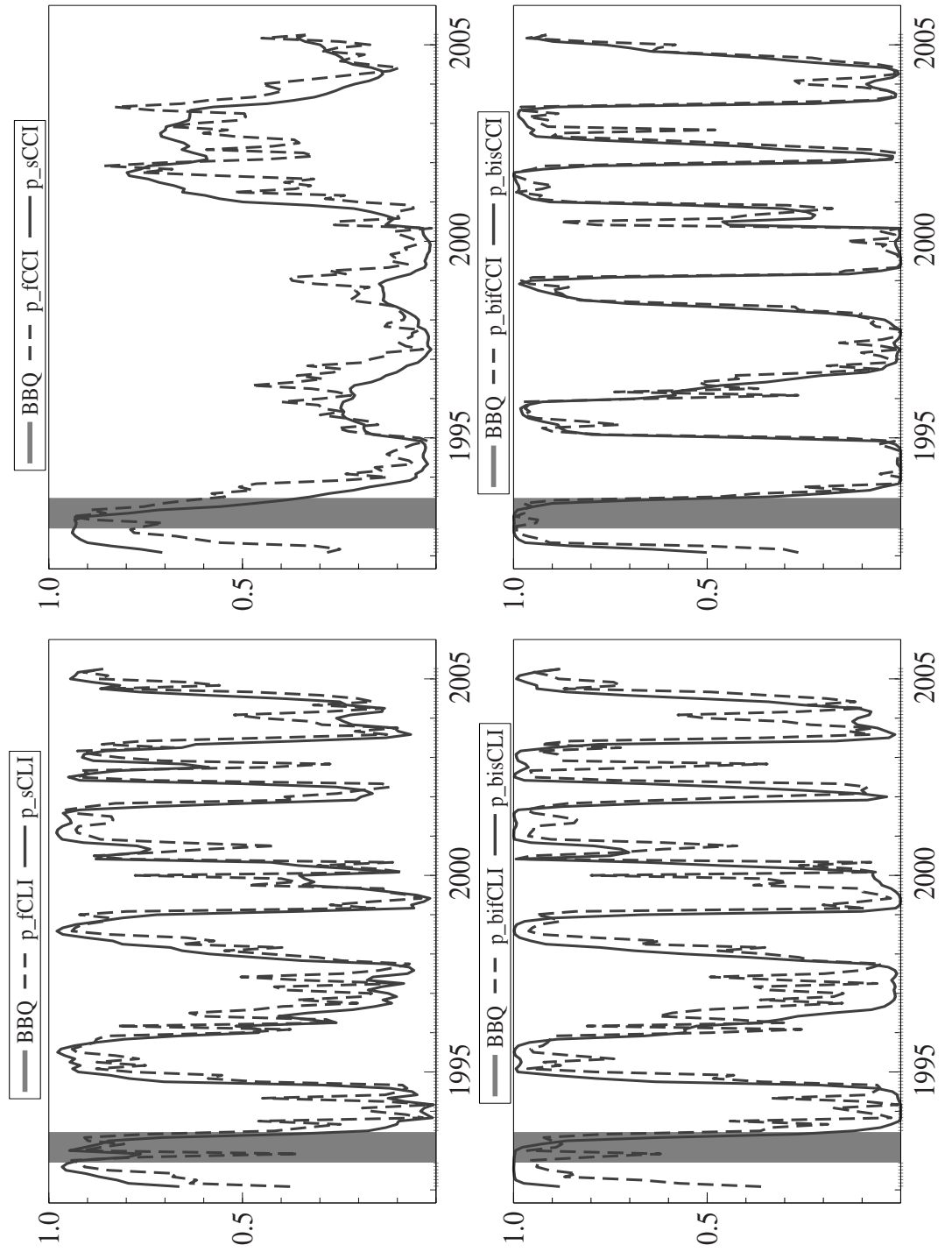

Figure 9: German CLI and CCI in levels, 1991:1-2005:3

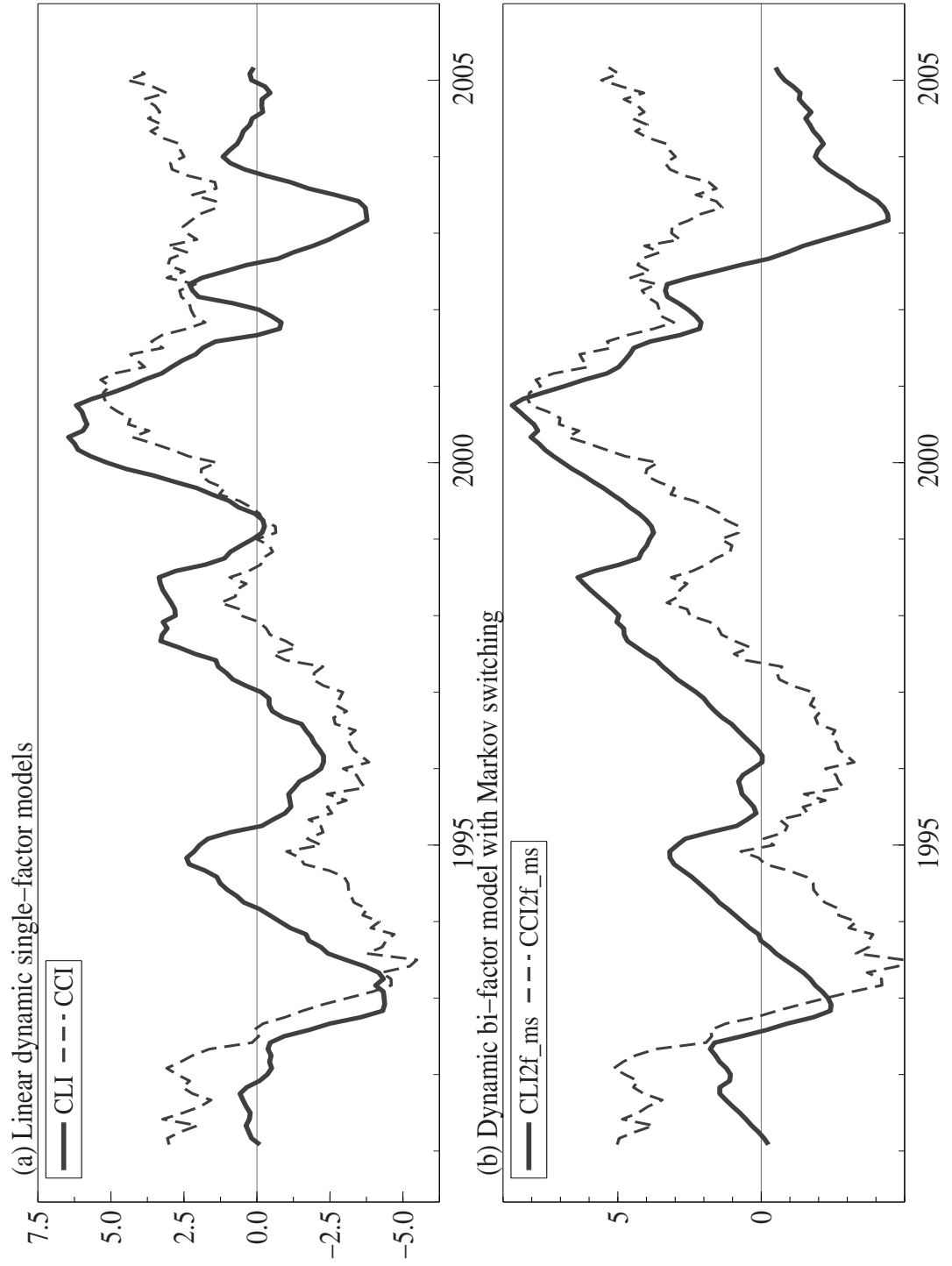

Figure 10: Recession probabilities of the single- and bi-factor models for Germany vs. cyclical chronology of the OECD, 1991:1-2005:3

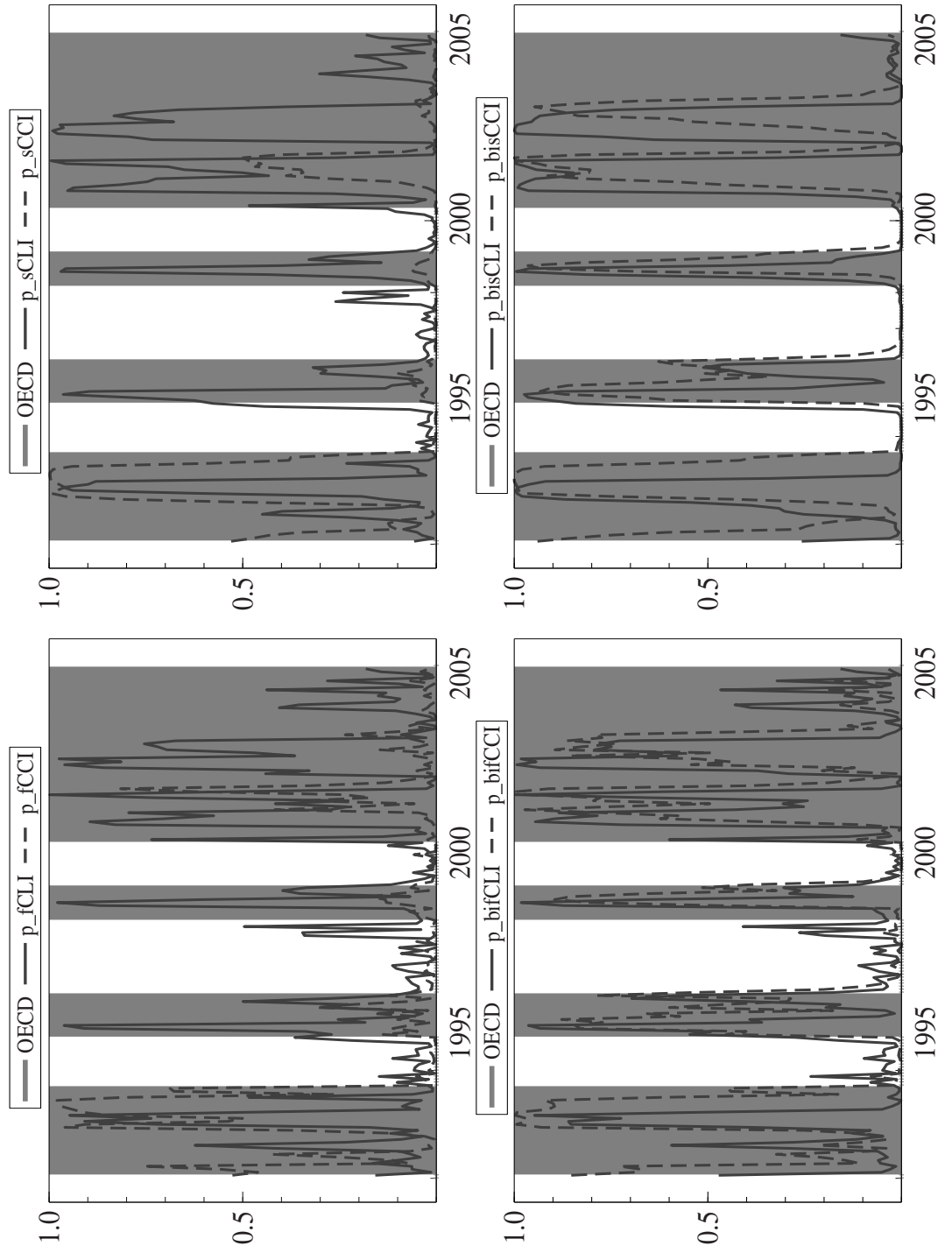

Figure 11: Recession probabilities of the single- and bi-factor models for Germany vs. cyclical chronology of the ECRI (growth cycle), 1991:1-2005:3

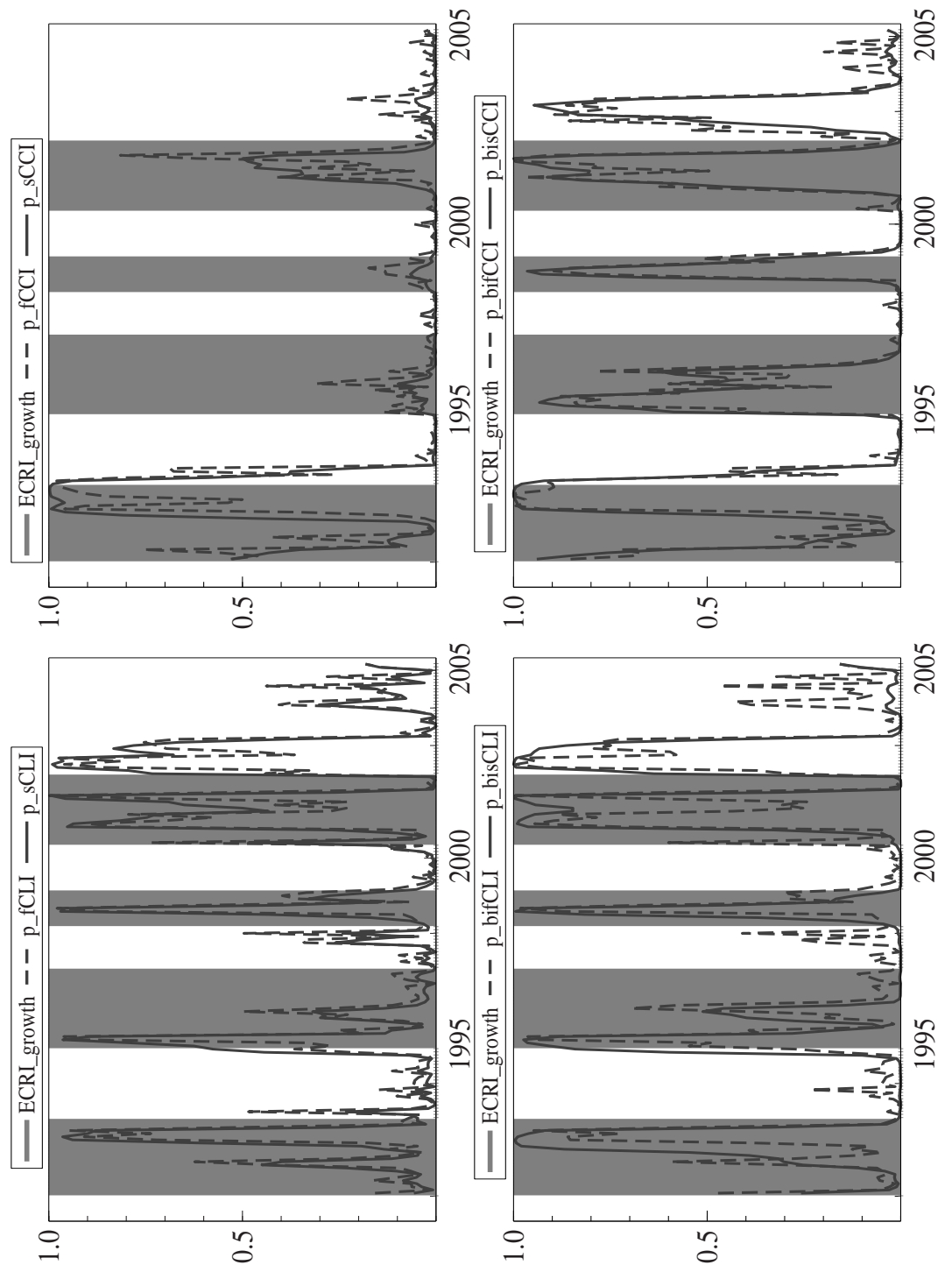

Figure 12: Recession probabilities of the single- and bi-factor models for Germany vs. cyclical chronology of the BBQ (classical cycle), 1991:1-2005:3

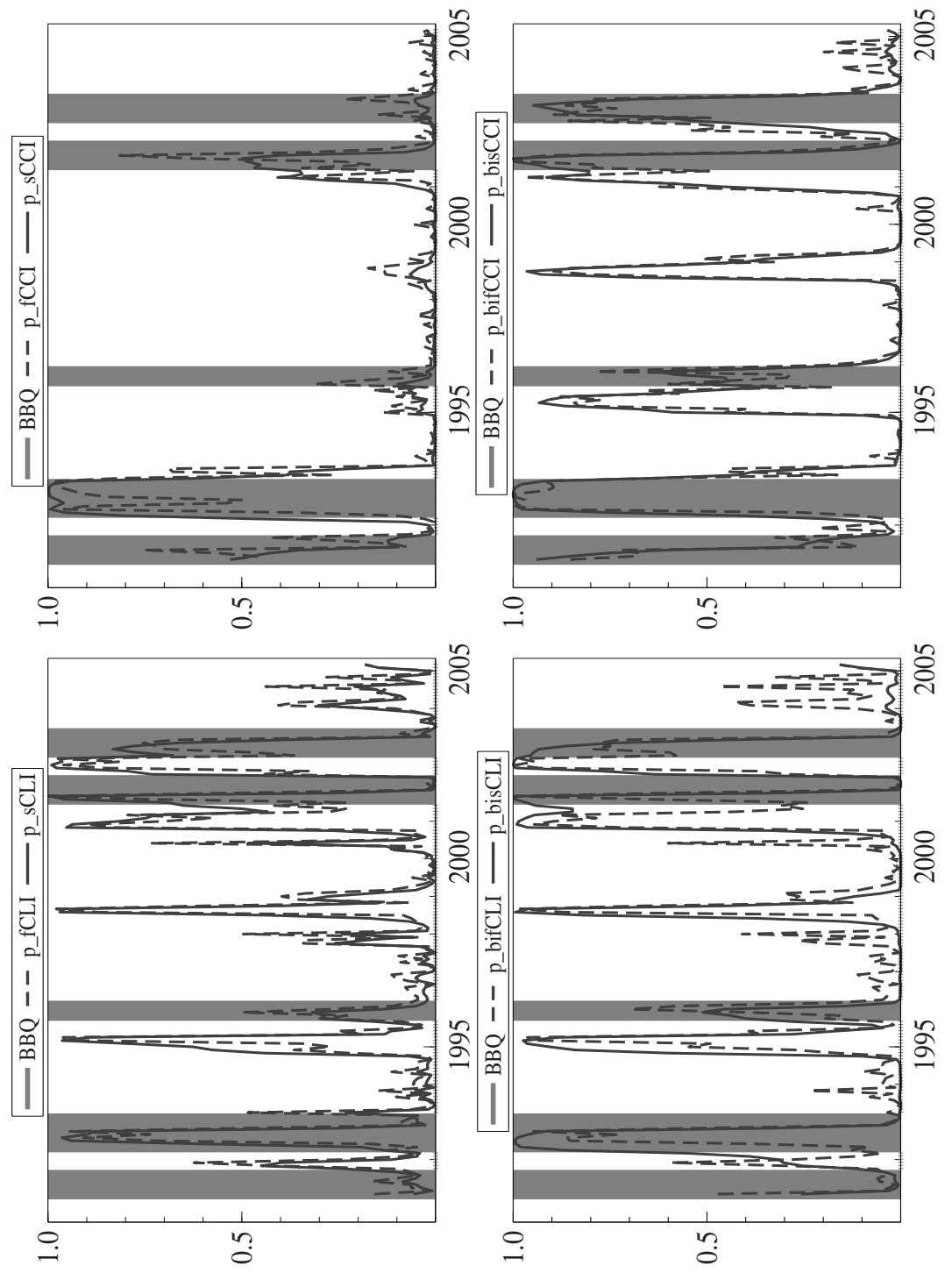

Figure 13: British CLI and CCI in levels, 1986:1-2005:3

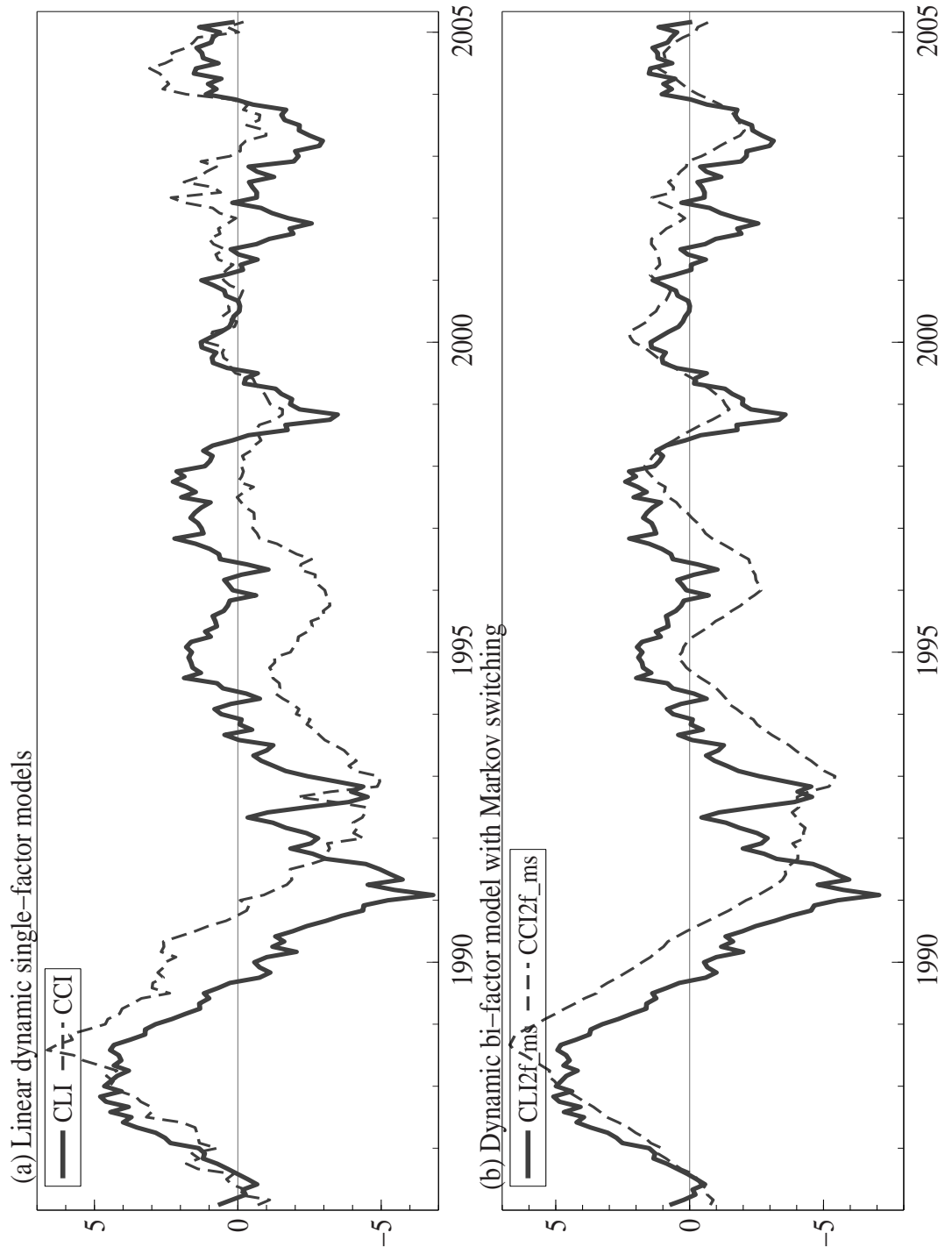

Figure 14: Recession probabilities of the single- and bi-factor models for UK vs. cyclical chronology of the OECD, 1986:1-2005:3

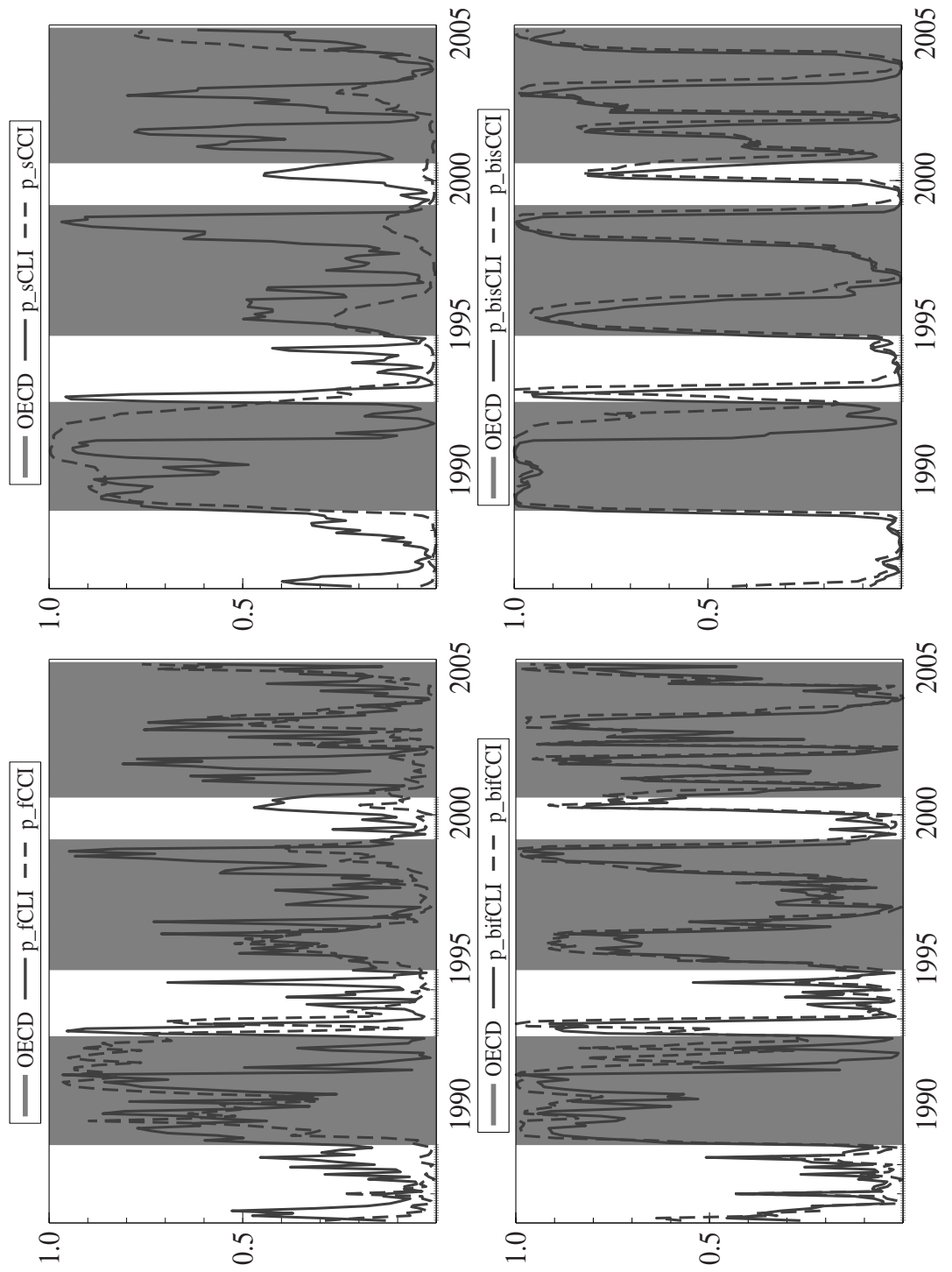

Figure 15: Recession probabilities of the single- and bi-factor models for UK vs. cyclical chronology of the ECRI (growth cycle), 1986:1-2005:3

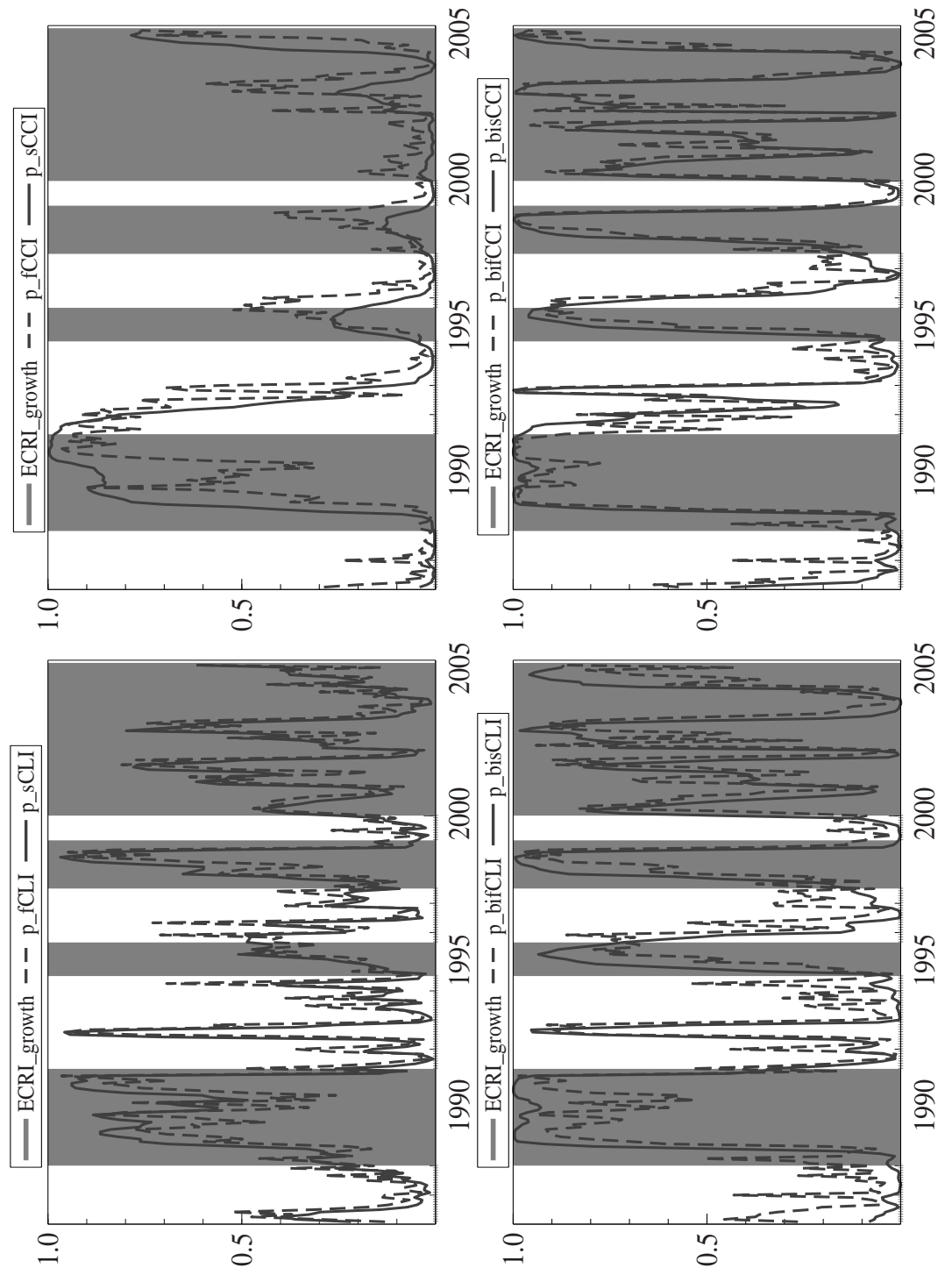

Figure 16: Recession probabilities of the single- and bi-factor models for UK vs. cyclical chronology of the BBQ (classical cycle), 1986:1-2005:3

