

Dreger, Mirka (Ed.); Huenninghaus, Anke (Ed.)

Working Paper

Social research on transformation in developing countries: Results of interdisciplinary PhD-school participants

IEE Working Papers, No. 171

Provided in Cooperation with:

Institute of Development Research and Development Policy (IEE), Ruhr University Bochum

Suggested Citation: Dreger, Mirka (Ed.); Huenninghaus, Anke (Ed.) (2003) : Social research on transformation in developing countries: Results of interdisciplinary PhD-school participants, IEE Working Papers, No. 171, ISBN 3-927276-57-X, Ruhr-Universität Bochum, Institut für Entwicklungsforschung und Entwicklungspolitik (IEE), Bochum

This Version is available at:

<https://hdl.handle.net/10419/183525>

Standard-Nutzungsbedingungen:

Die Dokumente auf EconStor dürfen zu eigenen wissenschaftlichen Zwecken und zum Privatgebrauch gespeichert und kopiert werden.

Sie dürfen die Dokumente nicht für öffentliche oder kommerzielle Zwecke vervielfältigen, öffentlich ausstellen, öffentlich zugänglich machen, vertreiben oder anderweitig nutzen.

Sofern die Verfasser die Dokumente unter Open-Content-Lizenzen (insbesondere CC-Lizenzen) zur Verfügung gestellt haben sollten, gelten abweichend von diesen Nutzungsbedingungen die in der dort genannten Lizenz gewährten Nutzungsrechte.

Terms of use:

Documents in EconStor may be saved and copied for your personal and scholarly purposes.

You are not to copy documents for public or commercial purposes, to exhibit the documents publicly, to make them publicly available on the internet, or to distribute or otherwise use the documents in public.

If the documents have been made available under an Open Content Licence (especially Creative Commons Licences), you may exercise further usage rights as specified in the indicated licence.

Mirka Dreger and Anke Huenninghaus

**Social Research on Transformation in
Developing Countries**

**Results of interdisciplinary
PhD-School participants**



Band 171

**Institut für Entwicklungsforschung
und Entwicklungspolitik
der Ruhr-Universität Bochum**

Bochum 2003

IEE Working Papers

171

Mirka Dreger and Anke Huenninghaus (Eds.)

Social Research on Transformation in Developing Countries
Results of interdisciplinary PhD-School participants

Copyright 2003

Herausgeber:

© Institut für Entwicklungsforschung und Entwicklungspolitik
der Ruhr-Universität Bochum
Postfach 10 21 48, D-44780 Bochum

E-Mail: ieeoffice@ruhr-uni-bochum.de
<http://dbs.ruhr-uni-bochum.de/iee/php/index.php>

ISSN 0934-6058
ISBN 3-927276-57-X

CONTENTS

Contents	i
Illustrations, Tables, and Figures	ii
Abbreviations	iii
Foreword and Introduction, Wilhelm Löwenstein.....	1
A Empirical Studies	3
A.1 Management of the “Biosphere Reserve Issyk-Köl” in Kyrgyzstan. An Actor-Oriented Survey with the Help of the Theory of Structuration, Anke Huenninghaus.	3
A.2 Promoting an Uncertain Democratization Process: The European Union and Zimbabwe, Armin Nolting	17
A.3 Affirmative Action in South Africa and Namibia: Transforming the Workplace or Maintaining the Status Quo? Sabine Schmid	39
A.4 Encountering Transition in Contemporary Uzbekistan – A Critical Perspective on Foreign Aid and Non-Governmental Organizations, Andrea Berg	51
A.5 A Call for Development Partnerships in the Framework of Current Decentralization Processes in West Africa (case study Benin), Mirka Dreger	65
B Methodological Studies.....	77
B.1 Control fit and autocorrelation in binary logistic regression: Explaining Democracy by Human Capital, Stefan Karduck	77
C Perspectives	87
C.1 The Relation of Macro-Level and Micro-Level: Five Perspectives, Mirka Dreger and Anke Huenninghaus	87
C.2 Empirical Social Studies in Developing Countries: Five Perspectives on Field Research, Armin Nolting.....	93

Illustrations, Tables, and Figures

Illustration 1: Relations of actors in the project	
“biosphere reserve Issyk-Köl”	9
Table 1: Representation of Formerly Disadvantaged Groups by Occupational Category in South Africa for 2000	46
Table 2: Indexing <i>SPELL</i>	82
Figure 1: Cross-national regression	78
Figure 2: Logit functions	80
Figure 3: Grouping	81
Figure 4: <i>T</i> against <i>DEMO</i>	82
Figure 5: <i>SPELL</i> against <i>DEMO</i>	82
Figure 6: <i>T</i> against <i>DEMO</i>	83
Figure 7: <i>SPELL</i> against <i>DEMO</i>	83
Figure 8: Result chart I	84
Figure 9: Result chart II	84
Figure 10: Result chart III	85
Figure 11: De-standardized function	85
Figure 12: Expected probabilities	86

Abbreviations

ACP	African, Caribbean, and Pacific Countries
BMZ	German Ministry for Economic Cooperation and Development
BMF	Black Management Forum
BTSCS	Binary Time-Series-Cross-Section Model.
CSO	Civil Society Organization
CFSP	Common Foreign and Security Policy
DC	Developing Countries
DG	Directorate General
EC	European Community
ECA	Economic Commission for Africa
EPC	European Political Cooperation
EU	European Union
GTZ	Deutsche Gesellschaft für Technische Zusammenarbeit
HC	Human Capital
IFI	International Financial Institution
ILO	International Labor Organization
LO	Local Organization
MDC	Movement for Democratic Change
SME	Medium-sized Enterprises
NCA	National Constitutional Assembly
NEDLAC	National Economic and Labor Council
NIP	National Indicative Program
LNGO	Local NGO
NGI	Non-Governmental Individuals
OSCE	Organization for Security and Cooperation in Europe
PPP	Public-Private Partnerships
TACIS	Technical Assistance (Program for the EU) for the Countries of Independent States
TEC	Treaty of the European Community
TEU	Treaty on European Union
TIZ	Transparency International Zimbabwe
TDA	Transition Data Analysis
SAP	Structural Adjustment Plan
SCR	Common Service for External Relations
UNESCO	United Nations Organization for Education, Science, and Culture
UNDP	United Nations Development Program
USAID	US Agency for International Development
ZANU	Zimbabwe African National Union
ZAPU	Zimbabwe African People's Union
ZANU-PF	Zimbabwe African National Union-Patriotic Front
ZOPP	Objective Oriented Project Planning

Foreword and Introduction

Wilhelm Löwenstein

Executive Director

Institute of Development Research

and Development Policy

Striving for a PhD at a German university is traditionally an effort taking place in isolation. PhD-students focus strongly on their individual thesis, quite often without having an institutionalised platform for scientific exchange either with colleagues from the own or from neighbouring disciplines or with experts from outside. Such platforms were initiated by the Deutsche Forschungsgemeinschaft (DFG) in the late 1980ies by issuing a program for the support of interdisciplinary PhD-schools at German universities.

Since 1992 the Institute of Development Research and Development Policy (German abbreviation: IEE) of the Ruhr-Universität Bochum hosts such an interdisciplinary PhD-school under the main title „System Efficiency and System Dynamics in Developing Countries“ with DFG’s generous support. Within the school, students holding a postgraduate degree in economics, law, geography, Islamic and East Asian studies, political science and sociology follow - under the guidance of scientists from the named disciplines - a three phase program aiming at creating a common knowledge base by especially designed seminars from the different disciplines involved in the first year, deepening the expertise in that specific area of humanities which promises the most solid fundament for the chosen topic of the PhD-theses and preparing field research in a developing country in working groups and seminars and doing the field-trips in the second year, integrating the results of research in the third year and discussing them in-group or with external experts.

This book is an attempt of documenting the results from interdisciplinary cooperation within the second intake of IEE’s PhD-school from the viewpoint of the PhD-students. Under the above main heading of the school students of this second cohort were working on the “Micro-Foundation of Macro-Processes of Economic, Legal and Social Reform” at their individual PhD-thesis. Six of those, all of them joining the school right at the beginning of the second intake, decided to systematically work out the value added of interdisciplinary cooperation in the PhD-school on the bases of their individual PhD-projects.

These projects cover a wide range of topics reaching from approaches of sustainable development in Central Asia over Affirmative Action policies in Southern Africa employing such different methodologies as open interviews and econometric Logit-models to find answers to the main research questions. Six of these individual projects - all of them successfully broad to an end in the course of the years 2001 and 2002 - are shortly described in the chapters A and B of the book. These descriptions give insights to

the main research questions, the theoretical background, methodological issues and the main results of the thesis.

Section C.1 presents - as a somewhat contextual conclusion - the common and sometimes the diverging perspectives of the thesis concerning the research done on the interaction and interdependence of micro- and macro-level actors in economic, legal, political, social transformation processes in developing countries.

An important part of the PhD-education as well as of the thesis themselves is empirical research in countries of the East and the South. The lessons learned, presented in section C2, include reflections on the need for pre-field research contacts, methods of data gathering and processing as well as on the perception of the role a Northwestern researcher is playing when starting with qualitative social research in a cultural setting quite different from the one s/he is used to. The reader looking for a checklist of the do's and don'ts of empirical research would not find it in this book. What can be found are lessons learned which might be useful to reflect upon when a young researcher is planning research in the field.

The book is equally interesting for those planning to run an interdisciplinary PhD-school as it presents some expected but also some surprising but in any case unfiltered views of participants vis-a-vis the challenge of reforming the education at the PhD-level in Germany by reducing individual isolation and broadening the disciplinary scope of the students.

A Empirical Studies

A.1 Management of the "Biosphere Reserve Issyk-Köl" in Kyrgyzstan. An Actor-Oriented Survey with the Help of the Theory of Structuration.

Anke Huenninghaus

A.1.1 Introduction

In international development cooperation, it is important to recognize the relation of environmental protection and development.¹ Because of the human use of nature, many ecosystems are nowadays dependent on human activities and therefore the result of human decisions.² Concepts of "harmonizing" man and nature are now emerging. With the help of biosphere reserves, valuable ecosystems are to be protected for humankind worldwide. These biosphere reserves are model regions of sustainable land use where, together with the people who live in such a reserve, concepts of protection, maintenance, and development are to be found and implemented. A biosphere reserve should contribute to ecologically oriented³ socio-economic development. The UNESCO defines the rules for recognition as a biosphere reserve. They are flexible but include requirements. The observance of these requirements calls for some prerequisites, such as infrastructure, staff, and environmental capacities, which third-world country applicants often cannot afford. Hence the question arises as to the appropriateness and transferability of global concepts (like biosphere reserves) which are defined by supranational organizations such as the UNESCO. If such a global concept is transferred into a national context, it is necessary to integrate this concept into the existing economic, political, and social structures. Further, it is of interest how the integration of such a global concept in these structures occurs and whether a biosphere reserve can contribute to ecologically oriented socio-economic development in the nation in question, which, in the case of Kyrgyzstan⁴, is influenced by the process of post-socialist transformation.

To answer these questions, a case study about the Kyrgyzstan project "biosphere reserve Issyk-Köl", which the German development organization GTZ⁵ has supported since 1995, was carried out.⁶ The aim of the project, in the phase I surveyed for my dissertation, was to

¹ Development is defined as an ongoing process of transformation of natural environment in an artificial environment. In this process goods, and services are developed which contribute to the spread of prosperity and economic productivity. At this juncture, the ability of the environment to bear such a development is reduced (Sunkel, quoted from Hein 1992: 8, transl. by the author).

² Giddens 1996: 147

³ An ecologically oriented development tries to avoid destroying the natural source of life for future generations (cf. Ständige Arbeitsgruppe der Biosphärenreservate 1995).

⁴ Kyrgyzstan is a Soviet successor state located in central Asia and bordering on China in the East, Kazakhstan in the North, and Uzbekistan and Tajikistan in the South-West. Kyrgyzstan became independent in 1991. During the process of transformation, the Soviet institutions have been replaced by new formal institutions such as market economy, democracy, etc. This process is marked by a breakdown of the macro economy and a strong increase of poverty (World Bank 1994).

⁵ Deutsche Gesellschaft für Technische Zusammenarbeit GmbH (German society for technical assistance). The GTZ carries out projects for the German Ministry for Economic Cooperation and Development (BMZ)

⁶ The data was collected by interviews during a four-month field survey which was conducted in summer 1999. My investigations concentrate on the time frame from 1993 (the first idea of establishing a biosphere reserve) until spring 2000 (closing of collecting data) (cf. Hünninghaus 2001).

support the efforts of the Kyrgyz government for the recognition of the "biosphere reserve Issyk-Köl" by the UNESCO with the help of certain project measurements such as the implementation of ecologically oriented small-scale projects in model villages of the future region of the biosphere reserve. But before the concrete measurements of the project could be implemented, governmental negotiations had to be carried out to set the institutional frame of the project, to fix the working conditions, and ultimately to negotiate and fix the objectives of the project so as to achieve the main aim of the project phase under investigation, which was the recognition of the "biosphere reserve Issyk-Köl" by the UNESCO, whereas in the long run the project's general objective was to support sustainable ecologically and socio-economically oriented development in East-Kyrgyzstan.

It is assumed that specific actors and their actions had great influence on the course of the project. Therefore, an actor-oriented approach was chosen. The actors who have been involved in the project and in the international negotiations were the focus of my research and are now the focus of the following article. First, with the term "actors" the members of the GTZ and the Kyrgyz Ministry of Environmental Protection⁷ are meant. Second, given the fact that participation plays an important role in the concept of biosphere reserves, the actors in the model villages on local level (who are the addressees of the project activities) and their points of view are also important. Further, it is assumed that either the current conditions of post-socialist transformation or the structures resulting from historical developments influence project implementation. From this viewpoint, the project "biosphere reserve Issyk-Köl" is treated as part of the process of post-socialist transformation.

A further aim of my dissertation was to discover indicators for international development cooperation in Soviet successor states, which will be discussed in the final part of this article. Generally, the main target of most German development cooperation projects and programs is to create the institutional framework for international and binational cooperation, to strengthen so-called "support structures" for development and of transformation to democracy.⁸ These activities are referred to as *capacity development*⁹ in the current debate on development cooperation. The precondition for *capacity development* is the understanding of the complex structures of a society and its institutions. Within this concept the post-Soviet society and its institutions are to become accustomed to "western" logic and ways of thinking. The aim is to create a basis for communication and mutual understanding for international cooperation. From the same perspective, the actors and their actions are the main source of interest. By attempting to understand and interpret individual actions and the context of the actions of actors who were involved in the project "biosphere reserve Issyk-Köl", it was hoped that assertions relative to *capacity development* in Soviet successor states can be derived.

This article consists of the following chapters: In chapter A.1.2 my understanding of transformation is explained and an appropriate theory is derived capable of explaining the relation of structures (marked by the process of transformation) and actions (which are assumed to be of interest for the specific course of the project) and which can help interpret

⁷ The BMZ and the UNESCO have only been indirectly involved.

⁸ Cf. GTZ 2000

⁹ Within the process of capacity development humans are to be strengthened in their ability to act and organizations in their ability to function. The GTZ speaks of capacity development as their core work. Sustainability of development projects might be supported through capacity development (cf. Giesen, van der Molen 1993).

the results of my field work. The third chapter (A.1.3) analyses my fieldwork with the help of Anthony Giddens' theory of structuration. This chapter is divided into two parts:

1. the negotiations on the national level to carry out a project in common and to build the institutional frame for recognition of a biosphere reserve by the UNESCO and
2. the description of the current situation of life in the model villages in the region of the future biosphere reserve Issyk-Köl and its meaning for the implementation of small projects which have been established to introduce and test ecologically and socially appropriate forms of land use.¹⁰

The fourth chapter (A.1.4) concludes and discusses the specific problems of implementing development projects in Soviet successor states.

In the following descriptions, the theory and its terms are always interlinked with the text. Giddens' has created neologisms for his theory which are explained here in footnotes. I would like to stress that the theory cannot be explained in this article, but I hope the theory's principle concepts become clear within the following descriptions.

A.1.2 Transformation and biosphere reserve: theoretical implications

The transformation of a Soviet successor state differs from other transformations because not only is a planned economy transformed into a market economy but the socialist society is also transformed into a democratic society. Therefore, the transformation takes place in all spheres and on all levels (economy, political system, institutions, culture) of the society. The whole structure of society changes. Furthermore, the interests and actions of actors greatly influence the process of transformation of Soviet successor states. The process is marked by the old nomenclature's struggle for national independence, return to communism, or simply the individual career.¹¹ Therefore, transformation is understood here as a multi-level process which, as Kollmorgen¹² stresses, refers to changes on the macro level via the meso level down to the micro level and is further characterized by the purposefulness of actors¹³.

The project "biosphere reserve Issyk-Köl" can be seen as part of the transformation process. As the complex transformation process is formed by actions of actors situated at different levels of society (micro, meso, macro) and in different sectors (i.e. economy, politics, science), the project is marked by the influence of a certain constellation of actors who come from distinctive administrative levels and a certain sector and therefore have different working backgrounds¹⁴.

¹⁰ The small projects will not be further described in this article. For this, see my Dissertation (Hünninghaus, 2001).

¹¹ Reißig 1994: 12

¹² Kollmorgen 1994: 385

¹³ Cf. Reißig 1993

¹⁴ Professional background defines social position, the so-called positioning. The term positioning, which is central in Giddens' work (1984: 83ff, 1997:137ff) (because social position is connected with institutionalized practices and structures of interaction and involves the specification of a definite "identity" within a network of social relations), contributes to the understanding of actions.

For such an actor-oriented view, a matching theory must provide categories which link the actors as well as the frame conditions (structures) and the micro, meso, and macro level to each other. With Giddens' theory of structuration (1984, 1997) this seems to be possible: By connecting action and structure (the duality of action and structure), Giddens developed a means of analyzing individual actions as well as social processes. This theory is suitable for the analysis of transformation processes because human actions and the reproduction of social structures are recursively connected. With the help of this theory, it is possible to set social processes on the micro, meso, and macro level in relation to each other. Structure has no connection to structuralism, as Giddens stresses.¹⁵ The term structure must be understood in reference to a subject (subjectively). Structure exists only as the reproductive behavior of people who act, and structure and action are recursively related. Giddens defines structure as organized sets of rules and resources that are produced and reproduced through human action. These actions influence and direct social processes and reproduce structures by acting. The continuity of structure depends on the knowledge of human actors who concretize and reproduce routine patterns of social life through their thoughts and actions. Through their actions, human actors are the agents of structural reproduction, which gives them the ability to transform. This understanding of the interconnection between structure and action helps us comprehend the relation of frame conditions and individual action and makes it possible to analyze institutions and a society's so-called "rules of the game".¹⁶

A.1.3 Results of the field research

A.1.3.1 The structuration of the intercultural negotiations for the project "biosphere reserve Issyk-Köl"

Every society has its own rules and institutions, which the action of their members shape in long run. In institutions, or in Giddens' terminology "structural principles"¹⁷, the present is connected with the past and helps structure the actions of the future. Institutions reveal the specific history of every society. This is also true of rules and styles of communication. In a negotiation process, which requires much coordination and cooperation, the status of communication is very high. Cultural norms and structural principles shape communication. Because of different cultural contexts, different styles of social interaction, and different social positions of the actors who were involved in the project, their forms of communication are different, not only in a linguistic manner but also stylistically. Due to this, difficulties in intercultural negotiations can arise, as will be shown in the following descriptions.

The context in which the project "biosphere reserve Issyk-Köl" was implemented and the negotiations took place was defined by hierarchical structures and concessions of the Kyrgyz and German actors concerned with resources and rules.¹⁸ Due to their socialization under

¹⁵ Cf. Giddens 1997

¹⁶ North 1990

¹⁷ Structural principles: "Principles of organization of societal totalities; factors involved in the overall institutional alignment of a society or type of society" (Giddens 1984: 376).

¹⁸ Resources are mediums of performance power which are included in institutions. Rules implicate methodical procedures of social interaction.

the Soviet system, the properties¹⁹ and principles of structure relevant for the Kyrgyz actors differed from those of the German actors. They acted based on an inherent logic which the German actors could not always understand. The Kyrgyz project participants acted based on their specific world view, which is shaped by historical as well as current patterns and structures. Inasmuch as every human and every society have their own institutions, they have their own routines as well. Routinization²⁰ is important for building a familiar environment with familiar styles of attitudes basic for ontological security. Routines help structure everyday life.²¹ Because of the specific Kyrgyz routines, which are strongly influenced by the Soviet system, it was difficult for the Kyrgyz negotiations participants to adapt to the logic of the Germans' understanding of project implementation and planning. With the help of the term routinization the reactions on the part of the Kyrgyz and their refusal to take part in the negotiations in a constructive way at the beginning of the project can be understood. The style of project planning of the GTZ came into conflict with their own routines, shaped by Soviet education. On the other hand it was also difficult for the Germans and their specific routines to understand the Kyrgyz strategy of refusal and to get used to Kyrgyz reactions and habits.

The problems of communication between the Germans and Kyrgyz were also caused by diverse understandings and meanings of planning (which are part of different structural principles²²). The Kyrgyz' understanding is marked by the Soviet centrally planned economy, in which the objectives of development were defined by the state. Therefore, the Kyrgyz actors know planning only as dictate. The Kyrgyz representatives were not willing (and, possibly because of the Kyrgyz identity and logic which still influence their actions, not able) to replace the Soviet system of planning with a German system. A state that was formerly defined by the Soviet ideology was now to be given the power to shape the planning process. Therefore, the Kyrgyz were touchy about GTZ interference as it criticized the routine processes and therefore the ontological security of the Kyrgyz actors. One can also assume that the German as well as the Kyrgyz actors argued on different analytical levels within the process of negotiations: the objective level was sometimes mixed with the emotional level. All participants in the negotiations have a cultural identity and ontological security. It can be seen that mutual understanding and acceptance are strained in intercultural negotiations and seem to be only to a certain extent possible.

Moreover, there were different development targets (economic development on the one hand and nature conservation on the other) which were expressed by diverse subjective interests of land use and development.²³ This made the negotiations more difficult. In this context, it is helpful to consider the terms allocative and authoritative rules and resources.²⁴ According to Giddens, they are important for the analysis of power. Actors on both sides have resources as well as rules which they brought into the project. The specific logic of

¹⁹ Structural properties: "Structured features of social systems, especially institutionalized features, stretching across time and space" (Giddens 1984: 377).

²⁰ Routinization: "The habitual, taken-for-granted character of the vast bulk of the activities of day-to-day social life; the prevalence of familiar styles and forms of conduct, both supporting and supported by a sense of ontological security" (Giddens 1984: 376)

²¹ Cf. Giddens 1984, 1997

²² Cf. Giddens 1984, 1997

²³ Within the process of transformation the principle interest is laid on economic development.

²⁴ Cf. Giddens 1984, 1997

GTZ planning - its rule - stands in opposition to the rule on the Kyrgyz side: the power of implementation. That means the Kyrgyz state has the authoritative power to implement the biosphere reserve in its area. The GTZ as well as the Kyrgyz side had performance power options. The imbalance in the nature of the resources (GTZ: more allocative resources like money, Kyrgyz Ministry of Environmental Protection: more authoritative resources) hampered the negotiations. But due to the dialectic of power, it was possible to reach an agreement. Each side was also interested in the resources of the other side (GTZ was interested in implementing the project successfully and the Kyrgyz actors were interested in investments in the form of environmentally friendly technologies and international reputation).

The following illustration (1) shows the (power-) relation of organizations and actors involved in the project. It shows the relations of rules, resources, and interests. The terms are defined here as follows: with the help of rules, the preconditions for the cooperation are set. The actors can provide resources. Their interests lead actors to pursue dissimilar targets. Rules, resources, and interests define the interaction and the dependence of the actors.

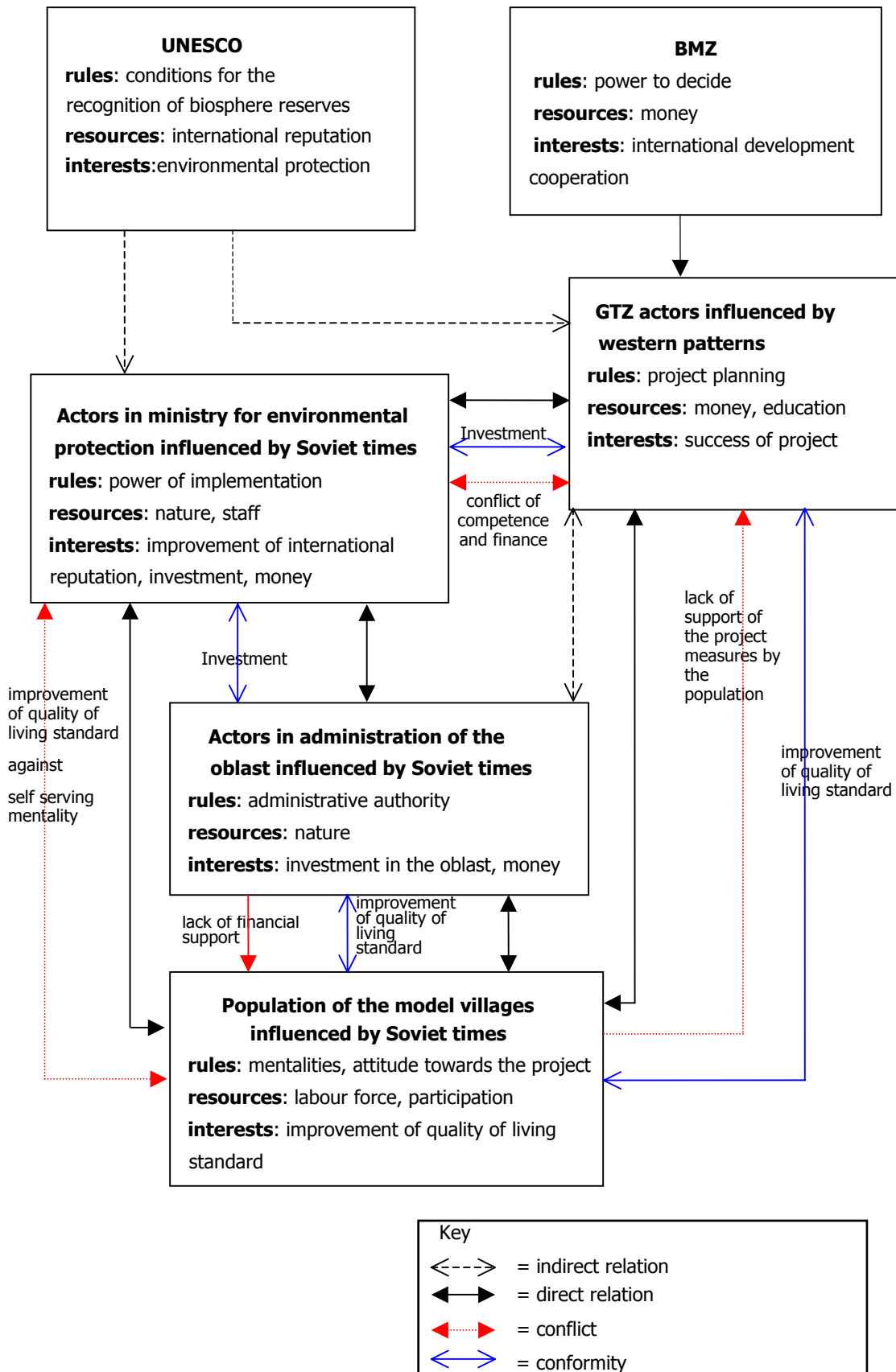

Illustration 1: relations of actors in the project "biosphere reserve Issyk-Köl" (own source)

One main problem which also hampered the negotiations was that, with every change of the Kyrgyz director, the whole staff was replaced (three times from 1994-1998). The decisions to engage new personnel were marked by nepotism and not by professional knowledge. Nepotism can be called a structure principle and is deeply rooted in Kyrgyz society. Through nepotism, networks are built which are distinguished by mutual obligations. The lack of law and order within the process of transformation is checked by the institutional security of nepotism. One can rely on relatives and, whenever necessary, performance sanctions. Kyrgyz society structural properties²⁵ have survived and serve, apart from the constitution of institutional security, to maintain ontological security. For the German representatives, these personnel decisions marked by nepotism were difficult to follow. Furthermore, the Germans had to adjust to new partners whenever the Kyrgyz project director changed making trustful cooperation difficult.

Moreover, the structuration theory facilitates the analysis of specific individuals' influences on the course of the project. The Kyrgyz actors have different professional backgrounds (architect, scientist, professor, mayor) which defined their social position and their behavior during the negotiations. These job-related characters could be called structural principles in a wider sense. A job-related logic of actions develops here. The term positioning, which is central in Giddens' work²⁶ (because the social position is connected with institutionalized practices and structures of interaction and involves the specification of a definite "identity" within a network of social relations), contributes to the understanding of actions. The social position, which is marked by the professional background, structured the negotiations and defined the specific relation of the actors to the objectives of the project (more scientific approach, more political approach, more economic approach). The actors' social position had immense influence on their attitude towards the project. Some Kyrgyz actors tried to push the project in "their" direction.

In addition, it is important to mention the influence of charismatic persons, such as Tschingis Aitmatow²⁷, who positively influenced the Minister for Environmental Protection's disapproving attitude, or an important BMZ²⁸ actor, who had a supportive attitude to the project, and - last but not least - Prof. Succow²⁹, without whom and without whose good contacts the implementation of a biosphere reserve in Kyrgyzstan would never have come about. Within a society's structures, these key persons have great importance because they belong to different networks and have great authoritative power and access to resources. Their influence on the project was immense.

Overall, the troubles during project planning and implementation are an example of the difficulties which can arise when western patterns are transferred to another cultural context where a different rationale is valid. In countries without experience of democracy, where administrative work is centralized, and where participation of all interest groups is yet not institutionalized, negotiations proceed according to their own rules. The collapse of the

²⁵ Cf. Giddens 1984,1997

²⁶ Cf. Giddens 1984: 83ff, 1997:137ff

²⁷ Tschingis Aitmatow is a famous Kyrgyz writer. He is now working as an ambassador for Kyrgyzstan in Luxembourg.

²⁸ Bundesministerium für wirtschaftliche Zusammenarbeit und Entwicklung (Ministry for economic cooperation and development)

²⁹ Prof. Succow is a botanist and recipient of the alternative Nobel price. His ambition is to preserve nature, especially in the Soviet successor states.

Soviet system and structural order causes ontological insecurity which endangers or even destroys individuals' routines. That made the people feel insecure. This insecurity leads them to cling to traditional patterns of actions. The actors on a national level are still strongly influenced by the Soviet system. Due to this, it is difficult for them to adapt rapidly to a system of planning marked by democratic rules, such as the GTZ planning system.

The process of transformation requires an adaptation of traditional structures and individual patterns of action to the new circumstances. The changes of the old structural principles, which were a guarantee for ontological security, now create a gap for the people, which has to be bridged with new orientation. This reorientation can be established by the state by means of new institutions, but achieving reorientation at the individual level takes longer, as individuals can only change their routines slowly by means of new principles. This also holds true for the findings of my field work on the local level, which can be seen in the next chapter.

A.1.3.2 Structuring of life in the three model villages of the project "biosphere reserve Issyk-Köl"

This chapter will explain how the current situation in post socialist Kyrgyzstan influences the actions of the local inhabitants of the three model villages and their attitude towards the small projects in their villages established within the project "biosphere reserve Issyk-Köl".

As already mentioned, during the current upheaval on the way from a planned to a market economy, there is a lack of informal rules and social practices towards newly established institutions such as market economy. The creation of the so-called "Homo Sovieticus" depending on and guided by the state was somehow successful. Therefore, an institutional gap now exists which the people can only slowly bridge. They had adapted to the supply network of the Soviet state and are now confronted with the difficult task of self supply. But if structural properties and institutional arrangements have to be re-established by individual actions, it takes much longer than if they were imposed by force, as under the Soviet system. New formal institutions (i.e. free market) are established by the state, but without any preparation of authoritative and allocative resources as well as without definition of rules.³⁰ Therefore the reflexive introduction of new informal institutions into individual actions and the process of routinization take a longer time since rules and resources are necessary to change or maintain social systems. At present, everyday life is marked by concern about the future and insecurity. To avoid risks, most people I met remain in waiting. They still hold on to well known actions and do not take any initiative to change their current situation. I often heard in my interviews: "What shall we do? We are sitting and waiting for better times." This "waiting attitude" also becomes evident in a defensive attitude towards private property, credit, or migration. Private property, for example, means responsibility which most of the people are not willing to assume because of current structural insecurity. Moreover, under the Soviet system, private property was defined as capitalistic and the enemy of equality, and this attitude towards private property is still valid to some extent. In addition, most of the people do not plan forward-looking strategies of action to improve their situation. They do not have a concrete idea about their future. To my research question: "What do you think about your future" I got answers like: "I don't know"

³⁰ Cf. Giddens 1984, 1997

or "we'll see". But to develop a strategy, it is necessary to have concrete ideas about the future and the targets which are to be achieved. This indifferent attitude has a negative impact on the measures of the project because they depend on the active support by the population.

Further, the poor economic situation of the population also has negative effects on support for small-scale projects. Due to the lack of willingness and ability to participate financially in these projects, the people prevent their amortization. In addition it was evident that these small-scale projects, where the economic usefulness can be seen only in future, were considered worse.³¹

Although the Soviet system was not popular, the people miss the leadership and the security which it provided. The current state is considered as weak. It does not provide any security or any spheres of trust to protect actions and everyday life. Under a weak state, there is the danger of certain coalitions being built which only distribute the resources of the state among themselves.³² The members of these coalitions are often politicians who have access to the resources of the state. Through this distribution among themselves and their relatives, they take things away from the other members of society. This creates the danger that the members of such a coalition usurp the benefits of the small-scale projects only for themselves.

The lack of security under the current upheaval is somehow counterbalanced by the system of relatives. This system of relatives was given new emphasis (it was always important in Kyrgyz society, but now has the added dimension of providing security under a collapsing system). It also provides a possibility for economic safety and support for the Kyrgyz identity. With the system of relatives, past and present are connected and individual actions are structured. Relationship is a means of social and system integration³³ and helps to create a familiar environment fundamental for ontological security. Besides, it guarantees mutual help and creates a social net which makes the survival of all, even the poorest, possible. This makes clear that nepotism has its own inherent logic within this society, as already mentioned in chapter A.1.3.1. This should be regarded when implementing projects.³⁴

The above mentioned institutional gap is important for the implementation of small-scale projects and the "biosphere reserve Issyk-Köl" project in general, because institutional rules are indispensable for successful cooperation and a sustainable effect of project activities. The latter must be adapted to the means and possibilities of individual action so the period of gaining acceptance is not too long. Moreover, only few common activities were implemented without orders from above. The centralized structures of the former Soviet

³¹ Cf. Hünninghaus 2001: 225f

³² Cf. Pfaff-Czarnecka, 1999

³³ Cf. Giddens 1984, 1997

³⁴ Whether positive or negative depends on the current project and frame conditions. Nepotism can be positive when it guarantees reliable structures. If local members of the project were relatives of staff from the administrative level there was the advantage of social control. With the help of relatives, sanctions could be carried out. Nepotism has negative impacts if the situation goes so far as to establish coalitions which only distribute the benefits of the project among members of the family. Because nepotism is a structural property of a society and cannot be avoided within the given time frame of a project, one should try to work with, and not against, this principle.

system have weakened personal initiative.³⁵ These structures today hamper the acceptance of duties for project measures. The population's distrust of state measures, developed during the Soviet era, leads to non-identification and disbelief concerning the small-scale projects. That is the reason for the lack of support.

A.1.4 Conclusions referring to project implementation

The UNESCO concept of biosphere reserves is based on a specific view of the world which the Kyrgyz government shares only to a limited degree. The main reason for recognition of the biosphere reserve "Issyk-Köl" was the Kyrgyz government's hope of attracting investments such as environmentally friendly technologies, ecology tourism, and the creation of jobs. The economic development of the country has priority in the current process of transformation.

Because of the different interests which the applicant and the supporting organization associate with recognition of the biosphere reserve, difficulties of communication and conflicts concerning project targets came up during international negotiations. These communication difficulties were also influenced by the negotiating partners' different institutional rules. While Kyrgyz administrative structures are still marked by centralization, the Germans used procedures based on a democratic understanding of planning. This democratic view of communication and cooperation can also be found in the leading idea for the "world network biosphere reserve" of UNESCO.

Democratically marked administrative planning has still not been established in Kyrgyzstan, and a simple transfer of democratic institutions cannot break up current structures. It seems clear that pre-Soviet and Soviet patterns and world views are still valid in the transformation process. They have not yet been given up because they make life more calculable in the current upheaval.

On the local level in the concrete implementation of measures, one can in summary observe that the village population's subjectively viewed scope of action has an important influence on opinion about the small-scale projects. The lack of institutional security within the transformation process influences most village people's actions, as they are less oriented towards active changes of the current situation than to protection of and security for their everyday life. This attitude has a negative impact on project implementation and support.

In the current transformation process, structures as well as institutions are maintained or erected which allow the privileged classes to protect their interests. In the current phase of upheaval, the population of economically less attractive areas is not well supported by the state, neither with financial resources nor with regulations of actions.

Biosphere reserves are arenas of different interests and institutions. Therefore a clear institutional arrangement and an appropriate political institutional surrounding is necessary on all project levels. This shows that concepts currently referred to in the debate on development cooperation as *capacity development* are important. First of all, the institutional framework of communication, coordination, and cooperation (as important

³⁵ Whether this lack of personal initiative is due to structures from pre-Soviet times, where the "Manap" as clan leader ruled, could not be determined within my fieldwork.

prerequisites for successful cooperation, as well as the necessary capacities for implementation and sustainable support of projects) must be erected. Because this high-challenge concept of *capacity development* requires the understanding of complex social structures in a different culture and its institutional rules to change or influence them, it is necessary to obtain a deep insight into these structures and the logic of action of the actors concerned. With a deeper understanding of social structures, projects can better adapt to societal structures and starting points for *capacity development* can be found. Successful *capacity development*, of course, presumes the ability and will to learn on both sides of the project (donor and addressee). Because the personal attitudes which are marked by pre-Soviet (clan structure) and Soviet times (command structure) are changing only slowly and the personal possibilities to change ones attitude is present only to a certain degree, the patterns of behavior and the structure of two different political systems (democratic and centralized) still coexist during implementation. This leads to implementation ineffectiveness. Moreover, the centralized structure of planning still hampers the coordination and cooperation of different environmental authorities and organizations, especially on the local level, which would be necessary for successful capacities development in the environmental sector. Development cooperation measures (not only in Soviet successor states) require one important resource which is often not available: time.³⁶

We can sum up:

- Institutional rules necessary for long-term support of small-scale projects on the local level were destroyed or modified by the Soviet system:
 1. Protection of natural resources: Destruction of informal institutional rules by industrially oriented and centrally planned agriculture.
 2. Strategies of action: Because of institutional insecurity, a passive attitude and risk minimization mark the people's current attitude.
 3. Social networks: informal institutional rules are kept intact by strong ethnic identity and the relative system.
- Because of the "dilemma of simultaneousness", which is a feature of the transformation process (transition from a planned economy to a market economy as well as transition from a socialist society to a democratic society), long-term support for a biosphere reserve still overburdens Kyrgyzstan's capacities.
- Economic development has priority over environmental protection; conflicts concerning the targets of the project emerged.
- As a result of the Soviet era, another attitude to the protection of nature and another understanding of planning still exist in Kyrgyzstan. Misunderstandings and misinterpretations arose between Kyrgyz and Germans.
- The inherent logic of planning of the ZOPP-workshops³⁷ was not adapted to the political culture and mentalities of the people on the village level.

³⁶ In the course of the discussion at the "Eschborner Fachtagen 2000", it also became clear that different opinions exist concerning the time problem. Some argued that only long-term programs could meet the needs of time. Others mentioned that small single projects are more flexible and can better react to changes in societal structure (cf. GTZ 2000).

³⁷ ZOPP is the abbreviation for „objective-oriented project planning“, a special method of participatory project planning created by GTZ (cf. GTZ 1991).

- The people of Kyrgyzstan are used to a centralized command structure of planning. Therefore, they are overburdened by long-term self-reliant support for small-scale projects.

Despite these problems, the objective of the surveyed phase of the project was reached and the "biosphere reserve Issyk-Köl" was recognized by UNESCO in 2001. But the question must be raised as to whether the "biosphere Issyk-Köl" can contribute to a sustainable ecologically and socio-economically oriented development in Kyrgyzstan given the lack of a supporting political-institutional environment, the lack of support by the local population, as well as the lack of financial resources which are not sufficient for long-term support and further development of the reserve.

A.1.5 References

- BARTHE, Susan / BRAND, Karl-Werner (1996): Reflexive Verhandlungssysteme. Diskutiert am Beispiel der Energiekonsensgespräche. In: Verhandeln und Argumentieren. Dialog, Interessen und Macht in der Umweltpolitik. Edited by Volker von PRITTWITZ. Opladen.
- GIESEN, Anne / MOLEN van der, Irna (1993): Institutional Capacity for Environment in the North-West Frontier Province. Pakistan. Enschede. unpublished.
- GIDDENS, Anthony (1999): Konsequenzen der Moderne. 3rd Edition. Frankfurt am Main.
- GIDDENS, Anthony (1997): Die Konstitution der Gesellschaft. 3rd Edition. Frankfurt am Main, New York.
- GIDDENS, Anthony (1996): Leben in einer posttraditionalen Gesellschaft. In: Reflexive Modernisierung. Edited by Ulrich BECK et al. Frankfurt/Main, pp. 113-195.
- GIDDENS, Anthony (1984): The constitution of society: outline of the theory of structuration. Cambridge.
- GTZ (2000): Menschen, Organisationen, Rahmenbedingungen: Technische Zusammenarbeit in einer globalisierten Welt. Dokumentation zu den Eschborner Fachtagen 2000. http://www.gtz.de/eschborner_fachtage/fachtage2000 (April 26, 2001).
- GTZ (1991): Methoden und Instrumente der Projektplanung und -durchführung. Eschborn.
- HEIN, Wolfgang (ed.) (1992): Umweltorientierte Entwicklungspolitik. 2nd Edition. Hamburg.
- HÜNNINGHAUS, Anke (2001) Management von Biosphärenreservaten in Transformationsländern. Dargestellt am Beispiel des Biosphärenreservats Issyk-Köl in Kyrgyzstan. Dissertation. Bochum. <http://www-brs.ub.ruhr-uni-bochum.de/net/html/HSS/Diss/HuenninghausAnke/diss.pdf>.
- KOLLMORGEN, Raj (1994): Auf der Suche nach Theorien der Transformation. Überlegungen zu Begriff und Theoretisierung der postsozialistischen Transformation. In: Berliner Journal für Soziologie, Vol. 4, No. 3, pp. 381-399.
- MINISTRY OF ENVIRONMENTAL PROTECTION, KYRGYZ REPUBLIC (1999): Environmentally Sound Land Use Development. In: The "Issyk-Kul" Biosphere Territory, Bishkek.

- NORTH, Douglas C (1990): Institutions, institutional change and economic performance. Cambridge, New York, Melbourne, pp. 3-10
- PFAFF-CZARNECKA, Joanna (1999): Verteilungskonkationen in Bajhang: Zu einem besonderen Typus von Mittlerstrukturen zwischen Staat und Bürger in (Fernwest-) Nepal. In: Peripherie, No. 73/74, pp. 77-97.
- PLANUNGSGRUPP ÖKOLOGIE + UMWELT (PÖU) (1998): Biosphärenreservat „Issyk-Köl“, Hannover.
- PRITTWITZ, Volker von (1996): Verhandeln und Argumentieren. Dialog, Interessen und Macht in der Umweltpolitik. Opladen.
- REIßIG, Rolf: (1993): Transformationsprozeß Ostdeutschland. Empirische Wahrnehmungen und theoretische Erklärungen. Berlin.
- REIßIG, Rolf (1994): Transformation -Theoretisch konzeptionelle Ansätze und Erklärungen. In: Berliner Journal für Soziologie, Vol. 3, pp. 323-343.
- SUNKEL, Osvaldo (1990): „El desarrollo sustentable: del marco conceptual a una propuesta operacional para Chile“. In: ifda dossier, no. 75/76, Jan-April, pp. 51f.
- STÄNDIGE ARBEITSGRUPPE DER BIOSPHÄRENRESERVATE IN DEUTSCHLAND (1995): Biosphärenreservate in Deutschland, Berlin et al.
- UNESCO (ed.) (1996): Biosphärenreservate. Die Sevilla Strategie und die Internationalen Leitlinien für das Weltnetz, Bundesamt für Naturschutz, Bonn.
- UNESCO (ed.): Biosphere Nomination Form. <http://www.unesco.org/mab/brnomform.htm> (10 November 2000).
- WELTBANK (1996): Vom Plan zum Markt. Weltentwicklungsbericht. Washington, D.C.
- WORLD BANK (1994): Kyrgyzstan: Agricultural Sector Review. Washington, D.C.

A.2 Promoting an Uncertain Democratization Process: The European Union and Zimbabwe

Armin K. Nolting

A.2.1 Introduction

The issues under consideration in this chapter lie at the intersection of the following three political trends: Firstly, the much cited third wave of democratization³⁸ that reached Africa³⁹ in the late 1980s and created much optimism concerning democracy's future on the continent. Here, however, one needs to concede that there is today increasingly more talk about blocked democratization and the return to autocratic practices throughout Sub-Saharan Africa. Secondly, the foreign and development policies of most democratic industrial or post-industrial countries reacted to and supported the democratization processes mentioned. The heavy dependency of many African countries on external funds was an asset that in some cases gave the international donor community enough leverage to tip the balance in favor of liberalization and democratization. The more recent development of democracy losing ground again undoubtedly poses new challenges to international democracy promoters. Thirdly throughout the 1990s, the European Union (EU) made considerable strides in establishing itself as a full scale international actor that contributed significantly to the pro-democratic trend in international relations.

By scrutinizing the European Union's promotion of democracy in Zimbabwe at the turn of the century, the three strands just outlined are brought together to achieve a better understanding of the following two issues: Firstly, the interplay between the EU's policy towards Zimbabwe at a diplomatic and contractual level and the EU's support for civil society organizations' (CSOs) projects aiming at liberalizing and democratizing the Zimbabwean society and state. Here, this chapter argues that only a consistent approach coordinated with other important external actors can result in the desired outcome, i.e. the strengthening of democratic forces and an improvement of the human rights situation. The second issue to be looked at more closely lies in the processes of planning and implementing positive measures in favor of democracy. Here it is argued that a rapid and efficient handling of administrative matters is as important as the establishment of a trust relationship between the funding donor agency and the implementing local organization. The way a project comes into being and is implemented, however, has a direct bearing on its substance and, thereby, its results. It will be shown that the organizational set-up of the EU and its administration of positive measures in favor of democracy as observed in the years 1999 and 2000 did not fulfill either of those prerequisites for a successful promotion of democracy.

The criteria for success in the applied sense does not include the outcome and results of a specific project as in impact analyses, but focuses on planning, inception, and implementation, communication structures built up in this process, as well as coordination

³⁸ Huntington 1991.

³⁹ In this chapter 'Africa' is used with the same meaning as 'Sub-Saharan Africa' and refers to the continent excluding the Maghreb countries.

with other international agencies' efforts. While not leading to insights about the results, this approach highlights matters of interaction between the different actors involved.

The first part of this chapter offers a very condensed and accordingly general introduction to the processes of democratization in Sub-Saharan Africa and the different ways in which international influences had a bearing on those processes. The focus then turns to the European Union and the instruments to promote democratization in the three most important fields of external policies it has developed over time. Next, the state of democracy in present-day Zimbabwe is assessed by reference to the most important political issues of the last few years. Finally, the EU's policy to support democratization in Zimbabwe is scrutinized. Hereby, the focus is on the five positive measures funded by the EU in the years 1999 and 2000 that show the EU's performance on the micro level of individual projects.⁴⁰ This support can be related to the macro level of diplomatic activities that will be included in the analysis as well. On the basis of this analysis, some tentative conclusions are drawn and recommendations for the future promotion of democracy by the EU and other international actors in Zimbabwe as well as in other countries are offered.

A.2.2 Democratization and its international dimensions in Sub-Saharan Africa

A.2.2.1 Democratization in Sub-Saharan Africa

Throughout the seventies and the eighties of the last century, the so-called third wave of democratization prompted political optimism as well as academic analysis. Meanwhile, most African countries remained in the firm grip of authoritarian leaders. The experience of colonialism, an extremely undemocratic way to rule a territory,⁴¹ did not help sow the seeds of popular emancipation and participation and the democratic institutions set up by the departing colonial powers collapsed quickly.⁴² Africa was widely believed to constitute infertile ground for democratic systems of governance.⁴³

What then triggered democratization in Africa and how exactly were the autocratic rulers removed from office? It can be maintained that in most cases the following developments were of decisive importance: Aggravated by the Structural Adjustment Plans (SAPs) of the International Financial Institutions (IFIs), economic deterioration was widespread in Africa in the late Eighties.⁴⁴ This had a twofold effect in favor of democratization. Firstly, the economic suffering of the populations reached a level at which they were prepared to air their frustrations and gather in the streets to stage massive protests.⁴⁵ Although most of the

⁴⁰ The analysis of those interventions, presented here in a very condensed way, is based on about 50 interviews conducted throughout field research from December 1999 to February 2000, as well as in the context of visits to the Commission in Brussels in December 1998 and October 2000. A more comprehensive analysis of the issues under consideration here and introducing Malawi as a second case study will be provided (Nolting, Armin K.: *Die Demokratieförderung der Europäischen Union: Eine Untersuchung am Beispiel von Positivmaßnahmen in Malawi und Simbabwe*, Ph.D. thesis, Ruhr-Universität Bochum 2001, forthcoming).

⁴¹ Wiseman 1997: 278.

⁴² Wiseman 1997: 280ff..

⁴³ Joseph 1997: 363. Generally structural (Lipset 1959: 78; Moore 1969: 495; Rueschemeyer et al. 1992: 59) as well as actor-oriented approaches (O'Donnell / Schmitter / Whitehead 1986; Huntington 1984) both raised little hope for democracy in Africa.

⁴⁴ Joseph 1997: 368f..

⁴⁵ Erdmann 1999: 43.

protests were economically motivated,⁴⁶ they can be considered a decisive factor contributing to political reforms.⁴⁷ Secondly, the crises infringed on the regimes' ability to buy acquiescence from key actors in the ruling party and the military, from traditional leaders, or representatives of important ethnic groups. The clientelistic power structures relying on the availability and distribution of resources was called in question.⁴⁸ Thus first cracks in the hitherto over powerful ruling networks emerged. In addition to these domestic processes, the scrutiny of African democratization processes has highlighted the importance of international variables that determine the dynamics towards a more inclusive mode of government.

A.2.2.2 The international dimensions of democratization in Sub-Saharan Africa

Here one can distinguish between three distinct phenomena. The first, termed democratic contagion or diffusion, is a channel of influence only indirectly attributable to agents and purposeful actions. The idea of contagion arose from the observation that processes of political liberalization and democratization often appear in geographical clusters within a comparatively short period of time.⁴⁹ This can be explained by the increasing significance of the (electronic) media in linking individuals, organizations, and whole societies. They make information, a key variable in any power struggle and hitherto a prerogative of the ruling elite, accessible to the wider public.⁵⁰ Limited access to international media, particularly in the rural parts of Africa, reduces the influence they can have on democratic developments. Other channels of contagion are individual experiences and personal contacts. In African countries the group of citizens that has been in touch with other systems of government and more liberal societies makes up only a tiny, but at the same time influential, part of society. In the late 1980s, most African countries were among the most marginalized in the world as regards the global exchange of information and ideas. If processes of contagion still had a tangible effect, it was due to the high level of responsiveness particularly in Africa's urban middle classes that were frustrated by traditional clientelistic structures.

The second mechanism, political conditionality, draws on political actors' decisions to make international trade and development cooperation subject to the partner countries' adherence to normative standards such as human rights and the democratic legitimacy of the government. After their sporadic introduction in the Seventies and Eighties by the Netherlands,⁵¹ later also by Scandinavian countries and Canada,⁵² today political conditions for trade prerogatives and development aid are almost universally applied. With respect to African countries, political conditionality must be seen as a powerful instrument. Due to their relative insignificance in global politics and the world economy, these countries are hardly in a position to reject trade and aid agreements that force them to follow certain political strategies.⁵³ They rely on export earnings and development aid accessible through those

⁴⁶ Bratton / van de Walle 1997: 35.

⁴⁷ Schmidt 1994: 260f..

⁴⁸ Joseph 1997: 377.

⁴⁹ Whitehead 1996: 5.

⁵⁰ Whitehead 1996: 6f..

⁵¹ Halm 1997: 27; Sørensen 1993: 2.

⁵² Nielinger 1998: 115.

⁵³ Barkan 1997: 373; Diamond 1997: 350; Hartmann 1999: 65.

agreements. However, there are voices that express doubt about the effectiveness of political conditionality for the spread of democracy and highlight its risks and traps.⁵⁴ Nevertheless, there are indications that adequate timing⁵⁵ of conditionality tailored to a certain country⁵⁶ can indeed have a pro-democratic impact.

Thirdly and finally, so-called positive measures have to be considered as yet another international dimension of democratization. In brief, they can be described as development projects providing technical, personal, and financial cooperation to contribute to the introduction and protection of democratic governance and civil liberties. They do so by identifying and supporting governmental and non-governmental institutions and organizations of importance for a functioning democratic commonwealth. This wide range of activities on the governmental side addresses the executive as well as the legislative and judicial sectors.⁵⁷ Support for non-governmental actors includes activities as diverse as the protection of the rights of vulnerable groups, strengthening the capacities of non-governmental organizations (NGOs), the promotion of independent media, and civic education. The long term nature of political and social changes and the fact that they are hard to quantify make evaluations and impact assessments of those interventions difficult.⁵⁸ One should note, however, that, because many African states presently fail to provide their populations with the basic physical necessities, civic education or the assessment of the human rights situation would most likely not take place at all without external support. This holds particularly true with respect to the organization and observation of democratic elections.

A.2.3 The European Union's promotion of democracy

A.2.3.1 External trade policy: The economic giant

Since its earliest appearance in the global economy as the European Coal and Steel Community in 1952, the European Community (EC) has become the biggest single trade power.⁵⁹ Trade agreements negotiated with third countries, other regional groupings, or within international forums like the General Agreement on Tariffs and Trade / World Trade Organization gave the EC and later its political umbrella EU remarkable status and practical influence in the macro-economic affairs of those countries for which Europe represents the dominant trading partner, which is the case for most African countries. At the same time, African countries represent only a minor percentage of the external trade of the EU and are therefore, from a European perspective, of very limited economic significance.

This asymmetrical relationship between the EU and developing countries offers two avenues for the promotion of democracy. On the one hand, it strengthens the EU's position in trade negotiations, enabling it to require political reform, more room for opposition groups, or adherence to human rights principles.⁶⁰ On the other hand, the impact of European trade

⁵⁴ Bratton / van de Walle 1997: 271; Ellis 1995: 12; Sørensen 1993: 5.

⁵⁵ Bratton / van de Walle 1997: 272.

⁵⁶ Schmidt 1997: 327.

⁵⁷ Heinz / Lingnau / Waller 1995: 20f.; Schmitter / Brouwer 1999: 15ff..

⁵⁸ Heinz 1994: 51ff.; Lingnau 1996: 803.

⁵⁹ Bretherton / Vogler 1999: 48.

⁶⁰ Crawford 1998: 134f..

with developing countries affects their macro-economic development and thus, indirectly, the output legitimacy of their governments. The popularity of a government as well as its ability to sustain clientelistic networks can be supported or checked by means of trade policy. With respect to countries that have just undergone democratic transitions, trade policy can be applied to support a weak economy in order to prevent the democratically elected government from being toppled because of economic frustration.⁶¹ The Agreements of the Lomé-Process between the EC and the African, Caribbean and Pacific (ACP) Countries are the most important and most comprehensive treaties regulating trade with developing countries worldwide. They contain a strong aid component, too, and will therefore be considered in the next section.

A.2.3.2 Development cooperation: The big spender

The Treaty of Rome, signed at the time of decolonization, stressed the special relationship between colonial powers and their (former) dominions and stipulated that newly independent states should not be denied the preferential access to the European market they enjoyed as colonial dominions. The Yaoundé-Agreement,⁶² which in 1975 was followed by the successively renegotiated Lomé-Agreements, elaborated and expanded trade and aid regulations while securing Europe's reliable access to cheap agricultural produce and mineral raw materials.⁶³ Part of the agreement was the European Development Fund (EDF), a five year plan of development aid agreed upon in negotiations between the EC, represented by the Commission, and the ACP-countries.

In the first ten years the Lomé-Agreements, however, made no reference to questions of human rights or democratic legitimacy at all. Brutal dictatorial regimes were supported without much hesitation. The situation began to change with the negotiations of Lomé III, which featured a general reference to the basic rights of man in its preamble.⁶⁴ Lomé IV, negotiated 1989 and 1990 amid the dramatic global political changes, contained more straightforward regulations in favor of democratization that were further strengthened by the Maastricht revision of the Treaty of the European Community (TEC) that postulates that the Community's development policy is to promote democracy, the rule of law, and the protection of human rights and basic freedoms (Art. 177(2)).

Subjecting the provision of European aid payments and technical cooperation to conditions was complemented by the introduction of facilities to finance positive measures, i.e. program activities promoting democracy as a new sector of development cooperation,⁶⁵ also referred to as political aid.⁶⁶ Implementing partners have been government institutions, international NGOs, and organizations of domestic civil society.⁶⁷ European support for initiatives in this sector rose significantly over the decade ending in 1995. Starting from nil in

⁶¹ This process, often referred to as disenchantment, stems from a population's exaggerated material hopes in a democratized state and society.

⁶² Piening 1997: 170.

⁶³ Grilli 1993: 26; Ravenhill 1995: 96.

⁶⁴ Oestreich 1990: 283f..

⁶⁵ The formal basis of those activities is a Council Decision from November 1991 (Heinz / Lingnau / Waller 1995: 5).

⁶⁶ Crawford 2000; Pinto-Duschinsky 1997.

⁶⁷ European Commission, DG VIII 1998; Crawford 1998: 160-170.

1986 the pledges to ACP-Countries in the area of promotion of democracy rose to over 30 million € in 1995 with a maximum of 41 million € in 1992.⁶⁸ The EU's commitment to the support of democracy and human rights in Africa and other developing countries is thus reflected in monetary terms. Referring solely to the countries of Southern Africa, a former head of the unit for democratization and human rights in the Commission's Directory General (DG) 8 reports that 120 million € were disbursed between 1992 and 1997.⁶⁹

With the Cotonou-Agreement signed in June 2000, the political dimension of EU-ACP cooperation has been strengthened by stricter procedures for the application of conditionality, i.e. the renunciation of support when principles of democratic governance and human rights are breached. At the same time local authorities and non-governmental actors have been given higher priority than in any of the preceding Lomé Conventions,⁷⁰ thus contributing to a modernization of the political aspects of cooperation.⁷¹ If those contractual changes result in a different political practice in development cooperation will have to be assessed once the new provisions have been put into practice.

A.2.3.3 European diplomacy: The political dwarf

With the introduction of the Common Foreign and Security Policy (CFSP) through the Treaty on European Union (TEU), external competencies of the Union have cautiously been extended to high politics. CFSP can draw from a number of diplomatic instruments as well as instrumentalize trade and development policy for the promotion of its aims, among which development and promotion of democracy, rule of law and respect for human rights, and basic freedoms rate highly (Art. 11(1) TEU).

In this field, a division of labor between CFSP and development policy can be observed. While the latter takes care of the everyday matters of political development cooperation, such as the support for human rights NGOs, CFSP provides the diplomatic and symbolic superstructure. Its involvement with positive measures is mostly restricted to high profile events such as elections. This division of labor, however, is by no means clear cut or harmonious. Institutional conflicts between the external relations of the Community (e.g. development and external trade policy) and the much more intergovernmentally constituted foreign policy of the Union began in the Seventies with the introduction of European Political Cooperation (EPC), which later was transformed into CFSP. Throughout the Nineties, competition and envy between different Directorate Generals of the Commission as well as between individual Commissioners complicated matters further.⁷² At the same time, institutional interests seemed to block any credible attempt to streamline organizational structures into a comprehensible set-up. When compared to the USA or its own member countries, the EU itself has not yet managed to become a fully functional and assertive actor in global diplomacy.

⁶⁸ Cox / Koning 1997: 49.

⁶⁹ Mosca 1998: 36. Evaluation reports of the German Development Policy Institute (Heinz / Lingnau / Waller 1995) and a more recent joint exercise by three consulting companies (European Commission SCR F5 2000) give detailed analyses of the thematic scope and regional distribution of those activities.

⁷⁰ Desesquelles 2000.

⁷¹ Câmara Santa Clara Gomes 2000: 13.

⁷² Allen / Smith 1994: 68; Bretherton / Vogler 1999: 39.

A.2.4 Zimbabwe at the turn of the century: democracy in the making?

At the time of writing, the political situation in Zimbabwe is precarious and signs of deterioration are more visible than those of hope. The highly complex interplay of internal and external as well as political and economic processes in the second half of the Nineties will be sketched out by reference to three issue clusters that help understand the political environment of the EU-policy considered below.

A.2.4.1 Economic crisis, regional ambitions, and the land question

Since 1997 Zimbabwe has been involved in the Congo conflict. Laurent Kabila's rebellion against Mobutu Sese Seko was supported by the sale of weapons and access to military intelligence.⁷³ Once Kabila's former allies Burundi and Uganda turned against him, Zimbabwe joined a coalition of countries in his support, sending more than 10000 soldiers, the equivalent of a quarter of Zimbabwe's armed forces.⁷⁴ This intervention, mirroring Mugabe's self perception as a regional leader, has been hotly debated ever since in Zimbabwe.⁷⁵ The criticism became more decisive when the plight of the Zimbabwean economy was felt by an increasingly large proportion of the population. At the same time, the regime was unable to explain the benefits from Zimbabwe's costly involvement in this war, as these, mainly mining concessions, were pocketed by army commanders or members of the ruling party.⁷⁶

The scarcity of energy in the country, however, was not merely due to the costs of the war in the Congo. It was also the consequence of ongoing mismanagement in parastatals. Simultaneously, it was a cause for further economic and environmental deterioration as more people were forced to resort to using wood for heating and cooking purposes. This environmental destruction was particularly grave on farmland occupied by 'war veterans' and thus turned into factually lawless territories.⁷⁷

These occupations were fanned by Mugabe's attempts to deviate popular pressure directed against his government. He blamed Zimbabwe's problems on an international conspiracy and identified the presence of the mostly white commercial farmers as the reason for economic problems. Hence, plans to distribute their land to black Zimbabwean farmers were revived, resulting in farm invasions at least partly orchestrated by the ruling party. Consequently, many farms were unable to harvest the cash crops badly needed to bring hard currencies into the country and to provide their employees with work and salaries.⁷⁸ With its demand that the British government pay the white farmers stripped of their land compensation in acknowledgement of British colonial responsibility,⁷⁹ the Zimbabwe

⁷³ Baumhögger 1998: 416.

⁷⁴ Baumhögger 2000: 431.

⁷⁵ Meyns 1999: 38.

⁷⁶ Mönikes 2000: 69.

⁷⁷ International Crisis Group 2000: 5.

⁷⁸ Auret 1998: 52; International Crisis Group 2000: 6.

⁷⁹ Cornwell 1998: 46.

government directly contributed to the internationalization of the land issue and Zimbabwe's way of dealing with the economic crisis.⁸⁰

A.2.4.2 The rebirth of civil society and the constitutional debate

After the liberation from white minority rule and throughout the Nineteen eighties that saw commendable development successes, particularly in the areas of education and health,⁸¹ the Government of Zimbabwe and civil society organizations lived in a honeymoon state.⁸² In the late Eighties and even more so in the following decade, the situation changed considerably. The Unity Accord between the Zimbabwe African National Union (ZANU) and the Zimbabwe African People's Union (ZAPU) to form ZANU-PF (Patriotic Front) left the country without a meaningful political opposition at a time when many African countries were starting their democratic experiments. The government seemed unable to ameliorate the consequences of an economic crisis aggravated by the SAPs and a drought that resulted in food shortages and starvation in a country usually regarded as an exporter of food staples. The subsequent price rises triggered mass protests and civil society became more critical and more vocal. Advocacy groups, the university community, and a plethora of other groups and individuals began to demand more participation in the political process and true accountability from the government.⁸³ Government tried to impose legal restrictions on NGO activities, but after opposition parties failed to organize themselves in a credible way in the run-up to the parliamentary elections in 1995, CSOs started to take over their functions.

A number of new organizations emerged and made themselves heard, especially with new insights into the atrocities committed throughout the troubles in Matabeleland in the 1980s. In 1997 the National Constitutional Assembly (NCA) was founded, an umbrella organization lobbying for a new and more democratic constitution. After initial attempts of the government and the NCA to join forces in this matter, the government set up its Constitutional Commission in June 1999. Following a massive outreach program the constitutional draft was published in November 1999.⁸⁴ The draft, complemented by last minute changes concerning limitations of civil liberties and Britain's duty to pay compensation to disowned commercial farmers, was unexpectedly rejected by Zimbabweans in a referendum in February 2000.⁸⁵ This must be regarded as a tremendous success of the NCA, which had intensely promoted a no-vote.

⁸⁰ The question of land distribution has been internationally discussed since the Lancaster-House- Constitution put an end to white minority rule in 1980. This document commits the Zimbabwe government to respect land-ownership for a period of ten years (Auret 1998: 49; Meyns 1999: 32). Since this period expired, government has made different attempts to tackle this question, albeit most of them mainly benefiting members of ZANU-PF or government officials (Goudie / Neyapti 1999: 87).

⁸¹ Goudie / Neyapti 1999: 84.

⁸² Nkiwane 1998: 93.

⁸³ Nkiwane 1998: 93.

⁸⁴ Baumhögger 2000: 423.

⁸⁵ Mönikes 2000: 68.

A.2.4.3 Opposition politics under severe pressure

After the *Unity Accord*, political opposition was hardly visible in Zimbabwe. Throughout the 1990s, opposition parties and independent candidates held a mere three mandates in parliament. Most groupings appeared shortly before the elections and disappeared immediately thereafter.⁸⁶ Apart from the uneven playing field, e.g. by ZANU-PF's instrumentalization of state resources for their campaigns, the opposition parties were unable or unwilling to coordinate and join forces as recommended by political commentators.⁸⁷ There are, however, other signs suggesting that the seemingly chaotic conduct of many opposition figures and parties was part of a strategy of the ruling party to suffocate political dissent in its inception.⁸⁸

In the run up to the parliamentary elections in June 2000, the situation changed in many ways. The economy was in disarray, the honeymoon between state and civil society over for good, and the formation of the Movement for Democratic Change (MDC) constituted a real threat to ZANU-PF's claim to power. The MDC arose from the trade union movement, was able to integrate diverse social groups, and constituted itself as a political party on September 10, 1999. As a major force in the constitutional debate, the MDC was able to further its credibility. It required massive intimidation strategies by ZANU-PF to prevent MDC from winning a majority of the 120 seats contested in the election. Months of violence, leaving more than 30 opposition supporters dead, and attempts to hamper MDC's campaign judicially preceded the two polling days, which themselves were judged sufficiently free and fair by most international observers. The election brought 57 MDC candidates into parliament, a result that, in view of the circumstances described above, must be regarded as a massive blow for ZANU-PF and Mugabe himself. It remains to be seen if the MDC will be able to consolidate its position and force ZANU-PF to commence substantial democratic reforms. It is just as possible, however, that Mugabe will foil this challenge with his repressive methods, sometimes equated to fascism,⁸⁹ once the opposition movement has exhausted its comparatively limited resources.

A.2.5 European promotion of democracy in Zimbabwe

Promoting democracy from the outside is a delicate task that must be closely adjusted to the domestic, political, and social dynamics of a country. The precarious political situation of Zimbabwe constitutes a demanding test case for such a policy. The EU's democratization policy in Zimbabwe will be investigated on two levels: firstly, the macro-level of diplomacy and governmental negotiations and agreements; secondly, the micro-level of positive measures by means of which the EU gets involved in a much more down-to-earth fashion. Other international actors will only be considered in order to shed additional light on the EU approach in this field.

⁸⁶ Nkiwane 1998: 99.

⁸⁷ Makumbe 1991: 185.

⁸⁸ Sylvester 1995: 423.

⁸⁹ The Economist, 24 February 2001.

A.2.5.1 Macro-level: diplomatic pressure and conditionality

In the 1990s, Zimbabwe was repeatedly subjected to economic conditionality. Since deciding to implement an SAP,⁹⁰ the relationship between the Government of Zimbabwe and the IFIs has been, to say the least, difficult. In 1995, the International Monetary Fund stopped its balance-of-payment support for the first time,⁹¹ a decision that prompted other important donors to reduce their support as well. The economic conditionality of the IFIs was adhered to in broad terms and replicated by the EU.⁹² The National Indicative Program (NIP) that specifies focus areas for European development cooperation with Zimbabwe does not mention democratization as one of them. Still, the general guidelines of this document posit that their cooperation is based on "the development and consolidation of democracy, and the rule of law as well as respect for human rights and fundamental freedoms".⁹³

A significant politicization of the European-Zimbabwean relationship occurred after two journalists were arrested and tortured by the military police in early 1999. Allegations that they had reported about a planned coup without sufficient evidence were most likely justified, the treatment of the journalists nevertheless illegal and an obvious attempt to intimidate an increasingly outspoken independent press.⁹⁴ In reaction to the arrests the EU issued an official protest and member countries summoned Zimbabwean Ambassadors to their respective foreign offices.

In this situation of increased tensions, a report on conflict potential in Zimbabwe,⁹⁵ commissioned and financed by the European Commission and using very straightforward language in its criticism of government policies, was leaked to the government press. The Commission was heavily attacked by the *Herald* newspaper as well as by government officials and members of the ZANU-PF Politburo.⁹⁶

In March 2000, in response to the farm occupations, the presidency of the EU requested the government of Zimbabwe to ensure the rule of law.⁹⁷ In April, the EU's foreign ministers discussed the cessation of aid payments in case the scheduled elections did not take place and violations of the rule of law continued.⁹⁸ Freezing Mugabe's Europe-based assets was discussed as well to make clear that the measures taken were not targeted against the people of Zimbabwe but against the corrupt and unresponsive leadership.⁹⁹ The Commission itself did not contemplate reducing its cooperation programs with Zimbabwe, as support in health or education was important irrespective of what happened in the political arena. At that moment, individual member countries were already one step further, freezing large parts of their aid payments and raising diplomatic pressure.¹⁰⁰

⁹⁰ Brown 1999: 77.

⁹¹ Jenkins 1997: 599f..

⁹² Brown 1999: 87; Jenkins 1997: 600.

⁹³ Republic of Zimbabwe / European Community 1996: 1.

⁹⁴ US Department of State 2000: 5.

⁹⁵ Stiftung Wissenschaft und Politik, Conflict Prevention Network 1998.

⁹⁶ The Zimbabwe Mirror, 21 May 1999.

⁹⁷ Press Release Pesc/00/29.

⁹⁸ The Times, 11 April 2000.

⁹⁹ The Zimbabwe Independent, 14 April 2000.

¹⁰⁰ The Zimbabwe Independent, 21 April 2000.

The highest profile involvement of the European Union in the political affairs of Zimbabwe was its observation mission for the parliamentary elections in June 2000. The initiative that included the employment of about 260 observers seems to have originated from British Foreign Secretary Cook, who was sure to receive support from his European colleagues.¹⁰¹ The negotiations with the Government of Zimbabwe concerning the deployment of European election observers encountered many difficulties. The first was Mugabe's rejection of British nationals as part of the EU-delegation or in fact as members of any observer mission.¹⁰² In June, the process of accreditation was delayed in a way that prevented many of the mission members from observing the last weeks of campaigning. On the election weekend, the EU mission visited 1729 polling stations, observing a free and fair polling process.¹⁰³ This stood in stark contrast to the campaign period that saw widespread intimidation and violence.

When the offices of the opposition MDC were searched by the police in September 2000 the Presidency of the EU condemned those activities repeatedly.¹⁰⁴ Simultaneously, it was stated that funds earmarked for Zimbabwe under the Cotonou-Agreement would not be released until the political situation had normalized.¹⁰⁵ This however in no way affected the disbursement of funds administered under the Lomé-Agreement still in implementation. While the EU was still contemplating commencing a political dialogue with the government of Zimbabwe as set out in Article 8 of the Cotonou Convention,¹⁰⁶ a number of member countries of the EU had already introduced more restrictive measures.¹⁰⁷ In June 2001, the EU finally proposed a 60 days deadline for the restoration of the rule of law to avoid "tough measures".¹⁰⁸

A.2.5.2 Micro-level: positive measures

While this war of words with the European Union and particularly its executive organ the Commission was going on, five positive measures supporting democracy, good governance, and human rights were financed by the EU.¹⁰⁹ Without exception, they were funded from the Commission's budget lines. The projects will be considered under the following sub-headings: firstly, planning and implementation; secondly, communication and evaluation; and thirdly, coordination with other donors' activities.

¹⁰¹ The Zimbabwe Independent, 14 April 2000.

¹⁰² The Zimbabwe Standard, 21 May 2000.

¹⁰³ European Union – Election Observation Mission – Zimbabwe 2000, Chap. 7.

¹⁰⁴ Pesc/00/133 and Pesc/00/141, September 19 and 27, 2000 respectively.

¹⁰⁵ Financial Gazette, 21 September 2000.

¹⁰⁶ Financial Gazette, 1 March 2001.

¹⁰⁷ These are namely Denmark (Panafican News Agency, 22 November 2000), Germany (Financial Gazette, December 7, 2000), and Great Britain (Financial Gazette, March 1, 2001). As early as 1999, the Netherlands decided to remove Zimbabwe from its list of bilateral aid recipients (Zimbabwe Independent, August 13, 1999)

¹⁰⁸ Financial Gazette, 9 August 2001.

¹⁰⁹ They were the following: 1. Catholic Commission for Justice and Peace in Zimbabwe: Video Production "Political Tolerance and the Development of a Multi-Party System in Zimbabwe", budget: 43.000 €; 2. Human Rights Research and Documentation Trust of Southern Africa: Mainstreaming Human Rights in Teacher Education, budget: 358.806 €; 3. Legal Resources Foundation: Paralegal Program in Gweru and Masvingo, budget: 229.000 €; 4. Transparency International Zimbabwe, budget: 580.000 €; Zimbabwe Human Rights Association: Election Monitors Training Program, budget: 220.000 €.

A.2.5.2.1 Planning and implementation

According to the principles of demand-driven development cooperation, positive measures in favor of democracy are conceptualized by domestic, here Zimbabwean, organizations, funded by the EU, and implemented by the applying organization. In reality, unsurprisingly, things are more complicated. In most cases the EU representatives were already involved at an early stage and strongly encouraged a request for funds by the NGO. The Commission's Delegation itself has no right of approval or rejection of funding requests, but its recommendations can significantly influence the decision on project proposals in Brussels. Accordingly, good personal and working relationships with the Commission's personnel on site are essential for local NGOs. It is also worth noting that in most cases the EU was not chosen as a partner because of political or programmatic reasons. It was rather knowledge about the availability of considerable funds and comparatively loose administrative obligations, thus giving the implementing NGO some leeway.

With respect to the actual implementation phase, the following observations were prevalent: firstly, significant delays in the disbursement of approved funds; secondly, a lack of flexibility in a political situation that is fundamentally volatile and needs flexible responses more than anything else.

Three projects saw a delay of the EU's financial contributions, particularly of the first portion that is badly needed to start the implementation. When a project is oriented towards a specific date, such as with the training of election monitors for the parliamentary elections in 2000, these delays are particularly destructive.¹¹⁰ These delays were even more problematic as the Commission's departments in charge, due to ignorance or negligence, did not announce them with sufficient transparency. As it was, the EU's partners had to borrow funds from other activities and donors in order to commence implementation. Delays can partly be explained by the negligence of the partner organizations themselves that failed to live up to the regulations put down in the financing agreement. Given that, there are problems on the EU-side as well that can serve as an explanation for disbursement delays. One is the internal restructuring of the Commission that has been going on since the early 1990s and reached a climax with the creation of the Common Service for External Relations (SCR), an administrative unit concentrating on processing approved projects, mainly the disbursement of funds. Working relations between the SCR and the DGs never developed satisfactorily until it was decided to transform the SCR into a larger department (European Commission, 16 May 2000).

Another reason for the slow processing of the projects in the Commission's administration is their relatively small financial volume. As 'soft projects' with only minor purchases of material they never amount to volumes represented by projects in the areas of infrastructure, health, or agriculture. Due to the necessity to disburse pledged funds as soon as possible in order to exhaust budget lines, the administration of larger projects received preferential treatment in the Commission. This practice compounded the relative slowness in the administration of projects in the area of democracy, human rights, and good governance.

¹¹⁰ In the case of Zim Rights' Election Monitoring Training Program, it was only the postponement of the election which enabled the organization to have its trainers in place in time, as the implementation was delayed by slow disbursement of pledged funds.

The EU was also criticized for lack of flexibility that rendered all but impossible short term adjustments of project activities entailing modifications of the budget. The lack of decision making power on the side of the Commission's Delegation in Zimbabwe must be seen as a great impediment for the implementation of positive measures in a political environment shaped by rapid changes.¹¹¹

A.2.5.2.2 Communication and Evaluation

The previous paragraphs have already alluded to the communication culture between the European Commission and its Zimbabwean partners. Any attempt to understand and assess an organization's performance depends on good cooperative and communicative relationships. Hence communication and evaluation are considered together here.¹¹² The culture of collaboration and communication between the NGOs and the Commission's Delegation in Harare was for the most part positively assessed. Any exchange involving the Commission in Brussels, however, was experienced as a rather frustrating exercise. Brussels, however, is the place where decisions are made. For the partner organizations, it was only rarely understandable who was dealing with their requests, and Brussels' tone was often perceived as disinterested, sometimes harsh, and mostly demotivating. Zimbabwean NGOs commented critically on the fact that Brussels failed to comment on provided activity reports and described the communication with Brussels as a one-way street.

The delays and the seeming lack of interest can be attributed to the understaffing of the Commission, which has acquired an increasingly heavy workload over the last years.¹¹³ The abrupt or harsh tone, however, highlights another dimension of the promotion of democracy and development cooperation in general which is particularly visible and relevant at the micro-level of individual projects. It is the difference between African and European business culture. The matter-of-fact approach of business that neglects the establishment of positive personal relationships was repeatedly criticized by representatives of NGOs and experienced as very disheartening.¹¹⁴ The fact that the project whose stakeholders felt most comfortable with the European Commission's running of things was managed by members of the white Zimbabwean minority with European background underlines this point. Another area of concern was the fact that the EU failed to encourage and enable its partners' networking activities. Starting from the hardly contested assumption that democracy can not be brought about in isolated approaches but needs an effective coordination and division of labor among all democratizers, this is a serious shortcoming, particularly in a hostile political environment such as exists in present-day Zimbabwe. In summary the contemporary organizational set-up seems inadequate to gain a reasonable understanding of the projects and their political environment and establish strategic partnerships to really impact on the democratic transformation of society.

¹¹¹ Other donor agencies (e.g. DANIDA) have limited resident budgets they can use to support local initiatives without elaborate consultation processes with their capitals.

¹¹² Evaluation is understood not merely as a single systematic exercise but as an ongoing process in which a funding agency becomes more knowledgeable about the supported organizations and projects.

¹¹³ Kaltefleiter 1995: 73.

¹¹⁴ A systematic analysis of those difficulties, using the example of Nigerian-German cooperation is provided by Erika Dettmar (1998).

A.2.5.2.3 Coordination of positive measures

It has just been shown that the present organizational structure of the EU's promotion of democracy does not enable it to build relationships with civil society organizations intensely and affirmatively. This holds true not only for the case of Zimbabwe.¹¹⁵ For partly the same reasons consistent communication and coordination structures between the Delegation of the Commission and other donor agencies represented in Zimbabwe have not so far materialized either. From the mixed and partly contradicting statements of interview partners, it is difficult to assess the quality of overall donor coordination in Zimbabwe. Whatever the overall status though, the inability of the Commission's representatives on site to enter into commitments make it an awkward partner for other donor organizations. Though very important in terms of its financial contributions, the EU is not considered an important consultation partner by most of the organizations approached in this research. While appreciating the efforts of EU officials, they consider it a cumbersome organization to deal with. Regardless of the individuals' opinion of EU democracy promotion, knowledge of its activities was very limited. The main points of criticism aired by other donor organizations were the EU's unreliable financial contributions and its administrative inability to enter into co-financed activities, aggravating the dependency of local NGOs on their international financiers.

Considering that the EU itself can be regarded as a major experiment in international coordination, one is tempted to expect a stronger degree of consultation between donor organizations and agencies of the EU member states. This, however, is not the case. Closer coordination, if not entirely accidental, seems to stem from personal relationships in the donor community but certainly not from the acknowledgement of belonging to the European Union. The question of consistency and coherency in European politics is also pressing in the seemingly peripheral field of promoting democracy in a Southern African country.

There are examples, however, that show that the EU with its support for positive measures can and does work complementarily with member states' agencies. Where this happened, it seems to be attributable to careful planning by the local NGO and not to efforts by the donor organizations themselves. There is, however, a minority position that doubts the overall desirability of complete coordination. It reasons that it would indeed be in the spirit of democracy and pluralism if different agencies, responsible as they are to different governments and parliaments, competed for best solutions. Certain additional costs and duplications due to a lack of coordination would in this case be acceptable.

A.2.6 Tentative conclusions and recommendations

A.2.6.1 Promoting democracy in Zimbabwe: The need for flexibility

Processes of liberalization and democratization remain fundamentally domestic, and the main work of democratization has to be done by the local elites and the population at large. In an increasingly interdependent world these processes, however, will never be fully independent from international variables, and the assumption that international factors will gain still more significance in the future seems plausible. This should also apply to Zimbabwe, which is standing at a decisive juncture in its political development. The present

¹¹⁵ For the case of Malawi, cf. Nolting 2001.

economic and political crises still command international attention and open windows of opportunity for democratic change and its support from abroad.

At the moment, while the opposition's stamina in enduring the suppression by state organs lasts, a dual approach seems to be advisable. Firstly and foremost, targeted, consistent, and coordinated political conditionality that restricts the Government's scope of action while limiting the burden on the population is inevitable if international actors desire a democratic Zimbabwe. Zimbabwe's economic plight and increasing dependency on external provisions should facilitate this strategy. Secondly, positive measures to support democratic pockets of the Zimbabwean society and build up trust relationships with key actors should be carefully encouraged and financed. In a political setting hostile to democratic change, however, progress achieved by those small initiatives is easily crushed by the people in power. For the time being restrictive measures to support democratization in Zimbabwe thus seem to be more promising and cost effective. The experience to be gained from the promotion of democracy in Zimbabwe should not be underrated as tendencies of democratic degeneration can be observed in other countries of the region, too. Although looking back on a decisively different recent history, it is not at all guaranteed that Zambia, Namibia, and Malawi will remain democracies.¹¹⁶

After a transition to democracy, a markedly different approach is needed. Civic education and the democratic orientation of the security forces need to be supported as well as the functioning of the democratic institutions. It is only thus that the people of Zimbabwe can gain trust in a new political dispensation. This specific support, however, must be complemented by effective support in the other, more traditional areas of development cooperation. Although causal relations between economic and political development have yet to be established, external economic support is needed to prevent anti-democratic tendencies from growing out of dissatisfaction with the development record of a newly elected democratic government that is challenged with hardly surmountable problems like the AIDS pandemic, food scarcity, and natural degradation.

A.2.6.2 The EU on its way to assertiveness?

Promoting democracy and human rights internationally is a complicated affair. When revisiting the three international dimensions of democratic change, the EU appears to be well situated to contribute to global democracy in each of those areas. Being the world's largest trading bloc and enjoying a comparably high moral standing gives the EU leverage in this field. Additionally, its overall financial muscle can provide strong support to institutions and organizations that implement positive measures in favor of democracy and human rights. It can be maintained that in the second half of the 1990s the EU took an increasingly critical stance towards undemocratic regimes, in Harare and elsewhere. Nevertheless, the EU still appears as a timid and slow international actor. Judging from its policy towards Zimbabwe, its promotion of democracy cannot be called proactive, as restrictive measures were hesitantly introduced only after the situation had deteriorated in a way that made other strategies all but impossible.

¹¹⁶ Reference is made to the brutalization of political competition and the attempts to weaken constitutional limits on the number of terms a president may serve once the incumbents' reach their last legal term of office.

In the introduction it was argued that international promotion of democracy needs to be consistent with other policies and coordinated with other actors in this field. After looking at the communication structures within the European Commission as well as between it and its partners, it has become apparent that the EU does not live up to these demands. Through its political softness towards the Government in Harare, it fails to contribute to changes at the macro-level that would help the positive measures at the micro-level to make a meaningful contribution. As it was, isolated democratization projects had to struggle in a hostile environment for a long time without receiving much high level political support from the EU. This can be explained by the Union's decision making procedures, which become particularly cumbersome when foreign policy issues, as opposed to trade or aid, are at stake. National interests can prevent a speedy and assertive approach as the struggle for a solution slowly but surely waters down most initiatives. Development agencies' own interests, however, also often prevent a more decisive restrictive approach. Expatriate officials who propose a withdrawal of support endanger their own job opportunities and might have to weigh their own interests with those of the democratic development of their host country.

It was further argued that a meaningful and sustainable contribution at the micro-level demands a speedy administration and a trust relationship between the funding donor agency and the implementing local organization. The picture painted as a result of this research is mixed. When supporting positive measures, the Union's peculiar political and administrative structure can inflict considerable problems on the implementing organization. To reduce the most destructive consequences, the EU should be allowed to contribute to basket funding exercises and abstain from comprehensive funding as in the case with Transparency International Zimbabwe (TIZ). This step has alienated other funding partners and given TIZ the appearance of a 'political pet' of the EU. Keeping in mind the EU's administrative weaknesses, it should not try to acquire more workload by additional positive measures before a number of administrative problems have been solved. The latest restructuring exercise in the Commission must be carefully assessed. It is just too likely that this reform, as has happened before, will be replaced by yet another reform born out of political activism before its real effects became tangible.

These critical remarks must be seen in the context of a considerable number of highly motivated officials in the EU system that try hard to make a change but are hamstrung by the procedures they have to work by. Another glimmer of hope can be found in the provisions of the Cotonou-Agreement, which has much more political weight than its predecessors.

A.2.7 References

ALLEN, David / SMITH, Michael (1994): External Policy Developments. In: The European Union 1993. Annual Review of Activities. Edited by Neil NUGENT. Supplement to JCMS, Oxford / Cambridge, pp. 67-86.

AURET, Diana (1998): Die Landreform – eine Geisel der Politik?. In: der überblick 3/98, pp. 48-52.

- BARKAN, Joel D. (1997): Can established democracies nurture democracy abroad? Lessons from Africa. In: Democracy's victory and crisis. Edited by Axel HADENIUS. Nobel Symposium no. 93, Cambridge, pp. 371-403.
- BAUMHÖGGER, Goswin (1998): Zimbabwe. In: Afrika Jahrbuch 1997. Edited by Rolf HOFMEIER. Leske + Budrich, Opladen, pp. 411-422.
- BAUMHÖGGER, Goswin (2000): Zimbabwe. In: Afrika Jahrbuch 1999. Edited by Rolf HOFMEIER / Cord JACOBET. Leske + Budrich, Opladen, pp. 423-435.
- BRATTON, Michael / van de WALLE, Nicolas (1997): Democratic Experiments in Africa. Regime Transitions in Comparative Perspective. Cambridge University Press, Cambridge.
- BROWN, William (1999): The EU & Structural Adjustment: The Case of Lomé IV & Zimbabwe. In: Review of African Political Economy, no. 79, pp.75-91.
- BREThERON, Charlotte / VOGLER, John (1999): The European Union as a global actor. Routledge, London.
- CAMARA SANTA CLARA GOMES, Sophie da (2000): The political dimension of the new ACP-EU partnership. In: The Courier, Issue 181, June/July, pp. 10-13.
- CORNWELL, Richard (1998): Gnadenfrist für Mugabe? In: der überblick 3/98, pp. 44-48.
- COX, Aidan / KONING, Antonique (1997): Understanding European Community Aid. Aid Policies, Management and Distribution Explained. Overseas Development Institute / European Commission, London / Brussels.
- CRAWFORD, Gordon (1998): Human Rights and Democracy in EU Development Cooperation: Towards Fair and Equal Treatment. In: European Development Policy. Edited by Marjorie LISTER. Palgrave, Basingstoke, pp. 131-178.
- CRAWFORD, Gordon (2000): Promoting Democratic Governance in the South. In: European Journal of Development Research, vol. 12, no. 1, pp. 23-57.
- DESEQUELLES, Gilles (2000): The non-governmental actors. In: The Courier, Issue 181, June/July, pp. 6-9.
- DETTMAR, Erika (1998): Konflikte in der afrikanisch-europäischen Zusammenarbeit und Möglichkeiten der institutionellen Einwirkung. In: Nord-Süd aktuell, no. 2, pp. 257-261.
- DIAMOND, Larry (1997): Promoting Democracy in the 1990s: actors, instruments and issues. In: Democracy's victory and crisis. Edited by Axel HADENIUS. Nobel Symposium no. 93, Cambridge, pp. 311-370.
- DIAMOND, Larry / PLATTNER, Marc F. / CHU, Yun-han / TEIN, Hung-mao (ed.) (1997): Consolidating the Third Wave Democracies: Regional Challenges. John Hopkins University Press, Baltimore / London.
- ELLIS, Stephen (1995): Democracy in Sub-Saharan Africa. Where did it come from? Can it be supported?, ECDPM Working Paper no. 6, Maastricht.
- ERDMANN, Gero (1999): Demokratie- und Menschenrechtsförderung in der Dritten Welt. Grundlinien eines Rahmenkonzeptes für die kirchliche Entwicklungszusammenarbeit. Deutsche Kommission Justitia et Pax, Bonn.

- EUROPEAN COMMISSION (16 May 2000): Commission shakes up management of external assistance, Press release.
- EUROPEAN COMMISSION, DG VIII (1998): Human Rights, Democracy and Development. Support from the European Union, Brussels.
- EUROPEAN COMMISSION SCR F5 (2000): External Evaluation of Community Aid Concerning Positive Actions in the Field of Human Rights and Democracy in the ACP Countries, 1995-1999. Synthesis Report (Phase 3), August 26, 2000, Franklin Advisory Services, Channel Research Ltd., SEPIA.
- EUROPEAN UNION – Election Observation Mission – Zimbabwe (2000): Report of the EU Election Observation Mission on the Parliamentary Elections which took place in Zimbabwe on 24th and 25th June 2000, 4th July 2000, Harare / Strasbourg (http://europa.eu.int/comm/external_relations/human_rights/report/zimbabwe/index.htm).
- GOUDIE, Andrew / NEYAPTI, Bilin (1999): Conflict and Growth in Africa, vol. 3: Southern Africa. OECD Development Center Studies.
- GRILLI, Enzo R. (1993): The European Community and the Developing Countries. Cambridge University Press, Cambridge.
- HADENIUS, Axel (ed.): Democracy's victory and crisis. Nobel Symposium no. 93. Cambridge University Press, Cambridge.
- HALM, Dirk (1997): Konditionalität: Entwicklung, Ergebnisse und Probleme eines Konzepts der entwicklungspolitischen Zusammenarbeit. Agenda-Verlag, Münster.
- HARBESON, John W./ ROTHCHILD, Donald (ed.): Africa in World Politics: Post-Cold War Challenges. Westview Press, Boulder / Oxford.
- HARTMANN, Christof (1999): Externe Faktoren im Demokratisierungsprozess. Eine vergleichende Untersuchung afrikanischer Länder. Leske + Budrich, Opladen.
- HAYNES, Jeff (ed.): Democracy and Political Change in the Third World. Routledge, London.
- HEINZ, Wolfgang S. (1994): Positive Maßnahmen zur Förderung von Demokratie und Menschenrechten als Aufgabe der Entwicklungszusammenarbeit. DIE, Berlin.
- HEINZ, Wolfgang S. / LINGNAU, Hildegard / WALLER, Peter (1995): Evaluation of EC Positive Measures in Favor of Human Rights and Democracy (1991-1993). DIE, Berlin.
- HUNTINGTON, Samuel P. (1984): Will More Countries Become Democratic?. In: Political Science Quarterly, Year 99, no. 2, pp. 193-218.
- HUNTINGTON, Samuel P. (1991): The Third Wave: Democratization in the Late Twentieth Century, Norman (Oklahoma).
- INTERNATIONAL CRISIS GROUP (2000): Africa Briefing. Zimbabwe: Three Months after the Elections, Harare / Brussels, September 26, 2000.
- JENKINS, Carolyn (1997): The Politics of Economic Policy-Making in Zimbabwe. In: The Journal of Modern African Studies, Jg. 35, no. 4, pp. 575-602.

- JOSEPH, Richard (1997): Democratization in Africa after 1989: Comparative and Theoretical Perspectives. In: *Comparative Politics*, Year 29, no. 3, pp. 363-382.
- KALTEFLEITER, Viola (1995): Die Entwicklungshilfe der Europäischen Union. Rechtfertigung, Effizienz und politische Ökonomie staatlicher Entwicklungshilfe. Physica-Verlag, Heidelberg.
- LINGNAU, Hildegard (1996): Positivmaßnahmen zur Förderung von Menschenrechten und Demokratisierung im Rahmen der Entwicklungszusammenarbeit. In: *Nord-Süd aktuell*, no. 4, pp. 794-808.
- LISTER, Marjorie (ed.): *European Development Policy*. Palgrave, Basingstoke, pp. 131-178
- LIPSET, Seymour Martin (1959): Some Social Requisites of Democracy: Economic Development and Political Legitimacy. In: *American Political Science Review*, pp. 69-105.
- MAKUMBE, John (1991): The 1990 Zimbabwe Elections: implications for Democracy. In: *The One-Party State and Democracy*. Edited by Ibbo MANDAZA / Lloyd M. SACHIKONYE. Harare, pp. 179-188.
- MANDAZA, Ibbo / SACHIKONYE, Lloyd M. (eds.): *The One-Party State and Democracy*, Harare.
- MERKEL, Wolfgang (ed.): *Systemwechsel 1. Theorien, Ansätze und Konzeptionen*. Leske + Budrich, Opladen.
- MEYNS, Peter (1999): Simbabwe am Ende der Ära Mugabe: Nationale Probleme und regionale Konflikte. In: *ApuZ B 27*, pp. 30-39.
- MÖNIKES, Volker (2000): Simbabwe in der Aufbruch-Krise. Zwischen Verfassungsreferendum und Wahlen. In: *KAS-Auslandsinformationen 4/00*, pp. 66-84.
- MOORE, Barrington (1969): *Soziale Ursprünge von Diktatur und Demokratie. Die Rolle der Grundbesitzer und Bauern bei der Entstehung der modernen Welt*. Suhrkamp, Frankfurt/Main.
- MOSCA, Francesca (1998): The European approach. In: *The Courier*, no. 171, pp. 35-36.
- NIELINGER, Olaf (1998): Demokratie und Good Governance in Afrika: internationale Demokratisierungshilfe als neues entwicklungspolitisches Paradigma. LIT Verlag, Hamburg.
- NKIWANE, Tandeka C. (1998): Opposition Politics in Zimbabwe: The Struggle within the Struggle. In: *The Politics of Opposition in Contemporary Africa*. Edited by Adebayo O. OLUKOSHI. Nordiska Afrikainstitutet, Uppsala, pp. 91-112.
- NOLTING, Armin K. (2001): External Actors in Processes of Democratic Consolidation. The European Union and Malawi. In: *Democracy and Political Change in the Third World*. Edited by Jeff HAYNES. Routledge, London, pp. 97-114.
- O'DONNELL, Guillermo / SCHMITTER, Philippe C. / WHITEHEAD, Laurence (1986): *Transitions from Authoritarian Rule. Prospects for Democracy*. The John Hopkins University Press, Baltimore / London.

- OESTREICH, Gabriele (1990): Menschenrechte als Element der dritten AKP-EWG-Konvention von Lomé. Sanktionsinstrument oder Zielvorgabe einer Entwicklungszusammenarbeit im Dienste des Menschen. Duncker & Humboldt, Berlin
- OLUKOSHI, Adebayo O. (ed.): The Politics of Opposition in Contemporary Africa. Nordiska Afrikainstitutet, Uppsala.
- PIENING, Christopher (1997): Global Europe: The European Union in World Affairs. Lynne Rienner Publishers, London / Boulder.
- PINTO-DUSCHINSKY, Michael (1997): The rise of "Political Aid". In: Consolidating the Third Wave Democracies: Regional Challenges. Edited by Larry DIAMOND / Marc F. PLATTNER / Yun-han CHU / Hung-mao TEIN. John Hopkins University Press, Baltimore / London, pp. 295-324.
- PRESIDENCY OF THE EUROPEAN UNION: CFSP Declaration concerning Zimbabwe (March 2000), PESC/00/29.
- PRESIDENCY OF THE EUROPEAN UNION: CFSP Declaration concerning Zimbabwe (19.09.2000), PESC/00/133.
- PRESIDENCY OF THE EUROPEAN UNION: CFSP Declaration concerning Zimbabwe (27.09.2000), PESC/00/141.
- RAVENHILL, John (1995): Dependent by Default: Africa's Relations with the European Union. In: Africa in World Politics: Post-Cold War Challenges. Edited by John W. HARBESON / Donald ROTHCHILD. Westview Press, Boulder / Oxford, pp. 95-123.
- REISEN, Mirjam van (1999): Global Player EU. Die Nord-Süd-Politik der Europäischen Union: Analyse – Kritik – Reformansätze. terre des hommes/WEED, Bonn.
- REPUBLIC OF ZIMBABWE / EUROPEAN UNION (1996): Framework of Cooperation. National Indicative Program 1996-2000, Harare.
- RUESCHMEYER, Dietrich / HUBER-STEPHENS, Evelyne / STEPHENS, John D. (1992): Capitalist Development and Democracy. University of Chicago Press, Chicago.
- SCHMIDT, Siegmund (1994): Demokratisierung in Afrika: Fragestellungen, Ansätze und Analysen. In: Systemwechsel 1. Theorien, Ansätze und Konzeptionen. Edited by Wolfgang MERKEL. Leske + Budrich, Opladen, pp. 229-270.
- SCHMIDT, Siegmund (1997): Widerstand gegen Demokratie- und Menschenrechtsinterventionen: Afrika - Erfahrungen mit Zaire und Kenia. In: Demokratieexport in die Länder des Südens? Edited by Rolf HANISCH. Deutsches Übersee-Institut, Hamburg, pp. 297-337.
- SCHMITTER, Philippe C./BROUWER, Imco (1999): Conceptualizing, Researching and Evaluating Democracy Promotion and Protection, EUI Working Paper SPS 99/9, San Domenico
- SORENSEN, Georg (1993): Introduction. In: Political Conditionality. Edited by Georg SØRENSEN. Frank Cass, London, pp. 1-5.

- STIFTUNG WISSENSCHAFT UND POLITIK, Conflict Prevention Network (1998): Zimbabwe. A conflict study of a country without direction, SWP-CPN Briefing Paper, December 1998, Brussels / Ebenhausen.
- SYLVESTER, Christine (1995): Whither Opposition in Zimbabwe?. In: The Journal of Modern African Studies, Year 33, no. 3, pp. 403-423.
- US DEPARTMENT OF STATE, (2000): 1999 Country Report on Human Rights Practices. Released by the Bureau of Democracy, Human Rights, and Labor, February 25, 2000. (http://www.state.gov/www/global/human_rights/1999_hrp_report/zimbabwe.html)
- WHITEHEAD, Laurence (1996): Three International Dimensions of Democratization. In: The International Dimensions of Democratization. Europe and the Americas. Edited by Laurence WHITEHEAD. Oxford University Press, Oxford, pp. 3-25.
- WISEMAN, John A. (1997): The rise and fall and rise (and fall?) of democracy in sub-Saharan Africa. In: Democratization. Edited by David POTTER. Policy Press, Cambridge, pp. 272-293.

A.3 Affirmative Action in South Africa and Namibia: Transforming the Workplace or Maintaining the Status Quo?

Sabine Schmid

A.3.1 Introduction

Affirmative action, broadly understood as the preferential treatment of members of formerly disadvantaged groups, aims at overcoming discrimination and achieving greater social equality. The concept is based on the assumption that the inequalities created by past discrimination cannot be redressed by the mere repeal of discriminatory rules, but that special measures are required to stop the perpetuation of imbalances and to level the playing field. Justifying the concept of affirmative action Duncan Innes stated:

'Let us assume there are two football teams competing against one another. One of the teams has been denied any opportunity to practice and is then required to play with the feet of its members tied together, while the other has had months of training and is allowed to play freely. Untying the feet of the one team will superficially create equality between the two teams, in that a major obstacle to its advancement has been removed. But it is still unlikely to make any serious headway against its competitors due to the lack of training in the past.'¹¹⁷

Thus, only when preferential treatment is given to the disadvantaged team, can the two teams compete against one another on a more or less equal footing.

In this light, affirmative action strategies have been implemented in various countries such as the United States of America, Canada, India, Australia, Italy, Great Britain, Malaysia, Zimbabwe, Sri Lanka, and most recently in South Africa and Namibia. Still, despite the increasing international implementation of affirmative action strategies, the concept has not been without controversy since its first introduction in the United States in the 1960s. The debate centers mainly around the question whether discrimination in favor of the disadvantaged groups can be justified and around the economic consequences of affirmative action programs. Whereas the ethical debate has collapsed into a binary opposition (the reverse discrimination argument versus the positive discrimination one), the economic discussion is hampered by the fact that the direct costs as well as the benefits of affirmative action are difficult to estimate. As such, the findings strongly vary. For instance, while Brimelow / Spencer¹¹⁸ projected that affirmative action reduced United States gross national product by about four per cent in 1992, Conrad¹¹⁹ estimated that affirmative action cost the United States less than one-half of one percent of gross national product a year. Studying the various research on the merits and demerits of affirmative action, which mostly focus on the United States, the findings seem to be guided by the standpoint the individual researcher maintains regarding affirmative action rather than by objective criteria. As such, there is still a need for objective or, to be more precise, inter-subjective studies on the economic consequences of affirmative action. In addition, since 'affirmative action is not necessarily a single strategy [and] there can be a number of different ways of implementing affirmative action,¹²⁰ there is great demand for comparative analysis on it.

¹¹⁷ Innes 1993:9.

¹¹⁸ Brimelow / Spencer 1993.

¹¹⁹ Conrad 1995:34.

¹²⁰ Innes 1993:4.

In accordance with this demand, this study – which is based on a doctoral thesis undertaken from April 1998 to 2001¹²¹ – will compare affirmative action strategy in South Africa with that in Namibia. With regard to the very recent enactment of affirmative action legislation in South Africa (1998) and Namibia (1998), this article will, however, not focus on the socio-economic impact which cannot yet be projected. Instead, it will focus on the interdependent relationship between policy formulation on the macro level and its implementation on the micro level (including the private sector and public services) in the countries concerned. Thereby, the main aim is to analyze whether the affirmative action drafting processes contribute to the success of affirmative action strategies in South Africa and Namibia.

The study is structured in four chapters. Chapter A.3.2 sets out the context for affirmative action in South Africa and Namibia. Chapter two A.3.3 focuses on the affirmative action legislation drafting process, and Chapter A.3.4 analyzes the implementation of the policy. The final chapter summarizes the main findings of the study.

A.3.2 Making the Case

Despite the achievement of majority rule in 1990 and 1994 respectively in Namibia and South Africa, the imbalances created by apartheid rule and colonial conquest still prevailed. Gross inequalities existed in access to health, education, land, employment, and in the distribution of wealth. At the time of independence, the wealthiest 10% of South Africans controlled 50% of national income¹²². The top 5.1% of Namibians controlled over 70% of national income¹²³. Due to past discriminatory laws and practices; socio-economic disparities had a significant race and gender dimension in both countries. The following serves to give some examples. In 1994 in South Africa, 24.7% of the African population but only 3% of the white population were unemployed. With a female/male ratio of 1,38:1, women were more likely to be unemployed than men.¹²⁴ Further disparities were found with respect to income. The Green Paper on Employment and Occupational Equity points out that, in 1996, a third of the black population (including Africans, Indians and coloreds) earned less than R500 a month, compared to fewer than 5% of whites in South Africa. It further states that, in 1996, a white man was 5000 times more likely than an African women to be in a top management position in South Africa¹²⁵

In that light and taking into account that 'those who were disenfranchised must experience practical improvement in their quality of life and standard of living for them to support the democratic order',¹²⁶ the South African and Namibian governments identified affirmative action as a major tool to redress existing inequalities. Despite the fact that every sphere of society was characterized by imbalances due to apartheid and colonialism, both governments decided that the affirmative action policy should focus on the labor market and that the other areas of disadvantage, such as housing, education, transport, and health, should be addressed by other means. The scope of the policy may be justified by the

¹²¹ Cf. Schmid 2002.

¹²² Republic of South Africa 1996:6.

¹²³ Jauch 1998:39.

¹²⁴ Central Statistical Survey 1998c:5f.

¹²⁵ Republic of South Africa 1996:14.

¹²⁶ Govan Mbeki cited in NAFCOC p.2.

employment sector's high degree of visibility and by the ruling parties' political alliance with the trade unions. A further deciding factor in the South African case was that the Black Management Forum, which can be described as the strongest local pressure group for affirmative action, demanded that the policy concentrate on the labor market. Additionally, it may be assumed that the International Labor Organization (ILO), which strongly engaged itself in the affirmative action policy formulation process in South Africa and Namibia, pressured for affirmative action in the workplace.

Although the limited scope of the policy was criticized by some experts, for example Herbert Jauch¹²⁷ in the Namibian case, it was widely recognized by key players (including government, employers' organizations, trade unions, organizations of the disenfranchised) that affirmative action measures are required to redress the existing racial and gender inequalities within the sphere of employment. Taking into account that the advancement and development of the disenfranchised is strongly determined by the institutional culture, both governments started with the formulation of an affirmative action policy that aims not only at bringing about numerical representatives in those areas of employment which have been dominated by the white male minority, but also at transforming the white male corporate culture into one which is all inclusive. As such, the affirmative action policy of both countries goes beyond the American approach, which Mamphela Ramphele describes as follows:

'The American dream was, and still is, seen as the basis of their socio-economic system, and the clamor is not to transform the system but to gain access to it and share the dream.'¹²⁸

A.3.3 The Macro Level: Formulating Affirmative Action

Although there was rarely any disagreement about affirmative action being the appropriate tool to transform the labor market, the question was whether affirmative action should be voluntary or legislated. Whereas the white business community advocated voluntary affirmative action measures in both countries, the ILO and the South African black empowerment groups defended legislated affirmative action. As the Namibian and the South African constitution did not require but permitted parliament to enact affirmative action legislation, the decision was left to the new governments. Thereby, the government's decisions were mostly determined by the dominance of the ruling parties, the existence of affirmative action pressure groups, and the economic situations at the time of political change. As a result of the pressure that came from the black empowerment groups and due to the fact that the ruling party depended on its political affiliates in the national elections and because these took a strong stand towards redistribution, the South African government decided on legislated affirmative action. In addition, due to the failure of employers to implement voluntary affirmative action measures in the past (already in the 1970s the US Government required US multinationals in South Africa to implement affirmative action measures), the arguments of black empowerment groups and the ILO for legislated affirmative action were convincing.

Unlike the South African government, the Namibian one was more afraid that affirmative action would lead to capital out-flow than to a loss in votes. Whereas no local key players

¹²⁷ Cf. Jauch 1998.

¹²⁸ Ramphele 1995:1f.

demanded affirmative action, the business community, which was strongly dominated by foreign interests, argued that the enactment of impending labor and affirmative action legislation would lead to over-regulation of the labor market. This, in turn, would have a negative impact on investments. As the unions had strongly pushed for the Labor Act, the ruling party appeased the unions by enacting the Labor Act and endeavored to secure business community confidence by rejecting the draft bill on affirmative action which the ILO had prepared at the request of the Namibian government in 1991. In order to meet the demands of its voting constituency regarding jobs and socio-economic changes, the ruling party enforced affirmative action in public service and provided for voluntary affirmative action in the private sector. By 1996 however, the Namibian government realized that its affirmative action strategy had failed. Firstly, intensive affirmative action implementation in public service resulted in inflation of the government sector (Namibia has one of the largest civil services in the world and the second largest in Africa¹²⁹), as the constitution provided job security for old public servants. And secondly, the composition of higher employment echelons demonstrated that the private sector had made little progress in changing the disenfranchised population's numerical representation. For instance, in 1995 whites accounted for 52.1% of administrators and managers, while Africans made up only 18.3% of those positions in Namibia.¹³⁰ In addition, the ruling party came under increasing pressure to demonstrate its commitment to redistribution, as the rising unemployment rate (the official unemployment rate rose from 19.1% in 1991¹³¹ to 22.9% in 1997¹³²) and the prevailing socio-economic disparities caused voter dissatisfaction. In light of this, the Namibian government resumed drafting of affirmative action legislation in 1996. Finally, Namibian and South African affirmative action legislation was passed in 1998.

Taking into account that the Namibian affirmative action process was deadlocked for five years, the actual drafting period was shorter in the case of Namibian than in that of South African. However, this should not lead to the misperception that the Namibian government was more committed to the strategy than the South African government, or that Namibian legislation met with less opposition among local key players. The shorter preparation time can rather be explained by the fact that the ruling party perceived the legislation as a tool for winning votes in the pending 1999 national elections, which resulted in a competition for votes for the first time since independence. With affirmative action legislation, the party demonstrated its commitment to job creation, which was a key issue in the elections due to the high unemployment rate. The comparatively fast drafting process of the Namibian legislation can further be explained by the low involvement of local decision makers (including employers' organizations, trade unions, women's and disabled people's organizations). Corresponding to the ruling party's authoritative leadership, the drafting process is characterized by lack of transparency and by the government's failure to consult intensively with local key players. As such, the employer organizations' chief concerns regarding lack of incentives were not addressed. In addition, as the government did not take active steps to overcome prejudices of trade unions, women's and disabled people's organizations that affirmative action only benefits a black elite, neither the unions nor the organizations of the disenfranchised tried to influence the legislation. As such, the largest

¹²⁹ World Bank 1999a:iii.

¹³⁰ Nyman 1997:5.

¹³¹ Central Statistics Office 1994:50.

¹³² UNDP 1998:109.

Namibian trade union federation did not use its political affiliation with the ruling party to influence the Act to a greater extent. In conclusion, the government drafted the act more or less single-handedly in cooperation with the ILO. However, as the Namibian government neither had the expertise nor the financial resources to draft such a piece of legislation, the Act carries the trademark of the ILO rather than that of the Namibian government. As a consequence of the strong impact of the ILO and weak consultation with local actors, employer organizations do not perceive the legislation as a Namibian act. Furthermore, as none of the local stakeholders provoked a public debate and as the legislation was for the most part drafted behind closed doors, the majority of the Namibian population is not aware of the affirmative action legislation.

Similar to its role in Namibia, the ILO also had a crucial impact on South African affirmative action legislation. The ILO supported the South African government financially and seconded an expert to the South African team of legal drafters. Most remarkably, the ILO expert thus involved was actually the principle drafter of the Namibian legislation. However, as the South African government could draw to a greater degree on local experts and due to the government's strong emphasis on consultation with local decision makers, the ILO influenced the South African act to a lesser degree than the Namibian one.

Through the labor market chamber of the National Economic and Labor Council (NEDLAC)¹³³, which considers every proposed labor legislation before it is presented to parliament, South African key players significantly shaped the terms of affirmative action legislation, as most of the NEDLAC proposals were incorporated into the legislation. Still, although NEDLAC as such influenced the Act to a great extent, the impact of various NEDLAC constituencies, namely white and black business, white and black unions, the government, and the community constituency (representing the interests of women, youth, the disabled, and the rural population) varied strongly. Of these members, the white business constituency was least successful in its main proposals, namely incentive-driven affirmative action and limited scope for the Act, because the other parties joined forces in pressuring for far-reaching legislation which is strongly reliant on fines. Unlike this, the black unions representative's recommendation was for the most part incorporated into the Act. Firstly, the black unions' key proposal, for inclusion of a wage equity provision, was also in the interests of the white unions and the community constituency. And secondly, due to the black trade unions representative's political affiliation with the ruling party, which depended on the black unions voting constituency in the elections, the government constituency of NEDLAC for the most part supported its proposals. Additionally, black unions' influence, unlike that of the other parties, was not limited to NEDLAC but expanded to Parliament. As such, even those recommendations which were rejected by the NEDLAC parties were for the most part incorporated during parliamentary negotiations.

¹³³ In correspondence to the ILO Convention no.144: Tripartite Consultation, 1976, the Government of South Africa established NEDLAC as a formal consultation body in 1995. In addition to traditional social partners, NEDLAC comprises organizations which represent community interests. The Council consists of four chambers, namely: the public finance and monetary policy chamber, the trade and industry chamber, the labor market chamber, and the development chamber. Its main aim is to promote the goals of economic growth, participation in economic decision-making, and social equity; seek to reach consensus and conclude agreements on matters pertaining to social and economic policy; encourage and promote the formulation of coordinated policy on social and economic matters; consider all proposed labor legislation before it is introduced to parliament; consider all significant changes to social and economic policies before introduction in parliament (see Republic of South Africa 1994).

Although the South African government focused on the NEDLAC parties in the consultation process, affirmative action legislation was significantly impacted by a non-NEDLAC party, namely the Black Management Forum (BMF). On the basis that the BMF was the first national actor which formulated an affirmative action policy framework, the South African government entrusted a BMF member with the affirmative action drafting process. Thus, the BMF influenced the Act already in the beginning of the drafting process. Furthermore, as the person in charge was also a leading figure of the NEDLAC government constituency and as the BMF had close interconnections with the NEDLAC black business constituency, the BMF also had a significant impact on NEDLAC negotiations. Unlike the BMF, the other non-NEDLAC parties (such as NGOs, academics, and personal practitioners) had only minor influence on the Act. Nevertheless, they significantly impacted the public debate which accompanied the drafting process. Unlike the Namibian legislation, South African affirmative action legislation met with strong opposition and enjoyed staunch supporters. As both parties used the media as a megaphone and as the Act was drafted in a very transparent manner, most South Africans are aware of affirmative action legislation. In addition, as affirmative action promised to be a lucrative market, affirmative action implementation guides and consultants 'shot up like mushrooms'. Strong public awareness and the pressure black empowerment groups put on the South African government contribute to the enforcement of the Act, as the government's dissociation from the Act would not go unnoticed and would discredit the ruling party. On the other hand, the Namibian government can more easily dissociate itself from the legislation, as neither Namibian key players nor the broader public show strong interest in affirmative action. This is particularly true, given that the 1999 elections showed that the voting behavior in Namibia is still guided by deeply rooted patterns of identification with the ruling party rather than by subject related topics.¹³⁴ In that light and taking into account that the Namibian economy is still dominated by foreign interests, it is not surprising that the Namibian government does not enforce the Act as rigidly on the private sector as the South African government does. For instance, in the Namibian case, the public sector was required to report on affirmative action six months before the private sector. In the South African case, reporting deadlines do not distinguish between public and private sectors. Furthermore, whereas the Namibian Act only applies to employers with 50 or more employees, the South African legislation also applies to employers with less than 50 employees but with an annual turnover that is equal to or above the applicable turnover of a small business.

A.3.4 The Micro Level: Implementing Affirmative Action

Given the employers' key role in the implementation of affirmative action policy, it is of crucial importance that they are committed to the legislation's objectives. This is particularly true as numerical representation of the disenfranchised may be legislated but the transformation of institutional culture is for the most part left to employers. Therefore, it is of vital importance that their representatives fully subscribe to the strategy. However, whereas the Namibian employers' organizations perceive the Affirmative Action Act as a piece foreign of legislation, the white South African employers' organizations argue that affirmative action legislation leads to the criminalization of labor law as it fails to stipulate

¹³⁴ Melber 2000:181.

adequate incentives. As those concerns increase resistance against affirmative action on the micro level rather than contribute to mutual understanding and agreement on Act's goals of the, it is not surprising that employer commitment is still lacking. Consequently, the first affirmative action reporting cycle revealed a low compliance level in both countries. In South Africa, 64% of public and private employers with 150 or more employees and, in Namibia, some 50% of private sector employers with 50 or more employees submitted affirmative action reports.¹³⁵ These figures even gloss over the compliance level, as a sizeable proportion of those employers did not report in time or in the correct form or did not fully comply with the requirements laid down in affirmative action legislation. As such, only 45% of South African employers complied fully with reporting requirements, and only 30% of Namibian parastatal organizations fully complied with affirmative action legislation (unfortunately it is not possible to state how the remaining designated employers performed, meaning those with less than 150 employees in South Africa and those within the public service and private sector in Namibia).¹³⁶

Employers' lacking commitment is also mirrored in the composition of the higher echelons of employment, which continued to be dominated by whites. Although comparable figures are scarce and often unreliable, they suggest that Namibian business lags behind South African business in terms of numerical representation of blacks. In 1999, whites accounted for 72.3% of middle to senior management, for 92% of lower to middle management, and for 74.8% of supervisors, professionals, and technicians in Namibia. In comparison, white employees made-up 83.6% of senior management, 61.5% of middle management, and only 52.2% of professionals in South Africa in 1998. These figures and the average percentage of black board members (31%) in Namibian private sector companies further suggest that their affirmative action policy had been strongly focused on top management, while that of South African employers had been concentrated on middle management. Taking into account that lower to middle management constitutes the main pool to draw on for future promotion into higher management echelons, Namibian business promotion practice leads to the assumption that particularly black affirmative action beneficiaries were mainly used as tokens in order to get government contracts and to keep functional interconnections with officialdom. The comparatively lower commitment of Namibian business was also shown in the lack of formal affirmative action policies (in that regard formal means that the policy is officially documented and forms part of the business strategy). Only one quarter of Namibian private sector employers had formulated a formal affirmative action policy by 1998, compared with 42% in South Africa by 1999.¹³⁷

As only the South African government provided a comprehensive report on the findings of the first affirmative action reports, the following in-depth analysis of the workforce composition will focus on South Africa.

Table 1 displays the representation of formerly disadvantaged groups by occupational category in South Africa for 2000.

Although blacks made up 76.16% of the total workforce in 2000, they accounted for merely 28.2% of legislators, senior officials, and managers. The relatively high representation of

¹³⁵ Department of Labor of South Africa 2000; Brandt 2001.

¹³⁶ Department of Labor of South Africa 2000, and Shigwedha 2001.

¹³⁷ FSA-Contact 1998:3 and 1999:15.

blacks in professional staffs was mostly due to the government and local government sectors, which had strongly increased the representation of blacks, in particular Africans, since 1994.

However, whereas the under-representation of blacks was mostly concentrated on the highest occupational category, women were underutilized in every sphere of employment, except in clerical and professional positions where they accounted for 61.09% and 51.58% respectively. Among female employees, black women were hardest hit by discrimination. Although they made up 72.8% of total female employees, they accounted for only 32.41% of female legislators, senior officials, and managers. Still, despite the especially deprived situation of black women, the figures for the disabled are most worrisome. In the context that some 6% of the South African population were disabled in 1999¹³⁸, the group of the disabled was, with 0.52%, most strongly under-represented in the workforce in 2000. The disabled were, however, not only the most underutilized group in employment, they were also least likely to benefit from affirmative action. Evidence therefore is given when comparing the workforce figures for 2000 with those for 1998. The percentage share of the disabled in the total workforce increased only insignificantly from 0.43% in 1998 to 0.52% in 2000¹³⁹.

Table 1: Representation of Formerly Disadvantaged Groups by Occupational Category in South Africa for 2000¹⁴⁰

Occupational Category	Black ¹⁴¹	Female	Disabled
Legislators, senior officials, and managers	28.20%	24.09%	0.59%
Professionals	60.20%	51.58%	0.31%
Technicians and associate professionals	54.33%	39.93%	0.46%
Clerks	62.08%	61.09%	0.63%
Service and sales workers	72.92%	40.18%	0.28%
Skilled agricultural and fishery workers	86.72%	33.83%	0.79%
Craft and related trades workers	57.74%	4.22%	1.04%
Plant and machine operators and assemblers	92.24%	17.19%	0.73%
Elementary occupations	96.72%	28.17%	0.56%
Non-permanent employees	85.78%	50.69%	0.12%
Total	76.16%	36.21 %	0.52%

¹³⁸ Department of Labor of South Africa 1999.

¹³⁹ Department of Labor of South Africa / USAID 1998 and Department of Labor of South Africa 2000.

¹⁴⁰ Department of Labor of South Africa 2000.

¹⁴¹ The category black comprises Africans, coloreds, and Indians.

In comparison, although representation of blacks did not significantly change among legislators, senior officials, and managers, it changed quite dramatically among professionals. Whereas blacks accounted for only 24.7% of professionals in 1998, they made up 60.16% in 2000. Similarly, female representation among professionals was strongly improved, from 30% in 1998 to 51.7% in 2000.¹⁴² Although these figures must be viewed with caution because, firstly, employers had problems classifying their staff in occupational categories and, secondly, survey samples greatly varied, they reveal that affirmative action implementation in South Africa was especially biased towards blacks. This overall trend applied to the private sector as well as to public service. In 2000, blacks accounted for 52.95% of public service management. In comparison, women made up 32.11% and the disabled only 0.43%.¹⁴³

Comparable biases were found with regard to Namibian public service. In 1996, blacks filled 64.9% of management positions, compared with 17.2% women.¹⁴⁴ As the disabled were not even specified in the statistics, it may be assumed that, up to 1996, Namibian public service affirmative action policy had not targeted them. Thus, although Namibian and South African public service was ahead of the private sector in terms of numerical representation of blacks, they were equally bad with respect to the promotion of women and the disabled. Taking into account that the government can directly enforce its policy on public service, the low promotion rates for women and the failure to promote the disabled reflects badly on the ruling parties' commitment to greater social equality. Furthermore, as public service represents government interests, the strong public service promotion biases jeopardize private employers' commitment towards gender equality and the rights of the disabled.

Reasons for the promotion biases may be found, firstly, in the historical recognition of the formerly disadvantaged groups. During the South African and Namibian liberation struggles, the call for empowerment first focused on blacks and only later on women. In contrast thereto, the issue of the disabled was first presented by the ILO during the affirmative action drafting process. And secondly, whereas trade unions, black empowerment groups, and the ruling parties pressured, due to their black male dominated constituency and/or leadership, for affirmative action on the grounds of race, none of those powerful key players were interested in the rights of the disabled, which made up only an insignificant proportion of their members. In addition, although all of those key actors called for gender equality they have never been fully committed to affirmative action on the grounds of gender. This is evident when analyzing the composition of their leadership and their rejection of a female quota system in their own organization. However, whereas the gender issue is at least recognized by those institutions, the issue of the disabled is mostly ignored.

Although the commitment of employers is already low with regard to the achievement of a more equitable workforce, it is even worse in terms of the transformation of institutional culture. This applies to the private sector as well as to public service. As employers perceive affirmative action as a necessary evil rather than as a strategy which positively impacts on productivity and competitive advantage, they only comply with the legislation's minimum requirements and focus on numerical increases for disadvantaged groups, particularly blacks. Hence, institutional culture remains unchallenged and affirmative action appointees

¹⁴² Department of Labor of South Africa / USAID 1998 and Department of Labor of South Africa 2000.

¹⁴³ Department of Labor of South Africa 2000.

¹⁴⁴ Jauch 1998:128.

are required to assimilate to a prevalent white male culture which is based on 'unwritten rules' (for instance, decisions are taken outside the boardroom, meetings are conducted in Afrikaans). The white male culture, however, excludes persons from formerly disadvantaged groups. This trend is reinforced by assessment of employers' affirmative action compliance, which strongly focuses on quantitative criteria. As such, it is not surprising that the review of the first affirmative action reports in South Africa and Namibia revealed that companies failed to formulate clear affirmative action measures which refer to identified job barriers and that the affirmative action measures stipulated were 'extremely superficial and bland'.¹⁴⁵ Past research gave evidence that particularly specific job barriers for the disabled and women were not removed. For instance, of South African employers, only 8.65% had established childcare facilities and only 14.05% had modified their workplace to accommodate persons with disabilities in 1998.¹⁴⁶ The review of affirmative action reports further found that consultation with employees on, and communication of, affirmative action policy at the organizations was for the most part poor.¹⁴⁷ The lack of consultation and communication was, however, not only caused by the employers' missing commitment, but also by the trade unions' lack of interest and/or ability. Hence, most South African and Namibian shop stewards were not prepared to consult effectively with employers on affirmative action or to communicate the policy to employees. This, however, not only undermines legislation monitoring by employees, but also increases existing prejudices against affirmative action in the workplace. Whereas white male employees may fear losing their jobs, employees from disadvantaged groups may expect unrealistic improvements in their career opportunities. Correspondingly, 69% of South African employers had experienced resistance from white employees, and 50% reported inflated expectations from black employees in 1998.¹⁴⁸ This, in turn, may increase inter-group conflicts and may have a negative impact on employee moral. These side effects have already been felt in the high labor turnover of black managers, which is reinforced by 'poaching' of affirmative action candidates. However, as the lack of staff retention negatively impacts on companies profitability with respect to direct costs associated with recruitment, training and development, as well as indirect costs caused by low employee moral, the already low commitment of employers towards affirmative action may drop. This, however, may not only discredit the policy in the public, but may also have a negative impact on job creation as organizations may try to bypass the legislation through outsourcing, down-sizing and company splitting.

A.3.5 Conclusion

In conclusion, the affirmative action policy formulation process has not contributed to a mutual understanding of and agreement on the legislation, as employers' organizations' concerns regarding the strong focus on fines rather than incentives have not been adequately addressed. The lack of support from employers' organizations is particularly worrisome in the Namibian case where the Affirmative Action (Employment) Act is rejected as a piece of foreign legislation, due to strong international influence. However, despite lesser international impact on the South African legislation, some provisions were only

¹⁴⁵ Department of Labor of South Africa 2000, Shigwedha 2001.

¹⁴⁶ Department of Labor of South Africa / USAID 1998.

¹⁴⁷ Department of Labor of South Africa 2000, Shigwedha 2001.

¹⁴⁸ FSA-Contact 1998:22.

included due to the pressure which came from the international experts. Correspondingly, both laws provide for affirmative action on the grounds of disability although none of the local key actors is committed to this issue. Thus, it is not surprising that the first review of affirmative action implementation in South Africa and Namibia has shown that the issue of the disabled has for the most part been ignored. On this basis, it is questionable whether international influence regarding the inclusion of the disabled as a target group of affirmative action legislation will contribute towards their promotion, or whether it would have been more appropriate to formulate a separate policy for the empowerment of the disabled.

However, employer resistance is not only felt with regard to the disabled, but also in terms of the general implementation of affirmative action. As such, the first evaluation of affirmative action implementation in South Africa showed that employers, if at all, only complied with the minimum requirements of the legislation, meaning the numerical increase of formerly disadvantaged groups. Thereby, a comparison of workforce composition revealed that Namibian business lags behind South African business and the private sector behind public service in terms of numerical representation of blacks. Despite those differences, it was found that neither public service nor the private sector had embarked on the formulation of policies aimed at managing the 'numerical uplifting of the disenfranchised' for corporate competitive advantage. Hence, the exclusively white male institutional culture, which undermines the development and advancement of formerly disadvantaged groups, remained unchallenged. As such, the recent affirmative action processes in South Africa and Namibia have not contributed to the transformation of the workplace. Instead, they have resulted in the maintenance of the status quo.

A.3.6 References

- BRANDT, Edgar (2001): Companies Lag on Affirmative Action. In: *The Namibian*, 25 April. [http:// www.namibian.com.na/2001/April/new/01E9D0/D0A.html](http://www.namibian.com.na/2001/April/new/01E9D0/D0A.html) (July 7, 2001)
- BRIMELOW, Peter and SPENCER, Lesley (1993): When Quotas Replace Merit Everybody Suffers. *Forbes*, February 15.
- CENTRAL STATISTICAL SURVEY (1998): Employment and Unemployment in South Africa: October Household Survey 1994-1997, Statistical Release, P0317.10.
- CENTRAL STATISTICS OFFICE (1994): 1991 Population and Housing Census. Windhoek.
- CONRAD, Cecilia A. (1995): The Economic Costs of Affirmative Action. In: *Economic Perspectives on Affirmative Action*. Edited by Margaret C. SIMMS, Joint Center for Political and Economic Studies, Washington, D.C., pp.33-53.
- DEPARTMENT OF LABOUR OF SOUTH AFRICA (1999): Labor Market Statistics 1999. Labor Market Demographics by Province: Disability. <http://www.labour.gov.za> (August 20, 2001)
- DEPARTMENT OF LABOUR OF SOUTH AFRICA (2000): Employment Equity Report: Key Findings of the Reports Submitted by Employers with more than 150 Employees. [http:// www.labour.gov.za](http://www.labour.gov.za) (January 30, 2001)

- DEPARTMENT OF LABOUR OF SOUTH AFRICA and USAID (1998): South African Employment Equity Project: Technical Assistance for the Development of an Employment Equity Legislative and Policy Framework.
- FSA-CONTACT (1998): Affirmative action: Policies & Practices Monitor and Current Survey on Trends and Information.
- FSA-CONTACT (1999): The Namibian Remuneration Survey.
- INNES, Duncan (1993): Affirmative Action. Issues and Strategies. In: Reverse Discrimination. Affirmative Action in the Workplace. Edited by Duncan INNES, Mathew KENTRIDGE, and Helen PEROLD. Oxford University Press, Cape Town, pp.4-22.
- JAUCH, Heribert M. (1998): Affirmative Action in Namibia. Redressing the Imbalances of the Past? New Namibian Books, Windhoek.
- MELBER, Henning (2000): The Culture of Politics. In: Namibia: A Decade of Independence 1990-2000. Edited by Henning MELBER. NEPRU, Windhoek, pp.165-191.
- NAFCOC: Comment on Employment Equity Bill (unpublished document).
- NYMAN, Roselyn (1997): An Overview of the Namibian Labor Market. NALEDI, Johannesburg.
- RAMPHELE, Mamphely (1995): The Affirmative Action Book: Towards an Equity Environment. IDASA Public Information Center, Cape Town.
- REPUBLIC OF SOUTH AFRICA (1994): National Economic, Development and Labor Council Act, No, 35 of 1994. In: Government Gazette, vol. 354, no. 16126.
- REPUBLIC OF SOUTH AFRICA(1996): Green Paper: Employment and Occupational Equity: Policy Proposals, Notice 804 of 1996. In: Government Gazette, vol. 366, no. 17303.
- SCHMID, Sabine (2002) Affirmative Action as a Tool of Transformation. The Cases of South Africa and Namibia. Bochumer Schriften zur Entwicklungsforschung und Entwicklungspolitik, vol. 50, Saarbrücken
- SHIGWHEDA, Absalom (2001): Parastatals Battle to Compile Equality Reports. In: The Namibian, January 10.
<http://www.namibian.com.na/2001/January/news/01C8E1F5A3.html> (February 5, 2001)
- SIMMS, Margaret C. (ed.): Economic Perspectives on Affirmative Action. Joint Center for Political and Economic Studies, Washington, D.C.
- UNDP (1998): Namibia: Human Development Report 1998. Windhoek.
- WORLD BANK (1999a): Namibia: Recent Economic Developments and Prospects. Report No: 19403-NA.

A.4 Encountering Transition in Contemporary Uzbekistan – A Critical Perspective on Foreign Aid and Non-Governmental Organizations

Andrea Berg

A.4.1 Introduction

Over the past several decades it has become a heightened strategy of international development assistance to cooperate with non-governmental organizations (NGOs) in an effort to alleviate poverty. This shift in development policy resulted from a disillusionment with classical patterns of development that focused singularly on governmental reform. In addition, criticism had long noted that aid money more often benefited the rich and corrupt elite than the targeted groups in need. The expectations placed on the role of NGOs are based on a working assumption that they have good access to local populations, well grounded knowledge of a region or country, a flexible organizational structure, are competent in their subject, and more quickly identify problems.¹⁴⁹ Furthermore, an increasing number of NGOs in a certain country are identified with a vital civil society and a growing level of democracy. In spite of the many successes of NGOs noted in development literature, there are a growing number of critics who are beginning to express skepticism about NGOs being a panacea for development. "The strategy of supporting NGOs and LOs [local organizations] has yet to prove its effectiveness in making a major contribution towards the eradication of underdevelopment. There are already signs that a new development myth of unlimited potential of NGOs/LOs to promote sustainable development has been created."¹⁵⁰

Despite limited success stories in developing countries in the so-called Third World, international donor agencies also use this strategy in the countries of Eastern Europe and the former Soviet Union. After the collapse of the Iron Curtain in 1989, the impetus increased to implement technical and financial assistance, as well as to develop civil society and to foster NGOs with the aim of creating Western-style democratic societies. Western donor agencies started what is called "the aid story"¹⁵¹ or "the grant game"¹⁵² in East Central Europe and Russia. Simultaneously, anthropological research in the same region has begun to challenge this approach and has shown the unintended or even non-democratic outcomes of Western aid.¹⁵³ Although the inclusion of NGOs in development policies was initiated to solve problems arising from development assistance the overestimation of their role led to new problems.

In her detailed and fascinating analysis of Western aid to Eastern Europe anthropologist Janine R. Wedel argues:

¹⁴⁹ Cf. Neubert 1997: 31 f.

¹⁵⁰ Schmale 1993: 2.

¹⁵¹ Wedel 2001: 2

¹⁵² Henderson 2000: 3.

¹⁵³ Among others: Hann / Dunn 1996, Wedel 2001.

“In the study of aid and development, little attention has been paid to how aid actually happens. Yet how aid happens – through whom and to whom, under what circumstances, and with which goals – determines not only the nature of what recipients actually get and how they respond to it, but its ultimate success or failure.”¹⁵⁴

In this paper I would like to highlight some of these questions taking into account the case of foreign aid in Uzbekistan.¹⁵⁵ In the first part, I will discuss the definition of NGOs and their role in development policy. Then I will describe the origins and activities of local NGOs. The third part of the paper deals with the activities of donor agencies in Uzbekistan, and the fourth part critically discusses the results of these activities. Part five is the conclusion.

A.4.2 Toward a definition of NGOs in Uzbekistan

The shooting-star of recent development policy is the NGO. But it is not always clear what organization one is talking about or working with. Sociologist Dieter Neubert argues: “The understanding of non-governmental organization is poorly defined and has changed its meaning since its appearance several times.”¹⁵⁶ He writes that the term non-governmental organizations was originally used by the United Nations for organizations working in at least three different countries. Later the definition was also used for smaller organizations working in only one country. Sometimes, non-governmental organization seems to be a “catch-all” definition, used for every kind of non-governmental association or union. In recent development policy discourse, the term is mostly used to describe private charities and development organizations.¹⁵⁷

Despite the problems of a standardized NGO definition, one may find several conformities within the respective definitions: volunteerism, not-for-profit activities, and beneficial activities for the community.¹⁵⁸ Furthermore, Dieter Neubert differentiates between NGOs working for the benefit of the community and self-help organizations working for the benefit of their members. Therefore NGOs are linked with the society at two points of intersection: the public basis and the radius of operation. The public basis is the members, volunteers, and donors; the radius of operation is that part of the society the activities focus on.¹⁵⁹ Taking into consideration the above attributes, what comes into view if we turn to Uzbekistan?

The Soviet Union lacked organizations formed from individual initiative. In the first decades of its existence, the Soviet state destroyed voluntary institutions and organizations and replaced them with organizations that followed state orders and promoted the ideas of Marxism-Leninism. “With the abolition of the voluntary institutions of civil society, its characteristic features disappeared. Individual values represented by these institutions were eliminated from public life and were replaced by the values of the Party/state.”¹⁶⁰ Only in the

¹⁵⁴ Wedel 2001: 6.

¹⁵⁵ This paper is based on field research in 1999 and 2000 in Uzbekistan. It is part of my Ph.D. project: „The Role of Non-governmental Organizations in Uzbekistan. Global Rhetoric and Local Reality.“ All translations and interpretations, except where noted, are by the author.

¹⁵⁶ Neubert 1997: 32.

¹⁵⁷ Cf. Neubert 1997: 33 f.

¹⁵⁸ Cf. Wahl 1997: 313, Neubert 1997: 16, Ruffin 1999: 12.

¹⁵⁹ Cf. Neubert 1997: 74 ff.

¹⁶⁰ Rau 1991: 10.

late 1970s did tiny voluntary groups of dissidents, environmentalists, pacifists, sports fans, and others reemerge.¹⁶¹

In Uzbekistan as well as in other republics of the former Soviet Union, public organizations like the Komsomol, trades-unions, women's unions, and sports clubs existed. Membership was obligatory rather than voluntary. In addition to these state-driven organizations, informal networks of neighbors, colleagues, kin, or classmates were of utmost importance for socio-economic life in Uzbek society in the Soviet era. They were necessary for obtaining goods and services and getting access to certain institutions or professions. Aline Coudouel et al. even argue that "...in many respects, this was the only manifestation of civil society that remained under state socialism..."¹⁶² And David Abramson describes developments in the post-Soviet era thus: "Uzbekistan is a society where social networks are a highly valued resource precisely because they help to maintain civility. Very little is accomplished without them."¹⁶³ Although informal networks are based on volunteerism and realize not-for-profit activities, they mainly work for the benefit of their members. Therefore, they are self-help rather than non-governmental organizations.

Furthermore, after national independence in 1991 dozens of organizations mushroomed which called themselves social organizations, non-governmental organizations, foundations, associations, etc. Mark Waite classifies today's voluntary organizations in Central Asia into three categories: social organizations, NGOs, and community organizations. Social organizations were established in the Soviet era to work in the welfare sector. They continue to have close relationships with governmental and administrative institutions. NGOs initiated by a group of individuals independently from the state are a new phenomenon in Central Asia. Both types of organizations must be registered with the Ministry of Justice. Community organizations in a participatory sense are very rare and tend to be based on a common interest than on residence.¹⁶⁴

In imitation of this classification and in using the characteristics of non-governmental organizations discussed above, I classify voluntary organizations in Uzbekistan as follows: (1) governmental organizations, (2) non-governmental organizations, and (3) informal networks. By governmental organizations I mean reestablished organizations from the Soviet era or newly established organizations on the order of the president or a regional mayor gaining financial and material support from governmental institutions and implementing the ideas of the state.¹⁶⁵ I use the term local NGOs for indigenous, non-governmental, not-for-profit organizations registered with the Ministry of Justice and working for the benefit of the Uzbekistani society or a certain target group. Informal networks are local unregistered organizations based on mutual exchange and reciprocal work for the benefit of their members. Although all kinds of organizations belong to Uzbekistani society, in this paper I will focus on local non-governmental organizations and the effects of foreign aid.

¹⁶¹ Cf. Rau 1991: 14.

¹⁶² Coudouel 1997: 207.

¹⁶³ Abramson 1999a: 1.

¹⁶⁴ Cf. Waite 1997: 225-229.

¹⁶⁵ Examples of this type of organization are the Fund *Mahalla*, Fund *Ecosan*, *So'g'lom avlod uchun* Fund (Fund for a Healthy New Generation), The Uzbek Women's Committee, Fund *Navruz*, Fund *Bolalar* (Children's Fund), the National Human Rights Center of the Republic of Uzbekistan, and others.

A.4.3 Origin and activities of local NGOs in Uzbekistan

Uzbekistan is the most populous state in Central Asia with 24 million inhabitants and is rich in natural resources. The last decade was characterized by political and economic changes although they were often only nominal. Referring to these reforms, Marat Terterov argues that "...in Uzbekistan, it may be more accurate to speak of substitution, or an over-haul of one set of institutions by another, as opposed to the physical removal of structures."¹⁶⁶ Uzbekistan faces serious economic problems resulting in unemployment and poverty. The state still dominates large parts of the financial and economic as well as the political system. "The population has been largely passive and pro-government, but increasing poverty and repression give considerable cause for concern about more activist politics, which in some cases will involve recourse to violence."¹⁶⁷

The activities of international organizations in Uzbekistan did not begin before 1994. At that time, the United States improved its relationship with Uzbekistan¹⁶⁸, foreign investors appeared, and in November the first NGO-conference took place, organized by a former Peace Corps Volunteer.¹⁶⁹ Since then, several foreign governmental and private donor agencies have begun to spread the concept of civil society in Uzbekistan and the number of non-governmental organizations has rapidly increased. The third UNDP's National Human Development Report for Uzbekistan in 1997 lists 200 registered non-governmental organizations of which more than 70 are national cultural centers and more than 20 funds and charitable organizations. The 1999 report adds over 40 women's organizations to these numbers. On April 14, 1999, a new law "Non-governmental, non-commercial organizations" was passed and came into effect on May 8, 1999. Furthermore, a "Committee on democratic institutions, NGOs, and organs of self-governance of citizens" was established on February 11, 2000, in the national parliament (Oliy Majlis). Today, official sources list more than 400 NGOs in Uzbekistan.

According to an internet database of Counterpart Consortium, 50 percent of the 465 registered NGOs are based in the capital Tashkent, 13.9 percent in the Karakalpak Autonomous Republic, 10.5 percent in Ferghana, 9.0 percent in Samarkand, 5.1 percent in Bukhara, 3.0 percent in Andijon, 2.7 percent in Namangan, 1.5 percent in Khorezm, 1.5 percent in Kashkadarye, 0.8 percent in Jizak, 0.6 percent in Surkhandarye, and 0.4 percent in other regions. Thus we can see a clear center-periphery gap.¹⁷⁰

If we look at the activities of local NGOs, most of them are involved with issues of the disabled (13.6 percent), followed by children and youth issues (10.3 percent), health (8.4 percent), and women's issues (7.5 percent). Other spheres of activities are education (7.0 percent), ecology (7.0 percent), artists (6.6 percent), ethnic cultural (3.6 percent), social (3.1 percent), media (2.7 percent), and others (12.9 percent).¹⁷¹

¹⁶⁶ Terterov 1999: 1.

¹⁶⁷ International Crisis Group 2000a: 13.

¹⁶⁸ Roy 2000: 133.

¹⁶⁹ Abramson 1999b: 243.

¹⁷⁰ www.cangonet.kg.

¹⁷¹ www.cangonet.kg. This list includes multiple registrations.

The analyses of the interviews I conducted with representatives of local NGOs clearly showed that most organizations originated due to the incentives of international organizations.¹⁷² The interviewed representatives learned of the very existence of a concept like NGO due to seminars and training of trainers conducted by donor agencies and very quickly discovered the potentials of the "aid business": exceptionally well paid salaries, business trips to foreign countries, and well equipped offices. Except for the Business Women's Association (Usb.: *Tadbirkor Ayol Uyushmasi*) and the "For Ecologically Clean Fergana" association ("*Ekologik toza Fargona uchun associaciasi*"), no local NGOs were established before 1995. Thus, the majority of local NGOs was established after the appearance of donor agencies.

A.4.4 Donor activities in Uzbekistan

Foreign organizations and foundations working in Uzbekistan are several United Nations agencies coordinated by the United Nation Development Program (UNDP), the World Bank, the Asian Bank of Development, the European Union's TACIS Program, the Organization for Security and Cooperation in Europe (OSCE), Winrock International, Counterpart Consortium, the Eurasia Foundation, the Open Society Institute – Soros Foundation, Save the Children Foundation, NOVIB, the GTZ, and others.

One main focus of these international organizations is the development of democratic political institutions and support of market economy. The priorities of the second country cooperation framework 2000-2004 between UNDP and the Uzbek government are for instance:

- (a) political liberalization, which includes the participation of civil society, developing non-governmental organizations (NGOs) and advancing human rights; (b) governance and administration, with the aim to continue the administrative-reform process, promote self-governance, and foster human-resource development and capacity building; and (c) economic liberalization, which includes taking measures to reduce government regulatory functions, to advance institutional and legal reform, and to develop small- and medium-sized enterprises (SMEs)."¹⁷³

In general one may identify two different approaches among international organizations supporting local NGOs. The aim of the first group is to foster and support NGOs; the second group cooperates with local NGOs to implement their own projects and gain access to vulnerable groups. Examples of the first group are the "NGO Support Initiative in Central Asia" by Counterpart Consortium, which "supports the growth of democratic and sustainable local NGOs that make a difference in people's lives in Central Asia"¹⁷⁴, and the OSCE office in Tashkent, which supports local NGOs "strengthening their capacities to effect social change, to assist them in developing links among themselves, and to help them improve their ties with local governmental authorities"¹⁷⁵. Examples of the second group are Abt Associates Inc. implementing a health care project and UNDP implementing a micro credit project in both cases in cooperation with local NGOs.

¹⁷² During my field research, I conducted interviews with representatives of 20 local NGOs and observed their activities.

¹⁷³ United Nations 2000: 2.

¹⁷⁴ English flyer by Counterpart Consortium Tashkent.

¹⁷⁵ Unpublished draft by the OSCE on the occasion of the NGO Strategy Development Meeting in Chimgan, December 10-13, 1999.

Besides the general focus on civil society, every foreign organization has its own aid programs and priorities. Their projects in Uzbekistan include education, social services, private sector development, food production, health care, media assistance, environmental problems, developing non-governmental organizations, and many others. They provide training and seminars for local activists, organize conferences and workshops and strengthen dialogue between governmental institutions and NGOs.

The activities of foreign organizations in Uzbekistan not only have a thematic, but also a financial aspect. NGOs in Uzbekistan are mostly dependent on foreign assistance and foreign funding. Anna Gonorskaya wrote that "the main sources of financing for Uzbek NGOs are resources received from international donors (51.8%), from state institutions (1.4%), local charity and commercial organizations (9.8%), private donations (3.3%), entrepreneurship (11.7%), and membership fees (18.1%)."¹⁷⁶ This data illustrates the importance and responsibility donor organizations have in Uzbekistan. Unfortunately, the results of foreign aid are very problematic.

A.4.5 Unintended outcomes of foreign aid

In the following section I will discuss the sometimes counterproductive results of foreign aid in Uzbekistan. This is not a plea for the discontinuation of foreign aid but an effort to highlight the problems resulting from exporting ideas and concepts, even with the best of intentions, into an alien social and economic framework. These outcomes are:

- thematic contradiction of NGO activities
- emphasis on quantitative results
- increasing professional manner instead of volunteerism
- increasing jealousy and rivalry among local NGOs
- dominance of certain NGOs
- splintering of NGOs and emergence of a new elite

A.4.5.1 Thematic contradiction of NGO activities

Due to the importance of foreign donations, local NGO programs often conform to donor agency priorities. Janine R. Wedel explains:

"A recent Carnegie Endowment-sponsored study of foreign funded NGOs in Central and Eastern Europe and the former Soviet Union found that local groups proliferated in Poland, Hungary, Russia, Kazakhstan, Uzbekistan, and Kyrgyzstan often around issues that Western donors found important, but rarely around issues that locals confronted on a daily basis."¹⁷⁷

This indeed reflects my own experience. The development of women's NGOs is one result of this tendency. Although women's issues rank only fourth in the Counterpart database, activities focusing on disabled persons, youth, and health often give priority to problems of women and girls and fit well with women's projects. Since many foreign donors focus on

¹⁷⁶ Gonorskaya 2001: <http://www.cango.net.kg/007.asp> visited on July 16, 2001.

¹⁷⁷ Wedel 2001: 110.

women's issues such as reproductive health, legal literacy, and domestic violence¹⁷⁸, many local NGOs do so, too. As a result of this, "priorities" set up by foreign organizations women's crisis centers and hotlines are mushrooming all over the country.

Problems occur, when donor agencies shift their attention to other priorities. Experience in East Central Europe and Russia shows that declining financial support has led to substantial problems for local NGOs since they depend on foreign money and lack a local advocacy network.¹⁷⁹ A similar development might be expected in Central Asia and Uzbekistan. Elvira Pak, representative of the Kazakh Najada-network of women's NGOs, pointed out during a presentation that donor agencies are beginning to shift their focus. While during the 1990s women's issues were favored, now priority is being given to security and environmental issues.¹⁸⁰ Although the effects on local NGOs in Uzbekistan still remain unclear, they are only able to work sustainably if they learn to rely on local desires and needs instead of orientating solely to donor policies.

A.4.5.2 Emphasis on quantitative results

Another effect of foreign aid in Uzbekistan is the emphasis on short-term projects with quantitative results. This is due to the way donor agencies work. They are under obligation to supporters and financiers in their home countries and must demonstrate successes to receive further funding. In the case of local NGOs, this means that a certain NGO cooperates with a certain donor agency within a limited period.¹⁸¹ They sign a contract and the local NGO pays several trainers to implement the foreign project and to conduct seminars. After the end of the project, the NGO looks for a new contract, possibly with another donor organization with other priorities. Thus, local NGOs react rather than act and must adapt to donor requirements to ensure their existence.

To convince donor agencies to cooperate with them, local NGOs mimic their emphasis on quantitative results.¹⁸² When I asked representatives about the activities of their respective NGOs, they very often answered that they conducted X seminars in Y villages. Only very few of the NGOs analyzed worked with the same group of people for a longer period. Most seminars are one-time events without further consequences. Donor agencies are hardly able to evaluate the work of their local counterparts. Most of them have their headquarters in the capital Tashkent; program directors or staff members fly for one or two-day seminars to the provincial capitals and meet their local partner NGO. They ultimately have limited time to

¹⁷⁸ According to the UNDP "Report on the Situation of Women in the Republic of Uzbekistan" the following organizations support women's issues: (1)USA: USAID, USIS, Eurasia, Counterpart Consortium, Peace Corps, National Endowment for Democracy, Carnegie Foundation, Soros Foundation, Winrock International, Global fund for Women – focus on health care, reproductive health, education, NGO support, gender-projects, micro credit projects, access to information; (2) Germany: Konrad-Adenauer-Foundation, German Embassy – focus on NGO support, democracy development, health care, reproductive health, legal literacy; (3) Great Britain: Know-how fund, Save the Children, British Council, British Embassy – focus on NGO support, technical support, health, access to information, organization of conferences and seminars; (4) Netherlands: NOVIB, Helvetas Caritas – focus on NGO support, environment, health, gender problems, conflict management, organization of conferences. See UNDP 1999: 76.

¹⁷⁹ Cf. McMahon 2000, Henderson 2000.

¹⁸⁰ Presentation on April 13, 2002, in Berlin, House of the Cultures of the World.

¹⁸¹ Mostly six to twenty four months.

¹⁸² There is no denying that quantitative results are one useful component of project evaluation.

see the real situation of the target group the NGOs claim to represent and not enough knowledge of the local language.

The same holds true for NGOs and foreign aid in Russia. Sarah Henderson argues:

“Thus analyses tend to focus on numbers, which are easy to measure and count. For Russian aid recipients, the focus on reporting back to their local donor is similar. Projects are evaluated on whether the recipient met the goals of the original proposal, not on qualitative results.”¹⁸³

The pressure to demonstrate countable results arising from foreign aid financial incentives hinders orientation toward problems which can only be solved in the long term and which have open results. Thus, local NGOs neglect their local context and focus mainly on external priorities. They lack what Neubert called a public basis (see above).

A.4.5.3 Increasing professional manner instead of volunteerism

Volunteerism is one of the very few factors most definitions of the term NGOs include. It is also to be found in the Uzbek NGO-Law. On the other hand, it is well known that aid is the business a lot of consultants, project employees, and scholars in the “donor countries” and that local NGO trainers and staff members in the “recipient countries” earn their living from it as well.

Donor organization financial incentives in Uzbekistan tend to undermine volunteerism and instead to create jobs for a couple of individuals. Thus, foreign aid results in increasingly professional staff and the tendency for local NGOs to resemble consulting firms. Although some of the NGO leaders interviewed were financially supported by their families, work in their respective NGOs was the only source of income for most of them and their staff members. They escaped unemployment or low wages in the public sector. Several staff members work in NGOs and have a second job in addition. Thus, volunteerism is rarely found, mostly among young students working for the NGOs without payment.

The problem of lacking volunteerism is likely not only a result of foreign aid. During the Soviet period, membership in public organizations was obligatory rather than voluntary. The concept of volunteerism was caricatured by the governmental organization of social life. The local population makes hardly any distinction between public organizations from the Soviet era and the new NGOs. On the contrary, indigenous informal networks based on volunteerism are not taken into consideration by donor agencies. They tend to work with registered groups, which means NGOs, and to create a highly formalized voluntary sector. Furthermore, only registered NGOs are allowed to open a bank account, which is necessary to receive a grant. Therefore, various groups made strive to achieve registration. Sampson hit the nail on the head when he argued: “Social networks can’t get grants, but autonomous associations can.”¹⁸⁴

Gap (Uzb.: conversation), a social gathering, and *hashar* (Arab.: heap, group), a rotating labor exchange, are among such informal networks in Uzbekistan. They are regular but open-ended relationships based on mutual support, exchange, and trust and are a strategy to cope with socio-economic needs. In addition to their “original” function, they often provide emotional and financial support during difficult times. Informal networks are

¹⁸³ Henderson 2000: 26.

¹⁸⁴ Sampson 1996: 141.

potential resources for political participation as well as being political agents themselves. Within informal networks, people learn to discuss their problems and to realize ideas and perspectives with other members of their network, that is to say, they gain civic skills. In a country like Uzbekistan, where legal political participation can be of personal risk, activities within informal networks are less dangerous for their members. Indeed, it must be said that political activities within those networks in Uzbekistan are currently very limited. Nevertheless, they are of utmost importance for all spheres of socio-economic, religious, and political life.

Donor agencies fostering NGOs and civil society in Uzbekistan tend to ignore informal networks for two reasons. (1) They are mainly based in the capital Tashkent and have little information about these networks, their function, and importance. (2) If donors are aware of these networks, they do not recognize them as part of the civil society because they act on a local level without using global concepts and definitions determining development policy. Donor agencies instead tend to cooperate with the most visible and well-known NGOs regardless of their acceptance at the local level, because they lack information from the target groups. Thus, they seem to sustain and support the system of hierarchy and foster unbalanced ties of NGOs with the international community rather than the local one. To strengthen volunteerism and to counter professionalization, donor agencies should rely on local volunteerism concepts. Only if NGOs lose the bad image of "forced volunteerism" remaining from the Soviet era will a public base for the voluntary sector emerge.

A.4.5.4 Increasing jealousy and rivalry among local NGOs

"Women's NGOs in Uzbekistan have traditionally been unable to sustain collaborative efforts, succumbing to continued competitiveness and rivalry."¹⁸⁵ This is the introduction to an article in the NGO-Bulletin "Theory and Practice" on continued efforts to bring various women's NGOs under one heading and to coordinate their activities in the sphere of reproductive health. This general opinion of the relationship among local NGOs was widespread and was shared by representatives of donor agencies as well as of local NGOs. One informant told me that the relation between women's NGOs and NGOs working on behalf of the disabled are especially marked by jealousy. Due to this rivalry, NGOs do not talk about grants and try to hoard their information. Such tendencies hold true in other regions of the former Soviet Union, too. Sarah Henderson wrote about her observations in Russia:

"Rather than building networks and developing publics, groups consciously retained small memberships, hoarded information, and engaged in uncooperative and even competitive behavior with other civic groups. In short, groups pursued individual short-term gains rather than collective, long-term development."¹⁸⁶

In addition to the struggle for financial resources there is a second reason for rivalry: friendship or quarrels among certain NGO leaders. Since local NGOs are identified with their respective leader, personal relations influence cooperation and work styles. Joint seminars or business trips contribute to the consolidation of an "inner circle" of chosen NGOs leaders while excluding others. The importance of personal relations is a legacy from the Soviet era and was also observed by Janine R. Wedel: "Central and Eastern European groups often

¹⁸⁵ Theory and Practice 4/1999.

¹⁸⁶ Henderson 2000: 6.

were unwilling to share information or otherwise cooperate with anyone who had not reached the status of personal friend."¹⁸⁷

This is of utmost importance, since the flow of information between donor agencies and NGOs and among NGOs in Uzbekistan is determined by a center-periphery drop. Most of the donor agencies have their offices in Tashkent, and the number of NGOs there is proportionately high. In comparison to NGOs in the provincial capitals, they have better access to information and resources from abroad. This initial advantage is strengthened by lacking communication among local NGOs and brings certain NGOs into a strong position. Thus, weaker NGOs are either excluded from information and therefore from financial support by foreign donors or they build alliances with stronger and more dominant NGOs. Unfortunately, these alliances are based on hierarchical grounds rather than on equal relations.

A.4.5.5 Dominance of certain NGOs

The strong position and dominance of certain NGOs results from three main factors: location, date of establishment, and personal relations with donor agencies. While some organizations are very good in establishing and using relations to foreign donor agencies, others fail. The most remarkable example of a very dominant NGO is the Business Women's Association. Established in 1991, this NGO is well organized and has branches in all regions and towns of Uzbekistan. In several towns, the Business Women's Association holds a broker-like position between other local NGOs and foreign donors. Since the branches were very often the first NGO in their respective town, they received dozens of grants. Furthermore, donor agencies like to work with organizations they already know. Thus, the Business Women's Association is in a favorable position.

Nevertheless, the leaders of local branches or other local NGOs try to establish their own relations with donor agencies. This leads to new conflicts and jealousy. During my field research, I observed such conflicts twice. While the headquarters of the Business Women's Association cut its branches off from all resources, the branch leaders needed to find donor agencies which were not already taken by the headquarters. Besides the Business Women's Association, other NGOs which were established early dominate the NGO sector, too. Several "younger" NGOs lamented the fact that, on the one hand, "older" NGOs blockade information and resources and, on the other hand, donor agencies lack information or sensitivity in understanding and countering the situation.

This work style is not exclusive to Uzbekistan. Various authors mentioned the center-periphery drop and donor agencies' preference for certain NGOs.¹⁸⁸ As I mentioned above, "younger" or weaker NGOs must look for alliances and cooperation. In most of the cases I observed, these alliances are purposeful and create patron-client relations.

¹⁸⁷ Wedel 2001: 113.

¹⁸⁸ Among others: Henderson 2000, Sampson 1996, Grunberg 2000, Hunt 2001.

A.4.5.6 Splintering of NGOs and emergence of a new elite

A further outcome of foreign aid, which is closely connected with the tendencies mentioned above, is the splintering or spin-off of local NGOs. Since a vital civil society is often identified with a growing number of NGOs, recent developments in Uzbekistan should be a success. This view does not take into account that most of the NGOs analyzed consist of only a couple of people without a public basis. Due to financial incentives, more and more individuals establish "their own" NGO. After gathering experience and information on how to work in the aid business in one NGO, members leave to establish a new one. In recent publications, this trend is called non-governmental individuals (NGIs).¹⁸⁹ Pauline Jones Luong and Erika Weinthal wrote on Kazakh environmental NGOs:

"The disconnect between LNGOs [local NGOs] and the local population has had two concrete effects. (1) It has produced what we call 'spin-off NGOs'; and (2) it has led to the phenomenon of NGIs, or Non-Governmental Individuals. Both of these undermine the development of a vibrant civil society, and hence, democracy building."

Local NGOs in Uzbekistan use splintering as a strategy to increase their chances of receiving a grant. First, an NGO declares several focal points. If it receives a grant, the staff members leave to establish their own NGO. In future, they are able to apply for further grants and are supported by their "mother" NGO. On the other hand, the position of the "mother" NGO is strengthened, since the spin-off NGO contributes to its reputation and influence. Therefore, they maintain their key position between international donors and the local population. They profit from the lack of communication between both sides. Since donor agencies accept NGOs as "representatives" or "speakers" of a target group in need, they seem to sustain and support the system of hierarchy and foster unbalanced ties of NGOs with the international rather than the local community.

A.4.6 Conclusion

The incentives and desired possibilities of financial aid have resulted in a growing number of NGOs and NGO activities in Uzbekistan. Due to artificial conditions, most NGOs are not grass-rooted or embedded in their environment. Instead of focusing on local support, they only intensify their relations with foreign donors. In my opinion, this is a dangerous starting point for the future when foreign assistance declines and the aid caravan moves on to the next region of interest. The situation in East Central Europe has already reached this point. McMahon observed that in Poland "in the last few years declining international support for the region has contributed to substantial problems among women's groups."¹⁹⁰ While focusing on donor priorities, NGOs in Uzbekistan run the risk of losing the chance to develop ideas based on their own experience and background.

Although some NGO representatives criticize donor activities, they are dependent on grants and assistance. Few of them consider their target group's needs and desires. Donor agencies stimulate this tendency. For now, they lack diligence, because, to a great extent, they work with the most visible and well-known NGOs. On the one hand, the "success" of these NGOs results from good networking and is connected with the assumption that "development" or "civil society" is somehow countable. Representatives of those NGOs

¹⁸⁹ Among others: Jessen 1994, Hunt 2001, Luong / Weinthal 1999, Henderson 2000.

¹⁹⁰ McMahon 2000: 11.

reinforce the importance of quantity by proudly talking about the number of training seminars they conducted or the number of people who took part in them or who called their hotline. On the other hand, donor agencies prefer to trust those they consider to be "leaders" and "brokers", and resources are routinely placed in a single individual's hands.

Although non-governmental organizations are important, they are not the only actors in the fairly active Uzbekistan society. Networks of kin, neighbors, and colleagues are manifestations of shared socio-economic needs and common strategies to cope with these needs. Instead of only focusing on cooperation with non-governmental organizations, foreign agencies should include local groups, communities, and networks in their activities.¹⁹¹ While non-governmental organizations are a relatively new phenomenon in Uzbekistan and often do not reach beyond the urban context, local networks and other groups represent an indigenous kind of interest group, whether economic, social, or religious. Only if foreign organizations as well as NGOs learn to rely on already existing local ideas and strategies will aid become rooted and productive. By cooperating with all actors and combining their potential, foreign aid could do a great deal to gain and establish vital projects tailored for the respective local context.

A.4.7 References

- ABRAMSON, David M. (1999a): Civil Society and the Politics of Foreign Aid in Uzbekistan. In: Central Asia Monitor, no. 6, pp. 1-12.
- ABRAMSON, David M. (1999b): A Critical Look at NGOs and Civil Society as Means to an End. Uzbekistan, a case study. In: Human Organization, no. 3, vol. 58, pp. 240-250.
- ALTVATER, Elmar / BRUNNENGRÄBER, Achim / HAAKE, Markus / WALK, Heike (eds.): Vernetzt und verstrickt. Nicht-Regierungs-Organisationen als gesellschaftliche Produktivkraft. Münster.
- COUDOUEL, Aline / McAULEY, Alastair / MICKLEWRIGHT, John (1997): Transfers and Exchange between Households in Uzbekistan. In: Household Welfare in Central Asia. Edited by Jane FALKINGHAM / Jeni KLUGMAN / Sheila MARNIE / John MICKLEWRIGHT. London / New York, pp. 202-220.
- FALKINGHAM, Jane / KLUGMAN, Jeni / MARNIE, Sheila / MICKLEWRIGHT, John (eds.): Household Welfare in Central Asia. London / New York
- GONORSKAYA, Anna (2001): Top ten of Instruments of an Uzbek Fundraiser. In: Initiative, No 10. <http://www.cango.net.kg/007.asp>
- GRUNBERG, Laura (2000): Women's NGOs in Romania. In: Reproducing Gender. Politics, Publics, and Everyday Life after Socialism. Edited by Susan GAL / Gail KLIGMAN. Princeton, pp. 307-335.
- HANISCH, Rolf / WEGNER, Rodger (eds.): Nichtregierungsorganisationen und Entwicklung. Auf dem Weg zu mehr Realismus. Hamburg

¹⁹¹ My findings from Uzbekistan have a certain similarity to Mirka Dreger's discussion of the decentralization process in Benin in this volume. She calls into question the role of non-governmental organizations and pleads for an active inclusion of villages and other local actors in the development planning process.

- HANN, Chris / DUNN, Elizabeth (eds.) (1996): *Civil Society. Challenging western models.* London / New York.
- HENDERSON, Sarah 2000: *Russia's Virtual Civil Society. Foreign Aid and Civic Development.* <http://pro.harvard.edu/papers/013/013013HendersonS.pdf>.
- HUNT, Martina (2001): 'Top down – bottom up'? A Study of Women's Participation in NGOs in Kyrgyzstan. INTRAC Research Report, Oxford.
- INTERNATIONAL CRISIS GROUP (2000a): *Central Asia. Crisis Conditions in Three States.* Brussels. ICG Asia Report no. 7.
- JESSEN, Brigitte (1994): *Fremdhilfe und die Mobilisierung interner Ressourcen dargestellt am Beispiel der NGO-Arbeit in Bangladesch und Thailand.* In: *Nichtregierungsorganisationen und Entwicklung. Auf dem Weg zu mehr Realismus.* Edited by Rolf HANISCH / Rodger WEGNER. Hamburg, pp. 45-68.
- LUONG, Pauline Jones / WEINTHAL, Erika (1999): *The NGO Paradox. Democratic goals and non-democratic outcomes in Kazakhstan.* In: *Europe-Asia Studies*, no. 7, vol. 51, Pp. 1267-1284.
- McMAHON, Patrice C. (2000): *Building Civil Societies in East Central Europe. The effect of American NGOs on Women's groups.* <http://pro.harvard.edu/papers/013/013004McMahonPat.pdf>.
- NEUBERT, Dieter (1997): *Entwicklungspolitische Hoffnungen und gesellschaftliche Wirklichkeit. Eine vergleichende Länderfallstudie von Nicht-Regierungsorganisationen in Kenia und Ruanda.* Campus Verlag, Frankfurt / New York.
- RAU, Zbigniew (1991): *Introduction.* In: RAU, Zbigniew (ed.): *The Reemergence of Civil Society in Eastern Europe and the Soviet Union.* Boulder et al. pp. 1-24.
- ROY, Olivier (2000): *The New Central Asia. The Creation of Nations.* New York.
- RUFFIN, Holt M. (1999): *Introduction.* In: *Civil Society in Central Asia.* Edited by Holt M. RUFFIN and Daniel WAUGH. Seattle et al. pp. 3-27.
- SCHMALE, Matthias (1993): *The Role of Local Organizations in Third World Development. Tanzania, Zimbabwe and Ethiopia.* Aldershot et al.
- SAMPSON, Steve (1996): *The social life of projects. Importing civil society to Albania.* In: *Civil Society. Challenging western models.* Edited by Chris HANN / Elizabeth DUNN. London / New York, pp. 121-142.
- TERTEROV, Marat (1999): *NGOs and the private sector in the Republic of Uzbekistan. Towards a new partnership in complimentary social development.* INTRAC Research Report, Oxford.
- UNITED NATIONS (2000): *Second Country Cooperation Framework for Uzbekistan (2000-2004).* (DP/CCF/UZB/2)
- UNITED NATIONS DEVELOPMENT PROGRAMME (1999): *Doklad o položenie žensčin v Respublike Uzbekistan.* Taškent.
- WAHL, Peter (1997): *Mythos und Realität internationaler Zivilgesellschaft. Zu den Perspektiven globaler Vernetzung von Nicht-Regierungs-Organisationen.* In:

Vernetzt und verstrickt. Nicht-Regierungs-Organisationen als gesellschaftliche Produktivkraft. Edited by Elmar ALTVATER / Achim BRUNNENGRÄBER / Markus HAAKE / Heike WALK. Münster, pp. 293-314.

WAITE, Mark (1997): The Role of the Voluntary Sector in Supporting Living Standards. In: Household Welfare in Central Asia. Edited by Jane FALKINGHAM / Jeni KLUGMAN / Sheila MARNIE / John MICKLEWRIGHT. London / New York pp.: 221-249.

WEDEL, Janine R. (2001): Collision & Collusion. The strange case of Western aid to Eastern Europe. St. Martin's Griffin, New York.

A.5 A Call for Development Partnerships in the Framework of Current Decentralization Processes in West Africa (case study Benin)

Mirka Dreger

A.5.1 Introduction

In many African countries, a vicious circle of economic and political underdevelopment can be observed.¹⁹² This has a considerable impact on the capacity of the state which is more and more dependant on a multitude of actors to fulfill and guarantee public services. At the same time, African people are starting to mobilize themselves in the form of "grassroots initiatives" or a broad spectrum of NGOs (Non-Governmental Organizations) in the service of development. They are beginning to matter as elements of a changing structure on a national level and even on the international one.

Since the beginning of the 1990s, many African states have been in a democratic transition and consolidation phase and confronted with notions such as '*empowered popular participation, good governance, participatory or human centered development,*' and decentralization.¹⁹³ Development cooperation has considerably influenced this evolution. Since the end of the 1980s, the international community has recognized the need to overcome classical bilateral or multilateral developmental relationships between recipient and donor states. The Bretton Woods Institutions, through SAPs (Structural Adjustment Programs), prescribed the decentralization of state structures, independence of the judiciary, political accountability, popular participation in decision making, a check on waste and corruption, and the protection of vulnerable groups in the adjustment process. In that context, the ECA (Economic Commission for Africa) emphasized that orthodox adjustment and stabilization policies "undermine the human condition and disregard the potential and role of popular participation in self-sustaining development". Centralized development models were to be overcome. The aim was to promote local development by strengthening local autonomy and by a stronger civil society participation in the development process. Despite these new orientations, even nowadays few development projects establish a coordination link between public actors (central and local government) and civil society, but contribute to the opaque landscape of development actors. Also, the practice of development aid, despite rhetorical declarations about focusing on decentralization, often remains centralist.¹⁹⁴ As a criticism of this, this article is intended to demonstrate that the promotion of decentralization processes is of utmost importance and that development cooperation has a considerable role to play in this respect. The concept of decentralized cooperation which donors are currently discussing, especially on the European Union level, might be a useful tool to support decentralization processes in developing countries, provided it is adapted to these processes.

Thus, in the first Chapter (A.5.2), this article presents the principle of subsidiarity, the application of which, in the framework of current decentralization processes, leads to a participatory development planning and implementation process. The second Chapter

¹⁹² Lingnau, Hildegard (1997), pp. 355-379 (376).

¹⁹³ Ato Dawit Yohannes, (1997), pp. 18-21 (19).

¹⁹⁴ Simon, Klaus. (1993), pp. 45- 83 (48).

(A.5.3) concretizes claims for "local development partnerships" by analyzing the current situation in Benin. Finally, the article concludes with the main consequences which development cooperation should draw from this analysis.¹⁹⁵

A.5.2 The subsidiarity principle as a means for self-determined development in the framework of decentralization processes

Development cooperation should be conceptualized with regard for the subsidiarity principle, which is itself closely linked with the notion of 'subsidiary aid'. The latter means an instrument of development cooperation to support processes which contribute to the calling into existence of organizational systems leading to more 'empowerment': such systems are characterized by the existence of a devolved administration system (in the sense of decentralization), as well as by duty sharing among state, non-state, private, and community sectors.¹⁹⁶

According to the subsidiarity principle, there is a need to look for institutional arrangements which allow the establishment of a constructive link between public, private, economic actors, or societal organizations and the population.¹⁹⁷ Thereby, an effective utilization of existing human and material resources and technical competencies is achieved.¹⁹⁸ Through these partner relations, which can at best be achieved in the framework of strong local self-government (in general: municipalities), common strategies and actions are harmonized. Thus, the democratically legitimated actors on the local government level concentrate on coordination of all (private and public) actors likely to contribute to the solution of development problems, such as the business sector, international institutions, NGOs, and also state representatives.¹⁹⁹ Moreover, especially in countries characterized by large rural areas, the local population living on the village level should be actively integrated into the local governments' development process.

The demand for administrative reforms in which the institutions concerned understand themselves as responsible bodies in a sort of *administrative partnership* is of utmost importance. Such partnerships can assume different forms; therefore, it is necessary to determine relevant actors as well as the degree and the time of cooperation. In order to mobilize existing resources and capacities of the members of a society and thereby to improve the level of development, there is a need to create efficient institutional structures responsible for the planning, control, and implementation of development activities and measures.²⁰⁰

¹⁹⁵ The data was collected by interviews and work in a project of decentralization in spring 1999 and winter 1999/2000 (cf. Dreger 2001, p. 3).

¹⁹⁶ On this, cf.: Steinich, Markus (1997), p. 139, who describes the local or beyond-local level as level of reference; as sectoral provenience the state, private, and/or community sector, which can be considered/promoted in the framework of subsidiary aid in different constellations which can be mono, bi, or multi-sectoral.

¹⁹⁷ Stockmayer, Albrecht (1993), p. 150.

¹⁹⁸ Rüländ, Jürgen (1993), p. 181 (191).

¹⁹⁹ Fiedler, Klaus P (1992), pp. 233-242 (237).

²⁰⁰ Reichard, Christoph (1992), pp. 301-320 (301).

A.5.3 Participatory development planning as a basis for new development partnerships

This demand becomes particularly crucial in the framework of decentralization processes. Therefore, in the context of the demand for new development partnerships, institutionalization of planning competencies on the communal level has been required. Such institutionalization guarantees the participation of the population and of organized civil society, as it currently exists in several developing countries in the form of *Local Development Councils*.²⁰¹ This requirement is in accord with the notion of 'poverty-related structural changes', which implies competence of civil society actors and especially NGOs for decision-making and contribution to the local development planning process on the one hand²⁰² and local population competence on the other.

These reflections were intended to demonstrate that 'new concepts of decentralization' should not be imputed to the classical four concepts of devolution, deconcentration, delegation, and privatization, but constitute a wider concept which applies *within* administrative structures. They are supposed to create development models integrating all existing local actors and thus avoid competition and duplication of efforts undertaken by the multitude of local actors. In some countries, the legislature has put these reflections into legal terms and prescribes concerted public and private action in the development process, beginning with the planning process, as well as institutional forms allowing popular participation.²⁰³

A.5.4 Implementation of development activities through Public-Private Partnerships

As far as development activity implementation is concerned, one can observe that the traditional dichotomy between the state and private sectors has been successively overcome. This is demonstrated by the recent concept for provision of public services or promotion of investments called *Public-Private Partnerships (PPP)*.²⁰⁴ It generally means a cooperation between state and private business actors, but can also imply cooperation of the state with other private development actors, especially NGOs.²⁰⁵ The discussion on *Public-Private Partnerships* is relevant inasmuch as it concerns administrative reforms²⁰⁶ and, especially as related to decentralization reforms, provision of basic services on the local level. So far, they present an interesting instrument that seems to be particularly adapted to local level reality in developing countries.²⁰⁷ Once more, some legislatures have put this form of cooperation into legal terms, thus giving PPPs an effective tool to improve the provision of local services by legally mandating public and private sphere cooperation.²⁰⁸

²⁰¹ Wedler, Jürgen, (1992), pp. 331-334 (333).

²⁰² Kochendörfer-Lucius, Gudrun (1993), pp. 255-263.

²⁰³ For a description of the recent process in Bolivia, the Philippines, and South Africa, see Dreger, Mirka (2001)

²⁰⁴ Budäus, Dietrich, Grüning, Gernod, (1996), pp. 109-149

²⁰⁵ South African Ministry of Provincial Affairs and Constitutional Development and the White Paper Political Committee, p. 51.

²⁰⁶ Budäus, Dietrich, Grüning, Gernod, (1996), pp. 109-149 (117).

²⁰⁷ Reichard, Christoph (1992), pp. 301-320 (309).

²⁰⁸ The most interesting example is the BOT law of the Philippines, which also applies to the local level and so far is closely linked with the decentralization process.

That having been said, it is obvious that, in general, *Public-Private Partnerships* do not imply prior communication or an integrative planning process. Inasmuch as they only imply partnerships to implement a certain type of public service, they constitute nothing but a project or sector oriented provision of public services, in the form of joint ventures, outsourcing, etc. Therefore, they should be complemented by a prior process of joint planning and communication in the sense of participatory development planning as presented above. Thus, the coordination and cooperation of all relevant actors will begin in the planning phase and be continued in the implementation phase.

A.5.5 Situation in Benin

As "Model for Democracy" in West Africa, Benin has been considerably supported by bilateral and multilateral development actors since the process of "Democratic Renewal" in 1990. One important aspect is the decentralization process which, under the impact of development cooperation, has led to the passage and implementation of five decentralization laws, the latest in May 2000. These laws concretize the mandate of Benin's 1990 Constitution, which prescribes the creation of autonomous decentralized collectivities (*collectivités décentralisées*). A very important aspect of the devolution of power is the transfer of local development plan formulation competence to the municipal level. Even though elections had still not been held by mid-2002, several development projects have anticipated the decentralization process and started to establish new development models on the level of the future municipalities, taking the new distribution of powers between the central government and the future municipalities into account.²⁰⁹

A.5.6 Relevant development actors

Currently, the local level in Benin is composed of a wide range of public and private actors at least pretending to contribute to the (local) development process. Once the future municipalities have been established by elections, democratically legitimated local authorities (mayor, municipal council) will be confronted with this multitude of actors which is briefly described in the following:

A.5.6.1 State representatives

First, there are "deconcentration actors", regional or local state representatives. They can be divided into two groups: on the one hand, the respective representatives of various national ministries, deconcentrated public services (*services publics déconcentrés*), which have a sectorally limited task; on the other hand, the prefect, who, on the department²¹⁰ level, has multi-sectoral competence and furthermore coordinates the state public services mentioned above, as well as, in the near future, the representatives of the future municipalities, who

²⁰⁹ A very important example is a French project on decentralization and local development in the Département du Zou which might be transferred to the whole Beninese territory. The author had the chance to work with this project and analyze the institutional framework and its legal compatibility with the current decentralization legislation. On this cf. Dreger, Mirka (2001)

²¹⁰ Currently, Benin is divided into 6 departments which will be split into 12. On the level of each department, the prefect is the representative of all national ministries.

will be represented in a special organ on the department level. Therefore, already under the transitional law²¹¹ the legislature has created an organ of concertation on the department level which brings together not only the representatives of deconcentrated services, but also civil society actors and the sub-prefects (the latter are state representatives on the level of the future municipalities and will disappear once elections are held and be "replaced" by mayors). Currently, the prefect is the president of this organ. In future, this organ will, on the one hand, be replaced by an administrative conference in which all deconcentrated services of the department are represented and, on the other hand, by an organ of concertation which then will only include the future mayors and some representatives of civil society.

A.5.6.2 NGOs

Second, one has been able to observe an explosion of civil society actors, especially NGOs, over the last ten years. It is interesting to point out that many of the newly created NGOs²¹² in Benin were founded by people who have been thrown out of their jobs, for example in the administration, mostly as a consequence of the implementation of SAPs by the Bretton Woods Institutions. Instead of concentrating on one sector (for example health), many NGOs declare themselves competent in all relevant sectors, thus seeking development grants from donors. Furthermore, most of them concentrate their work on the big city level in the more fertile South and completely leave out rural areas. Given the fact that over 70 % of the population in Benin lives in rural areas, it is obvious that the really needy people do not profit from the activities proposed by such NGOs. Finally, most NGOs do not have democratic structures but are clientelistic.²¹³ Therefore, not only should donors be more careful with their "NGO euphoria", contributing to the increase of grant-seekers; future mayors and municipal councils must themselves carefully examine with whom a cooperation might be useful.²¹⁴

A.5.6.3 Pupils' parents' associations, local development association, and producers' unions

Besides these newly created civil society actors, there are several other private actors which have a longer tradition. The most important seem to be the pupils' parents' associations, the local development associations, and the producers' unions. The local development associations considerably influenced the democratization process which led to the 1990 national conference putting an end to the former authoritarian system under the former and

²¹¹ Spécial Juris Info: Loi n° 90-008, 13 August 1990, including organization and attributions of administrative circumscriptions during the transition period, p. 16-19.

²¹² In the following, the paper generalizes; thus, the author does not pretend that there are NO serious and honest working NGOs in Benin. There are exceptions which can not be presented here. However, the large majority of NGOs provide examples of the criticism raised here.

²¹³ Bierschenk, Thomas (2000).

²¹⁴ Some elements should be a democratic NGO organizational structure, regional competence, and yearly activities reports whose veracity should be controlled.

present president, Kérékou.²¹⁵ The original mandate of the local development associations, which, under state influence, were called into existence in the 1980s, was the development of their respective territory.²¹⁶ Through evolution in the 1990s, they have become actors on the political level, some qualifying as “political parties”. Even though they are present on the local level, it is obvious that many local development association presidents occupy an important post in a political party in Cotonou. Thus, they are far from being politically neutral development actors.

Other important local level actors are the producers’ unions, most of which work in the cotton sector. They have important economic power at their disposal and have long had a monopoly for local product commercialization and manure distribution. According to their statutes, they invest into social projects and infrastructure projects, such as school and hospital construction and road maintenance and repair. Thus, they have considerable influence on local investments.²¹⁷ Nevertheless, most projects these unions finance serve their own interests first before taking into consideration the needs of the people.

Besides these unions, the status of which is somewhat hybrid, Benin, as most West African countries, does not really have potential business partners. So far, the situation is very different from countries like South Africa, where business actors play an active role in the local development process and are actively integrated into the whole local development process.

A.5.6.4 Traditional authorities

Even though the role of traditional leaders differs from one region to another, it can be said that their influence and legitimacy in Benin is rather decreasing.²¹⁸ In the current decentralization process, their position has been completely left out and they have not been attributed any legally guaranteed position on the level of the future municipalities. The author is of the opinion that, through the decentralization process, their influence should further decrease in the long term. The democratically legitimized organs of the future municipalities should only consult them in matters which are traditionally in their domain, such as land issues. For the present analysis and the pledge for „development partnerships”, the author believes that, in Benin’s special case, the traditional leaders should as far as possible be left outside and only maintain their informal influence.

²¹⁵ Without entering into details, I will briefly describe this phenomenon. Kerekou ruled the country for about 20 years under a Marxist regime. After the peaceful transition in 1990, in which a new constitution was passed and a democratic system established, Kerekou was replaced by N. Soglo, who was known for his good relations with the United States and the Bretton Woods institutions, in the first presidential election. During his term of office, he greatly disappointed the Beninese with his policies and especially with increasing corruption. Interview partners confirmed that ‘under Kerekou corruption was for everyone, under Soglo it served only his family’. Thus, in the next presidential election in 1996, Kerekou, after a long period of mediation which the media extensively covered, presented himself as a ‘new personality’ and was elected president. Again, in March 2001, he was elected for a second term as president.

²¹⁶ Agonse, Codjo Antoine (1986-88), pp. 12-21.

²¹⁷ Batoko, Ousmane (1998), p. 539.

²¹⁸ Alber, Erdmute (2000).

A.5.7 Rural areas – the role of the villages

Having briefly described the wide range of local actors, a very important level remains to be presented: the villages. Again without entering into details, the author would like to point out how important this level is for the great majority of Beninese. The strong rural character of Benin implies that for most people everyday life is concentrated in the village territories, which constitute the smallest administrative unit under the current sub-prefectures (which, in future, will become municipalities).²¹⁹ Since the development process has, up to now, always been centralist, the village level, and thus the rural poor, have been completely left out of development activities emanating from the state. As has been stated above, especially NGOs in Benin rarely work with and for the rural population, despite their rhetoric.

Still, the relevance of the village level has been recognized by development cooperation which, in many cases, recognizes vulnerable groups at the village level. The same is valid for other countries of the region, such as Burkina Faso and Ivory Coast. In Burkina Faso, village forums have been created on the department level. In this framework, village representatives are supposed to “defend” development projects which, on the basis of co-financing and with the support of development cooperation, are to be realized by the local people. In Ivory Coast, a recent project²²⁰ funded by the World Bank is focussing on village cooperation in order to establish development plans at the level of the future (rural) municipalities, thus preparing for pending rural area decentralization (*communalisation*).

In Benin, the major role of the villages in the development process is also pointed out by the Ministry of Planning: interview partners stressed the need to attribute villages an active role in the development planning process, once decentralization is implemented by local elections on the municipal level. Even now, so far anticipating the decentralization process, a pilot-project has been implemented with the support of the World Bank. The project implies the establishment and implementation of development plans by and for the population of several villages (*Approche Participatory Niveau Village*). In the same sense, during parliamentary debate on decentralization laws, several speakers pointed out the importance of the village level. They also emphasized the need to integrate the villages into the future development planning and implementation process on the future local government level (municipalities).

According to these statements and the author’s own impressions, the process of decentralization in Benin can only lead to an improvement of the living conditions of the majority of people if the villages are represented in local development planning of the future municipalities. This is the result of a case study made in a French-Beninese project on

²¹⁹ Even though the village might, in many cases, still be too abstract and far away for the rural people, it seems to be the best level to be integrated into the development planning process of the future municipalities:

²²⁰ PNGTR. In September, 2001, the author had the opportunity to visit some implementing actors of the project in Bouaké (Northern Ivory Coast) who underlined the fact that despite problems between some villages, people were learning to understand their own responsibility for the development of the whole territory of the future municipality; thus, they seemed to be prepared for the pending ‘communalization’. Unfortunately, and due to political tensions in Ivory Coast, the funding agencies stopped funding of the project at the beginning of 2001 for an indefinite time.

decentralization and local development in the Département du Zou.²²¹ Even though (some of) the development actors quoted above should be integrated into the development planning, and implementation, process on the future communal level, this seems to be insufficient and should be complemented by institutionally guaranteed village representation. This means that future municipal councils should not elaborate local development plans on their own but, on the one hand, cooperate with organized civil society actors and, on the other hand, with all village representatives located in the municipal territory. Thus, the future municipalities will become the main actor to mobilize local capacities and steer the development process on the level of their territorial responsibility. Therefore, they need the support not only of the central government but also of the donors.

A.5.8 Conclusions: consequences for development cooperation

This article has manifested the need to mobilize all existing forces in order to make the development process dynamic. The current decentralization process and the establishment of municipalities has to be used in order to create cooperation and concertation models in the form of partnerships with all relevant local actors and forms of popular participation. This must have an impact on development cooperation concepts. With the current process of decentralization in many African states, local governments have become new potential partners for development cooperation in addition to and situated between the central government and civil society. Thus, the question of future concepts of decentralized cooperation in the framework of administrative reforms is of utmost importance and timeliness. It is decisive that (future) local governments in developing countries confronted with a deficit financial situation get support not only from the national government, but also from donors. This can be described under the concept of decentralized cooperation which, in the authors opinion, is a concretization of the principle of subsidiarity as presented above.

The European Union concept of decentralized cooperation has been discussed in the framework of the Post-Lomé debate and needs to be concretized in practice. European decentralized cooperation, in contrast to the concept proposed in the present abstract, focuses on a collaboration between civil society actors from the North and the South. The latter, though very important, seems to be insufficient and should be linked with and adapted to the current efforts of decentralization in developing countries. This point is not only valid for the European Union, but also for other donors which, with their "NGO euphoria", have influenced local community structures, often in a negative sense (cf. above, A.5.6)

Therefore, the donor community should complete the current practice of cooperating with civil society actors by strengthening direct support of local governments. In future, the focus should be to promote local development partnerships, in the form of "local coalitions",

²²¹ As has already been mentioned, the project anticipates the decentralization process. Thus, the Beninese actors concerned established a development plan for the future municipalities in the future Département du Zou. Again on the basis of co-financing, the implementation of the plan is already advanced. The project has aroused the interest of a multitude of Benin's development partners, as well as of national decision makers. In late 1999, the author participated in a conference dealing with the possibility of extending the project on the national level. The Dutch development cooperation has started another similar project, inasmuch as it also led to the establishment of the development plan of the future municipality Dogbo. Here as well, the relevant local development actors and the villages were integrated into the whole planning process.

between local governments and all relevant and "suitable"²²² civil society actors, especially on the municipal level. Given the fact that in many West African countries especially NGOs do not have a long tradition and often do not serve the poor and especially rural population, a special role and responsibility should be accorded to village representatives. Institutional options in this sense could not be presented in the present article.²²³

The aim of such development cooperation will be to promote new development models on the local level, considering the municipality to be the main "agent of conduct", thus uniting existing forces instead of supporting their competitive behavior.

Obviously, this concept remains rather general and needs to be adapted to the concrete situation of each country and of each local government. An important point of reference is, on the one hand, the existing legal framework, which includes the decentralization level, and, on the other hand, the constellation of actors. Furthermore, genuine control mechanisms have to be considered so as to reduce the danger of "shared corruption" at the expense of the rural poor. Again, the latter have to be integrated as active partners into the proposed local development partnerships to emanate from the local government councils.

A.5.9 References

- AGONSE, Codjo Antoine (1986/88): *Vie Associative et développement socio-économique des collectivités locales*, Mémoire ENA Cotonou 1986/88.
- ALBER, Erdmute (2000): *Traditionelle Herrschaftsstrukturen in der westafrikanischen Savanne*, Lecture held at the Institute for Development Research and Development Policy, May 19, 2000.
- ATO, Dawit Yohannes (1997): *A small but important step forward in State-Civil Society Interface, Dialogue and Cooperation*. In: *DPMN Bulletin: The state and civil society: partners or adversaries ?* vol. IV, no. 3, pp. 18-21.
- BATOKO, Ousmane (1992): *L'administration régionale de développement au Bénin*, Thèse Paris II Panthéon Assas, Paris (unpublished version).
- BIERSCHENK, Thomas (2000): *Der schwierige Umgang der Entwicklungszusammenarbeit mit lokalen Machtstrukturen am Beispiel Westafrikas*, Lecture held at the Institute for Development Research and Development Policy, June 19, 2000.
- BRÜNTRUP-SEIDEMANN, S. / LE MEUR, P-Y. / FLOQUET, A. (1999): *Political and development arenas in rural Benin*, Stuttgart (unpublished).
- BUDÄUS, D./GRÜNING, G. (1996): *Verwaltungsreform und Public-Private Partnership*. In: *Jahrbuch zur Staats und Verwaltungswissenschaft*, vol. 9/1996, pp. 109-149.
- DREGER, Mirka (2001): *Territoriale Verwaltungsreform und lokale Entwicklung in Benin - rechtliche und entwicklungspolitische Rahmenbedingungen - Bochumer Schriften zur Entwicklungsforschung und Entwicklungspolitik*, vol. 48, Saarbrücken.

²²² Cf.. Footnote 214.

²²³ Cf.. Dreger, Mirka (2001).

- FIEDLER, K.P. (1992): Der Beitrag der Kommunalverwaltung zur öko-sozialen Entwicklung. In: Schriftenreihe der Hochschule Speyer, vol. 116, 1992, pp. 233-242.
- KOCHENDÖRFER-LUCIUS, G. (1993): Strukturelle Wege aus der Armut: Die Zusammenarbeit von Staat und Nicht-staatlichen Organisationen, pp.256. In: Neuer Institutionalismus in der Entwicklungspolitik - Perspektiven und Rahmenbedingungen der Verwaltungsentwicklung im Süden und Osten, Schriftenreihe der Hochschule Speyer, vol. 118, 1993, pp. 255-263.
- LINGNAU, H. (1997): Lean Management Reformen als Ansatz zur Überwindung struktureller Dysfunktionalität öffentlicher Verwaltung in Afrika südlich der Sahara - Überlegungen am Beispiel Bénins und Ugandas. In: Verfassung und Recht in Übersee, 30, pp. 355-379.
- MINISTRY OF PROVINCIAL AFFAIRS AND CONSTITUTIONAL DEVELOPMENT and the White Paper Political Committee (no year): South Africa's Local Government - a discussion document towards a white paper on local government in South Africa, South Africa.
- REICHARD, C. (1992): Perspektiven institutioneller Entwicklung. In: Schriftenreihe der Hochschule Speyer, vol. 116, pp. 301-320.
- RÜLAND, J. (1993): Politisch-institutionelle Reformen und Dezentralisierung: Thesen zum Forschungsstand. In: Subsidiarität in der Entwicklungszusammenarbeit - Dezentralisierung und Verwaltungsreformen zwischen Strukturanpassung und Selbsthilfe. Edited by SIMON / STOCKMAYER / FUHR. Baden-Baden, pp. 181-195.
- SIMON, K. (1993): Subsidiarität als Rahmenbedingung für Entwicklung durch Armutsbekämpfung in Selbsthilfe. In: Subsidiarität in der Entwicklungszusammenarbeit - Dezentralisierung und Verwaltungsreformen zwischen Strukturanpassung und Selbsthilfe. Edited by SIMON / STOCKMAYER / FUHR. Baden-Baden, pp. 45- 83.
- SIMON / STOCKMAYER / FUHR (1993): Subsidiarität in der Entwicklungszusammenarbeit - Dezentralisierung und Verwaltungsreformen zwischen Strukturanpassung und Selbsthilfe, Baden-Baden.
- SOTINEL, T. (1998): L'Afrique attend beaucoup de la coopération décentralisée, Le monde, February 8, 1998.
- SOUTH AFRICAN MINISTRY OF PROVINCIAL AFFAIRS AND CONSTITUTIONAL DEVELOPMENT and the White Paper Political Committee (no year): South Africa's Local Government - a discussion document towards a white paper on local government in South Africa, South Africa.
- SPECIAL JURIS INFO: Loi n° 90-008 du 13 août 1990 portant et attributions des circonscriptions administratives durant la période de transition, pp. 16-19
- STEINICH, Markus (1997): Erst wenn wir unseren Kopf in unsere eigenen Hände nehmen können...,, – Subsidiaritätsförderung als Beitrag zur Armutsbekämpfung in Entwicklungsländern, Münster.
- STOCKMAYER, Albrecht (1993): Subsidiarität als Ziel von Maßnahmen der Verwaltungsreform. In: Schriftenreihe der Hochschule Speyer, vol. 118, pp. 151-167.

WEDLER, Jürgen (1992): Diskussion zu den Referaten von Christoph Reichard und Heinrich Siedentopf. In: Schriftenreihe der Hochschule Speyer, vol. 116, pp. 331-334.

B Methodological Studies

B.1 Control fit and autocorrelation in binary logistic regression: Explaining Democracy by Human Capital

Stefan Karduck

The analysis of data is an art, not a science.

Nathaniel Beck, Jonathan Katz, Richard Tucker

B.1.1 Abstract

Measuring democracy in high resolution is quite a difficult undertaking as more than 40 years of research history may prove. I²²⁴ encoded *Democracy* with an easily surveyed binary variable (*DEMO*) coded 1 if a political system fulfills certain criteria and 0 otherwise. Applying these data to a logit analysis with *DEMO* as dependent and *Human Capital (HC)* as explanatory variable allows explaining the probability to observe a democratic system in dependence of the performance in *HC*. In other words, the *discrete* binary measurement of either 0 or 1 is transformed to a *continuous* probability now *ranging between* 0 and 1. The calculations were done with a data pool for Malawi, Namibia, and Zambia from 1984 to 1997 ending up in a binary time-series-cross-section (BTSCS) model.

Researchers working with BTSCS logit models may face two major problems: The models' fit to data and the effect of time. For both problems, I propose solutions based on graphic methods instead of inference. To control the fit of the model, I used nonparametric regression based on conditional means representing the structure of the data without the need for assumptions. To control time effects, I indexed *time (T)* as a new variable adopting the idea of *spells* from event history methodology. Adding this variable to the simple model allows control of the amount of explanation of *DEMO* achieved just by the influence of *T*.

B.1.2 The initial position

Before I focused on the countries of interest, I examined the correlation between *Human Capital* and *Democracy* with a 'worldwide' cross-section approach so I was able to keep out time effects and had access to at least 50 countries' data concerning democracy and human capital: *Democracy* was measured by GASTIL'S²²⁵ *Civil Liberties* and *Political Right*. Both are constructed as discrete variables with 1 indicating the lowest possible value and 7 indicating the highest score. While the ranks are questionable concerning the value for a single country, one can assume the measurement errors' ε_i expected value to equal zero ($\mu_\varepsilon = 0$) for a cross-section approach as the number of cases rises. *HC* was measured by WORLD BANK²²⁶ data listed under the cue of *education*. On this data I performed an OLS regression and four nonparametric regressions based on the arithmetic mean, the median, and the first and ninth deciles. In addition, I plotted the difference between the deciles to show the amount of variance. The results were plotted into scatter plots with the democracy measure

²²⁴ Stefan Karduck, 2001.

²²⁵ Raymond Gastil, 1993, pp. 21–46.

²²⁶ The World Bank, 1997.

on the abscissa and *HC* (see figure 1, here: *HC* is *primary school pupil-teacher ratio*) on the ordinate. In these pretests the presumed correlation was proven²²⁷ for most variable combinations and thus encouraged me to turn towards the countries of interest.

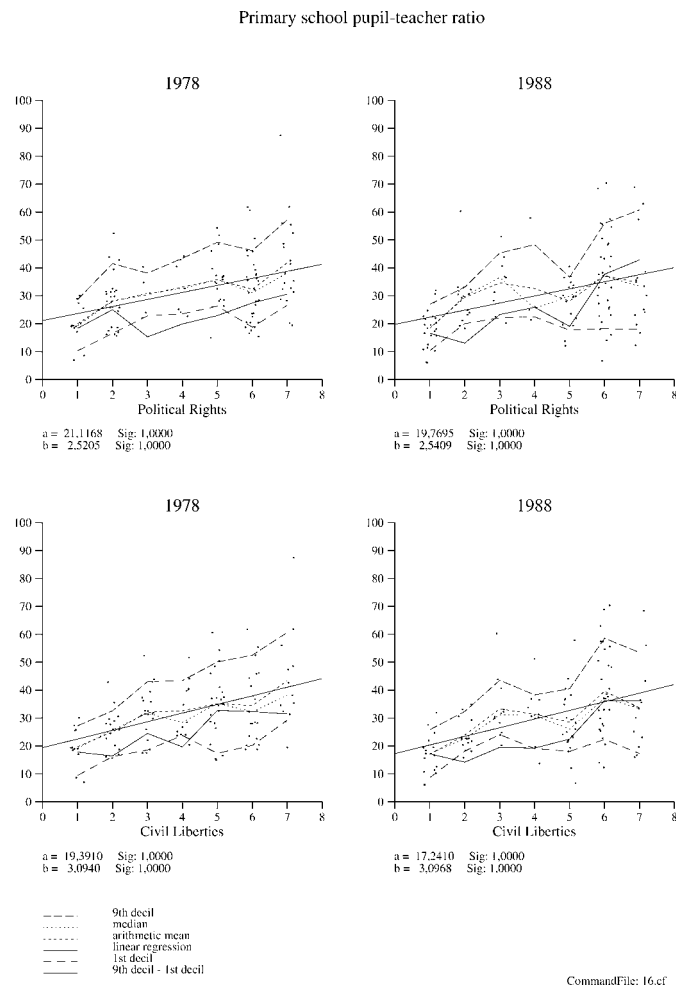

Figure 1: cross-national regression

²²⁷ I used TDA (Transition Data Analysis can be downloaded for free from the authors' web-page: <http://www.stat.ruhr-uni-bochum.de>). Please note: For OLS regressions TDA outputs the probability of the *acceptance* of the null hypothesis instead of its refusal. Thus values near 1 indicate significance and not near 0 as is common in most statistical software e.g. SPSS.

B.1.3 Acquiring Democracy

As already said above *DEMO* was to be constructed as a dichotomous variable, meaning a system is labeled either democratic or not. In order to decide which value is proper, it was necessary to work out a definition of democracy that could provide some kind of threshold. If one compares widely accepted definitions of democracy presented by well-known researchers (e.g. BOLLEN, LIPSET, SCHUMPETER, TETZLAFF), it turns out that there are three universally shared characteristics that seem to be the lowest common denominators:

1. *Participation*, in the sense of the citizens' involvement in government formation.
2. *Constitutionality*, in the sense of respecting human rights.
3. *Competition for political power*, carried out by multiple competing political parties.

So I defined a system that provides all three properties as a democracy resulting in $DEMO=1$. On this basis the following stipulations were made:

- Malawi has been labeled a political democracy from 1993 on, because on June 17 of that year an internationally organized and observed referendum was held that decided the country's future political system, where 63% of the voters proposed the introduction of a multi-party system. Some authors even regard 1992 as the beginning of Malawi's democratization: "In some countries, like Malawi, the democratization process would not have begun at that specific time (1992) and would not have taken the same speed if the donors had not put their pressure on Banda's regime."²²⁸
- In Namibia the results of the elections to form the first constitution-giving assembly were announced on November 14, 1989. The country is said to have been democratic since 1990: "On 21 March 1990 Namibia became a sovereign republic [...]."²²⁹
- Zambia held the country's first free elections on October 31, 1991, so that 1992 seems to be a good choice as the first democratic year in the sense of my model.
-

B.1.4 Selection of the analysis method

I opted for the logit analysis because:

1. It makes use of the metric scale's information of the explanatory variable while the explained variable may be dichotomous.
2. It delivers an interpretation of results which is simple to understand. Here the analysis answers the question: "How probable is it to find a political democracy if human capital reaches a certain development?"
3. The logit function is mathematically highly flexible: Though the graph always follows an S-shaped curve, it can be adopted from a nearly linear to an almost cascaded shape, as figure 2 demonstrates.
4. The function's run matches the process characteristics of *HC*.

²²⁸ Sidgi Kaballo, p. 195, 1995.

²²⁹ Cynthia Cohen, 1994.

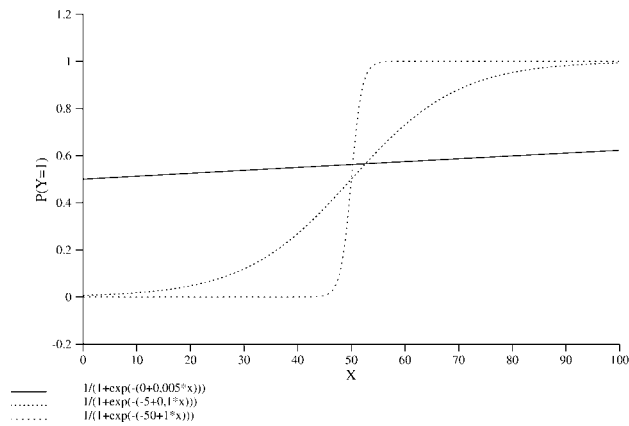

Figure 2: logit functions

B.1.5 Analysis

The logit analysis delivers the function

$$(1) \quad P(Y = y_i = 1) = F(\alpha, \beta | X = x_i).$$

With a maximum of 14 cases per country, the logit analysis produced so-called *perfect fits*, meaning that α and β realized extremely high values forcing the curve into a cascaded shape. This was caused on the one hand by poor data quantity and by an underlying temporal structure within the data on the other hand. To avoid this problem I took two steps:

In order to raise the number of valid cases, I pooled the data using standardized values. To account for temporal interference, it is common practice to include time T in the model:

$$(2) \quad P(Y = y_{i,t} = 1) = F(\alpha, \beta, \gamma | X = x_i, T = t_i)$$

Unfortunately, this did not solve the problem. Although the number of perfect fits was reduced, the estimation system was still unstable, resulting in findings that depended the estimation algorithm. The mediating hint was delivered in an essay by BECK et al. mentioning that I was dealing with grouped duration data: "[...] is based on the recognition that BTSCS (Binary Time-Series--Cross Section) is grouped duration data. Note that we do not say 'like grouped duration data'; BTSCS *is* grouped duration data."²³⁰ And in fact, Figure 3 shows that *DEMO* and T build up groups if you plot the cases in yearly order by country (M84 means Malawi in 1984).

²³⁰ Beck, Katz, Tucker, 1999.

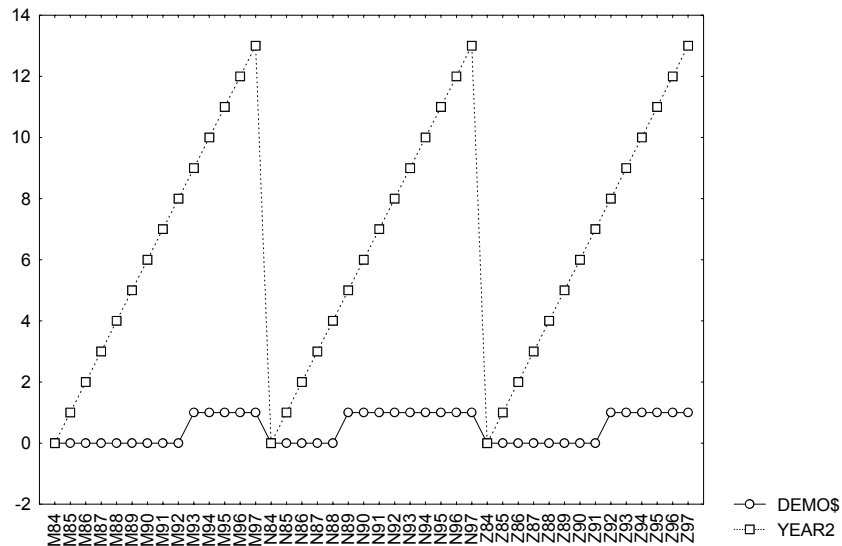

Figure 3: grouping

The problem is:

1. The tuples $(DEMO, HC, T)$ contains redundancies. $DEMO$ can be explained not only by HC but more or less by T alone. For all $t < 5$, one always obtains $DEMO = 0$ and for all $t > 8$, one obtains $DEMO = 1$.
2. The notation $(DEMO, HC, T)$ is, strictly speaking, foreshortened. Since the data are pooled from three countries, one must note the country as a condition as well: $(DEMO|country, HC|country, T|country)$. The problem arises through the fact that T is the same throughout all countries resulting in $(DEMO|country, HC|country, T|country) = (DEMO|T, HC|T, T|T)$

This means that, while T is the same in all countries, it does not have the same meaning with respect to $DEMO$ e.g. $t = 1992$. The same value in all countries – however: Malawi is not democratic yet, but Namibia has already been so for two years, and Zambia is now in the year of transformation!

Against this background, I changed time measurement according to BECK et al. Time as a variable for the logit analysis no longer counts the units of time within the period of observation; instead, the new variable $SPELL^{231}$ additionally marks a change in $DEMO$ by initializing $SPELL$ with zero again at that point of time (see table 2).

²³¹ As already mentioned, BECK et al. gave the impulse for that time indexing. Since I adopted their basic idea, I took over the term 'spell' as well. However there are some differences to note:

1. BECK et al. proposed $SPELL$ as a dummy variable, while I decided to opt for a discrete variable for better understanding and interpretation.
2. A change in the dependent variable does not cause a new initialization directly, but in the following year. With regard to my data, this would provoke additional distortion. By stepping through the pooled data matrix case by case, one not only observes a change in $DEMO$ if there is really a change in politics but if one moves from one country to the next as well. This means that changes in $DEMO$ from 0 to 1 always occur within a country, while changes from 1 to 0 indicate the crossover to the next country. Thus, changes in $DEMO$ to 0 would be recorded immediately, but changes to 1 would lag one unit of time behind. To avoid this, I indexed $SPELL$ according to table 1.

Table 2: Indexing *SPELL*

<i>T</i>	...	84	85	86	87	88	89	90	91	92	93	94	95	96	97
19..															
<i>DEM</i>	...	0	0	0	0	0	0	0	1	1	1	1	1	1	1
<i>O</i>															
<i>SPELL</i>	...	0	1	2	3	4	5	6	0	1	2	3	4	5	6
<i>L</i>															

The logit functions results in

$$(3) \quad P(Y = y_{i,s} = 1) = F(\alpha, \beta, \gamma | X = x_i, SPELL = s_{i|DEMO}).$$

The effect is illustrated in figures 4 and 5; the jittering in *Y*-direction just prevents single dots from overlapping.

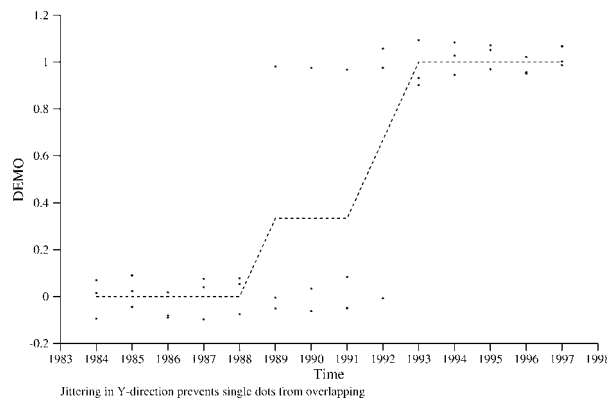

Figure 4: *T* against *DEMO*

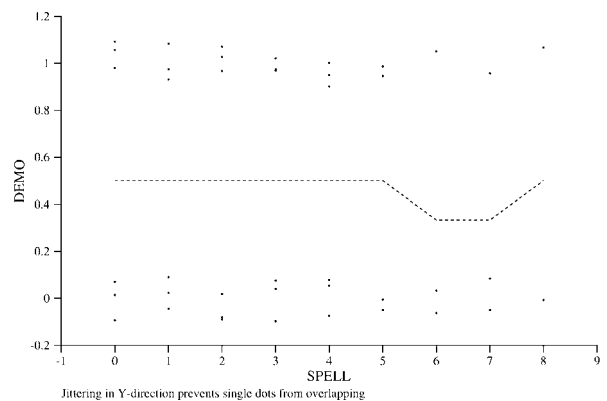

Figure 5: *SPELL* against *DEMO*

While *T* against *DEMO* indicated a strong interdependence, figure 5 shows an equal distribution for *SPELL* against *DEMO*. The small incursion stems from the fact that the 42 cases of data are not equally distributed to the dependent variable:

$$(4) \quad \{DEMO = 0\} = 22, \{DEMO = 1\} = 20$$

Hence, one can assume that *SPELL* does not import a new dependency into the system. Values for γ near 0 thus indicate that *HC* reaches a high level of explanatory power. The more $|\gamma|$ differs from 0, the less is *HC*'s proportion in explaining the variance of *DEMO*.

To illustrate this effect, figure 6 shows a logit regression according to (3) where instead of a real *HC* the cases timely order (*YEAR2*) was used to simulate a maximum influence of time. In contrast, figure 7 shows the regression plane with *DEMO*·13²³² instead of *HC* simulating no influence of time and a perfect correlation between explained and explanatory variable.

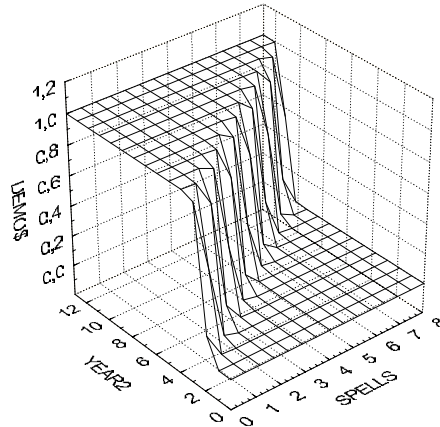

Figure 6: *T* against *DEMO*

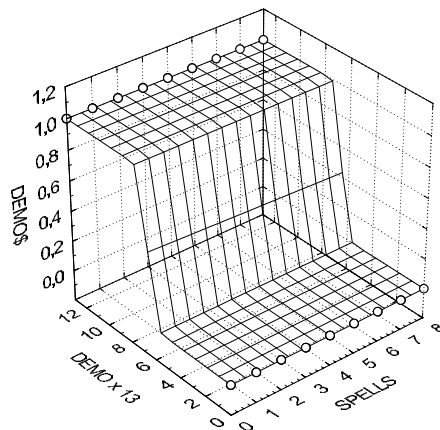

Figure 7: *SPELL* against *DEMO*

To integrate these three dimensional functions into the two dimensional final plots, I used the projection of the function plane by fixing *SPELL* to its maximum, minimum, and arithmetic mean.

$$(5) \quad SPELL = s = \max SPELL, \mu SPELL, \min SPELL$$

Figure 8 shows such a result chart with the assignment of the different curves according to the legend.

²³² Multiplying by 13 is a simple way to ensure that both simulation variables share the same scale.

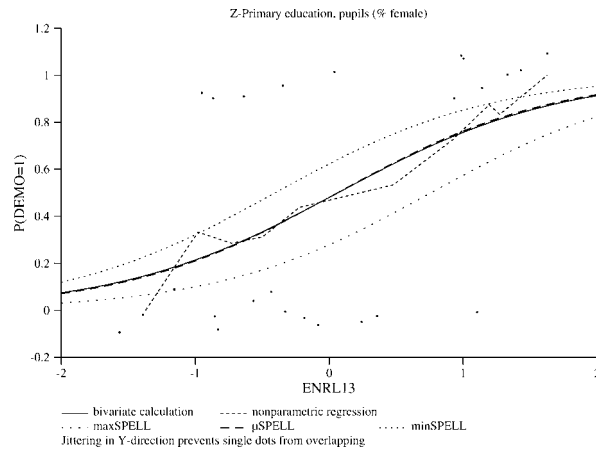

Figure 8: result chart I

B.1.6 Chart Interpretation

As mentioned above, these charts serve to illustrate the correlation between *DEMO* and *HC* (solid line). In order to check if the course of that curve fits the data, one compares it

1. to the raw data of the scatter plot.
2. to the course of the nonparametric regression.

Figure 8 shows that the simple logit regression records the data's structure appropriately because the nonparametric course is very similar. Figure 9 is a contradicting example.

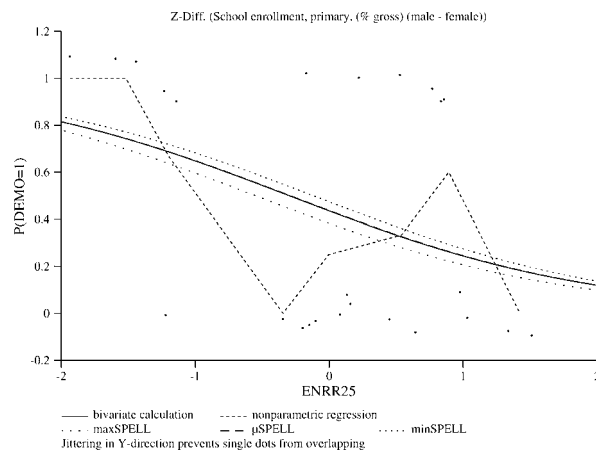

Figure 9: result chart II

In order to check for temporal influence, one compares the courses of the simple and extended regressions. The courses of the curves in figure 8 validate the assumption of low temporal influence, hence the bivariate result can be expected to be adequate, while the courses in figure 10 are obviously inconsistent with one another.

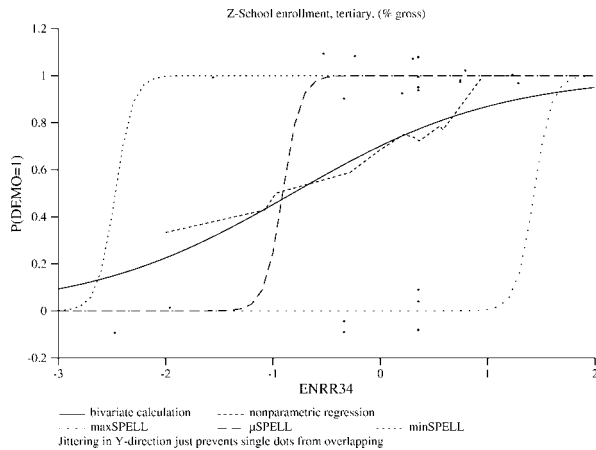

Figure 10: result chart III

By performing these comparisons for all calculations, one can detect which *HC* have explanatory power for *DEMO* and which do not. For meaningful *HCS*, it is then interesting not only to describe the correlation but also to quantify the probability of observing a political democracy. Since the result chart's *X*-axis is divided in units of the appropriate *HC*'s standard deviation, one needs to de-standardize this axis, most usefully with the parameters of a specific country and not with the pools μ and σ .

These de-standardized functions can then be illustrated in a simple chart like figure 11.

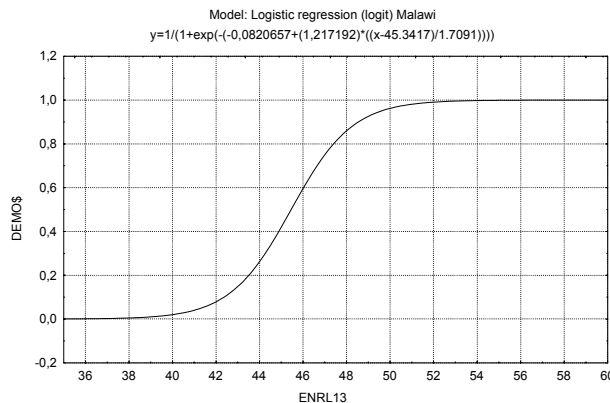

Figure 11: de-standardized function

Here the *X*-axis is made of real empirical units and one can directly derive $P(DEMO=1)$ for any *HC* value.

B.1.7 Realized Probabilities

With the findings of the previous section, one can calculate expected probabilities for each country and year. Plotting them onto a line chart visualizes the course of the level of democracy as it is calculated based on the performance in *HC*. Figure 12 shows such a chart with separate curves for each country. Dashed segments of the lines indicate that neighboring dots move apart for more than a year.

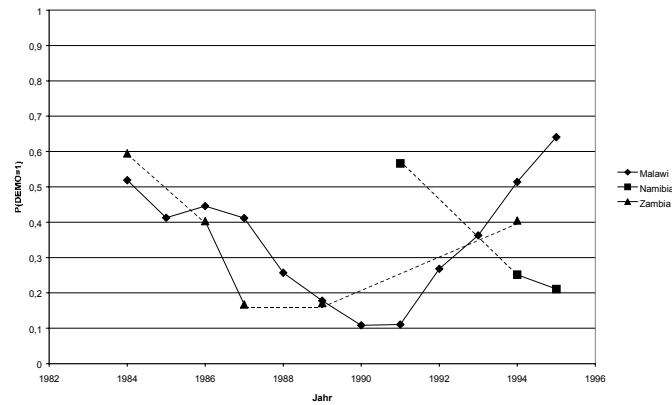

Figure 12: expected probabilities

B.1.8 References

- GASTIL, Raymond (1993): The Comparative Survey of Freedom: Experiences and Suggestions. In: On Measuring Democracy: Consequences and Concomitants. Edited by Alex INKELES. New Brunswick, New Jersey, Second Printing, pp. 21–46.
- WORLD BANK (1997): World Development Indicators on CD-ROM, Washington.
- WORLD BANK (1999): World Development Indicators on CD-ROM, Washington
- KABALLO, Sidgi (1995): Human Rights and Democratization in Africa. In: Political Studies Association, Political Studies, XLIII, page 195.
- KARDUCK, Stefan (2001): Zusammenhang zwischen Humankapitalbildung und Demokratisierungseffekten, Herleitung von Analysemethoden und empirische Untersuchung in Malawi, Namibia und Sambia, <http://www-brs.ub.ruhr-uni-bochum.de/netahtml/HSS/Diss/KarduckStefan/diss.pdf>
- COHEN, Cynthia (1994): Administering Education in Namibia: the colonial period to the present, Namibia Scientific Society, Windhoek.
- BOLLEN, Kenneth A. (1989): Structural Equations with latent variables. New York, Chichester, Brisbane, Toronto, Singapore.
- BECK, Nathaniel; KATZ, Jonathan; TUCKER, Richard (1999): Beyond Ordinary Logit: Taking time seriously in binary time-series--cross-section models, http://wizard.ucr.edu/polmeth/working_papers97/beck97c.html (February 11, 1999)
- ROHWER, Götz; PÖTTER, Ulrich (1998): Statistical concepts and models for social research, Bochum, <http://www.stat.ruhr-uni-bochum.de/teaching.html>, December 9, 2000.
- ROHWER, Götz; PÖTTER, Ulrich (1998): TDA user manual, Bochum, <http://www.stat.ruhr-uni-bochum.de/tman.html> (December 8, 2000)

C Perspectives

C.1 The Relation of Macro-Level and Micro-Level: Five Perspectives

Mirka Dreger and Anke Huenninghaus

C.1.1 Introduction

The Ph.D. program was entitled: "System efficiency and system dynamic in developing countries. The micro-foundation of macro processes of social, political, and economic transformation". Various research projects were developed to approach this topic as the individual participants in the Ph.D. program selected specific research questions designed to contribute to the overall theme of the course. The main focus was laid on how macro processes influence processes on the micro-level or vice versa.

Due to the Ph.D. students' different academic backgrounds, research questions as well as methods employed differ. But in the end it can be seen that all participants contributed to the main question regarding the reciprocal influence of macro processes on micro processes, thus trying to give an interdisciplinary answer concerning the Ph.D. program's topic.

It is not the aim of this article to summarize the articles in this book but to show how each of them dealt with the leading research question, the theme of the Ph.D. program, applying the specific view of its author's discipline. Furthermore, some recommendations concerning development cooperation will be drawn from the outcomes of the different Ph.D. studies.

Three of the Ph.D. students undertook an implementation study to show how a project or political process on the macro-level influences the micro-level: the establishment of a biosphere reserve in Kyrgyzstan (Huenninghaus), the promotion of democratization through the European Union in Zimbabwe (Nolting), as well as the political process of affirmative action in South Africa (Schmid). Two researchers analyzed how the process of decentralization and the influence of foreign donors on civil society actors should or does present itself on the micro-level (Berg, Dreger).

All research projects were implemented in countries where a process of transformation is currently going on. The process of transformation, as mentioned in the title of the Ph.D. program, is interesting for the survey of the relation of macro and micro, because it includes changes of the system as well as of the society. In a changing society new concepts and policies are frequently "imported" and it is interesting to see how these new concepts, which are often defined by donor organizations, are integrated into a changing system and society of developing countries.

Five of the research studies followed an empirical approach. One research project is not an empirical but rather a methodological study: here the focus is laid on a statistical method to access political processes of transformation (Karduck). Therefore, it will not be analyzed in the present article.

C.1.2 The Studies

In very general terms, it is assumed that processes of transformation on the macro-level have an influence on the micro-level and vice versa. But how? That was the question of the

Ph.D. program. The definition of macro and micro was to be posed and argued by each Ph.D. student.

For Huenninghaus, the macro-level is located on the national level (Ministry of Environmental Protection of the Kyrgyz Republic) where the project to implement a biosphere reserve had been negotiated. The villages where the concrete project measures have been implemented are defined as the micro-level. Nolting defined the involvement of the European Union in the process of democratization in Zimbabwe in the form of diplomatic activities as the macro-level and the concretization by small-scale development projects for promoting the process of democratization as the micro-level. For Schmid, the interdependent relationship of policy formulation of affirmative action in Namibia and South Africa and its implementation by the public and private sector was of interest. She defined policy formulation as the macro-level and its implementation by the public and private sectors as the micro-level. All these studies can be termed implementation studies, because the implementation of a policy or project is the key to describing the relation of macro and micro-level and vice versa.

As already mentioned above, the common point of all Ph.D. projects was a process of transformation in the state in question: In the case of Huenninghaus, this was the process of transformation in the former socialist country of Kyrgyzstan from a centrally planned state into a market-oriented democracy; for Nolting, it was the process of democratization in Zimbabwe; and, in the case of Schmid, it was the process of democratization and equalization of the former regime of apartheid in South Africa.

All three Ph.D. students chose an actor-oriented view to describe their selected research interest. This research position is derived from a scientific point of view that represents the presumption that for the understanding and explanation of political processes the actors of these processes have to be at the focus of research. The success or failure of projects or policies often lies in the hands of very few important persons and these key persons and their particular interests are often more important for specific (sometimes not intended) developments within the projects or policies than the applied theories, concepts, or other determinants which may have an impact on projects and/or policies (see the articles by the three Ph.D. candidates in this volume).

Huenninghaus and Nolting found that difficulties of communication and a lack of flexibility on the donors side could be detected which hampered project implementation. Negotiations play a crucial role in development cooperation as they are necessary to fix the frame of the cooperation. Negotiations depend on human beings, and if different styles of communication are confronted with each other, project implementation is marked by difficulties. Therefore, it is necessary to train negotiation system participants in intercultural communication. In her article, Schmid also states that communication in the formulation of affirmative action policy was poor, a factor which negatively affected the implementation and acceptance of affirmative action.

Moreover, the two articles by Huenninghaus and Nolting show the difficulties which can arise if a project or a concept is imposed from the "outside" on structures marked by other principles, rules, and values than those valid for the actor who has created and introduced the "new concept" (promoting democracy from the "West" as well as transferring a concept like a biosphere reserve which is based on democratically marked structures into a former

socialist country). Both examples show the difficulties of adjusting democratic principles into a context where clientelistic structures and undemocratic principles are still dominant.

Furthermore, Huenninghaus, Nolting, and Schmid made clear that the influence of people in key positions is very significant. Key persons on the national level endowed with power (such as political leaders or key persons in ministries) can influence or even destroy all endeavors of donors, for example. But this also holds true for the opposite. The success of projects often depends on a few highly motivated persons. Schmid found out that the process of affirmative action is strongly influenced by specific actors and their endowment with power (financial as well as political). Politicians tried to exploit affirmative action policy to win elections: "...the ruling party perceived the legislation as a tool for winning votes..." (Schmid in this volume p 41). But unlike the articles by Nolting and Huenninghaus, the concept and implementation of affirmative action was not imported from foreign donors but was initiated by the nation itself to reduce inequality after the apartheid regime. Nevertheless, especially in the case of South Africa, one international organization played a crucial role: the ILO (International Labor Organization).

All three Ph.D. candidates found that a specific institutional culture is necessary for the implementation of new strategies, concepts, or processes. The building of capacities to make sure that there are structures and actors who can carry out the newly introduced processes for development (capacity building, see Huenninghaus in this volume p 13) is a crucial precondition for success and sustainability of projects and programs.

Berg and Dreger place their studies in the framework of a transformation process which can be generalized as a national democratization process and which constitutes the transformation of a former centralist socialist system in Uzbekistan (Berg) and the peaceful transition of a Marxist regime to a democratic system designed to be consolidated through the decentralization process in Benin (Dreger).

Berg defines the international community and the central state as the macro-level, whereas, on a lower level, she points out the central role of NGOs which can be considered to be the meso-level. According to her analysis the level of community organizations form the micro-level which can take the form of neighborhood or other informal networks.

Dreger defines the decentralization reform process on the national level as the macro-level, whereas the future local governments (the municipalities) and their sub-structures (villages) are supposed to be the micro-level. Accordingly and as the reform of decentralization in Benin has been conducted by means of a top-down approach of the national level which stood under the influence of donor's community, she believes that, in its implementation phase, the process of decentralization should be complemented by a bottom-up approach which leads to real empowerment on the local level. Moreover, in a more detailed analysis of the micro-level, she underlines the importance of the variety of local actors at stake and with whom the future municipalities will have to deal.

Both Berg and Dreger (Dreger explicitly and Berg more implicitly) use the concept of subsidiarity as the guiding principle which should be used in order to ensure that the democratization process will be rooted at the micro-level and lead to self-determined development.

As in the other articles (especially Huenninghaus and Nolting) and throughout the example of the reciprocal influence of donors and NGOs, Berg points out that a lot of problems may

result from simply exporting ideas and concepts into an alien social and economic framework. She argues that instead of exporting foreign concepts, a focus should be put on the integration and support of local groups, communities, and networks which Berg defines as an indigenous kind of interest group/stakeholder. The main local actors in Uzbekistan's society have long been state run public organizations, trade-unions, etc. which were created under the influence of the state and not on a voluntary basis. On the other hand, since the democratization process started one can observe the rise of NGOs which are often not rooted on the community level and thus also have to be seen as a result of the influence of the macro-level (in this case the donors – Berg uses the notion of aid business which is exploited by the NGOs).

In the same line of argumentation, Dreger points out that in order to make the current decentralization process a real instrument of empowerment, it is crucial that future local governments (which are a creation of the macro-level) get the power to steer the activities of all other local stakeholders. She states that it should be avoided that through the influence of the macro-level the decentralization process be undermined by the ongoing support of other actors (especially NGOs) at the expense of local governments. She stresses the need to create "new local coalitions for development" which are steered by the local government but integrate the multitude of local stakeholders, especially those who have their base in the local communities, and the sub-municipal level into the local development process.

C.1.3 Relation of Macro-Level and Micro-Level

The articles by Hueninghaus, Nolting and Schmid prove that a process, strategy, or project imposed from "above" (the so-called macro-level) needs actors who are fully subscribed to the strategy and who have the power to implement it as well as that they should have the respect of the people on the micro-level. So-called capacities to carry the imposed structures for development and to implement and sustain the process initiated are necessary²³³. If strategies are imposed without the necessary framework conditions and capacities, their sustainability is more than questionable. Generally, it can be said that macro processes imposed from above without the necessary capacities to carry out the process of change have no chance of becoming integrated into the existing structures of the nation in question and therefore have only marginal influence on processes on the micro-level.

The articles by Berg and Dreger maintain that the influence of the national state as well as that of the donor, which constitute the macro-level, has a considerable impact on the evolution of the landscape of actors and their behavior on the micro-level. The micro-level, even though a creation of the macro-level, might really contribute to the fostering of the transformation process on the national level and to a genuine, self-determined development, according to Dreger. But in Uzbekistan, Berg found, NGOs are often not rooted on the community level and must thus be seen as a result of the influence of the macro-level, as most of them developed only through the encouragement of the donor community which needs NGOs as partners on local level (see Berg in this volume, pp 60).

²³³ Where the main focus of these capacities lies depends on the project, policy, or program implemented.

C.1.4 Recommendations for development cooperation

Beyond the analysis of the mutual influence of the macro and micro levels, the different Ph.D. projects deal with the question as to which conclusions can be drawn from the research results for development cooperation. This chapter is only a short compilation; for further and more detailed recommendations the dissertations should be consulted.

Huenninghaus underlines the need for capacity building in projects of development cooperation with Soviet successor states in order to create an institutional framework for cooperation. The administrative and planning structure in Soviet successor states is still marked by centralization. This stands in opposition to the donors' democratic understanding of planning and leads to conflicts. Therefore, she stresses the importance of teaching the actors intercultural communication where the discrepancies of different cultural backgrounds and different styles of communication and cooperation can be overcome. Furthermore, she points out the necessity for donors to gain knowledge about the specific institutional rules and the logic of action, the "rules of the game" (North 1990), of the given society and the actors concerned. Only if donors and their implementing agencies understand the given institutional rules are they able to implement development projects which are really integrated into the particular structures of the society. This is a precondition for the identification of the target group with the project measurements. Identification is a crucial condition for successful participation of the target group and actors involved (this is valid for the national level as well as the micro-level) and sustainability of projects (see the article by Huenninghaus in this volume, pp 5 as well as her dissertation (Huenninghaus 2001)).

Nolting focuses on the European Union and asserts that it should exercise stronger influence on the macro-level through the promotion of the democratization process in Zimbabwe in form of diplomatic activities and not limit its activities to small-scale projects (positive measures) on the micro-level. This implies decentralization of decision making structures inside the European Union.

Schmid draws the conclusion that for a successful promotion of political processes in developing countries by external actors (in this case the affirmative action process in SA and Namibia), the interests of the target group should be considered. Otherwise, if only imposed from the top, they will not be accepted by the actors on the micro-level and thus not be sustainable. Acceptance of a policy by the target group can be achieved if the target group gets benefits. But if a well meant policy is not implemented by persons who are fully subscribed to it, as mentioned, and the target group does not see any results, the whole policy is judged bad. This is not quite a new concept, but reality shows that the point of integrating the target group with their interests is still neglected.

Against the background of the mutual influence of the macro on the micro-level, Berg underlines that it is essential to rely on indigenous structures and autochthonous social networks on the local level in the case of Uzbekistan. Only if the donors and the implementing agencies promote these existing local potentials, may the really needy people be reached and a sustainable, self-sustained development process be fostered. She stresses that it might be fatal if development cooperation accepts working only with local NGOs. Rather, it is of the utmost importance to establish and maintain direct relations between certain donor organizations and their focus groups to weaken the broker position of NGOs and to include the viewpoint of different actors. Thus, development cooperation will

contribute to a combination of external (donors, NGOs) and internal (local) knowledge systems.

In the same sense, Dreger draws the conclusion that the influence of the macro on the micro-level in the framework of formulation and implementation of decentralization should be used in order to strengthen local development partnerships. She points out that donors can foster such local coalitions through the concept of decentralized cooperation which is rooted in the principle of subsidiarity (for a concrete study on how such coalitions can be shaped and supported by decentralized cooperation please cf. Dreger, Mirka (2001)). According to her analysis, this aspect is essential in the sense that it will lead to decentralization becoming a bottom-up-process (emanating from the micro-level to the macro-level). Otherwise, strong local stakeholders on the micro-level might misuse the isolated support of the macro-level, especially of development cooperation, which would circumvent a real development process from below.

In general it can be said that for the assessment of development projects and policies it is important to judge them within the framework of general societal conditions. In particular, project measurements aiming at the improvement of life conditions of parts of the society, have to be adapted to the target groups and their institutional rules. This seems to be a commonplace and mirrors the status of discussions in the seventies. However this knowledge is still valid and has not lost its importance, because many project measurements are still imposed from above, without adequate understanding of the functioning of societal systems and are therefore not well adapted to the target group's everyday life. The consequence is that project measurements often do not reach the target group and evaporate without effects.

C.2 Empirical Social Studies in Developing Countries: Five Perspectives on Field Research

Armin K. Nolting

'Ah, so you're back.'

'Yes.'

'Was it boring?'

'Yes'

'Did you get very sick?'

'Yes.'

'Did you bring back notes you can't make head or tail of and forget to ask all the important questions?'

'Yes.'

'When are you going back?'

I laughed feebly. Yet six months later I returned to Dowayoland.

(Nigel Barley: "The Innocent Anthropologist")

C.2.1 Introduction

This short chapter draws on the experience gathered by five Ph.D. researchers²³⁴ who carried out their projects within a three-year post-graduates program (Ph.D. program) at the Institute of Development Research and Development Policy of the Ruhr-University Bochum. Throughout those years of collaboration, a number of issues and questions related to research design, field research, and methodology featured prominently in individual reasoning as well as in the group's discussions. This shared experience can be regarded as the first of two starting points of this chapter.

The second and related starting point arises from more general reflections. Empirical social research is prone to many difficulties and inherent contradictions. Some methodologies oblige the researcher to integrate himself sufficiently into the social structures and processes he is to analyze. Simultaneously, it is desirable for him to remain cognitively detached in order to avoid being absorbed by the interests and perspectives of his research objects. This tension, which has to be resolved in each individual case, can be detected in all empirical social research endeavors that at least partly assume a qualitative approach. It is aggravated, however, by the widening of the cultural distance between the researcher and his field of study. The wider that distance, the more difficult this integration becomes. This integration, however, is at the same time even more necessary, as the common knowledge of a researcher does not help much in an uncommon environment. This is observable when upper middle class academics turn up in working-class areas or at social hot spots with their questionnaires in order to record or understand what is happening there. Similar difficulties have been observed with respect to studies in social geography conducted by West German researchers in the new federal states on the territory of the former German Democratic Republic.

²³⁴ The sixth research project is not an empirical but rather a methodological study: here the focus is laid on a statistical method to assess processes of political transformation (Karduck). Therefore, it will not be considered in this article.

Not surprisingly, the cultural distance and the related difficulties in the research process are most pronounced when Europeans (or North Americans) carry out empirical social research in developing countries. While problems encountered by empirical researchers elsewhere are further aggravated, this constellation also opens up a set of entirely new questions. The difficulties of social empirical research in developing countries, it is argued, differ from those of similar research in more familiar surroundings in degree and in kind.

On the quest for methodological guidance it can be noted that handbooks on empirical social research hardly deal with research activities in developing countries. This is understandable, for the majority of readers of those handbooks will not plan research trips to distant regions. They are looking for guidance based on examples more familiar to them than decentralization in Benin or environmental protection in Kyrgyzstan. Due to the special and additional challenges arising from research in developing countries, one cannot expect specialists in methods, who have mainly or exclusively worked in their own cultural context, to provide qualified assistance with respect to this specific field. This can rather be expected from the researchers focusing on anthropological, social, and political phenomena in developing countries, as many of those studies are indeed based upon empirical social research.

Those studies, however, rarely elaborate on their methodological questions and difficulties. This can be explained by the following lines of thought. Many of the studies just mentioned (just as those compiled in this volume) are prepared to obtain an academic degree. Accordingly, apart from trying to do justice to the issues under investigation, the authors also try to prove that they deserve their diploma or doctoral degree. In order to live up to the perceived expectations of their supervisors, employers, or universities, they might be tempted to obscure methodological difficulties or chaotic elements in the conduct of their field research. It is not argued here that researchers necessarily omit information knowingly, let alone try to cheat their way through graduation procedures. It is rather considered a well-established fact that the desire to protect one's self-image as a researcher leads to selective perceptions concerning the research process. Accordingly, mistakes that were made and frustrations that were experienced tend to be unconsciously ignored or belittled; and, in the end, the impression prevails that one has completed a rather consistent and efficient research process.

In cases where the detours and difficulties of the research process find their way into the research report, they are still not secured for a public with broader interests. Even if the author is self-assured enough to share his doubts and failures with the readers, a publishing company will not necessarily be interested in including extensive methodological reflections in the printed volume. It is therefore strongly felt that, in a volume that draws together researchers from different academic disciplines, a modest contribution to address this perceived shortcoming should be made.

Any research process benefits from a critical reflection of methods, pre-conceived ideas, and the process of interaction between the researcher and his field of research. The authors of this volume strongly believe that this holds particularly true with respect to cultural and social studies in developing countries. In cultural and social sciences the research objects are individuals and the constructions and institutions they live by. Hence, any inappropriate research attitude not only endangers the quality of the findings but, worse yet, might hurt the dignity of the people defined as the target group, i.e. the people without whom the research project could never have been realized.

The relationship of the researcher who asks and the target group that is supposed to answer is inherently asymmetrical. Most methodologies demand the researcher to set an agenda, to define the topics of the discussion according to his information needs. The respondent as a representative of the target group is restricted to comment on points raised by the researchers. If a researcher from an affluent northern country interacts with the population of economically poorer regions, the asymmetrical power-relationship can be further pitched in favor of the researcher due to possible material expectations of the respondents that lead them to try to please the researcher. One should also consider that most of today's developing countries have experienced one or several forms of colonial rule and hegemonic control by European powers. The risk of injecting the persistent patterns of (post) colonial perception into the research interaction poses considerable demands on the researcher's sensitivity.

The motivation to include some form of methodological reflection in this volume has now become clear. Rather than attaching elaborate methodological sections to the individual contributions, it was considered more appropriate and richer in content to integrate the experience gathered in five distinct research processes and provide them within one chapter. Thereby dominant methodological approaches are identified and elaborated while problems unique to specific projects are also taken into account. This chapter hardly considers aspects related to secondary data, but concentrates on those parts of the research processes where primary data was collected and processed. Contradictions between experiences have not been ironed out. They are considered an inevitable result of interdisciplinary debates and of the fact that the research environments of any two studies significantly differ. Methodological details associated with a researcher here do not necessarily coincide with their contributions to this volume, as the chapters provided in some cases represent only part of a wider research endeavor or scientific exercise reaching beyond the scope of the underlying Ph.D. thesis.

This chapter includes a range of topics that are roughly arranged according to the successive stages in research design and implementation. Section two gives a short introduction to the research topics and research interests. Section three elaborates on the group of people that was expected to provide the necessary information for the research project, i.e. the target group. Section four expands upon the methods applied for the collection of data and the challenges this incurred. The following passages turn to the methods of processing and interpreting the data collected, while section six reflects the specific difficulties of intercultural research as experienced by the authors. Then follows a short assessment of the interdisciplinary research environment of the Graduates' College at the Institute of Development Research and Development Policy. By way of conclusion, the final paragraphs entitled 'lessons learned' draw a synthesis of those pages and condense the information given.

It goes without saying that this chapter cannot offer the philosophers' stone of empirical social research in developing countries. Neither does it reflect the whole range of methods in this field, nor does it review the methodological literature. It is the presentation and reflection of the recent experience of five junior researchers in Africa and Central Asia. If thanks to this chapter a handful of young researchers are able to avoid repeating the mistakes made by the contributors of this volume, it has already achieved its purpose.

C.2.2 *The issues and research interests*

The common cause of the research projects considered in this volume can already be derived from the title of the Ph.D. program itself: political, economic and social dynamics in developing countries. Those dynamics are manifold and can be observed in the reform of political structures (Dreger, Nolting), the changing roles of politically relevant groups (Berg), developments in specific policies concerning the environment (Hünninghaus), or the uplifting of formerly disadvantaged groups (Schmid). Another focus shared by the individual projects was an assessment of the relationship between developments on the social or political macro-level and dynamics on related micro-levels.

Many of the possible research questions concerning those dynamics can be grouped under two headings, i.e. the causes of change and the effects of change. Although most of the projects appear to cover both those aspects, a certain gravitation towards one or the other direction can be identified in each study. While Berg and Dreger rather turned towards the consequences that a policy change imposes upon parts of the population, the other contributors took the opposite view and focused on how political concepts were planned and/or implemented by the relevant actors or to what extent the very role of those actors underwent changes.

Either way, actors and their interests and behavior are at the core of these research endeavors and even partly feature in the titles of the doctoral dissertations (Berg, Nolting). The actor-centered approach is also reflected by the consideration of international agents and their policies as well as the significance they bear for the processes under investigation. Apart from the objective significance international actors enjoy due to the socio-economic leverage of development policy, this focus can be understood and justified in yet another more subjective way. All contributors to this volume were brought up and educated to hold a European perspective. Contacts and discussions with fellow Europeans throughout the field research, especially where they represented aid agencies, also cast light on the viewpoints and activities of European (i.e. Northern) organizations. Hence it appears rather natural that the significance of international actors was considered to varying degrees in most research projects.

C.2.3 *Target groups and contacts into the field*

Considering the actor-centered approach that is observable throughout this volume, it is hardly surprising that relevant information was first of all expected from those very actors. Generalizing from the five research projects, the target group can be subdivided into three categories: *actors*, *experts*, and the *people* in general. The group of *actors* comprises all the informants who are responsibly involved in the processes under investigation. They have a variety of backgrounds as they represent semi and non-governmental organizations, government departments, and local public authorities, as well as foreign and international organizations (donor agencies). Where private enterprises have a direct bearing on the problems under consideration (Schmid), they have been taken into account as well.

The defining characteristics of the *experts* are that they must on the one hand have a thorough understanding of the issues considered by the research. Accordingly, they are often specialized academics or journalists and might, in terms of their professional background, resemble the *actors*. On the other hand, they do not qualify for the group of

actors as they do not have direct stakes in the processes under consideration. They are considered to provide a more neutral point of view that is less influenced by vested interests. To distinguish sharply between those two groups is not always possible. An NGO director presently not involved in the implementation of a development program might still have long term and indirect personal interests related to it that influence the information he provides.

The third and most general target group is the *people*. In the research projects reflected here, this group is in no case constituted by a random set of the citizens of the country of research. Where the population is identified as a target group for the collection of information (Berg, Dreger, Hünninghaus), the people were approached because they were expected to feel the effects of a policy or more general changes under investigation. While the study on affirmative action by Schmid can be considered as a borderline case (the employees she considered were obviously affected by the affirmative action policy, yet they were a group rather too small and narrowly defined to be considered as *people*), the research undertaken by Nolting focuses solely on elite interaction, includes actors and experts, but does not consider the wider population. Even there, however, casual conversations with common people influenced the research perspective and provided information that found its way into the results of the study.

An important element of all five research projects was the establishment of contacts to the target groups prior to entry into the field. In this respect, the target group *people* is of limited relevance only. They can normally not be known by the time of entry into the field and can only in the rarest of cases be contacted. Consequently, the early establishment of contacts is directed at *actors* and *experts*. There is agreement among the authors of this volume that there cannot be too many pre-established contacts in the field, as many prove useless anyway, be it due to a reorientation of research focus or the lack of interest on the side of the individuals and institutions contacted. The possibility of establishing contacts obviously depends on knowledge about who there is to get acquainted with in the first place. In a case where the research endeavor is concentrated on a small number of development projects all funded by the same donor (Nolting) this knowledge is comparably easy to acquire. In other cases, early contacts had to remain somewhat tentative. This can be due to the broader scope of the research (Berg) as well as to situations where the definition of the target group within a wider range of organizations had to be delayed until arrival in the field.

Where contacts in the field were established, contacts to universities (Schmid) or the staff of western donor organizations in the country concerned (Hünninghaus, Nolting) proved extremely helpful. Donor organizations' program offices are normally among the places with better information and communication capacities in a given developing country. Additionally, the expatriates working in those programs mostly have an academic background themselves and are often acquainted with the challenges and practical difficulties of empirical social research. This might positively influence their preparedness to support researchers. Furthermore, the donor organizations themselves rely on the ongoing acquisition and integration of information in order to optimize their performance, but in their day-to-day affairs they usually cannot take the time to deal with arising difficulties and questions thoroughly. Without exception, this volume's contributors received support from German or other donor organizations throughout their field research that was instrumental in moving forward with the research project. The establishment of contacts in the field prior to

departure is also obligatory in the case of countries that require invitations when applying for visas.

Throughout the period of field research, it is usually necessary to find more informants than were identified before departure into the field. Since this is often done by asking interviewees to recommend other knowledgeable persons, another difficulty arises. This snowball system entails the risk that the interviewees recommend people who more or less share their point of view, resulting in an artificial homogeneity of the respondents' points of view that is by no means representative of the wider target group. The higher the number of initial contacts, the less the snowball system restricts the plurality of opinions. Additionally, the timely inclusion of interviewees believed to hold contradictory points of view is commendable. This again requires a degree of knowledge not always attainable at an early stage of, or even prior to, the field research.

Not surprisingly, the most reliable way to establish contacts in the field is a first field trip. Such a pre-study does not free the researcher from the necessity of getting in touch with the target group before leaving for the field. What it does, though, is to enable the researcher to test his expectations, assess the quality of the established contacts, and, if necessary, expand networking activities on site at an early stage of the research. Apart from conducting a shorter preparatory trip or pre-study that is followed by the main field research for the collection of data, the field research can also be distributed more evenly in two journeys. Those of the contributing researchers who split their field research into two parts (none went more often than that) consider this to have been a sensible decision. It enabled them to analyze phenomena under investigation at different points in time and establish a more trustful relationship with their informants.

C.2.4 Methods of data collection

Specific questions one tries to answer and interaction with target groups of diverse social and educational backgrounds require the application of different data collection techniques. The predominant method applied by the group of researchers was guided interviews with a varying degree of standardization. More guidance, eventually by the use of closed questions, seemed sensible where factual information, as opposed to opinion, was sought from the respondents, or a large number of respondents was to be considered. It can be rightly said, however, that the dividing line between facts on the one hand and opinions and perceptions on the other is nebulous. With respect to social phenomena, there are no objective criteria to distinguish between the two forms of information since social, as opposed to natural, phenomena do not exist without social actors perceiving, constructing, and labeling them.

Since all researchers approached different target groups in order to include diverging perspectives, interview guidelines and the questions themselves had to be adapted to those groups. For the most part, a basic interview guideline was established and modified for application to individual target groups. Thus, it was on the one hand possible to consider the respondent's individual background and, on the other hand, to reintegrate the findings in order to create a multi-faceted, yet coherent picture of the research issue. The main dividing line in the target groups is that between *actors* and *experts* on one side and the common *people* on the other. This difference will now be expanded upon.

Due to their occupation, *experts* and *actors*, as defined in the previous section, are often familiar with interview techniques and able to state their opinion with a certain degree of eloquence. In some cases, they even objected to the wording of questions and paraphrased them before proceeding to answer. Obviously, they knew exactly what they wanted to talk about. This does also support the point of view that subjecting senior officials to the predefined answers of closed questions does not necessarily go down well with them, although in this respect there is contradictory experience as well (Schmid). In contrast, interviewing members of the wider public demands another kind of flexibility. Questions either have to be explained or, which appears to be preferable, the highly specific language used in political and academic discourse has to be translated into expressions of customary language. In interviews with common *people*, it therefore seems recommendable to use a more open, narrative interview format to enable the respondents to elaborate on their own experience and opinion by using their own words. When interviewing the rural population in Kyrgyzstan, however, Hünninghaus made a rather contradictory experience. In her case some interviewees were not willing to talk freely but requested more precise questions and kept asking what exactly she was aiming at. Obviously, it is not easy to determine the appropriate degree of openness for a particular purpose before the first tests are carried out and evaluated.

Since only a minority of researchers primarily interviewed less educated common people systematically, experience with translators was also limited. Interviews with *actors* and *experts* were held in English, French, German, Russian, and Uzbek without using translators. Where a translator's services were systematically applied (Hünninghaus), the potential distortion of the results was acknowledged and critically reflected in the research design. Particularly in cases where it was necessary to restructure or paraphrase questions, the translator features as a strong filter between informants and researcher. A loosely related element of uncertainty in the collection of data occurred in Schmid's study, as she was the only researcher in the group to apply a written survey. Her questionnaires were distributed within the organizations considered in a way not entirely transparent to her. It should be noted, however, that those filters are practically omnipresent and hard to tackle, as was already exemplified by the reference to the snowball system in the selection of interview partners.

The number of interviews conducted for the studies varies greatly. Where figures are provided, they range from about 70 (Nolting) to 254 interviews (Hünninghaus). This high number was reached by asking practically everyone met in the villages under investigation. There were also remarkable differences in the lengths of the interviews.

Those who used a voice recorder to tape the interviews consider it a great asset. Respondents themselves often indicated any objection they might have had to being recorded. At the same time, switching off the recording device, particularly towards the end of the interview, often opened up yet another level of confidentiality. Researchers who did not use recording devices did not comment on difficulties with lost data. One who applied the voice recorder only to one category of his interviews and took written notes in the other cases found compiling an elaborate interview transcript without the answers on tape rather challenging (Nolting). In those cases, a detailed transcript was made at the earliest possible occasion, ideally on the same day.

While the reliance of the studies solely on the data gathered from conducted interviews and surveys can be ruled out, only two researchers (Berg, Dreger) identify participatory

observation as another means of collecting information. While in Dreger's case this arose inevitably from her attachment to a donor funded development project, Berg, who based her research on Anselm Strauss' Grounded Theory, systematically included those observations in her research design.

The majority applied only qualitative methods to gain an understanding of the issues under consideration. Schmid combined qualitative and quantitative data in order to present her case studies against a backdrop of more extensive and possibly less subjective information. One researcher (Nolting) originally planned to apply quantitative methods to gather information on the planning and implementation of development projects. This approach was neither appropriate for the processes studied nor for the target groups envisaged and was abandoned following warnings from academics and practitioners alike. His fixation about methodology can be interpreted as a consequence of the interplay between limited knowledge and the appeal of a certain method. In this case, a better knowledge of the target group and the phenomena to be studied would have been helpful. In the worst case, the lack of thorough knowledge of the research area might result in abundant data that turns out to be of only limited relevance to working hypotheses. In this respect, the recommendation of multiple research trips is underscored once again.

C.2.5 Methods of processing and interpreting data

In accordance with the dominance of interviews with mainly open questions, the methods to process the data collected also converge to a significant degree. Transcribed interviews were mostly condensed by means of qualitative content analysis. That is to say that, starting from the underlying research interest, the interviewees' responses were arranged in categories to detect patterns and structures. Since this form of analysis is not objective in the sense of mathematical measurement, it was necessary to go through the transcripts in a repetitive fashion and to keep testing the order imposed on the material. Thus, a more consistent handling of the material is ensured. This obviously is a time and nerve consuming procedure, especially when processing large quantities of information. A fellow researcher (not contributing to this volume) who dealt with roughly 1000 pages of transcribed interviews experienced this most markedly.

Generally speaking, too large quantities of data can seriously infringe on the quality of a systematic and transparent analysis. If one realizes after data collection that the amount of data gathered in fact exceeds the capacities at hand (time, manpower, etc.), reducing the data becomes difficult for the following two reasons. Firstly, there is a tendency to avoid having done anything in vain: "Those interviews were a lot of trouble, they have to be good for something." Secondly, even if the data is reduced, this reduction is undoubtedly a first analytical step since decisions concerning which information to consider and which to disregard are made on the basis of certain assumptions. Those assumptions are not necessarily included in the research design and later made transparent in the study report. In many cases, this results in a subsequent redefinition of the target groups according to a first review of the gathered information.

Only Schmid, drawing from 139 written questionnaires, systematically applied statistical techniques for quantitative analysis. Thus, she generated her own set of quantitative data and was not entirely dependent on official statistics to put the results of her interviews into

context. This is a valuable approach since statistical data from developing countries, for a variety of reasons, is often of doubtful quality.

C.2.6 Self-reflection and perception in the field

As hinted at in the introductory remarks of this chapter, empirical research in developing countries entails just as many specific difficulties for the researcher as for the people making up the target groups. Intercultural distance has to be bridged in two ways. On the one hand, one needs clarification as to whether concepts applied in the interviews or questionnaires are used in the same ways by researcher and respondent. Different ideas of social concepts such as 'family' or 'brother' in Africa and Europe can serve as one example for a multitude of fascinating and sometimes amusing, but potentially obstructive misunderstandings. On the other hand, even when a shared idea of the key terminology has been achieved, it is still important to establish a positive atmosphere of mutual respect and appreciation. Due to the colonial experience in many parts of the world, there are still formidable starting points for miscommunication and interpersonal conflicts. Within our group, there was only little experience with those inter-cultural problems. To a large degree, this can be attributed to the elite orientation of most projects. In those cases, the majority of respondents belonged to a social and educational elite working in the development sector or in internationally active businesses. Hence, those informants had already been exposed to international terminology and business culture. Many of the respondents deal with foreigners on a regular basis and, in order to achieve their own aims, have to get along with Swedish, German, or American ways of running business or conducting interviews. While this interaction is less liable to fall victim to intercultural misunderstandings, it encourages respondents' attempts to co-opt and instrumentalize the researcher for the interviewees' other objectives, e.g. attempts to secure external funding for their institutions or organizations.

The situation just described is obviously different for those who included the perspectives of the wider (rural) population in their studies (Hünninghaus). In those cases, processing and interpreting data required extensive consideration of cultural and intercultural structures. It should be noted, however, that even in the majority of cases, where intercultural difficulties were not experienced, they might still have occurred and played into the data gathered in the field. Absence of proof is no proof of absence, and not noticing the problems of intercultural perceptions and communication might be their most hideous quality.

An experience shared by the majority of this volume's authors was to be mistaken for a representative of donor organizations. On the one hand, this could simply be an extrapolation of the target groups' everyday experience, as most Europeans they meet indeed work for those organizations or belong to diplomatic services. The often persistent assumption that the researchers belonged to a donor agency also mirrors the dependency on external support experienced by many of the respondents. Sometimes, the interviewees, especially those working for NGOs, feared hidden control mechanisms, a fear that could be eased by establishing a trust relationship, e.g. through repeated visits.

The tendency to be mistaken as a donor agency representative is obviously aggravated by any attachment to those organizations and their field offices, as was recommended above for organizational reasons. Dreger experienced this to a particular extent as she was not

only informally attached to an agency's office but in fact worked for a project while conducting her research on the decentralization process in Benin. Thus, there can be conflict between two aims throughout the field study. On the one hand, one strives for as neutral an image as possible. On the other hand, organizational back up is essential but increases the risk of being identified with a particular organization.

Notwithstanding the qualifications expanded on, the five researchers generally encountered very helpful and committed people who tried hard to support the foreigners in their work, which otherwise would hardly have advanced at all. Empirical social science based on the points of view of political actors, experts, or the population relies entirely on the interaction between the researcher and those source persons. Hence, these source persons are a valuable asset that should be cultivated.

C.2.7 The added value of an interdisciplinary working environment

Most research projects involving empirical social research in developing countries are planned and carried out in an institutionalized academic framework. This also applies to the projects dealt with here, which evolved within an interdisciplinary Ph.D. program from 1998 to 2001. One rationale of the Ph.D. program was to expose young researchers to approaches and methodologies used in other disciplines in order to enable cross fertilization between researchers of different faculties while ensuring that the individual projects fully live up to the standards of their respective faculties. Apart from the sensitization to the colleagues' approaches at an early stage of the Ph.D. program, it was envisaged to reintegrate the findings of the Ph.D. projects in order to create insights into the overarching questions guiding the participating researchers' work. This volume can indeed be seen as a direct result of this reintegration of findings within a shared framework.

In order to learn from practical experience, it is worthwhile to assess the added value of such a working environment critically, particularly with a view to the preparation of research design and subsequent field research. The results of a written survey on the perceived value of the organizational set-up and the teaching inputs offered by the hosting institute, which included colleagues not featured in this volume, provide a mixed picture. Four of the contributing researchers do not mention any positive contribution to their own projects arising from the work in the Ph.D. program at all. Two merely point out a helpful workshop on statistical methods and the advice of academic staff of the institute hosting the Ph.D. program. Finally, one researcher acknowledges the experience gained from repeated project presentations that, according to him, helped to identify errors or ambiguities in research design at an early stage and to avoid the potential repetition of those errors by colleagues. This seemingly sobering outcome needs thorough discussion and can be explained by reference to the demand side, i.e. the participating researchers, as well as to the supply side, i.e. the hosting institute.

Considering the researchers themselves first, one might ask how much interest for interdisciplinary teamwork they brought to the Ph.D. program in the first place. It can hardly be disputed that the preparation of a Ph.D. thesis, particularly when it includes field research, is a taxing and time consuming matter. Anything not directly related to one's own needs and interests might appear as an unwelcome diversion. In fact, some participants in the Ph.D. program held and articulated this perspective. Obviously, they were not convinced

of the usefulness of devoting time to questions and approaches not directly related to their own field and country of research. To really benefit from an exercise in which one only takes part unwillingly is very difficult, and one might ask why it was not possible to convince all researchers that the interdisciplinary approach can indeed be worthwhile for everyone. The difficulties were aggravated by the fact that the researchers who were originally asked to reside in the proximity of the hosting institute were scattered over a much wider area, in some cases resulting in travel times of several hours and less presence at the research institute hosting the Ph.D. program. What seems as perhaps a practical, but by no means an academically relevant, fact indeed left its mark on the Ph.D. program's activities as some researchers were practically excluded from day-to-day exchange and the arrangement of group appointments became cumbersome or even impossible.

Here the question as to whether the hosting institute sufficiently encouraged interdisciplinary exchange can be raised. Introductory lectures in all academic disciplines represented in the Ph.D. program were offered. On several occasions, workshops where the Ph.D. projects were presented and discussed opened opportunities for interdisciplinary discussion and learning. Participation in those events, however, was sometimes passive, leaving a lot of potential untapped. Without clear expressions of interest from the Ph.D. scholars, institute staff primarily provided input in accordance with the mainstream of recent research, which happened to have been rather quantitative in nature. It has already been mentioned that those researchers who took a related approach appreciated input on quantitative methods. At the same time, others sensed a predominance of methodological support they felt they were unable to apply in their more qualitative research projects.

After this critical account of the perceived benefits of the interdisciplinary working environment in field research preparation and the development of other parts of the research project, one should not end this section without the following clear statement. Firstly, some participants in the Ph.D. program indeed perceived this as a beneficial working environment. Secondly, the fact that its benefits were not as widely felt as hoped can be explained in three ways. Either those potential benefits were overrated in the first place, as highly specialized research projects necessarily turn into rather narrow-minded exercises, or the Ph.D. program's organizational set-up and the researchers' mental orientation prevented added value from developing in the way desired. Thirdly, one should not forget that one cannot compare the work done in the Ph.D. program with a control group that did not have the privilege of an interdisciplinary working environment. The real, as opposed to the felt, benefits of it can therefore not be established.

C.2.8 Lessons learned

The experience gained by five researchers over a three-year period, including an average of four months of field research, is very diverse. In the concluding part of this chapter I shall nevertheless try to identify the most important insights.

There is consensus that two or more periods of field research are recommendable, because a timely first exploratory trip can give important additional information to be considered for research project (re-)design. On the same note, this approach reduces, though does not eliminate, the risk that is alluded to in the introductory quotation, finding oneself thousands of miles away from the phenomenon to be researched with a lot of open questions and a lot

of data that does not match the questions. Where restrictions in time and funds allow only one research trip, it seems that a detailed time schedule with room for flexibility still enables satisfactory results. Although on the surface apparently a contradiction, a detailed schedule for field research and mechanisms to assess progress might indeed be a prerequisite for the flexibility required. Knowing where one stands in the realization of a research plan is instrumental in monitoring whether the direction chosen still seems rewarding. An all too liberal research design and implementation offers even more room for variation, but it might then be hard to answer the question "variation from what?" Nevertheless, one contributor to this volume doubts the relevance of a time schedule in general, as necessities demand continuous adaptations.

Entry into the field was a crucial point for the authors of this volume. It was noted that the organizational capacities of western donor organizations' offices offer promising entry points. The difficulties this produces for perception in the field, however, have to be taken into account and should be actively ameliorated. This can be done by making one's own interest and research aims particularly clear to the identified target groups. In terms of research efficiency for the kind of research projects considered here, there does not seem to be an alternative to donor organizations as a starting point and organizational hub. The fact that in one case such a contact resulted in a subsequent employment might further encourage researchers to strive for good working relationships with donor organizations in their field of research.

It has already been pointed out that flexibility is essential. Especially less experienced researchers (such as those featured in this volume) risk frustrations and unsatisfactory results when they cling to the hypotheses and methods developed in their home country far from the realities of their country of investigation. It is essential to have the courage to change the methods applied throughout the research process when there is good reason to conclude that they are inappropriate. The alternative, following a ballistic course without looking to the left or right and without critically reflecting one's chartered course, might appear impressive at a first glance. The main result of such a research activity, however, might be the insight that the methods applied did not fit the research interest or the environment.

There are a number of practical details that should be pointed out, too: If it does not infringe upon the conversation atmosphere, the recording of interviews seems recommendable as it conserves details that would otherwise be lost. Taking notes while asking the next question is no simple task, especially if it is not in the researcher's mother tongue. Having respondents wait until one has finished writing down complete answers does not seem an option either. If a voice recorder is out of the question, one should write a detailed transcript on the basis of the notes at the earliest possible occasion as memory fades rapidly. If the transcripts are to be typed, e.g. to enable subsequent application of analysis software, starting to transcribe recorded interviews directly into the computer or typing written notes in small portions while still in the field was experienced as an asset. Arriving home with a bag full of tapes that need transcribing is not a pleasant situation. Written material such as reports or working papers should be requested and collected as early as possible. Colleagues who did not, found it difficult to get a hold of them later.

One contributing researcher nearly ran into difficulties by being too shy to contact the informants persistently enough. Obviously, a modest and polite approach to the target group is suitable and exaggerated boldness will spoil the atmosphere from the start. At the

same time, however, if one is not prepared to make clear one's need for information when conversing with informants, empirical social research becomes an even more cumbersome exercise for all sides involved.

Just as the reactions of today's informants are determined by their past experience with researchers, the impression left by the researchers today will make future researchers' work easier or harder. Research ethics is not just a matter of respect for one's 'research objects', it also has to do with paving the way for future colleagues by establishing professional and positive relationships with informants and supporting institutions alike. Part of this is to disclose the findings of the research endeavor to the people who contributed to it, if they wish to see it.

There are hosts of further questions and problems related to empirical social research in developing countries that cannot be dealt with in this format. One that should at least be alluded to could be called the 'limits of empiricism'. The five research projects this chapter is based on displayed many ways in which a strictly empirical approach (based on experience) is curtailed. The importance of translators in mediating between the researcher and the realities of informants has already been stated. Another limit of empiricism can be found in the distribution of questionnaires in a way not fully transparent to the researcher. With respect to interviews, a related phenomenon is the directing force of the snowball system that tends to create an artificially homogeneous pool of interviewees. Here as well, decisions concerning the selection of respondents are delegated to the respondents themselves, giving them a greater say in the research design than envisaged at the outset. The snowball effect can be somewhat weakened if the starting points for interview series are deliberately chosen to include independent or even antagonistic networks of respondents. This strategy, however, implies a fair understanding of the interpersonal relations within the target group, which is normally not available prior to the collection of data, but rather a result of it.

Due to the very nature of empirical social science, it is impossible to reduce those mediating variables to zero and design a research process that links the researcher directly to the issue under investigation. Mediating variables, however, can also be seen as a source of insight themselves. Being mistaken for a representative of a donor organization is indeed an impediment to the collection of information. Simultaneously though, it is in itself a result that deserves interpretation. Because of those mediating variables, a systematic outline of the research strategy, the methods applied, and the modifications undertaken along the way is all the more important. In a detailed documentation of the research process, information on methods is indeed a prerequisite for follow-up examination or future replication. In the social sciences, those scientific demands will never be satisfied in a way comparable to the natural sciences with their laboratory situations. Due to the central importance of methods in upholding scientific standards, the question as to whether methods are a support or a constraint is not a real question in the first place. By restricting researchers' fancies, methods not only support the quality of individual work but also ensure that the research project is not destined to remain an isolated endeavor but can also be communicated and related to other efforts. Thus, methods can contribute to a gradual improvement of our understanding of social processes in developing countries.

The Authors:

Andrea **Berg** was born in 1973. She studied Political Science in Berlin and did her PhD in Islamic Studies and is currently working at the Institute for Peace Research and Security Policy at the University of Hamburg.

Mirka **Dreger** was born in 1974. She studied Law in Cologne and Paris (Pantheon Sorbonne) and did her PhD in Law. Currently she is working at the Institute for Development Research and Development Policy.

Anke **Hueninghaus** was born in 1968. She studied Geography in Bochum and did her PhD in the same subject. She is currently working at the Institute for Development Research and Development Policy.

Stefan **Karduck** was born in 1969. He studied Social Science in Bochum and did his PhD in this subject. He is currently working at the Development Research Center, University of Cologne.

Armin **Nolting** was born in 1971. He studied Political Science in Freiburg and did his PhD in the same subject. He is currently working at GTZ (Deutsche Gesellschaft für Technische Zusammenarbeit GmbH), Eschborn.

Sabine **Schmid** was born in 1970. She studied Pedagogy in Dortmund and did her PhD in Political Science. She is currently working at GTZ (Deutsche Gesellschaft für Technische Zusammenarbeit GmbH), Eschborn.