

Nah, Won Jun; Lavoie, Marc

Working Paper

The role of autonomous demand growth in a neo-Kaleckian conflicting-claims framework

FMM Working Paper, No. 22

Provided in Cooperation with:

Macroeconomic Policy Institute (IMK) at the Hans Boeckler Foundation

Suggested Citation: Nah, Won Jun; Lavoie, Marc (2018) : The role of autonomous demand growth in a neo-Kaleckian conflicting-claims framework, FMM Working Paper, No. 22, Hans-Böckler-Stiftung, Macroeconomic Policy Institute (IMK), Forum for Macroeconomics and Macroeconomic Policies (FMM), Düsseldorf

This Version is available at:

<https://hdl.handle.net/10419/181480>

Standard-Nutzungsbedingungen:

Die Dokumente auf EconStor dürfen zu eigenen wissenschaftlichen Zwecken und zum Privatgebrauch gespeichert und kopiert werden.

Sie dürfen die Dokumente nicht für öffentliche oder kommerzielle Zwecke vervielfältigen, öffentlich ausstellen, öffentlich zugänglich machen, vertreiben oder anderweitig nutzen.

Sofern die Verfasser die Dokumente unter Open-Content-Lizenzen (insbesondere CC-Lizenzen) zur Verfügung gestellt haben sollten, gelten abweichend von diesen Nutzungsbedingungen die in der dort genannten Lizenz gewährten Nutzungsrechte.

Terms of use:

Documents in EconStor may be saved and copied for your personal and scholarly purposes.

You are not to copy documents for public or commercial purposes, to exhibit the documents publicly, to make them publicly available on the internet, or to distribute or otherwise use the documents in public.

If the documents have been made available under an Open Content Licence (especially Creative Commons Licences), you may exercise further usage rights as specified in the indicated licence.

FMM WORKING PAPER

No. 22 · May, 2018 · Hans-Böckler-Stiftung

THE ROLE OF AUTONOMOUS DEMAND GROWTH IN A NEO-KALECKIAN CONFLICTING-CLAIMS FRAMEWORK

Won Jun Nah¹, Marc Lavoie²

ABSTRACT

This paper incorporates the role of an independently growing autonomous demand component into a neo-Kaleckian model of growth and distribution where the distribution of income reacts to changes in the employment rate. A peculiar feature of these autonomous expenditures is that in contrast to investment they are non-capacity creating. The model combines the Sraffian multiplier, a conflicting-claims theory of inflation, a Harroddian instability mechanism and effects tied to the size of the reserve army of labor. The long-run version of the model converges conditionally to stable rates of employment and inflation, at the normal rate of capacity utilization. The model vindicates some of the main Keynesian or Kaleckian tenets, in the sense that an increase in the marginal propensity to save out of profits or in the bargaining power of firms generate lower average rates of capital accumulation and capacity utilization during the traverse.

¹ Associate Professor, School of Economics and Trade, Kyungpook National University, 80 Daehakro, Bukgu, Daegu, 41566 Korea. wjnah7423@gmail.com

² Senior Research Chair, University of Sorbonne Paris Cité (University of Paris 13, CEPN) 99 ave. Jean-Baptiste Clément, 93430 Villetaneuse, France, mlavoie@uottawa.ca; FMM Fellow.

The role of autonomous demand growth in a neo-Kaleckian conflicting-claims framework

Won Jun Nah

Associate Professor, School of Economics and Trade, Kyungpook National University, 80 Daehakro, Bukgu, Daegu, 41566 Korea.
wjnah7423@gmail.com

Marc Lavoie

Senior Research Chair, University of Sorbonne Paris Cité (University of Paris 13, CEPN)
99 ave. Jean-Baptiste Clément, 93430 Villetaneuse, France
mlavoie@uottawa.ca

Abstract This paper incorporates the role of an independently growing autonomous demand component into a neo-Kaleckian model of growth and distribution where the distribution of income reacts to changes in the employment rate. A peculiar feature of these autonomous expenditures is that in contrast to investment they are non-capacity creating. The model combines the Sraffian multiplier, a conflicting-claims theory of inflation, a Harrodian instability mechanism and effects tied to the size of the reserve army of labor. The long-run version of the model converges conditionally to stable rates of employment and inflation, at the normal rate of capacity utilization. The model vindicates some of the main Keynesian or Kaleckian tenets, in the sense that an increase in the marginal propensity to save out of profits or in the bargaining power of firms generate lower average rates of capital accumulation and capacity utilization during the traverse.

Key words: *neo-Kaleckian; wage-led growth; autonomous expenditures; conflicting claims*

JEL codes: *E11, F41, O41*

The role of autonomous demand growth in a neo-Kaleckian conflicting-claims framework

1. Introduction

Recently, there has been a surge of interest among researchers over the role of autonomous expenditures in a neo-Kaleckian model of growth and distribution. This class of models, which has been first proposed by Allain (2015), and then by Lavoie (2014, 2016) and Dutt (2015), picks up the so-called “Sraffian super-multiplier” argument put forward by Serrano (1995a, 1995b) and Bortis (1997), and introduces it into an otherwise canonical neo-Kaleckian model. Investment in capacity is regarded as an induced component of demand, which is itself attuned to the growth rate of the non-capacity creating autonomous component of demand. This approach enables neo-Kaleckian models to achieve the normal rate of utilization of capacity in the long run, while still preserving Keynesian results such as the paradox of thrift and the paradox of costs. There have already been a few extensions along this line of research in various directions, for example, Hein (2016), Dutt (2016), Lavoie (2017), Nah and Lavoie (2017, 2018), Fazzari et al. (2018). Whereas Allain (2015), Hein (2016) and Dutt (2016) focused on government spending as an independently growing demand component, Lavoie (2016) and Nah and Lavoie (2017) assumed a similar role of a non-proportional part of capitalists’ consumption with respect to their profit income, and a part of export demand which is not explained by exchange rate fluctuations, respectively. Fazzari et al. (2018) examine the consequences of such an approach for the rate of unemployment. Also it should be noted that there have been recent empirical studies that provide support for the important role of autonomously or semi-autonomously growing expenditures, such as Girardi and Pariboni (2016) and Fiebiger (2018).

However, up until now, the distribution of income between capital and labor has always been assumed to be exogenously given in this class of models. The authors making this assumption were aware that that income distribution is being affected by the extent of economic activity and the situation of the labour market, but the assumption was made as a first-step simplification. Income distribution is both affecting and, at the same time,

affected by the course of economic growth. It follows that it would be best to consider all possible ramifications resulting from the endogenous and simultaneous interactions between the distribution of income and all the other relevant variables within the economy when we examine the role of an autonomously-growing demand component.

We want to start to fill this gap. In this paper, we investigate the effects of an autonomously growing demand in an environment where the distribution of income is endogenous. For this purpose, we apply the framework of conflicting-claims inflation initially developed by Rowthorn (1977), and we embed price-setting and wage-setting relations by firms and labor unions into a version of Lavoie (2016). This essentially makes income distribution, i.e., the relative shares of wages and profits, endogenously determined. With this explicit consideration of the endogeneity of income distribution, we introduce feedback relations running from capacity utilization and accumulation to income distribution into a neo-Kaleckian growth model with autonomous expenditures and examine the issue of the long-run stability of the model, in a manner which is reminiscent of the approach previously taken by Stockhammer (2004).

The key results of the present study are not reproduced here and we will summarize them in Section 7 as concluding remarks. The Section 2 which follows lays out the basic assumptions of our model. For analytical clarity and tractability, the model is separated into its short-run, medium-run, and long-run versions. The properties of equilibrium and the related transitional dynamics are investigated analytically for each run in Sections 3 through 5. The main results will be confirmed in Section 6 with the help of numerical simulations.

2. The economic environment

We employ the following function for the saving equation, in consideration of the autonomous demand term which captures the consumption by capitalists which does not depend on their profit income.

$$\sigma = s_p \pi u - z \tag{1}$$

where s_p denotes the propensity to save out of profits of capitalists, π the share of profits, u a proxy for the rate of utilization of capacity which is output q divided by the stock of capital K , and z the ratio of the autonomous consumption of capitalists Z to the stock of capital. It is further assumed that workers spend all of their wages.

The accumulation function is specified in its simple neo-Kaleckian form.

$$g = \gamma + \gamma_u(u - u_n) \quad (2)$$

where g is the rate of accumulation, i.e., the ratio of net investment to the stock of capital, and hence the rate of output growth in equilibrium. γ captures Harroddian adjustments in investment and is assumed to take on a positive value. γ_u is a positive parameter which relates the rate of accumulation to the rate of utilization of capacity. u_n is the *normal*, i.e., targeted rate of utilization of capacity.

We specify both wage inflation and price inflation in terms of the conflicting-claims argument initially found in Rowthorn (1977) and other Cambridge authors as the following. For simplification, we do not consider technical progress in this paper.

$$\frac{\dot{w}}{w} \equiv \hat{w} = \Omega(\varpi_w - \varpi) \quad (3)$$

$$\frac{\dot{p}}{p} \equiv \hat{p} = \Psi(\varpi - \varpi_f) \quad (4)$$

where w , p , and ϖ denote the nominal wage rate, price level, and real wage rate, respectively. ϖ_w is the real wage target of labor unions while ϖ_f is that of firms. The strengths of the bargaining position of workers and capitalists are represented by Ω and Ψ , respectively. Since Ω and Ψ can be regarded as being relative to each other, we further assume that $\Omega = 1 - \Psi$ and $0 < \Psi < 1$. Also we can posit that $\varpi_f < \varpi_w$.

3. Short-run equilibrium

In this paper, the short-run is defined as the time period during which both the level of autonomous consumption and the stock of capital are given. The growth rate of capital determines the level of investment at a moment of time. Hence, we have z as a given constant in the short run. Also in the short run, we assume that γ , a Harrodian variable, and n , the rate of growth of active population, are both exogenous constants. On the other hand, the rate of utilization of capacity, the rate of accumulation, the rate of inflation, the rate of profit and the share of profits are endogenously determined in the short run. The medium run is the period during which z is allowed to adjust, while in the long run γ will be allowed to adjust as well.

The equilibrium is conditioned by the two criteria given by equations (5) and (9) below, the first of which equates saving to investment by adjusting u such that

$$\dot{u} = \phi_u(g - \sigma) = 0, \quad \phi_u > 0 \quad (5)$$

From (5), the equilibrium rates of capacity utilization and of capital accumulation are given by:

$$u^* = \frac{\gamma + z - \gamma_u u_n}{s_p \pi^* - \gamma_u} \quad (6)$$

$$g^* = \frac{s_p \pi^* \gamma + \gamma_u (z - s_p \pi^* u_n)}{s_p \pi^* - \gamma_u} \quad (7)$$

where $*$ represents the short-run equilibrium. Here we assume that both the denominator and the numerator of (6) are positive so that Keynesian stability holds and the rate of utilization is positive in equilibrium.

The second criterion for the equilibrium is the constancy of the actual real wage rate, since we abstract from technical progress.

$$\dot{w} = 0$$

In the equilibrium where the real wage rate is constant, it is obvious from (3) and (4) that both the rates of wage inflation and price inflation are equal and constant.

$$\hat{p}^* = \hat{w}^* = \text{constant}$$

The equilibrium real wage rate ϖ^* can be solved for by equating (3) and (4).

$$\varpi^* = \Psi \varpi_f + (1 - \Psi) \varpi_w$$

Note here that π^* and ϖ^* are in close connection with each other since

$$\pi = \frac{pq - wE}{pq} = 1 - \frac{\varpi}{y}$$

and

$$\varpi = y(1 - \pi)$$

where E and y denote employment and average labour productivity, respectively. Hence we can rewrite the equilibrium criterion above as the constancy of the share of profit.

$$\dot{\pi} = 0 \tag{8}$$

Also, we can derive the equilibrium share of profits π^* .

$$\pi^* = \Psi \pi_f + (1 - \Psi) \pi_w \tag{9}$$

where

$$\pi_f \equiv 1 - \frac{\varpi_f}{y}$$

and

$$\pi_w \equiv 1 - \frac{\varpi_w}{y}$$

which implies that there is a one-to-one correspondence between the target real wage and the target profit share in the case where there is no change in productivity. Notice that targets for the real wage and the profit share move in opposite directions. As the former

goes up, the latter goes down.

Assuming, as done by Lavoie (2014, ch. 8), that the target wage share of workers increases with faster growth rates of the employment rate, or equivalently assuming that the target profit share of workers is inversely related to the growth rate of the employment rate,¹ we have:

$$\pi_w = \nu_0 - \nu_1(\dot{e}/e)$$

where e denotes the rate of employment which is the size of employment divided by the size of the labor forces with $\nu_0 > 0$ and $\nu_1 > 0$. Then it follows that

$$\pi_w = \nu_0 - \nu_1(g - n) \tag{10}$$

where n is growth rate of the active population. We suppose that ϖ_f and hence π_f are exogenously set.

Plugging (10) into (9), we can express π^* as a linear function either of g^* or of u^* as follows.

$$\pi^* = A - Bg^* \tag{11}$$

Or recalling the definition of equation (2),

$$\pi^* = C - Du^* \tag{12}$$

where

$$A \equiv \Psi\pi_f + (1 - \Psi)(\nu_0 + \nu_1 n)$$

¹ This assumption looks similar to that of Cassetti (2003), but it is different. Cassetti (2003) assumed that the workers' bargaining power depends on the growth rate of the level of employment, whereas we assume that it depends on the growth rate of the employment rate. The difference in the assumptions will turn out to be consequential because we shall later assume that the growth rate of active population becomes an endogenous variable when we deal with the long run.

$$B \equiv (1 - \Psi) v_1$$

$$C \equiv A - B(\gamma - \gamma_u u_n)$$

$$D \equiv B\gamma_u$$

A triplet (π^*, u^*, g^*) of equilibrium profit share, equilibrium rate of capacity utilization, and equilibrium rate of accumulation can be simultaneously solved for from (6) and (12), or alternatively from (7) and (11). It is evident from (6) that u^* is monotonically decreasing in π^* . Hence if we treat u^* as a function of π^* , then it follows that

$$\frac{du^*}{d\pi^*} = -\frac{s_p u^*}{s_p \pi^* - \gamma_u} < 0$$

and

$$\frac{d(u^*)^2}{d^2\pi^*} = \frac{2 s_p^2 u^*}{(s_p \pi^* - \gamma_u)^2} > 0$$

This implies that the equilibrium rate of capacity utilization given by (6) can be depicted as a decreasing curve which is convex to the origin in the (π, u) plane.

Equation (12) is obviously a decreasing linear function in the (π, u) plane, as shown in [Figure 1]. This one-to-one function maps a constant-inflation share of profits to each of the rates of utilization of capacity. Both π and u should be positive and hence only the north-east quadrant is relevant. Hence, we need to assume that $C > 0$.

[Figure 1] around here

The short-run equilibrium (π^*, u^*) can be represented as the points where the two curves representing equations (6) and (12) intersect in [Figure 2]. Three different cases emerge as in panels (a), (b) and (c).

[Figure 2] around here

From the equality of (3) and (4), we must have:

$$\Psi y(\pi_f - \pi^*) = (1 - \Psi)y(\pi^* - \pi_w)$$

Now if $\pi < \pi^*$, then it follows that

$$\hat{p} = \Psi y(\pi_f - \pi) > \Psi y(\pi_f - \pi^*)$$

and

$$\hat{w} = (1 - \Psi)y(\pi - \pi_w) < (1 - \Psi)y(\pi^* - \pi_w)$$

When the share of profits π falls short of its equilibrium constant-inflation level π^* , price inflation exceeds wage inflation and hence the share of profits goes up, i.e.,

$$\pi < \pi^* \quad \Rightarrow \quad \dot{\pi} > 0 \quad (13)$$

and conversely

$$\pi > \pi^* \quad \Rightarrow \quad \dot{\pi} < 0 \quad (14)$$

Consider the case where there are two equilibria, as shown in panel (a) of [Figure 2]. Suppose that we are on the demarcation line of $\dot{u} = 0$. Now moving along $\dot{u} = 0$, let us consider a perturbation around (π_L, u_H) . Clearly, we can see that even a tiny disturbance drives our economy away from the point (π_L, u_H) due to (13) and (14). Any increase in u results in $\pi > \pi^*$, lowering π . This in turn increases u further away from u_H . Thus, (π_L, u_H) is unstable. On the contrary, we can verify that the other combination, given by (π_H, u_L) , is a stable equilibrium by the same way of reasoning. Any increase in u results in $\pi < \pi^*$, which in turn increases π and decreases u .²

Panel (b) of [Figure 2] exhibits the case with no equilibrium, while panel (c) is the case of tangency. In panel (c), there is a unique combination of (π^*, u^*) satisfying (6) and (12) simultaneously. However, based on the arguments in (13) and (14), we can conclude that this point of (π^*, u^*) is unstable. In this paper, we confine our attentions only to the case of stable equilibrium, which is in fact unique, and rule out the possibility of either panel (b) or (c). [Figure 3] illustrates the determination of the short-run equilibrium of the present model.

² These results confirm those of Cassetti (2003) and Stockhammer (2004).

The exact solution of (π^*, u^*, g^*) can be algebraically obtained from (6), (7), (11) and (12) as follows.

$$u^* = \frac{s_p C - \gamma_u - \sqrt{G}}{2s_p D} \quad (15)$$

$$\pi^* = \frac{s_p C + \gamma_u + \sqrt{G}}{2s_p} \quad (16)$$

$$g^* = \frac{F - \sqrt{H}}{2s_p B} \quad (17)$$

where

$$F \equiv s_p [A + B(\gamma - \gamma_u u_n)] - \gamma_u$$

$$G \equiv (s_p C - \gamma_u)^2 - 4s_p D(\gamma + z - \gamma_u u_n)$$

and

$$H \equiv F^2 - 4s_p B[s_p A(\gamma - \gamma_u u_n) + \gamma_u z]$$

For this unique solution (π^*, u^*, g^*) to be real and positive, we assume that the following strict inequalities hold.

$$s_p C > \gamma_u \quad (18)$$

$$G > 0 \quad (19)$$

$$H > 0 \quad (20)$$

Additionally, we can solve for the rate of equilibrium inflation using (4) and (11).

$$\hat{p} = \Psi y (\pi_f - \pi^*) = \Psi(1 - \Psi)y (\pi_f - v_0 + v_1(g^* - n))$$

It is easy to see that in the short run

$$\frac{\partial \hat{p}}{\partial g^*} = \Psi(1 - \Psi)y v_1 > 0$$

which vindicates the positive association between growth and inflation in the short run.

[Figure 3] around here

Now let us consider the characteristics of this equilibrium. Firstly, suppose there is an increase in the marginal propensity to save out of profit income. This indeed shifts the demarcation line of $\dot{u} = 0$ leftward in parallel fashion as in the upper panel of [Figure 4].

Furthermore, this rotates the saving curve counterclockwise as in the lower panel. In the short run, a higher saving propensity is associated with a lower rate of utilization of capacity, a lower rate of accumulation and a higher share of profits. This can be interpreted as confirming the well-known Keynesian paradox of thrift.

[Figure 4] around here

We can see that a change in functional income distribution also affects the short-run equilibrium. An exogenous increase in either π_f or v_0 shifts the demarcation line of $\dot{\pi} = 0$ to the right in parallel fashion since, obviously from (12), we have

$$\frac{\partial \pi^*}{\partial \pi_f} = \Psi > 0$$

$$\frac{\partial \pi^*}{\partial v_0} = 1 - \Psi > 0$$

This upward adjustment in capitalists' claims for profit and the accompanying concessions by workers result in an increase in the equilibrium share of profits, which also brings about a pivot of the saving curve counterclockwise. The consequences are the lower rates of capacity utilization and accumulation. This is illustrated in [Figure 5]. Conversely, we can

expect that a downward adjustment in capitalists' claims for profits yields higher rates of utilization and accumulation in the short run.

[Figure 5] around here

A change in income distribution owing to a shift in the relative bargaining positions between capitalists and workers also affects the short-run equilibrium. Let us consider an increase in Ψ . The effect of this enhancement of capitalists' bargaining power can be evaluated also from (12).

$$\frac{\partial \pi^*}{\partial \Psi} = \pi_f - (v_0 - v_1(\gamma + \gamma_u(u^* - u_n) - n)) = \pi_f - \pi_w > 0$$

Therefore, unless $\pi_f < \pi_w$, or equivalently, unless $\varpi_f > \varpi_w$, a stronger bargaining power of capitalists is associated with a rightward parallel shift of the demarcation line of $\dot{\pi} = 0$ and also a counterclockwise pivot of the saving curve. These are illustrated with the help of [Figure 5]. From this, we can infer that the present model with an endogenous profit share exhibits wage-led demand and growth regimes in the short run.

4. Medium-run equilibrium

Now, let us move on to a longer time horizon. To focus on the pure dynamic effects of autonomously growing expenditures, we define the *medium run* as a logical period which is a succession of short runs, yet this time with an independently growing consumption. We relax the constancy assumption of z and, in order to allow for the Sraffian supermultiplier to work out, posit that Z increases at an exogenous rate given by \bar{g}_z . Note that we are still holding γ and n constant. It follows that z grows in accordance with the following law of motion.

$$\frac{\dot{z}}{z} \equiv \hat{z} = \bar{g}_z - g^*$$

(21)

We can then define the medium-run equilibrium as being conditioned by

$$\hat{z} = 0$$

with $z > 0$. Thus, the medium-run equilibrium value of z , which we denote by z^{**} , can be solved for by combining equations (17) and (21).

$$z^{**} = -\frac{s_p B}{\gamma_u} \bar{g}_z^2 + \frac{F}{\gamma_u} \bar{g}_z - \frac{s_p A \gamma}{\gamma_u} + s_p A u_n \quad (22)$$

where $**$ represents the medium-run equilibrium. The stability of this equilibrium z^{**} can be verified since

$$\frac{\partial \hat{z}}{\partial z} = -\frac{\partial g^*}{\partial z} = -\frac{\gamma_u}{\sqrt{H}} < 0 \quad (23)$$

where the denominator becomes real thanks to condition (20). From this inequality, we can also see in a highly straightforward manner that

$$\frac{\partial^2 \hat{z}}{\partial z^2} < 0$$

Therefore, the evolution of z can be depicted graphically as in [Figure 6].

[Figure 6] around here

The exact location and shape of this graph can be solved for. It is easy to confirm that they depend on the values of parameters $(\alpha_1, \alpha_2, \alpha_3, \alpha_4)$, as defined in the appendix.

Now the medium-run equilibrium, a new triplet $(\pi^{**}, u^{**}, g^{**})$ is such that

$$g^{**} = \bar{g}_z \quad (24)$$

$$u^{**} = u_n + \frac{\bar{g}_z - \gamma}{\gamma_u}$$

(25)

$$\pi^{**} = A - B\bar{g}_z \quad (26)$$

We assume

$$\bar{g}_z > \gamma - \gamma_u u_n \quad (27)$$

so that the rate of utilization cannot take non-positive values. [Figure 7] demonstrates an example of adjustment process towards the medium-run position of the economy when the initial value of z , z_0 , was such that $z_0 < z^{**}$. In this case, when z increases, the demarcation line of $\dot{u} = 0$ shifts to the right as is evident from (6) or (15), while the other demarcation line remains still. This lowers the equilibrium value of π , which in turn leads to a clockwise rotation of the saving curve in the medium run.

This is a novel result of the model. We have shown that an economy that exhibits a wage-led growth regime in the short run has a medium-run equilibrium which is stable. This can be contrasted with the result previously achieved by Stockhammer (2004) in a somewhat similar neo-Kaleckian model, but without an autonomous consumption component, where the profit share was a negative function of the rate of accumulation and hence a negative function of the growth rate of the employment rate, as is the case here. With such an assumption, Stockhammer (2004) has shown that the economy needs to be in a short-run profit-led regime for the longer run equilibrium to be stable; any economy in a stable short-run wage-led regime would turn out to have an unstable long-run equilibrium. It is not so here, because of the presence of a growing autonomous non-capacity creating demand component. The present model reinforces the claim made by Freitas and Serrano (2015) that the existence of an autonomous consumption component brings stability to the model economy, a claim also recently confirmed by Fazzari et al. (2018) in a model that incorporates expectations.

[Figure 7] around here

We can investigate some of key features of this medium-run equilibrium with the help of comparative statics. Firstly, consider again an increase in the propensity to save out

of profit income. As long as \bar{g}_z is close enough to γ ,³ it follows from (22) that

$$\frac{\partial z^{**}}{\partial s_p} = \frac{z^{**} + \bar{g}_z}{s_p} > 0 \quad (28)$$

The higher is the value of $z^{**} = (Z/K)^{**}$, the lower is the rate of growth of K , once the rate of growth of Z is held constant at \bar{g}_z . A description of the evolution of z^{**} after an increase in s_p can be found in [Figure 6B] of the appendix.

Let us assume that our economy is initially at a medium-run equilibrium $(\pi^{**}, u^{**}, g^{**})$. An increase in s_p shifts the demarcation line of $\dot{u} = 0$ to the left. This increases the share of profits and hence rotates the saving curve counterclockwise as indicated by grey arrows in [Figure 8]. But, this is not the whole story. In the longer run now, as the increased saving propensity slows down capital accumulation, the ratio of the autonomous consumption to capital stock goes up from z_0^{**} to z_1^{**} .

[Figure 8] around here

This increase in the value of z^{**} brings about two changes, the first of which is the downward shift of the saving curve as is evident in (1). The second change is the rightward shift of the demarcation line of $\dot{u} = 0$ as is also clear from (6). Note that this shift of the line of $\dot{u} = 0$ is again associated with an increase in the constant-inflation share of profits, and hence the saving curve evolves clockwise towards σ_1^{**} . All of the changes are illustrated in [Figure 8] with dark arrows.

Comparing the new equilibrium with the initial one, we can conclude that, after an increase in s_p , in the medium run the economy recovers the exact same position of $(\pi^{**}, u^{**}, g^{**})$ from which it started. However, if we consider the whole duration of adjustments after the change, it is clear that the average rate of capacity utilization and the average rate of capital accumulation must be lower. In this sense, we can argue that the

³ We will see later that this relation holds in the neighborhood of the long-run equilibrium defined in this paper.

paradox of thrift is still valid in the medium run of the model.

We can also investigate the effects of changes in distribution parameters such as π_f and ν_0 , which represent claims for profits, and Ψ , the bargaining power of capitalists. In accordance with the short-run analyses already noted, an increase in either π_f , ν_0 or Ψ instantly shifts the demarcation line of $\dot{\pi} = 0$ to the right and rotates the saving curve counterclockwise accordingly. This yields lower rates of utilization and of accumulation in the short run.

However moving on to the medium run, we should additionally take into account changes in z . The effect is that z^{**} goes up due to the lower rate of accumulation, as can also be confirmed from the following inequalities, where $\pi_w(\bar{g}_z)$ is the value of π_w evaluated at $g^* = \bar{g}_z$. To check the evolution of z^{**} after each change, one can refer to [Figure 6C] and [Figure 6D] in the appendix.

$$\frac{\partial z^{**}}{\partial \pi_f} = s_p \Psi u^{**} > 0 \quad (29)$$

$$\frac{\partial z^{**}}{\partial \nu_0} = s_p (1 - \Psi) u^{**} > 0 \quad (30)$$

$$\frac{\partial z^{**}}{\partial \Psi} = s_p u^{**} (\pi_f - \pi_w(\bar{g}_z)) > 0 \quad (31)$$

With an increase in z^{**} , the saving curve shifts downward and the demarcation line of $\dot{u} = 0$ shifts to the right until the economy reaches the new medium run equilibrium at $(\pi_1^{**}, u^{**}, g^{**})$. Note that the saving curve should rotate clockwise again, reflecting the changes in the profit share to π_1^{**} . Comparing this new equilibrium with the initial one at $(\pi_0^{**}, u^{**}, g^{**})$, we can notice that the equilibrium share of profits goes up whereas there is no change in the rates of utilization and accumulation after all. From (26), we can measure

the degree to which the share of profits responds to each change.

$$\frac{\partial \pi^{**}}{\partial \pi_f} = \Psi > 0$$

$$\frac{\partial \pi^{**}}{\partial v_0} = 1 - \Psi > 0$$

$$\frac{\partial \pi^{**}}{\partial \Psi} = \pi_f - \pi_w(\bar{g}_z) > 0$$

The overall effects are illustrated in [Figure 9].

[Figure 9] around here

At first glance, this may seem to mean that distribution parameters are neutral in their effects on the economy. This would be true if we were only to compare the initial and final end positions, without considering the transitional dynamics. However, taking account of the transition process from the initial to the final positions, and thus the resulting level effects generated during the whole traverse of the adjustments towards the new medium-run equilibrium, we can conclude that the present model exhibits wage-led demand and growth regimes.

Let us now consider the medium-run effects of an exogenous increase in \bar{g}_z , the rate of growth of autonomous consumption. In (22), z^{**} is represented as a quadratic equation of \bar{g}_z . Two different values for \bar{g}_z which make z^{**} zero are given by

$$\frac{F \pm \sqrt{F^2 - 4s_p^2 AB(\gamma - \gamma_u u_n)}}{2s_p B} \equiv \Delta_1, \Delta_2$$

with $\Delta_1 < \Delta_2$. It should be noted that both Δ_1 and Δ_2 are strictly bigger than zero due to (20). Since the coefficient for the first term on the right-hand side of (22) is negative, for z^{**} to be positive, \bar{g}_z should be such that

$$\Delta_1 < \bar{g}_z < \Delta_2$$

However, we have already seen from (17) that in the medium run

$$\Delta_1 < \bar{g}_z < \frac{F}{2s_p B}$$

Note that the fraction on the far right amounts to the exact middle point between Δ_1 and Δ_2 . This implies that z^{**} must be in the range within which it increases in \bar{g}_z .

$$\frac{\partial z^{**}}{\partial \bar{g}_z} > 0$$

(32)

The evolution of z^{**} after an increase in \bar{g}_z is depicted in [Figure 6E] in the appendix, where the graph of \hat{z} shifts up in a parallel fashion.

Then what will happen to the rates of utilization and accumulation and the share of profits in the medium run? It follows from (24), (25) and (26) that

$$\frac{\partial g^{**}}{\partial \bar{g}_z} = 1 > 0$$

$$\frac{\partial u^{**}}{\partial \bar{g}_z} = \frac{1}{\gamma_u} > 0$$

$$\frac{\partial \pi^{**}}{\partial \bar{g}_z} = -(1 - \Psi)v_1 < 0$$

Clearly, a higher rate of growth of autonomous expenditures is associated with higher rates of utilization and accumulation together with a lower share of profits.

These medium-run adjustments can be explained graphically. Let's look at [Figure 10]. An increase in z^{**} due to an increase in \bar{g}_z from \bar{g}_z^0 to \bar{g}_z^1 has two distinct direct effects. Firstly, in the upper panel of the figure, it shifts the demarcation line of $\dot{u} = 0$ to the right over time. Note that this yields both a decrease in π^{**} and an increase in u^{**} . Meanwhile in the lower panel, the increase in z^{**} shifts the saving curve downward in a parallel fashion, and then there is a rotation of the saving curve clockwise reflecting the increase in π^{**} . The medium-run position of our economy was initially at $(\pi_0^{**}, u_0^{**}, g_0^{**})$, but over time it moves to $(\pi_1^{**}, u_1^{**}, g_1^{**})$.

5. Long-run equilibrium

So far, our model economy stabilizes the share of profits, the rate of accumulation and the rate of capacity utilization in its medium run where autonomous demand leads growth. However, it is not certain that the medium-run equilibrium defined in this paper brings the rate of (un)employment to a steady level. Unless the medium-run growth rate \bar{g}_z happens by fluke to equal the given growth rate of active population n , the rate of (un)employment will increase or decrease indefinitely, as has been pointed out by Casseti (2002) and Dutt (2006), just to name a few of the authors who have made this point.

As summarized in Lavoie (2014, pp. 411-416), several possible mechanisms have been proposed that reconcile the actual growth rate and the *natural* growth rate of the economy so that the rate of (un)employment reaches some constant value in the long run. To this end, we propose the following equation to help achieve the long-run equilibrium of the model:

$$n = \phi_0 + \phi_n e$$

So that, assuming that the constant in the above equation remains a constant:

$$\frac{\dot{n}}{n} \equiv \hat{n} = \phi_n \hat{e} = \phi_n (g^* - n) \tag{33}$$

with $\phi_n > 0$ and $n > 0$. This would pull the growth rate of active population towards the long-run equilibrium growth rate. It should be noted that the long-run *natural* growth rate is simply nothing but the growth rate of active population, since we assume that there is no technical progress in this paper.

This long-run adjustment mechanism can be justified on the following grounds. Firstly, economic growth can be demand-led. Within our neo-Kaleckian framework, the supply-side factors adjust to the evolution of effective demand. In the literature, it has been argued that the endogeneity of the so-called *natural* rate is quite plausible. Secondly, the

key determinants of the size of active population can indeed be regarded as being endogenous. It is very well known that the size of active population fluctuates not only with birth and death but also with migration movements into and out of the reservoir of the labor force. This can be an effect emanating from the reserve army of labor. In addition, economic fluctuations do have an impact on the rate of participation, an effect which is referred to as the *extensive margin of labor supply* and which has been emphasized in the mainstream macro labor literature. In their parlance, the decision of individual workers on whether to participate in the labor market or not is based on their *reservation wage*. In a sense, this is lending support to the idea of the endogeneity of the size of active population. To summarize, we can argue that, perhaps not all, but at least some important factors affecting the growth rate of active population can be endogenously determined by the evolution of the economy within society instead of being just exogenously given.

The only remaining condition that we need to add with a view to having a fully-adjusted position in the long run is for the targeted or normal rate of capacity utilization to be achieved. To this end, we introduce a Harrodian investment adjustment mechanism and allow γ to change in accordance with the following equation suggested by Lavoie (2014, 2016):

$$\hat{\gamma} = \phi_{\gamma}(g^* - \gamma) \quad (34)$$

with $\phi_{\gamma} > 0$. This equation reflects the argument that the growth rate of sales expected by firms, which is proxied by γ , should adjust to the realized growth rate of sales over time (which is the same as the rate of accumulation once transitions are achieved).

With the introduction of the additional adjustments of n and γ besides that of z , the long-run dynamics of the model is now governed by the system of equations (21), (33), and (34). The conditions under which this system exhibits stability in the long-run can be examined based on a Jacobian matrix, J , defined as below:

$$J = \begin{bmatrix} \frac{\partial \hat{z}}{\partial z} & \frac{\partial \hat{z}}{\partial n} & \frac{\partial \hat{z}}{\partial \gamma} \\ \frac{\partial \hat{n}}{\partial z} & \frac{\partial \hat{n}}{\partial n} & \frac{\partial \hat{n}}{\partial \gamma} \\ \frac{\partial \hat{\gamma}}{\partial z} & \frac{\partial \hat{\gamma}}{\partial n} & \frac{\partial \hat{\gamma}}{\partial \gamma} \end{bmatrix} = \begin{bmatrix} (-) & & (-) \\ 0 & (-) & 0 \\ (+) & & (+) \end{bmatrix}$$

where

$$\frac{\partial \hat{n}}{\partial n} = -\phi_n < 0$$

$$\frac{\partial \hat{n}}{\partial z} = \frac{\partial \hat{n}}{\partial \gamma} = 0$$

$$\frac{\partial \hat{\gamma}}{\partial \gamma} = \frac{\partial \hat{\gamma}}{\partial z} = \frac{\phi_\gamma}{\sqrt{G}} > 0$$

$$\frac{\partial \hat{z}}{\partial \gamma} = -\frac{1}{2} \left(1 + \frac{s_p C + \gamma_u}{\sqrt{H}} \right) < 0$$

and $\partial \hat{z}/\partial z$ is given by (23). Note that the growth of active population is a stable process as is the evolution of z , whereas that of γ alone is not. However, the present system as a whole can be stable when both the trace and the determinant of J are negative, even with the Harrodian instability embedded in the dynamics of γ .

It is very clear that the trace of J can be negative under the condition that

$$\left| \frac{\partial \hat{\gamma}}{\partial \gamma} \right| < \left| \frac{\partial \hat{z}}{\partial z} \right| + \left| \frac{\partial \hat{n}}{\partial n} \right|$$

i.e., as long as the instability due to γ can be tamed by the stability due to the growth of both autonomous expenditures and the active labor force.

It is also evident that we can define some parametric conditions under which the determinant of J becomes negative.⁴

⁴ For a $(n \times n)$ Jacobian J , the stability condition requires that $(-1)^n \text{Det}(J) > 0$.

$$\text{Det}(J) = -\phi_n \left(\frac{\partial \hat{z}}{\partial z} \frac{\partial \hat{\gamma}}{\partial \gamma} - \frac{\partial \hat{z}}{\partial \gamma} \frac{\partial \hat{\gamma}}{\partial z} \right)$$

Notice that the required condition is such that

$$\left| \frac{\partial \hat{z}}{\partial \gamma} \frac{\partial \hat{\gamma}}{\partial z} \right| > \left| \frac{\partial \hat{z}}{\partial z} \frac{\partial \hat{\gamma}}{\partial \gamma} \right|$$

Hence, we can conclude that the present model is conditionally stable around its long-run equilibrium position defined as $(z^{***}, n^{***}, \gamma^{***})$, where *** denotes long-run value of a relevant variable. The equilibrium can be solved for as follows:

$$g^{***} = \gamma^{***} = n^{***} = \bar{g}_z \quad (35)$$

$$u^{***} = u_n \quad (36)$$

$$\pi^{***} = \Psi \pi_f + (1 - \Psi) \nu_0 \quad (37)$$

$$z^{***} = s_p \pi^{***} u_n - \bar{g}_z \quad (38)$$

The long-run equilibrium rate of inflation turns out to depend on the relative bargaining power of capitalists and workers and also on their aspiration gap with respect to the target share of profits. In the long run, the rate of inflation does not depend on the rate of (employment) growth.

$$\hat{p}^{***} = \Psi(1 - \Psi)y(\pi_f - \nu_0) \quad (39)$$

Starting from the initial long-run equilibrium where $g_0^{***} = \bar{g}_z^0$, we shall consider the effects of an increase in \bar{g}_z from \bar{g}_z^0 to \bar{g}_z^1 as an interesting comparative statics. From (35), (36), (37) and (38), it can be shown that

$$\Delta g^{***} = \Delta \gamma^{***} = \Delta n^{***} = \Delta \bar{g}_z = \bar{g}_z^1 - \bar{g}_z^0 > 0$$

$$\Delta u^{***} = \Delta \pi^{***} = 0$$

$$\Delta z^{***} = -\Delta g^{***} < 0$$

The long-run equilibrium rate of accumulation increases with the growth rate of

autonomous demand. However, the rate of utilization does not change (unless there is a change in the normal rate). Also it is clear that neither the long-run profit share nor the long-run rate of inflation change after an increase in the long-run growth rate. This can be explained in the following way. Recall first that in the medium run the share of profits has fallen after an increase in \bar{g}_z . However, as the growth rate of active population increases over a longer time horizon, the target wage share of workers is exposed to downward pressures, reflecting the weaker bargaining power of their unions. This ends in the unchanged share of profits.

[Figure 11] illustrates these long-run adjustments. In the upper panel, the line of $\dot{u} = 0$ which once shifted rightward due to the higher value of z^{**} in the medium run shifts back to its original position since the changes in γ^{***} and z^{***} cancel out each other, i.e., $\Delta\gamma^{***} + \Delta z^{***} = 0$. Note that an increase in \bar{g}_z increases the value of z in the medium run at first, but over the longer time horizon the value of z should decrease due to the expansionary effects from the increased rate of accumulation of capital. Also it can be noted that the effects from an increase in n which pushes the line of $\dot{\pi} = 0$ to the right and up are exactly offset by the effects from a decrease in γ , and hence in this case there will be no shift at all of the line given by $\dot{\pi} = 0$. Moving to the lower panel, we can see that the saving curve recovers its original slope. This is because $\Delta\pi^{***} = 0$. The vertical intercept once lowered in the medium run gets higher than even its initial position as we go to the long run. Again, this is due to the response of z .

6. A numerical example

The analytical results obtained so far can be demonstrated by numerical simulations. We assume an artificial economy which has long-run characteristics as summarized in Table 1. The assumptions for the long-run share of profits and the long-run rate of growth are consistent with the values found in Franke (2017).

Profit share	Profit rate	Output to full-capacity output	Growth rate
0.310	0.100	0.800	0.025

Table 1. An artificial economy: long-run assumptions

From the assumptions for the profit share and the profit rate in the long run, we compute u_n , the normal rate of utilization of capacity, which corresponds to the long-run average ratio of output to capital⁵ as being 0.323. We assume the propensity to save out of profits, s_p , to be 0.700, which is close to the value chosen by Sasaki (2011). Consistent with this assumption for s_p , the long-run value of z is computed to be 0.045 in accordance with (38).⁶ The values for the other parameters in the model are assumed to be as follows: $\gamma_u = 0.080$, $\Psi = 0.3000$, $\pi_f = 0.5000$, and $\nu_1 = 10$. Then we can compute ν_0 in turn as being equal to 0.2285 so that the long-run share of profits can become 31%. The assumption for γ_u is also based on Sasaki (2011). The values chosen for these parameters of the model are rather provisional and can be regarded justifiably as being somewhat arbitrary. However, concerning the *qualitative* aspects of the achieved numerical results, they appear to be robust, at least when parameter values are modified within a reasonable range.⁷

Based on these calibrations, we can perform comparative static analyses either for the short, medium, or long run. Here, we present some of the results. The second, third and fourth columns of Table 2 compare an initial long-run equilibrium with the new short-run (SR) and the new long-run (LR) equilibrium following an increase in the propensity to save

⁵ In the model, the variable u proxies the rate of utilization, but in fact is the ratio of output to capital, q/K , as defined in (1) and, strictly speaking, differs from the ratio of output to full-capacity output, q/qf .

⁶ Recall that workers do not save in this paper. A propensity to save out of profits of 70% with a profit share of 31% implies that the share of saving (or investment) out of national income is 21.7%. It is well-known that the historical long-run investment-to-output ratio in the U.S. varies from 18.7% (Maddison (1992) to 24% (Summers and Heston (1984)).

⁷ Since the important endogenous variables such as the share of profits are solved for from a set of quadratic equations as shown in (15) through (17), we can have complex roots for them. In the theoretical model, this possibility is ruled out thanks to assumptions (19) and (20). However, while doing simulations, we cannot just assume away the possibility of complex roots. This problem indeed turned out to be severe and constrained our choice of parameter values. This is why we suggest that our numerical results should be understood as an illustrative example.

of capitalists s_p from 0.700 to 0.750. The second, fifth, and sixth columns do the same exercise, but this time following an increase in the relative bargaining position of capitalists Ψ from 0.300 to 0.400. Note that qf denotes the full-capacity level of output.

	Initial	SR	LR	SR	LR
s_p	0.700	0.750	0.750	0.700	0.700
Ψ	0.300	0.300	0.300	0.400	0.400
$z = Z/K$	0.045	0.045	0.050	0.045	0.051
γ, n	0.025	0.025	0.025	0.025	0.025
$\pi = P/q$	0.310	0.361	0.310	0.376	0.337
q/qf	0.800	0.575	0.800	0.597	0.800
g	0.025	0.018	0.025	0.018	0.025
\hat{p}	0.057	0.042	0.057	0.049	0.065
$r = P/K$	0.100	0.084	0.100	0.091	0.109

Table 2. Comparative statics

However, these results compare only the initial and final positions of the model economy. We believe that the whole transitional dynamics along the traverse from the initial steady state to the new one after a change in parameter values should be computed to fully examine the properties of the model. [Figure 12] and [Figure 13] summarize our computational results.

[Figure 12] around here

[Figure 13] around here

The upper panel of [Figure 14] compares the levels of capital and output when there is a permanent increase in s_p with those when there is no change in the propensity to save. The latter is shown as 100% in the figure. Likewise, the lower panel contrasts the case of a permanent increase in Ψ and the case of no change. As claimed before an increase in the propensity to save or an increase in the bargaining power of firms leads to a permanent fall in the levels of output and of productive capacity.

[Figure 14] around here

7. Concluding remarks

We investigated the role of a non-capacity creating autonomous expenditure in the process of growth of an artificial economy which is demand-constrained in its nature. In this paper, we have assumed that a part of aggregate consumption by capitalists is not proportional to their profit income and is an independently growing demand component, as in Lavoie (2016). The novelty of our model, which makes it distinct from the previous literature dealing with the super-multiplier effects of autonomous expenditures, lies in that we have applied the framework provided by the conflicting-claims theory of inflation in order to make the distribution of income between capital and labor fully endogenous. We conclude by summarizing the two main results of our study as follows.

Firstly, our model combines the dynamic effects of the conflicting-claims model of inflation and income distribution that depends on changes in the employment rate, the Sraffian super-multiplier, the Harrodian investment adjustment mechanism and an endogenous labor force. All of these turn out to contribute to a kind of classical convergence towards the fully-adjusted state in the long run where the normal rate of capacity utilization is achieved, while generating rich dynamics along the transitional path. More importantly, our model demonstrates that some of the main Keynesian tenets such as the paradox of thrift and wage-led demand (the paradox of costs) still hold not only in the short run but also in the long run. These paradoxes hold in the restricted sense that both the average rate of accumulation and that of capacity utilization decrease when we consider the whole traverse after either an increase in the marginal propensity to save out of profits, an upward adjustment in the claims on profits, or an enhancement of the bargaining power of firms relative to that of workers.

Secondly, our model contains an important message concerning the long-run stability of the wage-led demand/growth regime. Under some specific assumption about the determinants of the endogenous share of profits which is similar to our own, Stockhammer (2004) has shown that there is no stable long-run equilibrium in any economy operating within a wage-led regime. By contrast, our model demonstrates that

this defect can be successfully addressed by considering the effects of an autonomously-growing and non-capacity creating component of effective demand. In this respect, autonomous expenditures, or semi-autonomous expenditures as Fiebiger (2018) calls them, seem to play an important role, as they provide the needed medium-run or long-run stabilizing forces in a wage-led economy. This being said, some of these semi-autonomous expenditures are also likely to generate large fluctuations in the short run: one only needs to think of household expenditures in real estate. In other words, while here we assumed the growth rate \bar{g}_z to be a constant, in reality the growth rate of autonomous expenditures is likely to change substantially from period to period.

References

Allain, O. (2015), 'Tackling the instability of growth: a Kaleckian-Harrodian model with an autonomous expenditure component', *Cambridge Journal of Economics*, 39 (5), 1351-1371.

Bortis, H. (1997), *Institutions, Behaviour and Economic Theory: A Contribution to Classical-Keynesian Political Economy*, Cambridge: Cambridge University Press.

Cassetti, M. (2002), 'Conflict, inflation, distribution and terms of trade in the Kaleckian model', in Setterfield M. (ed.), *The Economics of Demand-Led Growth, Challenging the Supply-Side Vision of the Long Run*, Cheltenham: Edward Elgar, 189-211.

Cassetti, M. (2003), 'Bargaining power, effective demand and technical progress: a Kaleckian model of growth', *Cambridge Journal of Economics*, 27 (3), May, 449-464.

Dutt, A. K. (2006), 'Aggregate demand, aggregate supply and economic growth', *International Review of Applied Economics*, 20 (3), 319-336.

Dutt, A. K. (2015), 'Growth and distribution with exogenous autonomous demand growth and normal capacity utilization', mimeo.

Dutt, A.K. (2016), 'Autonomous demand growth and government debt in the short run', mimeo.

Fazzari, S., P. Ferri and A.M. Variato (2018), 'Demand-led growth and accommodating supply', FFM working paper No. 15.

Fiebiger, B. (2018), 'Semi-autonomous household expenditures as the causa causans of postwar US business cycles: the stability and instability of Luxemburg-type external markets', *Cambridge Journal of Economics*, 42 (1), 155-175.

Franke, R. (2017), 'A simple approach to overcome the problems arising from the Keynesian stability condition', *European Journal of Economics and Economic Policies: Intervention*, 14 (1), 48-69.

Freitas, F. and F. Serrano (2015), 'Growth rate and level effects: the stability of the adjustment of capacity to demand and the Sraffian supermultiplier', *Review of Political Economy*, 27 (3), 258-281.

Girardi, D. and R. Pariboni (2016), 'Long-run effective demand in the US economy: an empirical test of the Sraffian Supermultiplier model', *Review of Political Economy*, 28 (4), 523-544.

Hein, E. (2016), 'Autonomous government expenditure growth, deficits, debt and distribution in a neo-Kaleckian growth model', Working paper, Berlin School of Economics and Law, Institute for International Political Economy (IPE).

Lavoie, M. (2014), *Post-Keynesian Economics: New Foundations*, Cheltenham: Edward Elgar.

Lavoie, M. (2016), 'Convergence towards the normal rate of capacity utilization in neo-Kaleckian models: The role of non-capacity creating autonomous expenditures', *Metroeconomica*, 67 (1), 172-201.

Lavoie, M. (2017), 'Prototypes, reality and the growth rate of autonomous consumption expenditures: a rejoinder', *Metroeconomica*, 68 (1), 194-199.

Maddison, A. (1992), 'A long-run perspective on saving', *Scandinavian Journal of Economics*, 94 (2), 181-196.

Nah, W.J. and M. Lavoie (2017), 'Long-run convergence in a neo-Kaleckian open-economy model with autonomous export growth', *Journal of Post Keynesian Economics* 40 (2), 223-238.

Nah, W.J. and M. Lavoie (2018), 'Convergence in a neo-Kaleckian model with endogenous technical progress and autonomous demand growth', *Review of Keynesian Economics*.

Rowthorn, R.E. (1977), 'Conflict, inflation and money', *Cambridge Journal of Economics*, 1 (3), September, 215-239.

Sasaki, H. (2011), 'Conflict, growth, distribution, and employment: a long-run Kaleckian model', *International Review of Applied Economics*, 25 (5), 539-557.

Serrano, F. (1995a), 'Long period effective demand and the Sraffian supermultiplier', *Contributions to Political Economy*, 14, 67-90.

Serrano, F. (1995b), *The Sraffian Multiplier*, PhD dissertation, Faculty of Economics and Politics, University of Cambridge.

Stockhammer, E. (2004), 'Is there an equilibrium rate of employment in the long-run?', *Review of Political Economy*, 16 (1), 59-74.

Summers, R. and A. Heston (1984), 'Improved international comparisons of real product and its composition: 1950-1980', *Review of Income and Wealth*, 30 (2), 207-262.

Appendix: Changes in the graph of \hat{z} against z

The equation governing the evolution of z is given by

$$\hat{z} = \bar{g}_z - \alpha_1 + \alpha_2 \sqrt{\alpha_3 - \alpha_4 z}$$

where

$$\alpha_1 = \frac{F}{2s_p B}$$

$$\alpha_2 = \frac{1}{2s_p B}$$

$$\alpha_3 = F^2 - 4s_p^2 AB(\gamma - \gamma_u u_n)$$

$$\alpha_4 = 4s_p B \gamma_u$$

This function can be graphed in the (\hat{z}, z) plane as in [Figure 6A].

[Figure 6A] around here

Now we consider the effects of an increase in s_p . It can be easily seen that

$$\frac{\partial \alpha_1}{\partial s_p} > 0$$

$$\frac{\partial \alpha_2}{\partial s_p} < 0$$

$$\frac{\partial \alpha_4}{\partial s_p} > 0$$

Together with (28) $\partial z^{**} / \partial s_p > 0$, these inequalities imply that

$$\frac{\partial}{\partial s_p} \left(\frac{\alpha_3}{\alpha_4} \right) > 0$$

[Figure 6B] shows how the graph of \hat{z} evolves for two different values of s_p .

[Figure 6B] around here

Secondly, we consider the effects of an increase either in π_f or v_0 . Easily, we can see that

$$\frac{\partial \alpha_1}{\partial \pi_f} > 0$$

$$\frac{\partial \alpha_2}{\partial \pi_f} = \frac{\partial \alpha_4}{\partial \pi_f} = 0$$

$$\frac{\partial \alpha_1}{\partial v_0} > 0$$

$$\frac{\partial \alpha_2}{\partial v_0} = \frac{\partial \alpha_4}{\partial v_0} = 0$$

Again since $\partial z^{**}/\partial \pi_f > 0$ and $\partial z^{**}/\partial v_0 > 0$, the partial derivatives above imply that

$$\frac{\partial}{\partial \pi_f} \left(\frac{\alpha_3}{\alpha_4} \right) > 0$$

and

$$\frac{\partial}{\partial v_0} \left(\frac{\alpha_3}{\alpha_4} \right) > 0$$

[Figure 6C] shows how the graph of \hat{z} gets modified when there is a change in either π_f or v_0 .

[Figure 6C] around here

Finally, it is evident that both α_2 and α_4 increase in Ψ .

$$\frac{\partial \alpha_2}{\partial \Psi} > 0$$

$$\frac{\partial \alpha_4}{\partial \Psi} > 0$$

[Figure 6D] sketches some of the changes in the graph of \hat{z} after an increase in Ψ .

[Figure 6D] around here

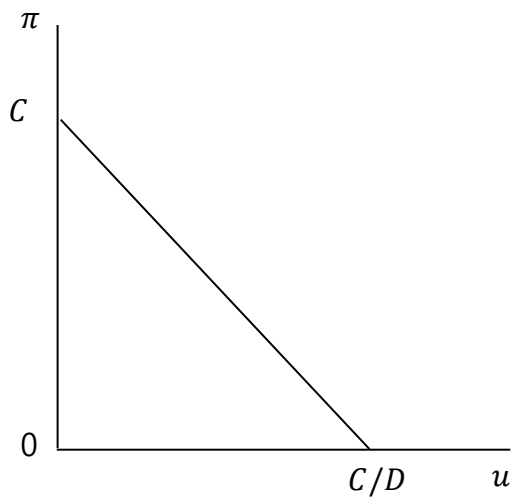

[Figure 1] Equilibrium constant-inflation share of profits

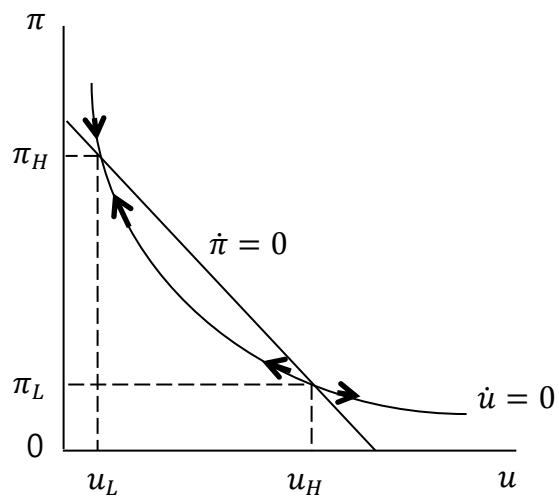

(a) Double-crossing: upper-left stable equilibrium and lower-right unstable equilibrium

[Figure 2] The short-run equilibrium of (π^*, u^*)

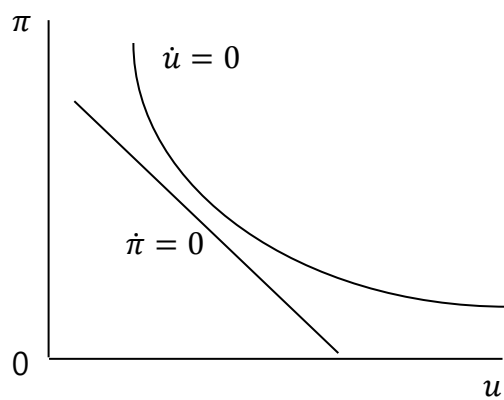

(b) No root

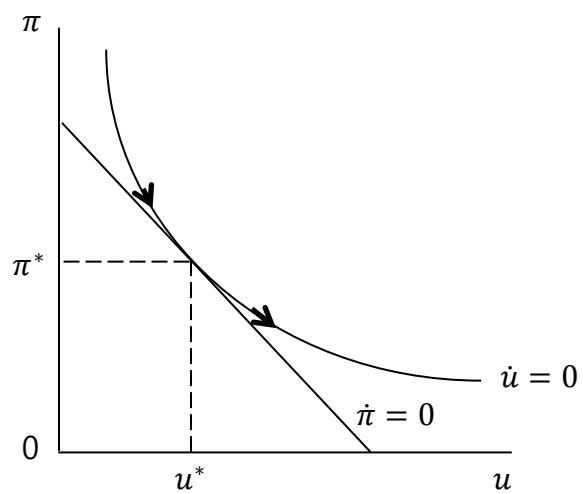

(c) Tangency: unique unstable equilibrium

[Figure 2] The short-run equilibrium of (π^*, u^*)

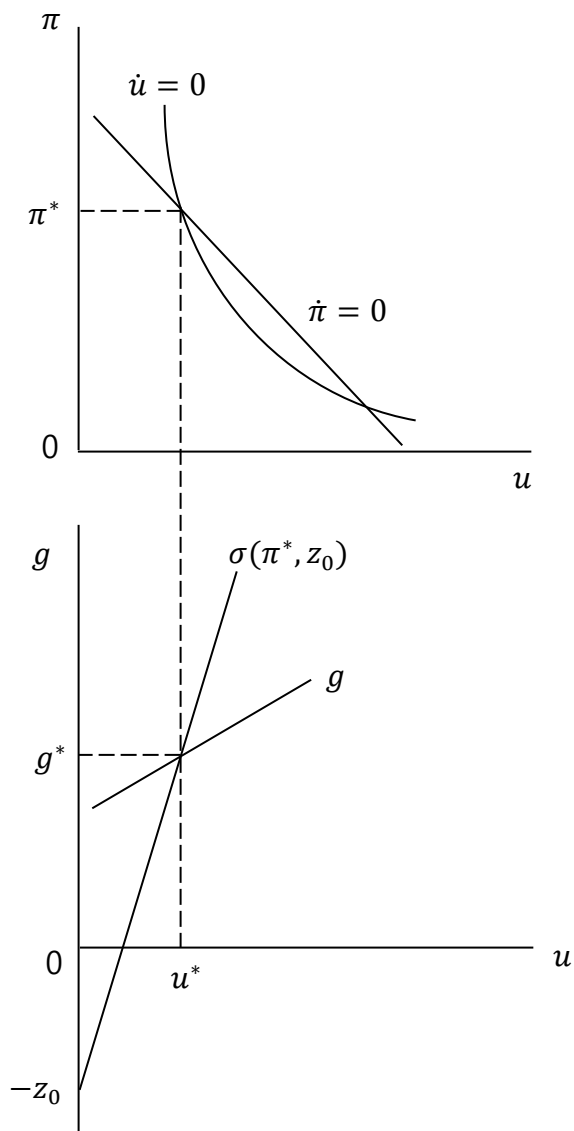

[Figure 3] Illustration of the short-run equilibrium of (π^*, u^*, g^*)

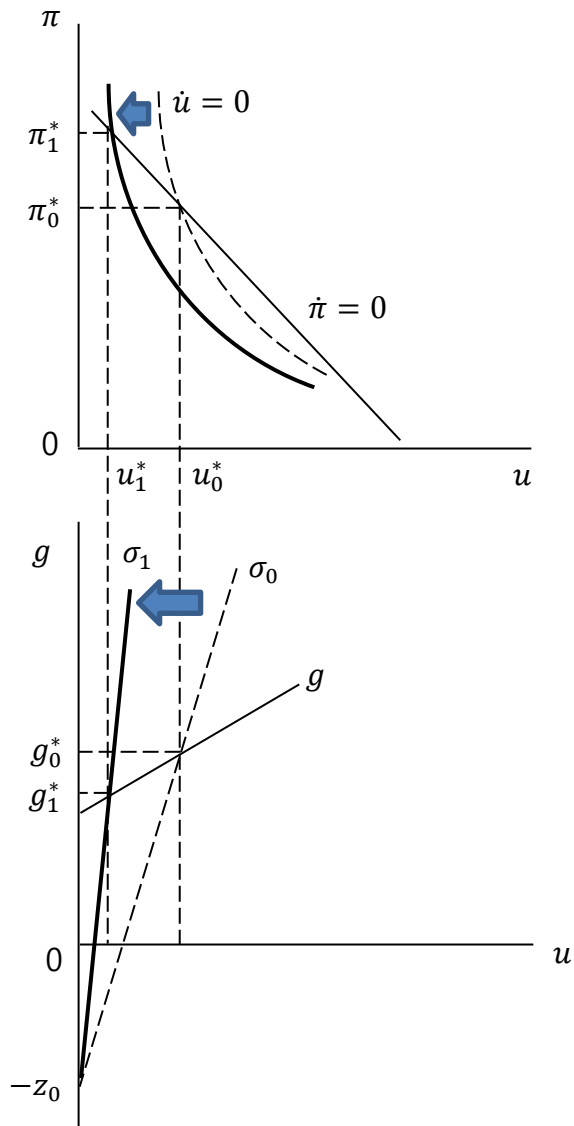

[Figure 4] The paradox of thrift in the short-run, where $\sigma_i = s_p^i \pi_i^* u - z_0$ ($i = 0, 1$).

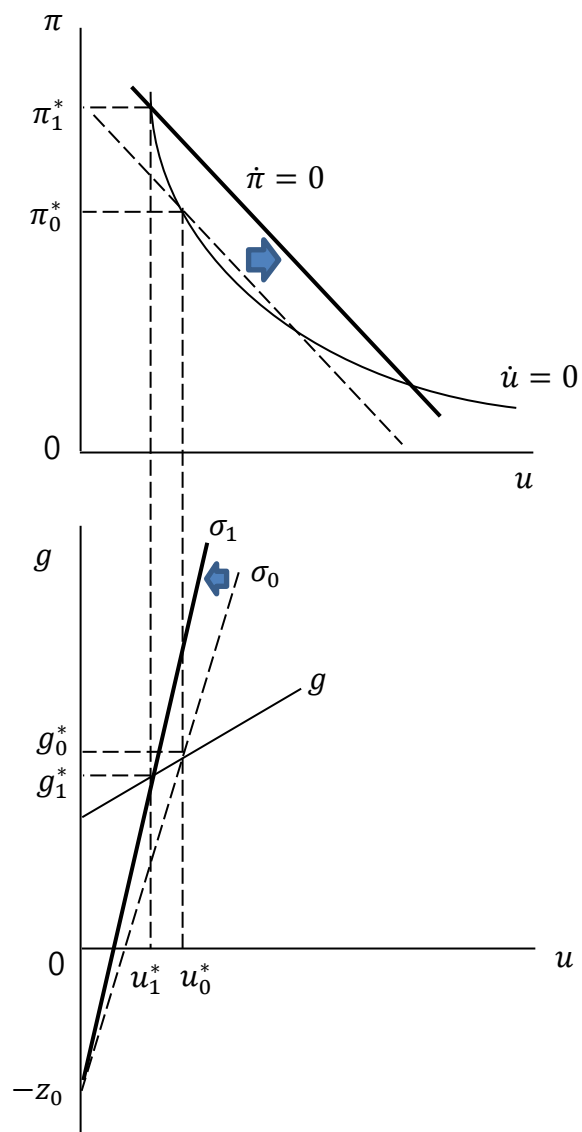

[Figure 5] The short-run effects of either an upward adjustment in capitalists' claims for profits or the stronger bargaining position of capitalists, where $\sigma_i = s_p \pi_i^* u - z_0$ ($i = 0, 1$).

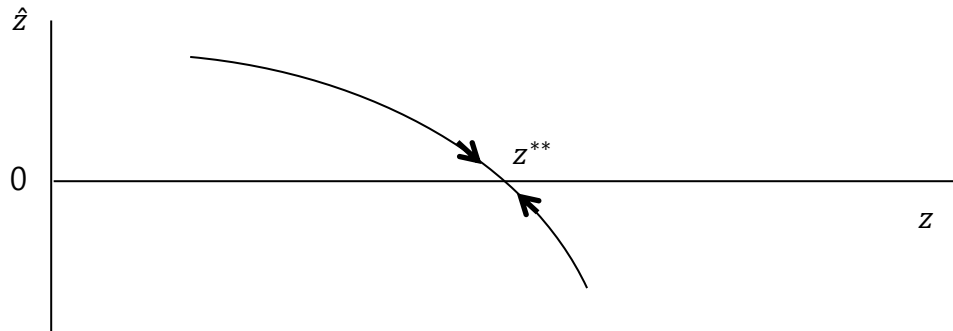

[Figure 6] The evolution of z

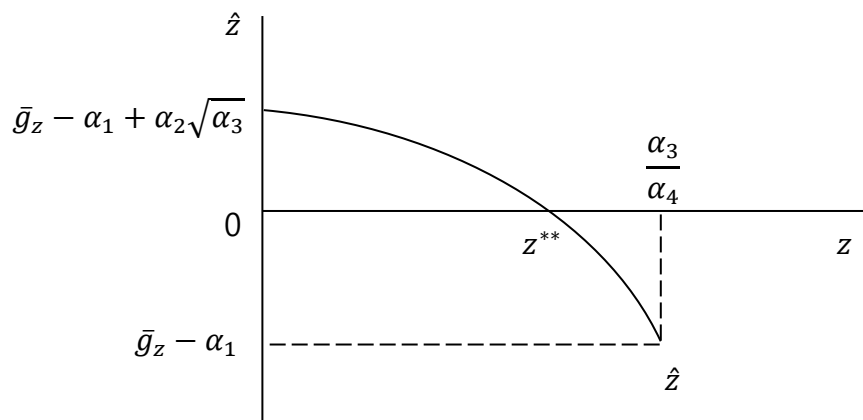

[Figure 6A] The graph of \hat{z}

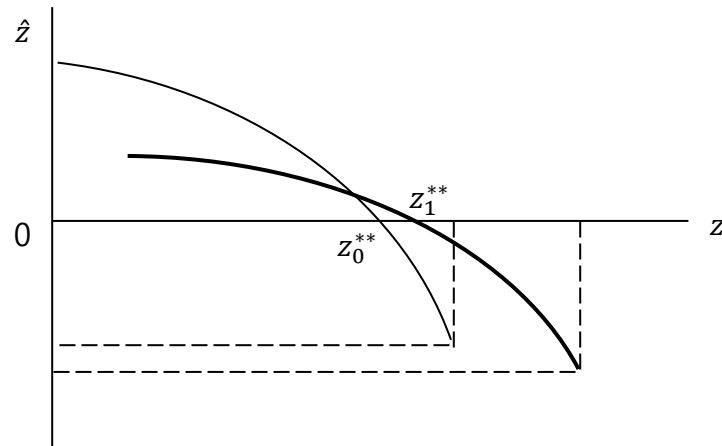

[Figure 6B] Changes in the graph of \hat{z} after an increase in s_p

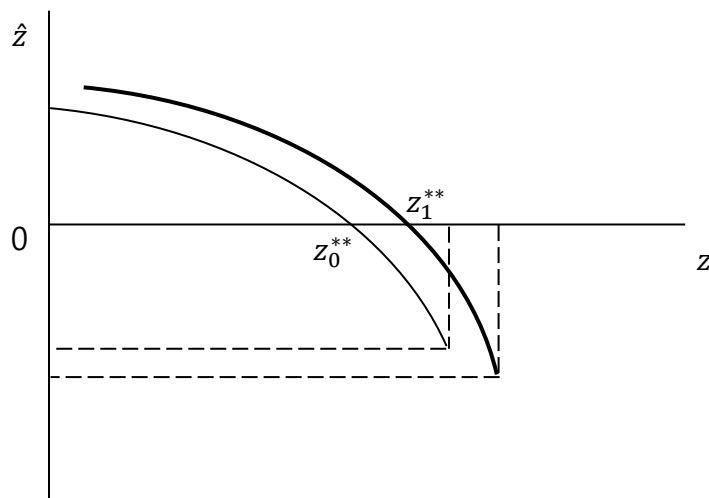

[Figure 6C] Changes in the graph of \hat{z} after an increase in either π_f or u_0

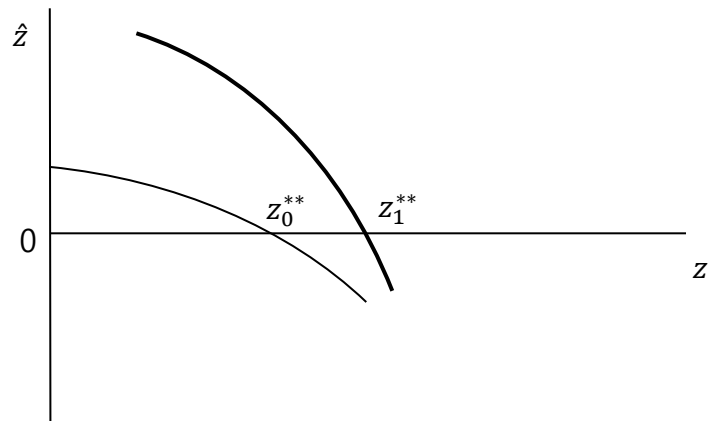

[Figure 6D] A sketch of changes in the graph of \hat{z} after an increase in Ψ

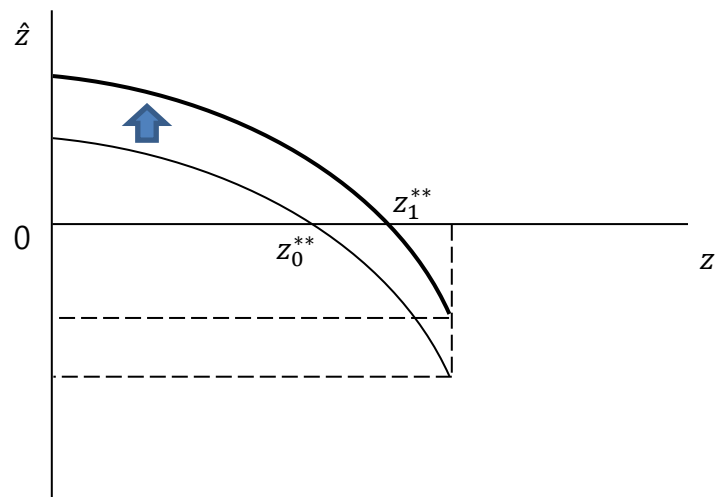

[Figure 6E] Changes in the graph of \hat{z} after an increase in \bar{g}_z

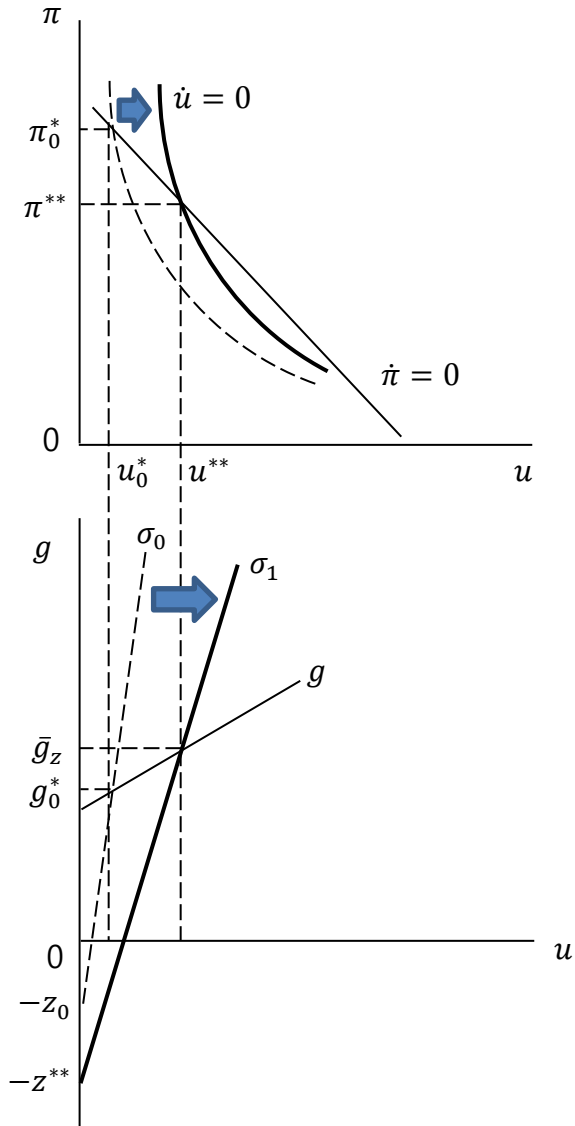

[Figure 7] An adjustment towards the medium-run equilibrium when $z_0 < z^{**}$, where $\sigma_0 = s_p \pi_0^* u - z_0$ and $\sigma_1 = s_p \pi^{**} u - z^{**}$.

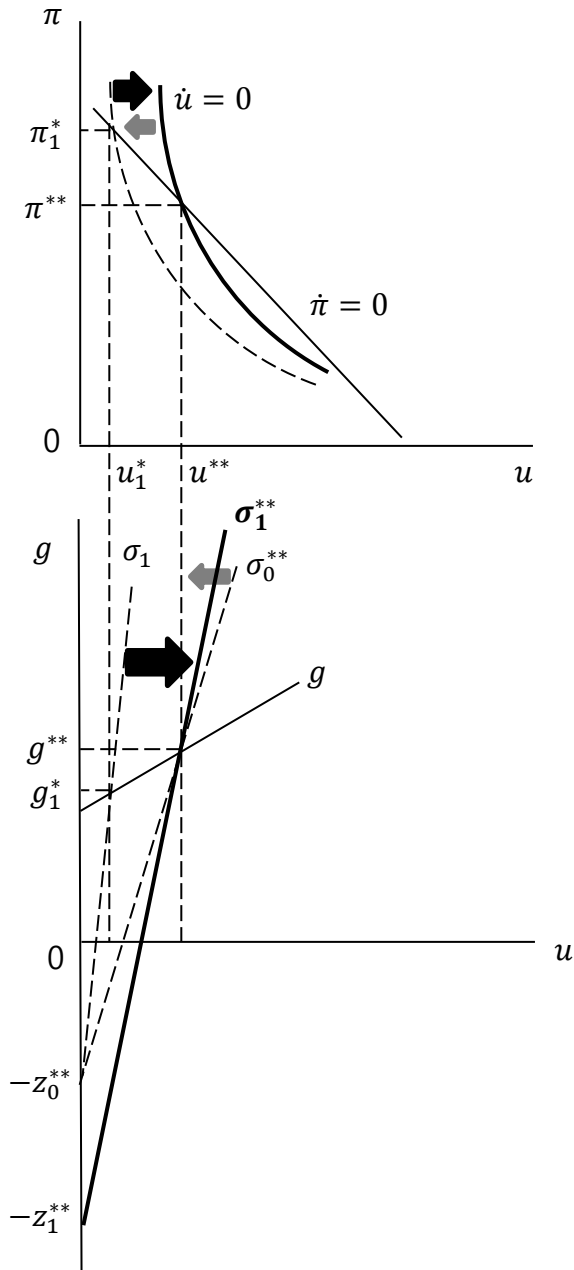

[Figure 8] The paradox of thrift in the medium-run or long-run, where $\sigma_i^{**} = s_p^i \pi^{**} u - z_i^{**}$ ($i = 0, 1$).

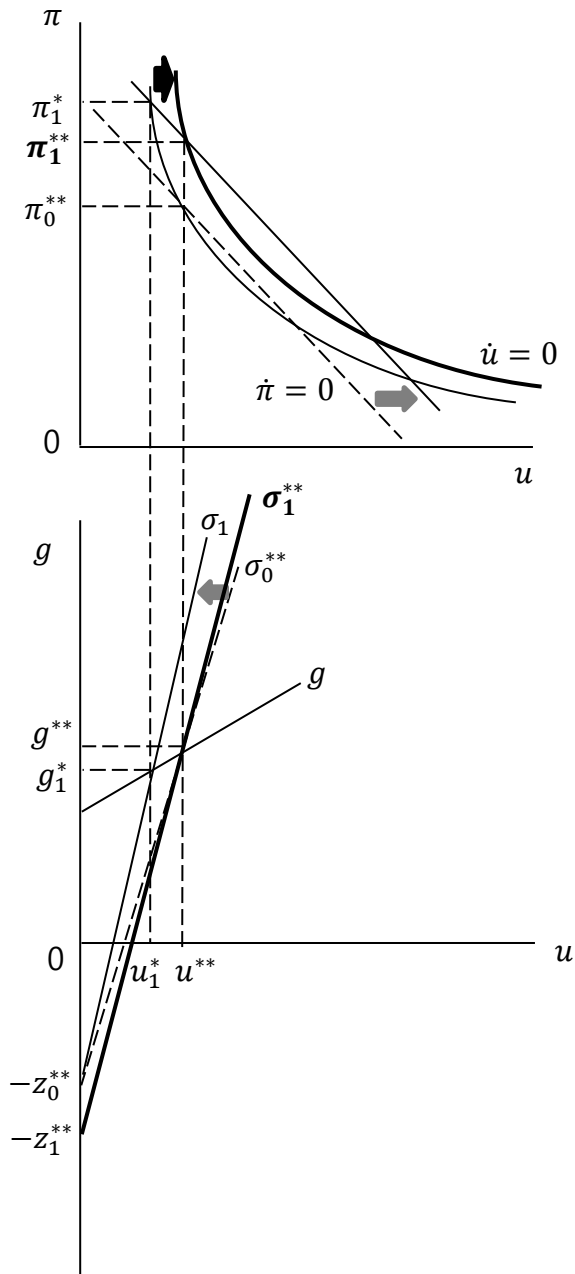

[Figure 9] The medium-run or long-run effects of either an upward adjustment in capitalists' claims for profits or the stronger bargaining position of capitalists, where $\sigma_i^{**} = s_p \pi_i^{**} u - z_i^{**}$ ($i = 0,1$).

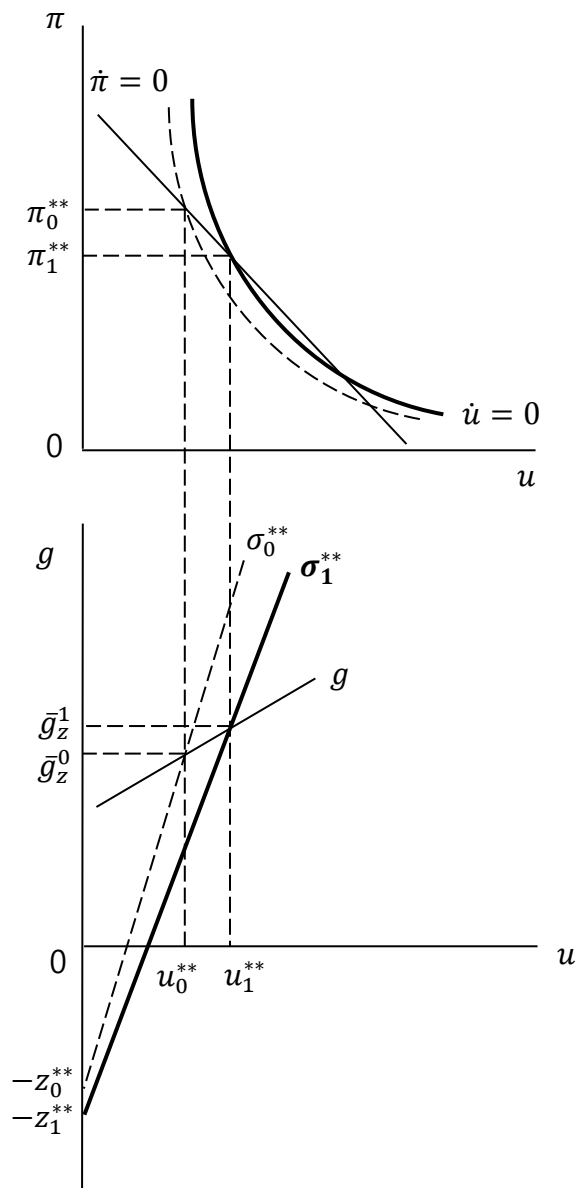

[Figure 10] The medium-run effects of an increase in \bar{g}_z , where $\sigma_i^{**} = s_p \pi_i^{**} u - z_i^{**}$ ($i = 0,1$)

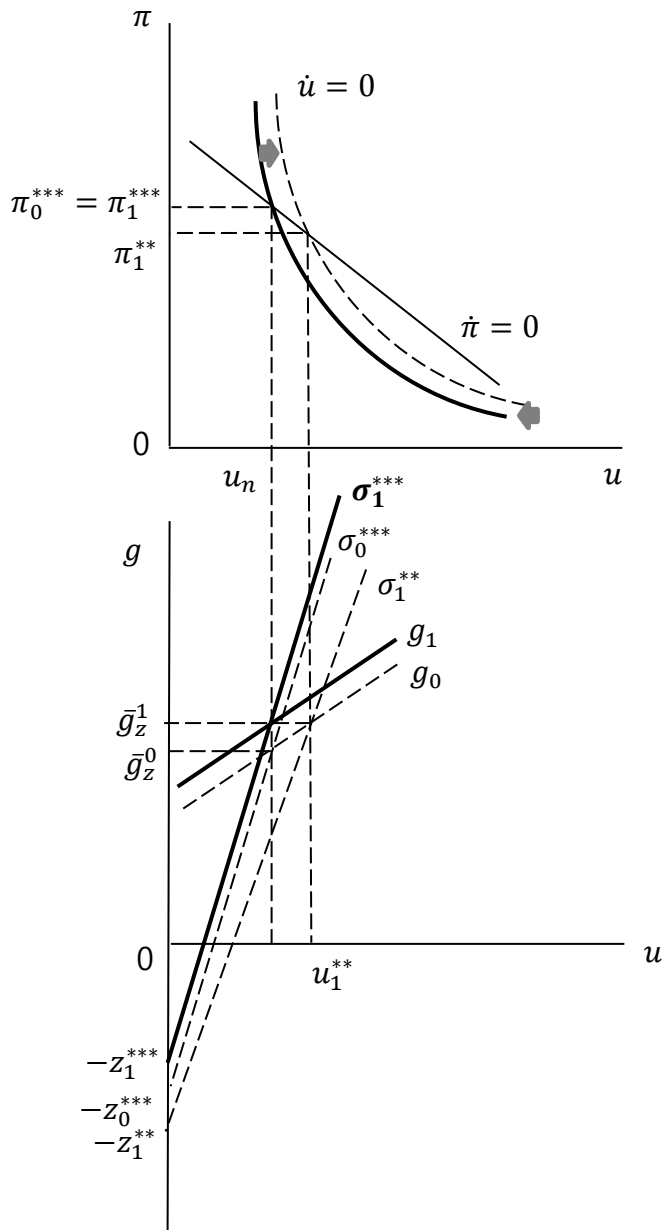

[Figure 11] The long-run effects of an increase in \bar{g}_z , where $\sigma_i^{***} = s_p \pi_i^{***} u - z_i^{***}$ ($i = 0,1$)

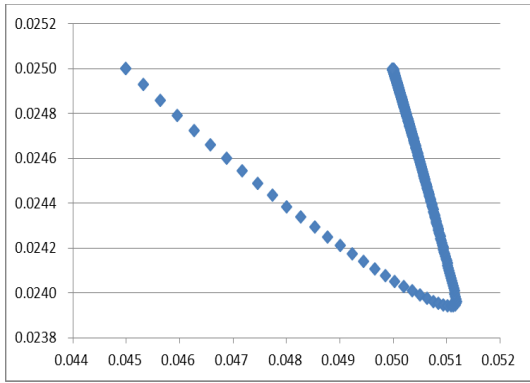

(a) γ (vertical) versus z (horizontal)

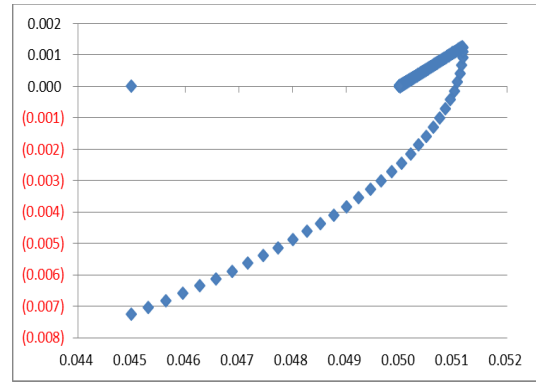

(b) \dot{e}/e (vertical) versus z (horizontal)

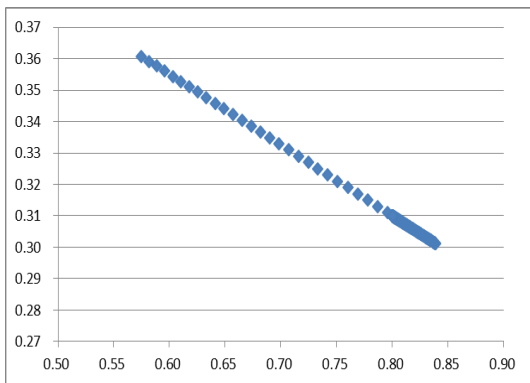

(c) π (vertical) versus q/qf (horizontal)

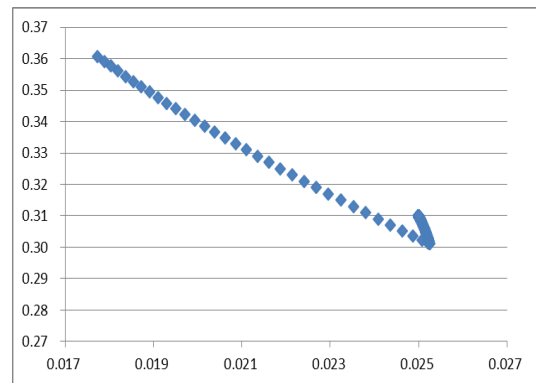

(d) π (vertical) versus g (horizontal)

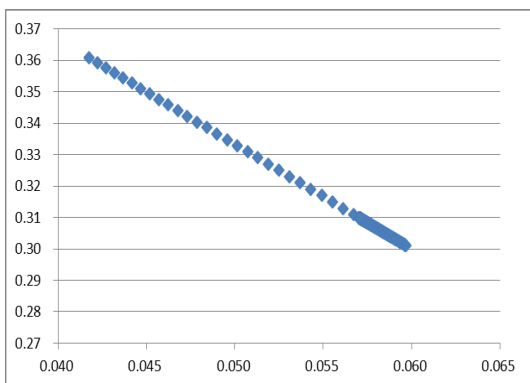

(e) π (vertical) versus \hat{p} (horizontal)

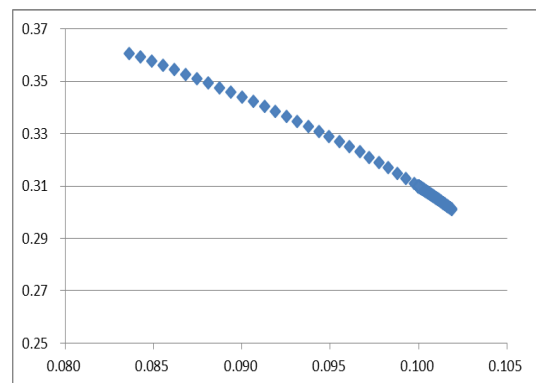

(f) π (vertical) versus r (horizontal)

[Figure 12] Long-run transitional dynamics after an increase in s_p

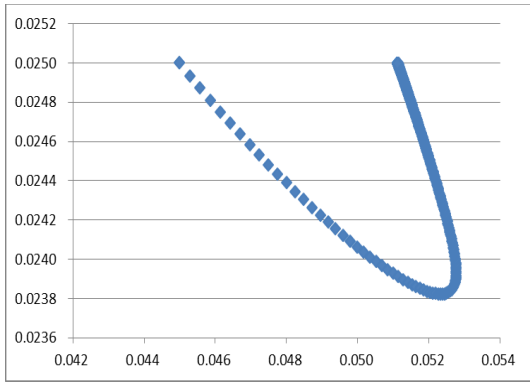

(a) γ (vertical) versus z (horizontal)

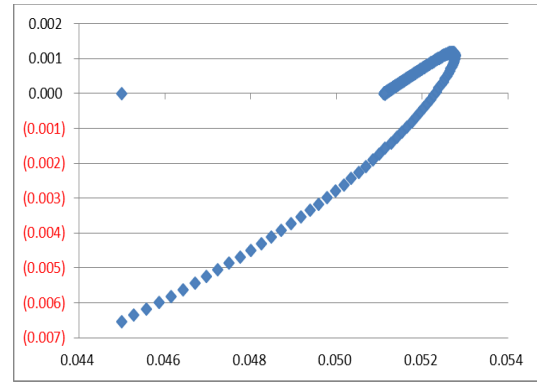

(b) \dot{e}/e (vertical) versus z (horizontal)

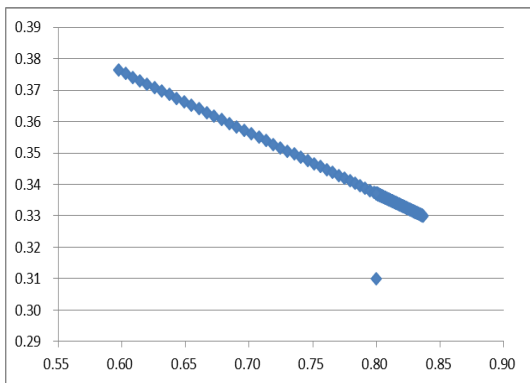

(c) π (vertical) versus q/qf (horizontal)

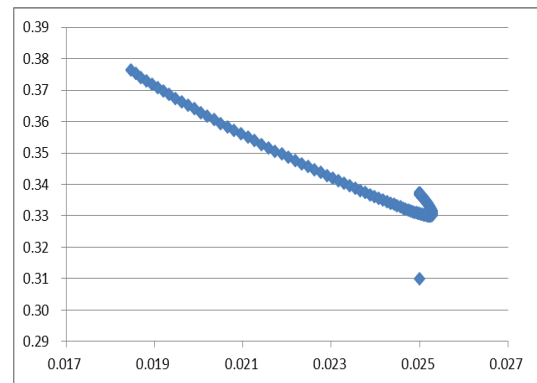

(d) π (vertical) versus g (horizontal)

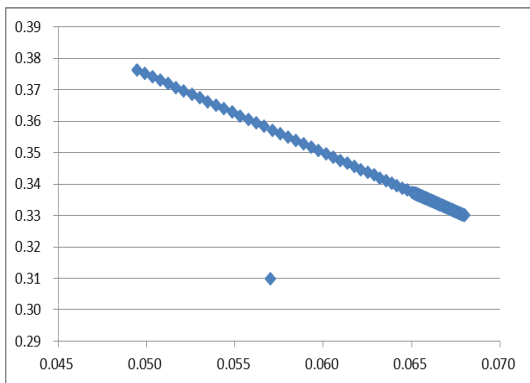

(e) π (vertical) versus \hat{p} (horizontal)

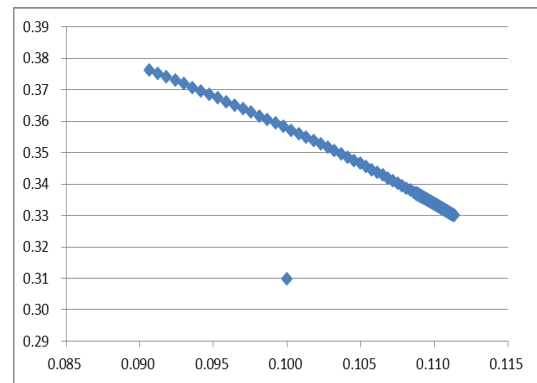

(f) π (vertical) versus r (horizontal)

[Figure 13] Long-run transitional dynamics after an increase in Ψ

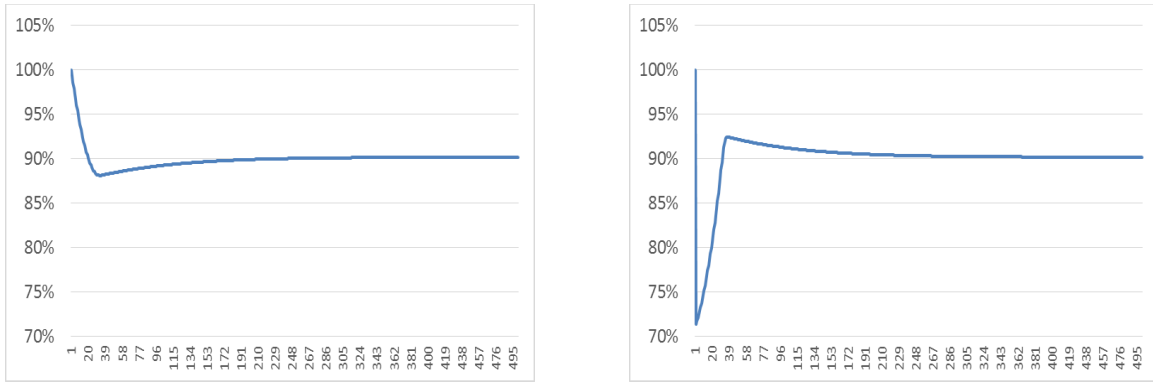

(a) Long-run effects of an increase in s_p on the level of capital (left) and output (right)

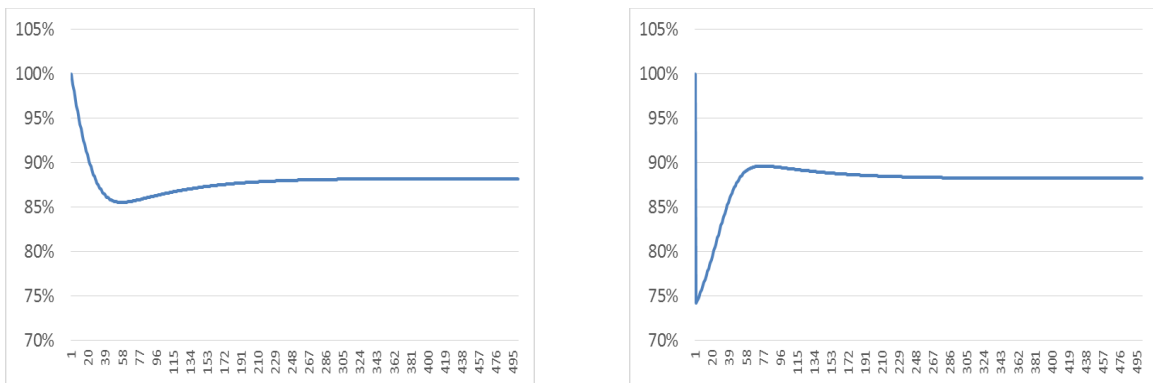

(b) Long-run effects of an increase in Ψ on the level of capital (left) and output (right)

[Figure 14] Comparison of the long-run level of capital and output

Impressum

Publisher: Hans-Böckler-Stiftung, Hans-Böckler-Straße 39, 40476 Düsseldorf, Germany

Contact: fmm@boeckler.de, www.fmm-macro.net

FMM Working Paper is an online publication series available at:

https://www.boeckler.de/imk_108537.htm

ISSN: 2512-8655

The views expressed in this paper do not necessarily reflect those of the IMK or the Hans-Böckler-Foundation.

All rights reserved. Reproduction for educational and non-commercial purposes is permitted provided that the source is acknowledged.