

van Wijnbergen, Sweder

Working Paper

On real interest rates, tariff policy, exchange rates and the ZLB

Tinbergen Institute Discussion Paper, No. TI 2018-032/VI

Provided in Cooperation with:

Tinbergen Institute, Amsterdam and Rotterdam

Suggested Citation: van Wijnbergen, Sweder (2018) : On real interest rates, tariff policy, exchange rates and the ZLB, Tinbergen Institute Discussion Paper, No. TI 2018-032/VI, Tinbergen Institute, Amsterdam and Rotterdam

This Version is available at:

<https://hdl.handle.net/10419/177722>

Standard-Nutzungsbedingungen:

Die Dokumente auf EconStor dürfen zu eigenen wissenschaftlichen Zwecken und zum Privatgebrauch gespeichert und kopiert werden.

Sie dürfen die Dokumente nicht für öffentliche oder kommerzielle Zwecke vervielfältigen, öffentlich ausstellen, öffentlich zugänglich machen, vertreiben oder anderweitig nutzen.

Sofern die Verfasser die Dokumente unter Open-Content-Lizenzen (insbesondere CC-Lizenzen) zur Verfügung gestellt haben sollten, gelten abweichend von diesen Nutzungsbedingungen die in der dort genannten Lizenz gewährten Nutzungsrechte.

Terms of use:

Documents in EconStor may be saved and copied for your personal and scholarly purposes.

You are not to copy documents for public or commercial purposes, to exhibit the documents publicly, to make them publicly available on the internet, or to distribute or otherwise use the documents in public.

If the documents have been made available under an Open Content Licence (especially Creative Commons Licences), you may exercise further usage rights as specified in the indicated licence.

TI 2018-032/VI
Tinbergen Institute Discussion Paper



On real interest rates, tariff policy, exchange rates and the ZLB

Sweder van Wijnbergen¹

¹ UvA, CEPR

Tinbergen Institute is the graduate school and research institute in economics of Erasmus University Rotterdam, the University of Amsterdam and VU University Amsterdam.

Contact: discussionpapers@tinbergen.nl

More TI discussion papers can be downloaded at <http://www.tinbergen.nl>

Tinbergen Institute has two locations:

Tinbergen Institute Amsterdam
Gustav Mahlerplein 117
1082 MS Amsterdam
The Netherlands
Tel.: +31(0)20 598 4580

Tinbergen Institute Rotterdam
Burg. Oudlaan 50
3062 PA Rotterdam
The Netherlands
Tel.: +31(0)10 408 8900

On real interest rates, tariff policy, exchange rates and the ZLB

by

Sweder van Wijnbergen

UvA, CEPR, TI and DNB

Abstract:

What could be the drivers of low real rates? What are the implications of the Zero Lower Bound for economic policy? To discuss these questions we introduce a full general equilibrium model of the world economy with a simple (2 period) intertemporal structure. The model is simple enough to allow for full analytical solution yet sufficiently complex to allow us to address the impact of anticipated future productivity slow down, aging, structural reform and fiscal policy on real interest rates if markets clear and on aggregate economic activity if they do not because of the ZLB. We extend both the equilibrium model and the ZLB variant to a more-goods-per-period set up with complete specialization to address (real) exchange rate policy and the macroeconomic impact of trade tariffs.

Key words: equilibrium real interest rates, aging, productivity change; the ZLB, real exchange rates, import tariffs

JEL codes: E62, F13, F40, F41, H30

1 Introduction

Recent research on real rates ([8, 7],....) aims to answer the question of whether "the" real rate has been declining and if so since when: long before the Great Financial Crisis? As part of some Financial Cycle ([2])? In response to a future aging of the population ([1])? Determining the main drivers of such a downward drift, if indeed one has occurred, is obviously relevant, if only to assess the likelihood of future real rates and the impact of the Unconventional Monetary Policies the various Central Banks have been following. A substantial literature is now emerging following up on this line of questioning. However this more recent empirical literature generally largely lacks a clear definition of what exactly "the" equilibrium real rate is, and what it equilibrates. Mostly there are some references to the concept of a natural rate introduced by Wicksell (cf [5]) but there is little or no discussion of what exactly that rate represents and by which factors it is influenced. This makes it difficult to answer the *what are the drivers* question, since a theoretical framework of what influences the equilibrium rate in which direction is not there. In a second strand of the literature, the starting point is not the data but some sort of a model, usually a complete risk sharing NK-DSGE model (for example [5]) which typically end up being too complex for analytical analysis at which point authors resort to computer simulations¹. This however severely limits getting a full analytical grasp of the structure of the models and, more importantly, makes it more difficult to explore empirical consequences amenable to econometric testing and to derive policy conclusions.

In this paper I propose a simple framework, rich enough to meaningfully discuss the concept of an equilibrium real interest rate and what it equilibrates, yet simple enough to be amenable to a full analytical derivation of results without having to resort to computer simulations or having to assume very specific functional forms. We start out by simply defining the real rate as a transform of the *real discount factor*, the relative price of future goods in terms of current goods. That leads naturally to a simple two period model, initially with only one good per period. This model already allows us to introduce ex ante and ex post real equilibria in the presence of unanticipated shocks. We do not introduce anticipated uncertainty in the model, so we cannot discuss such factors as shifts in risk preferences, flights to safe assets etcetera (see [3] for such an exercise in a framework not unsimilar to ours, but with uncertainty explicitly introduced). We leave this for future work since leaving out uncertainty allows us to drastically simplify our framework while still allowing us to address many of the questions raised in this real interest rate debate. Because the focus is on relative prices and welfare, we use duality methods with prices and welfare as prime variables instead of the more traditional primal approach where quantities are the prime variables and price and welfare effects need to be derived after the optimization problems in quantity space have been solved explicitly. Duality of course reaches the same solutions as primal approaches do, but using duality methodology allows us to start out from optimized solutions by the very

¹[3]is for to a substantial extent an exception, although they too need to use specific functional forms to reach clear conclusions.

definitions of expenditure and revenue functions.

Since real rates represent the terms at which intertemporal trade can take place, we use the minimal intertemporal structure necessary to meaningfully discuss intertemporal trade: a two period set up distinguishing "today" and "tomorrow". Even within this simple framework we can introduce the ZLB; also we can already analyse the link between for example declining productivity growth rates and real interest rates, the consequences of a greyer population on real rates and the impact of time varying taxrates, again on real rates and with and without the ZLB binding. Obviously using a two period model rules out analysis of the dynamics along transition paths, but it does turn out to be surprisingly powerful because it sets the key phenomena influenced by real rates, i.e. the various channels of intertemporal trade, at the center of the analysis.

We then extend the model to a two goods per period/two periods setting so as to discuss the impact of real exchange rate policy, tariffs and the ZLB; this is where we do derive novel results that highlight when exchange rates, which are in essence intra-temporal relative prices, nevertheless have intertemporal effects. Similarly, we show that setting tariff policy in an intertemporal framework does enrich the conclusions. We show that temporary tariff policy, like recently instigated by the US, will actually slow down world economic activity even if expenditure patterns are sufficiently symmetric to eliminate any intra-temporal impact of the redistribution from foreign to domestic players that tariff policy aims to achieve. The intertemporal framework we employ also gives a theoretically sound basis for discussions of the link between the current account/trade balance on the one hand and the (real) exchange rate on the other; of how real exchange rates influence intertemporal allocations of consumption and production (i.e, explain investment responses). This is useful since certainly in the world of practitioners exchange rates are routinely linked to trade balances; we show that that is in fact a more complex relation than is usually thought in policy discussions.

Of course simplifying this far yields strong results but also comes at a cost. For example we can only analyse unanticipated shocks in an otherwise perfect foresight world, and we cannot meaningfully discuss differences along the transition pathways towards a possibly disturbed long run steady state. Uncertainty could be introduced, see [3] for an attempt within an equally simple model, but still too complex to derive results without assuming specific functional forms, parameter values; and still the authors need to resort to simulation analysis for part of their analysis. Also the literature, whether numerical or analytical, largely stays within the expected utility framework, which I consider unattractive because the strong restriction that implies for the relation between risk aversion and intertemporal substitution: they are inversely related in the expected utility framework. But for a meaningful analysis one would want to separate the intertemporal elasticity of substitution and the CRRA parameter to analyse IT substitution and risk aversion independently. This is impossible within an expected utility framework, one option would be to switch to Eppstein-Zinn preferences where the two are separated in an approach that is otherwise closely related to expected utility maximization. We leave this for future work. Also,

the two period framework precludes analysis of transitional effects for which a richer intertemporal structure is necessary. This would most likely once again require the use of numerical solutions instead of analytical treatment, and that is in fact already widely done in the literature. For the same reason we do not introduce a monetary side of the economy and therefore abstract from monetary effects; I simply assume that short run price stickyness and nominal exchange rate targeting produce short run (i.e. first period only) real rate stickyness and limits on how low real rates can go.

2 The Modeling Framework

The real interest rate r is (a transformation of) the price of future goods in terms of current goods, call it δ . Consider for a start the simplest possible setup: one good per period, two periods. If r is the real interest rate, we get:

$$\delta = \frac{1}{1+r} \tag{1}$$

So what defines the equilibrium level of δ (and of r)?

2.1 *A simple two region intertemporal model with one good per period*

The real rate can be defined as the price that equilibrates total demand for current goods to total supply of current goods. Say's law then implies that demand and supply for future goods is in equilibrium too. Another way of stating the same equilibrium condition is that the world current account is zero at that equilibrium rate. Of course *ex post* the world current account is always zero, we do not trade with Mars; even when it is not *ex ante* equal to zero at a particular real rate but the real rate cannot adjust, for example because of price stickyness in combination with a ZLB, other variables will adjust to set the current account to zero *ex post*. So to make the definition more operational I want to extend it to the rate at which the *ex ante* world CA equals zero with all prices sufficiently flexible to clear all markets. Note that our concept of an *ex ante world current account surplus* is the mirror image of the *global excess demand for assets* that plays a central role in [3]. Since in equilibrium we are mostly interested in relative prices and welfare, the analysis is facilitated by using expenditure and revenue functions rather than the more conventional utility and production function framework, i.e. we work in duality space ([6]provides a very clear introduction to duality methods). Of course our solutions have exactly equivalent primal counterparts that can be derived using the more conventional framework concepts.

For further analysis we need a few concepts. Consider first the allocation of spending over the two periods (the savings decision). To explain the intertemporal pattern of expenditure I define an expenditure function for consumers in the home country, E , and in the foreign country, E^* :

$$E = E(1, \delta_c; U), E^* = E^*(1, \delta_c^*; U^*) \quad (2)$$

E (E^*) gives the minimum expenditure necessary to reach utility level U (U^*) at given intertemporal relative price δ_c (δ_c^*), where "*" refers to foreign variables and δ_c (δ_c^*) is the intertemporal relative price consumers face in the home and in the foreign country. In the absence of taxes (about which more later on in this note), we get:

$$\begin{aligned} \delta_c &= \delta \\ \delta_c^* &= \delta^* \end{aligned}$$

In an integrated world capital market we furthermore get:

$$\delta = \delta^*$$

By properties of the expenditure function, we then have:

$$E = E_1 + E_\delta \delta \quad (3)$$

and

$$E^* = E_1^* + \delta E_\delta^* \quad (4)$$

Before we can proceed to analyse market equilibria we need to develop a similar framework for the revenue/production side of the economy. Define output today as Y at home and Y^* abroad. For the corresponding second period variables we use lower case letters, so second period output equals y at home and y^* abroad. Y is a function of labor L and capital K , with similar definitions for the other output definitions. Full employment corresponds to $L=1$ and $L^*=1$, we do not endogenise labor supply. We do assume that future labor markets are always in equilibrium. Capital today is given, but tomorrow's capital stock depends on today's (we ignore depreciation) and on first period investment:

$$k = K + I, k^* = K^* + I^*$$

We start out by assuming that all factor markets clear; later on we will consider unemployment and possibly a binding ZLB. We can then define a revenue function R that describes the intertemporal pattern of output available for consumption, in a manner similar to the definition of the expenditure function:

$$R = R(1, \delta; K) \quad (5)$$

By properties of the revenue function the following holds for first and second period output:

$$R_1 = Y - I, \quad R_\delta = y \quad (6)$$

and

$$R = R_1 + R_\delta \delta \quad (7)$$

Analogous relations hold for the foreign revenue function R^* . Individual country budget constraints then come down to:

$$R = E, \quad R^* = E^* \quad (8)$$

Note that using equations (3), (4) and (5) allows us to rewrite the intertemporal budget constraint in terms of a country's current account:

$$\begin{aligned} R - E &= (R_1 - E_1) + \delta(R_\delta - E_\delta) \\ &= CA + \delta ca \\ &= 0 \end{aligned} \quad (9)$$

Simply differentiating the IT budget constraint gives the welfare impact of changes in the real discount factor:

$$\begin{aligned} E_U dU &= (R_\delta - E_\delta) d\delta \\ &= ca \cdot d\delta \\ &= -CA \frac{d\delta}{\delta} \end{aligned}$$

An analogous expression holds for the foreign welfare impact of a change in the discount factor.

World market equilibrium requires demand and supply for current goods to be in equilibrium:

$$R_1 + R_1^* = E_1 + E_1^* \quad (10)$$

or in terms of each country's current account:

$$CA(\delta) + CA^*(\delta) = 0 \quad (11)$$

The equilibrium discount factor δ /real interest rate r^*

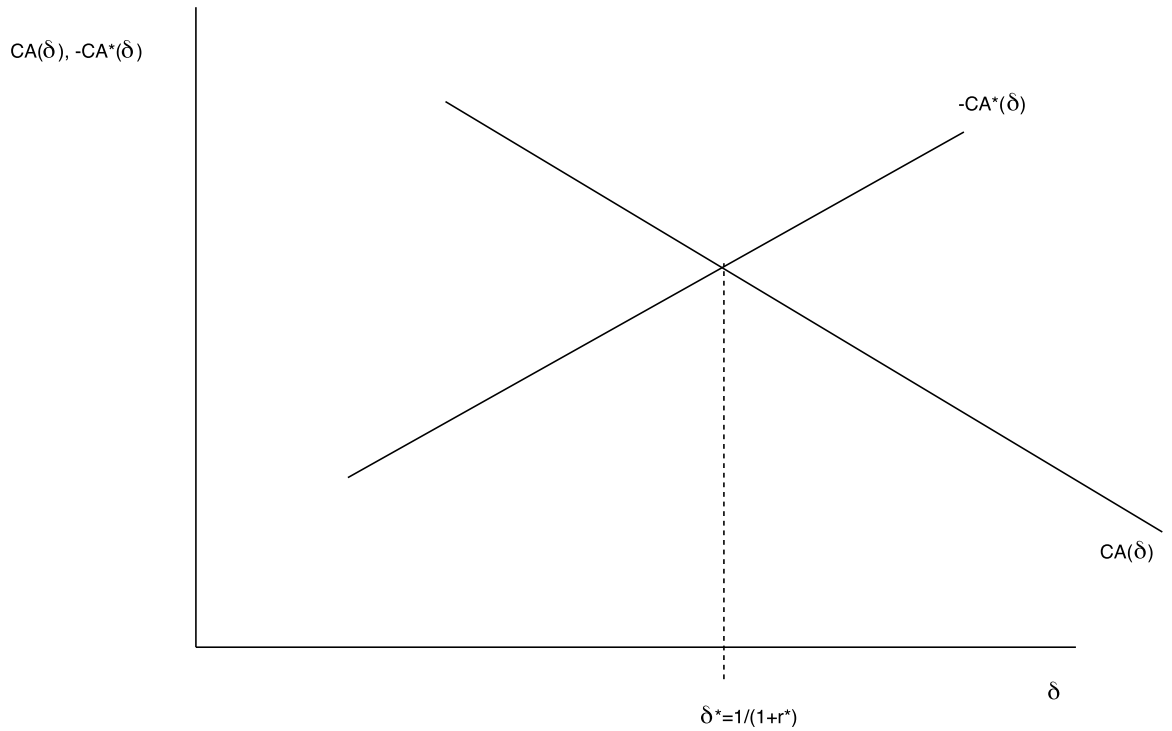

Figure 1: The Equilibrium (world) real discount factor/real interest rate

So we can define the world equilibrium real rate of interest as the rate at which the world current account equals zero but that is not specific enough for the definition to be useful. The reason is that the world current account always equals to zero, at any interest rate, simply because we do not trade with anybody outside this world. So we need to specify it in *ex ante* terms: **the equilibrium real rate of interest is the (real) rate of interest for which when all markets clear, the world current account equals zero.** Figure 1 gives a graphical representation of this equilibrium condition (cf 5.1 for the mathematics).

The diagram shows the home and (minus) the foreign country's CA surplus schedule; where they intersect the sum adds up to zero and the corresponding discount factor δ^* clears commodity markets: aggregate supply of current goods equals aggregate demand for current goods at this real discount factor (or equivalently at this real interest rate).

The slopes are as we should expect:

$$\begin{aligned}
\frac{\partial CA}{\partial \delta} &= R_{1,\delta} - E_{1,\delta} - E_{1U} \frac{\partial U}{\partial \delta} \\
&= R_{1,\delta} - E_{1,\delta} - c_1 ca \\
&= R_{1,\delta} - E_{1,\delta} + c_1 CA/\delta \\
&< 0
\end{aligned} \tag{12}$$

$E_{1,\delta} > 0$ because in a two good world different goods can only be substitutes so along an iso-utility curve (i.e. given U) a higher price of future goods lead to more demand for current goods. Also, $R_{1,\delta} = -I'(\delta) < 0$, higher prices of future goods leads to more investment and thus less goods available for consumption today. So the CA schedule will slope downwards unless income effects offset that relation. That will happen when the current account surplus today is very large: this implies a very large deficit tomorrow and then more expensive future goods (higher δ or a lower real interest rate) implies a welfare loss for the home country and accordingly lower first period spending and thus a higher surplus today. We will assume income effects do not dominate. The discussion of the slope of the foreign CA schedule follows a similar pattern. Note by the way that income effects cannot dominate in the same direction in both countries, we cannot have both countries run a CA surplus at the same time. In fact since one country's surplus is the other country's deficit, income effects are redistributive only and will not have any effect if global expenditure patterns are the same.

2.2 Productivity decline and the equilibrium real rate of interest

Consider now a future productivity (growth) slowdown in the home country². The slotted line in implies the consequences of a shift in the intertemporal balance between aggregate demand and supply, for example as a consequence of a decline in (future) productivity, i.e. the anticipation of slower productivity growth in the future. Lower future productivity implies lower second period output, which in turn lowers overall welfare and accordingly expenditure in each period, so at the old equilibrium real interest rate, a current account surplus emerges in the home country: the CA schedule shifts up. with an ex ante current account surplus at the old equilibrium real interest rate as a consequence. To restore equilibrium, the real interest rate falls (the discount factor rises), cf the arrow in Fig. 2.

That shift brings up the next issue, what if such shifts in the intertemporal patterns of output actually drive real rates into negative territory? If current prices are sticky, the ZLB on nominal rates implies a ZLB on real rates too. We turn to that situation in Section 2.5. Before moving to a discussion of the ZLB however, we first discuss the link between interest rates and structural reforms, a link frequently suggested by ECB president Mario Draghi.

²Note that in a discrete time set up there is no difference between an anticipated decline in future productivity and a (sufficiently large) decline in productivity growth.

The equilibrium discount factor δ /real interest rate r^*

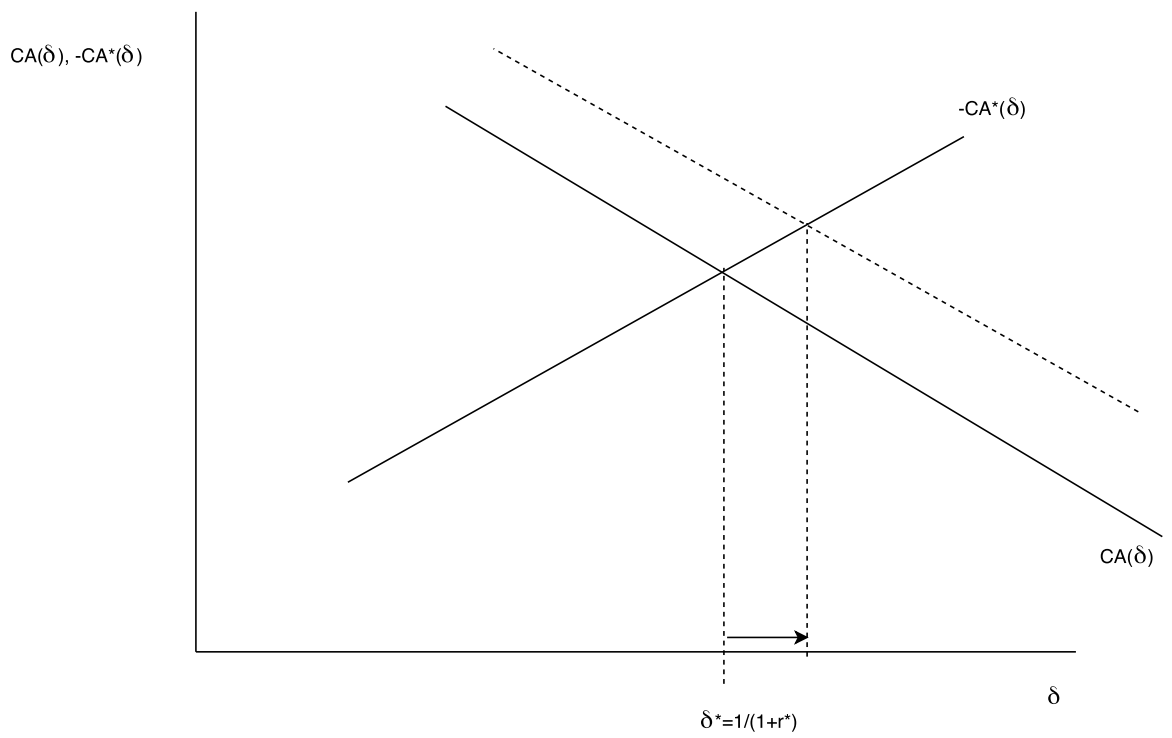

Figure 2: Productivity slowdown in the Home Country and world real interest rates

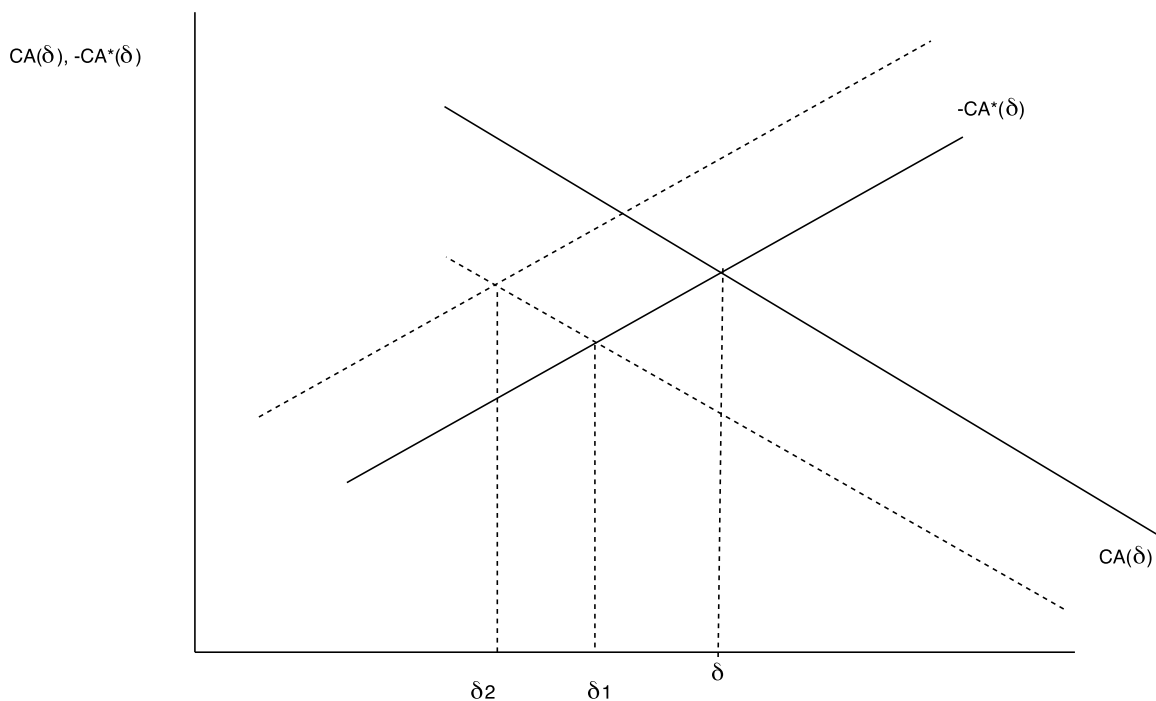

Figure 3: Structural Reform and the Real Rate

2.3 Structural Reform

ECB president Mario Draghi in a widely reported speech at the ECB's annual SINTRA conference in 2016 argued that structural reform is the way to get out of the ZLB trap if fiscal policy is not effective or if excessive levels of sovereign debt prevent the use of fiscal policy. The link is obvious from our argument on real rates and the slowdown of productivity growth because structural reform is designed to do the exact opposite. Figure 3 shows the mechanism.

Structural reform can be loosely defined as any set of measures likely to improve economic efficiency and possibly increase investment incentives (cf [4]). Reforms will generally take time, so a wide ranging program of structural reform should lead to anticipations of higher *future* rather than *current* output. 3 shows the impact on the equilibrium real rate of a structural reform effort leading to the expectation of higher anticipated future growth, the world Mario Draghi depicted in his SINTRA speech.

Consider first structural reform in the home country only, i.e. only home country future output is expected to increase. This is represented by a down-

ward shift in the home CA schedule: some of the future gains will be spent today of intertemporal consumption smoothing. Since output increases only tomorrow and a world CA deficit is impossible in any given period, the new equilibrium requires a lower price of future goods or equivalently a higher real interest rate so as to shift expenditure back to the future to a sufficient degree: the global equilibrium discount factor shifts from δ to δ_1 , cf Figure 3. If structural reform is enacted globally, i.e. also in the foreign country, we get further shifts: then the foreign current account schedule will also shift down (up in 3 since that figure lists -CA*) and the world real interest rate has to rise further to achieve equilibrium, so the discount factor shifts from δ_1 further down to δ_2 and world real interest rates will go up accordingly (cf Figure 3).

2.4 *Aging and the equilibrium real rate of interest*

The reason why an older society worldwide would have an impact on real rates is because it implies lower laborforce participation in the future for equal number of consumers compared to a society with a younger age pyramid. Of course an OLG model with unavoidably at least three periods is necessary to actually model the aging process, otherwise there is no partial overlap possible. But a shift in the period 2 participation rate can be modeled in our 2 period framework also and should have the same impact as aging in a more realistic OLG model.

So consider the following extension of the basic model: there are two groups of actors, still adding up to a measure 1. A fraction $(1 - \lambda)$ is as before producing and consuming today and tomorrow, and a fraction λ will consume both periods but only produces today. We will leave investment exogenous for this subsection (an extension to endogenous investment is straightforward but not informative). We will assume equal average productivity, so the intertemporal pattern of output is:

$$\begin{aligned} \text{Period 1 output :} & \quad Y & Y^* \\ \text{Period 2 output :} & \quad (1 - \lambda)y & (1 - \lambda^*)y^* \end{aligned}$$

The expenditure functions remain the same but the budget equations change. We assume the retiring fraction λ needs to cover its pension through their own savings; a Pay As You Go system cannot be modeled in a two period framework. Note that the expenditure functions are in per capita terms. This gives us:

$$(1 - \lambda)E^w = (1 - \lambda)(Y + \delta y) \tag{13}$$

$$\lambda E^r = \lambda Y \tag{14}$$

$$(1 - \lambda)E^w + \lambda E^r = Y + (1 - \lambda)y \tag{15}$$

And similarly for foreigners. The current account CA once again simply equals income minus expenditure in the corresponding period, with a similar definition holding for the foreign country's current account. World current output

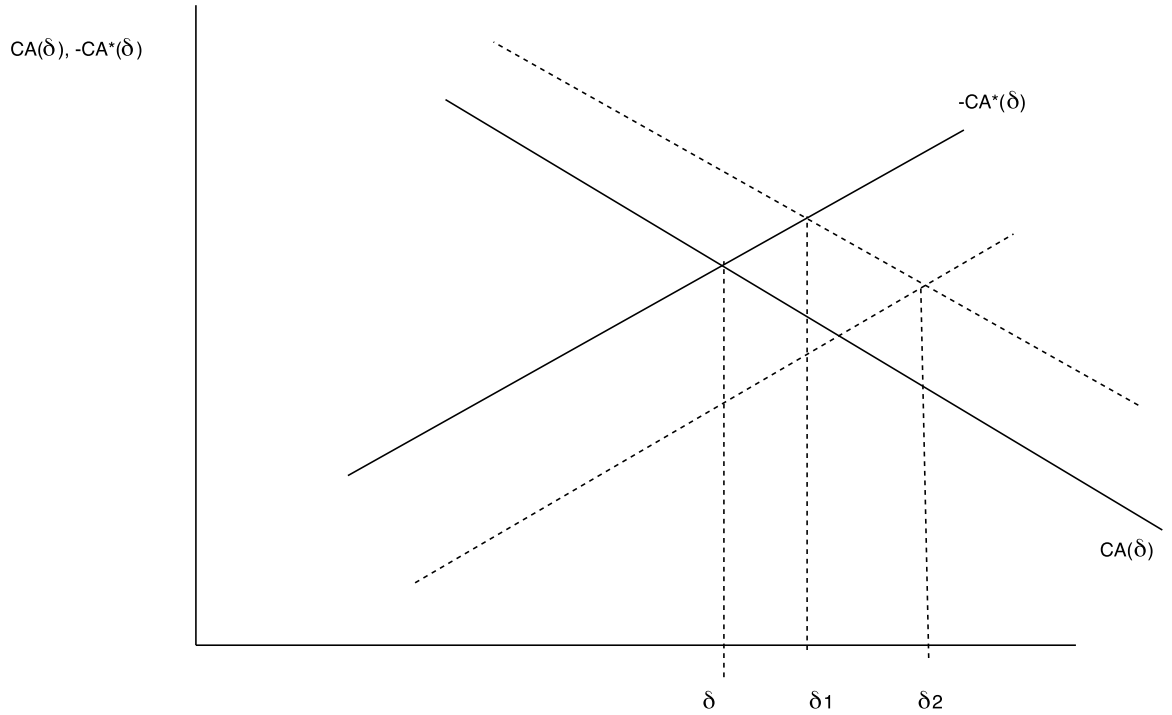

Figure 4: Aging and the real rate of interest/real discount factor δ ; δ_1 :only home country ages; δ_2 : both countries age

equals current expenditure is then equivalent to *the world current account* is zero condition:

$$\begin{aligned}
 CA &= Y - \{(1 - \lambda)E_1^w + \lambda E_1^r\} \\
 CA^* &= Y^* - \{(1 - \lambda^*)E_1^{w*} + \lambda^* E_1^{r*}\} \\
 CA + CA^* &= 0
 \end{aligned} \tag{16}$$

Clearly if the intertemporal relative price δ does not change both groups will maintain the same intertemporal allocation of expenditure, but the new allocation will if budget constraints are to remain satisfied lead to excess demand in period 2 and excess supply in period 1. As a consequence the relative price of future goods δ will go up (or the interest rate r^* will fall) to restore equilibrium. (for proofs of these statements see Section 5.1).

Figure 4 shows how this works. An increase in population aging, represented by an increase in λ , leads to an anticipated future decline in income for part of the population, which will partially be met by lower consumption today as

the fraction of people saving period 1 for their period 2 pension in goes up. Without adjustment in the real discount factor that would result in an ex ante WCA surplus, so interest rates will have to fall/discount factors will have to rise to restore equilibrium, see the move from δ to δ_1 in Figure 4. Let's say Europe, the US, Japan and China yes, but not in India and Africa where the process is taking place at a slower pace), we can represent that by setting $\lambda > 0$ and $\lambda^* = 0$, so only the CA schedule shifts and the world discount factor shifts to δ_1 in Figure 4.

If aging occurs in both countries, the $CA(\delta)$ schedule shifts upwards and the $-CA^*(\delta)$ schedule shifts down (that schedule represents *minus* the foreign country's current account). The new equilibrium is then at δ_2 , in other words, the price of future goods goes up more, or, equivalently, the real interest rate falls more than it falls when only one of the two countries faces a demographic transition towards an older population structure: see Figure 4: the real rate will fall also if only the home country ages, but less than it would if aging is a global shift in demographics.

2.5 *The Zero Lower Bound*

In the previous section we saw that various real factors may drive real interest rates lower. That brings us to the next question, what if equilibrium real rates turn negative? On a priori grounds, one would not expect equilibria at negative real rates (or, equivalently, values of δ above 1). There is strong empirical evidence in favor of preference of current consumption over future consumption all else being equal. This is typically modelled by postulating a time preference parameter $\beta < 1$ to discount next period consumption: i.e. current consumption is preferred over future consumption even when the marginal utility of consumption is the same in both periods. But if consumers prefer current goods over future goods all else equal, one should reasonably expect future goods to be cheaper in current value terms to offset that time preference, which implies $\delta < 1$ or, equivalently, positive real interest rates.

However a strong anticipated decline on the *supply side* of future goods, could reverse that expectation by creating scarcity at a future goods price of 1 or lower. For example the shock analyzed above, an anticipated decline in future productivity, could well shift us in a regime of low real rates. But what if we then run into the ZLB? We do not model the origin of such a restriction, but the combination of price stickyness and the impossibility of negative nominal interest rates can obviously create a real rate ZLB, or, equivalently, an upper bound on δ . But an upper bound on δ implies that the price of future goods cannot go up enough to restore future goods equilibrium, so excess demand will persist. And excess demand for future goods implies as its mirror image excess supply for current goods. If we define the pre-shock real discount factor as δ_1 , and the post-shock discount factor as δ_2 , the ZLB may become binding (i.e. $\delta_2 > 1$) if the future decline is large enough. But the ZLB binding means the price of future goods cannot rise enough to meet demand. Therefore a binding ZLB implies excess demand for future goods and, as its mirror image, an

excess supply of current goods: the economy lands in a regime characterized by Keynesian lack of effective demand at $\delta = 1$.

Consider our formal framework under the assumption that the ZLB binds, i.e. the the region where global market clearing requires a discountfactor above 1 (i.e. a negative interest rate). Clearly in that case the real rate cannot play its equilibrating role, demand for current goods falls short of supply:

$$R_1 + R_1^* > E_1 + E_1^* \quad (17)$$

How the excess supply is allocated (i.e.in which country resources go unutilized and by how much if in both) is has not been defined yet since we only have only looked at a full equilibrium solution sofar, where (global) supply and (global) demand for current goods are set equal through their relative price δ . Within our current one good/period model we assume the following setup. Assume producers are randomly matched on a platform with buyers. If there is an aggregate shortfall of demand, the probability p_m of being matched with a buyer is assumed to be proportional to the overall ratio of aggregate demand to aggregate supply:

$$p_m = \frac{E_1 + E_1^*}{R_1 + R_1^*}$$

Define aggregate demand induced activity $Z = E_1 + E_1^*$, and the relative size of country H as $\psi_H = \frac{R_1}{R_1 + R_1^*}$, and analogously for country F, We then get for actual output Y, Y^* (as opposed to capacity output R_1, R_1^*):

$$\begin{aligned} Y &= p_m R_1 \\ &= \psi_H Z \end{aligned}$$

and

$$\begin{aligned} Y^* &= p_m R_1^* \\ &= \psi_F Z \end{aligned}$$

The equilibrating variable in the ZLB situation is again the matching probability p_m , or, equivalently, the ratio of aggregate demand Z to aggregate supply. For expositional purposes, we can use a diagram analogous to Figure 5 to show the impact of structural changes on output in the ZLB region. In that ZLB region, $\delta = 1$, but p_m , really a measure of capacity, will fall below 1 or equivalently, overall economic activity will then fall to below capacity output:

$$Z < R_1 + R_1^*$$

Text

The equilibrium real interest rate r^* and the ZLB

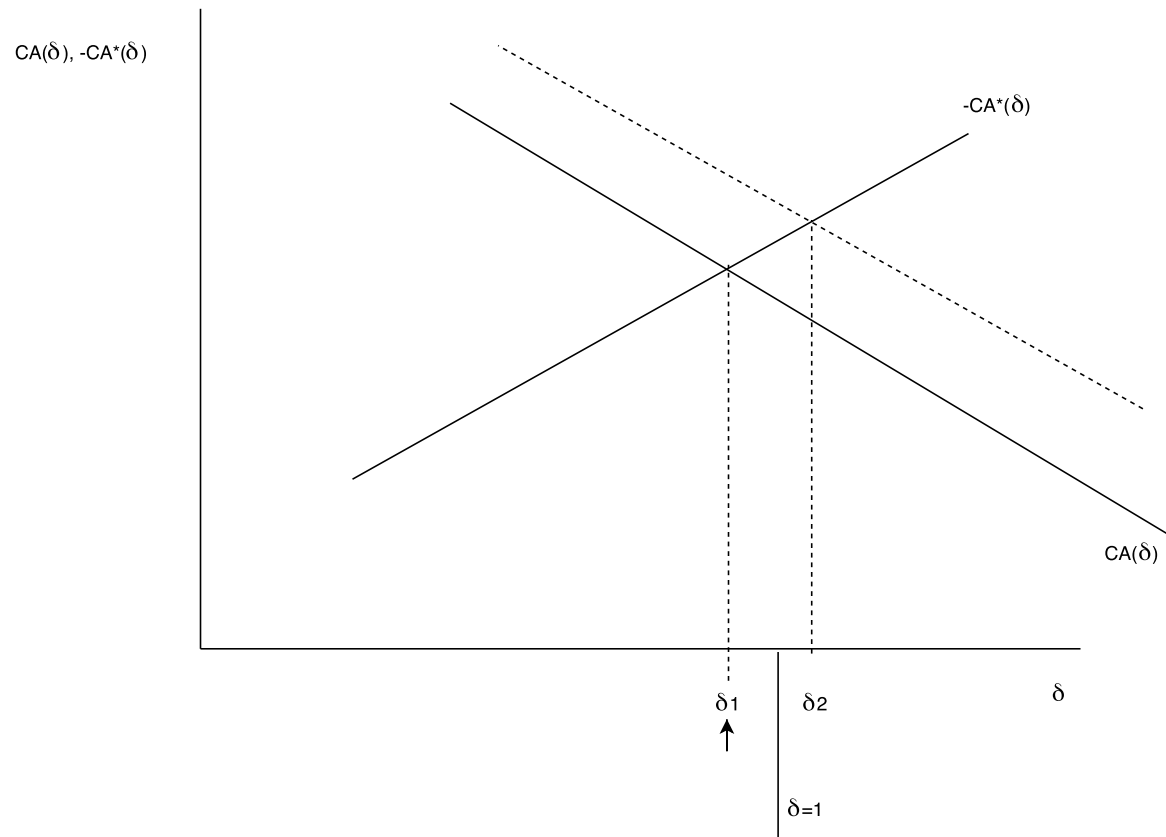

Figure 5: Shifts in intertemporal production patterns and the ZLB

Then the intertemporal budget constraint for the home country becomes:

$$\psi_H Z + R_\delta = E(1, \delta; U) \quad (18)$$

Simple differentiation of the home country's ITBC gives us the welfare effect of changes in aggregate economic activity, which we will need later on:

$$\frac{dU}{dZ} = \psi_H E_U^{-1} \quad (19)$$

Now is straightforward to derive the CA schedule as before, except that it is now a function of Z, cf Figure 6:

$$CA(Z) = \psi_H Z - E_1(1, \delta; U) \quad (20)$$

which yields the following expression for the slope:

$$\begin{aligned} CA_Z &= \psi_H - E_{1U} \frac{dU}{dZ} \\ &= \psi_H (1 - c_1) \\ &> 0 \end{aligned}$$

It is straightforward to derive analogous expressions for the foreign country to arrive at the global CA equilibrium condition in the Keynesian deficit demand/ZLB region:

$$CA(Z) + CA^*(Z) = 0 \quad (21)$$

The two schedules are shown in Figure 6. Assume an increase in capacity utilization p_M and a matching increase in demand driven aggregate output Z. Because some of the additional income will be spent next period, there is an incipient CA increase: CA slopes up in figure 6. Following similar reasoning, $-CA^*$ slopes down. The intersection point determines equilibrium first period output: if prices (i.e. δ) cannot clear the global goodsmarkets because the ZLB pins δ down at 1, quantities will have to adjust to restore equality between aggregate demand and supply. take over: we are in a Keynesian deficient demand region.

2.6 Intertemporal effects of Fiscal Policies

Consider next various fiscal and tax policies at the ZLB. A logical policy instrument to look at is consumption taxes, since we are dealing with a lack of effective demand in period 1.

Global equilibrium in the keynesian deficient demand/ZLB region

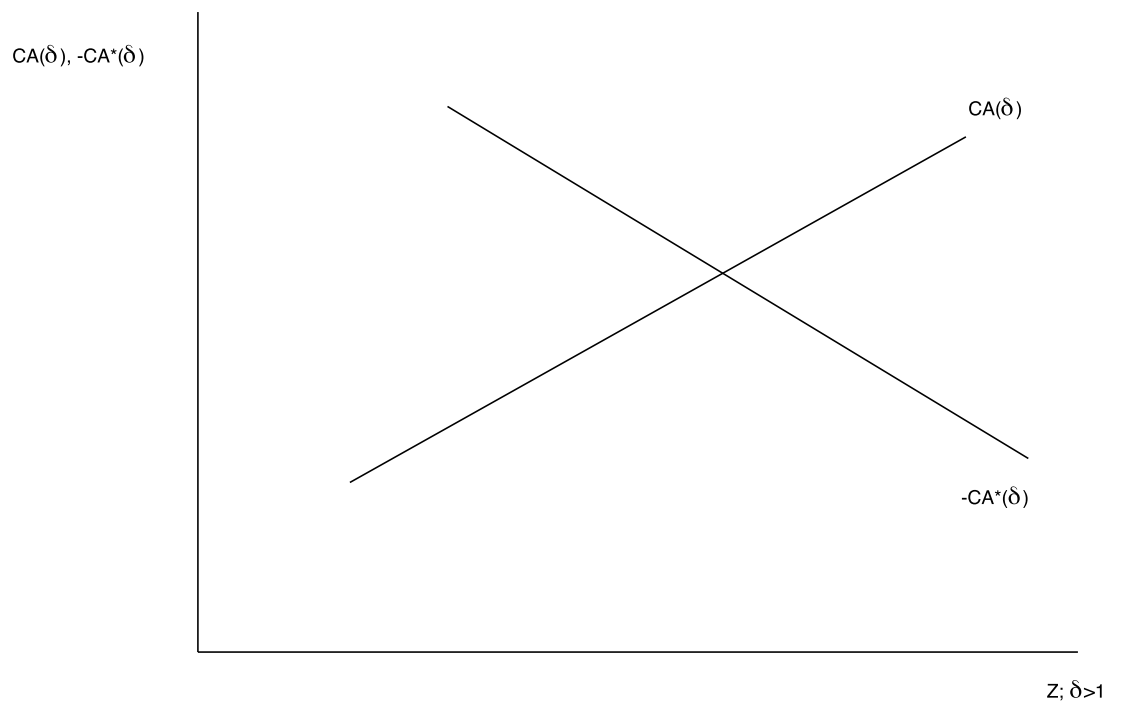

Figure 6: Output determination in the ZLB/Keynesian deficient demand region

2.6.1 Time varying consumption taxes

Consumer taxes are easily introduced into the model: they affect consumption prices in the period they are levied and thus influence the Consumer Discount Factor δ_C :

$$\delta_C = \frac{\delta(1+t)}{(1+T)} \quad (22)$$

$$\equiv \frac{1}{1+CRI} \quad (23)$$

CRI stands for Consumer Rate of Interest, a transform of the Consumption Discount Factor. We will eliminate income effects by assuming that the tax revenues are handed out again in lump sum fashion, i.e. we focus on substitution effects. The model now becomes:

$$\begin{aligned} \psi_H Z + R_\delta &= E(1, \delta_C; U) \\ CA_Z &= \psi_H - E_{1,U} \frac{dU}{dZ} \\ &= \psi_H(1 - c_1) \\ CA(Z; \delta_C) + CA^*(Z) &= 0 \end{aligned}$$

It should immediately be clear from equ 22 that a permanent increase in taxes $dT = dt > 0$ has no impact on intertemporal relative prices; and since we assumed the income effects to be offset by handing back the tax revenues in lumpsum fashion, a permanent increase in consumer taxes with their income effects offset has no impact on the allocation of consumption and productive resources over time nor on the degree of demand deficiency. But like in the case of real exchange rate devaluation we cover in the next section, the situation is different when the tax changes are temporary. A temporary cut in consumer taxes ($dT < 0$, $dt=0$) will in fact lower the consumer discount factor (i.e. raise the consumer rate of interest) and thereby shift consumer expenditure from tomorrow towards today, cf 24. Similarly, an increase in consumption taxes tomorrow to finance the taxcut today would influence intertemporal relative prices in a similar way but in a stronger fashion (cf equ. 25). Combining the two policy moves would thus result in a current cut but subsequent gradual increase in consumer taxes, if necessary with any remaining net income effects offset by an increase in lump sum taxes:

$$\frac{\partial \delta_C}{\partial T} = -\frac{\delta_C}{1+T} < 0 \quad (24)$$

$$\frac{\partial \delta_C}{\partial t} = \frac{\delta_C}{1+t} > 0 \quad (25)$$

This package could if substantial enough get the economy out of the ZLB region by shifting demand from the future to today.

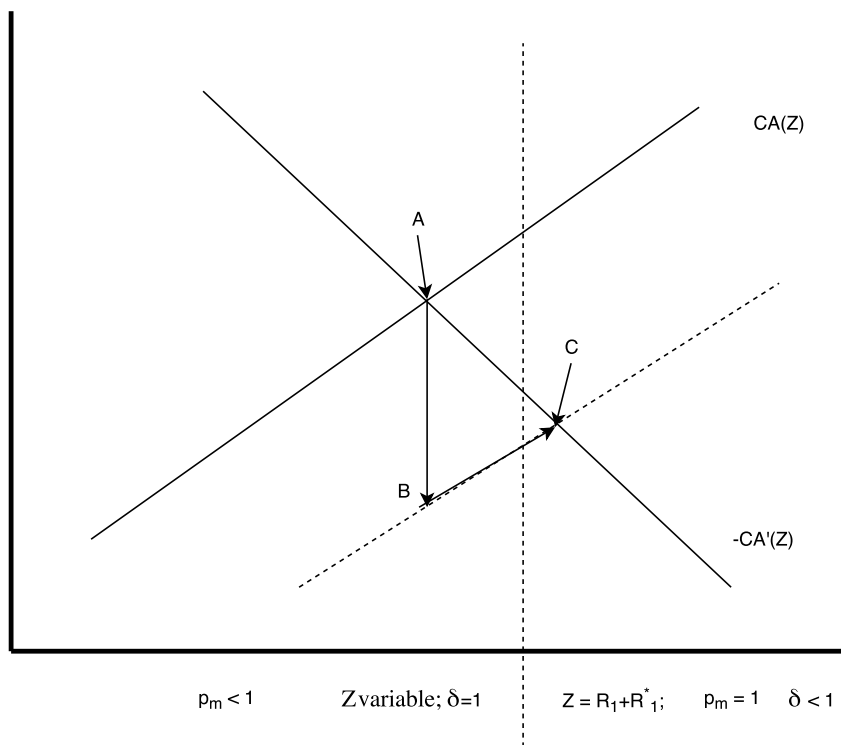

Figure 7: Temporary tax Cuts can Move the Economy away from the ZLB

To see this also diagrammatically, note from equ 24 and equ 25 that cutting consumption taxes today and raising them tomorrow raises the consumption discount factor (lowers the real consumption rate of interest). This unambiguously shifts the home country's current account schedule downwards. Away from the ZLB this would lead to a higher real interest rate to restore the ex ante world current account to its equilibrium value of zero, and in the ZLB region such a policy package would get us out of the ZLB region or at least closer to the boundary separating the complete flexibility region from the ZLB region.

Figure 7 demonstrates how this works when the economy is in the ZLB region, say at A in the diagram. To the left of the vertical slotted line, the ZLB is in fact binding and capacity utilization p_m and the level of aggregate activity Z vary to restore equilibrium. To the right of the slotted line, Z is fixed at its maximum value $R_1 + R_1^*$ and p_m is stuck at 1, there is full capacity utilization. In the region where p_m would have to exceed 1 to restore equilibrium we are away from the ZLB and real interest rates can vary again to restore world equilibrium³.

A temporary tax cut today offset by an equal NPV tax cut tomorrow would

³Note that the diagram is set up only to demonstrate the potential crossing of the boundary of the ZLB region; to the right of the $\delta = 1$ line the schedules of CA and CA^* as a function of respectively Z and Z^* do not describe the workings of the economy anymore.

shift the CA schedule down for given level of aggregate activity Z and so would move the economy to B. But that is not a feasible equilibrium since at B the ex ante world Current Account is in deficit and this is of course impossible *ex post*. As a consequence a higher level of economic activity comes about after the tax-change-induced shift of future home expenditure towards today and the economy will end up at its new equilibrium at C if Z could exceed its maximum value of $R_1 + R_1^*$. But C is in the region where Z is stuck at that maximum value $R_1 + R_1^*$ and so we are back into the region where real rates will go up (the real discount factor falls below 1) to restore equilibrium: the strategy of cutting taxes today and raising them tomorrow has moved us away from the ZLB.

2.7 *Fiscal policy at the ZLB: higher public expenditure on home goods $dG > 0$*

Consider now tax changes designed to finance additional expenditure in response to the Keynesian lack of demand recession: $dG > 0$. We need to slightly adjust the model to accommodate this. Define first total tax revenue TR:

$$TR = E_1 T + E_\delta \delta t$$

The government needs to satisfy its intertemporal budget constraint GIBC, which simply comes down to:

$$G + \delta g = TR \tag{26}$$

Since we only consider current expenditure G , the GIBC comes down to $G=TR$.

Consider next how the increase in G interacts with the matching model introduced before. We plausibly assume that the government directs its purchases towards domestic producers, and selects producers that came back empty handed from the matching platform. This implies that if we interpret Z as activity generated by private expenditure and $Z' = G + Z$ as aggregate activity, the private sector ITBC becomes:

$$\psi_H$$

$$G + \psi_H Z + R_\delta - TR = E(1, \delta; U)$$

Since we only consider current expenditure, $dG = dTR$ and we get immediately:

$$\frac{dU}{dG} = 0$$

so there are no induced income effects directly triggered by dG : in the language of old style Keynesian economics, there are no second round multiplier

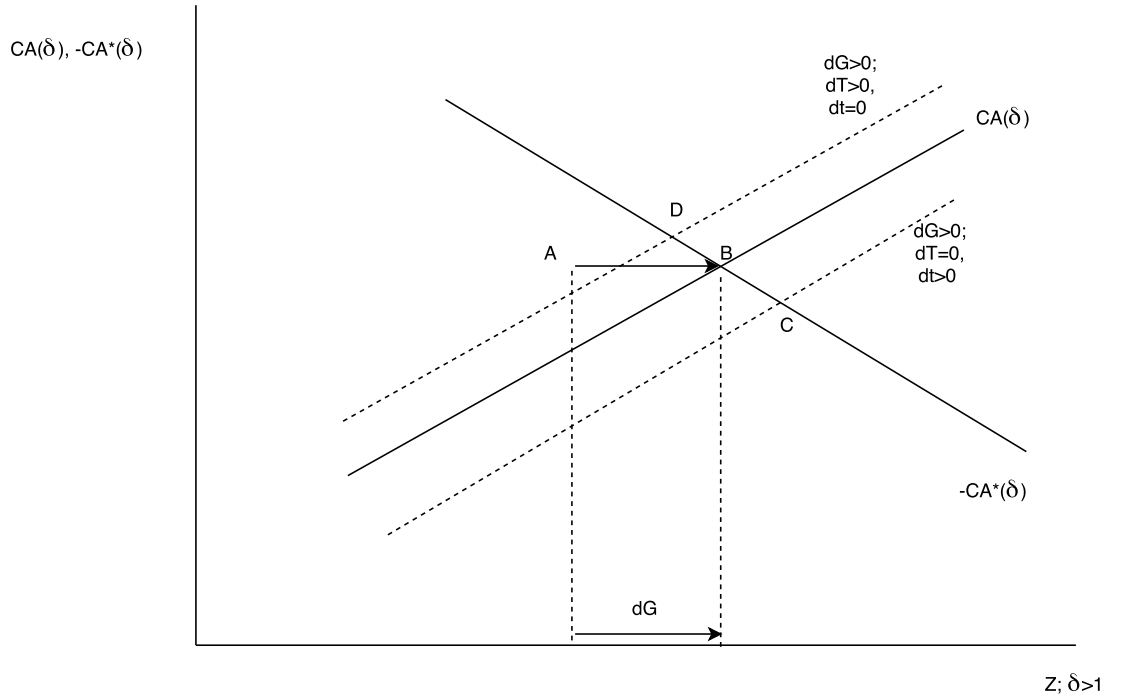

Figure 8: Expansionary fiscal policy and the time pattern of taxation at the ZLB

effects. But there are potentially secondary effects derived from the impact of the mode of financing on the Consumption Discount Factor. In the appendix we show that the multiplier taking the GIBC into account equals:

$$\mu_G = 1 + \Gamma \frac{d\delta_C}{dG} \Big|_{GIBC} \quad (27)$$

with $\Gamma > 0$ if income effects do not dominate substitution effects after a change in the CDF (cf equ. 56 in section 5.1 in the Annex). So whether the multiplier is smaller or larger than 1 depends on the time pattern of tax changes necessitated by the increase in government expenditure. Figure 8 explains.

Financing the additional first period increase in Government expenditure can happen in three ways:

1. dG is financed by a flat consumption tax over time: $dT=dt=dt'$ such that $dG = E_1 dt' + E_\delta \delta dt'$. In that case $\frac{d\delta_C}{dG}|_{GIBC} = 0$ so there is no secondary keynesian multiplier effect, income is reduced as much as it is increased by dG , and that is all: $\mu_G = 1$. The equilibrium moves from A to B in Figure 8.
2. However if taxes are set to cover expenditure in the same period ($dG = dT$ and $\delta = 1$), we get from equ. 24 that $\frac{d\delta_C}{dG}|_{GIBC} < 0$ and the multiplier actually falls below 1. Raising current taxes makes current consumption more expensive than future consumption, as a consequence private expenditure is shifted towards the future and the multiplier actually falls below 1: $\mu_G < 1$. The equilibrium moves from A to D in Figure 8.
3. Only if the expenditure is covered by future taxes only ($dG = \delta dt$), there is indeed a multiplier larger than one but for different reasons than in conventional models: the delay in financing raises the tax-inclusive price of future goods over current goods, i.e. actually increases the CDF: $\frac{d\delta_C}{dG}|_{GIBC} > 0$ which leads to a shift in private expenditure towards today. This add-on effect is in addition to the increased government expenditure so in this case the multiplier will indeed exceed one, not because the additional expenditure relaxes borrowing constraints but because the way it is financed changes intertemporal relative prices: $\mu_G > 1$. The equilibrium moves from A to C in Figure 8.

3 Real exchange rates and the real rate of interest

3.1 Extending the model to more goods per period: intra-period exchange rates in the intertemporal world

To address the issue of allocating the burden of the recession through exchange rate movements (arguably the main effect of the ECB's LSAP policies...) we need to extend our framework to a multicommodity (per period) world. The simplest setup introduces two goods per period, but complete specialization so as not to have to deal with issues of resource reallocation within one economy. This is the Mundell-Fleming framework also used in [3]: there is complete specialization, the home country produces current and future home goods Y, y ; and the foreign country produces current and future foreign goods Y^*, y^* . Their respective intertemporal patterns of output are governed by the revenue functions R and R^* . On the expenditure side home and foreign goods are imperfect substitutes both today and tomorrow. For simplicity and without much loss of generality we assume that investment at home uses the home good only and investment abroad only uses the foreign good..

The main changes in the global model come at the expenditure side: consumers now need to choose not just how to allocate over time but also how to

allocate expenditure per period over the two goods. Under two simplifying assumptions (weak time separability and homotheticity) that can be represented by the following expenditure function:

$$E = E(\Pi(P, 1), \delta\pi(p, 1), U), \quad (28)$$

Π and π are unit expenditure functions that can be interpreted as price indices of first and second period consumption. Homotheticity implies that the unit expenditure/price functions Π, π do not depend on the level of that period's expenditure. A similar function can be defined for the foreign country's consumers. Introducing more goods also implies more market equilibrium relations; four goods requires three equilibrium conditions (Say's law takes care of the fourth). The budget constraints remain the same:

$$R(P, \delta p; X) - T = E(\Pi(P, 1), \delta\pi(p, 1), U) \quad (29)$$

$$R^*(1, \delta; K^*) = E^*(\Pi(P, 1), \delta\pi(p, 1), U^*) \quad (30)$$

The current foreign good is the numeraire. Market equilibrium then can be summarized in three equilibrium conditions:

$$R_P = E_P + E_P^* \quad (31)$$

$$R_{\delta p} = E_p + E_p^* \quad (32)$$

$$WCA \equiv CA(\dots) + CA^*(\dots) = 0 \quad (33)$$

Note that total output in period 1 now is defined as $Z = PY + Y^*$. The first two equations describe home goods equilibrium in each period, with as associated relative prices the intra-period real exchange rates P and p ; P and p represent the relative price of home goods in terms of foreign goods in their respective period. And the third equation is once again our world current account equals zero condition tying down the world discount factor δ . In this 2-commodity/period set up, δ corresponds to the current price of future foreign goods expressed in terms of current foreign goods. The world current account is zero condition is equivalent to an equilibrium condition for current foreign goods, which can be seen by subtracting (19) and using the definitions of expenditure and revenue functions. Equilibrium in the market for future foreign goods then follows from Say's law and does not need an explicit equilibrium condition.

We can now introduce the various concepts of the real interest rate that are relevant in a multi-commodity world. First of all, we have the current price of future foreign goods, expressed in the numeraire, today's foreign good: $\delta = \frac{1}{1+r^*}$. So r^* is what we may call the foreign goods real rate of interest. However that is not the relevant rate for consumers in either country, nor for producers in the home country. We can define a similar intertemporal relative price in terms of home goods:

$$\delta_H = \frac{\delta p}{P} \quad (34)$$

$$\frac{1}{1+r} = \frac{1}{(1+r^*)} \frac{p}{P} \quad (35)$$

(24) gives the relation between the foreign goods discount factor (real interest rate) and the home goods discount factor (home goods real interest rate). (25) gives the same relation but expressed in terms of real interest rates, where r now is the home goods real rate and r^* the foreign goods real interest rate. Note that since R is homogenous of degree one, R_P is homogenous of degree zero; It follows that the supply of home goods today (or for that matter tomorrow) only depends on the home discount factor δ_H , which is not affected by *permanent* changes in the real exchange rate.

For consumers an amalgam of these two rates (the home goods intertemporal discount factor and the foreign goods intertemporal discount factor) is relevant, depending on their spending patterns. Once again we define the real consumption rate of interest as a transformation of the real consumption discount factor, now in a multi-goods per period setting:

$$\begin{aligned} \delta_C &= \frac{\delta\pi(p,1)}{\Pi(P,1)} \\ &= \frac{1}{1+CRI} \end{aligned} \quad (36)$$

Since the first derivatives of the expenditure function are homogenous of degree zero, aggregate current expenditure can be written as a function of the CRI defined in equ. 36; or, equivalently, in terms of its transform, the real consumption discount factor δ_C :

$$\begin{aligned} E_\Pi &= E_\Pi(\Pi(P,1), \delta\pi(p,1); U) \\ &= E_\Pi\left(1, \frac{\delta\pi(p,1)}{\Pi(P,1)}; U\right) \\ &= E_\Pi(1, \delta_C; U) \end{aligned} \quad (37)$$

Of course (real) exchange rates are equilibrium variables in this model variant with all prices flexible and no ZLB introduced yet. But inspection of the model equations already allows for some suggestive observations. First of all, it should be obvious that *permanent* changes in the real exchange rate do not change *intertemporal* relative prices and will therefore not have any substitution effects on the current account. Wealth effects due to terms of trade (ToT) gains may change that, but only when they too vary over time or in the presence of spending pattern asymmetries at home and abroad. The latter point stems

form the fact that one country's ToT gains are the other country's ToT losses, so expenditure patterns will change only in aggregate if there are spending pattern asymmetries across countries, for example home good biases or different patterns of intertemporal expenditure.

The full equilibrium flexprice global model has the following ITBC for the Home Country (with obvious analogon for the foreign country):

$$R(P, \delta p) = E(\Pi(P, 1), \pi(p, 1); U)$$

Straight differentiation gives the familiar welfare gain due to an appreciation of the real exchange rate:

$$\frac{dU}{dP} = E_U^{-1}(R_P - E_P)$$

The welfare gain due to a real appreciation of the exchange rate equals the net home goods export position times the size of the real appreciation⁴. However note also that 'our' welfare gain is 'their' welfare loss:

$$\begin{aligned} \frac{dU^*}{dP} &= -E_U^{*-1} E_P^* \\ &= -E_U^{*-1}(R_P - E_P) \end{aligned}$$

using the commodity clearing equation:

$$R_p = E_P + E_P^*$$

One observation is useful before we move towards explicitly taking price stickyness into account. It should be clear that exchange rate changes that are permanent ($dP=dp$) are unlikely to have a major impact, for the same reason permanent changes in the consumption tax do not change intertemporal allocation patterns:

- a permanent change $dP=dp$ does not affect δ_H , so it will not directly affect domestic investment;
- equally, it does not affect δ_F , so foreign investment will not be affected either;
- and finally it does not directly affect δ_C , so the intertemporal pattern of consumption expenditure ("saving") will also not be affected, at least not by substitution effects. Income effects of ToT changes might have an impact, but only when there are asymmetries in international expenditure patterns, because one country's welfare gain is unavoidably another country's welfare loss after a terms of trade change.

⁴Note that in our Mundell-Fleming complete specialization framework, the real exchange rate in fact equals the Terms of Trade.)

3.2 The ZLB in a multi-goods-per-period world

For a more policy related discussion of exchange rates we need to leave our full market clearing equilibrium world and introduce the same price rigidities that we also discussed when introducing the ZLB. Of course even in that setting, given the absence of monetary variables in our model, we cannot analyse purely nominal changes in exchange rates, only the real exchange rate matters. However in the global savings glut world of the ZLB, exchange rates do possibly play a role: we have argued that a real ZLB emerges from a nominal ZLB coupled with price stickyness, taken together to imply a real ZLB. And in such an environment there is potentially a role for exchange rate policy since nominal changes in the exchange rate in the presence of nominal price rigidities actually do change real exchange rates and so will have real effects. Consider first the structure of the world economy in a ZLB environment.

In the ZLB environment, we once again have $R_P > \psi_H Z$. Aggregate global economic activity Z is linked to global capacity output as before, where we need to adjust the definition of global capacity output for the dimensionality issue introduced by the two-goods/period world we now live in:

$$Z < PR_P + R_1^*$$

What changes compared to the one-good-per-period world is the allocation of excess capacity. We cannot pool expenditure anymore like was done in the one-good-per-period version of the model because home and foreign goods are now different. In Section 5.2 in the Annex we show that instead we should use an allocation parameter related to relative expenditure shares, call it ψ_H^E :

$$\psi_H^E = \frac{E_1 + E_1^*}{E_1 + E_1^* + (E_f + E_f^*)/P}$$

The intertemporal budget constraint at home now becomes:

$$\psi_H^E Z + pR_p = E(\Pi, \delta\pi; U) \quad (38)$$

Once again differentiating the ITBC yields welfare expressions that we will need later on:

$$\frac{dU}{dZ} = \psi_H^E E_U^{-1} \quad (39)$$

$$\frac{dU}{d\psi_H^E} = Z E_U^{-1} \quad (40)$$

We need two more equilibrium conditions to pin down the global ZLB equilibrium, the World Current Account equals zero condition and the second period

home goods market clearing condition. Consider first the WCA=0 condition, now dependent on aggregate economic activity Z instead of on δ since the latter is stuck at one at the ZLB:

$$CA(Z, p; P) = \psi_H^E Z - \Pi E_\Pi \quad (41)$$

$$CA^*(Z, p; P) = (1 - \psi_H^E) Z - \Pi^* E_\Pi^* \quad (42)$$

$$CA(\dots) + CA^*(\dots) = 0 \quad (43)$$

The model is completed by the second period home goods market equilibrium GM2:

$$R_{\delta p} = E_{\delta p} + E_{\delta p}^* \quad (44)$$

The solid line labeled WCA=0 in Figure 9 depicts the WCA schedule in Z - p space; we show in the annex that the slope of the WCA schedule for symmetric intertemporal expenditure patterns at home and abroad simplifies to:

$$\frac{dp}{dZ} \Big|_{WCA} = \frac{(1 - c_f^*)}{\Pi(E_{\Pi, p} + E_{\Pi, p}^*)} > 0 \quad (45)$$

The second period goods market equilibrium is represented by the schedule GM2 in Figure 9.

$$\frac{dp}{dZ} \Big|_{GM2} = \frac{(c_2^* + \psi_H^E(c_2 - c_2^*))}{(R_{pp} - E_{pp} - E_{pp}^*)} > 0 \quad (46)$$

since the second derivatives of the expenditure function (E_{pp} and E_{pp}^*) are always negative (they are proportional to pure own-price substitution elasticities) while R_{pp} is always positive. The two solid lines in Figure 9 show the two schedules in Z - p space. The GM2 schedule 46 is always steeper than the WCA schedule 45 in stable configurations.

3.3 Exchange rates and the ZLB

We now have the apparatus to analyse changes in (real) exchange rates. Note that *future* exchange rate policy (moving p) plays no role: we have assumed period two is a flexprice equilibrium so nominal exchange rate policy can in fact not affect the real exchange rate p directly, p is an endogenous variable. More relevant is the discussion of current exchange rate policy and the variable P (the current day real exchange rate). If we assume that the price stickiness that gives rise to the ZLB to begin with also allows one country to move the current day real exchange rate through nominal devaluations (i.e. change P), what would be the impact of such a policy? The question is relevant, one

Global equilibrium in a multi-good/multi-period world

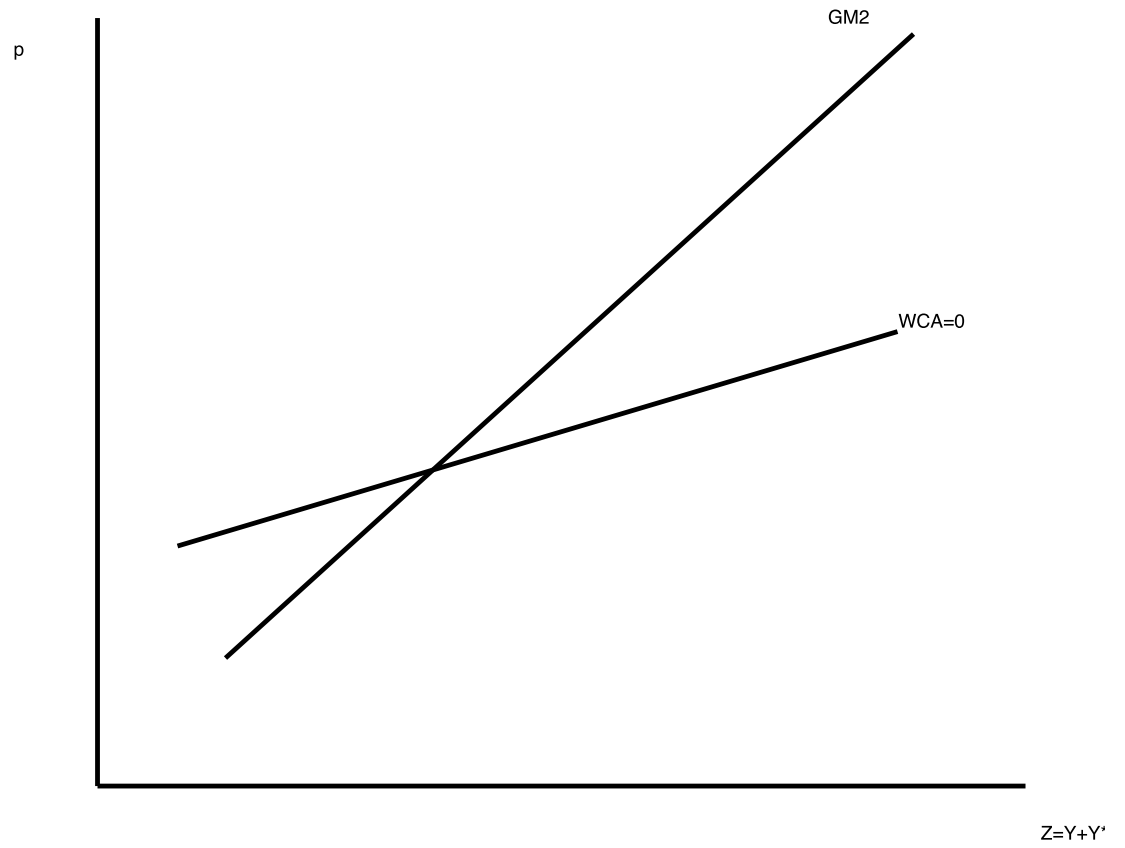

Figure 9: Output at the ZLB and (future) real exchange rates

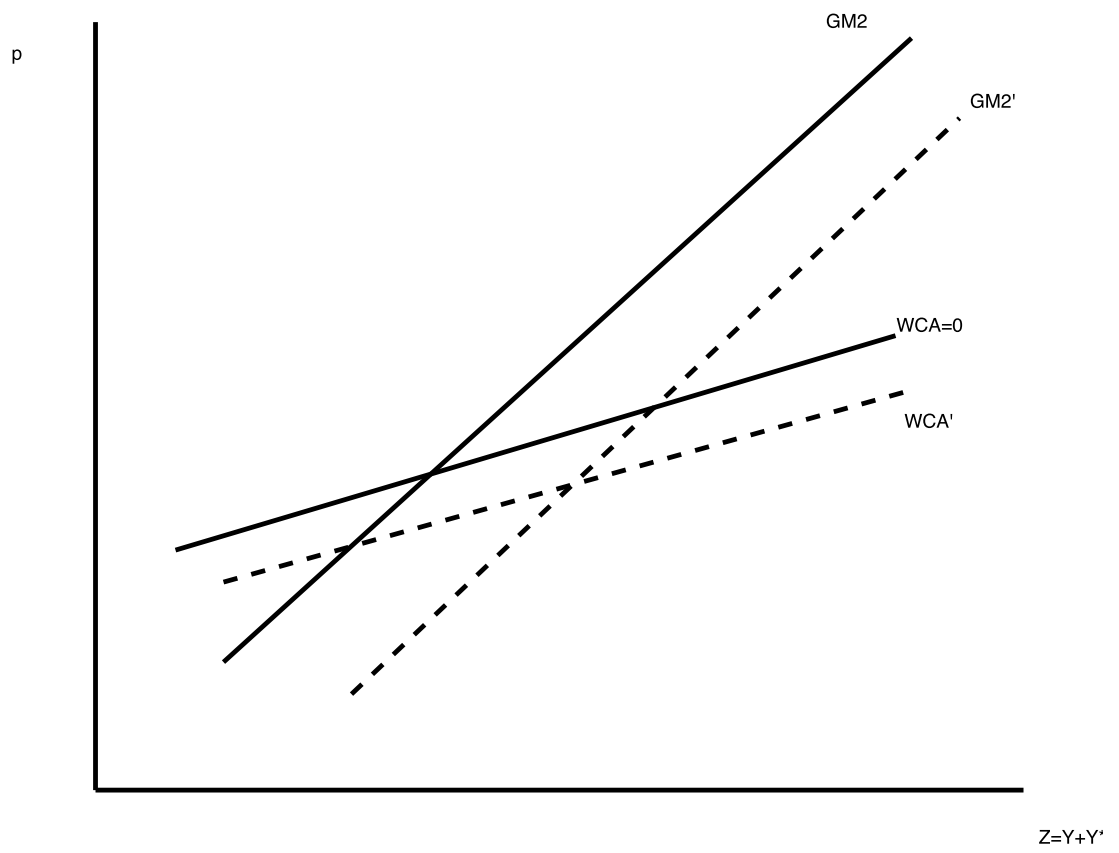

Figure 10: Impact of a current real depreciation (shift from slotted to solid lines)

view on current FED/ECB policy is that it is just a currency war, a reply of the competitive devaluations of the 1930ties using indirect unconventional monetary policy instruments. The consequences are sketched in Figure 10 below.

Consider then the first step in a currency war, a period one real depreciation ($dP < 0$). A lower P (a real depreciation of the home currency, "talking the dollar down") has a variety of effects, although none of them directly addresses the key ZLB problem of excess supply of current goods at $\delta = 1$. First of all, a lower P shifts demand from current foreign goods to current home goods; In our framework, this is represented by a shift in ψ_H . In Section 5.2 in the Annex we show that.:

$$\frac{dWCA}{d\psi_H} = Z(c_I^* - c_I) \quad (47)$$

But this reallocation does not affect *overall* demand for current goods (both foreign and domestic) if expenditure patterns are symmetric ($c_I = c_I^*$). In other words, a lower P reallocates the burden of the recession from the home to the foreign country but that does not in itself alleviate the overall burden. This is the point made by [3].

However that is not the end of it. Even if we assume sufficient spending symmetry so the redistribution of income brought about by the terms of trade deterioration of the home country has no macroeffect either, we are still left with the possibility of a less than one-for-one offsetting change in tomorrow's real exchange rate, thereby triggering a change in *intertemporal* relative prices. If $dP < 0$ is even partially temporary (i.e. $dP < dp < 0$), the initial first period depreciation is in fact followed by an *expected real appreciation*, which implies a shift in the intertemporal relative prices δ_H and δ_C (cf equ. 35 and equ. 36) shifting demand from tomorrow towards today. That of course has an expansionary effect on today's output. But how certain are we that there will be a less than complete offset in tomorrow's real exchange rate?

Consider first the opposite: is it possible that an exchange rate depreciation today ($dP < 0$) endogenously generates an equivalent depreciation tomorrow, thereby making the price impact of the exchange rate change permanent and by that very fact eliminating any intertemporal price effect? The answer is no which we can see by assuming that it does and show that that assumption leads to inconsistencies. Assume $dP < 0$ is endogenously followed by a (proportionally) equivalent depreciation tomorrow. Then from the definitions of the home and the consumption discount factors equ. 35 and equ. 36 it is clear that neither investment at home nor investment abroad nor consumer savings behavior would be affected (again barring asymmetric spending out of income effects). The only thing that will happen then is that the burden of the recession is reallocated from country H towards country F. This is the claim made by [3]. But if there is no change in current behavior, what will trigger the change in tomorrow's exchange rate? If both domestic and foreign investment remain the same, the intertemporal pattern of production, and hence the aggregate supply of both H and F goods tomorrow will be the same as before $dP < 0$. And we saw

that consumption behavior does not change either, again assuming international spending pattern symmetry. But then the equation tying down the second period exchange rate (32) has left and right the same arguments and will yield the same solution as before the change in P ; so there will in fact not be a matching change in the future exchange rate p , which invalidates the starting point of this line of reasoning. This establishes that the exchange rate impact cannot be permanent, any offsetting depreciation tomorrow, if it takes place at all, will be smaller, although we will establish shortly that some depreciation tomorrow will follow.

As a consequence, there will be a substitution driven shift from future to current expenditure which in turn would undermine world current account balance. So we get the result shown in Figure 10, that output today has to increase to bring WCA back into its WCA=0 equilibrium. This is a non-trivial result, and it goes against the Caballero-Fahri view that exchange rate changes have no impact other than reallocating the burden of the recession without affecting its overall severity (cf[3]). Interestingly enough we can also see that the increase in expenditure is larger at home than abroad, even if consumer expenditure would respond equally at home and abroad to the shift in intertemporal relative prices: because δ_H is also affected by a (partially) temporary depreciation, domestic investment increases. There is no such investment effect abroad because $\delta_F = \delta$ is pinned down by our assumption of a ZLB tying down δ at 1. This home investment response has two macroconsequences: first, tomorrow's supply of home goods increases, which does lead to a further depreciation tomorrow, although still not enough to fully match $dP < 0$. But second, the asymmetry in investment response also explains why **the home country current account will in fact deteriorate, in spite of the real depreciation!** This is a warning against too closely linking changes in exchange rates and the current account, the relation is more complicated than usually assumed in policy circles. Here a real depreciation through its intertemporal effects actually leads to a deteriorating current account in the depreciating country. The explanation lies in the less than full matching of today's depreciation by tomorrow's depreciation; that in fact implies a gradual appreciation over time which lowers the relevant real interest rate and triggers a home country current account deficit (and of course a matching foreign country surplus, after all the world current account always equals zero). These current account reactions to real exchange rate changes reflect shifts in intertemporal trade and the exchange rate is not an intertemporal relative price. Linking the two should thus be done with caution.

Is the opposite possible, no change whatsoever in future exchange rates? Assume that is the case. Then quite a lot will happen today, but will that leave tomorrow's goods markets unaffected in such a way that an unchanged real exchange rate is still compatible with second period home goods equilibrium? Consider first domestic investment. Since $dP < 0$, $dp=0$ unavoidably leads to a higher δ_H , today's investment will increase in the home market. This reduces excess supply today, which in itself does not necessarily disturb tomorrow's equilibrium. But it also increases the net supply of home goods tomorrow, which in fact would cause the real exchange rate tomorrow to fall, although

less than today's rise, otherwise the investment surge would not have happened to begin with. So this channel already argues against a zero change tomorrow outcome.

These two counterfactuals establish our key result: after an exchange rate change $dP < 0$, we get:

$$dP < dp < 0$$

The net effects can be seen in Figure 10. The shift away from tomorrow's goods market triggered by a depreciation today is represented by the shift to the right of the second period goods market equilibrium curve GM2 (cf the slotted line GM2'). The first period real depreciation cheapens current goods in general: when P goes down Π goes down too). But that in itself triggers an incipient current account deficit which needs to be offset by an offsetting cheapening of future goods or an increase in today's income, both of which improve today's current account and so bring it back into balance. This is represented by the shift in the WCA schedule down and to the right (towards the slotted line WCA'). The net impact is as we just argued: today's real depreciation is incompletely matched by a smaller depreciation tomorrow, and by an expansion in current day activity Z . The depreciation indeed shifts some of the burden from the recession from the home country to the foreign country, but it also lessens the severity of the overall recession.

Some qualifying remarks: first, the assumption that each country uses its home goods only as an input for capital accumulation has as we saw a magnifying impact on both the particular intertemporal exchange rate pattern that emerges after the first period depreciation and on the impact of that depreciation on recession severity. The assumption (only home goods are used in domestic investment) is too extreme to be sure, but not entirely unrealistic either: investment has a large building/construction component which is associated with domestic output only. A second issue concerns the question of why does it matter which country depreciates? Could we trigger the same string of consequences when the foreign country depreciates and thus the home country appreciates (i.e. $dP > 0$)? That can obviously not be true, $dP > 0$ cannot lead to the same sequence of effects as $dP < 0$, but what explains the asymmetry, since our designation of which country is home and which is foreign is in fact arbitrary? The reconciliation comes from the way the ZLB is imposed. We limit $\delta \leq 1$, not $\delta_H < 1$. And the gradual appreciation over time actually lowers the home country goods discount rate (raises the home goods discount factor $\delta_H = \frac{\delta p}{P}$). Foreign real rates cannot fall because of the ZLB pinning δ at 1. For that to change we would need to actually introduce explicit nominal variables in the model and explore the consequences of the arbitrage opportunities that would open up in the presence of relative price changes that would break the arbitrage relations between the two discount rates if both are capped.

3.4 The global impact of import tariffs

Consider next the beginning of a tariff war in ZLB territory, which we interpret as one country temporarily setting up tariffs against the other country during a worldwide deficient demand recession. Tariffs are easily introduced in our multicommodity ZLB setup: a tariff raises the price of foreign good in the home country. Consider the imposition of a temporary tariff Ta , so the first period home price index changes as follows:

$$\Pi(P, 1) \Rightarrow \Pi(P, (1 + Ta)) \quad (48)$$

Tariff revenues have an impact on each country's ITBC:

$$\begin{aligned} \psi_H(Ta) * Z + R_{\delta p} + Ta * E_{\Pi} \Pi_{Ta} &= E((\Pi(P, 1 + Ta), \delta\pi(p, 1); U) \quad (49) \\ (1 - \psi_H(Ta))Z + R_{\delta}^* &= E^*(\Pi(P, 1), \delta\pi(p, 1); U^*) \quad (50) \end{aligned}$$

Implicit in the formulation of equ. 49 is the assumption of symmetric expenditure patterns (i.e. $\Pi(P, 1) = \Pi^*(P, 1)$). Differentiation of the ITBC's shows that handing out the tariff revenues in the home country in lump sum fashion means that direct income effects of the tariff cancel out at home and any remaining welfare effect work through the redistribution of global expenditure triggered by the tariff imposition:

$$\begin{aligned} \frac{d\psi_H}{dT_a} Z &= E_U \frac{dU}{dT_a} \\ -\frac{d\psi_H}{dT_a} Z &= E_U^* \frac{dU^*}{dT_a} \end{aligned}$$

Consider next the impact on the world current account equilibrium and second period home goods equilibrium:

$$\begin{aligned} (R_p - E_{pp} - E_{pp}^*)dp &= E_{\delta p, Ta} dTa + E_U dU + E_U^* dU^* \\ &= (E_{\delta p, Ta} + Z(c_f - c_f^*))dTa \end{aligned}$$

Therefore unless expenditure patterns are very asymmetrical internationally, we get:

$$\begin{aligned} \frac{dp}{dT_a} &= \frac{E_{\delta p, Ta} + Z(c_f - c_f^*)}{R_p - E_{pp} - E_{pp}^*} \\ &> 0 \end{aligned}$$

So the GM2 curve shifts upwards in Figure 11.

Consider next the way the world current account equilibrium is shifted by the imposition of first period tariffs:

Tariffs and World Economic Activity

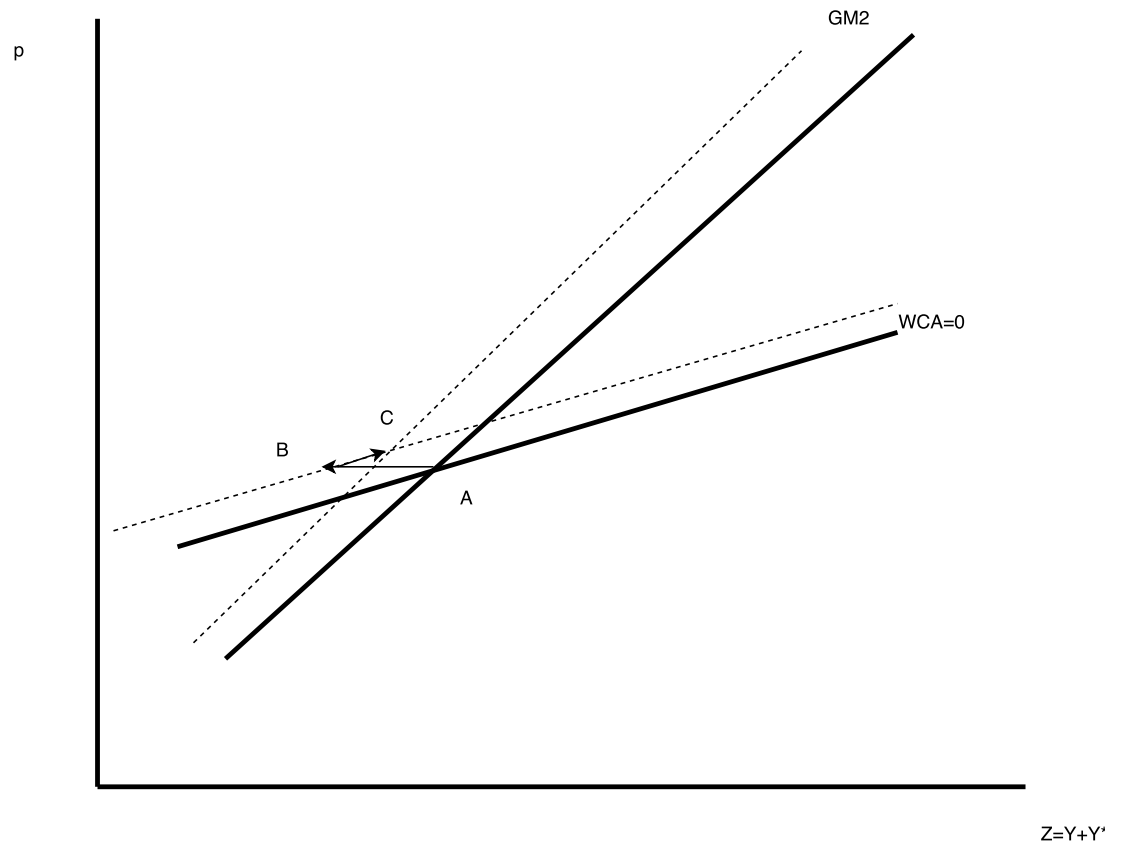

Figure 11: Tariffs and global economic activity

$$WCA_Z dZ + WCA_{d\psi_H} d\psi_H + WCA_{\delta_C} \frac{\partial \delta_C}{\partial T a} + WCA_p dp = 0$$

For symmetric expenditure patterns we can ignore the term $WCA_{d\psi_H} d\psi_H$ because in that case the redistribution of income that tariffs bring about from foreign to home consumers will not have an impact on aggregate world economic activity. Note also that there are no effects of the income effects of tariffs throughn their direct (negative) income effect at home because we assume that the tariff revenues are handed out again (as is traditional in trade theory, and in randomized fashion so as not to also eliminate the substitution effect). So for given future exchange rates p (i.e. we investigate the horizontal shift of the WCA schedule in Figure 11), we are left with a single shift factor operating through the consumer discount factor δ_C :

$$\begin{aligned} \frac{\partial \delta_C}{\partial T a} &= -\delta_C \frac{\Pi T a}{\Pi} \\ &< 0 \end{aligned}$$

Combine this with our earlier result that $WCA_Z < 0$ to get:

$$\begin{aligned} \frac{dZ}{dT a} \Big|_{WCA} &= - \frac{-WCA_{\delta_C} \delta_C \frac{\Pi T a}{\Pi}}{WCA_Z} \\ &= \frac{WCA_{\delta_C} \delta_C \frac{\Pi T a}{\Pi}}{WCA_Z} \\ &< 0 \end{aligned}$$

So the WCA schedule shifts to the left: for given future real exchange rates, world output will in fact fall after the imposition of first period tariffs. Of course shifting expenditure towards the future means the period 2 exchange rate will appreciate; at least part of th higher future expendiutire wiull fall on home goods so its relative price will have to go up too restore equilibrium. But that offset can logically only be partial because otherwise it would not arise to begin with. In terms of our diagram in Figure 11, the economy moves from A towards B for given future exchange rates, an unambiguous decline in world activity level Z. The subsequent appreciaton which arizes as a consequence of this shift of expenditure towards the future can logically only partially offset the fall in current global activity levels: the economy moves from B to C in Figure 11. This is a strong result: although under symmetric expenditure patterns the redistributive impact of tariffs will not have an impact on world economic activity, their temporary nature shifts expenditure towards the future and makes them recessionary after all.

4 Conclusions

Our starting point in this paper is a definition of "the" equilibrium rate of interest: the (real) interest rate that sets the ex ante world current account equal to zero with all markets characterized by fully flexible prices. To discuss that concept and subsequently potential drivers of observed changes in the real interest rate over time in the empirical literature, we have presented a starkly simplified model of the world economy, with a minimal structure of two periods and first one then two goods per period. This is the absolute minimum necessary to discuss both intertemporal relative prices (real interest rates) and intra-temporal relative prices (real exchange rates). Simplification has its costs: the absence of uncertainty except for unanticipated shocks means we cannot discuss the impact of shifting risk preferences or increases in demand for safe assets, like in [3]. And just focusing on a two period framework we cannot discuss any transition issue at all. But it also has major advantages: we do not need to resort to specific functional forms nor to computer simulations to reach our conclusions. And a full analytical treatment allows for much more complete analytical characterization than an analysis confined by specific functional forms or even worse by having to resort to parameter dependent computer simulation.

We first present the simplest variant, a two period one good/period model that already leads to rich results. We clarify when a ZLB can emerge in spite of the presence of a positive rate of time preference which makes negative real rates an a priori implausible outcome. We show that a ZLB can emerge when a decline in future output is expected. In this manner we show that expectations of lower future productivity growth can lead to lower and possibly even more negative real rates. But in reverse we demonstrate that Mario Draghi in his Sintra (2016) speech was right arguing that structural reform leading to anticipated higher future output can restore positive real rate equilibria. Furthermore by introducing minimal heterogeneity into our model (a distinction between consumers who will work in period 2 and consumers who will not) we show how and why aging also can depress equilibrium real rates to the point of driving them negative. We then analyse time varying consumption taxes and demonstrate that cutting consumption taxes now and increasing them in the future (i.e. a temporary cut in general VAT rates) can help the economy escape from the ZLB trap by allowing negative consumption real rates to emerge in spite of the ZLB. Finally we use the same framework to analyse a fiscal expansion, higher home government expenditure on home goods in period 1. Since we do not have borrowing constrained consumers in our Keynesian deficient aggregate demand region, the excess demand for assets is triggered by the ZLB, we do not get standard second round multiplier effects. Whether the multiplier is higher or lower than 1 is shown to depend on the time pattern of the taxes needed to finance the additional government spending. If the additional government expenditure is financed by an equal-discounted-value permanent flat tax, the multiplier stays at one. A balanced budget expansion, i.e. today's additional expenditure is fully financed by concurrent taxes leads to higher cost of consumption today than tomorrow and so a shift of expenditure from today towards tomorrow. As

a consequence the multiplier ends up being smaller than one in this case. If instead one chooses for full deficit financing (the additional expenditure is financed by equal discounted value future taxes only), future goods will be more expensive and expenditure will shift towards today. So for the case of deficit financing and higher future taxes the multiplier is in fact larger than 1.

We then proceed to extend the model to a two goods per period setting so as to be able to discuss exchange rate and tariff policy. Tariff wars are becoming relevant again since at the time of writing the USA seems to be about to start one; and exchange rates have taken on additional relevance since on one interpretation recent central bank Unconventional Monetary Policies have in fact come down to relaunching competitive exchange rate policies to combat recessions. Like [3] we find that for given intertemporal relative prices exchange rate depreciation just reallocates the burden of a ZLB-induced recession. But we extend their results by indicating that a temporary real depreciation in fact does more than reallocate the burden of the recession for given overall severity. A fall in the relative price of home goods will not only shift expenditure from foreign to domestic markets in the same period, but also from future goods markets towards today. That will lead to a partially offsetting real depreciation tomorrow, but always smaller than the initial depreciation today. As a consequence the initial depreciation is followed by a gradual appreciation and an overall increase in current expenditure and, by extension, since we are in ZLB territory, an expansion in overall economic activity. The reason for which this happens is intricately linked to the way the ZLB actually binds: we have assumed a ZLB for foreign goods real interest rates. Since the depreciation in fact is endogenously followed by an appreciation, the real rate in terms of domestic goods falls, in this way allowing for negative real consumption rates of interest in spite of the ZLB on real interest rates expressed in terms of foreign goods. Finally we use our multi-good/multi-period model to analyse the impact of tariff policy on global economic activity. We show that under symmetric expenditure patterns, the income redistribution brought about by tariff policy will not expand world economic activity; but if tariffs are temporary, like one can reasonably expect if they are part of a trade war, we show they will in fact lead to LOWER world economic activity through their influence on intertemporal relative prices. Higher tariffs today raise the cost of current consumption compared with the cost of future consumption and will shift expenditure towards the future. In a ZLB region, that will in turn trigger a fall in economic activity.

5 Mathematical Appendix

5.1 The one good-two period model

The intertemporal budget constraint requires the discounted value of income to equal the discounted value of expenditure::

$$R = E$$

Simply differentiating the intertemporal budget constraint gives us the welfare effect of changes in the discount factor:

$$(R_\delta - E_\delta)d\delta = ca.d\delta = E_U dU$$

With a similar expression for the foreign country:

$$\begin{aligned} (R_\delta^* - E_\delta^*)d\delta &= ca^*.d\delta \\ -ca.d\delta &= E_U^* dU^* \end{aligned}$$

using the fact that the world current account is zero in each period.

Consider next the basic equilibrium condition $CA(\delta) + CA^*(\delta) = 0$. Differentiating it gives us the two lines from Figure 1 and the resulting equilibrium condition:

$$(CA_\delta + CA_\delta^*)d\delta = E_{\delta U} dU + E_{\delta U^*} dU^* \quad (51)$$

$$(CA_\delta + CA_\delta^*)d\delta = (c_\delta - c_\delta^*)ca.d\delta \quad (52)$$

c_δ is the marginal (and average, given our assumption of homotheticity of preferences) propensity to spend on second period goods by the home country, and c_δ^* the corresponding variable for the foreign country. For symmetric expenditure patterns the RHS of (51) is zero, as stated in the text and the two terms on the LHS give us the two lines in Figure 1. In what follows we will generally assume symmetric expenditure patterns and thus no global income effects unless mentioned differently. For later use we give the expression for CA_δ below, the expression for the foreign counterpart is similar with obvious substitutions.

$$\begin{aligned} CA_\delta &= R_{1\delta} - E_{1\delta} - E_{1U} \frac{dU}{d\delta} \\ &= R_{1\delta} - E_{1\delta} + c_1 CA \frac{d\delta}{\delta} \\ &< 0 \end{aligned}$$

unless strong positive income effects offset that. We will always assume that income effects are too small to do that (and note that globally they cancel out anyhow). An initial current account deficit is already sufficient for that. In the derivation we used $c_1 = E_{1U} E_U^{-1}$, Note that $R_{1\delta} = -I'(\delta) < 0$. The analogous formulas for the foreign counterpart are obvious. Consider next the various shift factors that may be behind our current period of low real rates.

5.1.1 *Productivity change.*

We model a downward shift in future output by introducing a shift factor combined with the second period price δ , i.e. future output is a function of $\xi\delta$, Lower future output is triggered by $d\xi < 0$:

$$\begin{aligned}
R_{\delta,\xi} &= R_{\delta\delta} \\
&= y_k I'(\delta) \\
&> 0
\end{aligned}$$

so a productivity slowdown is represented by $d\xi < 0$. Next we need the welfare impact of a productivity shift, which we again get by differentiating the intertemporal budget constraint:

$$R_{\delta}d\xi = E_U dU$$

We can then investigate the shift in the CA schedule:

$$\begin{aligned}
CA_{\xi} &= R_{1,\delta} - E_{1U} \frac{dU}{d\xi} \\
&= R_{1,\delta} - E_{1U} E_U^{-1} R_{\delta} \\
&= R_{1,\delta} - c_1 R_{\delta} \\
&< 0
\end{aligned}$$

So a prospective productivity decline $d\xi < 0$ indeed shifts the CA schedule upwards, as depicted in Figure 2 in the main text.

5.1.2 *Structural Change*

The same analysis can be used to analyse the shifts introduced by (future) structural change: structural change can be represented by $d\xi > 0$ shocks with the corresponding shift factors.

5.1.3 *Aging and the world real interest rate*

On aging the analysis is relatively simple. Clearly the current account in the home country is the sum of the savings-investment balance of the two groups. We assume consumption and investment decisions are taken by different actors, so we can simply use the revenue function framework for the intertemporal supply side description as before. This leads to:

$$\begin{aligned}
CA(\delta; \lambda) &= \lambda CA^p(\delta) + (1 - \lambda) CA^w(\delta) \\
&\Rightarrow \\
CA_{\lambda} &= CA^p(\delta) - CA^w(\delta) \\
&> 0
\end{aligned}$$

because the group knowing it needs retirement income will save more. This corresponds to the shifts in Figure 4. If the same aging related shift occurs abroad (i.e. $d\lambda^* > 0$ too we get analogous expressions for the foreign current account with general equilibrium effects as depicted in Figure 4.

5.1.4 *Temporary Consumption Tax Cuts*

Consider next the coordinated tax change (current consumer taxes down and future consumer taxes up in a balanced budget fashion:

$$\begin{aligned} E_1 dT + E_\delta \delta dt &= 0 \\ dT &< 0 \end{aligned}$$

Then the impact of the tax changes (for given real pre-tax discount factor δ) on the consumption discount factor $\delta_c = \frac{\delta(1+t)}{1+T}$ is:

$$\begin{aligned} d\delta_c|_\delta &= \delta dt + \frac{\delta^2(1+t)}{(1+T)^2} dt \\ &= \left(\delta + \frac{\delta_c^2}{1+t}\right) dt \\ &> 0 \end{aligned}$$

We also have:

$$\begin{aligned} CA_{\delta_c} d\delta_c|_\delta &= -E_{1,\delta} d\delta_c|_\delta - E_{1,U} \frac{dU}{d\delta_c|_\delta} d\delta_c|_\delta \\ &= -E_{1,\delta} d\delta_c|_\delta + c_1 E_\delta d\delta_c|_\delta \end{aligned}$$

which means the CA schedule shifts down barring excessively large income effects.

5.1.5 *The ZLB*

The ITBC of the home country becomes:

$$\psi_H Z + R_\delta = E(1, \delta; U)$$

Differentiating it yields the welfare impact of changes in economic activity Z :

$$\frac{dU}{dZ} = \psi_H E_U^{-1}$$

The home country current account schedule is:

$$\begin{aligned}
CA(Z) &= \psi_H Z - E_1 \\
&> \\
CA_Z &= \psi_H - E_{1,U} \frac{dU}{dZ} \\
&= \psi_H(1 - c_1) \\
&> 0
\end{aligned}$$

with analogous expressions holding for CA^* . Global current account equilibrium requires:

$$CA(Z) + CA^*(Z) = 0$$

Using the expressions for CA_Z and CA_Z^* it is straightforward to show that:

$$\begin{aligned}
WCA_Z &= \psi_H(1 - c_1) + (1 - \psi_H)(1 - c_1^*) \\
&= (1 - c_1^*) + \psi_H(c_1^* - c_1) \\
&> 0
\end{aligned}$$

which we will need below.

5.1.6 *Fiscal Policy: Government expenditure at the ZLB*

Define first of all total tax revenues Tr :

$$TR = E_1 T + E_\delta \delta t$$

And recall the definition of the consumer discount factor δ_C :

$$\delta_C = \frac{\delta(1+t)}{1+T}$$

Note that through tax changes δ_C can change although $\delta = 1$ at the ZLB. The model with a GBC (Government Budget constraint) and fiscal policy now becomes:

$$G + \delta g = TR$$

We will only consider policy experiments where $dG > 0$, $dg = 0$. The private sector budget constraint now is:

$$\psi_H Z + G + R_\delta - TR = E(1, \delta_C; U) \quad (53)$$

$$(1 - \psi_H)Z + R_\delta^* = E^*(1, \delta; U^*) \quad (54)$$

Z now represents private-expenditure-generated production. Underlying this formulation is that G is exclusively directed at home producers, see the corresponding subsection in the main text for an elaboration. It immediately follows from differentiating equations (52) and (53) that there are no direct welfare effects of dG:

$$\frac{dU}{dG} = 0 \quad (55)$$

It is then straightforward to show that the multiplier for total activity $Z' = Z+G$ deviates from 1 only when δ_C is affected. Define

$$\mu_G \equiv \frac{dZ'}{dG}$$

and one gets by using the GIBC that:

$$\mu_G = 1 + \frac{-CA_{\delta_C}}{WCA_Z} \frac{d\delta_C}{dG} \Big|_{GIBC} \quad (56)$$

$$= 1 + \frac{E_{1,\delta} - c_1 E_\delta}{(1 - c_1^*) + \psi_H(c_1^* - c_1)} \frac{d\delta_C}{dG} \Big|_{GIBC} \quad (57)$$

$$= 1 + \Gamma \frac{d\delta_C}{dG} \Big|_{GIBC} \quad (58)$$

with $\Gamma > 0$ given our assumption that income effects do not dominate the substitution effects of changes in δ_C .

5.2 On real exchange rates, tariffs and the ZLB in a multi-commodity world

Consider now a matching model on a country basis⁵ instead of pooling all expenditure as was done in the previous section in the context of a 1 good/period set up. We define p_H as the matching probability in the home country, and aggregate worldwide period one consumption expenditure as Σ . First also define the relative expenditure share on home goods in period 1 in total period 1 expenditure:

$$\psi_H^E = \frac{E_1 + E_1^*}{E_1 + E_1^* + (E_f + E_f^*)/P}$$

We then get:

⁵And thus on commodity basis, given our assumption of complete specialization

$$\begin{aligned}
p_H &= \frac{E_1 + E_1^*}{R_1} \\
&= \left(\frac{E_1 + E_1^*}{\Sigma}\right)\left(\frac{\Sigma}{R_1 + R_1^*}\right)\left(\frac{R_1 + R_1^*}{R_1}\right) \\
&= \psi_H^E p_m / \psi_H
\end{aligned}$$

Therefore we can write aggregate demand for first period home goods as:

$$\begin{aligned}
E_1 + E_1^* &= p_H R_1 \\
&= \psi_H^E p_m R_1 / \psi_H \\
&= \psi_H^E Z
\end{aligned} \tag{59}$$

using the previously introduced definition: $\psi_H = \frac{R_1}{R_1 + R_1^* / P}$.

We can then proceed to assess the partial derivatives we need to construct the diagrams used in the main body of the paper:

$$\begin{aligned}
CA_Z &= \psi_H^E - \Pi E_{\Pi, U} \frac{dU}{dZ} \\
&= \psi_H^E - \Pi E_{\Pi, U} \psi_H E_U^{-1} \\
&= \psi_H^E (1 - c_I) > 0
\end{aligned}$$

Similarly, we obtain:

$$CA_Z^* = (1 - \psi_H^E)(1 - c_I^*) > 0$$

so for the WCA schedule we get:

$$\begin{aligned}
WCA_Z &= CA_Z + CA_Z^* \\
&= \psi_H^E (1 - c_I) + (1 - \psi_H^E)(1 - c_I^*) > 0 \\
&= (1 - c_I^*) + \psi_H^E (c_I^* - c_I) \\
&> 0
\end{aligned}$$

It is furthermore straightforward to show that the partial derivative with respect to to the second period exchange rate p equals:

$$WCA_p = -(\Pi E_{\Pi, p} + \Pi^* E_{\Pi, p}^*) - (c_I - c_I^*)(R_p - E_p)$$

So we get in p-Z space:

$$\begin{aligned}\frac{dp}{dZ}|_{WCA} &= \frac{(1 - c_I^*) + \psi_H^E(c_I^* - c_I)}{(\Pi E_{\Pi,p} + \Pi^* E_{\Pi,p}^*) - (c_I - c_I^*)(R_p - E_p)} \\ &> 0\end{aligned}$$

if we assume symmetric intertemporal expenditure patterns at home and abroad ($c_I = c_I^*$), we obtain the simplified formula given in equ. 45 in Section 3 in the main text.

Consider next second period goods market equilibrium, the line GM2 in Figure 10. Differentiating $R_p = E_p + E_p^*$ and inserting expressions for the welfare effects of dp yields:

$$\begin{aligned}(R_{pp} - E_{pp} - E_{pp}^*)dp &= E_{p,U} \frac{dU}{dZ} + E_{p,U}^* \frac{dU^*}{dZ} \\ &= (c_2 \psi_H^E + c_2^*(1 - \psi_H))dZ \\ &= (c_2^* + \psi_H^E(c_2 - c_2^*))dZ\end{aligned}$$

so we get:

$$\begin{aligned}\frac{dp}{dZ}|_{GM2} &= \frac{(c_2^* + \psi_H^E(c_2 - c_2^*))}{(R_{pp} - E_{pp} - E_{pp}^*)} \\ &> 0\end{aligned}$$

It can be shown that under reasonable price adjustment mechanisms ($\dot{Z} \propto (\Sigma - Z)$ and $\dot{p} \propto (E_p + E_p^* - R_p)$), stability requires:

$$\frac{dp}{dZ}|_{GM2} > \frac{dp}{dZ}|_{WCA}$$

which is conform the diagrams used in Section 3 in the main text.

References

- [1] A. Boersch-Supran, A. Ludwig, and J. Winter. Aging, pension reform and capital flows: a multi-country simulation model. *Economica*, 73:625–658, 2006.
- [2] C. Borio, M. Juselius, P. Disyatat, and M. Drehman. Monetary policy, the financial cycle, and ultra-low interest rates. *International Journal of Central Banking*, 13(3):55–89, 2017.
- [3] R. Caballero, E. Fahri, and P. Gourinchas. Global imbalances and currency wars at the zlb. *NBER WP 21670*, 2015.
- [4] J. De Haan and J. parlevliet, editors. *Structural Reforms. Moving the Economy Forward*. Springer International Publishing AG, 2018.

- [5] M. Del Negro, M. Giannone, Giannone G., and A. Tambalotti. Safety, liquidity and the natural rate of interest. *BPEA*, 2017.
- [6] Avinash Dixit and Victor Norman. *The Theory of International Trade*.
- [7] K. Holston, T. Laubach, and W. Williams. Measuring the natural rate of interest: International trends and determinants. *Journal of International Economics*, 108:59–75, 2017.
- [8] T. Laubach and W. Williams. Measuring the natural rate of interest. *ReStat*, 85(4):1063–1070, 2003.