

Jochem, Patrick; Kaschub, Thomas; Fichtner, Wolf

**Working Paper**

## How to integrate electric vehicles in the future energy system?

Working Paper Series in Production and Energy, No. 3

**Provided in Cooperation with:**

Karlsruhe Institute of Technology (KIT), Institute for Industrial Production (IIP)

*Suggested Citation:* Jochem, Patrick; Kaschub, Thomas; Fichtner, Wolf (2013) : How to integrate electric vehicles in the future energy system?, Working Paper Series in Production and Energy, No. 3, Karlsruhe Institute of Technology (KIT), Institute for Industrial Production (IIP), Karlsruhe,  
<https://doi.org/10.5445/IR/1000035023>

This Version is available at:

<https://hdl.handle.net/10419/176729>

**Standard-Nutzungsbedingungen:**

Die Dokumente auf EconStor dürfen zu eigenen wissenschaftlichen Zwecken und zum Privatgebrauch gespeichert und kopiert werden.

Sie dürfen die Dokumente nicht für öffentliche oder kommerzielle Zwecke vervielfältigen, öffentlich ausstellen, öffentlich zugänglich machen, vertreiben oder anderweitig nutzen.

Sofern die Verfasser die Dokumente unter Open-Content-Lizenzen (insbesondere CC-Lizenzen) zur Verfügung gestellt haben sollten, gelten abweichend von diesen Nutzungsbedingungen die in der dort genannten Lizenz gewährten Nutzungsrechte.

**Terms of use:**

*Documents in EconStor may be saved and copied for your personal and scholarly purposes.*

*You are not to copy documents for public or commercial purposes, to exhibit the documents publicly, to make them publicly available on the internet, or to distribute or otherwise use the documents in public.*

*If the documents have been made available under an Open Content Licence (especially Creative Commons Licences), you may exercise further usage rights as specified in the indicated licence.*

# How to integrate electric vehicles in the future energy system?

by Patrick Jochem, Thomas Kaschub and Wolf Fichtner

No. 3 | JUNE 2013

WORKING PAPER SERIES IN PRODUCTION AND ENERGY



Foto: Rainer Sturm / pixelio.de

# How to integrate electric vehicles in the future energy system?

**Patrick Jochem, Thomas Kaschub, and Wolf Fichtner**

Chair of Energy Economics, Institute for Industrial Production (IIP)  
at the Karlsruhe Institute of Technology (KIT),  
Hertzstr. 16, building 06.33, 76187 Karlsruhe,  
tel.: +49 721 608-44590, email: jochem@kit.edu

This paper has been prepared for the “final conference of the socio-economic research of the 'Model region Electric Mobility Bremen/Oldenburg’”, 18<sup>th</sup> and 19<sup>th</sup> August 2011 at Jacobs University in Bremen.

## **Abstract**

Main challenges within the energy system of tomorrow are more volatile, less controllable and at the same time more decentralized electricity generation. Furthermore, the increasing research and development activities on electric vehicles (EV) make a significant share of electric vehicles within the passenger car fleet in 2030 more and more likely. This will lead to a further increase of power demand during peak hours.

Answers to these challenges are seen, besides measures on the electricity supply side (e. g. investing in more flexible power plants or storage plants), in (1) grid extensions, which are expensive and time consuming due to local acceptance, and in (2) influencing electricity demand by different demand side management (DSM) approaches. Automatic delayed charging of electric vehicles as one demand side management approach can help to avoid peaks in household load curves and, even more, increase the low electricity demand during the night. This facilitates integrating more volatile regenerative power sources, too.

Bidirectional charging (V2G) and storing of electricity extends the possibilities to integrate electric vehicles into the grid. But, comparing electricity storage costs and availability of electric vehicles with costs and technical conditions of other technologies leads to the conclusion, that vehicle to grid (V2G) is currently not competitive – but might be competitive in the future, e. g. within the electricity reserve market.

In summary, the paper gives an overview of the future electricity market with the focus on electric vehicles and argues for automatic delayed charging of electric vehicles due to economic and technical reasons.

## Introduction

The energy system of today is faced with advancing challenges: more volatile, less controllable and at the same time more decentralized electricity generation. Simultaneously, the political objective is to increase energy efficiency (see e. g. proposal for the directive on energy efficiency (EC 2011)) and to greenhouse gas emissions (e. g. Erdmenger et al. 2009). From the German perspective these challenges might be tremendous due to the ambitious aim of CO<sub>2</sub> emission reduction of up to 80 % in 2050 compared to 1990 levels (e. g. Nagl et al. 2011; BMU 2010) and the nuclear phase-out until 2022 (German Atomic Energy Law – AtG).

The development of the electricity generation and its composition in Germany until 2050 illustrates these challenges (Figure 1). While the share on conventional power generation (coal, nuclear, natural gas, and oil) was above 80 % in 2008, it is supposed to be below 50 % in 2050 (Nagl et al. 2011, and EWI et al. 2010).

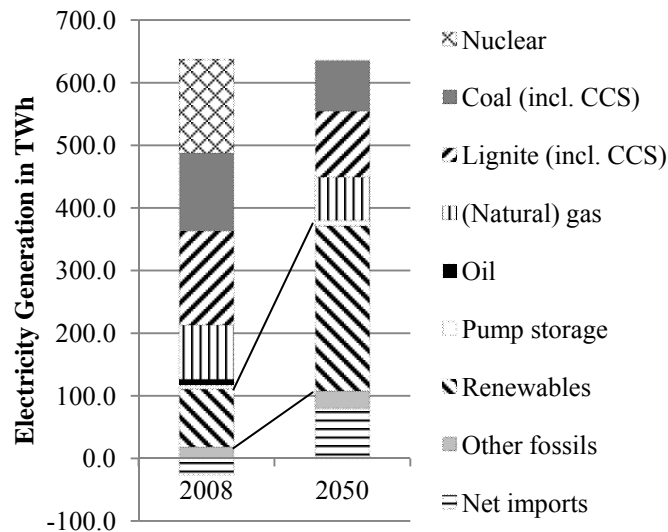

**Fig. 1.** Electricity generation in Germany in 2008 and 2050 by fuels in TWh. Source: EWI et al. (2010)

This increase in power generation from renewable sources, together with the trend to heat driven<sup>1</sup> domestic combined heat power plants (CHP), leads to a higher feed-in of “uncontrolled” electricity generation in the lower voltage grid levels (distribution grid). Beside these challenges a significant share of electric vehicles (EV) on the passenger car fleet in 2030 is highly probable (Pehnt et al.

<sup>1</sup> Currently, most domestic combined heat power plants are heat driven – their operation time depends on the heat demand of the household and not on the electricity demand.

2011). This leads to a further increase in electricity demand (energy and power) – especially during peak hours and, again, on the low voltage grid (Pollock et al. 2009). Hence, on the one hand a more complex energy supply can be observed, and on the other hand an increased electricity demand with higher peak loads in the evening hours is expected.

However, a modified charging process of electric vehicles might help to tackle these challenges: (1) by controlled unidirectional charging and (2) by controlled bidirectional charging (Kempton and Tomić 2005b). This allows reversing the previously unchanged principle of energy economics, which states that electricity supply usually adjusts to the more or less price-inelastic electricity demand. With the price-elastic charging of electric vehicles, however, the electricity demand becomes more variable and helps to adjust the electricity demand to the inflexible but volatile future electricity supply with a high share of renewable energy.

The structure of this paper is as follows: Chapter two introduces the issue. Chapter three illustrates an answer to these challenges in terms of the demand side management (DSM) approach. This gives an incentive to charge electric vehicles whenever the energy system contains “abundant” electricity. In order to assess the corresponding profitability, the related costs are estimated, which contains battery depletion costs and other related costs of electric vehicles to offer auxiliary services to the grid (including vehicle to grid – V2G). These costs are estimated in chapter four, which ends with a competitiveness assessment of vehicle to grid to other storage technologies. Chapter five concludes.

## **Challenges**

When considering the challenges in the energy system of tomorrow, the question remains whether electric mobility is boon and bane for these developments. Obviously, electric vehicles generate an additional energy demand within the low voltage grid, which is at the same time less time critical than the usual electricity demand of households (see below). The additional load might lead to shortages within the grid. Currently, two solutions are seen to prevent the lower voltage grid levels from this hazard:

- Grid extensions, which are however expensive and time consuming due to local acceptability, and
- Smart grids, in terms of demand side management (DSM) with local storage technologies (e. g. batteries).

## Impact on the grid

In Germany four different grid levels can be distinguished (Mez 1997): The 380 kV grid level, the transmission grid, is responsible for the national balancing of electricity and serves as feeding point for most conventional power plants (see Figure 2). The distribution grid on 110 kV and 10 or 20 kV level distributes electricity within a given region and delivers electricity to industrial consumers. The low voltage grid (in Germany usually 0.4 kV) gives access to private households. This transformation results due to the fact that the Ohmic resistance decreases quadratically with higher voltage by constant transport capacity.<sup>2</sup> Hence, for longer distances a transformation to high voltage is reasonable.

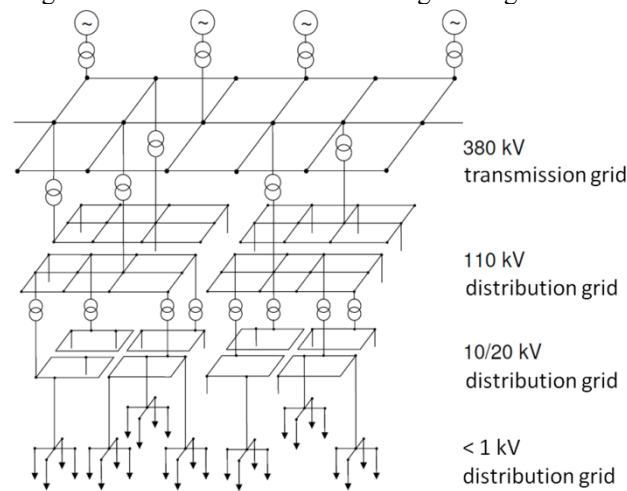
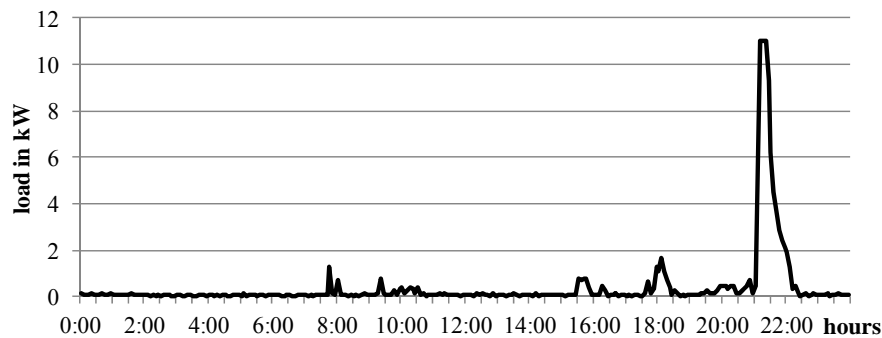

Fig. 2. Different grid levels in Germany (Oswald 2009)

The charging of a single electric vehicle is generally located in the low voltage distribution network. The charging process of an electric vehicle at home with 11 kW is displayed in the Figure 3. The exemplary, but empirical, load curve of this single household over the period of one day shows the load of an electric vehicle between 9 pm and 10:15 pm. The charging of the electric vehicle nearly doubles the household electricity consumption of this day and triples the peak power. Considering, that there could be several electric vehicles charging uncontrolled in the neighborhood on that evening, there will be an overload at the local transformer due to the simultaneity of this high load peaks. A local power outage might be the result. Unfortunately, the prediction of this hazard is complex as the spatial probability for electric vehicle penetration rates differ strongly and German low voltage grids are rather heterogeneous (Stöckl et al. 2011). In some

<sup>2</sup> The corresponding formula is  $P_v = 3 \cdot R \cdot \frac{p^2}{U^2}$ .

grid areas, especially in cities, the average load per household is very low – sometimes even below 1.2 kW (Pollok et al. 2010). Nevertheless, most current low voltage grids seem to cope with the additional load of normal distributed charging in the evening hours and the forecasted penetration rates of electric vehicles. From the current perspective the high penetration rate of domestic photovoltaic systems (with per se high simultaneity) in Germany seems to be more challenging.

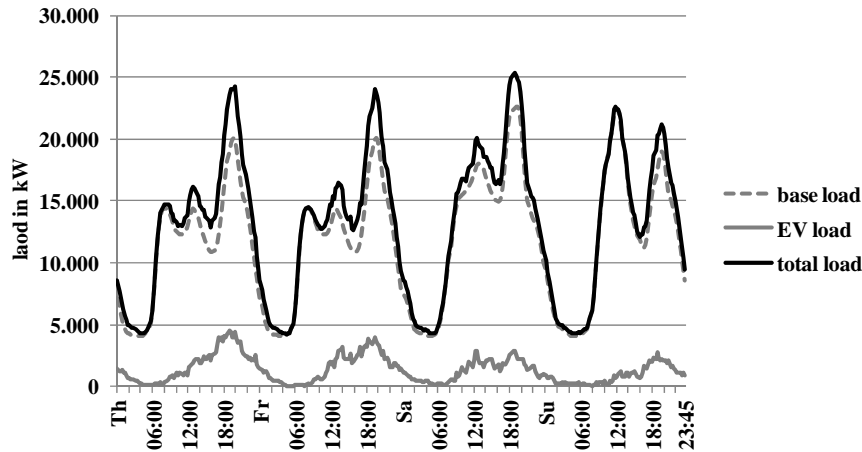

**Fig. 3.** Household load curve with an electric vehicle charging at 9 p.m. (own source)

Looking at higher distribution network levels, the situation is similar. Kaschub et al. (2010) analysed the impact within a representative urban grid in Germany supplying 25,000 households on the 10 kV level. A penetration rate of 100 % electric vehicles without special charging infrastructure and instant charging at 3.5 kW would lead to a significant load increase, particularly in the evening hours (cf. Figure 4).<sup>3</sup> With regard to the infrastructure, transformers seem to be a bottleneck for the German low voltage grid, especially for high charging rates (Pehnt et al. 2011). These effects do highly depend on the network design and its number of households (Stöckl et al. 2011).

---

<sup>3</sup> This is confirmed for many other countries by other studies e. g. Göransson et al. (2009), Davies and Kurani (2010), Waraich et al. (2009), Weiller (2011), Hartmann and Özdemir (2010), Vliet et al. (2011), or Leitinger and Litzlbauer (2011).



**Fig. 4.** Load curve of an urban district with uncontrolled electric vehicles charging. (Kaschub et al. 2010)

In the transmission network, the impact of electric vehicles is rather low due to the relatively little additional electricity demand compared to overall electricity consumption – this is also true for the power plant portfolio (Heinrichs et al. 2011 and Pehnt et al. 2011). However, other political framework conditions, e. g. the increasing volatile electricity supply by renewable energies, in particular wind, have a much stronger impact on the transmission grid (e. g. DENA 2005 and 2010).

The previously offered solution for bottlenecks in the electricity grid was to expand the current grid, which is however laborious and costly (DENA 2010; BDEW 2011). This results not only from the technical costs, but equally from the local resistance of the population. In the following, we therefore concentrate on the new demand side management approach – even though both approaches do not exclude each other.

### ***Smart grid and demand side management (DSM)***

Smart grids, with direct communication between energy supplier and consumer, allow optimizing the coordination of electricity demand and supply in an efficient manner. This includes demand side management approaches influencing the electricity user to adapt its electricity demand over time: e. g. through dynamic tariffs (see Hillemacher et al. 2011). The potentials in average households are usually small due to the users' low price elasticity. However, electric vehicles increase these potentials substantially: the energy consumption in an average household will almost double and the parking time is by far long enough to allow



a load shift without constraining the users. Hence, if users allow automatic delayed charging, the increase of peaks can be avoided ('peak shaving') and, additionally, the low electricity demand during the night can be increased, which leads to an increased efficiency of baseload power plants ('valley filling') (cp. Figure 5). Even more, in stormy nights a significant share of superfluous electricity in the grid could be absorbed by electric vehicles.

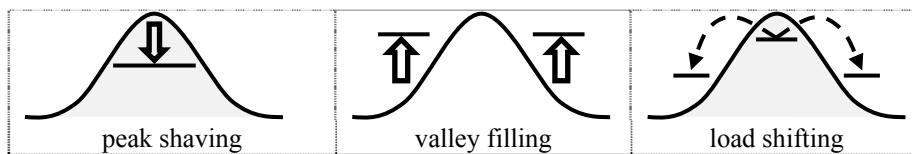

**Fig. 5.** Selected demand side management strategies

The degree of freedom and the effectiveness of demand side management can be enhanced by implementing stationary storage systems in the distribution grid. This is an alternative to vehicle to grid, but could be more expensive, since the battery is only used for storing electricity.

Hence, with demand side management a reduction of the load is feasible, but does not fully replace the grid extension approach – especially in regions where load shift potentials and its acceptability are small.

Demand side management can be implemented by highly complex and intelligent domestic control boxes (smart grid technologies), or alternatively initially by the already implemented basic technology ripple control (a price signal from the electricity provider through the low voltage grid) as e. g. used for night storage heating. The significant load shift potential by electric vehicles might help to overcome the challenges in the future energy system. However, from a socio-demographic view, this potential is highly uncertain. Users might not allow any external control or only use instant-charging for maximum flexibility. Therefore, the technical potential is significantly influenced by personal constraints, which are hardly predictable. Even though some first questionnaires about the participation of demand side management with electric vehicles already exist (e. g. Bunzeck et al. 2011, Paetz et al. 2011), experience in the real environment is still missing.

### ***Load shift potentials***

Defining the load shift potential (LSP) of electric vehicles is not as trivial as it seems. For one electric vehicle it is rather straight forward: The car arrives with a certain state of charge (SoC) of its battery and a certain future point in time, where it will depart again with a certain desired state of charge. In between the charging process can be allocated arbitrarily – respecting the user requirements. For several electric vehicles with different arriving and departing times as well as charging rates and state of charge, the issue is getting complex.

To allow a simple estimation, we assumed two extreme behaviors that are idealized in the following:

- recharging the battery as fast and as much as possible, and
- recharging the battery as late and as little as possible.

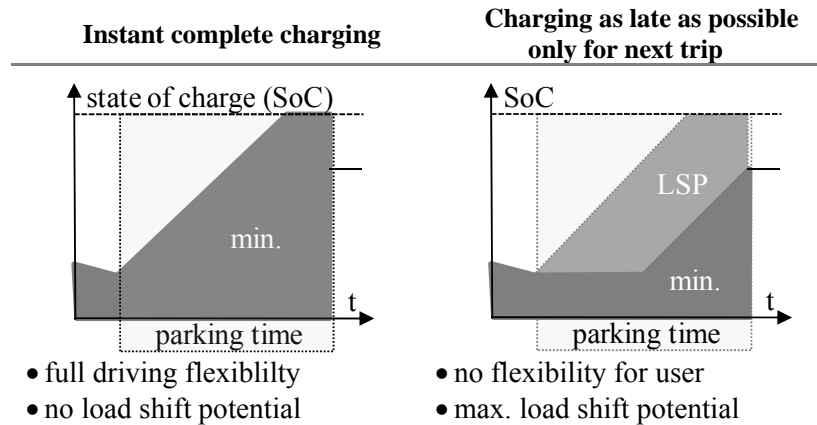

**Fig. 6.** Extreme charging strategies to estimate the load shifting potentials (LSP) of electric vehicles

The first charging strategy leads to an always fully charged battery and therefore highest flexibility, but at the same time no load shifting potential. The second charging strategy allows the maximum load shifting potential but no flexibility in using the car unexpectedly earlier or for a longer distance (cf. Figure 6). Both strategies might be seldom and real-life behavior will be somewhere between these extremes.<sup>4</sup>

With these two extreme charging strategies it is possible to generate fictive charging curves during one week, based on the representative trip data of current passenger cars from the study Mobility in Germany 2008 (infas and DLR 2008). From the study database we selected all single car trips in German city districts together with the arrival and the following departing time, as well as the required energy resulting from the last and following trip<sup>5</sup>. Furthermore, we assumed an average battery capacity depending on the car segment, a charging rate of 3.5 kW and that vehicles are plugged-in whenever they are parked at home. The resulting sum of all electric vehicles load shift potentials shows the maximum technical load shift potential based on our assumptions and is indicated with the blue area in Figure 7. It shows a theoretical load shift potential of 40 % to 90 % of the available battery capacity depending on the time and day of week. During the

<sup>4</sup> Especially for the second strategy an instant charging to a certain state of charge (SoC) might be meaningful (e. g. to guarantee a trip to the next hospital).

<sup>5</sup> We assumed average electricity consumption depending on the car segment (small, medium, large).

night, the potential is greatest and during midday lowest. The green line shows the theoretical minimum state of charge required to accomplish all trips. In reality this minimum line would be higher, and, hence, the real load shift potential smaller.

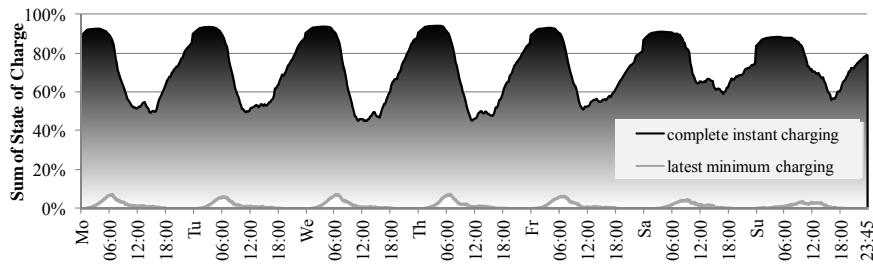

own calculations based on data from Infas and DLR (2008)

**Fig. 7.** Technical load shift potential of the electric vehicles fleet

Other studies on load shifting potentials confirm our results (Göransson et al. 2009, Waraich et al. 2009, Davies and Kurani 2010). However, the real load shifting potential might strongly differ from these calculations and depends on the acceptance of the customer and the underlying smart charging principle, which is explained in the following.

## Smart charging

The technical possibilities for smart charging depend on the one hand on the charging infrastructure at the parking places, and on the other hand on the information and communication technologies (ICT) implemented. Without special charging infrastructure the communication and billing requirements have to be inside the car. In case of charging stations with implemented smart charging capabilities, this equipment has to be located there. Furthermore, a communication between the charging station and the car is mandatory. These communication capabilities are still in standardization process (DIN IEC 62196).

Depending on the existing infrastructure three main charging scenarios can be defined:

- Charging only at the household plug at home, i. e. in Germany at 3.5 kW
- Charging only at home and at the workplace at e. g. 3.5, 11 or 22 kW
- Charging everywhere with up to 43 kW.

Moreover, the operator of smart charging is not defined yet. This may be the power transmission system operator (TSO), the power distribution system operator (DSO), or another stake holder, e. g. a third entity representing the objectives of

the utilities. Depending on the objective for smart charging, each operator might have advantages and disadvantages.

Additionally, there are several possibilities to implement the smart charging process. There could be a binding control signal like the already mentioned ripple control for night storage heating, or a voluntary incentive scheme. Dynamic tariffs, which are currently of high interest in research, mainly focused on time variable tariffs, are promising representatives. An already existing dynamic tariff is the Time of Day (TOD) price (e.g. HT/NT-tariff in Germany) with two fixed levels, one for the daytime and one for the nighttime.

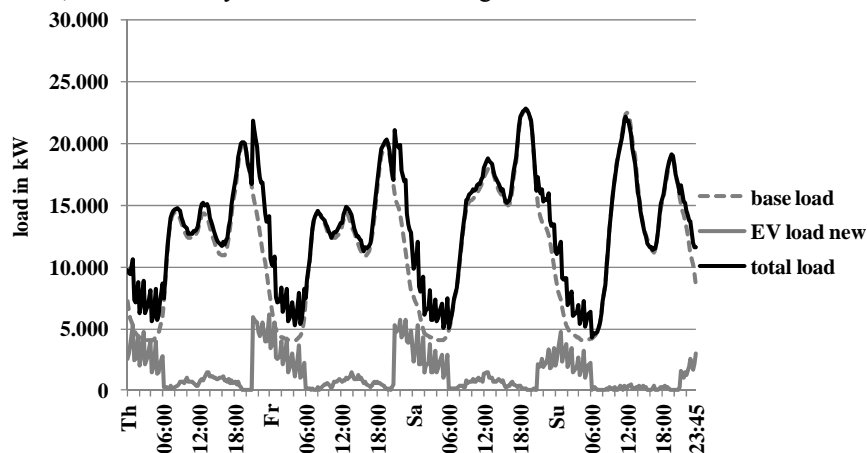

**Fig. 8.** Load curve of an urban district with controlled electric vehicles charging. (Kaschub et al. 2010)

Simulations show that smart charging principles help to avoid increasing load peaks of uncontrolled charging and to raise the low electricity demand during night time (valley filling). Comparing Figure 8 with Figure 4 shows how the smart charging scenario in an urban district with low electricity prices during the night leads to significant load shifts into cheaper night time, and hence fulfills the principles of peak shaving and valley filling (cf. Kaschub et al. 2010). In order to prevent a charging peak at the price leap at 9 p.m., the cars are divided into early, later and latest charger.

Hence, through smart charging of electric vehicles the electricity grid is released and the supply side of the market gains stability. But is this profitable for the vehicle user? For this the user might ask whether the spread of the dynamic tariff is sufficient to cover the following costs:

- the implementation costs of the information and communication technologies infrastructure (i. e. smart meter), and
- the additional degradation of the battery (which can be neglected as far as the maximum charging rate remains equal).

The following example should illustrate these considerations: In average about 3,000 kWh/a charging energy per car seems realistic<sup>6</sup>. Assuming that charging at 15 ct/kWh instead of 25 ct/kWh is always possible, which leads to savings of 300 €/a. The costs for charging infrastructure at home are between 150 and 350 € and communication hardware at max. 100 € (Kley 2011). Hence, while investing<sup>7</sup> less than 100 €/a, the car user can benefit from a considerable revenues of about 300 €/a. This confirms the results from Szczechowicz et al. (2011). Therefore, the economic question does not seem to be the obstacle in order to cut the high technical potential for load shifting through smart charging (see above) in praxis – its acceptance, however, is still vague (Paetz et al. 2011).

In using the battery of the car not only as energy storage for mobility, but also for the grid, is referred as “Vehicle to Grid” (V2G). It includes on the one hand side that not only the charging time and charging rate is controlled, but alike the discharging (and hence feeding back into the grid) to allow optimal and cost-efficient grid stability. On the other hand side the mobility autonomy of the vehicle owner is further reduced. Moreover, the additional battery use accelerates its degradation, which might lead to extra costs if an additional battery replacement during the vehicle’s life time is required.

## **Storage technologies in comparison to vehicle to grid**

In the past, energy storage in the power grid was mainly accomplished by pump storage power plants. Only few compressed air energy storage power plants (CAES) or stationary battery storage systems (BESS) are in operation (e. g. EAC 2011). These alternatives operate either as demonstration projects or in special system setups. The economic competitiveness of these storage systems is dependent on several parameters. Use cases reach from long term storage for up to several weeks, down to short term storage for only several minutes or seconds, which has a significant impact on the number of cycles and hence on the costs and potential benefits of these technologies. When calculating business cases for vehicle to grid it is inevitable to know the alternatives available: Where other technologies are more economically efficient, vehicle to grid will not be applied. Therefore, in the following a short introduction in alternative technologies is given.

---

<sup>6</sup> In Germany the average mileage of a car is 12 500 km and the average consumption of battery electric vehicles is about 0.24 kWh/km, which results in a required energy of 3 MWh/a.

<sup>7</sup> In general the depreciation time for vehicle investment in Germany is six years (BMF 2000).

## Overview of storage technologies

The storage technologies can be classified in energy and power storage technologies or based on its physical storage technique (mechanical, electrical, electric-chemical, etc.). This classification is done based on parameters that are listed in Table 1. The specifications often include a broad range and indicate that the listed storage type is representing a couple of subgroups.

Table 1. Characteristics of different power and energy storage technologies

Type	Cycles	E-Density in Wh/kg	P-Density in W/kg	Invest in EUR/kWh	self- discharge
Pump storage	very high	~ 1	–	600 – 3k	Low
CAES	very high	2 kWh/m <sup>3</sup>	–	400 – 800	Low
Lead-Acid	< 1k	20 – 30	80 – 300	100 – 250	low
NiMH	eq. Li-ion	50 – 80	200 – 1.5k	750 – 1.5k	high
Li-ion (HE)	2.5k – 7.5k	120 – 180	80 – 300	450 – 1.2k	low
Li-ion (HP)	2M – 5M	60 – 140	200 – 2k	1k – 2k	low
Ultracapacitors	500k – 2M	2.2	1.4k	1k – 2k	high
Flywheels	>5M	3.7 – 11.1	180 – 1.8k	4.5k – 5k	high
NaS	1.5k – 4.5k	90 – 110	100 – 120	250 – 3k	low
Redox-flow	5 – 15k	20 – 65	–	300 – 1k	low

CAES – Compressed Air Energy Storage; HP – High Power; HE – High Energy

source: IIP (2011)

Table 1 shows, that the Li-ion high energy (Li-ion HE) technology has no outstanding parameter compared to other technologies. This indicates that the combination of the parameters is decisive. For Li-ion batteries especially the combination of energy density, price projection and usability in large battery packs make them interesting for mobile devices and vehicles.

Pump storage power plants remain the most efficient large storage system due to their high cycle capability and therefore unrivalled low specific energy costs (3.5 ct/kWh, VDE 2008), combined with very low self-discharge for stationary applications. But the geographical requirements limit capacity extension. Nevertheless, several projects are in planning for the coming years (e. g. Deane et al. 2010). Only for flat landscapes other technologies could be advantageous in the near future when transmission grid capabilities are insufficient. In the following, we outline the vehicle to grid approach to allow a more sophisticated comparison between vehicle to grid and pump storage thereafter.

### ***Relevant markets for vehicle to grid (V2G)***

If the number of electric vehicles (and especially battery electric vehicles) does further increase, the vehicles, while plugged-in, can be interpreted as a large virtual electricity storage system. This requires a bidirectional electricity link and an intelligent management system for all plugged-in electric vehicles. If one million electric vehicles are assumed, an average available battery capacity of about 10 kWh per electric vehicles leads to a storage capacity of 10 GWh – which is about the capacity of two large pump storage power plants. The corresponding capacity amounts to 3.5 GW (or 22 GW for 22 kW charging) respectively – more than three large power plants at nominal load. But, would this storage for electricity with electric vehicles batteries be competitive to other technologies? Is the acceptance of vehicle to grid assured? In order to give an answer to the techno-economic question of profitability, two issues are relevant:

1. the potential gain through vehicle to grid, which is highly dependent on the time-specific (without usage) and the usage-specific depletion cost of the battery, and
2. the electricity prices and storage requirements from the grid perspective.

Furthermore, the additional costs for the infrastructure (components for the bidirectional link) are to be defined.

(1) The corresponding costs of the battery highly influence the profitability within these markets. Due to little experience with this fast developing technology a well-founded cost estimate is highly unlikely – especially for the given context (battery type, usage etc.). Nevertheless, first estimates are used in the chapter below to allow a preliminary forecast of the relevance of vehicle to grid in the future electricity grid.

(2) Electricity storage technologies can participate mainly in two different markets:<sup>8</sup>

- a. Short-term electricity trading market (in particular day-ahead and intraday market).
- b. Control reserve markets for stabilizing the grid if electricity supply or demand deviates from its forecast at short notice.<sup>9</sup>

The corresponding requirements for the markets and therefore the resulting chances for each technology, differ strongly. The participation within the short-term electricity trading market (a) is rather a future opportunity for vehicle to grid: Only a huge share of volatile and non-controllable wind energy makes an integration of this technology into the day-ahead market reasonable. The great

---

<sup>8</sup> Other relevant use cases could be focused on the own household or a micro-grid, where no market is influenced and the benefit is localized in the own household or community.

<sup>9</sup> In Germany, however, it is currently not possible to integrate the vehicles due to the organizational and technical requirements. E. g. the smallest bid is 5 MW (Regelleistung 2011)

amounts of energy and long-time horizons require a huge number of highly reliable participating car owners, as well as a good knowledge of the trip scheduling: If by chance one day all participants make a long trip, the storage capacity would be zero – even though this is not a very likely scenario (see Kaschub et al. 2011). Nevertheless, the control reserve market (b) seems much more convenient, as its advantage is twofold: Less energy and power is required and even the provision of capacity is funded (“procurement fee”). E. g. the current average retrieved capacity in the German secondary control reserve (SCR) market is about 450 MW (Regelleistung 2011) – less than half of a large power plant at nominal load<sup>10</sup>. Hence, due to the procurement fee and energy price, a certain amount of parked and plugged-in vehicles lead to a decrease in the average electricity costs for each participant.

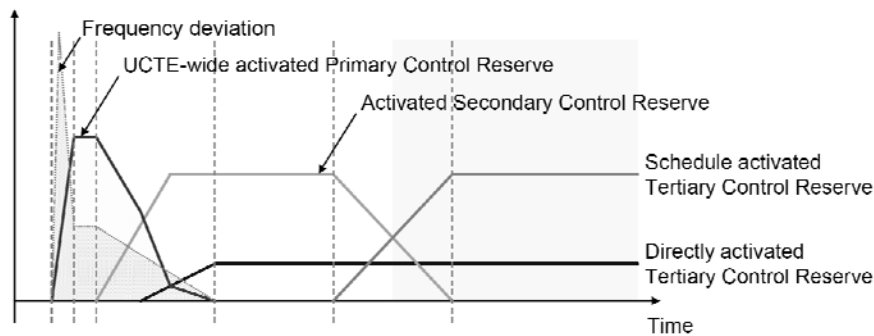

**Fig. 9.** Principle frequency deviation and subsequent activation of control reserves (UCTE 2009)

Besides the SRM two other reserve markets are implemented: The UCTE-wide primary and the tertiary control reserve market (see Figure 9) (UCTE 2009). In case of instable frequency within the grid, first (within seconds) the primary control reserve (provided directly within the power plant) is automatically activated to provide positive or negative power reserve. After about half a minute, other storage technologies with longer ramp-up times can undertake this operation within the secondary control reserve (e. g. pump storage power plants). Thereafter the tertiary control reserve has to take over for up to several hours, which is in general achieved by additional power plants. Due to the smaller electricity demand in the tertiary control reserve (BNetzA 2011:108ff), this market is not considered at this stage, but could also be relevant for vehicle to grid in the future. In the following we concentrate on the secondary control reserve.

<sup>10</sup> The average weekly energy provided is about 80 GWh (Regelleistung, 2011) with a potential capacity offer of 3.2 GW (Regelleistung, 2011).



## A techno-economic analysis of vehicle to grid competitiveness

Today the usage of existing Li-ion batteries seems far from being competitive in the energy storage market. But the increasing need for electricity from the control reserve market might lead to rising electricity prices and together with the declining costs of Li-ion batteries (RB 2010) the situation might change significantly in the future.

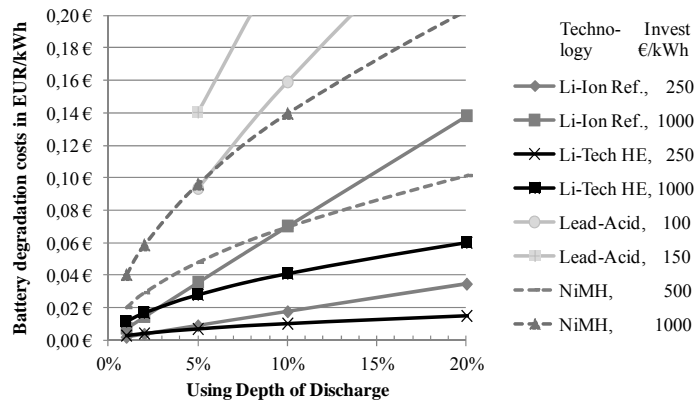

own calculations based on (Kalhammer et al. 2007; Pesaran 2007; Schäfer 2009; Barensee 2010)

**Fig. 10.** Minimum battery degradation costs depending on the depth of discharge

As depicted above, the costs for electricity storage in automotive Li-ion batteries consist of time-specific (without usage) and the usage-specific depletion costs of the battery. The time-specific costs depend on the depletion due to aging of the battery and the self-discharge rate. The usage-specific costs depend on the depletion due to its usage and the corresponding conditions (temperature, depth of discharge (DoD), number of cycles, charging rate (C-rate), etc.). Figure 10 illustrates the bandwidth of specific prices of some current battery technologies depending on the applied depth of discharge. The Li-ion batteries seem unrivalled at these low DoD, but have a broad price-range from 0.01 to 0.14 €/kWh.

To allow a first estimation of the competitiveness of vehicle to grid, we illustrate a simple and optimistic calculation in the following, assuming an average vehicle battery of 20 kWh and investments of 8,000 € (Kalhammer et al. 2007). Time-specific costs depend mainly on the DoD. For the use-specific cost of the battery with 400 €/kWh specific investment costs<sup>11</sup> and 20 % DoD a price of

<sup>11</sup> Today prices for Li-ion batteries are more likely at 600 €/kWh (Jochem et al. 2011), although severe data is not given.

0.05 €/kWh can be derived from Figure 10.<sup>12</sup> Other (ICT) hardware system costs amount to about 500 € (see Kley 2011), which equals about 85 €/a.

After having identified the underlying costs, we now focus on the identification of possible revenues in the secondary control reserve market. The secondary control reserve market is characterized by an erratic demand. In Figure 11 an example is given for an arbitrary week in the German secondary control reserve market. The demand of positive reserve capacity is changing from zero up to 3 GW (Regelleistung 2011). Most of the time the demand is at low capacity: 70 % below 100 MW, 90 % below 500 MW, and less than 5 % of the time above 1,000 MW. The amount of energy within the positive reserve amounts to 30 GWh in this week. Within regional markets the quotation is even more erratic. An example is the region within the EnBW grid, where almost no positive secondary reserve was requested in the week between July 18<sup>th</sup> and 24<sup>th</sup>, 2011.

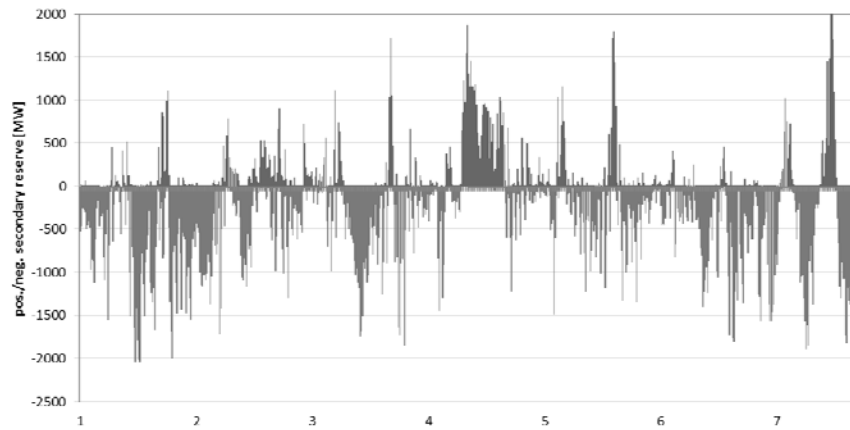

**Fig. 11.** Released secondary control reserve energy in Germany from October 24th to 30th 2011. (Regelleistung 2011)

Because negative secondary reserve energy can also be provided through controlled unidirectional charging, the following calculation focuses on the revenues with positive reserve energy provided through vehicle to grid. At first glance, providing 2 GW of peak power, about 600.000 electric vehicles with a 3.5 kW charging rate seem to be sufficient to supply the required power. On second glance however, the amount of vehicles is far too small with respect to the requested energy. If we still assume a provision of 20 % DoD for average 20 kWh traction batteries for vehicle to grid services in the considered time period, we would need about 5 million plugged-in vehicles (12 % of German passenger car fleet). In reality these numbers should be much higher in order to guarantee the

<sup>12</sup> The C-rate is neglected here, as charging rates at 3.5 kW are much lower compared to usual driving cycles and thus causes hardly any additional costs. Other additional costs are not measurable or not known yet.

grid services and allowing unforeseen trips at the same time. Assuming a supply of 2 GW with an average price of 1,000 €/MW (per week) for procurement<sup>13</sup>, plus an energy price of about 130 €/MWh (Regelleistung 2011), the resulting revenue with a demand of 1.5 TWh reserve energy per year would amount to 5.75 million € per week, which equals (in an optimistic calculation) to 1.20 € per vehicle and week, or about 60 € per vehicle and year.

The corresponding costs can be calculated in assuming the 85 € p.a. depicted above for the required hardware and the battery depreciation costs of 50 €/MWh. Together with the required fleet of 5 million vehicles the costs per vehicle and year are

$$85 \text{ €} + \frac{(1.5 \text{ TWh} \times 50 \frac{\text{€}}{\text{MWh}})}{5,000,000 \text{ EV}} = 100 \frac{\text{€}}{\text{a}}. \quad (1)$$

The corresponding revenues per vehicle and year amount to

$$\frac{1.5 \text{ TWh} \times 130 \frac{\text{€}}{\text{MWh}} + 1,000 \frac{\text{€}}{\text{MW}} \times \frac{365}{7} \times 2 \text{ GW}}{5,000,000 \text{ EV}} = 59.86 \frac{\text{€}}{\text{a}}. \quad (2)$$

Consequently, the resulting profit of this estimation is negative (40 € per vehicle and year).

Hence, vehicle to grid for positive reserve energy in the German secondary control reserve market seems not to be profitable today. We should, however, keep in mind that the underlying prices are highly volatile and might develop in the coming years in favor of vehicle to grid (e. g. decreasing battery costs and increasing market prices in the secondary control reserve market). Furthermore, if we assume a longer lifetime of the battery than the vehicle, the depreciation price of the battery is zero. This would lead to a smaller loss of about 25 € per vehicle and year. In conclusion we might say that vehicles with low mileage but “overdesigned” batteries may be dedicated to provide ancillary services in the future, when battery prices are lower and market prices higher.

Other studies confirm our results. E. g. Dallinger et al. (2011) concludes that under today’s condition in Germany vehicle to grid is only profitable for primary control and negative control reserve in the secondary control reserve and tertiary control reserve markets, whereas it is not profitable for positive control. However, according to Kempton and Tomić (2005a), vehicle to grid with ancillary services has been already profitable in the US in 2005. This was confirmed by Tomić and Kempton (2007) for the electric vehicle “Think City”, using different charging rates.

---

<sup>13</sup> The procurement period is reduced from one month to one week per bid, since June 2011. Price fluctuation is still very high and prices between 800 and 1500 are common; but deviations thereof in both directions numerous. This volatility holds equally for the energy price.

Furthermore, Hill et al. (2012) showed for an extended-range electric vehicles (EREV) fleet with a sensitivity analysis of the influencing factors on profitability of vehicle to grid in the US reserve market, that the significance of each variable differs and is strongly case specific. In their analysis they show – despite the uncertainties in technical and market development – two profitable market conditions.

Another possibility to evaluate the economy of market participation is the comparison to other storage technologies. For short term storage applications in the transmission grid (about one cycle per day) the competitor technology is pump storage. The specific costs for pump storage are between 0.03 and 0.04 €/kWh (VDE, 2008). These costs can be compared to the battery usage costs through additional degradation (Figure 10). When only 20 % DoD are assumed with investment of 600 €/kWh, the costs are between 0.05 and 0.08 €/kWh. The battery technology is therefore obviously not economic nowadays – but at the same time in a similar league with other storage technologies. Through intensive research and innovation in Lithium-ion technology (RB, 2010), a cost development down to 250 €/kWh<sub>invest</sub> is realistic before 2030 (which is a target for the *Competence E* research project at KIT). This leads, together with the assumption of 20 % DoD, to costs of 0.02 to 0.04 €/kWh, which enables a profitable application. Increased cycle stability can reduce these costs further below 0.02 €/kWh. In this case the Li-ion technology is competitive to pump storage.

## Conclusions

This paper outlines the impact of electric vehicles on the power grid – especially the impacts on different grid levels are outlined, with lower grid levels seeming to be the most challenging. Especially the contribution to an increased load peak in the evening hours is seen as a drawback in the energy system. Two possible solutions are: (1) grid extensions or (2) demand side management approaches. Within the latter we indicated, that the load shift potential of private households multiplies, if the household owns an electric vehicle. The average German household would roughly double its energy demand and even more than triple its power demand (when using faster charging rates). The high load shift potential derives from the high power flexibility, comprehensive energy storage possibilities (batteries) and long parking times of more than 12 h at home or even 23 h per day on all parking sites. This, together with the fact that most charging processes will occur in the evening, where already today a peak in the lower grid levels is observed, turns a delayed charging of electric vehicles to an essential milestone for a successful electric vehicles market penetration.

In order to give a short contribution to the ongoing discussion on vehicle to grid, we estimated potential profits of vehicle to grid in the current German secondary control reserve market for positive control reserve. It has been shown

that in the current market situation vehicle to grid is not competitive. But several assumptions affect the results of the calculation considerably such as battery costs, battery lifetime (which particularly depends on the number of cycles and depth of discharge), costs for vehicle to grid infrastructure, market prices, as well as market and regulatory conditions.

In the future market, the increasing non-controllable volatility in German electricity generation might (even with simultaneously improved weather forecasts) raise the demand in the reserve market, and hence lead to an increasing market price. Furthermore, from the current perspective it seems that the number of electric vehicles will increase and the battery costs will decline. This might lead to increasing vehicle to grid profits in the future.

Besides these economic constraints however, legal aspects, user's acceptance, the reliability (of thousands of electric vehicles) as well as the future technical development, make profits of vehicle to grid still uncertain in the future electricity system. Yet, a controlled charging is necessary to allow high penetration rates of electric vehicles without jeopardizing the low voltage grid and to foster higher shares of renewable electricity generation. Hence, controlled charging converts electric mobility from a gatecrasher to a welcome guest.

## References

- Barenschee, E.R. (2010). Energiespeicherung und Lithium-Ionentechnologie. Proceedings of *Senior Expert Chemists Annual Meeting*. Bitterfeld.
- BDEW (German Association of Energy and Water Industries) (2011). *Abschätzung des Ausbaubedarfs in deutschen Verteilungsnetzen aufgrund von Photovoltaik- und Windeinspeisungen bis 2020*. Berlin.
- BMF (German Federal Ministry of Finance) (2010). *AfA-Tabelle für die allgemein verwendbaren Anlagegüter*. Bonn.
- BMU (Federal Ministry for the Environment, Nature Conservation and Nuclear Safety) (2010). *Langfristszenarien und Strategien für den Ausbau der erneuerbaren Energien in Deutschland bei Berücksichtigung der Entwicklung in Europa und global – „Leitstudie 2010“*. Berlin.
- BNetzA (German Federal Network Agency) (2011). *Monitoringbericht 2011*. Bonn.
- Bunzeck, I., Feenstra, C.E.J., & Paukovic, M. (2011). Preferences of potential users of electric cars related to charging – A survey in eight EU countries. *Deliverable D3.2 of the Grid for Vehicles Project* within the FP7 program of the European Commission. Brussels.
- Dallinger, D., Krampe, D., & Wietschel, M. (2011). Vehicle-to-Grid Regulation Reserves Based on a Dynamic Simulation of Mobility Behavior. *IEEE Transactions on Smart Grid* 2(2), 302–313.
- Davies, J., & Kurani, K.S. (2010). Households' Plug-in Hybrid Electric Vehicle Recharging Behavior: Observed variation in households' use of a 5kWh blended PHEV-conversion. Institute of Transportation Studies, University of California, Davis, *Working Paper UCD-ITS-WP-10-04*.
- Deane, J.P., Gallachóir, B.P.Ó., & McKeogh, E.J. (2010). Techno-Economic Review of Existing and New Pumped Hydro Energy Storage Plant. *Renewable and Sustainable Energy Reviews* 14, 1293–1302.

- DENA (German Energy Agency) (2005). *Energiewirtschaftliche Planung für die Netzintegration von Windenergie in Deutschland an Land und Offshore bis zum Jahr 2020* (DENA Netzstudie 1). Berlin.
- DENA (German Energy Agency) (2010). *Integration of Renewable Energy Sources in the German Power Supply System from 2015- 2020 with an Outlook to 2025 – dena Grid Study II*. Berlin.
- EAC (Electricity Advisory Committee) (2011). *Energy Storage Activities in the United States Electricity Grid*. Washington, DC.
- EC (European Commission) (2011). *Proposal for the Directive of the European Parliament and of the Council on Energy Efficiency and Repealing Directives 2004/8/EC and 2006/32/EC*, SEC(2011) 779 final, 22/06/2011. Brussels.
- Erdmenger, Ch., Lehmann, H., Müschen, K., Tambke, J., Mayr, S., & Kuhnhenh, K. (2009). A climate protection strategy for Germany – 40 % reduction of CO<sub>2</sub> emissions by 2020 compared to 1990. *Energy Policy*, 37, 158–165.
- EWI (Institute of Energy Economics at the University of Cologne), GWS (Institute of Economic Structures Research), & prognos (2010). *Energieszenarien für ein Energiekonzept der Bundesregierung*. Basel, Cologne, Osnabrück.
- Göransson, L., Karlsson, S., & Johnsson, F. (2009). Plug-in Hybrid Electric Vehicles as a Mean to Reduce CO<sub>2</sub> Emissions from Electricity Production. Proceedings of *EV24*. Stavanger.
- Hartmann, N., & Özdemir, E.D. (2010). Impact of Different Utilization Scenarios of Electric Vehicles on the German Grid in 2030. *Journal of Power Sources*, 196(4), 2311–2318.
- Heinrichs, H., Eßer-Frey, A., Jochem, P., & Fichtner, W. (2011). Zur Analyse der langfristigen Entwicklung des deutschen Kraftwerkparcs – Zwischen europäischem Energieverbund und dezentraler Erzeugung. In: VDI-GET (Ed.), *Optimierung in der Energiewirtschaft*. Düsseldorf: VDI Publisher.
- Hill, D.M., Agarwal, A.S., & Ayello, F. (2012). Fleet Operator Risks for Using Fleets for V2G regulation. *Energy Policy*, 41, 221–231.
- Hillemacher, L., Eßer-Frey, A., & Fichtner, W. (2011). Preis- und Effizienzsignale im MeRegio Smart Grid Feldtest – Simulationen und erste Ergebnisse. Proceedings of *IEWT (Internationale Energiewirtschaftstagung)*. Wien.
- IIP (Institute for Industrial Production) (2011). *Internal Database of Electricity Storage Technologies*.
- Infas (Institute for Applied Social Sciences), & DLR (German Aerospace Centre) (2008). *MID – Mobilität in Deutschland 2008*. Berlin.
- Jochem, P., Feige, J., Kaschub, T., & Fichtner, W. (2011). Increasing Demand for Battery Applications. Proceedings of *6<sup>th</sup> International Renewables Energy Storage Conference and Exhibition*. Berlin.
- Kalhammer, F. R., Kopf, B.M., Swan, D.H., Roan, V.P., & Walsh, M.P. (2007). *Status and Prospects for Zero Emissions Vehicle Technology - Report of the ARB Independent Expert Panel 2007*. California Environmental Protection Agency – Air Resources Board, California.
- Kaschub, T., Mültin, M., Fichtner, W., Schmeck, H., & Kessler, A. (2010). Smart Charging of Electric Vehicles in the Context of an Urban District. *VDE Congress E-Mobility*. Leipzig.
- Kempton, W., & Tomić, J. (2005a). Vehicle-to-Grid Power Fundamentals: Calculating Capacity and Net Revenue. *Journal of Power Sources*, 144(1), 268–279.
- Kempton, W., & Tomić, J. (2005b). Vehicle-to-Grid Power Implementation: From Stabilizing the Grid to Supporting Large-Scale Renewable Energy. *Journal of Power Sources*, 144(1), 280–294.
- Kley, F. (2011). *Ladeinfrastrukturen für Elektrofahrzeuge*. Karlsruhe Institut für Technologie, Karlsruhe: Fraunhofer Publisher.
- Leitinger, C., & Litzlbauer, M. (2011). Netzintegration und Ladestrategien der Elektromobilität. *Elektrotechnik und Informationstechnik*, 128(1-2), 10–15.

- Mez, L. (1997). The German Electricity Reform Attempts: Reforming Co-optive Networks. In: A. Midttun (Ed.), *European Electricity Systems in Transition* (pp. 231–252). Amsterdam: Elsevier.
- Nagl, S., Fürsch, M., Paulus, M., Richter, J., Trüby, J., & Lindenberger, D. (2011). Energy policy scenarios to reach challenging climate protection targets in the German electricity sector until 2050. *Utilities Policy*, 19, 185–192.
- Oswald, B.R. (2009). Optionen im Stromnetz für Hoch- und Höchstspannung: Freileitung/Erdkabel, Drehstrom/Gleichstrom. Proceedings of *Netz-Event 14. Mai 2009: Freileitung / Erdkabel*.
- Paetz, A.-G., Dütschke, E., & Schäfer, A. (2011). Die Last mit der Lastkontrolle. *Energie & Management*, 12/2011, 19.
- Pehnt, M., Helms, H., Lambrecht, U., Dallinger, D., Wietschel, M., Heinrichs, H., Kohrs, R., Link, J., Trommer, S., Pollok, T., & Behrens, P. (2011). Elektroautos in einer von erneuerbaren Energien geprägten Energiewirtschaft. *Zeitschrift für Energiewirtschaft*, 35(3), 221–234.
- Pesaran, A. (2007). *Battery Choices and Potential Requirements for Plug-In Hybrids*. National Renewable Energy Laboratory (NREL), Plug-In Hybrid Electric Truck Workshop, Hybrid Truck Users Forum. Los Angeles.
- Pollok, T., Szszechowicz, E., Matrose, C., Schnettler, A., Stöckl, G., Kerber, G., Lödl, M., Witzmann, R., & Behrens, P. (2010). Electric mobility fleet test – Grid management strategies with electric vehicle fleets, VDE-Kongress 2010, Leipzig, Germany.
- Pollok, T., Dederichs, T., Smolka, T., Theisen, T., Schowe-von der Brellie, B., & Schnettler, A. (2009). Technical Assessment of Dispersed Electric Vehicles in Medium Voltage Distribution Networks. *CIREN*, 0887. Prague.
- RB (Roland Berger) (2010). *Electro-mobility – Challenges and Opportunities for Europe*. European Economic and Social Committee. Brussels.
- Regelleistung (2011). Own evaluation of data from *www.regelleistung.net* in the time period 12.07.11 until 11.12.11.
- Schäfer, T. (2009). Batterietechnologie: Trends, Entwicklungen, Anwendungen. Proceedings of *3<sup>rd</sup> Expert Forum Leipzig*. Leipzig.
- Szszechowicz, E., Pollok, T., & Schnettler, A. (2011). Economic assessment of electric vehicle fleets providing ancillary services. *CIREN*, 0967. Frankfurt.
- Stöckl, G., Witzmann, R., & Eckstein, J. (2011). Analyzing the Capacity of Low Voltage Grids for Electric Vehicles. *IEEE International Electrical Power and Energy Conference*. Winnipeg.
- Tomić, J., & Kempton, W. (2007). Using fleets of electric-drive vehicles for grid support. *Journal of Power Sources*, 168, 459–468.
- UCTE (Union for the Co-ordination of Transmission of Electricity) (2009). *Operation Handbook: Policy 1: Load-Frequency Control*. V3.0 rev15 01.04.2009. Brussels.
- VDE (German Association for Electrical, Electronic and Information Technologies) (2008). *Energiespeicher in Stromversorgungssystemen mit hohem Anteil erneuerbarer Energieträger – Bedeutung, Stand der Technik, Handlungsbedarf*. Power Engineering Society (ETG). Berlin.
- Vliet, O. van, Brouwer, A.S., Kuramochi, T., Broek, M. van den, & Faaij, A. (2011). Energy Use, Cost and CO<sub>2</sub> Emissions of Electric Cars. *Journal of Power Sources*, 196(4), 2298–2310.
- Waraich, R.A., Galus, M.D., Dobler, C., Balmer, M., Andersson, G., & Axhausen, K.W. (2009). Plug-in Hybrid Electric Vehicles and Smart Grid: Investigations Based on a Micro-Simulation. Proceedings of *12<sup>th</sup> International Conference on Travel Behaviour Research*. Jaipur.
- Weiller, C. (2011). Plug-in Hybrid Electric Vehicle Impacts on Hourly Electricity Demand in the United States. *Energy Policy*, 39, 3766–3778.

## Working Paper Series in Production and Energy

---

recent issues

- No. 1** Alexandra-Gwyn Paetz, Lisa Landzettel, Patrick Jochem, Wolf Fichtner:  
Eine netnografische Analyse der Nutzererfahrungen mit E-Rollern
- No. 2** Felix Teufel, Michael Miller, Massimo Genoese, Wolf Fichtner:  
Review of System Dynamics models for electricity market simulations
- No. 3** Patrick Jochem, Thomas Kaschub, Wolf Fichtner:  
How to integrate electric vehicles in the future energy system?



## Contact

Karlsruhe Institute of Technology

Institute for Industrial Production (IIP)  
French-German Institut for Environmental Research (DFIU)

Hertzstr. 16  
D-76187 Karlsruhe

KIT – University of the State of Baden-Wuerttemberg and  
National Research Center of the Helmholtz Association

Working Paper Series in Production and Energy  
**No. 3**, June 2013

ISSN 2196-7296

---

[www.iip.kit.edu](http://www.iip.kit.edu)