

Föllmer, J.

Article

Probabilistic model of divided conveyor belt to increase input performance of sorter feed systems

Logistics Research

Provided in Cooperation with:

Bundesvereinigung Logistik (BVL) e.V., Bremen

Suggested Citation: Föllmer, J. (2016) : Probabilistic model of divided conveyor belt to increase input performance of sorter feed systems, Logistics Research, ISSN 1865-0368, Springer, Heidelberg, Vol. 9, Iss. 1, pp. 1-10,
<https://doi.org/10.1007/s12159-016-0131-1>

This Version is available at:

<https://hdl.handle.net/10419/157729>

Standard-Nutzungsbedingungen:

Die Dokumente auf EconStor dürfen zu eigenen wissenschaftlichen Zwecken und zum Privatgebrauch gespeichert und kopiert werden.

Sie dürfen die Dokumente nicht für öffentliche oder kommerzielle Zwecke vervielfältigen, öffentlich ausstellen, öffentlich zugänglich machen, vertreiben oder anderweitig nutzen.

Sofern die Verfasser die Dokumente unter Open-Content-Lizenzen (insbesondere CC-Lizenzen) zur Verfügung gestellt haben sollten, gelten abweichend von diesen Nutzungsbedingungen die in der dort genannten Lizenz gewährten Nutzungsrechte.

Terms of use:

Documents in EconStor may be saved and copied for your personal and scholarly purposes.

You are not to copy documents for public or commercial purposes, to exhibit the documents publicly, to make them publicly available on the internet, or to distribute or otherwise use the documents in public.

If the documents have been made available under an Open Content Licence (especially Creative Commons Licences), you may exercise further usage rights as specified in the indicated licence.



<http://creativecommons.org/licenses/by/4.0/>

Probabilistic model of divided conveyer belt to increase input performance of sorter feed systems

J. Föller¹

Received: 31 March 2015 / Accepted: 1 February 2016 / Published online: 24 February 2016
© The Author(s) 2016. This article is published with open access at Springerlink.com

Abstract Maximization of input performance and throughput in sorting systems is a crucial interest of the industry. Due to self-impediment and mutual impediment at the input stage, a considerable reduction of throughput may occur. In this paper, a new design of a feeding system is discussed that addresses this deficiency, the divided conveyer belt (proposed by the author in 2003, patent DE 100 51 932 A). The new design is based on belt segments working at different, sequentially increasing speeds and takes into account ergonomic aspects to avoid worker fatigue. Based on a probabilistic model, that is the topic of this article, it will be argued that combined with sufficient spatial input variability the divided conveyer belt design substantially reduces the deficiency caused by mutual impediment and, consequently, increases input performance.

Keywords High-speed package sorter · Supply system (carrier) · Feed system · Feeder · Input performance · Increasing throughput

1 Introduction

The bottleneck of modern sorting systems is no longer found in the field of the physical distributor (sorter). The fluidic characteristic optimization of the supporting element (carrier) designs for discretely working sorter systems, in the CEP industry (courier, express, postal services), now allows sorting speeds up to 3.5 m/s [1]. The

resulting disadvantage, the enlargement of the dropping parable and associated enlargement of the “unloading window”, these days can be compensated for the most part by technical control procedures [2–4]. One example is the consideration of the unloading window at the rotary sorter. A mathematical solution has been compiled for this by Schmidt [5].

This paper proposes improved input stages for sorter systems that operate with non-tacted, random input. Application of modern loading and unloading strategies also has led to high unloading or sorting performance [6, 7]. It can therefore be said that the discrete supplying elements used today have achieved the physical–technical limits. Efficiency considerations, in particular maximization of throughput, do not cease to be in the centre of research interest and are primarily focused on system optimization as a whole [8]. The solution presented in this manuscript approaches the problem on machine level instead. Only a fundamentally new development in this area would allow another significant increase in output. Nevertheless, the field of feed systems and the conveyer belt feeding systems (single-stage-feeder) has been out of focus for a long time due to the concentration on developing the physical distributor. Yet recently the infeed line has gained attention again [9]. Performance studies of infeed lines at the rotary sorter with a proposal of improvements have been presented in [10]. However, impediment at sub-optimal feeder systems, which may lead to a considerable reduction of input performance and thus reduce the overall performance of otherwise optimized discrete and continuous sorter systems [11], has rarely been discussed in the literature.

On the one hand, impediment can be caused by the presence of a self-loaded general cargo unit that has not yet left the input area in the moment when the next general

✉ J. Föller
dr-foeller@dr-fup.de

¹ Hohlohstraße 8, 75334 Straubenhardt, Germany

cargo unit is ready to be placed on the conveyer belt. This phenomenon is called *self-impediment*. On the other hand, at subsequent input stations of a multistage feeder system, impediment may and usually will be caused by traversing general cargo from previous input stations. This article is largely focused on the latter type of impediment, *mutual impediment* (see Sect. 2).

A new feeding system that substantially reduces mutual impediment was conceived, simulated and validated with the help of a prototype in [12]: the *divided conveyer belt* feeder. A sequence of conveyer belts with sequentially increasing speeds, in combination with *spatially variable input* (denoted *variable input* in the following), guarantees that there is always sufficient vacant space at subsequent input stations such that another general cargo unit can be loaded. The divided conveyer belt with variable input is discussed in Sect. 3.

In Sect. 4, a rigorous mathematical treatment of the divided conveyer belt is given that confirms and reproduces results obtained from experiment. Additionally, we argue that the divided conveyer belt with variable input theoretically eliminates the problem of mutual impediment completely.

2 Mutual impediment

Mutual impediment is caused by existing general cargo on a conveyer belt feeding system (single-stage feeder) or on a physical distributor (blocked carrier on the sorter). It can originate from input on a collecting conveyer belt feed as well as from an input on an obliquely located feeding belt. This form of impediment to input operators leads to a noticeable decline in the overall performance in the feed system. Xiaoguang and Tsutsumi [11] analysed a similar impediment in a simulation of a multistage feeder model. They showed that with each additional feeder the on-loading performance at the additional feeder declines compared with the previous feeder. The reduction of the efficiency is shown in Fig. 1. The probability of occurrence of mutual impediment is increasing with the number of single-stage feeders [11].

Mutual impediment can only be avoided if usable and sufficiently large vacant space on the single-stage feeder or a free support element (e.g. cross belt, carrier) is available at all times.

An exception concerning the mutual impediment is the direct input on the physical distributor. Here, the input operator has the possibility of “variable” input. In principle, the operator can always use the support element (carrier) before or after the occupied support element [11, 12].

In contrast to mutual impediment, self-impediment is caused by self-loaded general cargo units, which block

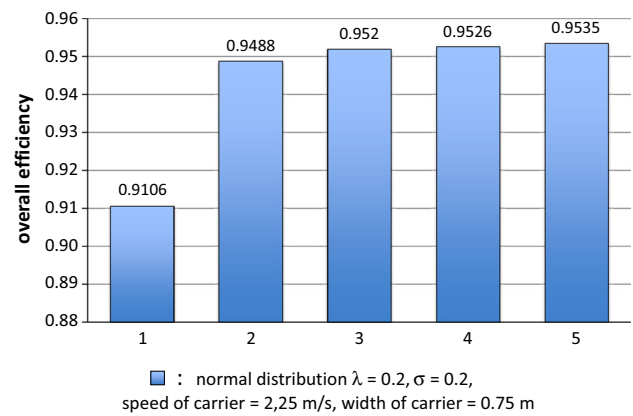

Fig. 1 Comparison of the overall on-loading efficiency of variable stage feeder models [11]. Note the reversed enumeration of input stations

the input area for a certain time that depends on the speed of the conveyer belt. However, in both types the presence of general cargo within the input prevents loading of another general cargo unit (see Fig. 2 for an illustration).

3 The divided conveyer belt

To define the system limits and to clarify the project contents, Arnold [13] provides an initial distinction (Fig. 3). The divided conveyer belt, as a feeder, acts only within the identification and supplying (feeding) area (1), while the physical distributor, clearly separated from area (1), is not included within the scope of this research. Similarly, the construction form and operating form of the physical distributor are not decisive factors. Therefore, following the VDI guideline 3619, the feed system brought to the centre of attention for this investigation is divided into its functions: input, identification and feeding.

The input into a distribution system using obliquely located feeding belts (single-stage feeder) generates, after a short machine operation time, mutual impediment (see also [11]).

Therefore, it was necessary to design a new feeder system, the *divided conveyer belt* feeder. The basic principle is depicted in Fig. 4. Every conveyer belt is accelerated compared with its predecessor by a factor a . Now, on the transition from one conveyer belt to the following faster one, a general cargo unit is accelerated relative to the units following behind. Thus, new vacant spaces are automatically generated between each general cargo unit, without enforcing explicit constraints on the operators that serve the input stations. The prototype system arranged up to four conveyer belts, connected in series, each having its own input area and its own workplace.

Fig. 2 **a** Mutual impediment occurs, when general cargo (GC) from a preceding input station blocks the input area at the end of handling a new general cargo unit. **b** Self-impediment occurs if self-loaded general cargo blocks the input area

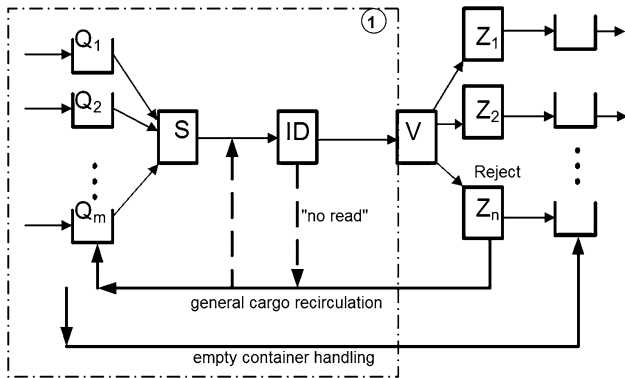
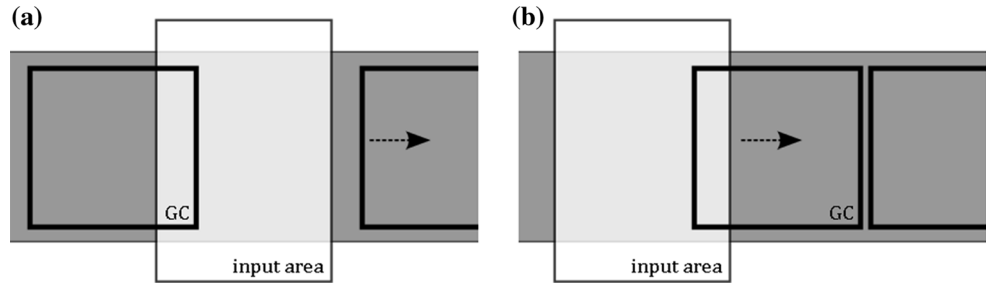

Fig. 3 Functional design of a sorting system; see also [13]. Q: source; Z: destination; S: accumulation; ID: identification; V: physical distributor

Figure 5 illustrates the generation of vacant spaces. The example given consists of three conveyers. On the vertical axis, snapshots of the momentary configuration are given for four different instances ($t = 0t_h, \dots, 3t_h$) (units of the (constant) handling time). Only at conveyer 1, general cargo is supplied at maximum rate to better demonstrate the growth of the vacant spaces (dashed boxes) from one conveyer to the next.

3.1 Experimental validation

Several preparations and precautions have been taken to ensure realistic and ergonomically optimal input operations in the experimental validation procedure. The methods–time measurement (MTM) study provided a basis for designing the workplaces and determining the expected

execution time for the various coding and input procedures (see Table 1). To carry out a comprehensive ergonomic design of a workplace, the psychological points of view were considered in addition to the anatomical and physiological factors. The basic conditions of the workplace and the working environment (light, noise, vibration and shock, climate, etc.), as well as the manual loading capacity, were adapted as much as possible to human needs. Care was taken that constantly recurring sequences of motion were supported by the specific kind of the construction for individual workplaces. To guarantee the most natural postures and motion sequences in the workplace design, the body mass of the input staff was taken into consideration. The aim was to ensure that the results of the attempt could not be falsified by insufficient ergonomic boundary conditions [14].

First, a series of experiments was carried out for all coding procedures and input procedures, to determine learning and fatigue curves. The tests for validation of the mutual impediment did not start until it was ensured that the input operator had reached maximum efficiency. External influence, which falsifies the test result, was therefore eliminated as much as possible.

Numerical and experimental evidence for the decline of input performance due to mutual impediment is summarized in Figs. 6 and 7. The possible input performance obtained from simulation with AutoMod decreases. This is in agreement with [11]. Note that it is yet difficult to compare numbers as the simulated systems were rather different. However, experiments with the divided conveyor belt have shown that reality is even worse. As the operator causes chaotic general cargo input (no rhythm), there are

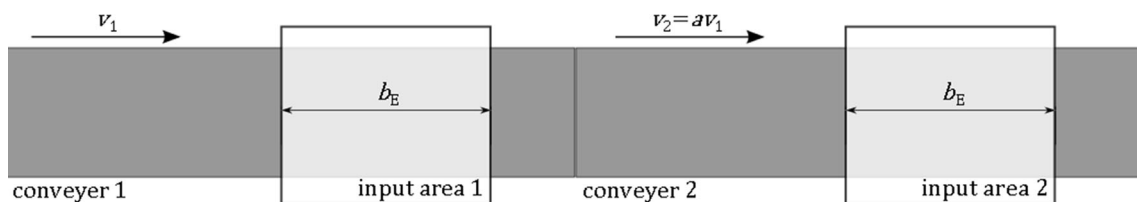

Fig. 4 Basic principle of the divided conveyor belt feeding system with variable width b_E of input area. Conveyor 2 is accelerated from conveyor 1–2, additional vacant space is generated compared with conveyor 1 by a factor a . General cargo on conveyor 2

moves faster than general cargo on conveyor 1, and thus on transition from conveyor 1–2, additional vacant space is generated between each general cargo unit

Fig. 5 Generation of vacant space by accelerating conveyers 2 (3) relative to conveyer 1 (2). After each handling time interval t_h , a new general cargo (GC) unit is supplied at conveyer 1. **a** $t = 0$, GC unit 1 is supplied at conveyer 1. **b** $t = t_h$, GC unit 1 has moved a distance $l_{min 1/1}$, and GC unit 2 is supplied at conveyer 1. **c** $t = 2t_h$, GC unit 1 is accelerated at conveyer 2, which generates vacant space (dashed box). **d** $t = 3t_h$, further acceleration of GC unit 1 at conveyer 3 generates additional vacant space

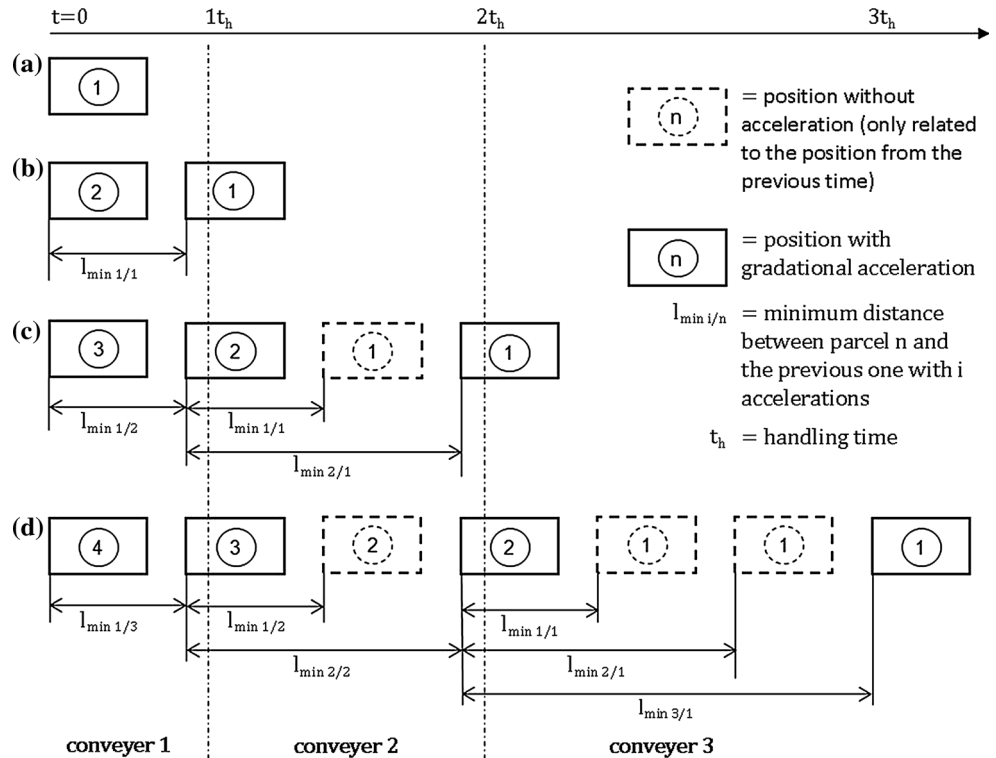

Table 1 Evaluation by means of MTM methods [12] (see also [15]), λ is the expected throughput in units of general cargo (GC) per hour

	Coding, sequence, sorting input	Time measurement unit per general cargo unit	λ [1/h]
Case A	Keyboard, one piece removal	127.5 TMU = 4.59 s	784
Case B	Keyboard, one piece removal, manual transfer	134.2 TMU = 4.83 s	745
Case C	None, several removal, manual transfer	109.9 TMU = 3.95 s	911
Case D	None, removal (5) GC, one piece input	64.8 TMU = 2.33 s	1544
Case E	Keyboard, removal (5) GC, one piece input	89.1 TMU = 3.20 s	1123
Case F	Voice coding, removal of multiple GC, one piece input	81.6 TMU = 2.94 s	1226

not enough “ideal” gaps, i.e. not enough vacant space with sufficient width is generated. As a result, the entire “real” input performance dropped, in fact, to zero at place 4 when conveyor 4 worked with 0.7 m/s and at place 3 when conveyor 4 worked with 0.5 m/s (See Fig. 6).

An even more pronounced decline of input performance at position 2 is shown in Fig. 7. Here, two input positions were observed after they entered a “steady state”. Then, the operator at position 1 gradually increased the input frequency. It is clearly apparent that the short-time increase in input performance at position 1 reduced the input performance at position 2 by almost 50 % due to lack of usable gaps. As a result, the entire input performance was reduced. Again, a simulation carried out simultaneously confirmed the experimental results. This clearly indicates that the origin of mutual impediment is linked to fast and chaotic cargo input.

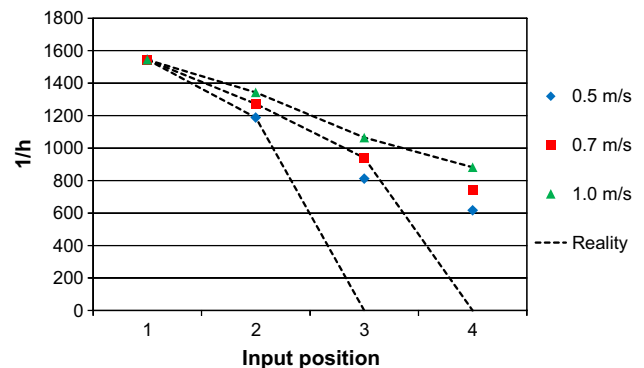

Fig. 6 Possible mutual impediment at different conveyor belt speeds. Symbolical comparison of worst-case results from simulation with AutoMod (data points) with reality, i.e. results obtained from experiments with the prototype of the divided conveyor belt feeding system [12]. Speed values in the legend indicate the speed of the fastest conveyor at input position 4

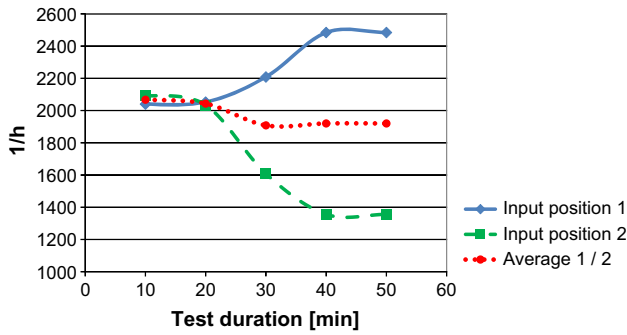

Fig. 7 Effect of mutual impediment: a decline of the input performance at position 2 due to an increase in input performance at position 1 [12]. The speed of the conveyer belt in this experiment was 1 m/s

Even though the initially chosen approach for removing the phenomenon with a *divided conveyer belt feed* (patent DE 100 51 932 A) seemed promising (cf. [12]), it turned out that as long as the input was spatially restricted a slight reduction of the overall performance still occurred. As a result of this insight, the variability of the input moved to the centre of attention. The probabilistic model described in the next section serves, in addition to practical experiment, as a tool to investigate the interplay between the divided conveyer belt as such and the variability of input.

Results of experiments on the divided conveyer belt prototype system and simulation of a standard conveyer belt feeding system are listed in Table 2. The advantage of *variable* input over *fixed* input position (this corresponds to the case where $b_E = l_{min}$ in Sect. 4) can clearly be seen. Input is denoted *variable*, or *spatially variable*, if the operator is flexible in his choice of where to place the general cargo unit within the input area. Obviously, input

can only be variable if the width of the input area is sufficiently much larger than the length of a general cargo unit.

To compute the efficiency (the value 1 corresponds to no idle time), the MTM value t_{MTM} for the handling time was taken as the optimal handling time. The reduced value for t_{MTM} had to be applied, because a modified experimental design of the workplace simplified the processing procedure. While for the standard conveyer belt system the idle time steadily increases, it decreases steadily for the divided conveyer belt with fixed input and almost vanishes completely if input is variable. The very high idle time at input position 2 is significant for a “fixed” input position. The reason for this is based on the origin of the vacant space, which is relatively narrow at this point in time. This makes further general cargo input difficult. The approach to realizing a bigger speed step at this point must be rejected on account of the subsequent speed steps. Although this table shows some relict of idle time at position 2—there is still a minimal amount of mutual impediment—the system performance does almost entirely depend on the handling time only.

4 Theoretical input performance

The following considers the new system in terms of a probabilistic model. Assuming a constant width of the general cargo units the optimal solution for the acceleration factor a that permits the maximum probability of input (loading) will be given. While the optimal choice of a ensures that another general cargo unit can always be loaded at the subsequent input station, it is the width of the input area that needs to be suitably adjusted to maximize

Table 2 Comparison of the waiting (or idle) time t_w for a standard conveyer belt feeding system (obtained from simulation with AutoMod) and the experimental results of the divided conveyer belt feeding system with fixed and variable input position [16]

System	Input station	t_w [s]	Efficiency
Standard conveyer belt feeding, simulation $t_{MTM} = 2.85$	1	0.000	1.00
	2	0.320	0.90
	3	0.960	0.75
	4	1.600	0.64
	Σ	2.880	0.80
Divided conveyer belt feeding, fixed input $t_{MTM} = 2.40$	1	0.000	1.00
	2	1.450	0.62
	3	0.710	0.77
	4	0.440	0.85
	Σ	2.600	0.79
Divided conveyer belt feeding, variable input $t_{MTM} = 2.40$	1	0.000	1.00
	2	0.024	0.99
	3	0.000	1.00
	4	0.000	1.00
	Σ	0.024	1.00

the input performance. With the optimal width of the input area, no idle times occur (Sect. 4.2). While it is not too difficult to see that with enough spatial variability the divided conveyer belt eliminates mutual impediment, it is instructive to investigate numbers in detail, thus obtaining a quantification of the benefit (Sect. 4.3). Furthermore, in some cases compromises might be in order that prevent from providing total spatial variability. Then, our approach may be helpful in finding an optimal solution under spatially restricted conditions.

4.1 The model

In the following investigation, the basic structure of the model shall mostly be restricted to the case of two conveyer belts, each having their own input area. With the first conveyer belt working at speed v_1 , the second conveyer belt is accelerated compared with the first by a factor a . Imposed by technical conditions, the speed v_2 , of the second conveyer shall be limited by v_{\max} , i.e.

$$v_{\max} \geq v_2 = av_1.$$

Three different lengths:

- the constant width of general cargo l_{GC} ,
- the constant minimum necessary handling width l_{\min} and
- the width b_E , of the input area equal at both stations,

are restricted and related to each other by

$$b_E \geq l_{\min} > l_{GC} > 0.$$

While, in principle, l_{GC} and l_{\min} may be different for each individual general cargo unit and thus represent random variables, both shall be assumed constant for simplicity. The handling times at station 1 and 2, denoted T_1 and T_2 , respectively, are treated as random variables following, for example, an equal or suitable normal distribution. An illustration of the basic structure is shown in Fig. 4.

For concretion and comparison, three specific models that differ only in the width of the input area shall be considered explicitly:

- Model 1: $b_{E1} = l_{\min}$.
- Model 2: $b_{E2} = 2l_{\min}$.
- Model 3: $b_{E3} = 3l_{\min}$.

Note that the increased input areas in models 2 and 3 permit spatially variable input.

In a real-world application, the minimum necessary handling width l_{\min} is always larger than l_{GC} by a small amount. To avoid unnecessary subtleties, l_{\min} shall be chosen as the central length of importance in our discussion. The minimum vacant space generated on the transition from one conveyer to the next is

$$l_{g,\min} = (a - 1)l_{\min}.$$

Thus, for $a \geq 2$, the new generated vacant space is always sufficiently large to accept another general cargo unit.

Generally, the allocation of vacant space between two general cargo units at the end of conveyer 1 is described by the random variable

$$G_1^{\text{out}}(T_1) = \begin{cases} 0, & \text{if } T_1 \leq \frac{l_{\min}}{v_1}, \\ v_1 T_1 - l_{\min}, & \text{if } T_1 > \frac{l_{\min}}{v_1}. \end{cases} \quad (1)$$

The condition $T_1 \leq l_{\min}/v_1$ signals self-impediment (see Fig. 2b) that occurs if a self-loaded general cargo unit still blocks the input area at the end of handling the following general cargo unit. If the speed of conveyer 1 is too low or, put in another way, the operator at station 1 acts too fast, the preceding general cargo unit has not had enough time to leave the input area. Assuming that the current general cargo unit then will be placed immediately after the preceding one, there will be effectively no vacant space left between the two units.

Let $P_1(T_1)$ be the probability density function of handling times at station 1. Then, the probability $P_{\text{si}}(T_1 \leq l_{\min}/v_1)$ that self-impediment occurs is formally given by

$$P_{\text{si}} = \int_0^{l_{\min}/v_1} P_1(T_1) dT_1. \quad (2)$$

Assume that a given handling time T_1 has indeed been smaller than l_{\min}/v_1 . Then, the operator must wait for a time $(l_{\min}/v_1 - T_1)$, before the new general cargo unit can be loaded. On average, the waiting or idle time due to self-impediment will be

$$\bar{w}_{\text{si}} = \begin{cases} \frac{l_{\min}}{v_1} - \int_0^{l_{\min}/v_1} P_1(T_1) T_1 dT_1, & \text{if } P_{\text{si}} \neq 0, \\ 0, & \text{if } P_{\text{si}} = 0. \end{cases} \quad (3)$$

The value of the integral in the above expression depends on the precise form of the distribution function $P_1(T_1)$. By choosing a suitable speed of the first conveyer, it can be ensured that no self-impediment will occur, i.e. $P_{\text{si}} = 0$ and $\bar{w}_{\text{si}} = 0$. The expression (1) for the allocation of vacant space then simply reduces its first line for all $T_1 \geq 0$. Note that, due to the increased speed, there will be no self-impediment at station 2 (and, in fact, all subsequent stations), provided $P_1(T_1) \approx P_2(T_2)$, i.e. the distributions of handling times are sufficiently similar.

With (1), (2) and (3), the expectation value of vacant space at the end of conveyer 1 can be computed as:

$$E(G_1^{\text{out}}) = \begin{cases} v_1 E(T_1) - l_{\min} + v_1 \bar{w}_{si} - l_{\min}(1 - P_{si}), & \text{if } P_{si} \neq 0, \\ v_1 E(T_1) - l_{\min}, & \text{if } P_{si} = 0. \end{cases}$$

In the special case of $P_{si} = 1$, when there is always self-impediment, an average idle time of $\bar{w}_{si} = l_{\min}/v_1 - E(T_1)$ results from (3) and the above equation gives consistently $E(G_1^{\text{out}}) = 0$.

After the transition from conveyor 1 to conveyor 2, a general cargo unit moves at increased speed $v_2 = av_1$, while all following general cargo units still move at speed v_1 . This “boost” generates extra vacant space according to $G_2^{\text{in}} = aG_1^{\text{out}} + (a - 1)l_{\min}$,

where the random variable G_2^{in} denotes the allocation of vacant space between two general cargo units at the beginning of conveyor 2 after the acceleration with factor a . The expectation value of G_2^{in} is obviously $E(G_2^{\text{in}}) = aE(G_1^{\text{out}}) + (a - 1)l_{\min}$. In the worst case, two subsequent general cargo units from conveyor 1 come closely packed, with no vacant space in between ($G_1^{\text{out}} = 0$). Then at least the minimum vacant space $(a - 1)l_{\min}$ is generated, which is *always* large enough to accept another general cargo unit if $a \geq 2$.

Technically, there is always an upper limit v_{\max} to the speed of conveyers. The speed of the first conveyor much be chosen sufficiently small, such that the speed of the subsequent conveyor(s) does not exceed this maximum. But if self-impediment is to be avoided, the speed of the first conveyor cannot be chosen arbitrarily small. Self-impediment can be completely avoided only if the minimum possible handling time at station 1, $T_{1,\min}$, is always larger than l_{\min}/v_1 . This puts another constraint on the speed v_1 of conveyor 1. Thus, in summary, if it is the primary goal to always provide sufficient vacant space at station 2 for another general cargo unit to be supplied, and the secondary goal to avoid self-impediment at station 1, the following optimal solution arises:

$$\frac{l_{\min}}{T_{1,\min}} \leq v_1 \leq \frac{v_{\max}}{a}, \quad \text{and} \quad a = 2.$$

It is, in fact, straightforward to generalize this discussion to a system of N conveyor belts with individual speeds v_i , each being accelerated with respect to its predecessor by a factor a_i . Yet, if there are more than two conveyor belts, it is to ensure that the maximum conveyor belt speed technically possible is not exceeded, i.e. $v_N \leq v_{\max}$. The random variable G_i^{in} , which describes the allocation of vacant space at the beginning of conveyor i , depends on the output of conveyor $i - 1$,

$$G_i^{\text{in}} = a_i G_{i-1}^{\text{out}} + (a_i - 1)l_{\min}.$$

The general treatment of G_i^{out} must take into account the mixing of different random input sequences for $i \geq 2$. Ideally, this can be described by a convolution of handling time distributions. Due to mutual impediment, however, the exact treatment is a bit more involved and shall be subject to a future publication.

In principle, the factors a_i can take different values at each conveyor, and fine tuning can lead to optimized performance in real applications. Following along the line of the above discussion, however, we argue that the theoretically optimal solution is

$$\frac{l_{\min}}{T_{1,\min}} \leq v_1 \leq \frac{v_{\max}}{a_2 \dots a_N}, \quad \text{and} \quad a_i \equiv a = 2,$$

for all conveyers $i = 2 \dots N$, in a system of N of conveyor belts. This ensures

- that at each conveyor $i \geq 2$, there will be sufficient new vacant space,
- that the last conveyor obeys the speed limit imposed by technical conditions, and
- that no self-impediment occurs, in particular, at station 1.

In the remaining parts of this section, it shall be assumed that no self-impediment occurs at the input stations.

4.2 Maximum idle time

Idle times at station 2 can arise by blocked input areas at the handling moment. The presence of general cargo from station 1 prevents the input of another general cargo unit at station 2. Of particular interest is the maximum idle time (or waiting time) w_{\max} . Impediment, i.e. blocking caused by the general cargo unit from station 1, begins when there is not enough space left within the input area *in front* of the blocking general cargo unit (Fig. 8a). Putting the origin to the edge of the input area where general cargo units enter, impediment thus begins when the front edge of the general cargo unit is at

$$x_1 = b_E - l_{\min} = (k_E - 1)l_{\min}, \tag{4}$$

where the ratio $k_E = b_E/l_{\min} \geq 1$ has been introduced for convenience. Impediment ends when there eventually occurs enough space within the input area *behind* the blocking general cargo unit (Fig. 8b). This is the case when the front edge of the blocking unit is at

$$x_2 = l_{\min} + l_{GC} = (1 + k_{GC})l_{\min}, \tag{5}$$

with the ratio $k_{GC} = l_{GC}/l_{\min} < 1$. The maximum idle time arises when the general cargo unit from station 1 has just begun to block. Then, the maximum distance it has to traverse to end impediment is $(x_2 - x_1)$. But this maximum

distance depends on the width of the input area, and the time it takes to traverse it depends on the speed of conveyor belt 2. Under the condition that $a \geq 2$, there is always enough space behind a general cargo unit, and we do not need to consider the presence of more than one blocking general cargo unit. Then, explicitly, the maximum idle time becomes

$$w_{\max} = \frac{2l_{\min} - b_E + l_{GC}}{av_1} = \frac{(2 - k_E + k_{GC})l_{\min}}{av_1} \approx \frac{(3 - k_E)l_{\min}}{av_1}$$

Note that the maximum idle time becomes zero for $k_E = 2 + k_{GC} \approx 3$.

For $k_E > 2 + k_{GC} \approx 3$, i.e. for input areas of width $b_E > 2l_{\min} + l_{GC} \approx 3l_{\min}$, the expression for the maximum idle time becomes negative, which does not make sense technically. But it simply indicates an (unnecessary) surplus of input space, which may be available or not, depending on whether there is an immediately following general cargo unit or not. In particular, for model 3 with $b_E = 3l_{\min}$, i.e. $k_E = 3$, there appears no idle time at all. Mutual impediment arising from the presence of general cargo from station 1 at the input area of station 2 is *eliminated*.

4.3 Average idle time

To quantify the benefit from the solution presented in this paper, it is instructive to consider the average idle time of a general setup with $b_E = k_E l_{\min}$. Generally, the idle time will take some (random) intermediate value between 0 and w_{\max} . Ignoring possible synchronization effects between station 1 and station 2, and assuming that every handling moment is equally probable, the probability that input at station 2 is blocked by the presence of general cargo from station 1 is the blockage probability

$$Pr_B = \frac{2l_{\min} - b_E + l_{GC}}{L} = \frac{(2 - k_E + k_{GC})l_{\min}}{L}$$

where $L \geq al_{\min}$ is the width of an interval at conveyor 2, measured from front edge to front edge of general cargo units. Note that the above expression can only be interpreted as a probability for $b_E \leq 2l_{\min} + l_{GC}$. From the point of view of station 2, the worst case is when station 1 works at maximum efficiency and all intervals are of minimum length l_{\min} . The worst-case average idle time can be computed from

$$w_{\text{avg}}^{\text{worst}} = \frac{1}{L_{\min}} \int_0^{L_{\min}} w(x) dx,$$

where $w(x)$ is the idle time as a function of the position x of the front edge of the blocking general cargo unit. With impediment beginning at x_1 (4) and ending at x_2 (5), it can be written

$$w(x) = w_{\max} \left(\frac{x_2 - x}{x_2 - x_1} \right) \quad \text{if } x_1 < x < x_2,$$

and $w(x) = 0$, otherwise. Then, the worst-case average idle time becomes

$$w_{\text{avg}}^{\text{worst}} = \frac{w_{\max}}{L_{\min}} \int_{x_1}^{x_2} \frac{x_2 - x}{x_2 - x_1} dx = \frac{w_{\max}(x_2 - x_1)}{2L_{\min}}$$

Noting that $L_{\min} = al_{\min}$ and inserting (4) and (5), we finally get the explicit dependence of the worst-case average idle time on the important technical parameters a , v_1 and b_E , i.e.

$$w_{\text{avg}}^{\text{worst}} = \frac{(2l_{\min} - b_E + l_{GC})^2}{2a^2 v_1 l_{\min}} = \frac{(2 - k_E + k_{GC})^2 l_{\min}}{2a^2 v_1} \approx \frac{(3 - k_E)^2 l_{\min}}{2a^2 v_1}$$

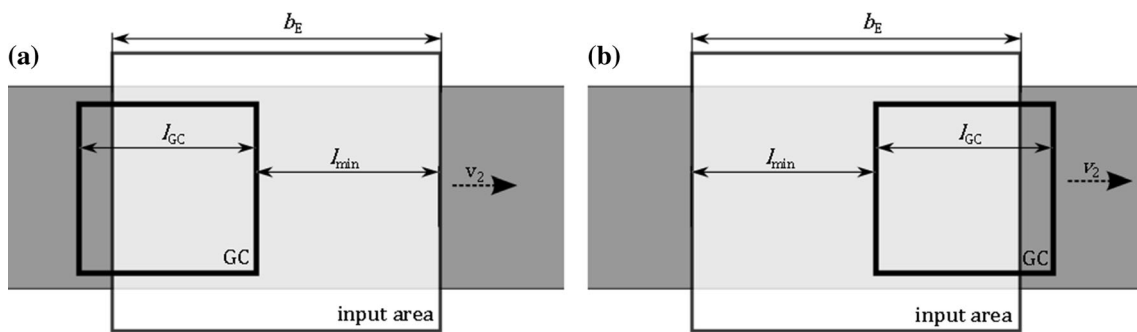

Fig. 8 **a** Impediment begins when the vacant space within the input area in front of a general cargo (GC) unit becomes less than the minimum necessary handling width l_{\min} . **b** Impediment ends when the

vacant within the input area space behind the general cargo unit becomes larger than l_{\min}

Table 3 Theoretical maximum idle time w_{\max} and worst-case average idle time $w_{\text{avg}}^{\text{worst}}$ for the three special cases of the general model with different widths of the input area

b_E	w_{\max}	$w_{\text{avg}}^{\text{worst}}$
l_{\min}	$\frac{l_{\min} + l_{GC}}{av_1}$	$\frac{(l_{\min} + l_{GC})^2}{2a^2v_1l_{\min}}$
$2l_{\min}$	$\frac{l_{GC}}{av_1}$	$\frac{l_{GC}^2}{2a^2v_1l_{\min}}$
$3l_{\min}$	0	0

which holds for $a \geq 2$ and $l_{\min} \leq b_E \leq 2l_{\min} + l_{GC} \approx 3l_{\min}$. For comparison, the maximum and worst-case average idle times of the concrete models 1, 2 and 3 are listed in Table 3.

The “worst” case at input station 2 is actually the “best” case at input station 1, which then works with maximum efficiency. In this idealized case, the handling time is always T_{opt} , which may be adjusted to be, for example, 2.40 or 2.85 s, the MTM values given in Table 2. However, the idealized optimal handling time at station 1 is certainly determined by the speed of conveyer 1 and the minimum necessary handling width, $T_{\text{opt}} = l_{\min}/v_1$. The optimal input at station 1 in general cargo (GC) units per hour then is $D_1 [1/h] = 3600/T_{\text{opt}}$. Nonzero idle times decrease the input performance and in the worst case from the point of view of station 2, $D_2 [1/h] = 3600 / (T_{\text{opt}} + w_{\text{avg}}^{\text{worst}})$. The ratio D_2/D_1 represents the efficiency of station 2 with respect to the optimal input at station 1 (see Fig. 9). It can be written

$$\frac{D_2}{D_1} = \frac{T_{\text{opt}}}{T_{\text{opt}} + w_{\text{avg}}^{\text{worst}}} = \frac{1}{1 + \frac{(2 - k_E + k_{GC})^2}{2a^2}} \approx \frac{1}{1 + \frac{(3 - k_E)^2}{2a^2}}$$

Note that this efficiency does, in fact, only depend on two technical parameters, the acceleration factor a and the width of the input area k_E relative to the minimum necessary handling width. It has to be reminded, however, that this expression holds only for a limited range of a and k_E .

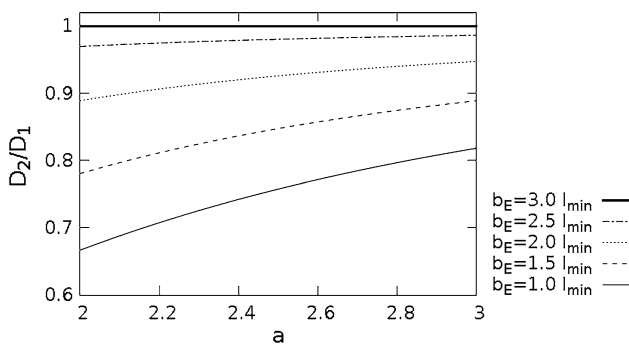

Fig. 9 Efficiency of input station 2 with respect to the input at station 1. The efficiency increases when the width b_E of the input area becomes larger and takes its maximum value for $b_E = 3l_{\min}$ (it has been assumed that $l_{\min} \approx l_{GC}$). The acceleration factor $a \geq 2$ ensures that there is always sufficient vacant space available to place another general cargo unit at input station 2

On the one hand, if $a < 2$, then in the worst-case scenario considered the efficiency becomes zero, while on the other hand if $k_E > 2 + k_{GC} \approx 3$, the presence of more than just one general cargo unit within the input area of station 2 needs to be considered, which has been ignored in present discussion.

5 Conclusion

In summary, the divided conveyer belt feeding system, which has been first presented by the author in 2003 [12], and its potential to reduce, respectively, eliminate the reduction of input performance caused by mutual impediment have been discussed in this article. In the course of developing the system, several validation procedures have been performed on a prototype with four input stations that produced evidence for the occurrence of mutual impediment and gave insight into the origins of this phenomenon [12, 16].

The main focus of this article has been the theoretical investigation of the divided conveyer belt based on the probabilistic treatment of an idealized model with two input stations. The reduction of input performance has been quantified in terms of the worst-case average idle time that can occur due to mutual impediment. In good agreement with the experimental results discussed in Sect. 3, the model predicts substantial reduction of the deficiency caused by mutual impediment, when the input stations of the divided conveyer belt are equipped with input areas that permit spatially variable input. In particular, with an optimal choice of the acceleration factor of the divided conveyer belt feeding system ($a = 2$) in combination with an optimal choice of the width of the input area ($b_E = 3l_{\min}$), the effect of mutual impediment can be completely eliminated.

Several limiting assumptions and idealizations have been applied in the course of the theoretical investigation. Extensions of the model to overcome these limitations shall be subject to future theoretical work, simulation and experiment. The possible extensions include: treating general probability distributions of handling times, treating the width of general cargo as random variable, determining the average idle time for non-worst-case scenarios, considering idle times caused by self-impediment in the efficiency calculation and, last but not least, extending the discussion to more than two input stations.

Open Access This article is distributed under the terms of the Creative Commons Attribution 4.0 International License (<http://creativecommons.org/licenses/by/4.0/>), which permits unrestricted use, distribution, and reproduction in any medium, provided you give appropriate credit to the original author(s) and the source, provide a link to the Creative Commons license, and indicate if changes were made.

References

1. Jodin D, ten Hompel M (2006) *Sortier- und Verteilsysteme*. Springer, Berlin Heidelberg
2. Linge N (2003) Development of a product sorter for medium throughput. Dissertation, Karlsruhe Institute of Technology, Germany
3. Hintz A (2003) Bedeutung der Endstellen an Hochleistungssortern. VDI-Berichte Nr. 1796, VDI-Verlag, Düsseldorf
4. Droste H (1995) Untersuchung an Kippelementen für Stueckgutsortieranlagen. Dissertation, Universität Hannover, Germany
5. Schmidt T (2000) Stückgutverteilung nach dem Drehsorterprinzip. Dissertation, Universität Dortmund, Germany
6. Beumer C (2002) C-2.4: Sortier- und Verteilsysteme. In: Arnold D, Isermann H, Kuhn A, Tempelmeier H (eds) *Handbuch Logistik*, VDI-Buch. Springer, Heidelberg
7. Föllner J (2004) Die Zuführstrecke als “Bottleneck” eines modernen Sortiersystems Teil 1 und 2. *Fördern und Heben* 3:110–111; 4:202–203
8. Haneyah SWA, Schutten MJM, Fikse K (2013) Throughput maximization of parcel sorter systems by scheduling inbound containers. In: Clausen U, ten Hompel M, Meier FJ (eds) *Efficiency and innovation in logistics*. Springer, Berlin, pp 147–159
9. Gasperin S, Jodin D (2012) Dynamic merge of discrete goods flow—impact on throughput and efficiency. *Logist J*. doi:10.2195/lj_Rev_gasperin_en_201202_01
10. Sadowsky V, Semrau KF (2012) Utilizing the full capacity of sorting systems with new infeed technology. *Logist J*. doi:10.2195/lj_Rev_sadowsky_en_201207_01
11. Xiaoguang Z, Tsutsumi M (2007) Model analysis and computer simulation study for feeders of the high-speed package sorter. IEEE international conference on automation and logistics, August 2007, pp 1001–1006
12. Föllner J (2003) Analyse einer neuartigen Materialzuführung für Warensortier- und Verteilsysteme. Dissertation, Karlsruhe Institute of Technology, Germany
13. Arnold D (2001) Sorter – nützliche Maschinen mit diversen Problemen. VDI – Berichte Nr. 1624, VDI-Verlag, Düsseldorf
14. Hettinger T, Kaminsky G, Schmale H (1980) *Ergonomie am Arbeitsplatz*, 2nd edn. Friedrich Kiehl, Ludwigshafen
15. Antis W, Honeycutt J, Koch E (1973) *The basic motions of MTM*, 4th edn. The Maynard Foundation, Naples
16. Föllner J (2010) Steigerung der Sorterauslastung durch optimale Nutzung der Zuführkapazitäten. In: Föllner J, Furmans K (eds) *Wege zu einer verantwortlichen Ressourcenverwendung in der Logistik*. VDI-IFL Sommerseminar, Karlsruhe, pp 99–124