

Hartmann, Florian; Charpe, Matthieu; Flaschel, Peter; Veneziani, Roberto

Working Paper

A basic model of real-financial market interactions with heterogeneous opinion dynamics

Working Paper, No. 104

Provided in Cooperation with:

Institute of Empirical Economic Research, University of Osnabrueck

Suggested Citation: Hartmann, Florian; Charpe, Matthieu; Flaschel, Peter; Veneziani, Roberto (2016) : A basic model of real-financial market interactions with heterogeneous opinion dynamics, Working Paper, No. 104, Osnabrück University, Institute of Empirical Economic Research, Osnabrück

This Version is available at:

<https://hdl.handle.net/10419/156150>

Standard-Nutzungsbedingungen:

Die Dokumente auf EconStor dürfen zu eigenen wissenschaftlichen Zwecken und zum Privatgebrauch gespeichert und kopiert werden.

Sie dürfen die Dokumente nicht für öffentliche oder kommerzielle Zwecke vervielfältigen, öffentlich ausstellen, öffentlich zugänglich machen, vertreiben oder anderweitig nutzen.

Sofern die Verfasser die Dokumente unter Open-Content-Lizenzen (insbesondere CC-Lizenzen) zur Verfügung gestellt haben sollten, gelten abweichend von diesen Nutzungsbedingungen die in der dort genannten Lizenz gewährten Nutzungsrechte.

Terms of use:

Documents in EconStor may be saved and copied for your personal and scholarly purposes.

You are not to copy documents for public or commercial purposes, to exhibit the documents publicly, to make them publicly available on the internet, or to distribute or otherwise use the documents in public.

If the documents have been made available under an Open Content Licence (especially Creative Commons Licences), you may exercise further usage rights as specified in the indicated licence.

**A Basic Model of Real-Financial Market Interactions with
Heterogeneous Opinion Dynamics**

**Florian Hartmann
Matthieu Charpe
Peter Flaschel
und Roberto Veneziani**

Working Paper No. 104
Mai 2016

INSTITUTE OF EMPIRICAL ECONOMIC RESEARCH
Osnabrück University
Rolandstraße 8
49069 Osnabrück
Germany

A Basic Model of Real-Financial Market Interactions with Heterogeneous Opinion Dynamics¹

Florian Hartmann^a, Matthieu Charpe^b, Peter Flaschel^c, Roberto Veneziani^d

^a*University of Osnabrück, Osnabrück, Germany*

^b*International Labor Organization (ILO), Geneva, Switzerland*

^c*Bielefeld University, Bielefeld, Germany*

^d*Queen Mary University, London, England*

Abstract

We consider an alternative modelling approach to the mainstream DSGE paradigm, namely a Dynamic Stochastic General Disequilibrium (DSGD) baseline model of continuous and gradual adjustment processes on interacting real and financial markets. Heterogeneous capital gain expectations (chartists and fundamentalists) are introduced in place of rational expectations and we show that the first type of agents tends to destabilise the economy. An additional feature is that the share of prevailing opinion types is able to switch endogenously. Global stability can be ensured if opinions favour fundamentalist behaviour far off the steady state. This interaction of expectations and population dynamics is bounding the potentially explosive real-financial market interactions, but can enforce irregular behaviour within these bounds when the dynamics is dominated by fundamentalist behavior far off the steady state (at least in the downturn). The size of output and share price fluctuations can be reduced however by imposing suitably chosen policy measures on the dynamics of the private sector.

Keywords: Output and share price dynamics, heterogeneous expectations, boundedness, persistent irregular fluctuations, policy measures

JEL classifications: E12, E24, E31, E52.

¹An earlier version of this paper appeared as Charpe, M., Flaschel, P. Hartmann, F. & R. Veneziani, Towards Keynesian DSGD-(isequilibrium) Modelling: Real-Financial Market Interactions with Heterogeneous Expectations Dynamics. IMK Working Paper 93/2012. Macroeconomic Policy Institute.

1. Introduction

So here's what I think economists have to do. First, they have to face up to the inconvenient reality that financial markets fall far short of perfection, that they are subject to extraordinary delusions and the madness of crowds. Second, they have to admit – and this will be very hard for the people who giggled and whispered over Keynes – that Keynesian economics remains the best framework we have for making sense of recessions and depressions. Third, they'll have to do their best to incorporate the realities of finance into macroeconomics.

Many economists will find these changes deeply disturbing.

Paul Krugman, New York Times, September 6, 2009

Financial crises are a permanently challenging phenomenon in market economies: they are recurrent, can be extremely disruptive and costly, and they raise important issues for theorists and policy makers alike. The ruling paradigm of Dynamic Stochastic General Equilibrium (henceforth, DSGE) in macroeconomics has done a rather unconvincing job with respect to the explanation of financial crises and especially the recent global downturn, as admitted also by proponents of the DSGE approach, such as Charie et al. (2009). Arguably, this unsatisfactory performance has not been the result of a lack of mathematical sophistication. Rather, it derives from the adoption of an equilibrium approach coupled with the assumption of Rational Expectations, which seem methodologically and empirically questionable. Indeed, De Grauwe (2010) has attempted to build DSGE models without Rational Expectations by assuming agents to have limited cognitive abilities. Tovar (2009) among others has also argued that it is necessary to incorporate various transmission mechanisms that had been absent in the DSGE literature for quite a while, but are nonetheless crucial to understand monetary market economies. Improvements like Benes and Kumhoff (2012) have been made to counter this line of critique, but cannot overcome the basic flaws which come with the imposition of RE. Even the incorporation of heterogeneous expectations, as it is done in Massaro (2012) or Branch and Evans (2011) only accomplishes partly a change in determinacy respectively policy implications,

but sticks to imposed equilibrium considerations, which do not allow to map some of the essential dynamic feedbacks.

This paper proposes a number of departures from DSGE methodology, which can be seen as the building blocks of a new approach in the Keynesian tradition, which we call Dynamic Stochastic General Disequilibrium (henceforth, DSGD). We construct an integrated macrodynamic model which incorporates some important feedback channels from the real to the financial sector (and vice versa), and in which markets are not assumed to jump to their equilibrium positions, but where dynamic adjustment processes take place. Further, unlike in much of the macrodynamic literature out of the DSGE approach, we analyse *behaviourally founded* (instead of standard micro-founded) expectation processes on the micro level in financial markets by incorporating an innovative concept of *animal spirits* developed by Franke (2012) instead of the standard rational expectation apparatus. In comparison, DSGD delivers a more general concept of which DSGE equilibria might be special cases, but cannot be considered the only economically relevant outcomes.

To be precise, we consider a one-good economy where output moves according to a dynamic multiplier approach which considerably simplifies the Metzlerian inventory accelerator mechanism of the Keynes-Metzler-Goodwin model of Chiarella and Flaschel (2000). Since our focus in this paper is on financial markets and their specific sources of instability, the real side of the economy is kept as simple as possible. However, we assume that stock markets have real effects by influencing the agents' state of trust in the economy, and so their investment and consumption decisions.

The reader may question the label 'General' in the Dynamic Stochastic General Disequilibrium model we are considering in this paper. However, if the approaches considered in Charpe et al. (2011a), Asada et al. (2011) are added to the present model, its message remains essentially the same, though its real part is then of an advanced KMG type (as considered in detail in Charpe et al., 2011) and its financial part of an advanced Tobinian type of macroeconomic portfolio choice (as considered in detail in Asada et al., 2011).

Three types of assets are traded on financial markets: first, a capital stock asset which is directly owned by households who supply the means of financing to firms. The second asset is a short-term, fix-price government bond, whose rate of interest is set by the Central Bank which issues the third asset, money M . A portfolio approach based on Tobin (1982) is employed to address disequilibrium adjustment processes on financial markets. Since

the economy wide stocks of assets are given numbers in a set-up neglecting growth (for the purpose of analysing business cycle issues), allocation is provided by the respective private asset demands. Households choose between risky capital and safe bonds, where the latter is just determined residually. Moreover, the central bank has to buy (sell) all the bonds left (needed) by private excess demand and finally adjust the money supply accordingly. It does not trade in the market for the capital stock. This allows us to identify the feedbacks between financial and real markets, via Tobin's q , here given by the market price of capital K . In particular, we consider the effects of real variables on capital gain expectations, which represent a key element of the expected rate of return on stocks.

Focusing only on one risky asset (though we have two additional ones present in the background) is appropriate in order to identify the key dynamic mechanisms and real / financial feedbacks. But it is important to stress that this is just a simplifying assumption and the model can be extended to include, for example, long-term bonds B^l or bank loans Λ as in Charpe et al. (2011b), Chiarella et al. (2012), Hartmann and Flaschel (2014) and in Flaschel et al. (2011). In this paper, however, we go even one step further in simplification to provide the core of the DSGD approach as clear as possible and, thus, redefine the wealth component, agents are focusing on, by the value of the capital stock (and thus ignore money and bond holdings in the stock demand function of asset holders²). This allows us to treat the stock market in isolation and to remove secondary wealth effects from the model, see Charpe et al. (2012) for a full Tobinian portfolio approach where such stock-flow consistency is restored.³

One of the key contributions of the paper, however, is the explicit incorporation of opinion dynamics in financial markets populated by heterogeneous agents, which allows us to examine the effects of herding and speculative behaviour in combination with real-financial market interactions. More precisely, we adopt the distinction between *chartists* and *fundamentalists* originally proposed by Allen and Taylor (1990) and as Brunnermeier (2008) documents perceived as a main approach in explaining bubbles. Chartists behave like speculators and can be seen as technical traders who adopt a

²based on Walras Law of Stocks and the assumed interest rate policy of the central bank.

³See Flaschel et al.(2015) for the incorporation of heterogeneous expectations along the lines of the disequilibrium approach presented here in an open economy approach.

simple adaptive expectation mechanism. In contrast, fundamentalists focus on basic economic data and expect variables to return to steady state values with a certain adjustment speed. When regarded *ceteris paribus*, chartists tend to exert a destabilising influence on the economy, whereas the presence of fundamentalists is stabilising.

Albeit simple, this description of agent heterogeneity on financial markets is consistent with studies analysing expectational heterogeneity (see, for example, Menkhoff et al., 2009), and agents' behaviour on financial or foreign exchange markets (see, for example, De Grauwe and Grimaldi, 2005 and recently Proaño, 2011), and sufficient to examine some of the core propagation features of financial markets that have played a prominent role in the current crisis. Overall *market* expectations are here a function of individual fundamentalist and chartist expectations, and of the relative weight of each group in the market.

When heterogeneity is introduced in macroeconomic models, the agents' type is normally exogenously given and constant. In this paper, we analyse a dynamic mechanism that endogenously determines agents' type and therefore the sizes of the different populations of traders. To be specific, we adopt the behaviourally-founded notion of *animal spirits* recently formalised by Franke (2012), in the context of his analysis of business sentiments. We assume that at every moment in time there is a positive probability of each agent changing their status, from chartist to fundamentalist, or vice versa. This probability depends on the key variables of the economy (output, expected capital gains, asset prices), but also on the composition of market traders itself, which allows us to capture herding processes. So it is an interplay between factors concerning the environment of the market and internal factors of the particular market.

Thus, the model economy, constructed in that way, contains two potential sources of instability:

- 1) the feedbacks between real and financial markets via Tobin's q , and
- 2) the endogenous opinion dynamics produced by the interaction of heterogeneous agents on asset markets.

Thus, it allows us to investigate a key question emerging from the current financial crisis, namely whether unfettered, interconnected markets with heterogeneous agents are able to absorb external shocks, or rather tend to amplify them.

We prove that the resulting 4D dynamic system describing the evolution of the economy always has either a single steady state (with uniformly

distributed agents) or three steady states (the one before, a chartist and a fundamentalist one), but even though various subdynamics of the model can be stable (at the uniform or the fundamentalist of the three steady states), the complete system may be repelling around all of its equilibria. Given the complexity of the 4D nonlinear system, though, it is difficult to draw more precise analytical conclusions on the overall dynamics (up to the consideration of two supplementing 2D cases). Therefore, we adopt numerical methods to explore the properties of the considered DSGD model further.

The numerical simulations show that the 4D system is indeed generally a bounded one: all trajectories remain in an economically meaningful subset of the state space. In this sense, the model shows the somewhat surprising result that unfettered markets with possibly accelerating real-financial feedback mechanisms have some in-built stabilising mechanism (based on opinion dynamics) that prevent the economy to move on an infeasible path. Moreover, despite the trivial dynamics of the 2D subsystems, the full 4D dynamics can exhibit somewhat irregular business fluctuations. Though the considered opinion dynamics is generally capable of ensuring upper and lower turning points in the real-financial market interactions, the generated persistent fluctuations may however still be too large to be acceptable from the societal and policy point of view.

We consider therefore various policies that may act as stabilisers of the private sector. Because markets are highly interconnected, we follow Minsky (1982) and consider multiple policy instruments: we in particular show that a Tobin-type tax on capital gains together with a capital market oriented monetary policy rule (the only ‘risky asset’ of the model) can indeed stabilise the economy, in the sense of reducing its volatility. The array of instruments proposed is similar to those obtained by Farmer (2010) from a different modern ‘animal spirits’ approach.

2. Framework

The main purpose of this paper is to analyse the specific sources of instability induced by financial markets participants and by feedback mechanisms between the financial and the real sector. Therefore, we simplify the real part of the Turnovsky (1995) benchmark model of dynamic macro portfo-

lio adjustment⁴ by ignoring inflation and growth, and by representing the quantity adjustment process by means of a dynamic multiplier approach. Specific instabilities arising from the real side of the economy are not taken into consideration. Giving the advantage that this simplifies the Metzlerian inventory accelerator mechanism of the real-side oriented Keynes-Metzler-Goodwin model of Chiarella and Flaschel (2000), thus suppressing it as a source of instability.⁵ As a result, the real part of the economy is always stable (from this partial perspective), provided the propensity to spend is less than one, which must be met in order to be sustainable on the micro level. However, we assume that stock markets have real effects on investment and consumption.

To be precise, we assume that output moves according to a standard dynamic multiplier process, except that the state of trust of the economy,⁶ instead of the short-term rate of interest, influences investment and consumption decisions.⁷ Formally, the law of motion of output (denoted by Y) is⁸

$$\dot{Y} = \beta_y(Y^d - Y) = \beta_y((a_y - 1)(Y - Y_o) + a_k(p_k - p_{ko})K) \quad (1)$$

$$Y_o = \frac{A}{1 - a_y - \frac{a_k b}{\rho_{ko}^e}}, \quad p_{ko} = \frac{bY_o}{\rho_{ko}^e K}$$

where A is autonomous expenditure, ρ_{ko}^e the given steady state value of the return on equity (see below for the general formulation of this rate), b the dividend rate, K total capital stock, a_y the propensity to spend, a_k the impact of Tobin's q on aggregate demand and β_y is the speed of adjustment concerning goods-market disequilibria.⁹

⁴This can be seen as a neoclassical reference point of our analysis, as it develops comparable feedback structures, but makes use of the Rational Expectations hypothesis.

⁵The instability induced in the KMG approach by the wage-price spiral is also ignored.

⁶measured by the price of the capital stock, p_k (equivalent to Tobin's q in this paper).

⁷This linkage was established in formal terms by Blanchard (1981).

⁸For any dynamic variable x , \dot{x} denotes its time derivative, \hat{x} denotes its rate of growth, and x_o denotes its steady state value.

⁹The flow-consistency background of such a Kaldorian dynamic multiplier process is considered in detail in ch. 5 of Chiarella and Flaschel (2000) and extended towards a Metzlerian treatment in their ch. 6. Note that firms (owned by households) hold inventories of goods and money in this framework which are here assumed to be passively changed through windfall profits or losses if goods demand exceeds (falls short of) output. It is

There is only one risky asset traded in the economy: K comprises the various forms of ownership claims on the physical capital stock (such as equities, corporate bonds, and credit) and can therefore be regarded as one representative capital asset. Its quantity is exogenously given. We assume that the market for K is imperfect, owing to information asymmetries, adjustment costs, or institutional restrictions, and therefore prices do not move instantaneously to clear markets. Let b denote the (given) profit share and let π_k^e denote the expected change in stock prices.¹⁰ Profits are entirely distributed as dividends. The expected rate of return on the capital stock ρ_k^e consists of these dividends $\frac{bY}{p_k K}$ and capital gains π_k^e .

$$\rho_k^e = \frac{bY}{p_k K} + \pi_k^e. \quad (2)$$

Following Asada et al. (2011), we postulate a dynamic disequilibrium adjustment process for stock prices:¹¹

$$\hat{p}_k = \beta_k \alpha_k [\sigma_k (\rho_k^e - \rho_{ko}^e)], \quad \alpha_k \in (0, 1), \quad \rho_{ko}^e = \frac{bY_o}{p_{ko} K}. \quad (3)$$

In words, only a fraction α_k of current aggregate excess demand for the capital *stock* $\sigma_k (\rho_k^e - \rho_{ko}^e)$ actually enters the asset market owing to the existence of adjustment costs. Thus, $1/\alpha_k$ represents the delay with which agents wish to clear any stock imbalance $\sigma_k (\rho_k^e - \rho_{ko}^e)$. As Asada et al. (2011) have argued, this approach is necessary in an open economy where *flow* rather than stock imbalances enter the capital account of the balance of payments. But it is also plausible in closed economies, in a continuous time setup, to assume that adjustment processes on the financial markets are somewhat gradual. The flow processes on asset markets are then translated into asset price changes by the speed parameter β_k .

assumed that investment decisions are made by the management of firms which are thus owned, but not directed by the household sector. Note finally that we do not yet consider explicitly capital depreciation, and neglect growth, inflation and government spending and taxes and thus the role of budget deficits in our model. The assumptions seem rather restrictive, but is adequate for the issues we want to cope for the time being.

¹⁰We assume a constant profit share throughout the paper. This is consistent with our assumption of constant output prices, wages, and labour productivity.

¹¹Note that the reference rate ρ_{ko}^e is a parameter of the model which will be equal to the steady state rate by the law of motion for share prices assumed below.

In addition to K (with market price p_k), we have in the background of the model two other financial assets, namely, as is customary, money M and short-term fix-price bonds, B .¹² The CB fixes the interest rate on B at the level r . Since it does not trade in real capital it must then accept households' excess demand for bonds. Households must however hold the same amount of real capital at the 'end' of the trading period, i.e., they can only realise a new composition of money and bonds (not explicitly shown in this paper) if the CB resets r . The allocation of wealth into 'aggregate money' $M + B$ and capital K will thus remain unchanged after each trading period, during which a reallocation of real capital is intended and alters the rate of change of the price of real capital according to the law of motion (3). For the sake of simplicity, we assume that households are focused on the market for real capital to such an extent that their nominal wealth $W = M + B + p_k K$ can be replaced (proxied) by $p_k K$ in their capital demand function, which allows to ignore total private wealth in the above law of motion of stock prices.

Equations (1)-(3) represent the baseline model. In this economy, Tobin's q is measured by p_k , and it plays a key role in breaking down the real/financial dichotomy. Real markets influence asset markets via the role of output as the main determinant of the rate of profit of firms, and thus of the rate of return on real capital. Financial markets feedback to the real side via the impact of Tobin's $q = p_k K / p K = p_k / p = p_k$, assuming $p = 1$, on aggregate demand (either via a consumption or an investment effect).

In order to focus on the stability characteristics of the Tobin feedback channel in isolation, assume for the time being that capital gain expectations are stationary, so that the corresponding 2D system describing the dynamics of Y, p_k is only subject to a Tobin-type accelerator mechanism. The Jacobian J of the real-financial market interaction is:

$$J = \begin{pmatrix} -\beta_y(1 - \alpha_y) & \beta_y a_k \\ \beta_k \alpha_k \sigma_k b / (p_k K_o) & -\beta_y \alpha_k \sigma_k b Y_o / (K_o p_k^2) \end{pmatrix} = \begin{pmatrix} - & + \\ + & - \end{pmatrix}.$$

The trace of J , $tr J$, is unambiguously negative. Then, it is not difficult to prove that if a_y is sufficiently small (but of course still larger than zero as well as smaller than one) and a_k is sufficiently small, the determinant of J , $\det J$, is positive, and the system is locally asymptotically stable around

¹²See Charpe et al. (2011, sec.2) for their explicit representation and also for a critique of allowing government to issue a perfectly liquid asset B , with $p_b = 1$.

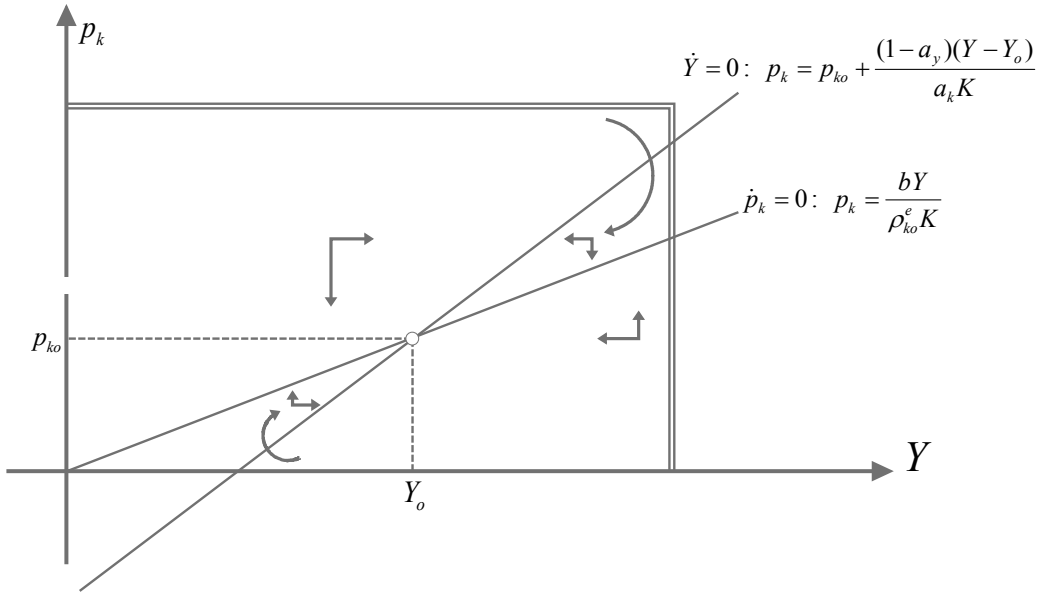

Figure 1: Asymptotically stable real-financial market interaction.

the steady state. This case is illustrated in figure 1. If the above restrictions on a_y and a_k do not hold, then it is possible to have $\det J < 0$, and so the system might display saddle-point dynamics around the steady state. If one assumes that policy is able to reduce the parameters a_y (propensity to spend) and a_k (capital market effect on aggregate demand), at least far off the steady state, then figure 1 suggests that global stability may be obtained. These stabilising forces may however be absent in a neighbourhood of the equilibrium. In this case the steady state is a repeller and figure 1 suggests the existence of a limit cycle within the compact box depicted.

These conclusions only concern the interaction of real and financial adjustment processes and do not depend on the presence of behavioural traders on the financial markets, which are introduced in the next section.

3. Capital gain expectations

Extending the model to include behavioural traders now, we consider financial markets with heterogeneous expectation formation and, following Allen and Taylor (1990) or Frankel and Froot (1990), distinguish between *fundamentalists*, f , and *chartists*, c . Fundamentalists expect capital gains to

converge back to their steady state position (zero in our model). Chartists instead adopt a simple adaptive mechanism to forecast the evolution of capital gains $\dot{\pi}_k^e$. Formally:

$$\begin{aligned}\dot{\pi}_{kf}^e &= \beta_{\pi_{kf}^e} (0 - \pi_{kf}^e), \\ \dot{\pi}_{kc}^e &= \beta_{\pi_{kc}^e} (\hat{p}_k - \pi_{kc}^e).\end{aligned}$$

Heterogeneous expectations are introduced here step by step, meaning that we start first with exogenously given fractions of agent types and analyse dynamic implications of this step, before we finally allow for an endogenous determination of populations.

To be sure, more complex expectation formation mechanisms can be adopted for each type of agent, including forward looking rules, in particular if numerical simulations are intended. Yet, our formulation has the virtue of analytical simplicity, and it allows us to draw a sharp distinction with respect to Rational Expectation models.

Given that agents have heterogeneous expectations, it is not obvious a priori what *market* expectations should be. In standard equilibrium models with efficient markets, heterogeneous information and beliefs are spontaneously aggregated and made uniform under the pressure of market forces. This is clearly not the case in our framework, as it seems rejectable on an empirical basis and is, thus, replaced here. As a first step before full endogenous determination, suppose that the population shares of chartists and fundamentalists, ν_c , $(1 - \nu_c)$, respectively, are constant.¹³ It may be tempting to argue that the market expectation is the weighted average of the expectations of chartists and fundamentalists:

$$\pi_k^e = \nu_c \pi_{kc}^e + (1 - \nu_c) \pi_{kf}^e.$$

It is not clear, however, that this is the theoretically appropriate way of capturing the formation of market expectations. For market expectations π_k^e may actually reflect what both types of agents *think* will emerge from the process of aggregation of fundamentalist and chartist expectations. In other words, market expectations may reflect the agents' view about the 'average' opinion. And this need not be the exact, weighted average of the individual expectations. In turn, the law of motion of market expectations may be the

¹³Population shares are endogenized in the next section.

product of what on average agents think the average opinion and its rate of change will be. In the words of Keynes (1936, p.156):

It is not a case of choosing those which, to the best of one's judgment, are really the prettiest, nor even those which average opinion genuinely thinks the prettiest. We have reached the third degree where we devote our intelligences to anticipating what average opinion expects the average opinion to be. And there are some, I believe, who practise the fourth, fifth and higher degrees.

In this paper, we consider the following simple law of motion for aggregate capital gain expectations:

$$\dot{\pi}_k^e = \beta_{\pi_k^e} [\nu_c \hat{p}_k(Y, p_k, \pi_k^e) - \pi_k^e], \quad (4)$$

where $\beta_{\pi_k^e} > 0$ represents an adjustment speed parameter and where share price inflation only enters expectations with the weight ν_c of the chartists (since the change in their number is not foreseen). We thus assume that adaptive expectations formation drives the expectation of capital gains (to the extent they are present in the market), while fundamentalists are only adding stabilizing forces to it. To be sure, this is only one possible formalisation of the dynamics of aggregate expectations in markets with heterogeneous agents, and alternative approaches can be proposed (see, for example, the approach adopted by De Grauwe and Grimaldi, 2005, in their analysis of the behaviour of agents on foreign exchange markets). Yet, we regard equation (4) as a very parsimonious way of capturing *both* the influence of aggregate observed variables *and* the role of heterogeneity and self-driving forces in expectation formation.

In order to analyse the dynamics of this economy, note that if the weight of chartists in average expectation is zero, the Jacobian of the 3D system (1), (3), (4) at the steady state becomes

$$J = \begin{pmatrix} -\beta_y(1 - \alpha_y) & \beta_y a_k & 0 \\ \beta_k \alpha_k \sigma_k b / (p_k K_o) & -\beta_y \alpha_k \sigma_k b Y_o / (K_o p_k^2) & \beta_k \alpha_k \sigma_k \\ 0 & 0 & -\beta_{\pi_k^e} \end{pmatrix} = \begin{pmatrix} - & + & 0 \\ + & - & + \\ 0 & 0 & - \end{pmatrix}.$$

with $J_{33} = -\beta_{\pi_k^e}$, so that a negative eigenvalue is added to the system. Therefore if a_y is sufficiently small but larger than zero and a_k is sufficiently small, the steady state of the expectations-augmented real-financial interaction process is, again, locally stable. Hence, given the continuity properties of eigenvalues, if a_y is sufficiently close to (but smaller than) one and a_k is sufficiently

small, then the steady state of the Tobin dynamics (1)-(3), augmented by the capital gain expectations rule (4), remains locally asymptotically stable even if the weight of chartists in average expectations formation is positive, but is sufficiently small. Intuitively, fundamentalists – if sufficiently dominant – may counteract any destabilising tendencies that chartists may create.

Instead, if the number of chartists, ν_c , the responsiveness of asset prices to disequilibria, β_k , and / or the responsiveness of the demand for capital stocks to expected returns, $f'(0)$, are sufficiently high, then one may obtain $J_{33} > 0$ and even $trJ > 0$. In this case, if the upper 2×2 minor satisfies the Routh-Hurwitz stability conditions (and the real-financial market interaction as such asymptotically stable), the system becomes unstable by way of Hopf-bifurcations, i.e., in general, by the death of a stable corridor around the steady state or by the birth of stable persistent fluctuations around it. The dynamic system (1), (3), (4) can thus provide a theory of business fluctuations caused by the interaction of real and financial markets.

To be sure, the previous argument and the existence of Hopf bifurcations is only based on a local analysis. Yet one may expect the presence of chartists to lead to explosive dynamics in general, if the speed of adjustment on financial markets or the responsiveness of the demand for capital stock are sufficiently high. This explosiveness may be tamed far off the steady state if nonlinear changes in behaviour or policy reduce β_k and/or α_k enough to make the system globally stable, thus ensuring that all trajectories remain within an economically meaningful bounded domain. We do not analyse this conjecture further here. Rather, in the next section, we explore the possibility that endogenous changes in the agents' populations, ν_c , reduce the influence of chartists far off the steady state and thereby create turning points in the evolution of capital gain expectations.

4. Opinion dynamics

Even if one rejects the assumption of Rational Expectations, agents in financial markets do learn and they may change their behaviour endogenously in response to changes in the key economic variables. In this section, we adopt a version of the herding and switching mechanism developed by Lux (1995) and Franke (2012), which provides behavioural foundations to the agents' attitudes in the financial market. Unlike in standard DSGE models, we do not start from individual optimisation programmes. The switching mechanism is arguably more realistic than DSGE and it is a very elegant

way of capturing *both* rational behaviour *and* purely speculative effects and herding. In fact, agents decide whether to take a chartist, or a fundamentalist, stance depending on the current status of the economy (captured by the key variables Y, p_k), on expectations on the evolution of financial gains (π_k^e), and also on the current composition of the market (captured by the variable x , defined below).

Formally, suppose that there are $2N$ agents in the economy. Of these, N_c are chartists and N_f are fundamentalists so that $N_c + N_f = 2N$. Let $n = \frac{N_c - N_f}{2}$. Following Franke (2012), we describe the distribution of chartists and fundamentalists in the population by focusing on the difference in the size of the two groups (normalised by N). To be precise, we define

$$x = \frac{n}{N} \in [-1, 1], \quad \text{and get} \quad 1 - x = \frac{N_f}{N}, \quad 1 + x = \frac{N_c}{N}, \quad (5)$$

where, as in Franke (2012), N is assumed to be large enough that the intrinsic noise from different realisations when individual agents apply their random mechanism can be neglected. Formally, as in Franke (2012), given the continuous time setting, we in fact take the limit of x as N tends to infinity.

Let $p^{f \rightarrow c}$ be the transition probability that a fundamentalist becomes a chartist, and likewise for $p^{c \rightarrow f}$. The change in x depends on the relative size of each population multiplied by the relevant transition probability.

$$\dot{x} = (1 - x)p^{f \rightarrow c} - (1 + x)p^{c \rightarrow f}.$$

The key behavioural assumption concerns the determinants of transition probabilities: we suppose that they are determined by a *switching index* s , summarising the expectations of traders on market performance. The switching index depends positively on the agent composition of the market (capturing the idea of herding, as the fact that e.g. when chartist attitudes are prevailing the general mood even reinforces chartistic opinions. See Franke and Westerhoff (2009, p.7).), and on economic activity, and negatively on the market value of the capital stock and on average capital gain expectations. Formally, assuming again a functional shape as simple as possible, in order to concentrate on the essential nonlinearities:¹⁴

¹⁴The details of the approach are in Lux (1995) and Franke (2012).

$$s = s_x x + s_y (Y - Y_o) - s_{p_k} (p_k - p_{k_o})^2 - s_{\pi_k^e} (\pi_k^e)^2. \quad (6)$$

This switching index assumes – besides the herding term and the role of economic activity as in Franke (2012) – that the deviations of share prices and capital gain expectations from their steady state values (in both directions) favour opinion making in the direction of the fundamentalists, because doubts concerning the macroeconomic situation become widespread. This change can be interpreted as a change in the state of confidence, whereby agents believe that increasing deviations from the steady state eventually become unsustainable. A similar approach concentrating on price p_k misalignment is used in Franke and Westerhoff (2009, eq.6).

An increase in s is assumed to increase the probability that a fundamentalist becomes a chartist, and to decrease the probability that a fundamentalist becomes a chartist. More precisely, assuming that the relative changes of $p^{c \rightarrow f}$ and $p^{f \rightarrow c}$ in response to changes in s are linear and symmetric:

$$p^{f \rightarrow c} = \beta \exp(as), \quad (7)$$

$$p^{c \rightarrow f} = \beta \exp(-as). \quad (8)$$

Given the above assumptions, the complete 4D dynamic system becomes:

$$\dot{Y} = \beta_y [(a_y - 1)(Y - Y_o) + a_k (p_k - p_k^o) K] \quad (9)$$

$$\hat{p}_k = \beta_k \alpha_k \sigma_k (\rho_k^e - \rho_{k_o}^e) \quad (10)$$

$$\dot{\pi}_k^e = \beta_{\pi_k^e} \left[\frac{1+x}{2} \hat{p}_k - \pi_k^e \right] \quad (11)$$

$$\dot{x} = \beta [(1-x) \exp(as) - (1+x) \exp(-as)] \quad (12)$$

where s is given by eq. 6. Equations (9)-(12) represent our baseline DSGD model. All variables are here dynamic in the sense that their evolution over time is described by more or less gradual adjustment processes, and no algebraic equilibrium condition is involved (only the definitional equation for s). Markets are essentially interconnected and there are various feedback mechanisms between them.

The key theoretical and policy question is, whether the unfettered market economies described by the DSGD model, where real/financial feedbacks play a prominent role and expectation formation may be affected by herding

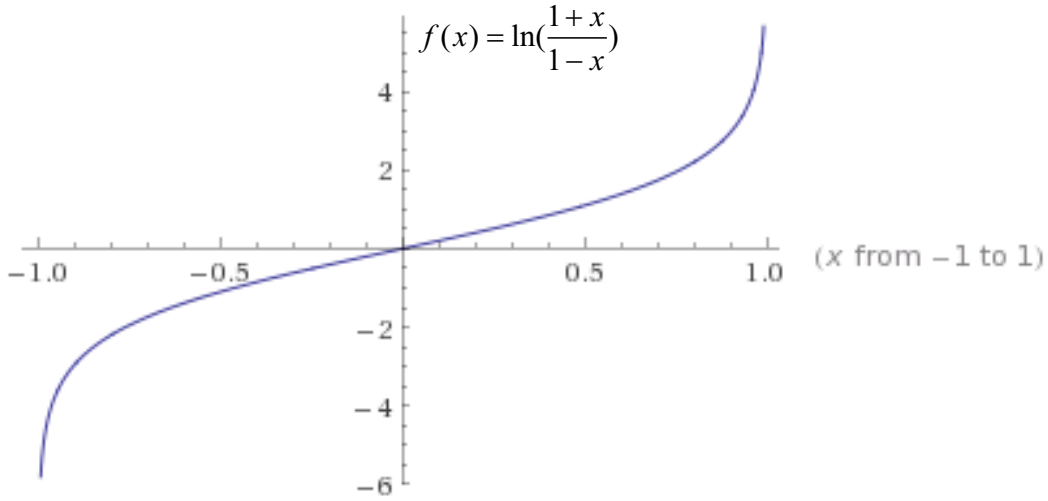

Figure 2: The core of the switching function $f(x) = \ln(\frac{1+x}{1-x})$, $f'(0) = 2$ (which when set equal to $2as_x x$ gives the steady state values for x).

behaviour, display explosive trajectories, or rather whether they contain some inherent stabilising mechanisms. As a first step, note that the dynamic system (9)-(12) always has the following steady state:

$$Y_0 = A/(1 - a_y), \quad (13)$$

$$p_{ko} = bY_0/(\rho_{ko}^e K), \quad (14)$$

$$\pi_{ko}^e = 0, \quad (15)$$

$$x_o = 0. \quad (16)$$

If $s_x \leq 1/a$ then this steady state is unique (the first three values are always uniquely determined). If $s_x > 1/a$, then there are two additional steady state values for $x_o : e_f, e_c$, one where chartist are dominant and one where the opposite holds true (all other steady state values remain unchanged). This is suggested by the backward-bending shape of the $\dot{x} = 0$ - isocline in figure 3, but is to be obtained in fact by what is shown in figure 2 (which is based on the assumption of given unique steady state values $Y_o, p_{ko}, \pi_{ko}^e = 0$). The figure 2 – and the derivative of this function at 0 – shows that $as_x < 2$ must hold for the case of a uniquely determined steady state value $x_o = 0$.

Before analysing the dynamics of the complete system, it is interesting to consider the properties of the opinion dynamics and the expectation part of the model in isolation. We thus assume that output and dividend payments

are fixed at their steady state values. This yields the following 2D system:

$$\dot{\pi}_k^e = \beta_{\pi_k^e} \left[\frac{1+x}{2} \beta_k \alpha_k c - 1 \right] \pi_k^e, \quad (17)$$

$$\dot{x} = \beta [(1-x) \exp(as(x, \pi_k^e)) - (1+x) \exp(-as(x, \pi_k^e))]. \quad (18)$$

First, note that x always points inwards at the border of the x -domain $[-1, 1]$. Then, it can be conjectured that there must be an upper and a lower turning point for π_k^e in the economically relevant phase space $[-1, 1] \times [-\infty, +\infty]$ and that, if the steady state $(0, 0)$ is unstable, the generated cycle stays in a compact subset of this phase space. The expectation herding mechanism would thus be bounded, if taken by itself.

Franke (2012) shows this conjecture to be correct in the context of a formally similar 2D system. Here we simply note that \dot{x} approaches infinity if there is an unlimited increase, or decrease, in the capital gains inflation rate π_k^e . However, as x approaches zero from above or from below, \dot{x} would go to zero if it did not cross the vertical axis at $x = 0$. This is a contradiction and therefore there must always be an upper or lower turning point for capital gain inflation or deflation.

The phase space of the 2D system (17)-(18) is shown in figure 3. The diagram is drawn under the assumption that $s_x > 2/a$, and so there are three steady states (e_f, e_o, e_c) . The horizontal axis is an invariant set of the dynamics which cannot be left (or entered) in finite time. Focusing on this part of the $\dot{\pi}_k^e = 0$ - isocline we see that both the fundamentalist and the chartist steady state (e_f, e_c) are attracting, but that this only holds for the fundamentalist equilibrium, when the economy is subject to non-zero capital gain expectations.

The $\dot{x} = 0$ - isocline is:

$$\pi_k^e = \pm \sqrt{\frac{s_x x - \ln \sqrt{\left(\frac{1+x}{1-x}\right)}/a}{s_{\pi_k^e}}},$$

and it is attracting with respect to x , since x falls whenever π_k^e is above the isocline and it rises if π_k^e is below it. Note that this isocline is not defined for values of x that make the numerator inside the square root negative. Figure 3 displays some innovative features, as compared to the 2D phase diagrams in the literature, though the outcome of the 2D subdynamics is a fairly trivial

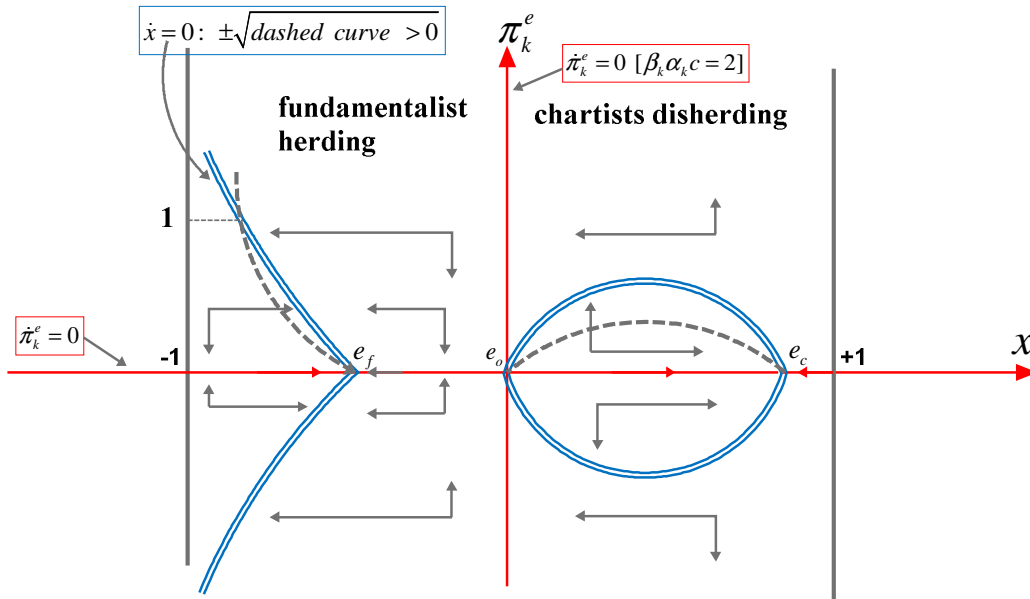

Figure 3: Bounded herding Behaviour.

one, since only the equilibrium where fundamentalists dominate is by and large a stable one. The figure 3 also suggests that the economy remains in a bounded subset of the state space, if capital gains depart too much from their steady state value (which is zero), due to the strong effects this has on opinion dynamics.

However, because the law of motion of expected capital gains is not easily mapped onto figure 3, it is difficult to analyse the properties of the full 4D system. One should expect the local dynamics to be unstable without policy intervention, since the real-financial markets interaction, in connection with opinion dynamics, is likely to be of centrifugal nature. This raises the issue of the global viability of the unfettered market economy. For based on the analysis of the 2D systems, we cannot conclude that the trajectories of the full 4D dynamic system will always remain in an economically significant subset of the state space.

Given the strong nonlinearity of the opinion part and also in the rate of return function of the 4D dynamics (despite the simple linear behavioral rules we have adopted), we shall address these questions by means of numerical simulations in the next section. They will show that interesting irregular and persistent fluctuations in the real and financial variables of the model can be

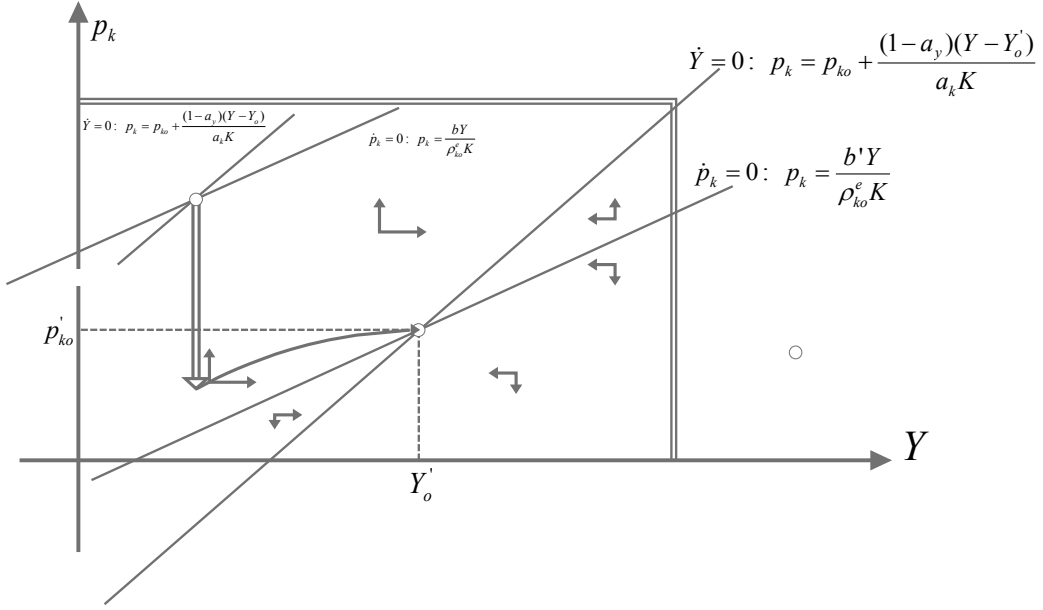

Figure 4: Rational expectations imply real-financial market interactions that – after a tailored jump in the share price p_k – converge to the steady state of the post-shock dynamics.

generated, quite in contrast to what is possible in such a model type under the assumption of the homogeneous rational expectations of the mainstream literature.

In the latter case one assumes in the deterministic case, see Turnovsky (1995) for a variety of examples, that π_k^e is simply given by \hat{p}_k . The population dynamics and a separate law of motion for share price expectations is then redundant and we get for the law of motion of share prices in this case:

$$\begin{aligned} \hat{p}_k &= \beta_k \alpha_k \sigma_k \left(\frac{bY}{p_k K} + \hat{p}_k - \rho_{ko}^e \right) \\ &= \frac{\beta_k \alpha_k \sigma_k}{1 - \beta_k \alpha_k \sigma_k} \left(\frac{bY}{p_k K} - \rho_{ko}^e \right) = \frac{1}{1 - 1/\beta_k \alpha_k \sigma_k} \left(\rho_{ko}^e - \frac{bY}{p_k K} \right) \end{aligned}$$

We restrict our investigation of the rational expectations approach on the likely case where $\beta_k \alpha_k \sigma_k > 1$ holds true in which case the last fraction to the right is positive. Formally seen, the 2D dynamics of section 2 is now self-contained in this modification of its second law of motion. Moreover, the isoclines in figure 1 remain in their position and the dynamics are now pointing upwards above the $\dot{p}_k = 0$ - isocline and vice versa. This situation is

shown in figure 4. In this figure we also consider a shock to the economy which moves both isoclines into a new position (for graphical reasons). Assuming the economy to have been in the steady state of the old dynamics then implies (by assumption) a jump of share prices p_k onto a unique position on the stable arm of the post-shock dynamics (if these dynamics are determinate) along which they and output then converge to the new steady state position. This is a very tranquil theoretical scenario for what is assumed to happen in the financial markets.

We have shown by means of figure 4 that the RE school basically trivializes the deterministic skeleton of the analysis of real-financial market interactions. Moreover, it also needs in the presently considered model the side condition that

$$a_y < a_k b / (\rho_{k_0}^e K)$$

holds true in order to get the saddle-point dynamics shown in figure 4. What happens in the opposite case is therefore not explained by the RE-methodology of the DSGE approaches, but blocked out from consideration.

5. Numerical simulations

As for the investigation of the global features of the nonlinear 4D dynamics, we reformulate the model in discrete-time in order to simulate it for different parameter sets. We use a standard Euler discretization to re-write the model. It is done with a sufficiently small step-size (high-frequency) in order to reproduce qualitatively the same results as the continuous counterpart.¹⁵

In the following, different types of shocks to the economy are considered, based at first on a choice of parameters which is characterised by the occurrence of business cycles as will be shown: $\beta_{\pi_k^e} = 4$, $\beta_k = 2.723$, $\alpha_k = 0.5$, $c = 2$, $b = 0.28$, $s_{\pi_k^e} = 0.5$, $a = 1$, $\beta_y = 2$, $a_y = 0.6$, $a_k = 0.35$, $A = 1$, $K = 1$, $\rho_0^e = 0.25$, $s_y = 0.1$, $s_x = 0.8$ and $s_{p_k} = 0.04$. On the basis of these parameter choices we get the following somewhat irregular and persistent, but not yet really complex¹⁶ fluctuations in the state variables of the model.

¹⁵See Flaschel and Proaño (2009) for a detailed consideration of this procedure with respect to the period length employed. Moreover, the procedure of Euler-discretization is admissible here, as we show that no chaotic dynamics occur.

¹⁶when their Largest Liapunov Exponent is measured.

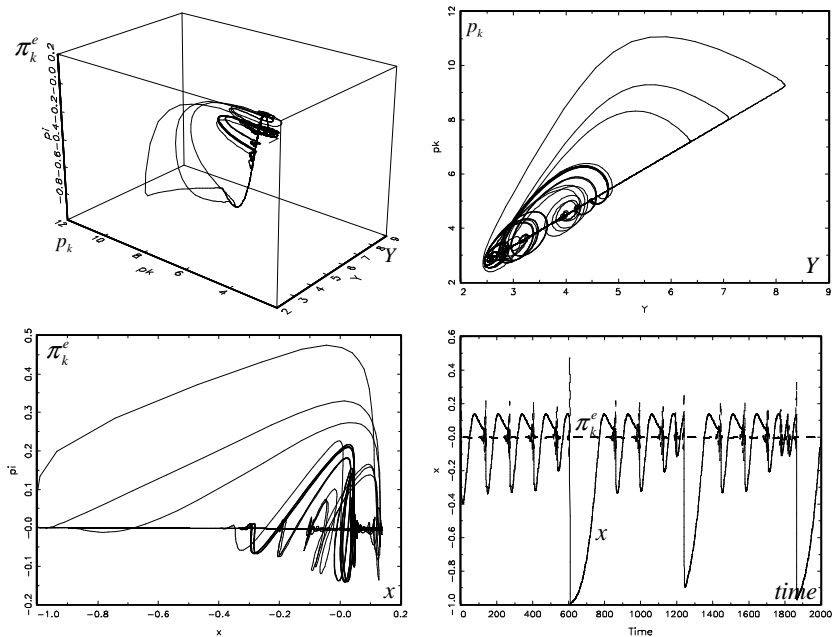

Figure 5: Irregular persistent business fluctuations.

Other configurations may deliver more stable outcomes, but these constellation of values cannot be safely excluded from consideration on economic grounds. So it makes sense to test the stability properties of the model in the parameter regions that might exhibit non-convergence. These are then implying potential crises, which the economy easily runs into, as speed and other parameters vary over time and stability gets lost as non-convergence values are crossed eventually.

We observe relatively regular sequences of smaller and larger fluctuations in for example the opinion dynamics x which sometimes go close to the extreme -1 where no chartist would be present any more. We have chosen here however an extreme case, right at the border of the viability of the dynamics, so that further (significant) increases of the parameter $\beta_k = 2.723$ will lead to a breakdown of the system. There is therefore no hope in this case to get more complex dynamics by making β_k larger and larger.

Figure 5 shows on the left the (very) long-run attractor (its projection into the output / stock price subspace) of what is shown in figure 5 as still transient behavior of the dynamics.

We repeat the phase sub-diagram of figure 5 top-right here in 5a in order

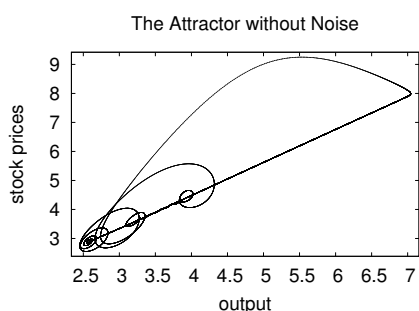

Figure 5a

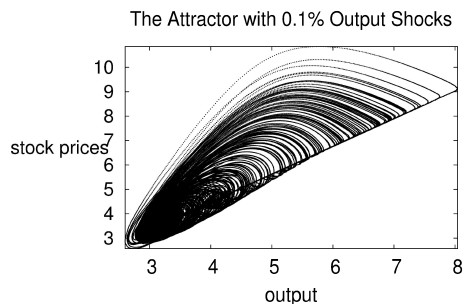
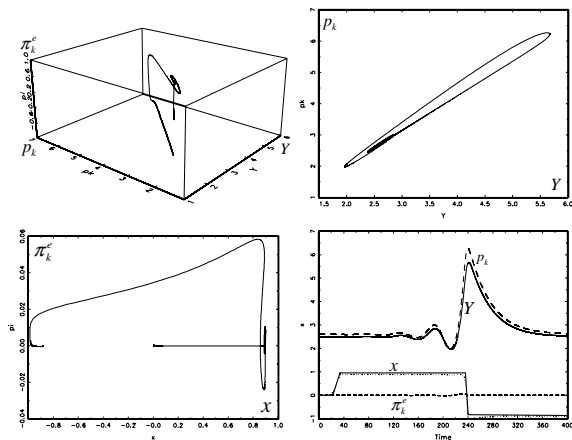

Figure 5b

to compare its deterministic outcome with the situation on the right, in figure 5b, where the attractor is shown with noise added to the system (in fact to output Y , uniformly with standard deviation 0.01, using the software package E&F Chaos with otherwise preset conditions). We can see that noise matters in this situation of already somewhat irregular business fluctuations quite a lot, however not to the extent that it destroys the qualitative features of the attractor of the consider example. This is our first example of what we consider an outcome of the DSGD type.

The third simulation example, in figure 6, the top four diagrams, show that if we set $s_{p_k} = 0.06$, $s_x = 1.6$ and if we assume $\beta_{\pi_k^e} = 0.4$, $\beta_k = 2$, $b = 0.26$ (slight variations of the starting values, which may easily come about), then persistent herding of chartists can in fact emerge for quite a while in a seemingly tranquil environment, though it is also visible that the instability of the economy is slowly increasing in this situation. Therefore, this is only a ‘temporary’ illusionary impression of the working of the economy, since after a (considerable) time span, the dynamics become explosive to such a degree that the population share switches quickly into a case which is dominated by fundamentalist (a case significantly below $x = 0$). It there finally comes to rest at a fundamentalist-dominated equilibrium which also stabilises the rest of the economy. The expectational part behaviour is accompanied by a drop in output and share prices and an even bigger boom thereafter before the chartist prevailance is replaced. The real and financial sides then land softly at a new steady state position after a while. Again to be stated, other cases of parameter choice can be less problematic, but since parameter changes occur



time series of population share and stock price

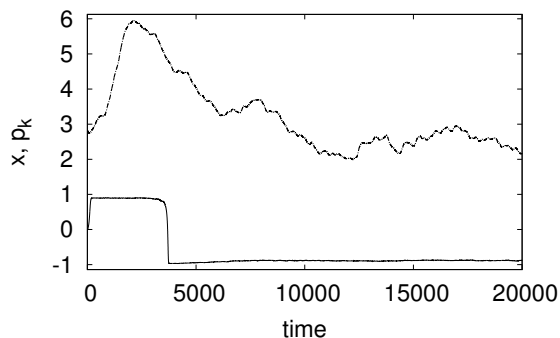

Figure 6: Multiple equilibria and temporary chartist herding: Without and with noise

gradually these presented thresholds will be passed eventually and trigger the implied irregular dynamics. Justification in detail will be provided by way of bifurcation analyses below.

Figure 6, at the bottom, again adds noise with variance 0.03 to the evolution of output Y which has a visible effect on both stock prices and populations shares which in the second case are however somewhat modest (even when the scale is chosen to be the interval $[-1, +1]$). The temporarily nearly fixed chartist position is shorter in the case where noise has been added. since the stock prices start rising nearly immediately now. while they moved only a little bit for quite a while in the deterministic case. In the deterministic

case we moreover see that output and stock prices are strictly pro-cyclical in their evolution.

Next we provide a first robustness test for the considered dynamical system. The employed software and the program listing (including parameter values is described in the appendix of the paper. Of crucial importance is the choice of the speedparameters β_i , as they constitute one of the distinguishing features of a disequilibrium approach, which are not needed in an equilibrium setting. We vary in this numerical simulations at first only the speed of adjustment of the expected stock price inflation and this between 0 and 10, i.e., over a very large range for this speed of adjustment. We test viability only over a horizon of 40 years and plot within this range only the last thirty years. The step size of the iteration is 0.01 so that the number of iterations has to be divided by 100 in order to get the time window expressed in years. In the figure 7, the first four plots show for this situation the behavior of the state variables where in fact – due to the chosen step size – only the minimum and maximum value of the state variable matter as information at each value of the parameter $\beta_p i$. The plots were generated using the bifurcation diagram routine in E&F Chaos which however does not supply in the nearly continuous case more information than was just stated. A next step – which allows for bifurcation diagrams in continuous time – would thus be to plot only the local minima and maxima of the four considered state variables which would allow to see period doubling routes into complex dynamics and more.

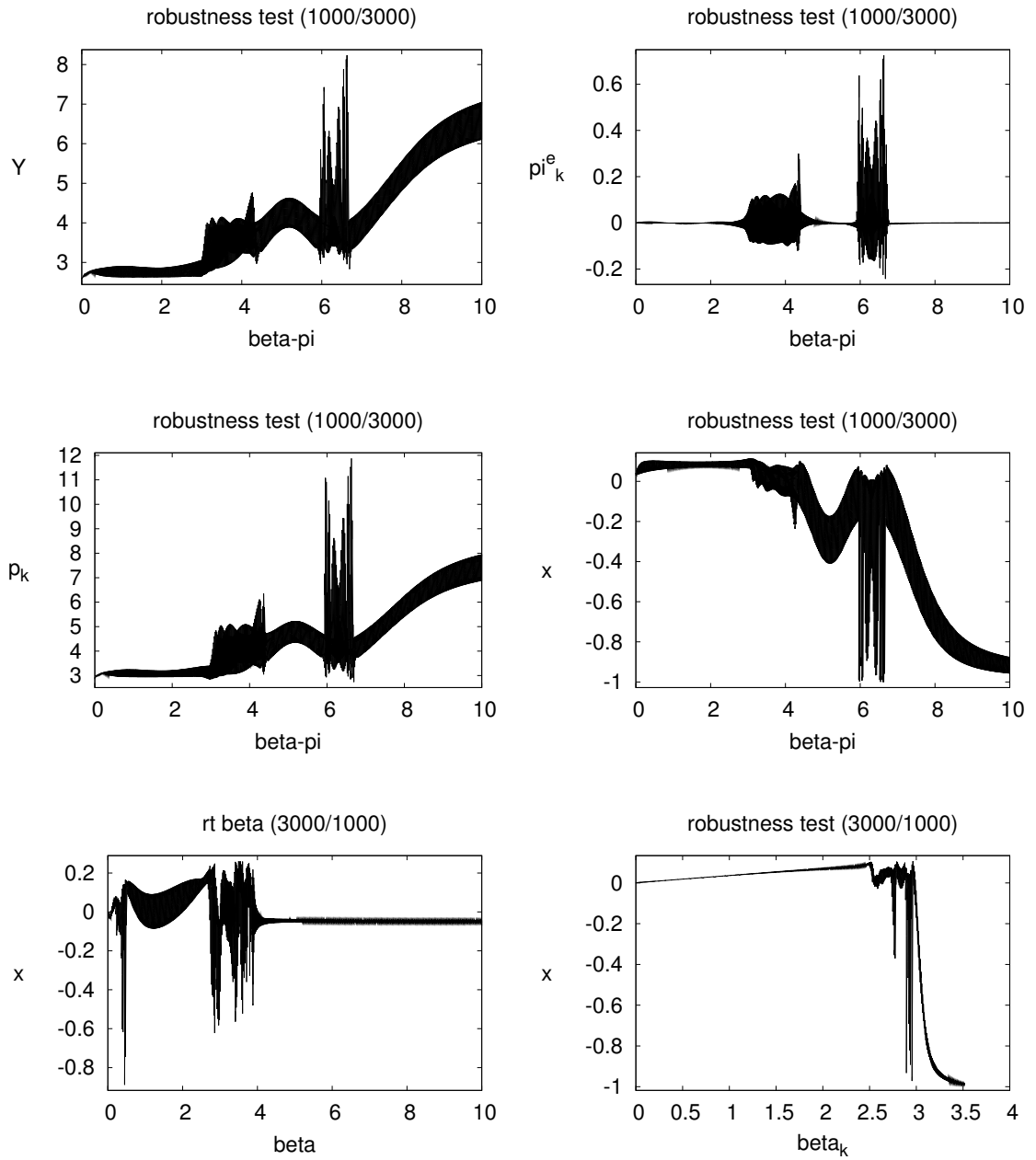

Figure 7: Varying speeds of adjustment and a testing of the viability of the model

It is interesting to compare the behavior of the state variables as the parameter β_π is varied. In particular the repeatedly occurring convergence to nearly a zero rate of expected stock price inflation is remarkable. This is correlated with relatively small fluctuations around positions where the proportion of chartists is low. On the left hand side of the first four figures we can see also that output and stock price dynamics is strongly correlated when viewed from this global perspective. The two figures at the bottom show left the variation of the speed in the population dynamics and right of the speed of stock price adjustment. We can see that increases in the former are stabilizing and thus allow for a huge variation again between zero and ten, while the latter is not (the dynamics breaks down before reaching the speed value four).

6. Some policy issues

Next we consider some policy experiments again by way of diagrams which check the robustness of the dynamics for a certain parameter range. Traditional anti-cyclical fiscal policy, i.e. here, a decrease in the marginal propensity to spend a_y can avoid problems in the behavior of the model which in the present example demands for a fairly low overall propensity to purchase in order to make the dynamics viable. It appears therefore that the present example needs a fairly low multiplier value for this to occur. The reasons for such a demand are not obvious from the chosen set of parameter values.

Unorthodox anti-cyclical fiscal policy, which reacts in view of what happens with stock prices, i.e., a lowering of the parameter a_k , is also stabilizing (as was to be expected), but not in a sense that can be perceived as monotonic as the parameter a_k is decreased. By contrast, increasing interest rates on short-term bonds, i.e. here, the assumption of a decreasing capital demand parameter c , since assets are allocated thereby away from the capital stock, clearly help to stabilize the economy, as always primarily from the viewpoint of its viability, but now also by reducing its volatility in a monotonic fashion.

This however is again not the case if taxes on dividends are introduced and increased which lowers the profitability parameter b in the expected rate of return function. There is finally the possibility to raise Tobin-type taxes on stock market transactions of the capital gains \hat{p}_k there achieved. As many authors since Keynes (1936) and Minsky (1982, 1986) have stressed, the main function of stock markets should be to ensure the efficient allocation

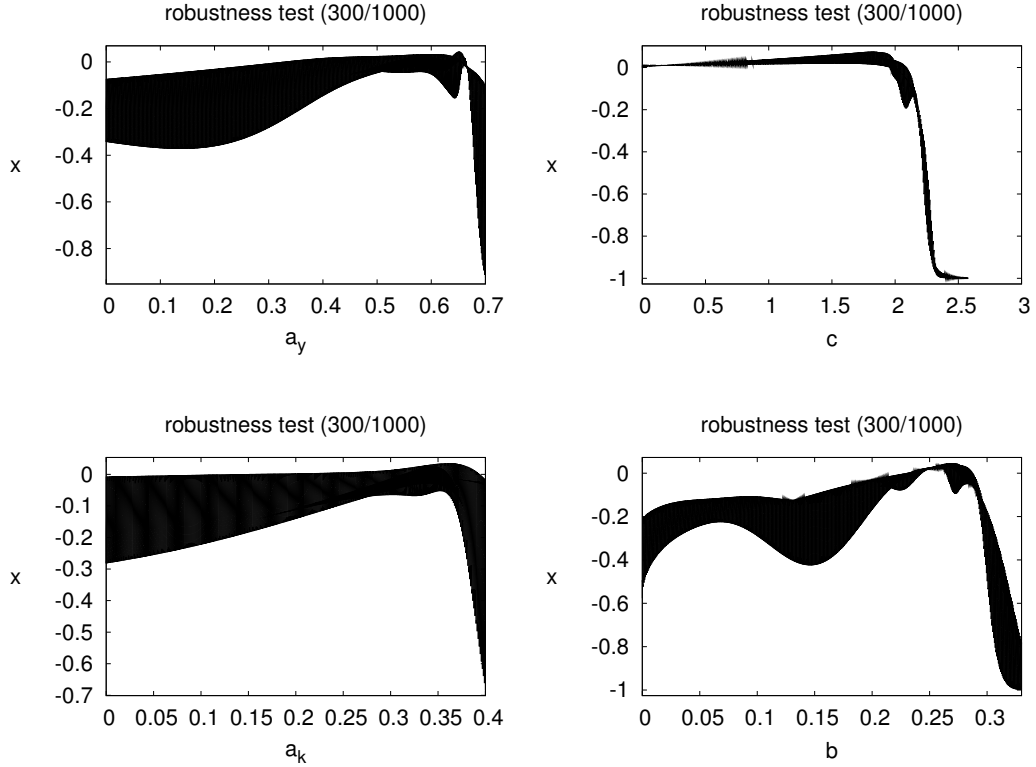

Figure 8: Policy Issues

of savings, and gambling activities should be constrained. It is therefore appropriate to consider a *Tobin type tax (or subsidy)* on capital gains at rate τ_k , leading to a total tax revenue equal to $\tau_k \dot{p}_k K$. The law of motion for capital gain expectations (11) can then be re-written as:

$$\dot{\pi}_k^e = \beta_{\pi_k^e} \left[\frac{1+x}{2} (1 - \tau_k) \hat{p}_k - \pi_k^e \right],$$

and Tobin taxes therefore indeed have a stabilising effect by weakening the impact of chartists on the process of market expectation formation. The figure 8 summarizes the first four findings on these policy issues.

The source of instability in the real economy was the Tobin accelerator of section 2, and one way of stabilising the saddle point dynamics in the real-financial interaction subsystem might also be a sort of ‘Quantitative Easing’, whereby the Central Bank directly intervenes on asset markets in response

to the state of the economy: it increases aggregate demand for capital during downturns and reduces it during booms, thus affecting the price of capital which in turns affects consumers' and investors' decisions.

Formally, we may assume that the Central Bank sets a policy parameter $m_k > 0$ that represents its responsiveness to the output gap. The real-financial subsystem (1)-(3) then becomes:

$$\begin{aligned}\dot{Y} &= \beta_y[(a_y - 1)Y + a_k(p_k - p_k^o)K + A], \\ \hat{p}_k &= \beta_k \left[\alpha_k c \left(\frac{bY}{p_k K} - \rho_{ko}^e \right) - m_k \left(\frac{Y}{K} - \frac{Y_o}{K} \right) \right].\end{aligned}$$

The Jacobian of this system has, again, the following structure:

$$J = \begin{pmatrix} -\beta_y(1 - \alpha_y) & \beta_y a_k \\ \beta_k \alpha_k \sigma_k b / (p_k K_o) - m_k / K_o & -\beta_y \alpha_k \sigma_k b Y_o / (K_o p_k^2) \end{pmatrix} = \begin{pmatrix} - & + \\ + & - \end{pmatrix},$$

but the determinant of J is now more likely to be positive, thanks to the policy m_k , which reduces J_{21} in magnitude and subsequently rises the probability of $J_{11}J_{22} - J_{21}J_{12} > 0$. Thus, this type 'Quantitative Easing' has indeed a stabilising effect by counteracting the unstable spiral of positive reinforcement in the process of the interaction of the real with the financial markets.

7. Hints on complex dynamics

In this section we briefly investigate the area around the chosen critical parameter value $\beta_k = 2.723$, see the appendix, and provide an example of bifurcation diagrams where only the local minima and maxima are plotted.

In figure 9 we show to the left a bifurcation diagram, obtained from E&F Chaos by eliminating the first 1000 years in the time series for each parameter value on the horizontal axis, and by plotting thereafter the next 100 years. The convergence to the intermediate steady state $x = 0$ gets abruptly lost around the parameter value $\beta_k = 2.477$ and the behavior becomes immediately of the type shown in the next figure 10. Thereafter the dynamics changes its erratic behavior in a sequence of locally similar outcomes, until it breaks down at around a value of 2,82. Figure 9, on the right, shows the Largest Liapunov Exponent corresponding to this behavior, obtained from E&F Chaos by using 1000 years of initial iterations and then 1000 years of iterations as demanded in this submodule of the E&F Chaos software.

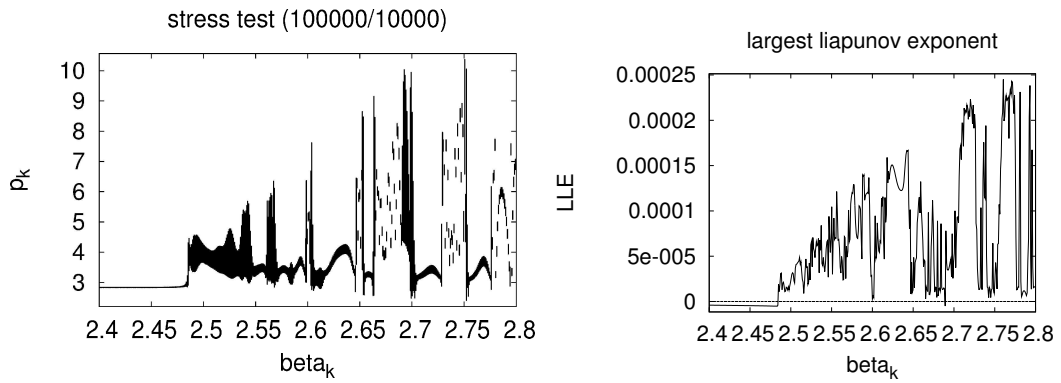

Figure 9: From convergence to stress: Bifurcation diagram and the corresponding Largest Liapunov Exponent.

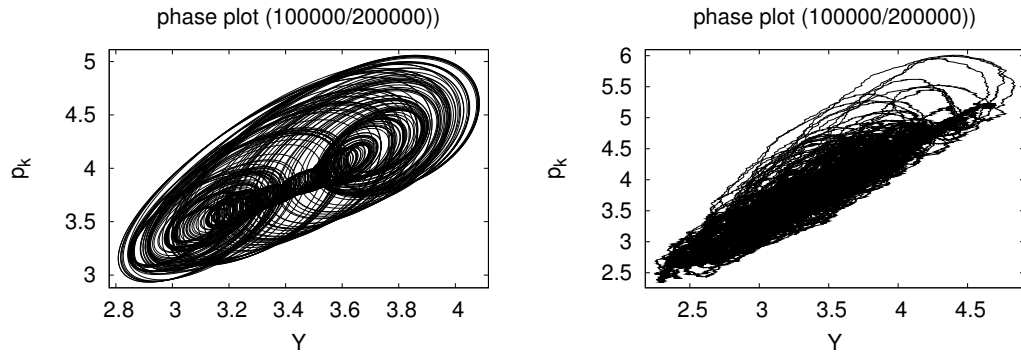

Figure 10: Complex dynamics with no noise ($\beta_k = 2.478$) and with noise (variance $0.01Y$).

In figure 11 we finally plot a bifurcation diagram where only the local minima and maxima of the state variable on the vertical axes are plotted against the parameter a_k . This suggests that the dynamics are becoming increasingly irregular as the impact of the stock market on aggregate goods demand is increased.

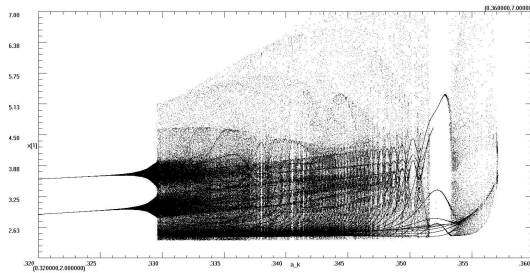

Figure 11: Bifurcation diagram showing local maxima and minima on the vertical axes for variations of the parameter a_k

Summing up, we can state that the simulations demonstrate the global viability of the fully integrated 4D dynamics. The \dot{x} mechanism is clearly pointing inside and presents a crucial part of the model which keeps the behaviour of the system by and large bounded. Yet the steady states of the dynamics may be locally unstable, and the economy may face severe and fairly irregular booms and busts along its business fluctuations. The considered very simple DSGD-type interaction of the real with the financial markets therefore can become very complex once heterogeneous expectations and switching agent behavior is introduced into them. This stands in stark contrast to the global asymptotic stability which is characteristic for the DSGE models of the literature. It remains to be said that the simulations only provide examples of the manifold outcomes that this simple model of real-financial market interaction and opinion dynamics can generate.

The last figure indicates what happens if the period length is varied and, thus, gives an additional robustness check for the validity of our obtained results. We show that small values of h do not change very much, while larger ones of course matter and thus raise the question which period length is in fact the appropriate one. Fortunately, in macroeconomics we know the quite fundamental fact that the generation (not necessarily the observation) of the macro-data is high frequency in nature, We thus need not even look for result on larger period length, but can right from the start rely on small values of the period length h in the Euler discretization and if still problematic with respect to accuracy on even still smaller ones.

However, the examples we have treat in this paper are close to complex dynamics already. Therefore qualitative similar outcomes for slightly varied period lengths can only be expected over the short-run of say three years of so. For the longer run more refined methods have to used to evaluate the

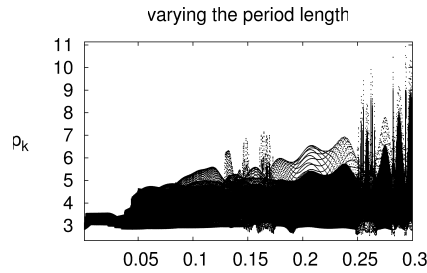

Figure 12: Varying the period length h of the model

differences in the orbits generated by the dynamics within a range of daily down to hourly or even less long period lengths.

8. Conclusions

A Dynamic Stochastic General Disequilibrium model in the Keynesian tradition was presented as an alternative to the perceived DSGE paradigm. In our model, the assumptions of market clearing and rational expectations are dropped. Instead a set of gradual, dynamic adjustment processes take place on highly interconnected real and financial markets. A Tobinian accelerator process drives the evolution of real macroeconomic activity. Financial markets, described by a risky representative capital stock asset, influence the state of trust of the economy, as measured by Tobin's q , and thus consumption and investment decisions. In turn, the performance of the real sector influences agents' decisions on financial markets via the profit rate. We showed that this interaction need not be stable. Further, we introduced heterogeneous expectations in financial markets populated by chartists and fundamentalists, and showed that chartist behaviour is another potential source of instability in the economy.

The crucial theoretical, empirical, and policy question arising then is whether unregulated market economies contain some mechanisms ensuring the stability or global boundedness of the economy if centrifugal forces prevail, making the equilibrium locally unstable and, potentially, the system explosive.

Numerical simulations show that global stability can be ensured if, far off the steady state, opinion dynamics favours fundamentalist behaviour during booms and busts which ensures that there are turning points in both of these

situations. However, both the local analysis and the simulations suggest that such market economies can nevertheless be plagued by severe business fluctuations and recurrent crisis phenomena. Moreover, certain non-excludable parameter constellations imply complex and close to chaotic dynamics.

We show among others that two policy measures often advocated in the Keynesian literature, namely Tobin taxes, here on capital gains, and quantitative easing, can mitigate these problems.

Closing this paper with some remarks on our treatment of expectation formation, which suggest interesting lines for further research. First, one may argue that the theoretical expectation rules characterising chartists and fundamentalists, and the process of formation of market expectations should be replaced by more sophisticated backward- and forward-looking rules based on econometric estimation techniques. It would certainly be interesting to analyse the impact of different expectation rules on the system (which is numerically not a huge step). But we do not expect these changes to significantly affect the qualitative conclusions of our analysis.

Second, in our formalisation of market expectations, we suppose the agents' guessing process is stopped after one step: market expectations are what agents think they will be on average. We consider this as a first step into the analysis of more complex processes of aggregate expectation formation. Once one drops the assumption of Rational Expectations, other possibilities can be explored, including Keynes' (1936) celebrated 'third degree' process, where agents try to anticipate what *average opinion* expects average opinion to be. We leave this suggestion for further research.

References

Allen, H. and Taylor, M.P., 1990, Charts, Noise and Fundamentals in the London Foreign Exchange Market, *The Economic Journal*, 100, 49-59.

Asada, T., Flaschel, P., Mouakil, T., Proaño, C.R., 2009. *Asset Markets, Portfolio Choice & Macroeconomic Activity*, Basingstoke: Macmillan.

Benes, J., Kumhof, M., 2012, The Chicago Plan Revisited, IMF Working Paper WP/12/202.

Blanchard, O. 1981. Output, the Stock Market, and Interest Rates. *American Economic Review*, 71(1), 132-143.

Branch, W. A. and G.W. Evans, 2011, Monetary Policy and Heterogeneous Expectations, *Economic Theory*, 47(2), 365-393.

Brunnermeier, M.K., 2008, Bubbles. In: Durlauf, S., Blume, L. (Eds.), *The New Palgrave Dictionary of Economics*, 2nd Edition, Palgrave Macmillan.

Chari, V., Kehoe, P., McGrattan, E., 2009. New Keynesian Models: Not yet useful for policy analysis. *American Economic Journal: Macroeconomics*, 1, 242-266.

Charpe, M., Chiarella, C., Flaschel, P. and W. Semmler, 2011a. *Financial assets, debt and liquidity crises: A Keynesian approach*. Cambridge University Press, Cambridge.

Charpe, M., Flaschel, P., Hartmann, F. and C.R. Proaño, 2011b, Stabilising an unstable economy: Fiscal and Monetary Policy, Stocks, and the Term Structure of Interest Rates. *Economic Modelling*, 28, 2129-2136.

Charpe, M., Flaschel, P., Proaño, C. and W. Semmler, 2012, Credit-Financed Investment, Dual Labor Markets and International Capital Markets in a Macrodynamic Two-Country Framework. ILO working paper

Chiarella, C., Flaschel, P., 2000. *The Dynamics of Keynesian Monetary Growth: Macrofoundations*. Cambridge University Press, Cambridge.

Chiarella, C., Flaschel, P., Franke, R., Semmler, W., 2009. *Financial Markets and the Macroeconomy. A Keynesian Perspective*. Routledge, New York.

Chiarella, C., Flaschel, P., Hartmann, F., Proaño, C.R., 2012. Stock Market Booms and Credit Creation: Implications of Broad and Narrow Banking for Macroeconomic Stability, *Journal of Economic Behaviour and Organisation*, .

De Grauwe, P., 2010. The scientific foundation of dynamic stochastic general equilibrium (DSGE) models. *Public Choice*, 144, 413-443.

De Grauwe, P., Grimaldi, M., 2005. Heterogeneity of agents and the exchange rate: A nonlinear approach. In: De Grauwe, P. (Ed.), *Exchange*

Rate Economics: Where Do We Stand?. CESifo Seminar Series, MIT Press, Cambridge, pp. 125-168.

Diks, C., Hommes, C. Panchenko, V., van der Weide, R., 2008, E&F Chaos: A user friendly software package for nonlinear economic dynamics. *Computational Economics*, 32, 221-244.

Farmer, R.E.A., 2010. How to reduce Unemployment: A new Policy Proposal. *Journal of Monetary Economics*. Carnegie Rochester Conference Series on Public Policy, forthcoming.

Flaschel, P., Malikane, C., Proaño, C., 2011. Output, Stock Markets and Macro-Policy Measures in a Keynesian Portfolio Model. *Intervention, European Journal of Economics and Economic Policies*, 8(2), 341-360 .

Flaschel, P., Hartmann, F., Malikane, C. and C. Proaño (2015): A Behavioral Macroeconomic Model of Exchange Rate Fluctuations with Complex Market Expectations Formation
Computational Economics, 45(4), 669-691, doi: 10.1007/s10614-014-9437-8.

Flaschel, P. and C.R. Proaño, 2009. The J2 Status of "Chaos" in Period Macroeconomic Models. *Studies in Nonlinear Dynamics & Econometrics*, 13(2).

Franke, R., 2012. Microfounded animal spirits in the new macroeconomic consensus. *Studies in Nonlinear Dynamics and Econometrics*, *Studies in Nonlinear Dynamics and Econometrics*, 16:4, Article 4.

Franke, R. and F. Westerhoff, 2009. Estimation of a Structural Stochastic Volatility Model of Asset Pricing. Working paper: Kiel Univeristy.

Hartmann and Flaschel, 2014, Financial Markets, Banking and the Design of Monetary Policy, *Economies*, 2 (1), 1-19.

Keynes, J.M., 1936. *The General Theory of Employment, Interest and Money*. Macmillan, London.

Lux, T., 1995. Herd Behaviour, bubbles and crashes. *Economic Journal*,

105, 881 - 889

Massaro, D., 2012, Heterogeneous expectations in monetary dsge models. CeNDEF Working paper 12-02.

Menkhoff, L., Rebitzky, R., Schröder, M., 2009. Heterogeneity in Exchange Rate Expectations: Evidence on the Chartist-Fundamentalist Approach. *Journal of Economic Behaviour & Organization*, 70(1-2), 241-252.

Minsky H., 1982. Can "It" Happen Again? M.E. Sharpe, New York.

Minsky H., 1986. *Stabilising an Unstable Economy*. Yale University Press, New Haven, CT.

Proaño, C.R., 2011. Exchange Rate Determination, Macroeconomic Dynamics and Stability under Heterogeneous Behavioral FX Expectations. *Journal of Economic Behaviour and Organization*, 77, 177-188.

Tobin, J., 1982. Money and the Macroeconomic Process. *Journal of Money, Credit and Banking*, 14, 171-204.

Tovar, C.E., 2009. DSGE Models and Central Banks. *Economics: The Open-Access, Open Assessment E-Journal*, Vol. 3, 2009 - 16.
<http://www.economics-ejournal.org/economics/journalarticles/2009-16>

Turnovsky, S., 1995. *Methods of Macroeconomic Dynamics*. MIT Press, Cambridge, MA.

Appendix

Regarding numerical simulations we have made use here of the (really user-friendly) software E&F Chaos which was developed at the Center for Nonlinear Dynamics and Finance (CeNDEF) at the Faculty of Economics and Business, Universiteit van Amsterdam. This tool for the numerical analysis of dynamic period models as well as continuous-time ODE systems can be downloaded from the webpage of the CeNDEF and is discussed in detail (from the viewpoint of period models primarily) in Diks, Hommes, Panchenko and van der Weide (2008). In this paper we have used the following simple code (without comments and hard returns in long lines in the original program listing):

The model as written for E&F Chaos (as an ordinary text-file):

Initial conditions:

Y=2.75, pk=2.8, pi=0, x=0

Parameter values:

bpi=4, bk=2.723, alk=0.5, c=2, b=0.28, beta=0.2, sx=0.8, spi=0.01, a=1,
by=2, ay=0.6, ak=0.35, barA=1, barK=1, rhoo=0.25, sy=0.1, spk=0.06,
h=0.01 (step size)

d(iscrete time)

Yo=barA/(1-ay) pko = b*Yo/(rhoo*barK)

Laws of motion:

Y1 = Y+h*by*((ay-1)*(Y-Yo)+ak*(pk-pko)*barK)

pk1 = pk+h*pk*bk*alk*c*(b*Y/(pk*barK)+pi-rhoo)

pi1= pi+h*bpi*((1+x)/2*bk*alk*c*(b*Y/(pk*barK)+pi-rhoo)-pi)

x1= x + h*beta*((1-x)*math.exp(a*(sy*(Y-Yo)-spk*(pk-pko)^2+sx*x-spi*pi^2))
-(1+x)*math.exp(-a*(sy*(Y-Yo)-spk*(pk-pko)^2+sx*x-spi*pi^2)))

Iteration:

Y=Y1

pk=pk1

pi=pi1

x=x1