

Weaver, Paul M.; Gabel, H. Landis; Bloemhof-Ruwaard, Jacqueline M.; Van Wassenhove, Luk N.

Working Paper

Optimising environmental product life cycles: A case study of the European pulp and paper sector

Nota di Lavoro, No. 88.1997

Provided in Cooperation with:

Fondazione Eni Enrico Mattei (FEEM)

Suggested Citation: Weaver, Paul M.; Gabel, H. Landis; Bloemhof-Ruwaard, Jacqueline M.; Van Wassenhove, Luk N. (1997) : Optimising environmental product life cycles: A case study of the European pulp and paper sector, Nota di Lavoro, No. 88.1997, Fondazione Eni Enrico Mattei (FEEM), Milano

This Version is available at:

<https://hdl.handle.net/10419/154850>

Standard-Nutzungsbedingungen:

Die Dokumente auf EconStor dürfen zu eigenen wissenschaftlichen Zwecken und zum Privatgebrauch gespeichert und kopiert werden.

Sie dürfen die Dokumente nicht für öffentliche oder kommerzielle Zwecke vervielfältigen, öffentlich ausstellen, öffentlich zugänglich machen, vertreiben oder anderweitig nutzen.

Sofern die Verfasser die Dokumente unter Open-Content-Lizenzen (insbesondere CC-Lizenzen) zur Verfügung gestellt haben sollten, gelten abweichend von diesen Nutzungsbedingungen die in der dort genannten Lizenz gewährten Nutzungsrechte.

Terms of use:

Documents in EconStor may be saved and copied for your personal and scholarly purposes.

You are not to copy documents for public or commercial purposes, to exhibit the documents publicly, to make them publicly available on the internet, or to distribute or otherwise use the documents in public.

If the documents have been made available under an Open Content Licence (especially Creative Commons Licences), you may exercise further usage rights as specified in the indicated licence.

**Optimising Environmental Product Life Cycles:
A Case Study of the European Pulp and Paper Sector**

(running head: Optimising Environmental Product Life Cycles)

Paul M. Weaver

Lecturer in Geography, University of Durham, UK

H. Landis Gabel

Professor of Economics and Management, INSEAD, France

Jacqueline M. Bloemhof-Ruwaard

PhD candidate, Wageningen Agricultural University, The Netherlands

Luk N. Van Wassenhove

Professor of Operations Management and Operations Research, INSEAD, France

Abstract

In this paper, we propose a methodology, based on materials accounting and operational research techniques, to assess different industry configurations according to their life cycle environmental impacts. Rather than evaluating a specific technology, our methodology searches for the feasible configuration with the minimum impact. This approach allows us to address some basic policy-relevant questions regarding technology choice, investment priorities, industrial structures, and international trade patterns.

We demonstrate the methodology in the context of the European pulp and paper industry. We are able to show that current environmental policy's focus on maximising recycling is optimal now, but that modest improvements in primary pulping technology may shift the optimal industry configuration away from recycling toward more primary pulping with incineration. We show that this will have significant implications for the amount and type of environmental damage, for the location of different stages in the production chain, and for trade between European member states. We caution policy makers that their single-minded focus on recycling may foreclose investment in technologies that could prove environmentally superior. Finally, we hint that member state governments may be fashioning their environmental policy positions at least in part on some of the trade and industrial implications we find.

[JEL Classification: Q2, C6]

[Keywords: environmental policy, pulp and paper, life cycle, optimisation, technology lock-in, recycling, geography of production, environment-trade conflict]

1. Introduction

Environmental policy has become more stringent in the last decades, and it has evolved from prescribing specific but limited end-of-pipe technologies to, in some instances, dictating holistic industry development paths, competitive structures, and international trade patterns. Perhaps this is a mark of its progress. But if more stringent and holistic environmental policy makes mistakes, for example, by locking in wrong technologies, the cost may be very high. And the possibility of mistakes has not lessened with the maturation of the policy making process. There are still technological, market, and environmental uncertainties ahead and little scientific consensus on the appropriate methodology for comparing the environmental impacts of product and process alternatives. Furthermore, the incentive for governments to pervert the policy process for industrial and international trade benefits is increasing as environmental policy becomes more stringent and pervasive.

The objective of this paper is to show with a case study how some of these risks are manifested and how one particular methodology can help mitigate them. In the paper, we demonstrate a methodology to evaluate alternative product life cycle design structures and to illuminate the sensitivity of environmental performance to different technical and structural choices which policies of various kinds can influence. Our methodology, based on materials accounting and operational research techniques, seeks the environmentally optimal sectoral configuration in both the short run with existing technology and in the longer run with some assumptions about prospective technologies. This reverses the tradition of predicting the consequences of an exogenously specified environmental policy instrument.

What we offer is not an overarching environmental policy, per se. Rather, we offer a methodology which we believe can usefully complement others in the goal of making wiser public policy. In particular, we believe it can help provide answers to some of the most basic questions of policy analysis, answers that are important inputs to policy design.

- * What currently feasible sector configuration gives the lowest life cycle environmental impact? By how much can a sector's environmental performance be improved in the short and longer term with existing and prospective technologies? What does this imply for setting public policy priorities?

- * Where in the product life cycle is the greatest potential for reducing environmental impacts through technological change? What does this imply for public and private sector research and development priorities?
- * What kinds of public policy measures would be most effective in reducing environmental impacts in the short and long term? What is the risk that short term expedients lock out better long term options?
- * What do different sector configurations imply for individual countries' industrial and international trade performance? How might the answer influence the positions those countries take in the policy process?
- * Would a change in society's relative concerns about different kinds of environmental damage change the optimal sectoral configuration? What does this imply about the robustness of environmental policy to new discoveries in environmental science? What does it imply for setting environmental science research priorities?

We take recycling in the European pulp and paper sector as our case study. In the pulp and paper sector, the era of end-of-pipe palliatives is now passé. The European Commission and several member state governments are promoting mandatory recycling as one of their principal environmental policy tools even though many analysts consider its benefits ambiguous. Some argue that recycling may simply change the type of environmental damage done by the sector (e.g., Virtanen and Nilsson, 1992, 1993) or that recycling may be optimal in one situation but not in another (Udo de Haes, 1994). In any case, there is no scientific consensus on the appropriate methodology for evaluating its environmental impacts in comparison with those of alternatives.

The level of recycling on which policy has focused has implications for more than environmental quality. It will influence the use of different technologies, the geographical distribution of production, and individual countries' industrial and trade performance. That is, it is a holistic policy. Given the extent of its implications, recycling has unsurprisingly raised the suspicion that some governments are manipulating environmental policy to serve their national trade and industrial policy interests.

Finally, mandating recycling percentages represent new command and control policy making in an era when market-based instruments are generally favoured by policy analysts. We will show that mandatory recycling, typical of command and control regulations generally, risks locking out better long run alternatives.¹ We suggest that market-based policies might avoid this problem.

Although pulp and paper recycling is our case example, we believe that what we present here is more generally relevant. The methodological approach we take is equally applicable to other sectors where holistic environmental policies are profoundly shaping industrial and technological trajectories.

In the following sections, we discuss the recent shift in approach to environmental policy making in the European pulp and paper sector, describe our model and its rationale, give its results, and conclude with their implications.

2. Environmental policy in the European pulp and paper sector

Pulp and paper has historically been and still is a major polluter. Different types of damage arise at different stages of the life cycle: forestry, pulp production, pulp bleaching, paper production, consumption, waste management, and transportation (Figure 1). The principal direct environmental impacts of the sector are associated with its consumption of raw materials, including primary energy resources, and its emissions to air, water, and land (Virtanen and Nilsson, 1992). There is also a major induced impact on forest ecosystems arising from the demand for pulpwood. These impacts contribute to a wide range of environmental and human health problems of local, regional, and global significance.

¹ There is an extensive literature on the phenomenon of technological lock-in. The basic reference is

Figure 1. Flow chart of pulp and paper industry

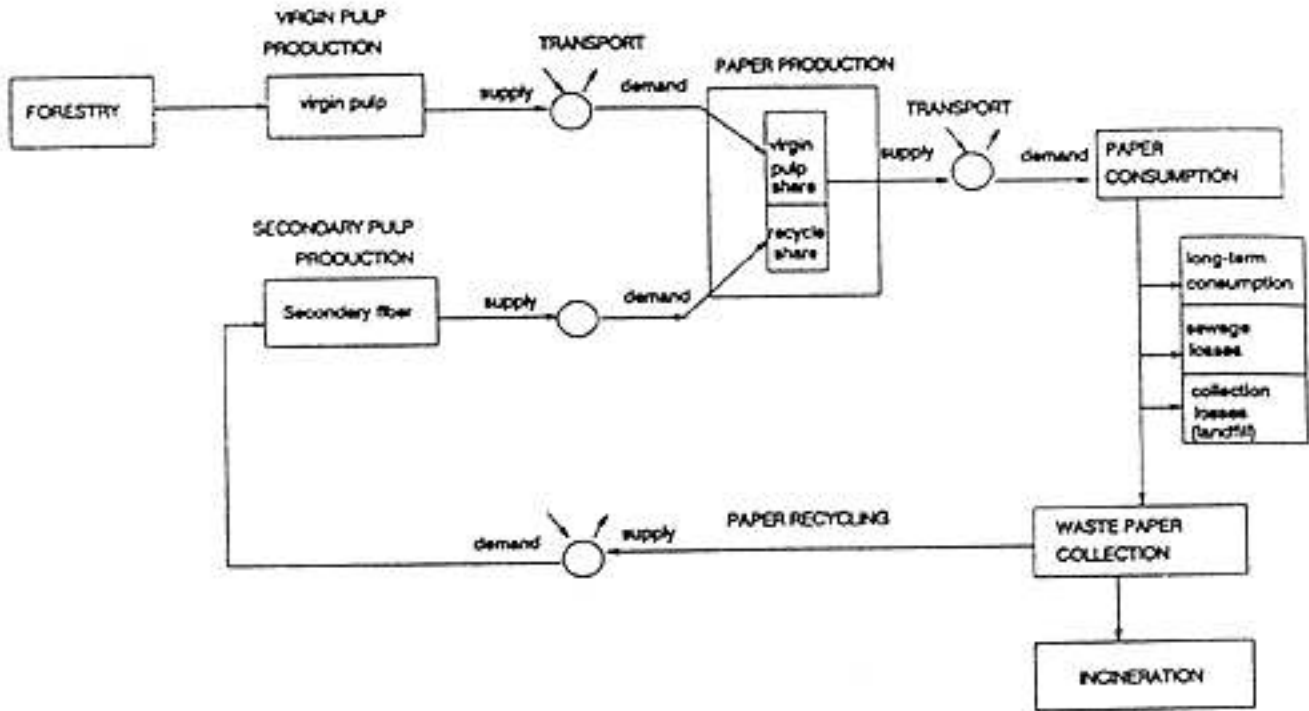
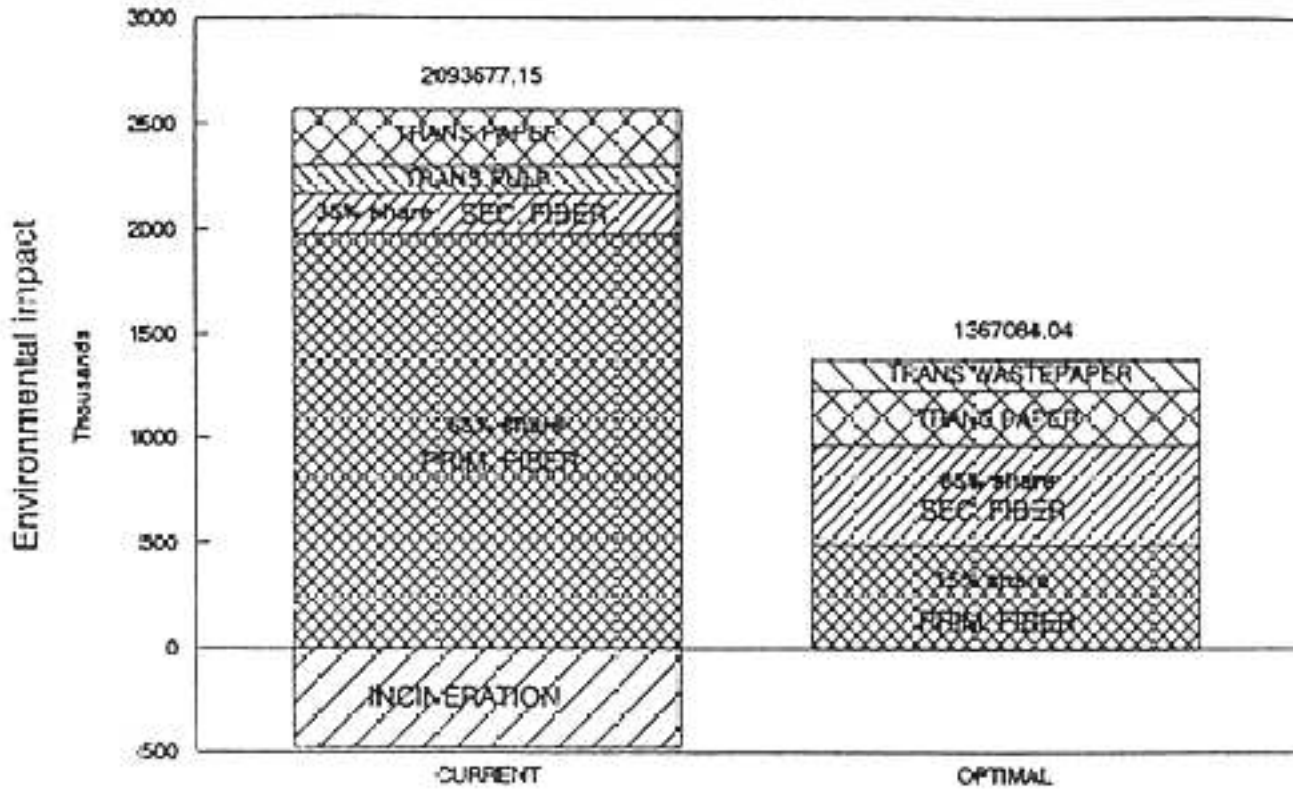

Figure 2. Contribution to environmental impact



This need not be so, however. Many (including Greenpeace) believe that pulp and paper could be among our most environmentally benign major industries. The environmental burden of the production processes can be improved. Paper's basic input, wood, is renewable if properly managed. The output - waste paper - can be recycled and ultimately incinerated to produce energy (Udo de Haes, 1994).

Aggressive environmental policy in the past has focused on emissions to air and water from pulping, bleaching, and paper making. A combination of policy instruments (mostly emission ceilings) and industry responses (end-of-pipe and process-integrated emission controls) has reduced chlorine and chlorine-compound emissions from pulp and paper mills substantially, and elemental chlorine is being phased out as a bleaching agent (Rajotte, 1994). By developing systems for the recovery and reuse of its wastes, the industry has reduced its draw on raw materials, including fossil energy.

Now, environmental concern has shifted to the sector's effect on forest ecosystems upstream and its generation of solid waste downstream from the basic production processes. Environmental policy is shifting accordingly to encompass the entire product life cycle.

Proposed or actual policies (Capps and Devas, 1994) include:

timber certification. Certificates will only be granted to pulp, paper, and board products made from timber produced from sustainably managed forests.

eco-labelling. Several eco-labelling schemes have been proposed or are currently operating at the EU and national levels. To qualify, the fibre source must be responsibly managed, production processes must comply with relevant emission standards, fossil energy use must fall below a specified threshold, and the product must be recyclable.

Britain's "Brands-Eco" scheme and the Nordic Swan offer a label to some paper and board products produced exclusively from primary fibre. All other schemes give labels only to products made at least in part from secondary (i.e., recycled) fibre. The German "Blue Angel" label is awarded only to papers that contain 100% recycled fibre. The EU's eco-label will exclude all products based

exclusively on virgin fibres, implicitly providing market advantages to recycled fibre (Rajotte, 1994).

eco-taxes. The Belgium government has proposed a tax of BF 10/kg (approximately US \$285/tonne) on paper and board products failing to meet specified secondary fibre content. The threshold proposed for magazines is 60%. The tax would be halved if the products were made from chlorine-free pulp.

facility licensing. As part of a strategy for Integrated Pollution Prevention and Control, production facilities will need licences to operate. Licences will only be granted if pulp and paper mills satisfy the relevant national emissions conditions.

mandated waste paper recovery and secondary fibre contents. An EU directive on packaging sets minimum targets for the levels of recovery of packaging waste and the secondary fibre content of packaging materials (50% and 60% respectively).

Whether by design or default, these policies are beginning to influence the evolution of the technological and geographical configuration of the sector (Weaver, 1995). The various activities in the pulp and paper value chain occur in different places, and thus the importance of environmental policies differs geographically. Yet, since different activities and places are linked, actions to reduce an environmental impact in one place may have serious implications for activities that occur elsewhere. For example, mandatory fibre recycling, which helps reduce continental Europe's solid waste problem, has environmental, industrial, and international trade implications for Scandinavia, the main supplier of primary (or "virgin") pulp. These industrial and international trade side effects of environmental policy help motivate our modelling.

3. The Model

The principal goal of the modelling is to find the configuration of the European pulp and paper sector that minimises the environmental burden of satisfying existing consumer demands. The modelling process entails minimising the value of the objective function in the model (the value is called the sector's *environmental impact*) which totals all the environmental costs of the pulp and paper life cycle. (For an exposition on the life cycle methodology, see EPA, 1993a, 1993b.) A basic ingredient of the objective function is the set of environmental damage coefficients - the *environmental indices* - for each of the processes in the life cycle. These indices combine objective information about the environmental characteristics of each process with a subjective evaluation of the relative

importance of different types of environmental damage. The mathematical minimisation of the objective function must be done while satisfying a number of constraints which ensure that the result is feasible. These constraints are explained in greater detail below.

The optimal sector configuration will entail a pattern of production, consumption, waste management, and transportation. The flows imply the geography and the technologies of the sector including levels of raw materials demand, production, and international trade. As noted above, exploring some of these implications is also a goal of the modelling.

One should note what the model does not do as well as what it does. The model does not maximise social welfare. Were that the objective, many more costs and benefits would have to be introduced and the problem would be much more complex. Nor does it model behaviour because it does not incorporate any decision-making agents. The objectives, constraints, and parameters are all fixed in accordance with environmental, market, and technological data as is common with mathematical programming methods. For the same reason, the model is not dynamic. The data are fixed at a point in time - generally the present. Of course, these data can be changed to allow scenario comparisons, including some that evolve through time. This we will demonstrate. Finally, the model does not compare the costs of arranging different sector configurations or of developing and operating the new technologies used in some of the scenarios we analyse. We should point out, however, that most of the sector configurations we examine are feasible given existing fixed investments. Additional major investment costs are thus unnecessary. And although a few of our scenarios entail technologies that are not currently feasible, all such technologies are close to being developed, and the completion of their development will come irrespective of the scenarios we describe. So again, there are no significant investment cost differences to concern us.

The first step in the modelling exercise is to construct a linear programming flow model to track the raw materials, mass commodities, products, and wastes between processes and geographical regions. Our focus on recycling rates allows us to simplify the model since changes in recycling rates affect only some flows and the levels of use of only some processes. We can ignore paper and board production and consumption since they are essentially unaffected by the fibre furnish. We assume that waste paper is either recycled for its fibre or incinerated for its energy content, so we ignore land filling.

The various pieces of the flow model include:

primary pulp production and bleaching. We define four primary pulp types: bleached sulphate, unbleached sulphate, bleached sulphite, and bleached thermo-mechanical.

product flows. The model differentiates six paper and paperboard types: printing, newsprint, hygienic/tissue, boxboard, fluted, and special grades.

fibre recovery and recycling. The availability of secondary (recovered) fibre depends on the paper usage. Hygienic papers enter the sewage system and are not collected. Most other paper and board products become collectable scrap paper. The waste paper collection rate and the fibre recovery rate are critical system characteristics.

incineration with energy recovery. In the model, collected waste paper that is not recycled is incinerated to recover its heat energy.

transportation of materials between processes. The model includes six regions within Europe - Scandinavia (Sweden and Finland), Germany, France, UK, Italy, and Iberia (Spain and Portugal) - and one representing the rest of the world. These account for most of Europe's pulp and paper producing capacity, consumption, and waste paper capacity (see Table 1). A distance matrix gives the shortest road or sea routes between regional capitals. Transportation between regions is differentiated by ship and truck which have different environmental impacts. Internal (within region) transportation is not considered.

Table 1. Pulp, paper, waste paper capacity and consumption

Region	Pulp capac. 1990 (%)	Paper capac. 1990 (%)	Waste paper capac. 1990 (%)	Primary Pulp Consum. (x1000 tonnes)	Waste Paper Consum. (x 1000 tonnes)	Secondary Pulp Consum. (yield = 0.88) (x 1000 tonnes)
Scand.	57	27	6	14,397	1,091	970
Ger.	7	19	25	5,428	5,735	5,098
Fra.	7	11	15	3,621	3,295	2,929
UK	2	8	17	2,551	2,570	2,284
Italy	3	9	12	2,176	246	219
Iberia	9	8	9	1,740	518	460
Total	85	82	82	29,913	13,455	11,960

Source: OECD (1993)

The second step is to develop an *eco-balance* for each process based upon an inventory of relevant inputs (e.g., fossil fuel consumption) and outputs (e.g., HC or CO₂ emissions). This includes direct inputs and outputs and those incurred upstream of the considered process during the production of intermediate products and their pre-cursors. This is especially important for forestry. Not all environmental impacts are negative, of course. When processes generate surplus energy, as do primary pulping and waste paper incineration, the model gives an environmental credit equal to the avoided environmental damage of fossil fuel consumption.

In our model, we use the *eco-balance* for each primary pulp type that represents the existing average mix of technologies. Our *eco-balances* for primary pulps and for transportation are based on BUWAL (1991) and for recycling and incineration on Virtanen and Nilsson (1993). With relevance to some of the results that follow, any changes in technology can be represented in this inventory phase. One just replaces the old technology with the new and builds a new *eco-balance*. Appendix A shows an example of what the *eco-balances* look like.

The third step is to prepare an *eco-profile* from the eco-balances. The significance of the different inputs and outputs in the eco-balances depends upon their contributions to environmental damage. I.e., all the different emissions that contribute to global warming must be weighted and aggregated; similarly for those causing acidification and each other type of environmental damage. There are several schemes for classifying different types of damages and for weighing and aggregating the data of the eco-balances to create the eco-profile (CSG, 1993). We have followed SETAC guidelines because they separate the contribution of a single output to multiple types of damage.

SETAC recognises seven categories of environmental damage relevant to the pulp and paper sector: global warming, human and eco-toxicity, photochemical oxidation, acidification, nutrification, and solid waste. The Centre of Environmental Science at Leiden provides a scoring matrix which indicates the relative contribution of the different emissions to each of these (CML, 1992). This provides the basis for deriving a score for each process with respect to each type of damage. These scores are normalised over global levels of emissions to provide an eco-profile for the process (Guinée, 1993).

In developing these eco-profiles, we assume that the environmental impacts of the individual technologies are the same in each region; i.e., that the same eco-profile for the different primary pulp types applies in all six European regions. We also assume one paper type representative of the average of all paper and board grades produced and consumed. The results of the eco-profile and normalisation are given in Appendix B.

A final step in the modelling is to assign weights to the different kinds of damage to reflect their differing costs to society and then to aggregate them into the overall environmental index for each process. As noted above, these are the environmental damage coefficients in the objective function. In our base runs, we ascribed equal costs to the different kinds of damage. The indices for the different processes are presented in Table 2.

Table 2. Environmental indices

Process	Environmental Index
Pulp/sulphate/bleached	67.531
Pulp/sulphate/unbleached	56.607
Pulp/sulphite/bleached	178.080
Pulp/TMP/bleached	69.178
Recycled pulp	12.173
Incineration	-18.120
Transport/truck	0.018
Transport/ship	0.002

In the search for the optimal configuration - the one with the lowest environmental impact - the decision variables include the level of recycling, the production of primary pulp by type, and the transportation flows. By implication these specify the technological and geographical configuration of the sector and are associated with environmental impacts of specific levels, types, and places. The configuration also specifies the sector's demand for raw materials, including pulpwood and the amount of recovered energy.

To ensure feasibility, the optimisation is done subject to constraints on:

paper production and paper consumption. In most of the results, we assume that these are fixed at their current levels for each region as reported by the OECD (1993). This implies that total pulp demand and waste paper supply are fixed for each region. In one of the results to be reported below, we fix production for Europe as a whole but allow it to shift from one country to another.

capacity. Primary pulping capacities are also based on OECD (1993) data. Secondary pulping capacity depends on waste paper supply and waste paper imports.

fibre furnish. The balance of use of primary pulps of different types for each paper type is assumed to be fixed. With increasing recycling, secondary fibre displaces primary fibre of different type proportionally up to a fixed maximum level as estimated by Virtanen and Nilsson (1993) and other industry analysts. Following Virtanen and Nilsson (1993), the average fibre requirement for each kilogram of

paper or board is taken as 0.9 kg. Minimum secondary fibre use levels can be set in accordance with prevailing regulations.

secondary fibre supply. There is a maximum secondary fibre recovery potential which limits overall secondary fibre use. Within the flow model, the coefficients for collection rate and for fibre recovery potential are fixed at 0.90 and 0.88 respectively (Virtanen and Nilsson, 1993). Collected waste paper not going for fibre recovery is assumed to be incinerated.

flow balance. There is a flow balance condition for primary pulp, secondary pulp, paper and board products, and scrap paper that requires that production plus imports equal consumption plus exports. The "system" represented by the six regions is assumed closed except for imports and exports of paper products from and to the rest of the world. This external trade is assumed to be fixed at prevailing levels. Finally, we assume that production and consumption are balanced. I.e., there is no increase in paper inventories or, for example, in the stocks of book collections.

Appendix C gives a formal presentation of the network flow model.

4. Results

The overall environmental impact of the processes modelled can be reduced by one-third with a shift to an environmentally optimal life cycle configuration. This optimal configuration entails the best currently available technologies for each process and the maximum feasible recycling rate.

Comparing alternatives, recycling is clearly preferable to primary pulp production. Its environmental advantage originates in the eco-balances, where the advantage of recycling - the difference between the environmental impacts of primary and secondary pulp production - outweighs the advantage of primary pulp production - the environmental gain from energy recovery in waste incineration. This finding justifies the current policy emphasis on recycling. The appeal of recycling from a policy perspective is obviously the greater precisely because of its apparently clear-cut advantage. However, we will soon challenge this perception and show that, on closer inspection, the case is not clear-cut. Before doing so, however, we explore the optimal configuration further.

Figure 2 and Tables 3 and 4 compare the current environmental life cycle impact of pulp and paper products with the optimal configuration.

Figure 2 indicates the value of the objective function (the "environmental impact") for the current and optimal configurations at the top of each column and shows how the four processes contribute to it. As is clear, the optimal configuration, relying on recycling rather than incineration, loses the energy credit and incurs the environmental costs of transporting waste paper and processing secondary fibre. Offsetting this, however, is the dramatically lower environmental cost of primary pulp making when its market share drops from its current 65% to 15%.

Table 3 sub-divides the respective objective function's value across the different types of environmental damage.² The table shows that most types of damage (global warming, human toxicity, acidification, and eutrophication) actually increase going from the current to the optimal configuration. One type of damage (solid waste) shows a modest diminution. Most of the improvement in the average (shown also in Figure 2) is due to the change in photochemical oxidation which constitutes approximately 80%-85% of the environmental index of primary pulp. Clearly, a different weighting scheme could reverse this conclusion, but the dominance of photochemical oxidation means that the conclusion is at least robust to modest changes in the weights.

In a variety of tests, we found that altering the weightings applied to different forms of impact had little effect on the relative impact scores of the different processes. This was true even with extreme variations in the weighting system such as a five-fold increase in the weight of climate change. Photochemical oxidation was the one exception. If it were assumed to have no weight at all, then there should be a consequent large-scale shift away from secondary fibre in paper products.

Figure 3. Market shares in total pulp production

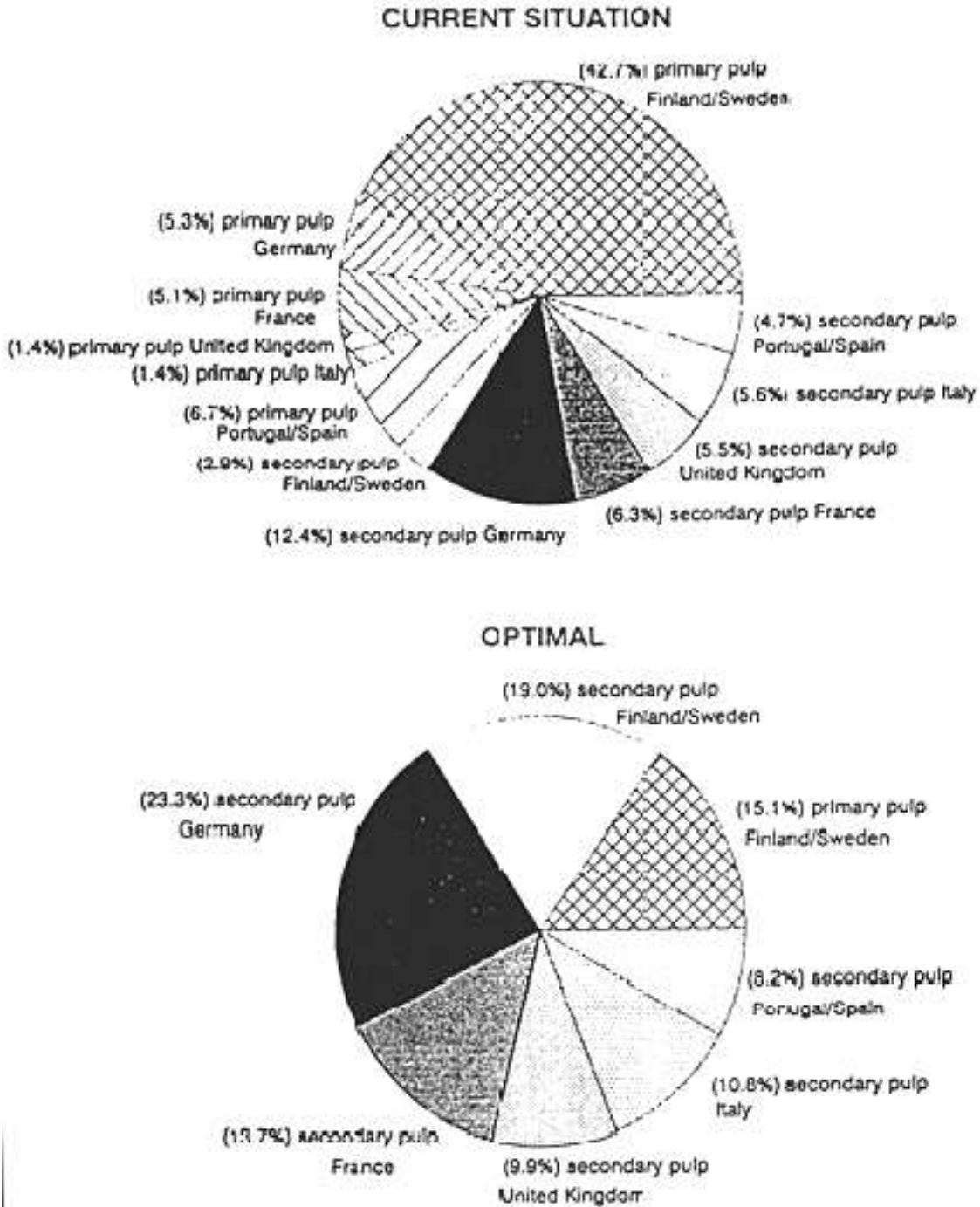

Figure 4. Environmental impact with fixed recycle share

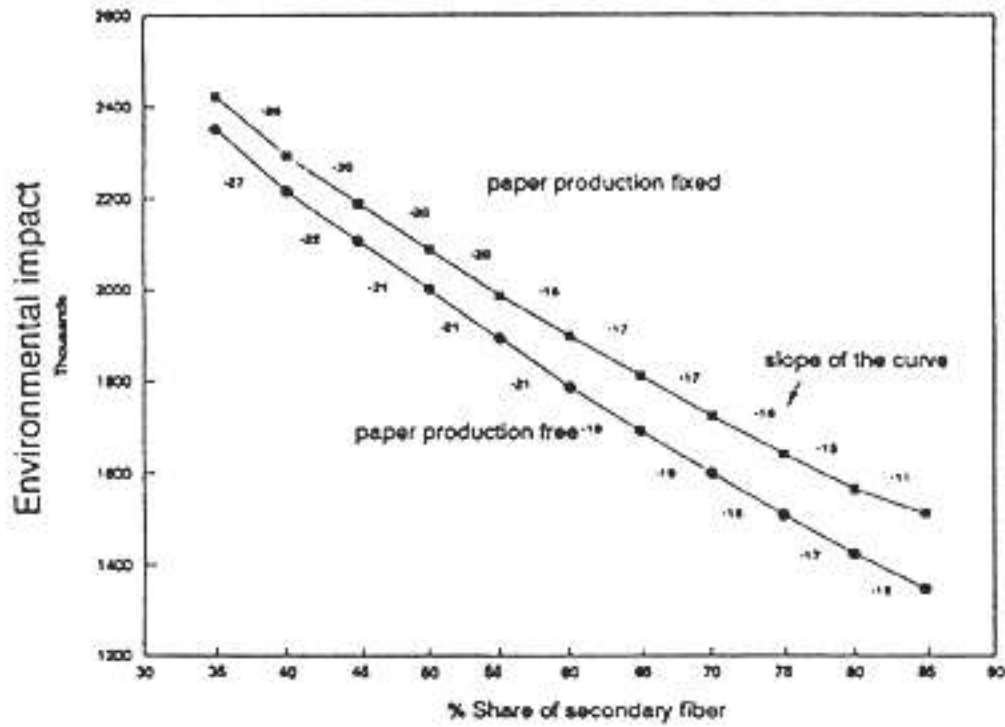

Figure 5. Sensitivity to pulping coefficient

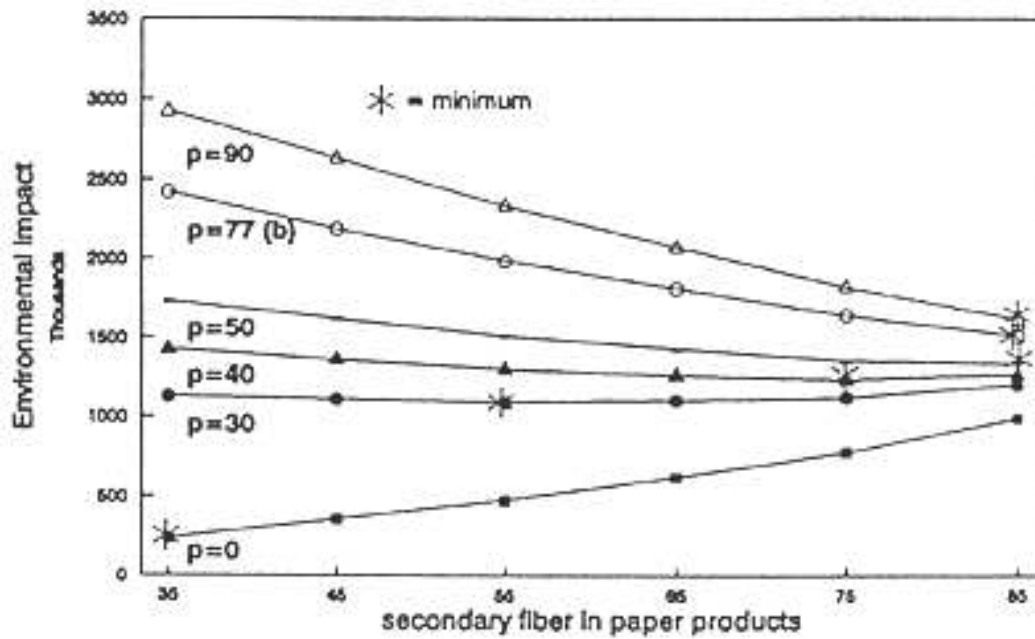

Table 3. Comparison of eco-profiles

	Current	%	Optimal	%
Global warm.	-61.9	-3.0	60.2	4.4
Human toxicity	34.2	1.6	63.8	4.7
Ecotoxicity	0.0	0.0	0.0	0.0
Photo. Oxid.	1,759.9	84.1	819.4	59.9
Acidification	-12.8	-0.6	74.2	5.4
Nutrification	45.1	2.2	46.3	3.4
Solid Waste	329.9	15.8	303.3	22.2
Total	2,093.7	100.0	1,367.1	100.0

Current and Optimal figures are in thousands. Columns do not sum due to rounding. Ecotoxicity was included in the study because it was one of the categories of damage identified as relevant to the sector. There was no measured value to one decimal place.

Table 4. Comparison of eco-profiles

	Current	%	Optimal	%
Global warm.	-6.19	-2.96	6.02	4.40
Human toxicity	3.42	1.63	6.38	4.66
Ecotoxicity	0.00	0.00	0.00	0.00
Photo. Oxid.	175.99	84.06	81.94	59.94
Acidification	-1.28	-0.61	7.42	5.43
Nitrification	4.51	2.16	4.63	3.39
Solid Waste	32.99	15.75	30.33	22.19
Total	209.37	100.00	136.71	100.00

Columns do not sum to zero due to rounding.

Table 4 translates the eco-profile figures back into the eco-balances - the actual emissions. The chosen indicators listed in the table are those being used as criteria in the development of the main eco-labelling schemes (Capps and Devas, 1994). Here we see improvement in the optimal configuration in wood consumption, energy use, chemical oxygen demand (COD), and chlorinated organic compounds (AOX). However, emissions of CO₂ and SO₂ increase.

A shift to this optimal configuration would have major implications for trade and industry. This is inevitable because the optimal solution involves maximum recycling while the current secondary fibre share in aggregate paper production is only about 35%. Some of the implications for markets and for shifts in the geography of pulp production are illustrated in Figure 3. The figure shows the split between primary and secondary fibre in the total pulp market and the shares for each of the different national pulp producers.

Clearly, Scandinavia would lose much of its market for primary pulp if recycling were to increase to the currently optimal rate, although there would be some pickup in secondary pulp. Germany's and France's secondary pulping would increase dramatically with the increase in recycling in those large consumer markets.

Interestingly, were one to shift to the optimal life cycle configuration, Scandinavia would supply all Europe's (reduced) need for primary fibre. Scandinavia would produce

and use primary pulp, but it would not export the primary pulp, per se. Rather, it would supply primary fibre indirectly by exporting paper with high primary fibre furnishes. The major consuming countries would in turn recover fibre from post-consumption waste, and then make paper and board grades that used entirely secondary fibre. Essentially, the optimal solution entails specialisation of production and of products.

With present day technology, more recycling is better all the way up to its maximum feasible rate. But is the marginal environmental gain constant or does it decline with ever higher recycling rates? Figure 4 addresses this question.

Figure 4 relates the environmental impact (the values of various objective functions) to the percentage share of secondary fibre (the recycling rate). The figure shows two environmental impact curves associated with two different scenarios. For each, the environmental impact has been calculated for a set of life cycle configurations, each associated with successively greater secondary fibre use.³ In the scenario of the upper curve, the current national pattern of paper production is assumed to be fixed. In the case of the lower curve, overall European paper production is fixed, but the location of paper production is allowed to vary between European countries within constraints imposed by their current installed capacities.

Figure 4 shows that the marginal environmental gain diminishes as the recycling rate increases. The curve is flattening with more recycling. The diminishing marginal environmental gain is due to an increase in transboundary waste paper shipment required for recycling. This is induced in the upper curve by the constraints on national recycling and de-inking capacities and the need to maintain paper and board production at the national level. For the Scandinavian countries to maintain their aggregate paper and board production under a maximum recycling scenario, they would need to import waste paper.

A second observation from Figure 4 is that one can achieve lower environmental costs if the location of paper production is allowed to change. The lower cost is maintained as secondary fibre share increases.

Table 5 shows that if paper production were allowed to move between countries, the Scandinavian countries would lose market share to all the others. In particular, Italy, Portugal, and Spain would significantly increase their market shares.

³ The figure was generated by making discrete runs from 35% to 85% secondary fibre share at 5%

Table 5: Relocation of paper production

Region	production fixed	production free	percent change
Scandina via	17,400	13,750	-23.3
Germany	11,900	13,050	+9.7
France	7,000	7,400	+5.7
UK	5,050	5,500	+8.9
Italy	5,500	6,350	+15.5
Iberia	4,200	5,000	+19.0
Total	51,050	51,050	

Given the relative environmental impacts of present day technologies, the diminishing environmental returns to recycling are modest. Yet they do hint that a policy to increase progressively the use of secondary fibre may be simplistic. Furthermore, they prompt an important question. Would the curvature in Figure 4 be more pronounced if the environmental impacts for the processes were different from those that now apply? How much would technology have to change to give an optimal configuration that did not entail maximum recycling?

Figures 5 and 6 answer these questions. We assume that the technology of some process can be improved to reduce its environmental impact. For each assumed improvement, we then calculate the overall environmental impact of different recycling levels. This gives us a family of curves analogous to what is shown in Figure 4, but with each curve in the family calculated with a different assumed environmental impact of some process technology.⁴ Figure 5 improves primary pulping technology; Figure 6 improves incineration technology.

⁴

The top line in Figure 5 shows the optimal configuration given current primary pulping technology. (The current technology has an impact score in the model of 77.⁵) The minimum environmental impact is at maximum feasible recycling. Successively lower lines represent progressively more environmentally benign primary pulping technology. The figure shows that at some point (the third line from the top where the impact score in the model drops to about 40), technological improvement renders maximum recycling no longer optimal. The optimal configuration at that point entails more recycling than is currently done, but the least environmental damage is achieved by shifting slightly away from maximum recycling toward cleaner primary pulping technologies and some incineration with energy recovery. Still, the relatively flat lines across the middle of Figure 5 suggest that the overall environmental impact of the sector is insensitive to the recycling rate at approximately this level of pulping technology improvement.

Figure 6 provides a comparable analysis for incineration. An improvement from the current -18 to -35 (higher negative numbers indicate greater energy credits in the model) would define a switching point, although again the relatively flat curve indicates that recycling rates make little difference at that technology level.

Figure 7 casts further light on this issue. Once again we assume that innovation can change the environmental performance of the different technologies. With each change in the environmental index, we run the model to define a new optimal life cycle configuration for the sector as a whole. Each of these configurations can be characterised by the proportion of secondary fibre in the aggregate paper furnish. Figure 7 reveals that the relation between the environmental index and the market share for primary pulp is a step-function. The most significant step occurs at the point where the environmental index for primary pulp production drops from 33 to 32. A minor shift in impact brings about a major shift in the optimal secondary fibre share - from 72% to 44%. The optimal configuration of the industry changes completely. This reinforces the impression that the pulp and paper sector has multiple, technologically determined environmental optima which are separated by sharp thresholds.

The maximum recycling scenario implies geographical division and specialisation of tasks and a cascade of fibre through a product hierarchy. This was explained before. How stable is this outcome to changes in the relative environmental impact of the different processes? Consider primary pulp production. If the environmental impact of producing primary pulp is just above a threshold level relative to the respective impacts

⁵ The impact score is the weighted average of the environmental indices of the four primary pulp types

Figure 6. Sensitivity to incineration coefficient

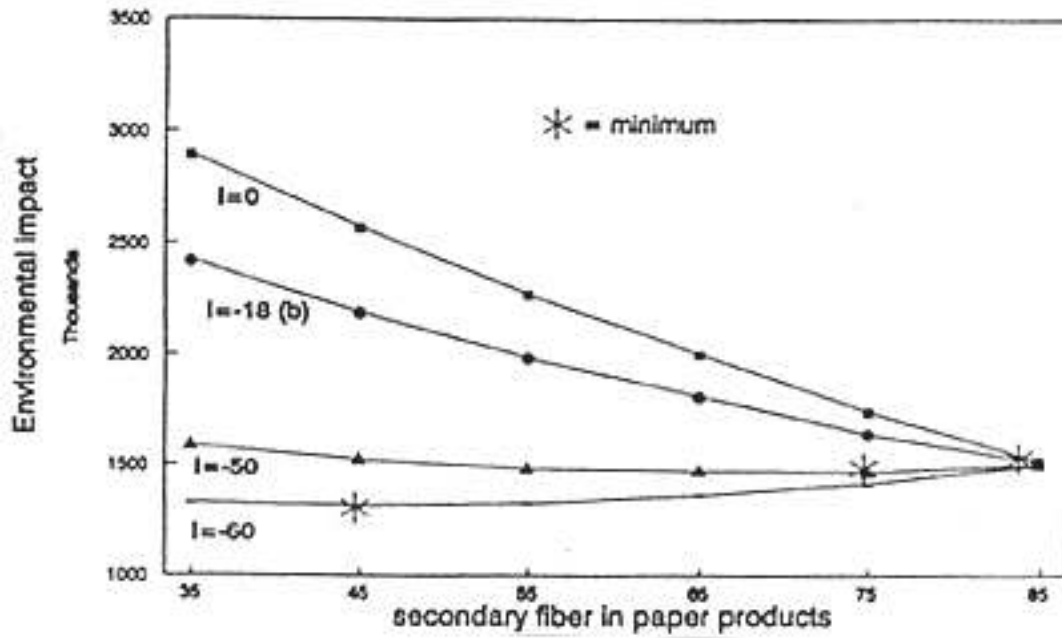
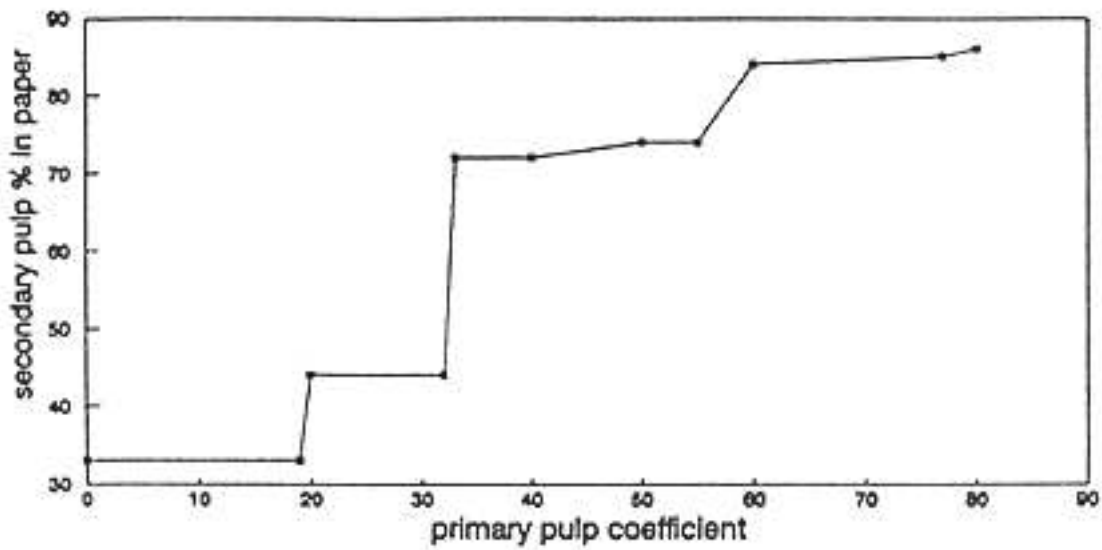

Figure 7. Sensitivity secondary pulp share to primary pulp coefficient



of fibre recovery and incineration, we have a relatively stable solution. (The threshold is where the environmental index of primary pulp production is 33 in our model.) The environmental impacts of primary pulp production exceed those of secondary fibre production by an amount that is too great to be offset by any credit from incineration. Production of primary fibre is minimised to reduce overall environmental damage, and remaining production would be a Scandinavian monopoly.

At the threshold level, the geography of production of the optimum configuration changes completely. This is because the environmental impacts of recycling vis-a-vis primary fibre production and incineration are in perfect balance. The optimal configuration is determined by the only remaining factor of relevance, the overall transportation level. This configuration is consistent with maximising self-sufficiency subject to capacity constraints. At this point, all countries would return to primary pulp production.

Below the threshold, transportation rapidly becomes irrelevant since there is a clear advantage in the primary fibre and incineration combination. There is no longer an impetus to maximise the materials productivity of fibre within the system, and therefore no reason to constrain the throughput of primary pulp. As a result, primary pulp dominates the pulp market.

Pursuing this last point to its ultimate conclusion, one could ask what the result would be if some producers had significantly cleaner technologies than their competitors. In the last scenario, when recycling no longer offered any environmental advantage, the solution would be sensitive only to the balance between the respective environmental performance of the pulping technologies of different producers and the transportation costs. If the difference between the different pulping technologies were sufficient to offset the impact of transporting primary fibre, the cleaner producers would export primary pulp.

The point of generating these results is to show the sensitivity of the optimal sectoral configuration to the environmental impacts of the different technologies and thus to prospective technological progress. In particular, the relative balance between these environmental impacts is critical to determining whether maximising recycling is the best route to improved environmental performance. It is today, but it may not be in the long run.

5. Conclusions

Our objective in this paper is to show a methodology that might complement others in a common goal of improving environmental policy making. The novelty of our methodology is that it does not start with a particular policy. Rather, it seeks the lowest feasible environmental impact - feasible in the sense of satisfying existing market, geographical, and technological conditions. We hope we have shown that this approach can be revealing in terms relevant to evaluating particular policies and in broader terms as well. In particular, we believe that to approach the issue as we have can help address some of the questions posed in our introduction.

Within the limitations of a relatively simple model, we demonstrate that a single-minded policy focus on recycling may be unwise. While pressure for more recycling is environmentally attractive now, policy makers intent on using command and control policies in this industry (policies that regulate levels of fibre reuse or mandate recycling percentages) must find ways to avoid discouraging investment in process changes that might eventually give returns superior to those available from even extremely high levels of recycling. Although it is not the objective of this paper to design a full environmental policy for pulp and paper, we can still suggest that resort to a more flexible and incentive-based policy approach might mitigate the risk of technology lock-out, a risk that is almost inherent in command and control regulations.

Our approach indicates that private sector research should, if not confronted with perverse public policy incentives, concentrate on process improvements in primary pulping. Technologies now in the pipeline would render the sector's environmental impact virtually insensitive to enormous variance in recycling rates. As we have noted, we do not compare costs in this paper. Nevertheless, this observation is significant because extremely high recycling rates may prove unachievable since, to be practical, they rely on voluntary behaviour that is uncommon in some European countries.

One insight our model provides is that alternative policy approaches have significant international trade implications in this sector, just as they undoubtedly have in others. As we have shown, maximum recycling significantly diminishes Europe's demand for primary pulp. Currently, primary pulp's share of all pulp production in Europe is over sixty percent, of which Finland and Sweden produce roughly one-third. With a shift to maximum recycling, the market share of primary pulp falls to only about fifteen percent. The Scandinavian countries would become its sole European suppliers, but not by

directly exporting it to paper makers in other countries. Rather, Scandinavia's primary pulp exports would be embodied in paper grades made entirely from it. Major consuming countries like France and Germany would recover the fibre and produce lower paper grades based exclusively on secondary pulp. Under some scenarios, secondary pulp from waste paper collected in these major consuming countries would be shipped back to Scandinavia to make lower paper grades for consumption there.

Contrasted with this industrial and trade structure is one in which improved pulping or incineration technologies (or rising environmental costs of transportation) shift the benefit/cost ratio away from recycling. We should then see greater self-sufficiency of the different major Union member states in producing virgin pulp and the various paper grades. International trade flows would diminish, and each country's industrial structure in forestry, pulping, paper making, waste handling, incineration, energy sourcing, etc. would adapt accordingly.

Although the industrial and trade consequences of alternative environmental policies have never been quantified as we have done, public policy makers at the national level are undoubtedly generally aware of them, and this provides at least a motive for them to try to manipulate the public policy process. In fact, industry participants frequently allege that ostensibly environmental policy is heavily influenced by trade and industrial policy concerns.

While we cannot legitimately comment on the purity of various countries' motives, the environmental policy positions taken by member states seem consistent with their trade and industry interests. For example, it is the Germans who are most intent on forcing recycling on the European Union while the Scandinavians are opposed. In any case, by providing a formal quantitative model to analyse both environment and trade issues, we are able to look explicitly at this potential environment-trade policy conflict.

Finally, our work suggests that there may be little relationship between the environmental weighting scheme and the optimal sector configuration. To the extent that this is true, then uncertainty over how to weigh different types of environmental risk should not per se stand in the way of decisions on environmental policy.

The direction that the pulp and paper industry development will take will depend on two things. The first is obviously the potential for technological improvement in the crucial processes and how that potential compares to the rising environmental burden of

transportation in Europe.⁶ Is it possible that these technologies can be improved to the point where primary pulping and incineration are environmentally preferred to the cost of transportation?

The second determinant of the future of the industry is whether environmental policy compels maximum recycling and forecloses the development of process technologies that is necessary to fulfil their potential. If this development is discouraged, the continual short run advantage of recycling will be a self-fulfilling prophecy.

References

- Arthur, B. (1989), 'Competing Technologies, Increasing Returns, and Lock-in by Historical Events', *Economic Journal*, 99/394, 116-31.
- BUWAL (1991), 'Ecobalance of Packaging Materials, State of 1990', Environmental Series No. 132, Swiss Federal Office of Environment, Forests and Landscape (BUWAL), Berne.
- Capps, C. and H. Devas (1994), *The Impact of Environmental Legislation on the European Paper Industry, An Environmental Legislation Handbook*, World Paper in co-operation with Rowe & Maw, London.
- CML (1992), 'Environmental Life Cycle Assessment of Products; I: Guide, II: Backgrounds', ed. R. Heijungs, Center of Environmental Science No. 9266, Leiden.
- CSG (1992), 'CSG/Tellus Packaging Study: Assessing the Impacts of Production and Disposal of Packaging and Public Policy Measures to Alter its Mix', Reports 1-5, Tellus Institute, Boston.
- EPA (1993a), *Life-Cycle Assessment: Inventory Guidelines and Principles*, EPA/600/R-92/245, US Environmental Protection Agency, Cincinnati.
- EPA (1993b), *Life-Cycle Design Guidance Manual, Environmental Requirements, and the Product System*, EPA/600/SR-92/226, US Environmental Protection Agency, Cincinnati.
- Gabel, H. L. and L-H. Röller (1992), 'Trade Liberalization, Transportation, and the Environment', *The Energy Journal*, 13/3, 185-206.
- Gabel, H. L. (1991), 'European Exhaust Emission Standards for Small Cars', INSEAD case study.

- Guinée, J.B. (1993), 'Data for the Normalisation Step within Life Cycle Assessment of Products', CML Paper No. 14 (Revised Version), Centre of Environmental Science, Leiden University, Leiden.
- Jerkeman, P. (1993), 'The Forest Sector in the Sustainable Society: A Pre-Study', Jaakko Poyry Client Magazine.
- OECD (1993), *The Pulp and Paper Industry in the OECD Member Countries*, OECD, Paris.
- Rajotte, A. (1994), 'The Status of the European Regulation of Chlorine Compounds in the Pulp and Paper Industry', unpublished manuscript, Pulp and Paper Working Group, OECD, Paris.
- SETAC (1993), 'Guidelines for Life Cycle Assessment: A Code of Practice', Edition 1, Sesimbra Workshop, Lisbon.
- Udo de Haes, H.A. (1994), 'Can all Chains be Closed: The Factor of Environmental Analysis Instruments to Substantiate Environmental Policy' (in Dutch), Inaugural lecture, 11 February, Leiden University, Leiden.
- Virtanen, Y. and S. Nilsson (1992), 'Some Environmental Policy Implications of Recycling Paper Products in Western Europe', Executive Report 22, IIASA, Laxenburg.
- Virtanen, Y. and S. Nilsson (1993), *Environmental Impacts of Waste Paper Recycling*, Earthscan, London.
- Weaver, P.M. (1995), 'Steering the Eco-Transition: A Materials-Accounts Based Approach', in Conti, S., E. Malecki, and M. Taylor (eds.), *Environmental Change: Industry, Power and Place*, Avebury Press, London.

Appendix A

Example of eco-balances

Appendix A. Example of Eco-Balances

Balance per ton paper (1000kg)

WASTE / INCIN / WASTE PAPER & BOARD					
Used materials			Atmospheric emissions ^b		
Waste paper	kg	1000	Particles	kg	-0.39825
			Co2	kg	-1253.21
Energy carrier requirement			Co	kg	-0.08176
Natural gas	MJ	-3645	HC	kg	-0.15627
Fuel oil extra-light	MJ	0	NOx	kg	-0.97695
Fuel oil heavy	MJ	-9450	N20	kg	-0.243
Coal	MJ	-9450	SO2	kg	-7.88605
			HCl	kg	0.1
Energy ^a					
Total	MJ	-15000			
Total	kWh	0	Solid wastes	kg	32.2

^aSteam necessary for the production of paper is assigned to natural gas 0.243; fuel extra high 0.63; hard coal 0.13.

The useable energy contents of wood and wastepaper amount to 15 MJ/kg.

^bEmissions from industrial heating (mg/MJ Steam).

Balance per km/ton paper

TRANSPORT ROAD (16 T TRUCK / DIESEL / HIGHWAY)

Used materials			Atmospheric emissions		
			Particles	kg	0.0008
			CO ₂	kg	0.074
Energy carrier requirement			CO	kg	0.000398
Natural gas	m ³		HC	kg	0.000199
Fuel oil extra-light	kg	0.02	NO _x	kg	0.000995
Fuel oil heavy	kg		N ₂ O	kg	0
Coal	kg		SO ₂	kg	0.0008

Energy

Total	MJ	0.85			
Total	kWh	0	Solid wastes	kg	0

Balance per km / ton paper

TRANSPORT SHIP (SEAGOING)

Used materials			Atmospheric emissions		
			Particles	kg	0.0001
			CO ₂	kg	0.033
Energy carrier requirement			CO	kg	3.0E-06
Natural gas	m ³		HC	kg	1.0E-06
Fuel oil extra-light	kg		NO _x	kg	0.000017
Fuel oil heavy	kg		N ₂ O	kg	0
Coal	kg		SO ₂	kg	0.000215
Energy					
Total	MJ	0.2			
Total	kWh	0	Solid wastes	kg	

Balance per ton pulp (1000kg)

PULP / PROD / BROWN / REUSE

Used Materials

Waste paper	kg	1125
Limestone (CaCO3)	kg	0
Lime(CaO)	kg	0
Chlorine (012)	kg	0
Sulphuric acid (H2504)	kg	0
Sodium sulphate (Na2SO4)	kg	0
Sodium chlorate (NaC]03)	kg	0
Sodium hydroxide (NaOH)	kg	0
Oxygen (02)	kg	0
Peroxides (H202)	kg	0
Sulphur (S2)	kg	0
Sulphur dioxide (SO2)	kg	0
Energy carrier requirement		
Natural gas	MJ	272.2694
Fuel oil extra light	MJ	0
Fuel oil heavy	MJ	705.8835
Coal	MJ	142.2972
Energy ^b		
Total	MJ	1120.45
Total	kWh	472.22

Atmospheric emissions^b

Particles	kg	0.091388
CO2	kg	279.0453
CO	kg	0.173579
HC	kg	0.01223
NOx	kg	0.7268
N2O	kg	0.061922
SO2	kg	1.67875
Adlehydes	kg	0
VOC	kg	0
NH3	kg	0
Fluorides	kg	0
CL2	kg	0
Hg	kg	0
H2SO4	kg	0
Mercaptans	kg	0
H25	kg	0
HCl	kg	0
Na2SO4	kg	0
Water consumption	l	13300
Water pollution		
Fibres	kg	0
Diss. solids	kg	0.6495
Salts	kg	0
Chlorides	kg	0
BOD	kg	8
COD	kg	7.89
AOX	kg	0
Sulphides	kg	0
Oils	kg	0
Phenols	kg	0
NH3	kg	0
Fluorides	kg	0
Hg	kg	0
Solid wastes	kg	75.97

^a Based on Reuse process in Nilsson, Virtanen (1992).

^b Emissions from industrial heating (mg/MJ Steam).

MJ assigned to energy carriers as in Incineration note a.

**Appendix B
Eco - Profiles**

Classification factors for environmental impact		Global warming waste (GWP 100)	Human toxicity (HCP)	Ecotoxicity (ECP)	Photo-chemical oxydation (POCP)	Acidi- fication (AP)	Nutrifi- cation (NP)	Solid waste
Air	Alt.							
Particles	CxHy	0	1.6	0	0.416	0	0	0
Carbondioxide	CO ₂	1	0	0	0	0	0	0
Carbon monoxide	CO	0	0.012	0	0	0	0	0
HC	CxHy	0	1.6	0	0.416	0	0	0
Nitrogenoxide	NOx	0	0.78	0	0	0.7	0.1.3	0
Dinitrogenoxide	N ₂ O	270	0	0	0	0	0	0
Sulphurdioxide	SO ₂	0	1.2	0	0	1	0	0
Aldehydes		0	0	0	0.443	0	0	0
VOC	CxHy	0	1.6	0	0.416	0	0	0
Ammonia	NH ₃	0	0	0	0	1.88	0	0
Fluorides	F-	0	0.48	0	0	0	0	0
Chlorine	Cl ₂	0	0	0	0	0	0	0
Mercury	Hg	0	120	0	0	0	0	0
Sulphuricacid	H ₂ SO ₄	0	0	0	0	0	0	0
Mercaptan	SH	0	0	0	0	0	0	0
Hydrogen sulfide	H ₂ S	0	0.78	0	0	0	0	0
Hydrochloric acid	HCl	0	0	0	0	1.88	0	0
Sodium sulphate	Na ₂ SO ₄	0	0	0	0	0	0	0
Fibres		0	0	0	0	0	0	0
Diss. solids		0	0	0	0	0	0	0
Salts		0	0	0	0	0	0	0
Chlorides	Cl-	0	0	0	0	0	0	0
BOD		0	0	0	0	0	0.022	0
COD		0	0	0	0	0	0.022	0
AOX		0	0	0	0	0	0	0
Sulphides	S	0	0	0	0	0	0	0
Oils		0	0.0009	0.05	0	0	0	0
Phenols		0	0.048	5.9	0	0	0	0
Ammonia	NH ₃	0	0	0	0	1.88	0	0
Fluorides	F-	0	0.041	0	0	0	0	0
Mercury	Hg	0	4.7	500	0	0	0	0

Environmental impacts 1000kg (1 ton)	Global warming (GWP 100)	Human toxicity (HCP)	Ecotoxicity (OECP)	Photo-chemical oxydation (POCP)	Acidi- fication (AP)	Nutrifi- cation (NP)	Solid waste
Pulp/sulfate/bleached	139.687	10.85042	0.00075	1.444643	4.466776	0.74611	61.3
Pulp/sulfate/unbleached	59.4473	8.503589	0.0003	1.267302	3.080659	0.40951	39.7
Pulp/sulfite/bleached	496.0417	25.73042	0.00095	4.073267	8.49867	2.37279	61.1
Pulp/tnp/bleached	886.7534	11.18966	0.00049	1.407126	4.909516	0.31959	69.8
Pulp/rcuse/unbleached	295.7642	2.749276	0	0.043105	2.18751	0.444064	75.97
Incineration	-1318.82	-11.1135	0	-0.23068	-8.38192	-0.127	32.2
Transport road	0.074	0.003339	0	0.000416	0.001497	0.000129	0

Environmental impacts

normalized with world

score for 1000 ton

(x 1.0E-9)	3.8E+13	5.8E+11	1.1E+14	3.7E+09	2.9E+11	7.5E+10	1.6E+12	Average
Pulp~sulphate/bleached	3.705225	18.83754	6.8E-06	386.2681	15.6181	9.974733	38.3125	67.53089
Pulp~sulphate/unbleached	1.576851	14.76318	2.7E-06	338.8507	10.77154	5.474733	24.8125	56.60708
Pulp~sulphite/bleached	13.1576	44.67087	8.6E-06	1089.109	29.71563	31.72179	38.1875	178.0803
Pulp~sulphite/unbleached	23.52131	19.42649	4.4E-06	376.2369	17.16614	4.272594	43.625	69.17834
Pulp~reuse/unbleached	7.845205	4.773048	0	11.52542	7.648636	5.936684	47.48125	12.17289
Incineration	-34.982	-19.2943	0	-61.6789	-29.3074	-1.69791	20.125	-18.1193
Transport road	0.001963	0.005797	0	0.111119	0.005233	0.001729	0	0.017977
Transport ship	0.000875	0.000752	0	0.011234	0.000793	0.00003	0	0.001955

Appendix C

Network Flow Model

Notation

Decision variables are in capitals, exogenous variables and other parameters are in small letters. Indices:

- $i, j, k \in I$ = index for regions
- $v \in V$ = index for virgin (primary) pulp types
- $r \in R$ = index for recycle fibre (secondary pulp)
- $p \in P$ = index for paper types

Decision variables:

- VP_{iv} : Virgin pulp Production of type v in region i
- VT_{ijv} : Virgin pulp Transport of type v , from region i to region j
- VD_{iv} : Virgin pulp Demand in region i of type v
- RP_{ir} : Recycle fibre Production of type r in region i
- RD_{ir} : Recycle fibre Demand of type r in region i
- PT_{ijp} : Paper Transport of paper type p , from region i to region j
- WT_{ij} : Waste paper Transportation, from region i to region j
- WI_i : Waste paper Incinerated in region i
- WP_i : Waste paper "Potential" for recycling in region i
- WD_i : Waste paper Demand for recycling in region i
- Δip : Share of recycle fibre in furnish of paper p in country i

Fixed quantities:

- vs_i : virgin pulp wood supply in region i
- pp_{ip} : paper production of paper product p in region i
- pd_{ip} : paper demand for paper product p in region i
- wg_{ip} : waste paper generated from paper type p in region i (this can be landfilled, incinerated or recycled)
- ws_i : waste paper supply for recycling or incineration in region i
- pt_{iop} : paper transport from region i to non-OECD countries (export)
- pt_{oip} : paper transport from non-OECD countries to region i (import)

Parameters in objective function:

- ev_{iv} : environmental impact of virgin pulp production of type v in region i
- er_{ir} : environmental impact of recycle fibre production of type r in region i
- ei_i : environmental impact of incineration of waste paper in region i
- etv_{ij} : environmental impact of transport of virgin pulp from region i to region j
- etp_{ij} : environmental impact of transport of paper products from region i to region j
- etw_{ij} : environmental impact of transport of waste paper from region i to region j

List of table and figure captions

- Table 1. Pulp, paper, waste paper capacity and consumption
- Table 2. Environmental indices
- Table 3. Comparison of eco-profiles
- Table 4. Comparison of eco-balances
- Table 5. Relocation of paper production
- Figure 1. Flow chart of pulp and paper industry
- Figure 2. Contribution to environmental impact
- Figure 3. Market shares in total pulp production
- Figure 4. Environmental impact with fixed recycle share
- Figure 5. Sensitivity to pulping coefficient
- Figure 6. Sensitivity to incineration coefficient
- Figure 7. Sensitivity secondary pulp share to primary pulp coefficient