

Arafeh, Labib

Article

An entrepreneurial key competencies' model

Journal of Innovation and Entrepreneurship

Provided in Cooperation with:

Springer Nature

Suggested Citation: Arafeh, Labib (2016) : An entrepreneurial key competencies' model, Journal of Innovation and Entrepreneurship, ISSN 2192-5372, Springer, Heidelberg, Vol. 5, Iss. 26, pp. 1-26, <https://doi.org/10.1186/s13731-016-0048-6>

This Version is available at:

<https://hdl.handle.net/10419/146868>

Standard-Nutzungsbedingungen:

Die Dokumente auf EconStor dürfen zu eigenen wissenschaftlichen Zwecken und zum Privatgebrauch gespeichert und kopiert werden.

Sie dürfen die Dokumente nicht für öffentliche oder kommerzielle Zwecke vervielfältigen, öffentlich ausstellen, öffentlich zugänglich machen, vertreiben oder anderweitig nutzen.

Sofern die Verfasser die Dokumente unter Open-Content-Lizenzen (insbesondere CC-Lizenzen) zur Verfügung gestellt haben sollten, gelten abweichend von diesen Nutzungsbedingungen die in der dort genannten Lizenz gewährten Nutzungsrechte.

Terms of use:

Documents in EconStor may be saved and copied for your personal and scholarly purposes.

You are not to copy documents for public or commercial purposes, to exhibit the documents publicly, to make them publicly available on the internet, or to distribute or otherwise use the documents in public.

If the documents have been made available under an Open Content Licence (especially Creative Commons Licences), you may exercise further usage rights as specified in the indicated licence.



<http://creativecommons.org/licenses/by/4.0/>

RESEARCH

Open Access



An entrepreneurial key competencies' model

Labib Arafah

Correspondence: larafeh@eng.alquds.edu
Computer Engineering Department,
Najjad Zeenni Faculty of
Engineering, Al-Quds University, PO
Box 20002, Jerusalem, Palestine

Abstract

The paper has twofold goals. The paper reviews the culture of entrepreneurship and entrepreneurial competencies in Palestine. It is characterized by donor-supported and non-governmental-initiated trainings. This demands an urgent active involvement of universities in the field of entrepreneurship that is shaped in the form of Research and Development as well as offering entrepreneurship academic programs. This comes in line with the emerging trend of offering courses and programs at universities worldwide. Furthermore, the paper proposes a softcomputing-based entrepreneurial key competencies' model (SKECM). This tool is capable of predicting/judging the overall quality of entrepreneurial competencies. SKECM is based on the three-cluster, ten key entrepreneurial competencies developed and used by Empretec. A three-stage, 14 different models have been developed and validated by hundreds of randomly generated datasets. Measures were used to validate the adequacy of these models including, the mean average percentage errors and the maximum percentage errors. The best achieved values for these measures are 0.8511 and 6.3175, respectively. However, although the preliminary findings of the proposed SKECM model are promising, more testing is still required before stating the adequacy of applying the softcomputing modeling approach in the entrepreneurship field (This is to state that there are no financial competing interests (political, personal, religious, ideological, academic, intellectual, commercial, or any other) to declare in relation to this manuscript).

Keywords: Entrepreneur, Competencies, Key entrepreneurial competencies, Neurofuzzy, Softcomputing, Modeling, Model

Background

Recently, entrepreneurship and entrepreneurial culture have received an increased amount of attention in both academic research and practice. Several initiatives in Palestine are conducting workshops and training sessions to promote the culture of related trends such as the start-ups, innovation, entrepreneurship, and intellectual properties. These are accomplished at high school level like Al-Nayzak (<http://www.alnayzak.org/>) as well as some tertiary education institutions such as the Technology Transfer Company, IBDAAs' (<http://www.ibdaa.ps>), as an example. The Palestinian entrepreneurship status is briefly presented in the "Entrepreneurship status in Palestine" section.

The term entrepreneur has several definitions. These include a person who organizes and manages any enterprise, mainly a business, usually with considerable initiative and risk (<http://dictionary.reference.com/browse/entrepreneur>); someone who exercises initiative by organizing a venture to take benefit of an opportunity and, as the decision maker, decides

what, how, and how much of a product or service will be produced (<http://www.businessdictionary.com/definition/entrepreneur.html>); a person who develops a business plan, acquires the human, financial and other required resources, and is responsible for its success or failure (Hisrich 2011); and any individual who organizes and/or manages resources in the form of a self-accounting non-farming enterprise, and assumes a significant amount of risk associated with equity participation in that enterprise (McClelland 1990). These entire definitions share attributes like business, initiative, management, decision making, risk, and the entrepreneurship, on the other hand, may be defined as the capacity required to identify and generate competitive business ideas, utilize resources, organize production, promote the products or services, manage risks, and continuously work for growth and excellence of the business.

The word competency also has several meaning like sufficiency to satisfy the wants of life (<http://dictionary.reference.com/browse/entrepreneur>); the quality of being adequately or well qualified physically and intellectually (<http://www.thefreedictionary.com/competency>); the capability to apply a set of related knowledge, skills, and abilities to successfully perform functions or tasks in a defined work setting (Entrepreneurship Competency Model 2010); the capacity, which occurs in a person leading to behaviors that meet the job demands within the bounds of organizational environment, which in turn brings about desired results (Boyatzis 1982); and the sum of experiences, knowledge, skills, and attitude which we acquire during our life time for effective performance in a task or job (Kaur and Bains 2013). All of these definitions refer to the competency as a capability/ability that serves as the basis for knowledge and skills standards. It is worth mentioning that competencies apply to all aspects of life including, graduate's competencies, job competencies, managerial competencies, etc. (Mitchelmore and Rowley 2010) and (Linton and Walsh 2013) can be reviewed for further deliberating the meaning of entrepreneurship and competencies.

As for the entrepreneurial competencies, the focus of this paper, reviewing the literature reveals that research papers and articles have addressed those using different terms like characteristics, competencies, traits, and qualities (Entrepreneurship Competency Model 2010; McClelland 1987; David and Edward 2011; Abdullah et al. 2009; Badal 2014; Rozell et al. 2011; Kaur et al. 2013; Brinckmann 2008; Mitchelmore and Rowley 2013; Brinckmann 2007; Pofeldt 2014; Chell 2008; Man 2006; James 2011; Anne 2011; Shukla 2009; Wu 2009; Sugars 2014; Prats et al. 2009; The UNCTAD Entrepreneurship Policy Framework 2012; The Empretec Program: The Entrepreneur's Guide 2015; The Canadian National Research Council Entrepreneurship). The number of the quantified competencies ranges from 5 (McClelland 1987; David and Edward 2011; Abdullah et al. 2009; Badal 2014; Rozell et al. 2011) through 7 (Kaur et al. 2013), 10 (Brinckmann 2008; Mitchelmore and Rowley 2013; Brinckmann 2007; Pofeldt 2014; Chell 2008; Man 2006; James 2011), 12 (Anne 2011), 13 (McClelland 1987), 15 (Entrepreneurship Competency Model 2010; Shukla 2009), 23 (Wu 2009), and up to 25 (McClelland 1987). Most of them have share competencies like passionate, risk-taking, confidence, determination, disciplined, visionary, decision-making, and leadership. Furthermore, other researchers categorized competencies into key (or levels/layers/clusters/tiers) entrepreneurial competencies rather than dealing with general individual ones. These proposed key competencies range from 2 to 9 categories (Boyatzis 1982) identified entrepreneurial traits and entrepreneurial motives, whereas (Sugars 2014) realized psychological, and education and experience factors. The three-type category is identified as attitudinal, behavioral, and managerial competencies (Mitchelmore and Rowley 2010); achievement/results—orientation, interpersonal and team-building, and business focus (Prats et al. 2009;

The UNCTAD Entrepreneurship Policy Framework 2012); achievement, planning, and power clusters (The Empretec Program: The Entrepreneur's Guide 2015); and personal, interpersonal, and business competencies (The Canadian National Research Council Entrepreneurship and http://www.nrc-cnrc.gc.ca/eng/careers/behavioural_competencies/entrepreneurship_competency.html). The four-category models include: knowledge, motivation, capabilities/qualities, and characteristics (Driessen 2005); and achievement, personal power, planning, and relationship building (Smith and Shankar 2015). The five-level category is proposed by (Sugars 2014) comprising: self-employed mindset, managerial perspective, attitude of owner/leader, entrepreneurial investor, and true entrepreneur. In addition, a six-layer entrepreneurship competency is proposed by (Entrepreneurship Competency Model 2010) including personal effectiveness, academic, work, industry-wide technical, industry-sector technical and management competencies, and occupation-specific requirements. The covariance seven-category structure model is proposed to test the entrepreneurial intent among engineering students at MIT (Lüthjel and Franke 2003). Such a model includes key parameters like entrepreneurial behavior, entrepreneurial intent, risk-taking propensity, locus of control, attitudes towards entrepreneurship, perception of context, and personal background. Furthermore, the nine-tier competencies' model that is proposed by (The Competency Model Development and Use: A Technical Assistance Guide 2015) includes personal effectiveness, academic, workplace, entrepreneurship technical, entrepreneurial focus areas, and the rest of the tiers represent the specialization that occurs within specific occupations within an industry. All of these categories include components like personal, achievement, planning, power, and academic explicitly or implicitly.

In this paper, the author aims at reviewing the Palestinian entrepreneurship status and various initiatives. The second goal is to propose a softcomputing-based software that can predict the quality of an entrepreneur's overall key entrepreneurial characteristics and competencies. This proposed software is based on the three-cluster model that has been successfully developed and implemented mainly by Empretec (Driessen 2005; Smith and Shankar 2015) in tens of countries all over the world over the three decades.

Following this brief introduction, the paper is organized as follows: the "Literature review" section surveys relevant studies which have addressed the problem of modeling entrepreneurial competencies. The "Methods" section briefly introduces the methodology used. It is followed by a brief presentation of the Palestinian entrepreneurship status. "The proposed model" section introduces the various softcomputing modeling techniques and presents the proposed SKECM model. While results and discussions are covered in the "Results and discussion" section, conclusion and further works are presented in the "Conclusions" section.

Literature review

The modeling of the entrepreneurship and the entrepreneur's characteristics/competencies has been addressed by several research studies in the last few years. Some of these studies are briefly presented.

A two-side entrepreneurial competencies' model is proposed by (Penchev and Salopaju 2011). While a one-side focusses on the core entrepreneurial competencies that are required at a time: proactiveness, change risk taking, seeing opportunities, soft networking, decision-making, creativity, and innovativeness; the other side which, is more necessary later on, for running the established company includes leadership, communication,

specialist, and problem-solving. The author adopts the triangulation approach to qualitatively analyze the interview results together with quantitatively the survey results, as well as with the theoretical findings (<http://www.pcbs.gov.ps/site/512/default.aspx?tabID=512&lang=en&ItemID=1397&mid=3172&wvversion=Staging>). In addition, (Zhi-qiang et al.) proposed an entrepreneur belief–desire–intention (BDI) model in different entrepreneurial environment that is based on the fuzzy wavelet neural networks. Authors stated that the proposed model enhanced the controlling and reasoning capacity of BDI model. Furthermore, a three-theme (knowledge, skills, and attitudes) action-based approach framework for entrepreneurial competencies focused on developing entrepreneurial competencies is proposed (Lackéus 2013). The knowledge theme contains mental models, declarative knowledge, and self-insight; the skills theme includes subthemes: marketing, opportunity, resource, interpersonal, learning, and strategic; and the attitudes one consists of entrepreneurial passion, self-efficacy, entrepreneurial identity, proactiveness, uncertainty/ambiguity tolerance, innovativeness, and perseverance. Authors identified the three-thematic sources linked between strong emotions and entrepreneurial learning outcomes: interaction with outside world, uncertainty/ambiguity in learning environment, and team-work experience. In addition, Mitchelmore integrated the various entrepreneurial competencies into four categories (Mitchelmore and Rowley 2010). These are entrepreneurial, business and management, human relations, and conceptual and relationship competencies. The author argued that this integrative list of entrepreneurial competencies is contextual and situational. Noor and co-authors (2010) suggested an integrated entrepreneurial competencies model of the roles of entrepreneurs in examining the relationship between entrepreneurial competencies and business success in SMEs. They included different domains like strategic, commitment, conceptual, opportunity, organizing and leading, relationship, personal, and technical.

Furthermore, Radović Marković and co-author proposed a fuzzy logic based generally applicable procedure to evaluate the competence (personal and professional) of the leader of the project team and its members, who are employed on virtual university (Mirjana and Dušan 2014). As a formulation of the original model, the authors proposed that a database of experts should be formed on the basis of the keywords from their publications. Also, an interesting study that compares the combination of organizational entrepreneurship and social capital, and its dimensions in three countries making use of statistical and fuzzy logic approaches (Yaghoubi). Authors identified the significant of considering the social capital to improve the organizational entrepreneurship.

A fuzzy logic-based dynamic economic-psychological model of factors that influence individuals' entrepreneurial intentions to go into business is proposed (Khefacha and Belkacem 2015). The considered factors include personal attitude, subjective norms, and perceived behavioral control. Authors reported that entrepreneurial intention is related to a composite of some demographic, competencies, networks, and perception factors. WU (The Canadian National Research Council Entrepreneurship), on the other hand, proposed a competency model and applied the rough set theory and the best attribute-value to investigate whether there are diverse competencies between small firm entrepreneurs and large firm managers. The author reported that the small firm entrepreneur is generally much better in building a mechanism for talent development, whereas a large firm manager is good at making feasible solutions for actions (The Canadian National Research Council Entrepreneurship).

Moreover, one of the most famous and implemented models is the three-clustered, ten personal entrepreneurial competencies (PECs), developed at Harvard University (Driessen 2005). These PECs include achievement cluster that addresses the opportunity-seeking and initiative, persistence, fulfillment of commitments, demand for quality and efficiency, and calculated risks; planning cluster that focuses on: goal-setting, information-seeking, and systematic planning and monitoring; and the power cluster that concentrates on persuasion and networking, and independence and self-confidence. Based on this model, the United Nations Conference on Trade and Development (UNTCAD) published an Entrepreneurship Policy Framework and Implementation Guidance (Smith and Shankar 2015). Furthermore, UNTCAD established the Empretec program (The Empretec Program: The Entrepreneur's Guide 2015) to promote the establishment of sustainable, innovative, and internationally competitive small- and medium-sized enterprises. The Empretec program is an integrated capacity building, one that is operating in 32 countries with over 300,000 trainees across the developing world. Empretec distinguishes itself from other training by offering a behavioral approach to entrepreneurship.

In this paper, we adopted the Empretec as depicted in Fig. 1. It shows the three clusters that covers a series of ten Key PECs represented by thirty behaviors associated with successful entrepreneurs.

Methods

The paper has twofold goals. The first one is to highlight the culture of the Palestinian entrepreneurship, and define its characteristics. A desk review has been conducted to identify all initiatives and training entrepreneurship-related programs, as well as the worldwide trends in the light of the Palestinian economy and unemployment rate.

The second fold of the paper aims at proposing a simulated and softcomputing-based entrepreneurial competencies' software model capable of predicting the overall entrepreneurial competencies. A desk review has been accomplished to review the various available entrepreneurial competencies models. These models have been compared from various dimensions including the features, categories, and implementations. The research work uses a framework, clustered structure entrepreneurship model that is mostly and widely used for the research consideration and implementation.

The mathematical modeling technique, namely softcomputing modeling approach, is explored and used as a platform for development and validated with generated random data.

A three-stage, 14 different models are developed. To validate these models, hundreds of datasets are randomly generated between 1 and 10. This range covers the poor, satisfied, good and excellent levels of entrepreneurial competencies. Three measures are used to examine the adequacy of using the softcomputing techniques to address the entrepreneurship field.

Entrepreneurship status in Palestine

Palestine (West Bank and Gaza) has an exceptional occupational, political, economic situations, and lack of natural resources. The Palestinian main features of economic indicators include a 45.6 % labor force participation rate of persons aged 15 years and

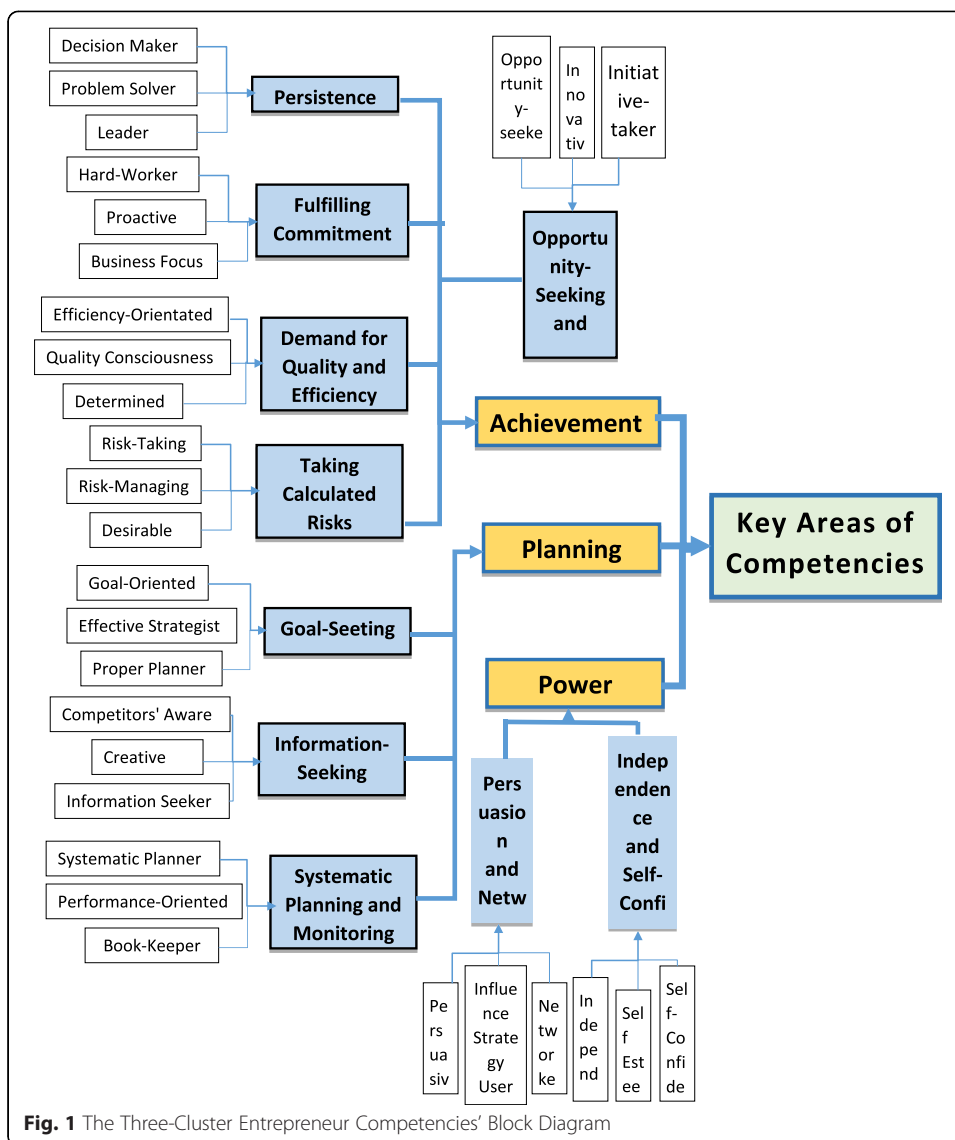

Fig. 1 The Three-Cluster Entrepreneur Competencies' Block Diagram

above, 25.6 % unemployment rate among labor force participants, 68.3 % of employed persons are wage employees, and 18.6 % of employed persons are self-employed, and 41.5 % among youth aged 20–24 year (<http://www.pcbs.gov.ps/site/512/default.aspx?tabID=512&lang=en&ItemID=1397&mid=3172&wversion=Staging>). Furthermore, 25 % of Palestinians are living in poverty (<http://www.worldbank.org/en/news/press-release/2015/09/27/palestinians-getting-poorer-for-third-year-in-a-row>), 1638 USD GDP per capita, and –387 USD Million Balance of Trade (<http://www.tradingeconomics.com/palestine/indicators>).

Similar to most of other developing countries, Palestine, in the last few years, has luckily witnessed the implementation of several entrepreneurship-related initiatives that are mainly supported by foreign donors. These include:

1. Al-Nayzak (<http://www.alnayzak.org/>) (The Arabic word for meteor) that aims at developing a new culture of scientific education to provide economic opportunities

and advances the daily lives of Palestinians. AL-Nayzak is targeting the K-12 students. Al-Nayzak has several annual programs like Science and Technology House, Tafkeer (Thinking) Technology, Young Researcher, and Talented Student Incubators. Furthermore, Al-Nayzak addressed the university students and graduates with one program entitled “Made in Palestine-Economy based on Knowledge and Entrepreneurship”.

2. The Education for Employment (EFE) (<http://efe.org/our-network/palestine>)—Palestine branch, launched in 2006, aims at empowering youth (18–32 years old) with the required skills and opportunities to build bright future. Among the three running programs by EFE, entrepreneurship is the one that started in 2011. The entrepreneurship program trains youths with skills required to start small new businesses, and directs them to financing, mentoring, and other services. In 2012, EFE launched the Bader (Arabic word for “to initiate”) Youth Entrepreneurship program that adopted the Intel® Learn Technology and Entrepreneurship program (<http://www.intel.com/content/www/us/en/education/k12/intel-learn/curriculum.html>) along with soft skills and business English training. At the end of the training programs, participants presented their ideas and business plans to business people and donors like the Rawabi Foundation (<http://www.rawabi.ps/foundation/>) and the Siraj Fund Management Company (<http://www.siraj.ps/>). Over, 2 Million USD were donated to support startups.
3. The four-Palestinian universities’ technology transfer company (IBDAA’ (<http://www.ibdaa.ps>): Arabic name for innovation) that aims at promoting scientific research at universities (Al-Quds, AL-Najah, Palestine Polytechnique, and Arab American Universities), has conducted several workshops addressing the entrepreneurship, intellectual properties to faculty members and students. Furthermore, IBDAA’ supports establishing startups in the field of technology and information technology.
4. Portland Trust (<http://www.portlandtrust.org/projects/training-entrepreneurship>) implemented among its several training and entrepreneurship programs, a pilot training project in the west Bank of Palestine to help establish new businesses in association with Sharek Youth Forum (<http://sharek.ps/en/>) and the Small Enterprise Center (<http://www.sec-pal.org/>): The program that run once in 2008 and provided training in business development and financial planning.
5. The Young Entrepreneurs Palestine (YEP) (<https://www.annalindhoundation.org/members/young-entrepreneurs-palestine-yep>) offered a two-part consulting program known as Youth Entrepreneurship Livelihood Program (YELP) (<http://kelley.iu.edu/IIB/ProgramsandIntitiatives/YELP/page45835.html>). YELP provides significant education and business support Palestinian potential entrepreneurs in partnership with two Palestinian Universities.
6. The Youth Entrepreneurship Project (YEP) (<http://www.silatech.com/home/project-countries/palestine>) has just announced (Aug. 2015) a 3-year collaboration with PlaNet Finance to improve access to financial services for young entrepreneurs in Palestine as well as Egypt and Lebanon targeting at economically and socially disadvantaged youths.
7. The Palestine for a New Beginning (PNB) and regional social initiative Silatech (Mitchelmore and Rowley 2010) has produced an interactive map designed to help enable more effective interaction between entrepreneurs, support organizations,

- and policy makers. The developed ecosystem map (<http://www.ta3mal.ps/en/Pages/Home.aspx>), which is based on the Babson Entrepreneurship Ecosystem Project (<http://www.babson.edu/executive-education/custom-programs/entrepreneurship/Pages/entrepreneurship-ecosystem.aspx>), presents the relationships between several entrepreneurship-related stakeholders who are involved in finance, education, government, media, the private sector, donor institutions, and civil society.
8. The International Labor Organization introduced its Knowledge About Business (KAB) program (http://www.ilo.org/wcmsp5/groups/public/—ed_mas/—eval/documents/publication/wcms_174956.pdf) in partnership with the United Nations Development Program (<http://www.undp.ps/en/>) in vocational and technical education at several community governmental colleges. KAB program covers training materials to develop entrepreneurial abilities and prepare students and trainees to establish their own businesses and to work productively in small and medium enterprises. In 2011, a 3-year KAB program was running in support of the Welfare Association (<http://www.welfareassociation.org/>) in Palestine.
 9. Youth Entrepreneurship Development (YED) (<http://www.iyfnet.org/initiatives/youth-entrepreneurship-development-yed>) is improving employment, entrepreneurship, and civic engagement opportunities for Palestinians ages 14 to 29. YED is collaborating across the public, private, and civil society sectors to provide young people with demand-driven, sustainable, and high quality projects that support their entry into the workforce and foster tangible improvements to their local communities.
 10. A 2-year ENPI CBC MED (<http://www.enpicbcmed.eu/programme/about-the-programme>)-funded project, called the cross-border_NETWORK to foster Knowledge-intensive business Incubation and TEchnology transfer (NET-KITE) (<http://www.netkite.eu/project-2/>) adopted a model to convey research ideas into the industrial system and promote the mutual exchange among young spin-off companies as well as more mature enterprises already operating on the market.
 11. Spark (<http://www.spark-online.org/>) has implemented an entrepreneurship development and Business Startup Program in coordination with Birzeit University's center of excellence (<http://sites.birzeit.edu/nzitce/index.php/pre-incubation>).
 12. Other programs that promote the entrepreneurship and the incubation culture include Intel Business Plan Contest (<http://www.picti.ps/project/picti-palestine-bic-and-intel-launch-the-palestine-business-plan-contest-2013/>), the Microsoft Imagine Cup Competition (<https://www.imaginecup.com/competition/17368>), Intilaq (<http://www.picti.ps/introductory-meeting-for-intilaq/>), World Summit Mobile Award (<http://www.wsa-mobile.org/news/wsa-palestine-workshop-460220140507>), Palestine Innovation Initiative (PI2) (<http://www.picti.ps/palestineinnovationinitiative/>), and Teamstart (<http://www.picti.ps/teamstart-palestine-2/>).
 13. Several Palestinian universities like the Islamic University, Al-Quds University, Palestine Polytechnic University, and Bethlehem University offer an introductory entrepreneurship credited courses.
 14. Currently, Palestine has witnessed the establishment of several business incubation programs and startup accelerators. The top eight (<http://www.wamda.com/2015/09/palestine-s-top-8-incubators>) include Arabrener (<http://www.arabrener.com/>), Business and Technology Incubator (BTI) (<http://bti.ps/En/default.aspx>), Business

Women Forum (BWF) (<http://www.bwf.ps/index.php/en/>), Gaza Sky Geeks (<http://www.gazaskygeeks.com/>), Leaders-FastForward (<http://www.leaders.ps/the-fastforward-accelerator-program/>), Mobaderoon (Arabic word for entrepreneurs) (<http://mobaderoon.ps/ar/index.php>), and Palestinian ICT Incubator (PICTI) (<http://www.picti.ps/>) and UCASTI (<http://www.ucasti.ps/>).

15. Recently, PalTel group Foundation (<http://www.pgfoundation.ps/?lang=en>) implemented, in coordination with Jawwal, its subsidiary, a 3-year program entitled "Code for Palestine-We Code). We Code aims at educating 14-year old youths with hands-on access to high tech, coding, business, and leadership skills while working in parallel with the group's current strategy.
16. Other initiatives include the American MiddleEAST Educational and Training Services (Amideast) (<http://amideast.org/west-bank-gaza>) initiative that offers the Cisco Entrepreneurship Institute (<http://amideast.org/our-work/elt/entrepreneurship-training>); the Bader ICT Incubator (<http://www.bader.ps/>) that provides incubating services including direct business development assistance, professional network and relationship support, technical assistance and consulting tailored to hosting growing companies and facility-based services; the Palestine Investment Promotion Agency (PIPA) (<http://www.pipa.ps/>) that facilitates a private sector-government cooperation to promote and maintain a competitive investment environment; the Leaders Organization (<http://www.leaders.ps/>) that provides Business Development and Hosting Centre; the Social Entrepreneurship Tawasul (<http://www.tawasul.com/>) (Global Connections Center) that addresses the capacity building, advocacy and leadership; and Tomorrow's Youth Organization (www.tomorrowsyouth.org) that provides women's incubation training and services for entrepreneurs in cooperation with the PalTel Group Foundation that includes mobile technology services, marketing, including selling solutions and adding value to the market; financial growth and access to capital; advanced IT; and business English.

Basing on the above review, one can point out the following features of the entrepreneurship-related initiatives and training programs in Palestine:

1. Most of these initiatives are donor-based ones, which sets them in an unpredicted and unsustainable status and threat
2. Most of them are informal and continuing education training programs
3. Most of these training programs are covered by non-governmental organizations rather than higher education institutions
4. Every initiative has its own curriculum that may raise the quality of such programs
5. The contribution or participation of higher educational institutions in these initiatives are very weak
6. The Palestinian higher educational institutions are taking the following role rather than the leading one
7. Few universities offer formal optional credited entrepreneurship courses
8. Up to my knowledge, there is no article that addresses the quality of these training programs, nor the quality of their graduates, or the quality of their obtained entrepreneurial competencies

9. According to the Global Entrepreneurship Monitor (GEM) (The Global Entrepreneurship Monitor—Adult Population Survey Measures 2015) indicators, Palestine (in 2012) scored rates of 9.8, 3, and 6.2 % for the Total early-stage Entrepreneurial Activity (TEA), the established business ownership; and nascent entrepreneurship rate, respectively. Unfortunately, these rates cannot significantly help drive the deteriorating Palestinian economy

In summary, one may conclude that:

1. The contribution of the Palestinian universities towards the new trends of entrepreneurship and innovation is merely conducting few studies as well as offering training courses and academic elective courses. This indicates the demand to develop an entrepreneurship academic program. Such a program will positively impact and equip graduates (entrepreneurs or self-employers) with the necessary competencies in a wide number of contexts so that they will become an increasingly important element of the Palestinian economic growth and development. This is in addition to the promotion of Research and Development in the fields of entrepreneurship and innovation fields and tightening the badly required enterprise-university partnership. It is worthwhile mentioning that around 82 % of the Chinese universities and colleges offer compulsory/elective courses on entrepreneurship and innovation (80% of universities open entrepreneurship courses et al. 2015). While, 35 entrepreneurship bachelor's degrees are offered in UK (Entrepreneurship Bachelor's degrees in UK et al. 2016), 101 master programs are offered jointly in Europe (Master Programs in Entrepreneurship and Europe, <http://www.masterstudies.com/Masters-Degree/Entrepreneurship/Europe/>). Offering an Entrepreneurship Academic program is undergoing by the author along with national, regional, and European partners.
2. Up to my knowledge, there is no available tool that can evaluate or judge the various competencies of all of these trainees. Thus, a software tool is badly needed to address the achieved entrepreneurship competencies. Thus, SKECM model is proposed to highlight the required unique key entrepreneurial competencies and measure or predict such competencies.

The proposed model

A simple softcomputing-based key entrepreneurial competencies' model (SKECM) is proposed. SKECM model can be used by organizations and individuals to judge or assess the various essential competencies an entrepreneur must have. SKECM is a three-stage model as shown in Fig. 2.

Based on its related behaviors, every key entrepreneurial competency (KEC) is modeled in the first stage. Such a model will represent the relations between the behaviors (as inputs) and their corresponding KECs (as an output). Since there are ten KECs, along with their associated behaviors as shown in Fig. 1, there will be ten such models. Figure 3 illustrates the persistence key competency as an example of one of these models, whereby its three associated behaviors are input into the model. This persistence model describes the relation between the three behaviors, with equal contributions of each behavior, and the predicted key persistence competency.

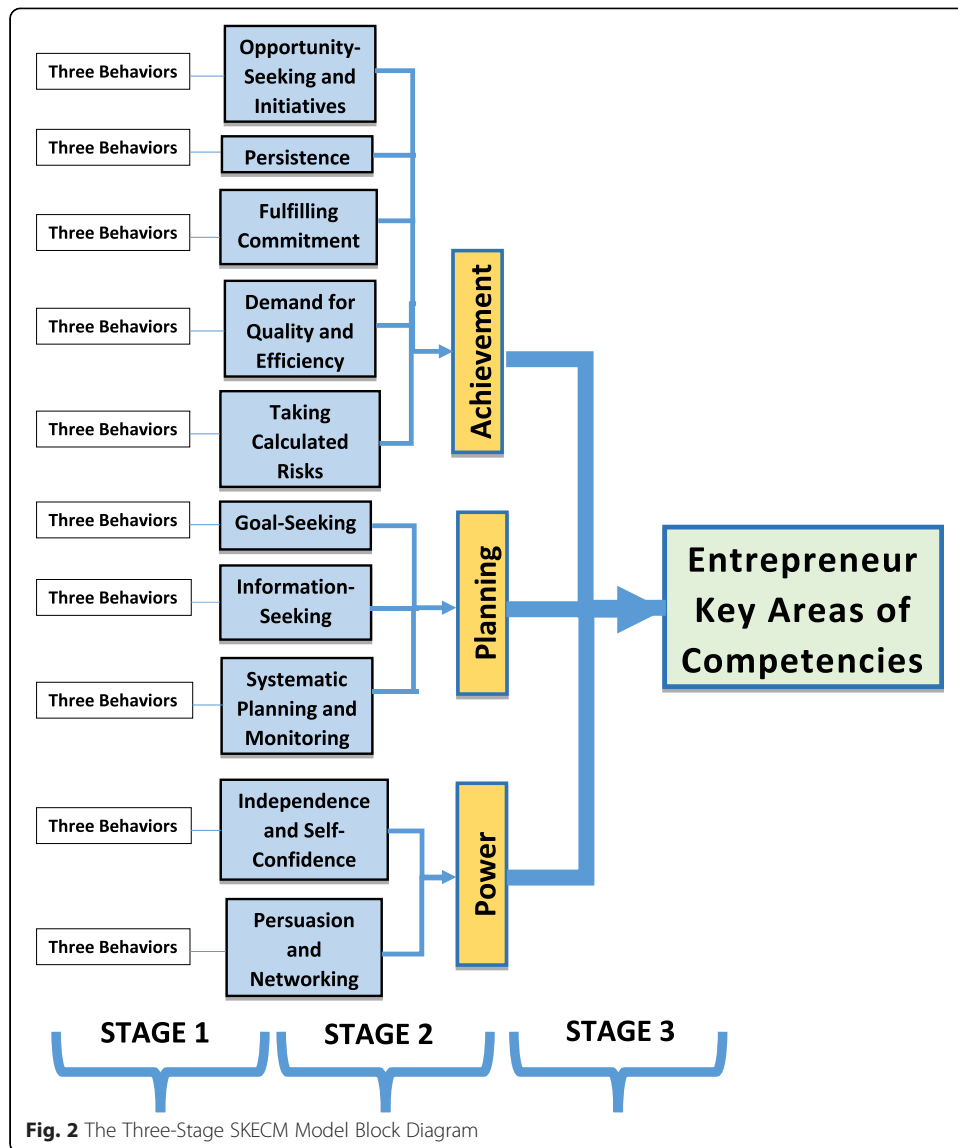

In the second stage, every cluster of competencies is modeled based on its related KECs. This model represents the relations between the KECs (inputs) and their corresponding cluster (output). Since there are three clusters, along with their associated KECs as presented in Fig. 1, there will be three such models. Figure 4 shows the achievement cluster as an example of for these models. This achievement model describes the relation between the five KECs, with equal contributions of each KEC, and the predicted achievement cluster.

In the third stage, as depicted in Fig. 5, the three clusters' competencies models are fed into the overall entrepreneurial competencies model to produce the overall competency and proficiency of the entrepreneur under consideration. This model describes the relations between the clustered competencies of the three clusters, with equal contribution of each one, and the overall entrepreneurial competency.

The following sub-sections briefly introduce the softcomputing field and present a detailed description of the SKECM model.

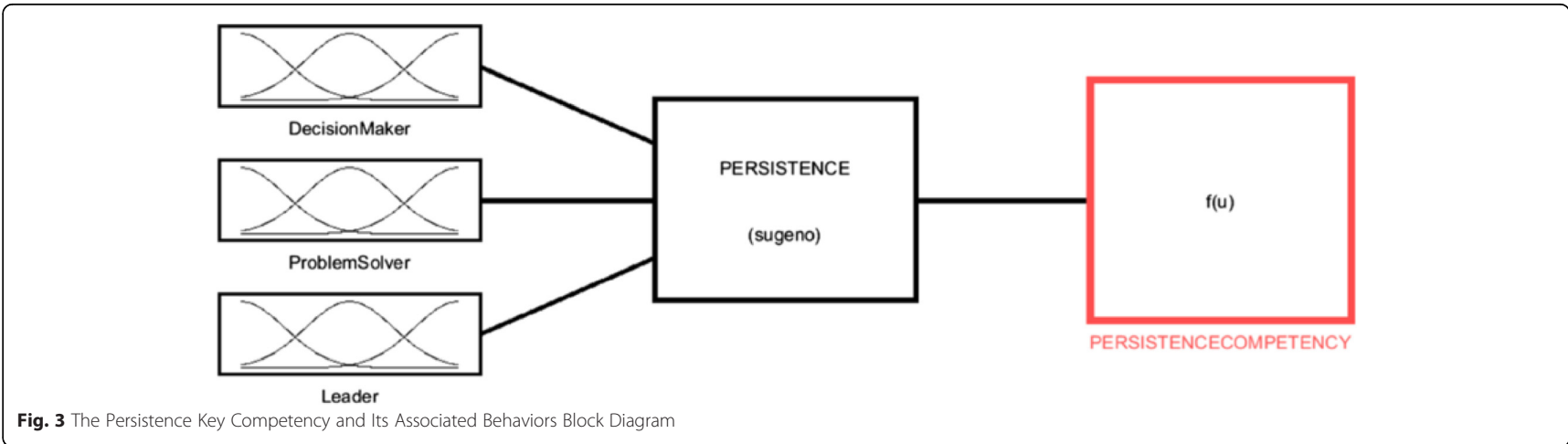

Fig. 3 The Persistence Key Competency and Its Associated Behaviors Block Diagram

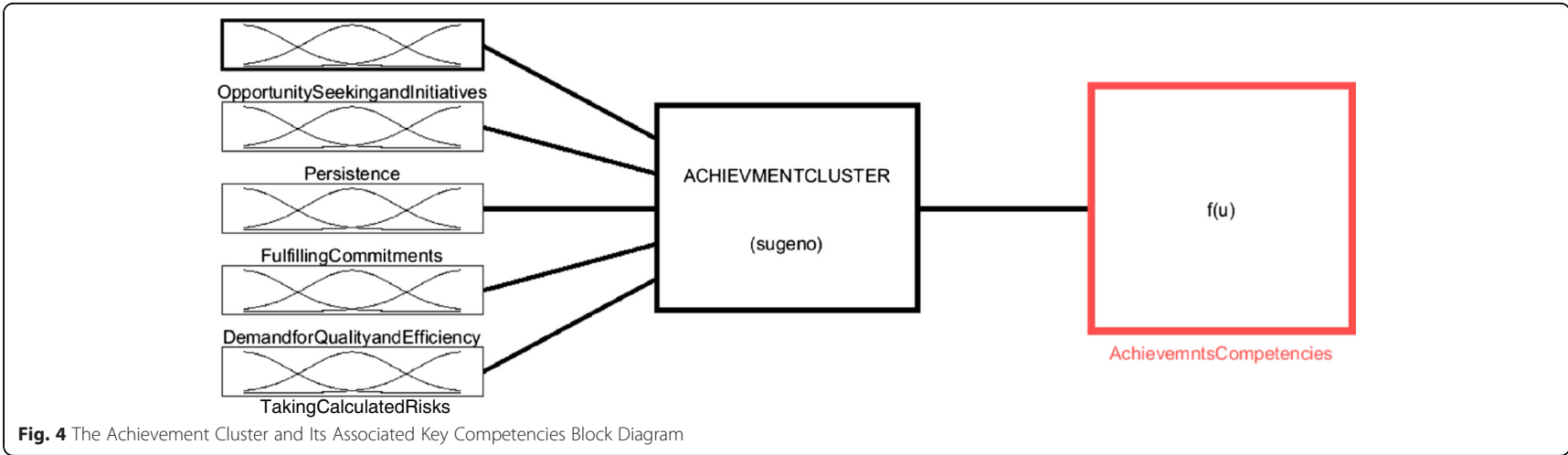

Fig. 4 The Achievement Cluster and Its Associated Key Competencies Block Diagram

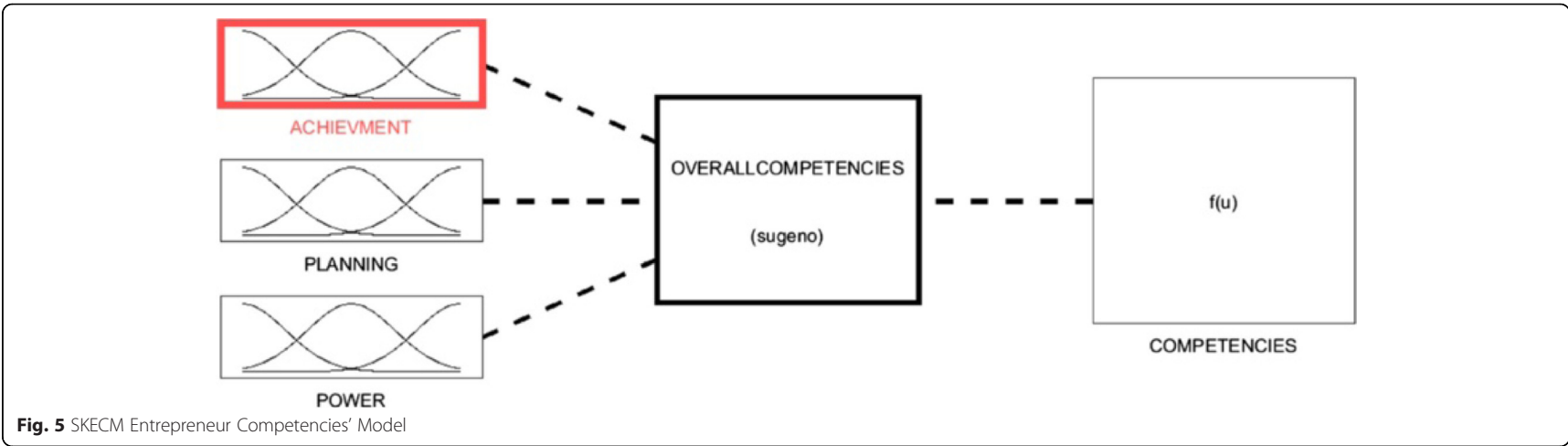

Fig. 5 SKECM Entrepreneur Competencies' Model

The softcomputing modeling techniques

Softcomputing is an emerging approach to computing, which mimics the remarkable ability of the human mind to reason and learn in an environment of uncertainty and imprecision (Zadeh 1994). Softcomputing is a combination of multidisciplinary approaches to model and enable solutions to real world problems. It encompasses several computing fields including fuzzy logic (FL) through the fuzzy if-then rules; neural networks (NN) for learning and adaptation; and genetic algorithms for evolutionary computation. Hybridization of these approaches will contain the various combined features such as the neurofuzzy approach that combines the NNs and the FL systems. Neurofuzzy will in turn have the reasoning capability of the FL systems and the learning and adaptation abilities from the NNs.

The fuzzy logic methodology incorporates human knowledge and performs inferences and decision-making depending on multi-value notions to solve problems instead of using Boolean logic. FL's basics are derived from fuzzy set theory (Zadeh 1965). A fuzzy system is a mapping of an input data vector into a scalar output based on FL, using the fuzzyfication, fuzzy inference, and defuzzification components. The fuzzyfication component maps a crisp input space into appropriate linguistic labels of fuzzy sets known as membership functions. The fuzzy inference component contains a rule base that holds fuzzy rules: a database that defines the MFs used in the fuzzy rules, normalizes the input and output universes of discourse, and performs the fuzzy partitioning of the input and the output spaces; and a reasoning mechanism that performs the inference process upon the rules and given condition to derive a reasonable output. The defuzzification component converts the aggregated fuzzy set to a crisp output value. Thus, FL theory logic provides a mathematical strength to capture the uncertainties associated with human cognitive processes, like thinking and reasoning. The neural networks is an information processing paradigm stimulated by biological nervous systems such as our brain. NN is composed of large number of highly interconnected neurons working together. NN learns from experience complex functional relations by generalizing from a limited amount of known input/output training data. NN has its strength in learning and adaptation. The main learning algorithm that has been implemented is the back propagation in addition to the subtractive clustering approach. Neurofuzzy models are used to achieve the reasoning and learning capabilities of FL and NN, respectively. One of these neurofuzzy approaches, namely adaptive network-based fuzzy inference systems or artificial neurofuzzy inference systems (ANFIS) (Jang 1993) has been implemented. Using known pairs of input/output datasets, ANFIS constructs a fuzzy inference system (structural identification), or makes use of the generated clusters by the subtractive clustering model. The generated membership function parameters are then tuned (parameter identification) using a learning rule such as the BP algorithm. This is the first time that the neurofuzzy approach is implemented to address the modeling of the entrepreneurial competencies as described in this paper.

Description of the SKECM model

The proposed three-stage SKECM model as presented in Fig. 2 is based on neurofuzzy approach that uses the associated behaviors of the ten KECs' values as inputs and models them individually. Next, the outputs of these ten KECs are fed into the second stage. The three entrepreneurial competencies' clusters are modeled based on their related KECs. The three clusters' models are then modeled to produce the overall

entrepreneurial competencies. The processing of these three inputs results in a value that describes and represents the status and of the overall competencies of an entrepreneur under consideration. The following subsections will describe in more details the processing of these three stages.

Stage 1 Individually, each KEC has been modeled using the neurofuzzy modeling technique to represent and describe the relations between all its associated behaviors with equal weights. These weights can be modified according to the organizational considerations, contexts, and environment. (Decision maker, problem solver, and leader), which produces the persistence competency as an output as described in Fig. 3. The output of each of these models represents the relations between all of the involved input corresponding behaviors and the output (KEC), taking into account the contribution of all these inputs to produce the output. In other words, such a model depicts the quality of each KEC as the linguistic terms: POOR, SATISFIED, GOOD, and EXCELLENT. The relations between these three input behaviors (decision maker, problem solver, and leader) and the resulted outputs are described in this model to produce the output. With equal weights' contribution, the relationship between these behaviors and the produced output, PersistenceCompetency, is described by the following fuzzy if-then Sugeno first order rule (The output or consequent part is a nonfuzzy first order linear equation) (Jang and Sun 1995):

Rule R_i: *if* (DecisionMaker is In_iCluster_i) and (ProblemSolver is In2Cluster_i) and (Leader is In3Cluster_i)

Then PersistenceCompetency is the i^{th} linear = $p_i + q_i + r_i$ (Jang and Sun 1995) where i indicates the i^{th} rule, that relates the i^{th} inputs terms (DecisionMaker, ProblemSolver, Leader) with the i^{th} consequent or output (PersistenceCompetency) p_i , q_i and r_i are first order linear parameters. In_iCluster_i, In2Cluster_i and In3Cluster_i are i^{th} input fuzzy sets.

Similarly, all of the stated ten KECs have been modeled to produce the competency of each KEC.

Stage 2 Individually, each cluster has been modeled based on the neurofuzzy modeling technique to signify and describe the relations between all its KECs with equal weights. These weights can be modified according to the organizational considerations, contexts, and environment. The output of each of these models represents the relations between all of the involved input corresponding KECs and the output, taking into account the contribution of all these inputs (opportunity-seeking and initiative, persistence, fulfillment of commitments, demand for quality and efficiency, and calculated risks) to produce the output (ACHIEVEMENTCLUSTER) as shown in Fig. 4. In other words, such a model depicts the quality of each cluster as the linguistic terms: POOR, SATISFIED, GOOD and EXCELLENT. The achievement cluster has five KECs that influence and contribute to its output.

The relations between these five input KECs and the resulted outputs are described in this model to produce the output with equal inputs weights' contribution is described by the following rule (the output follows the nonfuzzy Sugeno first order linear):

Rule R_i: *if* (OpportunitySeekingandInitiative is In1Cluster_i) and (Persistence is In2Cluster_i) and (FulfillmentofCommitments is In3Cluster_i) and (DemandforQualityandEfficiency is In4Cluster_i) and (CalculatedRisks is in5Cluster_i)

Then ACHIEVEMENTCLUSTER is the i^{th} linear = $p_i + q_i + r_i$ (Jang and Sun 1995)

where i indicates the i^{th} rule that relates the i^{th} inputs terms (OpportunitySeekingand Initiative, Persistence, FulfillmentofCommitments, DemandforQualityandEfficiency CalculatedRisks) with the i^{th} consequent or output (ACHEIEVEMNTCLUSTER) p_i , q_i and r_i are first order linear parameters. $In1Cluster_i$, $In2Cluster_i$, $In3Cluster_i$ and $In4Cluster_i$ are the i^{th} input fuzzy sets parameters.

Similarly, all of the stated three clusters have been modeled to produce the competency of each cluster.

Figure 6 illustrates the calculated versus the Predicted Competencies (output) for the Achievement Cluster.

Stage 3 The outputs of the three clusters models (from Stage 2) are inputs, with equal weights, to the overall neurofuzzy model as presented in Fig. 5. The weights of these inputs can be modified according to the organizational concerns. This overall model describes the relationships of the produced outputs of the three clusters, in the second stage (input), and the produced overall competency of the system. It is worth mentioning that all inputs have contributed equally to produce the output of the system.

Figure 7 illustrates the internal structure of the overall SKECM model. The rules that govern the model have the following form (Sugeno first order linear model):

Rule R_i : *if* (ACHIEVEMENTCLUSTER is $in1Cluster_i$) and (PLANNINGCLUSTER is $In2Cluster_i$) and (POWERCLUSTER is $In3Cluster_i$)

Then OVERALLCOMPETENCY is the i^{th} linear = $p_i + q_i + r_i$ (Jang and Sun 1995) where i indicates the i^{th} rule that relates the i^{th} inputs terms (ACHIEVEMENTCLUSTER, PLANNINGCLUSTER, POWERCLUSTER) with the i^{th} output or consequent (OVERALLCOMPETENCY) p_i , q_i , and r_i are first order linear parameters. $In1Cluster_i$, $In2Cluster_i$, and $In3Cluster_i$ are the i^{th} input fuzzy sets parameters.

Models' validation

The tested and validated data to verify the performance of the whole SKECM model has been randomly generated. Two hundred fifty pairs of datasets have been used to train and validate the SKECM model. For every individual model, 250 datasets have been split into training and checking datasets using the cross validation approach

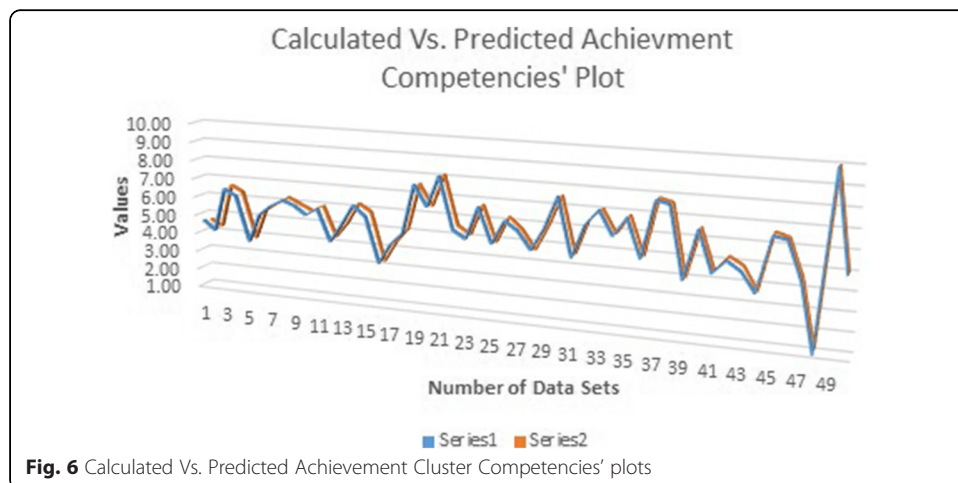
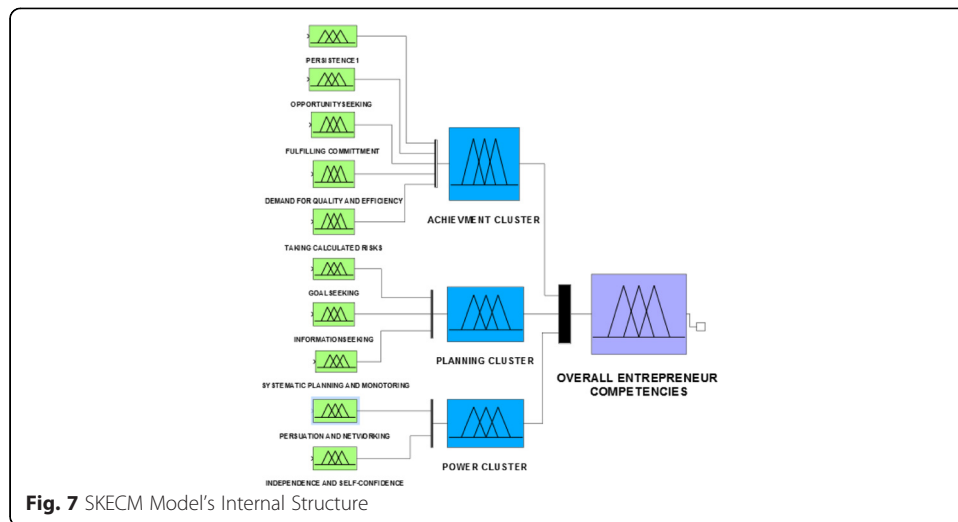

Fig. 6 Calculated Vs. Predicted Achievement Cluster Competencies' plots



(<http://kelley.iu.edu/IIB/ProgramsandInitiatives/YELP/page45835.html>). That is, 80 % of the data has been used as the training set and the rest as the checking set.

Three measures have been used to check the adequacy of the developed models: the mean absolute percentage error (MAPE), which measures the average of the absolute percentage errors of forecasts as in equation (1); the correlation coefficient (CC) measure that determines the degree to which two variables' movements are associated as in equation (2); and the max percent error (MPE) between the calculated and predicted values as in equation (3). These measures are calculated using the following formulae:

$$MAPE = \frac{1}{n} \sum_{i=1}^n \left| \frac{Calculated_i - Predicted_i}{Calculated_i} \right| \tag{1}$$

where n is the number of values.

$$CC_{predicted \text{ Calculated}} = \sqrt{\left[1 - \frac{\sum_i (Calculated_i - Predicted_i)^2}{\sum_i (Calculated_i - Calculated_i)^2} \right]} \tag{2}$$

$$MPE = MAX \left(\frac{|Calculated - Predicted|}{Calculated} \times 100 \right) \tag{3}$$

SKECM simulated version

A simulated version of the SKECM version has been developed as shown in Fig. 8, in order to obtain the overall entrepreneurial competency. The SKECM-simulated tool provides a friendly user interface, where any value in the range between 1.0 and 10.0 is used as an input to any behavior(s) as in the first stage. Furthermore, the interface provides users the ability to set any value for the behaviors and accordingly predict the overall performance, competency, and capability of the entrepreneur under consideration as shown in Fig. 9. The SKECM capability is demonstrated with randomly setting values clusters: 7.7 to ACHIEVEMENTCLUSTER, 7.91 to PLANNINGCLUSTER, and 7.44 to POWERCLUSTER. The predicted output is equal to 7.68. Following a scale of a four-level Likert one 1-<3.5 is POOR; 3.5-<7.0 is SATISFIED; 7.0-<8.5 is GOOD, and 8.5-10 is EXCELLENT. The overall entrepreneurial competency of the entrepreneur under consideration is GOOD.

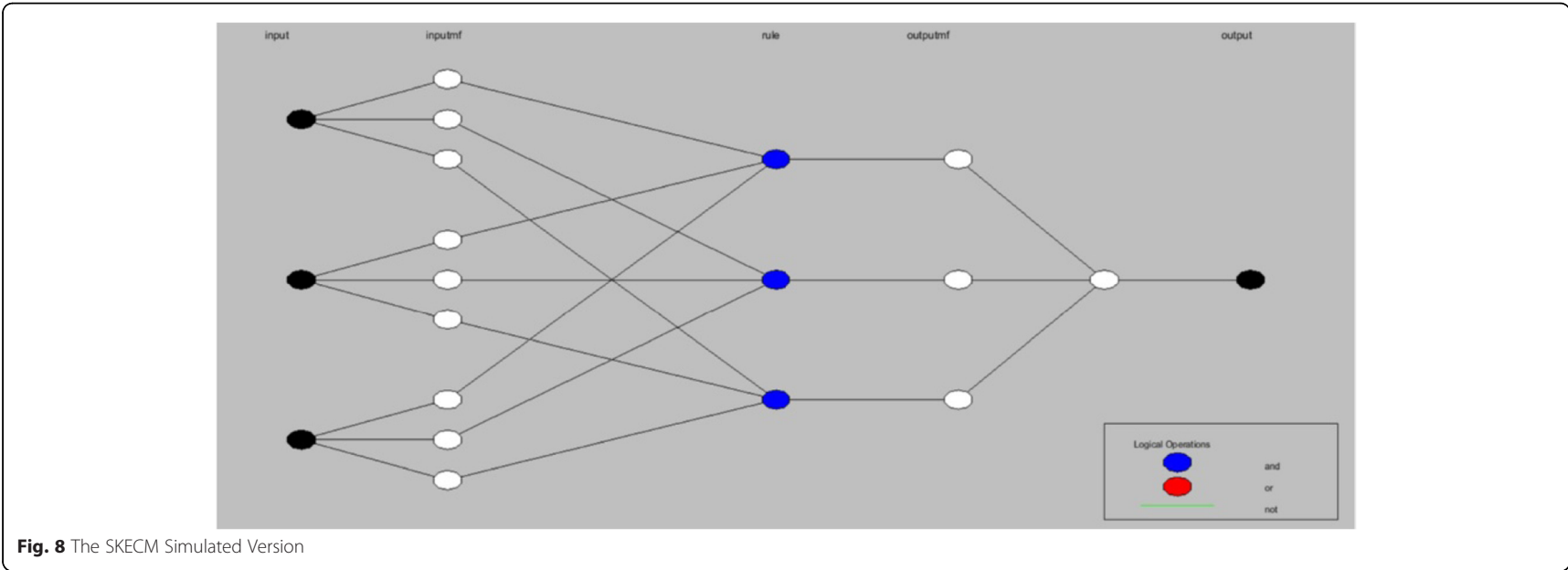

Fig. 8 The SKECM Simulated Version

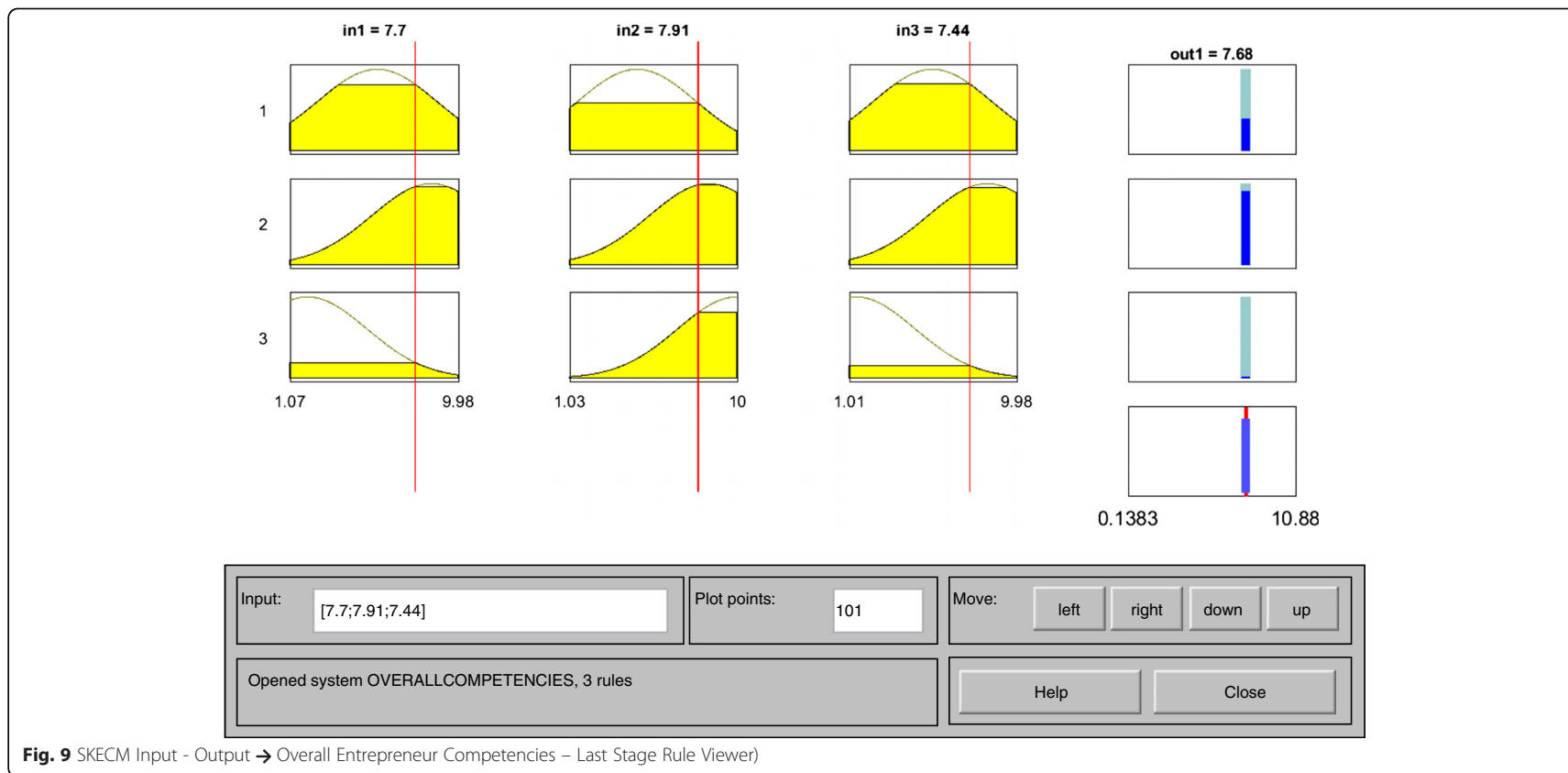

Fig. 9 SKECM Input - Output → Overall Entrepreneur Competencies – Last Stage Rule Viewer)

Results and discussion

The SKECM model has been developed to assess the overall entrepreneurial competency of the various KECs including the overall entrepreneurial competency. A sample of SKECM first stage is as depicted in Fig. 3. To validate the models, datasets have been randomly generated in the range 1.0 to 10.0. That is, a 1.0 to 10.0 scale has been used to assess each EKC and the overall entrepreneurial competency.

It is assumed that such a scale represents four categories: POOR to cover the range between 1.0 to less than 3.49; SATISFIED to cover the range from 3.5 to less than 7.0; GOOD to represent 7.0 to less than 8.5 range; and EXCELLENT to represent the 7.5 to 10 range.

For each KEC model, the associated behaviors are given values between 1.0 and 10. The calculated output, the competency of that particular KCE, is the average of these input values. This assessment is mainly based on the evaluation or judgment of all related behaviors. The predicted outputs of all KECs are combined together to provide the overall KAs' competency. Two hundred fifty datasets have been randomly generated and split into training and checking datasets using the cross validation approach (<http://kelley.iu.edu/IIB/ProgramsandInitiatives/YELP/page45835.html>). In other words, 80 % of the dataset has been used as the training set, and the remaining 50 dataset has been used as the checking set that contains the non-seen data to the model.

The softcomputing approach has been used to develop such models. Authors of this paper have tried several softcomputing techniques. These include neurofuzzy with a hybrid learning algorithm, subtractive clustering, and a combination of the subtractive clustering and the neurofuzzy approaches. The best results have been obtained by making use of the subtractive clustering and the neurofuzzy approaches. Thus, all of the developed models are based on the combinations of the two approaches.

Figure 10 presents a sample of the various inputs' values as well as all obtained competencies' values for all 14 developed models, thus covering the stages. Figure 11 illustrates the various obtained MAPE values for all 11 models (ten KECs, three clustered KEC, and the overall KEC). MAPE ranges between 0.8511 for the information seeking model to 2.9551 for the persuasion and networking model. However, the achieved MAPE value for the overall competencies model is 1.2087. MAPE values measure the accuracy of the predicted output. These small MAPE values reflect the high accuracy of the various developed models. Such accuracy has been consistent with the obtained values of the CC measure. The obtained CC values are shown in Fig. 12. The obtained high CC values that range between 0.9964, which corresponds to the persuasion and networking model, and 0.9996 show the adequacy of such models to predict the competencies of the various KECs. The CC measure determines the degree to which two variables' movements, calculated and predicted values, are associated. Moreover, the attained MPE measure values, shown in Fig. 13, are in consistence with the other used measures. The various obtained MPE values range between 1.6374 and 6.3175. The percentage error (PE) provides the difference between the calculated and the predicted values as a percentage of the calculated value that help see how close the prediction is to the calculated values. MPE provides the maximum of these closeness. Finally, Fig. 14 compares the calculated and predicted values of the overall KECs competencies.

These results reflect the adequacy of applying the softcomputing approach to the field of entrepreneurship, particularly, the prediction or assessment of the entrepreneurial key competencies.

Cluster	Competencies	Attributes	Input				Competency Output	Cluster Output	Overall Competencies Output
			Poor	Satisfied	Good	Excellent			
ACHIEVEMENT	Opportunity-Seeking and Initiatives	Initiative-taker	4.64				5.06 (Satisfied)	7.7 (GOOD)	7.68 (GOOD)
		Innovative		5.72					
		Opportunity-seeker	4.81						
	Persistence	Decision Maker			7.89		8.02 (Good) 8.03		
		Problem Solver			7.56				
		Leader				8.64			
	Fulfilling Commitments	Hard-Worker				8.76	8.31 (Good)		
		Proactive			7.33				
		Business Focus				8.85			
	Demand for Quality and Efficiency	Efficiency-Orientated			8.43		8.56 (Excellent)		
		Quality Consciousness			8.41				
		Determined				8.85			
	Taking Calculated Risks	Risk-Taking				8.62	8.54 (Excellent)		
		Risk-Managing			8.28				
Desirable					8.74				
PLANNING	Goal-Seeking	Goal-Oriented			8.32	8.53 (Excellent)			
		Effective Strategist			8.64				
		Proper Planner			8.63				
	Information-Seeking	Competitors' Aware			8.08		8.12 (Good)		
		Creative			7.66				
		Information Seeker				8.64			
Systematic Planning and Monitoring	Systematic Planner			8.41		7.08 (Good)			
	Performance-Oriented			7.00					
	Book-Keeper		5.83						
POWER	Persuasion and Networking	Persuasive			8.53	7.01 (Good)			
		Influence Strategy User	3.44						
		Networker					9.06		
	Independence and Self-Confidence	Independent			8.21		7.73 (Good)		
		Self-Esteem		5.93					
	Self-Confident				9.06				

Fig. 10 A sample of the inputs' values and all obtained competencies' values for all 14 developed models, covering the three stages

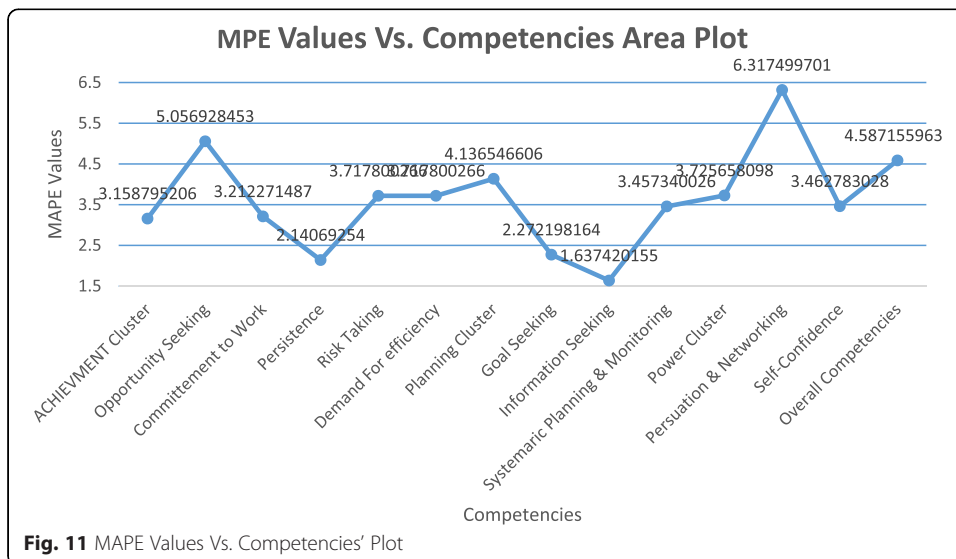
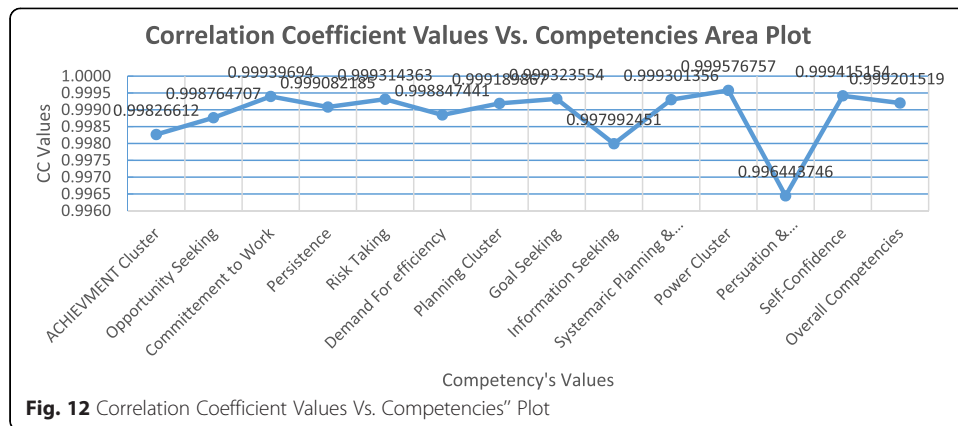

Fig. 11 MAPE Values Vs. Competencies' Plot



Conclusions

Palestine has witnessed active entrepreneurship-related initiatives and programs. The main characteristics of these initiatives are donor-based ones that raise the question of sustainability, informal non-governmental organizations-hosted rather than formal universities-offering. The quality of such programs and the quality of obtained entrepreneurship competencies have never been evaluated. The time has come for the Palestinian higher education institutes to follow the emerging trend of offering formal entrepreneurship courses and programs. It is for sure, it will be an essential step to provide community with entrepreneurs and self-employers who will create jobs and thus boost the economic situation.

A softcomputing-based SKECM model has been developed to predict each KEC and clustered competencies depending on their individual associated behaviors that are treated as black boxes. An overall entrepreneurial competencies assessment has also been achieved in the third stage of the SKECM model. The different adopted behaviors, ten KECs, and three clusters are as provided by Empretec. The validation of these models has been accomplished by randomly generating 250 datasets. Using the cross-validation

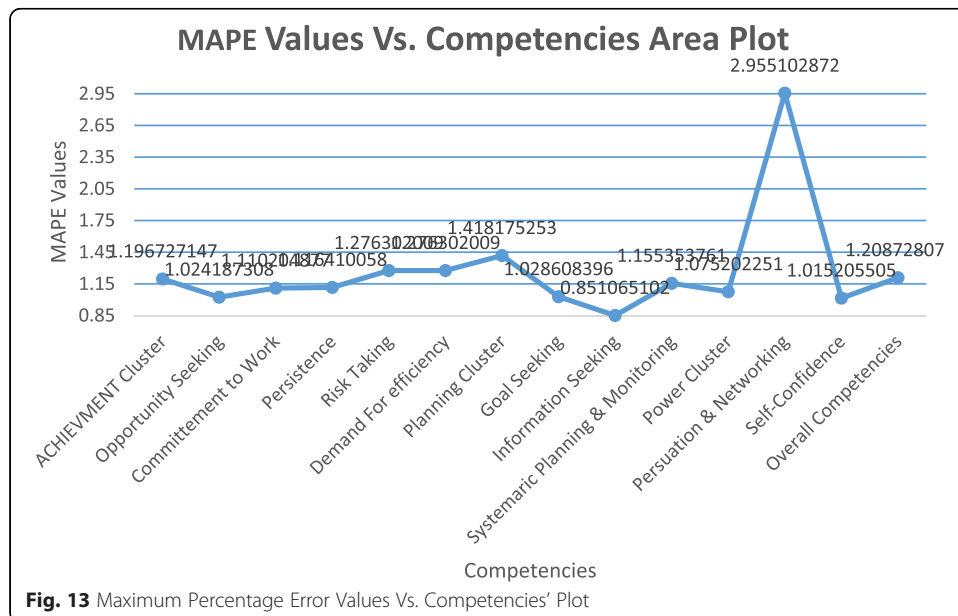

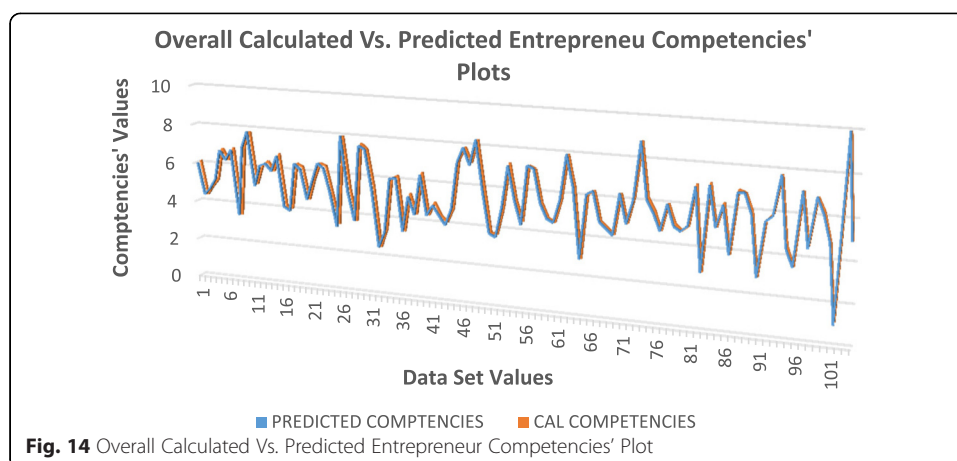

algorithm, the generated datasets have been split into training and checking datasets. Three measures have been used to validate the adequacy and accuracy of such models: MAPE, CC, and MPE. The top obtained MAPE, CC, and MPE values are 0.8511, 0.9996, and 6.3175, respectively. These consistent values suggest the potential, adequacy, and suitability of the softcomputing approach to assess and predict the entrepreneurial key competencies and the overall entrepreneurial competencies in the field of the entrepreneurship.

The developed SKECM model will be proposed to judge or evaluate the quality of the obtained entrepreneurial competencies from the various running of entrepreneurship training programs.

Thus, the future research study will focus on validating such models against benchmarked realistic data. This step is essential to fine-tune the models before stating the adequacy of applying the softcomputing approach to the field of entrepreneurship. In addition, in order to succeed in business, it is essential to integrate the KECs models throughout the business planning process that includes several planning tasks like introduction, description of business, description of products and services, customers, competition, location, pricing, marketing, key personnel, material and sources of supply, manufacturing and production, sales forecast predict profit and loss, forecast cash flow, and presentation. Furthermore, it is worth integrating KECs models with the innovation and business start-ups.

Competing interests

The author's declare that they have no competing interests.

Received: 5 September 2015 Accepted: 23 April 2016

Published online: 27 June 2016

References

- 80% of universities open entrepreneurship courses, University World News, issue 388, Oct. 2015, available at: <http://www.universityworldnews.com/article.php?story=20151031113627331> Accessed 2 Jan 2016
- Abdullah, F., et al. (2009). Developing a framework of success of Bumiputera entrepreneurs. *Journal of Enterprising Communities*, 3(1), 8–24.
- Ahmad, N. H., et al. (2010). Is entrepreneurial competency the silver bullet for SME success in a developing nation? *International Business Management*, 4(2), 67–75. doi:10.3923/ibm.2010.67.75. <http://www.medwelljournals.com/abstract/?doi=ibm.2010.67.75>
- Anne, M.L., (2011). 10 competencies for entrepreneurial success. *Scribd*
- Badal, S.B, (2014). 10 Talents that drive entrepreneurial success. *Entrepreneurial Strengths Finder*, Gallup Press, 2014, ISBN-13: 978-1595620828
- Boyatzis, R. (1982). *Competent manager: a model for effective performance*. New York: John Wiley & Sons.
- Brinckmann, J. (2007). *Competence of top management teams and success of new technologybased firms: a theoretical and empirical analysis concerning competencies of entrepreneurial teams and the development of their ventures*. Wiesbaden: DUV.
- Brinckmann, J. (2008). *Competence of top management teams and the success of new technology-based firms: a theoretical and empirical analysis concerning competencies of entrepreneurial teams and the development of their ventures*. Wiesbaden: Gabler.

- Chell, E. (2008). *The entrepreneurial personality: a social construction*. London: Routledge.
- David, Z., & Edward, B. (2011). Personal characteristics and strategic orientation: entrepreneurs in Canadian manufacturing companies. *International Journal of Entrepreneurial Behaviour & Research*, 17(1), 82–103.
- Driessen, M., (2005). E-Scan Ondernemerstest: beoordeling en ontwikkeling van ondernemerscompetenties, PhD-thesis, Entrepreneur Consultancy, Gravenland
- Entrepreneurship Competency Model. (2010). *The consortium for the entrepreneurship education*. available at <http://www.careeronestop.org/competencymodel/competency-models/entrepreneurship.aspx> Accessed 15 Jun 2015.
- Hisrich, R.D., (2011). *Entrepreneurship*. McGraw-Hill Education. ISBN 978-0-07062-017-9
- <http://amideast.org/our-work/elt/entrepreneurship-training> Accessed 26 Dec 2015
- <http://amideast.org/west-bank-gaza> Accessed 26 Dec 2015
- <http://bti.ps/En/default.aspx> Accessed 24 Dec 2015
- <http://dictionary.reference.com/browse/entrepreneur> Accessed 15 Jun 2015
- <http://efe.org/our-network/palestine> Accessed 10 Dec 2015
- <http://kelley.iu.edu/IIB/ProgramsandInitiatives/YELP/page45835.html> Accessed 15 Dec 2015
- <http://mobaderoon.ps/ar/index.php> Accessed 24 Dec 2015
- <http://sharek.ps/en/> Accessed 15 Dec 2015
- <http://sites.birzeit.edu/nzitce/index.php/pre-incubation> Accessed 24 Dec 2015
- <http://www.alnayzak.org/> Accessed 15 Jun 2015
- <http://www.arabreneur.com/> Accessed 24 Dec 2015
- <http://www.babson.edu/executive-education/custom-programs/entrepreneurship/Pages/entrepreneurship-ecosystem.aspx> Accessed 24 Dec 2015
- <http://www.bader.ps/> Accessed 26 Dec 2015
- <http://www.businessdictionary.com/definition/entrepreneur.html> Accessed 15 Jun 2015
- <http://www.bwf.ps/index.php/en/> Accessed 24 Dec 2015
- <http://www.enpicbmed.eu/programme/about-the-programme> Accessed 24 Dec 2015
- <http://www.gazaskygeeks.com/> Accessed 24 Dec 2015
- <http://www.ibdaa.ps> Accessed 15 Jun 2015
- http://www.ilo.org/wcmsp5/groups/public/—ed_mas/—eval/documents/publication/wcms_174956.pdf Accessed 24 Dec 2015
- <http://www.intel.com/content/www/us/en/education/k12/intel-learn/curriculum.html> Accessed 15 Dec 2015
- <http://www.iyfnet.org/initiatives/youth-entrepreneurship-development-yed> Accessed 24 Dec 2015
- <http://www.leaders.ps/> Accessed 26 Dec 2015
- <http://www.leaders.ps/the-fastforward-accelerator-program/> Accessed 24 Dec 2015
- <http://www.netkite.eu/project-2/> Accessed 24 Dec 2015
- <http://www.pcbs.gov.ps/site/512/default.aspx?tabID=512&lang=en&ItemID=1397&mid=3172&wverson=Staging> Accessed 10 Dec 2015
- <http://www.pgfoundation.ps/?lang=en> Accessed 24 Dec 2015
- <http://www.picti.ps/> Accessed 24 Dec 2015
- <http://www.picti.ps/introductory-meeting-for-intilqa/> Accessed 24 Dec 2015
- <http://www.picti.ps/palestineinnovationinitiative/> Accessed 24 Dec 2015
- <http://www.picti.ps/project/picti-palestine-bic-and-intel-launch-the-palestine-business-plan-contest-2013/> Accessed 24 Dec 2015
- <http://www.picti.ps/teamstart-palestine-2/> Accessed 24 Dec 2015
- <http://www.pipa.ps/> Accessed 26 Dec 2015
- <http://www.portlandtrust.org/projects/training-entrepreneurship> Accessed 15 Dec 2015
- <http://www.rawabi.ps/foundation/> Accessed 15 Dec 2015
- <http://www.sec-pal.org/> Accessed 15 Dec 2015
- <http://www.silatech.com/home/project-countries/palestine> Accessed 15 Dec 2015
- <http://www.siraj.ps/> Accessed 15 Dec 2015
- <http://www.spark-online.org/> Accessed 24 Dec 2015
- <http://www.ta3mal.ps/en/Pages/Home.aspx> Accessed 15 Dec 2015
- <http://www.tawasul.com/> Accessed 26 Dec 2015
- <http://www.thefreedictionary.com/competency> Accessed 15 Jun 2015
- <http://www.tradingeconomics.com/palestine/indicators> Accessed 10 Dec 2015
- <http://www.ucasti.ps/> Accessed 24 Dec 2015
- <http://www.undp.ps/en/> Accessed 24 Dec 2015
- <http://www.wamda.com/2015/09/palestine-s-top-8-incubators> Accessed 24 Dec 2015
- <http://www.welfareassociation.org/> Accessed 24 Dec 2015
- <http://www.worldbank.org/en/news/press-release/2015/09/27/palestinians-getting-poorer-for-third-year-in-a-row> Accessed 10 Dec 2015
- <http://www.wsa-mobile.org/news/wsa-palestine-workshop-460220140507ok> Accessed 24 Dec 2015
- <https://www.annalindhfoundation.org/members/young-entrepreneurs-palestine-yep> Accessed 15 Dec 2015
- <https://www.imaginecup.com/competition/17368> Accessed 24 Dec 2015
- Master programs in entrepreneurship, Europe, <http://www.masterstudies.com/Masters-Degree/Entrepreneurship/Europe/>; Accessed 2 Jan 2016
- Entrepreneurship bachelor's degrees in UK, Bachelor Portal, <http://www.bachelorsportal.eu/study-options/268927062/entrepreneurship-united-kingdom.html>; Accessed 2 Jan 2016
- James, H., (2011). Test for personal entrepreneurial competencies. *Scribd*
- Jang, J.-S. R. (1993). ANFIS: adaptive-network-based fuzzy inference systems. *IEEE Transactions on Systems, Man, and Cybernetics*, 23(3), 665–685.
- Jang, J. S. R., & Sun, C.-T. (1995). Neuro fuzzy modeling and control. *IEEE Proc.*, 83(3), 378–405.
- Kaur H., Bains, A., (2013) Understanding the concept of entrepreneur competency. *Journal of Business Management & Social Sciences Research (JBM&SSR)*. 2(11), 31–33.

- Kaur, H., et al. (2013). Understanding the concept of entrepreneur competency. *Journal of Business Management & Social Sciences Research*, 2(11), 2013.
- Khefacha, I., & Belkacem, L. (2015). Modeling entrepreneurial decision-making process using concepts from fuzzy set theory. *Journal of Global Entrepreneurship Research*, 5, 13. doi:10.1186/s40497-015-0031-x. available at <http://link.springer.com/article/10.1186/s40497-015-0031-x>; Accessed 15 Jul 2015.
- Lackéus, M., (2013). Developing entrepreneurial competencies: an action-based approach and classification in education. Engineering thesis, CHALMERS University of Technology available at <http://vcplis.com/wp-content/uploads/2013/11/Lackeus-Licentiate-Thesis-2013-Developing-Entrepreneurial-Competencies.pdf>; Accessed 15 Jul 2015
- Linton, J., & Walsh, S. (2013). The effect of technology on learning during the acquisition and development of competencies in technology-intensive small firms. *International Journal of Entrepreneurial Behavior & Research*, 19(2), 165–186.
- Lüthjel, C., Franke, N., (2003). R&D management 33, 2, 2003, available at <http://onlinelibrary.wiley.com/doi/10.1111/1467-9310.00288/pdf> Accessed 15 Jul 2015
- Man, T. W. Y. (2006). Exploring the behavioural patterns of entrepreneurial learning: a competency approach. *Education+Training*, 48(5), 309–321.
- McClelland, D. C. (1987). Characteristics of successful entrepreneurs. *The Journal of Creative Behavior*, 21, 219–233. doi:10.1002/j.2162-6057.1987.tb00479.
- McClelland, D. C. (1990). *Entrepreneurship training and the strengthening of entrepreneurial performance, Final Report, Management systems international*. available at http://pdf.usaid.gov/pdf_docs/pnabg210.pdf; Accessed 01 Jun 2015.
- Mirjana, R.M., Dušan, M., (2014) Measuring professional competencies of virtual teams: fuzzy-logic based model. <http://ipsitransactions.org/journals/papers/tar/2014july/01.pdf> Accessed 15 Jul 2015
- Mitchelmore, S., & Rowley, J. (2010). Entrepreneurial competencies: a literature review and development agenda. *International Journal of Entrepreneurial Behavior & Research*, 16(2), 92–111.
- Mitchelmore, S., & Rowley, J. (2013). Entrepreneurial competencies of women entrepreneurs pursuing business growth. *Journal of Small Business and Enterprise Development*, 20(1), 125–142.
- Penchev, P., Salopaju, A., (2011). Entrepreneurial competencies needed by managers in their work. Master Thesis, Jönköping University available at <http://www.diva-portal.org/smash/get/diva2:419847/FULLTEXT01.pdf>; Accessed 15 Jul 2015
- Pofeldt, E. (2014). The 10 qualities of highly successful entrepreneurs. *Forbes*
- Prats, M.J., et al. (2009) "Beyond Business Instinct" Estudios y Ediciones IESE, IESE, Insight. Issue 1. Second quarter 2009;
- Rozell, E.J., et al. (2011). Perceptions of the characteristics of successful entrepreneurs: an empirical study in China. *International Journal of Management*, 28(4), 279–291.
- Shukla, A. (2009). *Gallup: top 7 personal competencies of an entrepreneur*.
- Smith, G., Shankar, A., (2015). Empowered entrepreneur training handbook, the Global Alliance for Clean Cookstoves, available at <http://cleancookstoves.org/binary-data/RESOURCE/file/000/000/342-1.pdf> Accessed 15 Jul 2015
- Sugars, B. (2014). *12 Essential characteristics of an entrepreneur*. available at http://www.actioncoach.com/_downloads/whitepaper-FranchiseRep5.pdf; Accessed 15 Jul 2015.
- The Canadian National Research Council Entrepreneurship, http://www.nrc-cnrc.gc.ca/eng/careers/behavioural_competencies/entrepreneurship_competency.html Accessed 15 Jul 2015
- The competency model development and use: a technical assistance guide, (2015), available http://www.careeronestop.org/competencymodel/info_documents/tag.pdf; Accessed 15 Jul 2015
- The Empretec program: the entrepreneur's guide (2015), available at http://empretec.unctad.org/wp-content/uploads/2015/09/EG_eng.compressed.pdf Accessed 15 Jul 2015
- The global entrepreneurship monitor—adult population survey measures, 2015, <http://www.gemconsortium.org/data/key-indicators> Accessed 2 Jan 2016
- The UNCTAD entrepreneurship policy framework (2012), UNCTAD/DIAE/ED/2012/1, UN
- Wu, W., (2009). A competency-based model for the success of an entrepreneurial start-up. *WSEAS Transactions on Business and Economics*. Issue 6, Volume 6
- www.tomorrowyouth.org Accessed 26 Dec 2015
- Yaghoubi, N., Jamshid, M., Banihashemi, S.A., Entrepreneurship in organization and social capital: fuzzy logic approach. http://download.springer.com/static/pdf/227/art%253A10.1186%252F540497-015-0031-x.pdf?originUrl=http%3A%2F%2Fjournal-jger.springeropen.com%2Farticle%2F10.1186%252F540497-015-0031-x&token2=exp=1462112487~acl=%2Fstatic%2Fpdf%2F227%2Fart%25253A10.1186%252F540497-015-0031-x.pdf*~hmac=64286d23a9707e3dfb3c3ab6bd431c315c1ae32c08d5999fd9cb802291b5b194.
- Zadeh, L. (1965). Fuzzy sets'. *Information and Control*, 8, 338–353.
- Zadeh, L. A. (1994). Fuzzy logic, neural networks and soft computing. *Communications of ACM*, 37(3), 77–84.
- Zhi-qiang M, et al. Research on entrepreneur FWNN-BDI model in different entrepreneurial environment, computer application and system modeling (ICCSM), 2010 International Conference on (Vol. 4), IEEE, 10.1109/ICCSM.2010.5619263.