

Carneiro, Pedro; Lopez Garcia, Italo; Salvanes, Kjell G.; Tominey, Emma

**Working Paper**

## Intergenerational Mobility and the Timing of Parental Income

IZA Discussion Papers, No. 9479

**Provided in Cooperation with:**

IZA – Institute of Labor Economics

*Suggested Citation:* Carneiro, Pedro; Lopez Garcia, Italo; Salvanes, Kjell G.; Tominey, Emma (2015) : Intergenerational Mobility and the Timing of Parental Income, IZA Discussion Papers, No. 9479, Institute for the Study of Labor (IZA), Bonn

This Version is available at:

<https://hdl.handle.net/10419/124995>

**Standard-Nutzungsbedingungen:**

Die Dokumente auf EconStor dürfen zu eigenen wissenschaftlichen Zwecken und zum Privatgebrauch gespeichert und kopiert werden.

Sie dürfen die Dokumente nicht für öffentliche oder kommerzielle Zwecke vervielfältigen, öffentlich ausstellen, öffentlich zugänglich machen, vertreiben oder anderweitig nutzen.

Sofern die Verfasser die Dokumente unter Open-Content-Lizenzen (insbesondere CC-Lizenzen) zur Verfügung gestellt haben sollten, gelten abweichend von diesen Nutzungsbedingungen die in der dort genannten Lizenz gewährten Nutzungsrechte.

**Terms of use:**

*Documents in EconStor may be saved and copied for your personal and scholarly purposes.*

*You are not to copy documents for public or commercial purposes, to exhibit the documents publicly, to make them publicly available on the internet, or to distribute or otherwise use the documents in public.*

*If the documents have been made available under an Open Content Licence (especially Creative Commons Licences), you may exercise further usage rights as specified in the indicated licence.*

IZA DP No. 9479

## Intergenerational Mobility and the Timing of Parental Income

Pedro Carneiro  
Italo Lopez Garcia  
Kjell G. Salvanes  
Emma Tominey

November 2015

# Intergenerational Mobility and the Timing of Parental Income

**Pedro Carneiro**

*University College London, IFS, CEMMAP and IZA*

**Italo Lopez Garcia**

*RAND Corporation*

**Kjell G. Salvanes**

*Norwegian School of Economics, IZA, CEE and CEPR*

**Emma Tominey**

*University of York and IZA*

Discussion Paper No. 9479

November 2015

IZA

P.O. Box 7240  
53072 Bonn  
Germany

Phone: +49-228-3894-0  
Fax: +49-228-3894-180  
E-mail: [iza@iza.org](mailto:iza@iza.org)

Any opinions expressed here are those of the author(s) and not those of IZA. Research published in this series may include views on policy, but the institute itself takes no institutional policy positions. The IZA research network is committed to the IZA Guiding Principles of Research Integrity.

The Institute for the Study of Labor (IZA) in Bonn is a local and virtual international research center and a place of communication between science, politics and business. IZA is an independent nonprofit organization supported by Deutsche Post Foundation. The center is associated with the University of Bonn and offers a stimulating research environment through its international network, workshops and conferences, data service, project support, research visits and doctoral program. IZA engages in (i) original and internationally competitive research in all fields of labor economics, (ii) development of policy concepts, and (iii) dissemination of research results and concepts to the interested public.

IZA Discussion Papers often represent preliminary work and are circulated to encourage discussion. Citation of such a paper should account for its provisional character. A revised version may be available directly from the author.

## **ABSTRACT**

### **Intergenerational Mobility and the Timing of Parental Income\***

We extend the standard intergenerational mobility literature by modelling individual outcomes as a function of the whole history of parental income, using data from Norway. We find that, conditional on permanent income, education is maximized when income is balanced between the early childhood and middle childhood years. In addition, there is an advantage to having income occur in late adolescence rather than in early childhood. These results are consistent with a model of parental investments in children with multiple periods of childhood, income shocks, imperfect insurance, dynamic complementarity, and uncertainty about the production function and the ability of the child.

JEL Classification: J24, E24

Keywords: child human capital, intergenerational mobility, parental income timing, semiparametric estimation

Corresponding author:

Kjell G. Salvanes  
Norwegian School of Economics  
Helleveien 30  
5045 Bergen  
Norway  
E-mail: [kjell.salvanes@nhh.no](mailto:kjell.salvanes@nhh.no)

---

\* We thank participants in several seminars for useful comments. Carneiro gratefully acknowledges the financial support from the Economic and Social Research Council for the ESRC Centre for Microdata Methods and Practice (grant reference RES-589-28-0001), the support of the European Research Council through ERC-2009-StG-240910, and ERC-2010-AdG-249612. Salvanes thanks the Research Council of Norway for financial support. Tominey acknowledges the Research Council for Norway, the Leibniz Association, Bonn, in the research network 'Non-Cognitive Skills: Acquisition and Economic Consequences' and the British Academy for support.

# 1 Introduction

There is a large empirical literature examining the intergenerational transmission of economic status (for recent surveys see Solon (1999), Black and Devereux (2011), Björklund and Salvanes (2011)). It is possible to find estimates of intergenerational mobility for various outcomes, and for virtually every country in the world where data linking parents and children is available. Most estimates come from simple models relating a measure of child income and a measure of parental income, such as:

$$y_c = \alpha + \beta y_p + u, \tag{1}$$

where  $y_c$  is a measure of the child's income,  $y_p$  is a measure of parental income, and  $u$  is a residual.

Standard economic models of intergenerational transmission justify the use of equation (1) (e.g., Becker and Tomes (1979), Becker and Tomes (1986)), but they collapse the childhood years to a single period of life. More realistic models of parental investments in children distinguish several stages of childhood (e.g., Cunha and Heckman (2007), Cunha, Heckman, and Schennach (2010), Cunha (2013), Caucutt and Lochner (2012)). They point out that the whole history (in particular, the timing) of parental investments in children may be as or more important than the total amount invested during the childhood years. This means that the timing of income may be as or more important than a single measure of income, and that the model of equation (1) may be misspecified.

This paper extends the literature on intergenerational transmission by examining the relationship between adult outcomes of children and the timing of parental income during their childhood years, using administrative data from Norway. Our main outcome of interest is the child's education (although we also look at other variables). To reduce the dimensionality of the problem, we divide childhood in three periods: early (ages 0-5), middle (ages 6-11) and late (ages 12-17).<sup>1</sup> We find that the timing of income matters, over and above permanent income.

A simple way to present our findings is to describe what happens to education when income is shifted from one period of childhood to another. We show that, as family income in early childhood rises and as income in middle childhood falls, an individual's level of education first increases and then decreases. This means that the child's schooling is maximized when income is balanced across these two periods, rather than when it is concentrated in just one of them.

This is an inverse U-shaped relationship between income in a period and final educational achievement, which is also observed (but less pronounced) when we examine the trade-offs between income in early and late childhood, and income in middle and late childhood. In particular, among children of richer families, schooling tends to increase when we shift income from early to late childhood.

These empirical patterns are consistent with a model with income uncertainty, partial insurance (Blundell, Pistaferri, and Preston (2008)), and complementarity between investments in children across periods (Cunha and Heckman (2007), Cunha, Heckman, and Schennach (2010)). Income

---

<sup>1</sup>Our results are robust to dividing childhood into more periods.

uncertainty, together with partial insurance possibilities, leads to a setting where investments in children react to parental income shocks. Complementarity between investments taking place in different periods means that human capital is maximized when there is a balanced flow of investments. The combination of these factors can result in a model where a balanced flow of income shocks may lead to higher human capital than an unbalanced history of shocks. This would be consistent with an inverse U-shaped relationship between the education of the child and the amount of income that is frontloaded (or backloaded) in the initial (middle) period of childhood.<sup>2</sup>

Finally, if there is uncertainty about a child's ability, or about the parameters of the production function of skill, but if parents learn about either one (or both) of these over time, then there could be an incentive to delay investments until more of this uncertainty is resolved. If that was the case then the late childhood years could be periods where parents are more prone to invest and consequently especially sensitive to income shocks.<sup>3</sup>

Our analysis has three main components. The first one is descriptive, where we document the association between different patterns of timing of parental income and the education (and other adult outcomes) of children. We expand equation (1), by replacing the single regressor  $y_p$  with multiple measures of income, measured at different stages of childhood. In order to do this we need data on the entire family income history for a large number of children, which is rarely available. We use data from Norwegian registries for children born during the 1970s, which allows us to link an individual's outcomes as a young adult to the whole history of parental income during the childhood and adolescence years.

Second, we assess the extent to which we can interpret the association between the child's education and the timing of parental income as causal. We face two (related) challenges. On one end, the timing of income could be a choice variable, potentially correlated with investments in children. For example, there are periods when parents take time off work to take care of their children, such as in the case of maternity leave. On the other end, there is heterogeneity across parents, which can be simultaneously related with income profiles and investments in children. For example, parents with steep income profiles may provide very different parenting from those with flat income profiles.

One way to address some of these issues, at least partially, is to use only father's income, which is less subject to endogenous fluctuations than total family (or mother's) income. In addition, we control for a rich set of variables: permanent father's income (measured either during the child's life, or the entire life of the father), parental education interacted with parental age and the individual specific slope of the income profile (computed from father's earnings measured before the birth of the child, and after she turns 18). We also assess the robustness of our findings to the inclusion

---

<sup>2</sup>However, this type of dynamic complementarity in parental investments is not strictly required to produce this pattern. Other models where parents have a desire to smooth out parental investments over time (because of technology or preferences) would be able to produce it.

<sup>3</sup>It is plausible that this revelation of uncertainty does not affect the trade-off between income in adjacent periods (early vs middle, and middle vs late) as much as the trade-off between income in more distant periods (early vs late), since much more learning takes place between distant periods than between adjacent periods.

of divorce and fertility episodes experienced in the family during an individual's entire childhood. Finally, we document that there is no association between the timing of income and the birthweight of the child, which suggests that the timing of income is not correlated with time invariant unobserved heterogeneity affecting this dimension of child quality.

It is however true that, even if we can convincingly tackle the issues just discussed, we cannot rule out the possibility that we are capturing the effect of the timing of other shocks, which are correlated with the timing of income shocks (such as, for example, parental illness). In that case, we would have to interpret our estimates more broadly as giving us the impact of the timing of parental shocks, which could include income shocks, but also other shocks correlated with shocks to income.

Third, we examine whether the empirical patterns we uncover can be explained by economic models of parental investments in children, with multiple periods of childhood. A simple model without uncertainty is not compatible with our empirical findings, because it predicts that it is never worse to have all income available in early childhood than to have it distributed across early and late periods of childhood. Therefore, we discuss models with income uncertainty, and uncertainty about the ability of the child, and pay particular attention to the roles of credit (and insurance) markets and the technology of skill production in these models.

A few other authors have explicitly examined the role of the timing of income in the formation of human capital. Some of these focus on survey data from the US and Germany, and rely on relatively small datasets (Duncan, Yeung, Brooks-gunn, and Smith (1998), Levy and Duncan (2000), Jenkins and Schluter (2002), Carneiro and Heckman (2003), Caucutt and Lochner (2012)). Others use much larger register data for Denmark and Norway (Aakvik, Salvanes, and Vaage (2005), Humlum (2011)), but nevertheless they estimate very restrictive models. In particular, all these papers estimate regressions of child outcomes on the income of parents at different ages. Since the levels of income in different periods enter in a linear and additive way in these models, they are assumed to be "substitutes" in the production of human capital.

Relative to the papers using US and German survey data our paper relies on much better data (larger samples and richer income histories), which allows us to estimate much more flexible models with considerable precision. This is also true when we contrast our analysis to the ones using register data for Norway and Denmark.

The flexible models we estimate enable us to construct a richer picture of the role of the timing of income than the one presented in previous work. This is important because the complementarity (or other interactions) of investments in human capital across periods (Cunha, Heckman, and Schennach (2010)) may translate into complementarity (or other interactions) of income shocks across periods.

Caucutt and Lochner (2012) present an overlapping generations model of parental investments in children. In addition, Cunha (2013) also presents such a model with overlapping generations and multiple periods of parental investments, explicitly accounting for uncertainty in income. The model presented in this paper is much simpler than the models in any of these two papers. It is neither a general equilibrium model, nor an overlapping generations model, but it serves a much more modest

purpose - we do not use it to conduct policy simulations, we just use it to check whether it is possible to explain the main patterns in the data using a parsimonious economic model of parental investments.

The structure of the paper is as follows. In section 2 we describe the data, and in section 3 we present our empirical methods. Section 4 discusses our empirical results and section 5 examines potential endogeneity of the timing of income. In section 6 we estimate and simulate simple dynamic models of parental investments in children which help us interpret the results. Finally, section 7 concludes.

## 2 Data

Our data source is the Norwegian Registry maintained by Statistics Norway, for the years ranging from 1971 up to 2006. It is a linked administrative dataset that covers the population of Norway, and it is a collection of different administrative registers providing information about (among other things) month and year of birth, educational attainment, labour market status, earnings, a set of demographic variables (age, gender), as well as information on families including parent's marital status. We are able to link individuals to their parents, and it is possible to gather labour market information for both fathers and mothers.

For the bulk of our analysis we select all births in the period 1971-1980. In particular, we construct annual paternal taxable earnings data for each year, starting from the three years preceding the child's birth, through to their 20th birthday. This gives us information on income data and parental characteristics, mapped to children's outcomes, for 522,490 children.

The earnings values for both parents and children include wages and income from business activity, but also unemployment and sickness benefits. This means that our income measures include some degree of insurance against low income shocks through social insurance. Therefore, we expect the effect of the timing of this measure of total earnings to be lower than the effect of labour earnings alone (which we cannot measure).

We discount all incomes to the year of birth of the child, using a real interest rate of 4.26% (Aakvik, Salvanes, and Vaage (2005)). However, our results are robust to a large range of fixed discount rates between 0% and 10%, and to time-varying discount rates (matching the risk free interest rate evolution during the relevant years for our analysis). In order to construct a measure of income in each of the three periods we take the average of discounted annual paternal incomes within each period (0-5, 6-11, 12-17). Permanent income is then defined as the sum of income in the three periods.

We consider a large range of human capital outcomes. Our data includes years of education for each individual, an indicator for dropping out of high school at the age of 16, and college enrollment. The consequences of the early dropout is that individuals do not receive a certificate for vocational or academic achievement which severely limits opportunities in the labor market, and prohibits access to further education. Unfortunately, it is not possible to measure whether a college degree was



completed. Individuals are at least 26 years of age when we observe their educational achievement, and consequently, most of them can be expected to have exited school.

We also present results for other outcomes such as IQ, teenage pregnancy, health and grades at school. Military service is compulsory in Norway for males, and between the ages of 18 and 20 males usually take an IQ test. This test is a composite of arithmetic, words,<sup>4</sup> and a figures tests<sup>5</sup>, all of which are recognized as tests of IQ. We also use a health score taken from the military tests upon entry to the Army. This test is designed to ascertain physical capabilities of the males. It is measured on a 9 point scale, with the top score of 9 indicating health sufficient to allow military service. Around 85% of individuals have the top score. For a set of individuals born predominantly in 1986 (so a much later cohort than the ones we have considered so far), we observe grades achieved at the end of the 10th grade, when individuals are aged 16.<sup>6</sup> Unfortunately, grades in schools are not available for earlier cohorts. For teen pregnancy, we construct an indicator for whether an individual (female) has a child, when she was between the ages of 16 and 20.

Finally, we construct a set of control variables, which are important for the credibility of our empirical strategy. First, we construct household specific slopes of income profiles, by taking the difference between household income when the child is aged 18-20, and in the three years before birth.<sup>7</sup> Other controls include parental years of education, parental age at birth, marital status of parents, and family size. The two latter variables can be measured in each year of the child's life. We also observe the year of birth of the child as well as the municipality of residence in each year of the child's life.

The descriptive statistics for the sample are reported in Table 1. There are 522,490 child level observations, which include all individuals born in Norway between 1971 and 1980 for whom we were able to collect paternal income data, plus those born in 1986. The average permanent income of the father (in the period between the ages of 0 and 17 of the child) is about £306,100. There is substantial income dispersion (the standard deviation is £116,900). Income in each period (1, 2, and 3) falls with the age of the child because of discounting.

Mothers have on average 11.14 years of schooling, which is slightly lower than the average years of education of the fathers (11.45). Mothers are much younger than fathers at birth (26 vs 29 years of age).

The average years of education of the children in our sample is 12.73. 21% of children drop out from high school, but 39% attend college. The average annual earnings of these children at age 30 is £19,930.

Regarding additional child outcomes, IQ is only available for males, and takes values on a 9 point scale, with a sample average of 5.25, and a standard deviation of 1.79. The average health score for

---

<sup>4</sup>The word tests are most similar to the Wechsler Adult Intelligent Scale (WAIS).

<sup>5</sup>The figures tests are similar to the Raven Progressive matrix.

<sup>6</sup>See Hægeland, Raaum and Salvanes (2008) for full detail of grade data.

<sup>7</sup>A robustness check conditions instead for the growth rather than the level difference of pre- and post- childhood income.

the males is 8.44, indicating that the majority of children achieve perfect physical health on this scale (which has a maximum score of 9). Teen pregnancies occur for 8% of the females in our sample. Finally, the cohort of children for whom we have 10th grade exam information have an average score of 42.75 (out of 60).

The income process is studied in detail in Carneiro, Salvanes, and Tominey (2015). They find that, as in many other countries, the income process for Norwegian fathers can be fairly well approximated by the sum of a random walk (permanent shock) and a low order MA process (temporary shock).

## 3 Methods

### 3.1 Empirical Strategy

Let  $Y_i$  be an outcome for child  $i$  (education, high school completion, college attendance, earnings, IQ, health, teenage pregnancy, grades in high school), measured in late adolescence or young adulthood. We are interested in  $Y_i$  as a function of the history of (discounted) paternal income  $I_{it}$  in each period  $t$  ( $t = 1, 2, 3$ ), and permanent income of the parents,  $PI_i$ . Since  $PI_i = I_{i1} + I_{i2} + I_{i3}$  we drop one of the periods from the model, say  $I_{i1}$ . Therefore, we write:

$$Y_i = m(PI_i, I_{i2}, I_{i3}) + \varepsilon_i \quad (2)$$

We allow  $m(PI_i, I_{i2}, I_{i3})$  to be a non-parametric function of its arguments. It is important to be able to estimate a flexible function, and the reason is the following. Parents are faced with income shocks in each period and in response, decide how much to invest in children (and how much to consume and save). There is a technology that links the adult human capital of an individual to the whole history of parental investments in childhood and adolescence. The link between income shocks and child outcomes, described by equation (2), depends on many factors, including preferences, technology, information, and the structure of credit markets (insurance possibilities). Therefore, there are likely to be complex nonlinearities and interactions between the different income measures included in the model.

We are particularly interested in  $m_2(PI_i, I_{i2}, I_{i3}) = \frac{\partial m(PI_i, I_{i2}, I_{i3})}{\partial I_{i2}}$  and  $m_3(PI_i, I_{i2}, I_{i3}) = \frac{\partial m(PI_i, I_{i2}, I_{i3})}{\partial I_{i3}}$ .  $m_2(PI_i, I_{i2}, I_{i3})$  tells us what is the impact on outcome  $Y_i$  of shifting income from period 1 to period 2, since we keep  $PI_i$  and  $I_{i3}$  fixed (and  $PI_i = I_{i1} + I_{i2} + I_{i3}$ ). In our empirical section we present a series of graphs relating  $Y_i$  and  $I_{i2}$  (for different outcomes  $Y$ ). The graphs will vary depending on the values of  $PI_i$  and  $I_{i3}$  on which we evaluate this function. An analogous interpretation and graphical representations of results can be given to  $m_3(PI_i, I_{i2}, I_{i3})$ .

$\varepsilon_i$  should be interpreted as the unobserved heterogeneity that is left after controlling for permanent income in the model. We assume that  $\varepsilon_i$  has finite conditional variance,  $E(\varepsilon_i^2 | PI_i, I_{i2}, I_{i3}) \leq C < \infty$ , and that  $E(\varepsilon_i | PI_i, I_{i2}, I_{i3}) = 0$ . We are interested not in the impact of  $PI$  itself on  $Y$ , but on the

impact of the timing of income ( $I_2$  and  $I_3$ ) on  $Y$ , after conditioning on  $PI$ . In other words, we want to compare outcomes of children whose parents have the same level of permanent income between the ages of 0 and 17, but differ in the level of income they experience in each period.

The assumption that  $E(\varepsilon_i|PI_i, I_{i2}, I_{i3}) = 0$  may be controversial. We would like to interpret  $I_{i2}$  and  $I_{i3}$  as income shocks orthogonal to other (unobservable) determinants of outcomes  $Y_i$ , conditional on  $PI_i$ . It is likely that  $PI$  absorbs much of the relevant unobserved heterogeneity across parents (correlated with the overall level of their income), but one may still be concerned that parents facing different income profiles may be also different in other dimensions.

In order to address this issue we start by excluding maternal income from the model, and rely only on paternal income to construct  $(PI_i, I_{i2}, I_{i3})$ . Maternal income in each period could be very much related to decisions of staying at home caring for children instead of work, which is likely to affect child outcomes (e.g., maternity leave; see Carneiro, Loken and Salvanes, 2015). On the other end, paternal income is much less likely to be affected by these choices.

In addition, we condition on paternal education interacted with paternal age at birth (by including dummies for years of education and age at birth interacted with each other). This controls for different age-education profiles across fathers. Moreover, we construct a measure of paternal income growth between the ages of 0 and 17 of the child, based on income 1 to 3 years before birth (pre-birth income), and income 1 to 3 years after age 17 (post-17 income). This means that we explore fluctuations in income around deterministic age-income profiles which are allowed to vary with education, after accounting for heterogeneous income growth (and, of course, keeping fixed permanent income). The remaining controls in the model are maternal age at birth interacted with maternal education, birth year and gender of the child. Therefore, we extend equation (2) to include a large set of controls ( $Z$ ):

$$Y_i = m(PI_i, I_{i2}, I_{i3}) + Z_i\delta + \varepsilon_i \quad (3)$$

Section 5 provides a detailed discussion of all these concerns.

Our argument is that  $I_{i2}$  and  $I_{i3}$  are uncorrelated with  $\varepsilon_i$  after conditioning on  $PI_i$  and all the controls just mentioned. One implication of this argument is that pre-birth investments should be uncorrelated with the timing of income, but may still affect child outcomes. We test this by examining the relationship between having a low birth weight baby and the subsequent timing of parental income. We show below in section 5 that, although low birth weight is strongly correlated with  $PI_i$ , it is uncorrelated with  $I_{i2}$  and  $I_{i3}$ .<sup>8</sup>

---

<sup>8</sup>We will also present results where we control for marital break up and number of children. In addition, we calculate income residuals from a regression of income on age-education dummies and father fixed effects. We estimate the role of the timing of income residuals by including them in equation (3), instead of  $PI_i$ ,  $I_{i2}$  and  $I_{i3}$ . In section 5 we repeat several of these arguments, and provide a more detailed discussion of potential violations of the assumption that  $E(\varepsilon_i|PI_i, I_{i2}, I_{i3}Z_i) = 0$ .

### 3.2 Multivariate Local Linear Regression

Equation (3) is a partially linear regression model. We implement a two step method for estimating this model. In the first step we estimate  $\delta$  (the coefficients on  $Z$ ) by using a series approximation for  $m(PI_i, I_{i2}, I_{i3})$ .<sup>9</sup> In the second step we estimate a local linear regression of  $Y_i - Z_i\hat{\delta}$  (denoted  $\tilde{Y}_i$ ) on  $(PI_i, I_{i2}, I_{i3})$ .<sup>10</sup>

We follow Ruppert and Wand (1994) and Fan and Gijbels (1996) when specifying the multivariate local linear regression estimator. Let  $I_i = (PI_i, I_{i2}, I_{i3})$  be  $\mathbb{R}^3$ -valued explanatory variables. Our goal is to estimate the conditional mean function  $m(x) = E(\tilde{Y}|I = \mathbf{x})$  for a vector  $\mathbf{x}$ . The solution is the value which minimizes the weighted least squares objective function

$$\sum_{i=1}^n \left\{ \tilde{Y}_i - \gamma - (I_i - x)\beta \right\}^2 K_{\mathbf{H}}(I_i - \mathbf{x})$$

where  $\mathbf{H}$  is a 3 by 3 diagonal matrix of bandwidths (with  $h_1, h_2$  and  $h_3$  in the diagonals), and  $K_{\mathbf{H}}(I_i - \mathbf{x})$  is the product of three univariate uniform kernel functions,  $K_{\mathbf{H}}(I_i - \mathbf{x}) = K_1(s_{1i}) * K_1(s_{2i}) * K_3(s_{3i})$ , with:

$$K_j(s_{ji}) = \begin{cases} 0.5 & \text{if } |s_{ji}| \leq 1 \\ 0 & \text{otherwise} \end{cases}$$

where  $s_{1i} = \frac{PI_i - x_1}{h_1}$ ,  $s_{2i} = \frac{I_{i2} - x_2}{h_2}$ ,  $s_{3i} = \frac{I_{i3} - x_3}{h_3}$ ,  $h_j$  is the bandwidth, and  $j = \{1, 2, 3\}$ .

This results in the local least squares estimator of  $m(x)$ :

$$m(\hat{x}; H) = e^T (I_x^T W_x I_x)^{-1} I_x^T W_x \tilde{Y}$$

where  $e^T$  is the vector with 1 in the first entry and 0 in all others, and  $W_x = \text{diag}\{K_H(I_1 - x), \dots, K_H(I_n - x)\}$  is a weighting function which depends on the kernel.

The choice of kernel is not important for the asymptotic properties of the estimator as long as it is chosen to be a symmetric, unimodal density, such as the uniform kernel. However, there exists a trade-off in the choice of the number of observations entering the local kernel regressions, determined by the bandwidth for each variable,  $h_j$ . A larger bandwidth increases the bias of the estimate but reduces the variance. We expect that  $h_j \rightarrow 0$  as  $n \rightarrow \infty$ .

<sup>9</sup>In particular, we approximate  $m(PI_i, I_{i2}, I_{i3})$  as:

$$\begin{aligned} m(PI_i, I_{i2}, I_{i3}) = & \alpha_0 + \alpha_1 PI_i + \alpha_2 I_{i2} + \alpha_3 I_{i3} + \alpha_4 PI_i^2 + \alpha_5 I_{i2}^2 + \alpha_6 I_{i3}^2 \\ & + \alpha_7 PI_i^3 + \alpha_8 I_{i2}^3 + \alpha_9 I_{i3}^3 + \alpha_{10} PI_i I_{i2} + \alpha_{11} PI_i I_{i3} + \alpha_{12} I_{i2} I_{i3} \\ & + \alpha_{13} PI_i^2 I_{i2} + \alpha_{14} PI_i^2 I_{i3} + \alpha_{15} I_{i2}^2 I_{i3} + \dots \end{aligned}$$

(include all two-way and three-way interactions between  $(PI_i, I_{i2}, I_{i3}, PI_i^2, I_{i2}^2, I_{i3}^2, PI_i^3, I_{i2}^3, I_{i3}^3)$ ). Then we can estimate equation (3) by least squares.

<sup>10</sup>The standard Robinson (1989) method is computationally cumbersome in our setting because of the large size of our dataset.

We use the following formula to choose our bandwidth, for each covariate  $I_j$ :

$$h_j = C * 2 * \sigma_{x_j} h^{\frac{-1}{7}} \quad (4)$$

where  $C$  denotes a constant and  $\sigma_{x_j}$  the standard deviation of component  $j$  of vector  $I$ . We allow  $C$  to vary between 2 and 6, in order to examine the robustness of our results to the choice of bandwidth.

Finally, we calculate the standard errors using the formula from Ruppert and Wand (1994).

$$\widehat{var} \{ \hat{m}(x, \mathbf{H}) | I_1, \dots, I_n \} = \left\{ n^{-1} |\mathbf{H}|^{\frac{-1}{2}} R(K) / f(x) \right\} v(x)$$

where  $R(K) = \int K_H(s)^2 ds$ ,  $f(x)$  denotes the conditional density of  $\mathbf{x}$  and  $v(x) = Var(\tilde{Y} | I = \mathbf{x})$  denotes the conditional variance of the outcome.<sup>11</sup> We estimate the conditional density and variance in this equation as follows:

$$\widehat{f}(x) = \frac{1}{nh^d} \sum_{i=1}^n \frac{1}{h_1 h_2 h_3} K \left( \frac{PI_i - x_1}{h_1}, \frac{I_{i2} - x_2}{h_2}, \frac{I_{i3} - x_3}{h_3} \right)$$

$$\widehat{v}(x) = e^T (I_x^T W_x I_x)^{-1} I_x^T W_x \hat{\epsilon}^2$$

where  $\hat{\epsilon}^2 = \tilde{Y}_i - \widehat{m}(x)$ .

## 4 Results

### 4.1 Parametric Estimates

We first present basic patterns from parametric regressions which serve as a benchmark for our semi-parametric analysis. We start with a simple version of equation (2) where we ignore the timing of income, and consider only the relationship between an outcome of the child,  $Y$ , and the permanent income of the father,  $PI$ . This is comparable to what is commonly done in the literature on intergenerational mobility, which regresses the child outcome on a single measure of parental income.

Although it is usual to estimate linear models, here we allow for a more flexible specification. Instead of including  $PI$  linearly in the model, we construct indicator variables,  $q_{PI,i}^k$ , which take value 1 if the paternal permanent income of individual  $i$  is in percentile  $k$  of its distribution in the sample, with  $k = 1, \dots, 100$ :

$$Y_i = \sum_{k=1}^{100} \phi_{PI}^k q_{PI,i}^k + \varepsilon_i \quad (5)$$

The empirical results in this paper are presented through a series of graphs. We focus on years of education as the outcome of interest, and briefly mention some results for other outcomes. Figure

<sup>11</sup>In principle one would need a degrees of freedom adjustment to these formulas in order to account for the fact that we have use the sample to estimate the coefficients on the control variables ( $Z$ ). However, given the enormous sample size we are using, such adjustment would be irrelevant, and we ignore it in our calculations.

1 plots the relationship between measures of schooling attainment of the child and paternal income, constructed from estimates of equation (5). The relationship between years of schooling and  $PI$  is monotonically increasing (except for very high values of  $PI$ ) and concave. Doubling permanent paternal income from £200,000 to £400,000 (which roughly corresponds to moving from the very bottom of the distribution to the median)<sup>12</sup> roughly translates into one additional year of schooling for the child. High school dropout rates are declining with  $PI$  for values of  $PI$  below £400,000 (the 57th percentile of the distribution of  $PI$ ), and they are flat after that. College attendance rates increase substantially throughout the support of  $PI$ .<sup>13</sup>

We now introduce into the model income during two periods of childhood, defined by ages 6-11 and ages 12-17 (leaving out income occurring at ages 0-5, because of collinearity). Take a version of equation (3) where the function  $m(PI_i, I_{i2}, I_{i3})$  is additively separable in its three arguments:  $m(PI_i, I_{i2}, I_{i3}) = m^1(PI_i) + m^2(I_{i2}) + m^3(I_{i3})$ . We approximate  $m^1(PI_i)$  using dummies for each percentile of the distribution of  $PI$ , and we proceed analogously for  $m^2(I_{i2})$  and  $m^3(I_{i3})$ . In other words, we estimate the following model:

$$Y_i = \sum_{k_1=1}^{100} \phi_{PI}^{k_1} q_{PI,i}^{k_1} + \sum_{k_2=1}^{100} \phi_{I_2}^{k_2} q_{I_2,i}^{k_2} + \sum_{k_3=1}^{100} \phi_{I_3}^{k_3} q_{I_3,i}^{k_3} + Z_i \delta + \varepsilon_i \quad (6)$$

where  $q_{PI,i}^{k_1}$  is an indicator that takes the value 1 if the father of child  $i$  has permanent income in percentile  $k_1$  of the distribution of  $PI$  and 0 otherwise.  $q_{I_2,i}^{k_2}$  and  $q_{I_3,i}^{k_3}$  are defined analogously for the other two measures of income.

As before, our main focus is on the years of education of the child. Figure 2 has two panels, corresponding to plots of  $m^2(I_{i2})$  and  $m^3(I_{i3})$  (all other variables are evaluated at their means).

For the outcome years of schooling, both  $m^2(I_{i2})$  and  $m^3(I_{i3})$  have an inverse-U shape. This means that years of education are maximized when there is balance between paternal income across periods. It is not desirable (in terms of schooling attainment) to have all father's income concentrated in one period of childhood, regardless of whether it is ages 0-5, 6-11, or 12-17. Below we discuss why this might be the case. Our results are similar when we consider alternative measures of educational attainment: high school dropout or college attendance.

We can test and reject that  $m^2(I_{i2})$  ( $m^3(I_{i3})$ ) does not vary with  $I_{i2}$  ( $I_{i3}$ ). In particular, we test whether the coefficients  $\phi_{I_2}^{k_2}$  ( $\phi_{I_3}^{k_3}$ ) are all equal to each other, across different values of  $k_2$  ( $k_3$ ). We reject this hypothesis even when we drop from the test the coefficients  $\phi_{I_2}^{k_2}$  ( $\phi_{I_3}^{k_3}$ ) corresponding to the

<sup>12</sup>From the 4th to the 57th percentile to be precise.

<sup>13</sup>In Appendix Figure A1 we show several panels, plotting estimates of equation (5) for each of the remaining outcomes in the paper. Log earnings at age 30 and IQ rise steeply with  $PI$  for values of  $PI$  below £400,000, and much more slowly after that. The basic pattern is somewhat similar for teenage pregnancy. Estimates for the health index are erratic but roughly display an increasing relation with  $PI$ . Finally, high school grades are increasing in  $PI$ . All these panels display a positive correlation between  $PI$  and several outcomes, and the magnitudes of the relationships between these outcomes and  $PI$  are very substantial.

extremes of the support of  $I_{i2}$  ( $I_{i3}$ ).<sup>14</sup>

We now turn to our main results, generated from the semi-parametric estimation of  $m(PI_i, I_{i2}, I_{i3})$  (allowing the function to be non-separable in its arguments). We document that the main patterns of Figure 2 are robust to the estimation of a more flexible model.

## 4.2 Semi Parametric Estimates

In this section we present semi-parametric estimates of  $m(PI, I_2, I_3)$ , following the method described in section 3.2. In order to implement the estimator we first need to create a grid of evaluation points for  $m(PI, I_2, I_3)$ . We take 19 points for each income variable ( $PI, I_2, I_3$ ), corresponding to the ventiles of each variable's distribution. This gives us a tri-dimensional grid with 6,859 points ( $= 19 * 19 * 19$ ).

It is standard practice to trim the data so to avoid spurious results driven by small cells. Therefore, we drop 2% of the sample, corresponding to the cells with the smallest number of observations. In our main results we use a uniform kernel and choose the bandwidths using the formula in equation (4), setting  $C = 4$ . Below we show that our results are robust to the choice of different bandwidths.

One way to present our estimates of  $m(PI, I_2, I_3)$  is through a series of two dimensional graphs, where in the y-axis we represent the outcome of interest, and in the x-axis we represent one of the income variables in  $m(PI, I_2, I_3)$ . The advantage of this presentation is that the graphs are straightforward to read. The downside of this type of presentation is that it allows variation of only one income period at a time, which means that we need to fix the remaining two income variables at some pre-determined values (we fix the remaining control variables at their mean values). Therefore, we use multiple figures for each outcome, corresponding to different pre-determined values for the left-out income variables in each graph.

For each outcome, we present three sets of graphs. In the first set, we fix  $PI$  and  $I_3$  at three different values each (the third, fifth, and seventh deciles of the distribution of each variable), and vary only  $I_2$ , for a total of nine possible combinations. These are presented in nine different panels, which plot  $m(PI, I_2, I_3)$  against  $I_2$  (for given values of  $PI$  and  $I_3$ ). At the top of each panel we display the values at which we are fixing  $PI$  and  $I_3$ .

---

<sup>14</sup>In appendix Figure A2a and A2b we report results for the remaining non-schooling outcomes available in our data. There is no a consistent pattern across different outcomes, perhaps because they correspond to different skills. The IQ graphs display what seems to be an inverse-U shape, both for income at 6-11 and at 12-17, although they have a fairly long increasing section. When we look at log earnings at age 30 the shapes of the graphs are quite different. Child earnings are decreasing with income at ages 6-11, which says that shifting money away from the first period and towards the second period of childhood results in worse labor market outcomes for the child. Child earnings are roughly increasing in income at ages 12-17. With regard to teenage pregnancy, there is not much of a gradient with income at 6-11, and a pronounced and declining relationship with income at 12-17. This suggests that positive income shocks in the last period of childhood may be particularly important to prevent teenage pregnancy. In terms of self-reported adult health it also seems to be beneficial to shift income towards late childhood. Finally, when we examine grades in high school, it is useful to shift income from ages 6-11 to ages 0-5, indicating that the early years are important. But at the same time it is also important to shift income towards ages 12-17. Notice that, when analyzing grades in high school, we increased the size of the bins over which we evaluate  $(PI_i, I_{i2}, I_{i3})$  (we do this in Figures A1 and A2). This is because the sample size is so much smaller for this outcome than for the remaining ones.

Since  $PI = I_1 + I_2 + I_3$ , when  $PI$  and  $I_3$  are fixed at particular values, we cannot vary  $I_1$  and  $I_2$  independently. Therefore, by moving towards the right along the x-axis in each graph, we are able to see how the outcome varies as  $I_1$  increases and, simultaneously,  $I_2$  decreases (i.e., as income is “shifted” from period 1 to period 2). The support of  $I_2$  over which we can evaluate  $m(PI, I_2, I_3)$  is not the same across all panels because, for different combinations of  $PI$  and  $I_3$ , there are values of  $I_2$  for which there are no observations in the sample. The second set of panels keeps  $PI$  and  $I_2$  fixed, and lets  $I_3$  vary (a “shift” in income from period 1 to period 3). The third set of panels keeps  $PI$  and  $I_1$  fixed and varies  $I_3$  (a “shift” in income from period 2 to period 3).

Below each panel we display two other parameters,  $\alpha_1$  and  $\alpha_2$  (and respective standard errors), which are defined as follows. For each panel, let  $H$  be the highest grid point for the income variable being used in that panel, let  $L$  be the lowest grid point, and  $M$  be the median grid point (corresponding to the 50th percentile of the distribution of that income variable in that panel). Take the case where we fix  $PI = \overline{PI}$  and  $I_3 = \overline{I_3}$ , and we let  $I_2$  vary. Then define:

$$\begin{aligned}\alpha_1 &= m(\overline{PI}, M, \overline{I_3}) - m(\overline{PI}, L, \overline{I_3}) \\ \alpha_2 &= m(\overline{PI}, H, \overline{I_3}) - m(\overline{PI}, M, \overline{I_3}).\end{aligned}\tag{7}$$

$\alpha_1$  is the difference between the values the outcome takes in the median and lower extreme of the support of  $I_2$ , while  $\alpha_2$  is the difference between the values the outcome takes in the median and upper extreme of the support of  $I_2$ . If  $m(\overline{PI}, I_2, \overline{I_3})$  did not vary with  $I_2$  (in which case the timing of income would be irrelevant, at least when we compare first and second period incomes) we would expect  $\alpha_1 = \alpha_2 = 0$ , so these parameters help us quantify the importance of the timing of income.

#### 4.2.1 Years of Schooling

In Figures 3ai)-jiii) we represent the relationship between years of schooling of the child and  $(\overline{PI}, I_2, \overline{I_3})$ . We begin with Figures 3ai)-ciiii), showing how years of schooling change with  $I_2$ , relative to  $I_1$ . At the top of each panel we display the values at which we keep  $PI$  and  $I_3$  fixed, which are either the third, fifth or seventh deciles of the distributions of each of these variables.

Each panel shows two lines. The solid line (with the dashed standard errors) corresponds to  $m(\overline{PI}, I_2, \overline{I_3})$ , where  $\overline{PI}$  and  $\overline{I_3}$  are the conditioning values for  $PI$  and  $I_3$ . The scale of this line is given on the vertical axis located on the left side of the graph. The dotted line, which is declining in every panel, corresponds to the income in the left out period of childhood. In this case, it is equal to  $I_1 = \overline{PI} - \overline{I_3} - I_2$ . The scale of this line can be read on the vertical axis located on the right side of the graph.

It is remarkable that all of the figures in panels 3ai)-ciiii) display an inverse-U shape. Recall that this is the same pattern that we get from the estimation of the parametric model of equation (6), as shown in Figure 2. We compute  $\alpha_1$  and  $\alpha_2$  for each panel, and for all cases we reject the hypothesis that these parameters are equal to zero (i.e., we reject that these lines are flat).



What this means is that, across different values of  $PI$  and  $I_3$ , the years of schooling of the child are maximized when there is some balance between early and middle childhood income. If income is too concentrated in either early or middle childhood, then one can improve education outcomes of children by “shifting” income towards the other period. The (discounted annual) level of  $I_2$  at which the maximum is achieved is roughly between £8,000 and £12,000 (it increases with  $I_3$ ), which is generally above the median level of  $I_2$  for each graph.

These results have two important implications. First, the timing of income shocks is relevant for human capital formation. If the timing of income was irrelevant then all these graphs would be horizontal lines, with only permanent income being relevant for human capital outcomes. It is likely that the timing of income shocks affects the timing of investments in human capital (which in turn affects human capital formation). This will happen if parents have imperfect insurance possibilities against income shocks.

Second, if the timing of income matters because parental investments react to income shocks, the shape of the curves in panels 3ai)-ciiii) is consistent with an underlying technology of skill formation that exhibits complementarity in investments across periods. The reason is that, under complementarity, it is desirable to maintain a balanced flow of investments over the life of the child.

It is especially interesting that there is an upward sloping section in each curve. One could imagine that, for a given level of permanent income, it should not be worse to receive the bulk of one’s lifetime family income in the first period, instead of having it spread out over different periods of childhood. If permanent income is fully available at the beginning of childhood then one should be able to allocate it freely across periods just by saving the appropriate amount, regardless of whether or not one can borrow. However, this reasoning ignores uncertainty about income. When faced with income shocks, parents change their investments in children, unless they have perfect insurance. Savings alone do not generally provide perfect insurance.

We show below that, in a model with income uncertainty, it is possible to have an upward sloping section in these curves. But we also show that uncertainty about the parameters of the technology of skill formation (or about the ability of the child), combined with learning about these parameters, also leads to an upward sloping curve.

It is useful to compare the upward and downward slopes in the different panels of Figure 3, with the slope of the relationship between years of schooling and permanent income, shown in Figure 2. The slopes of the curves in Figures 3ai)-ciiii) are roughly half of those shown in Figure 2. For example, a £100,000 increase in permanent earnings leads to about an extra 0.5 years of education, while an increase in middle childhood’s income from £0 to £100,000 leads to about an extra 0.25 years of education. This means that, although the impact of the timing of income is smaller than that of permanent income, it is still quite substantial.

Figures 3di)-fiii) examine trade-offs between early and late childhood income (keeping fixed income in middle childhood and permanent income) and show a similar inverse-U shape, although it is less pronounced than in the previous figures. Some of the graphs display curves that are mainly

monotonically increasing such as, for example, Figure 3diii). In addition, while  $\alpha_1$  is usually positive and significantly different from zero,  $\alpha_2$  is often negative but not statistically different from zero, so schooling appears to be higher when income occurs in late rather than early childhood.

Figures 3gi)-jiii) examine trade-offs between income in middle and late childhood (keeping fixed income in early childhood and permanent income). Although most of these figures still display an inverse-U shape, there also cases where the most robust pattern in these figures is a declining one (indicating that schooling is higher when income occurs in middle rather than in late childhood). We come back to the economic interpretation of these patterns below, when we simulate different models of income shocks, parental investments and child outcomes.

#### 4.2.2 High School Drop Out and College Attendance

Instead of years of schooling, it is useful to consider high school dropout rates and college attendance rates separately, since they correspond to education decisions at the lower tail and at the upper tail of the education distribution. Perhaps not surprisingly, these results are quite similar to the ones we showed for years of education. Therefore, to save on space, we show only three figures per outcome, corresponding to fixing the omitted variables at their median values (which are analogous to Figures 3bii, 3eii, and 3hii). The full set of figures is shown in the appendix, in Figures A3 and A4.

High school dropout rates are minimized, and college attendance rates are maximized, when incomes are balanced between the early and middle childhood years (periods 1 and 2; see Figures 4a and 5a), keeping permanent income and income in late childhood (period 3) fixed. When we increase income in late childhood, educational outcomes appear to improve when this is done at the expense of early childhood income (Figures 4b and 5b), but it is less clear what happens when this is at the expense of middle childhood income (Figures 4c and 5c): while we still have a roughly U-shaped curve for high school dropout, in the case of college the relationship between the outcome and income in the third period of childhood is monotonically decreasing.

Again, we can clearly reject that these curves are flat, by computing both  $\alpha_1$  and  $\alpha_2$  for each panel. The magnitudes of these impacts are substantial. An increase in permanent income of £100,000 is associated with roughly a 10% decline in high school dropout rates and a 10% increase in college attendance rates. In comparison, a £100,000 shift in income from period 1 to period 2 leads roughly to a 4% decrease in high school dropout and a 6% increase in college attendance.

#### 4.2.3 Other Outcomes

We present a series of semi-parametric estimates for other outcomes in the Appendix. We start with log annual earnings at age 30, which is especially interesting because of its importance for intergenerational mobility literature, which usually focuses on the relationship between parental and child incomes. These are shown in Figure A5. Keeping  $PI$  and  $I_3$  fixed, shifting income away from period 1 and towards period 2 leads to a sharp reduction in log earnings, followed by a flattening

of the relationship. Shifting income toward the late childhood and away from early childhood years leads to increases in log earnings at age 30. These patterns are similar to the ones we documented for college education.

However, there is not much movement in earnings when we consider shifts in income from the middle to late period of childhood, which is not true for any of the education variables we considered. Any difference between these figures and the ones displayed above for education could be due to the existence of an unobserved dimension of human capital, which affects earnings, and which is influenced by parental investments.

The slopes of the estimated curves are remarkably steep. For low values of  $I_1$ , a £100,000 shift in income from  $I_1$  to  $I_2$  (keeping  $PI$  and  $I_3$  fixed) leads to a 5-15% decline in wages. A shift of £100,000 in  $I_1$  towards  $I_3$  generates gains in earnings close to 5%. These figures are very large, especially in light of the fact that a £100,000 increase in  $PI$  is associated with a 10% increase in log earnings at age 30.

Looking to IQ, and examining the trade-off between  $I_1$  and  $I_2$  (Figures A6ai)-ciiii), and  $I_1$  and  $I_3$  (Figures A6di)-fiii), the results suggest that it is beneficial to shift income away from early childhood, either towards the middle childhood or late childhood years, which is in contrast with the results we have had so far. However, when we study the trade-off  $I_2$  and  $I_3$  (Figures A6gi)-jiii), the results indicate that shifting income towards late childhood is associated with lower levels of IQ.

With regards to health, and in contrast to what we have seen so far, the curves are quite flat, or they do not show a clear pattern. We cannot reject that most curves in Figures A7ai)-ciiii), and in Figures A7di)-fiii), are flat lines. The results are less consistent across panels A7gi)-jiii). The estimates are also relatively more imprecise in this case than for the outcomes studied so far.

Figures A8ai)-jiii) show that teenage pregnancy is minimized when there is a balance between  $I_1$  and  $I_2$ , and when there is a shift in income from  $I_1$  to  $I_3$ , or, in some cases, from  $I_2$  and  $I_3$ . Nevertheless, because teenage pregnancy is only observed for females, and that it is a relatively infrequent phenomenon, these estimates are more imprecise than the ones presented above for other outcomes.

Unfortunately the nonparametric results for grades in school are too imprecise to be informative and they are available upon request. The parametric graphs corresponding to this outcome and shown in the last panels of Figure 2 are more precise. They show that grades decline as income is shifted from period 1 to period 2 of the child's life. And they increase when one shifts income from period 1 to period 3.

In sum, the patterns we document for schooling are often different from the patterns we document for other outcomes. The most likely explanation, as suggested above, is that there are multiple skills that are important for different adult outcomes, and which may be impacted by the timing of income in a different way. Additional research is needed to understand them in more detail. In this paper we focus on schooling, because of its importance in the human capital literature. One reason for not having an equally strong focus to earnings is that our observations of earnings are limited, and

restricted to fairly young workers (since we only consider children born in the decade between 1970 and 1980).

## 5 The Endogeneity of the Timing of Income Shocks

In our main empirical specification we cannot be certain that the error term is orthogonal to the timing of income, even after controlling for permanent income. Although we mentioned this problem above, below we discuss in detail two challenges to interpreting our estimates of the impact of the timing of income on the education of children as causal, which are related and driven by parental heterogeneity.

First, the timing of income could be a choice variable, potentially correlated with human capital investments. One obvious case is maternity leave: parents choose to take time off at the beginning of the child's life, presumably with the goal of improving the outcomes of the child (e.g., Carneiro, Løken, and Salvanes (2015)). More generally, there may be particular time periods when parents take time off to improve the life chances of children.

Second, there may be unobserved traits of individuals which are potentially correlated with human capital investments and with income profiles. Those parents who have their income frontloaded in the early years of the life of the child could be different from those who have their income backloaded. The question is: in which ways are they different?<sup>15</sup>

It is difficult to fully address endogeneity concerns without an external source of exogenous variation for the timing of income.<sup>16</sup> Therefore, we employ alternative empirical strategies to deal with this issue, and diagnose the degree to which it is important.

It is illuminating to begin by examining one particular child outcome: birth weight. One implication of our assumptions is that post-birth income fluctuations should not predict pre-birth investments, unless they are correlated with permanent traits of parents, which would have independent effects on all the outcomes we consider. Therefore, we examine the relationship between the timing of income and an indicator for low birth weight. Birth weight is strongly correlated with our permanent income measure.

We find that the timing of income fluctuations does not predict whether a child is low birth weight (even though permanent income is strongly correlated with low birth weight). Figures 6a-c present results from a semi-parametric regression of an indicator variable for low birthweight on  $(PI, I_2, I_3)$  and other controls. As above, we show only three figures, corresponding to fixing the omitted variables at their median values (which are analogous to Figures 3bii, 3eii, and 3hii). The full set of figures is shown in the appendix, in Figures A9. For almost all panels, it is not possible to reject that these lines

---

<sup>15</sup>Parental education affects the slope of income profiles and the outcomes of children, but this is a variable we will control for.

<sup>16</sup>One candidate would be local labor market shocks, but when we implemented the (control function) estimator the resulting estimates were very imprecise.

are flat (based on our estimates of  $\alpha_1$  and  $\alpha_2$ ), suggesting that the timing of income is uncorrelated with permanent unobserved parental quality, affecting both their choices about the timing of income, or affecting their income profiles.

Notice also that in all our previous estimates we use paternal income as our measure of income. We do this because father’s income is likely to be more stable than mother’s income, and less subject to changes in labor supply due to child-rearing activities. It is however possible that, for some fathers, labor supply choices are also affected by child-rearing activities. Therefore, Figures 7a-c) re-estimate equation (3) using only paternal income, but excluding income in years 0-2. These again focus on three panels and full results are displayed in appendix Figures A10ai-jiii). The effect of the timing of income is estimated now defining income in the three periods as 3-7, 8-12 and 13-17 with permanent income defined as the sum across these periods.

The results show that if anything, there is even a more pronounced curvature in the inverse u-shape relationship between the two variables. The main difference relative to our previous results occurs when we examine shifts in income from the early to the late childhood period. The curves display a much stronger inverse-U shape than before.

Additional family-specific unobserved preferences for child-rearing might be correlated with the timing of income. For example, parents can have certain preferences for the quality of child care or schools, and may choose to work more intensively in the early years to fulfill these preferences. Exploring only within family variation will allow us to account for all family specific heterogeneity, which is constant across siblings. We implement the within family estimator just by adding family indicators to our regressions, and relying on variation in the timing of income and outcomes across siblings. Figure A11 in the appendix plots within family parametric regressions and the general patterns, even though noisier, are inverse U-shape<sup>17</sup>

## 5.1 Heterogeneous Age-Earnings Profiles

To address the two main concerns listed above we adopt three additional strategies. First, it could be that paternal incomes are front-loaded or backloaded as a consequence of heterogeneous human capital. We already have a large set of controls for heterogeneous human capital, including *PI*. However, we further address this concern by estimating paternal income shocks in a first step, where we take the residuals of a regression of paternal income on a full set of age-education dummies, and a paternal fixed effect. This is especially useful if *PI* and the remaining father specific controls are not enough to account for time invariant unobservables for the father. In a second step, we re-estimate equation (3) using these residuals to compute our measure of income at each age, instead of the actual paternal income values.<sup>18</sup> The three panels in Figures 8a-c (and full results in Appendix A12ai-jiii))

<sup>17</sup>We only present the parametric estimates, because we do not have enough data to reliably estimate a semi-parametric model with family fixed-effects.

<sup>18</sup>Father fixed effects are not included in the second step model, unlike what was done to generate Figure A11, so this is not estimated using only within family variation. We use the father fixed effects solely in the first step construction

show a clear pattern of the inverse u-shaped curves which are significant in each figure.

Second, it could be that heterogeneous income profiles are driven by unobserved individual-specific life-time income trends. Our main specification controls for the income profile of fathers by calculating the difference between income post-childhood (using age 18-20) and pre-childhood (three years prior to birth). In Figures 9a-c,<sup>19</sup> we add to our specification the growth in income during the pre-birth years, and the growth in income in the post-childhood years. The results displayed are similar to the ones in our main specification.

Third, any remaining endogeneity in income profiles could be related to heterogeneity in the variance of income. Recall that our estimates show that balanced profiles of income are optimal to maximise child human capital. There is a possibility that could be partly driven by a model where parents with less volatile income profiles are “better” parents than those with fluctuating income profiles. We therefore include a measure of income variance as an additional control in the main semi-parametric regressions. In order to compute it we first run a regression of fathers’ income on dummy variables for education and age. For each individual, we then calculate the error term in each period, and calculate an individual specific variance of income (across periods). Again, as shown in Figures 10a-c (and Figures A14 in the Appendix) the resulting estimates are similar to those in the rest of the paper.

It is however true that, even if we can convincingly tackle the issues discussed here, we will not be able to rule out the possibility that we are capturing the effect of the timing of other shocks, which are correlated with the timing of income shocks (such as, for example, parental illness). In that case, we would have to interpret our estimates more broadly as giving us the impact of the timing of parental shocks, which could include income shocks, but also other shocks correlated with shocks to income.

## 5.2 Other Robustness Checks

In the appendix we present additional checks to the sensitivity of our estimates. First, as discussed in section 2, we have used a fixed discount rate to construct our measures of per period income and permanent income. In order to address concerns that the chosen discount rate is not appropriate for our panel, we re-estimate the model using different fixed rates (0%,2%,4%,6%,10%,15%), and we also re-estimate the model using time-varying discount rates using official real interest rates data for Norway between 1971 and 1998. In all the cases the main shapes of the figures we focus on are preserved, as shown in Figures A15.

Second, we check the robustness of the results to bandwidth choice, either by reducing (Figures A16ai-jiii) or increasing (Figures A17ai-jiii) the bandwidth. Using equation (4), the bandwidth used in our main results is defined by setting  $C$  equal to 4, so here we also set  $C = 2$  and then  $C = 6$ . Estimates using the smaller bandwidth are more noisy, as expected. But the general patterns of our

---

of income shocks.

<sup>19</sup>Again, for simplicity we display only three panels. The full set of panels are shown in Appendix Figures A13.

results remain essentially unchanged.

Third, we control additionally for marital status and the number of children in the household. These are likely to be correlated with the timing of family income and with child outcomes. However, they are also potentially endogenous to family income and therefore were excluded from the original specification. Figures A18ai-jiii) show similar patterns than those found when we include only exogenous controls, albeit the emergence of more pronounced inverse u-shaped curves when shifting income between period 2 and 3.

Fourth, in the main specification in the paper we take income from biological fathers, irrespective of marital break up and further family formation. However, this may not be the relevant measure of income if, for example, mothers re-marry, in which case income from the non-biological father could become the main income source. The sample in Figures A19ai)-jiii) selects only families which do not experience marital break-up. Again, the patterns are remarkably similar to those in our main specification.

To summarize, the conclusions of our paper are robust to a range of checks for our identification strategy and specification of the human capital equation. Where we do find deviations, it tends to be in the direction that the robustness checks find stronger evidence of inverse-U shaped relationships between the timing of parental income and the child's education.

## 6 Simple Models that Explain our Findings

Why and how does the timing of income drive human capital formation of children? In this section we attempt to address this question by simulating simple dynamic models of parental investments in children, which are able to produce an inverse-U relationship between the human capital of the child, and a shift in income from the first to the second, from the second to the third, and from the first to the third periods of childhood. At the same time, some of these models are also able to generate increasing relationships between years of schooling and a shifts in income from the first to the third period of childhood. Such models would be consistent with the main empirical findings of this paper regarding years of schooling, although they could also be used to interpret our results for other outcomes.

For example, one could think that the downward sloping section of the relationship between years of schooling and  $I_2$  (after controlling for  $PI$  and  $I_3$ ) is driven by credit constraints. If the technology of skill formation exhibits complementarity in investments across periods, and if credit constrained parents cannot borrow funds from the future, then the level of investments during the early childhood could be sub-optimal. In that case, one could increase it with a shift in income towards early childhood, leading to an increase in human capital.

It is also interesting that there is an upward sloping section in each curve. One would think that, for a given level of permanent income, it should not be worse to have all income available in the first period, than to receive it in payments spread out over different periods of childhood. This is

because, if permanent income becomes fully available at time zero, then one can allocate it freely across periods just by saving the appropriate amount, regardless of whether or not one can borrow.

However, the reasoning just described ignores the possibility that parents face multiple sources of uncertainty when they make investment decisions. One of them is income uncertainty. When faced with income shocks, parents change their investments in children, unless they have perfect insurance. Savings alone cannot provide perfect insurance. Another one is uncertainty about the ability of the child or about the technology of skill formation. If parents are not sure about the ability of the child, parents may want to postpone investment until more of this uncertainty is revealed (see Altonji, Hayashi, and Kotlikoff (1997)).

We discuss these ideas in detail in this section, where we simulate different models of parental investments in children, and examine their implications for the impact of the timing of income shocks on human capital formation.<sup>20</sup>

## 6.1 The Basic Model

### 6.1.1 Preferences

We assume that there is a single parent and a single child, and parents have the following instantaneous preferences for consumption:

$$u(c_t) = \frac{c_t^{1-\sigma}}{1-\sigma} \quad (8)$$

where  $c_t$  is per-period parent consumption and  $\sigma$  the degree of relative risk aversion.

Asset accumulation is described by the standard budget constraint

$$a_{t+1} = (1+r)a_t + i_t - px_t - c_t \quad (9)$$

where  $a_t$  is the current stock of assets in  $t$ , and  $i_t$  is income in  $t$ ,  $p$  is the relative price between investment and consumption (assumed to be constant over time), and  $x_t$  denotes investment in children in period  $t$ .

We add heterogeneity to the model to match the support of child's schooling attainment and per-period parental incomes found in the data. We include three equally sized groups of individuals,

---

<sup>20</sup>We could further enrich our model with additional realistic features. For example, another issue we should consider is time as a parental investment. Time and good investments can be complementary or substitutable, and the elasticity of substitution between these two types of investment may change with age. Investments in periods 1 and 2 of the child's life could be complements, but the aggregate of the two could be substitutable with investments in the last period of the child's life. Furthermore, there may be issues related to preferences. For example, the parent's objective function may include other arguments beyond child's schooling, so depending on how the marginal rate of substitution between parental consumption and investments in children changes with the child's age, delayed parental income could lead to higher investments in children. We have accounted for these factors in other simulations, not presented in the paper, but the goal here is only to present the simplest set of models that could explain our empirical findings, and tell us about the main economic forces behind them.



defining their income profiles as increasing, decreasing, and flat. The income process is given by:

$$i_{kt} = w_{min} + w_k \exp(\varepsilon_t) \quad (10)$$

where  $k$  denotes type,  $\varepsilon_t$  is an iid income shock, the type-specific wage slope on this shock is  $w_k$ , and  $w_{min}$  is a minimum level of income.

### 6.1.2 The technology of skill formation

We consider a CES production function, where human capital at age  $t + 1$ ,  $y_{t+1}$ , is a function of the current human capital stock,  $y_t$ , and investment in children,  $x_t$ :

$$y_{t+1} = \delta \left[ \gamma_t y_t^\phi + (1 - \gamma_t) x_t^\phi \right]^{\frac{\rho}{\phi}} \quad (11)$$

Under this specification,  $\gamma_t$  is the self-productivity of human capital (see Cunha, Heckman, and Schennach (2010)),  $\rho$  denotes the degree of concavity of the production function and  $\phi$  measures the degree of complementarity of investments across periods ( $1/1 - \phi$  is the elasticity of substitution). Finally,  $\delta$  is a scaling parameter that maps skills to observed human capital measures (such as years of schooling).

Each individual is born with an initial endowment of human capital,  $y_{0,k}$ , which varies with type.

### 6.1.3 The household problem

At the beginning of each period, parents know their assets, the current income shocks, and the child's level of skill (this assumption will be relaxed later). They then decide on the optimal level of consumption and investments in children, after forming expectations about the future. Parents cannot perfectly predict future income shocks, but they know their distribution. Parents also face a budget constraint, the technology of skill formation (which is assumed to be known for now), borrowing constraints, and (for simplicity) they are unable to leave financial bequests to their children. The recursive formulation of the parental problem is the following:

$$V_t(y_t, a_t, \varepsilon_t) = \text{Max}_{c_t, x_t} \left\{ \frac{c_t^{1-\sigma}}{1-\sigma} + \beta \int_{\varepsilon_{t+1}} [V_{t+1}(y', a', \varepsilon') | \Omega_t] d\varepsilon \right\} \quad (12)$$

*s.to.*

$$\begin{aligned} c_t + px_t + a_{t+1} &= i_t + (1+r)a_t \\ i_{t,k} &= w_{min} + w_k e^{\varepsilon_t} \\ y_{t+1} &= \delta \left[ \gamma_t y_t^\phi + (1-\gamma_t) x_t^\phi \right]^{\rho/\phi} \\ c_t, x_t, a_T &\geq 0 \\ a_t &\geq -a \\ V_T(y_T, a_T, \varepsilon_T) &= \eta \frac{(y_T)^{1-\sigma}}{1-\sigma} + \varphi [(1 - \exp(-a_T))] \end{aligned}$$

where  $V_T(y_T, a_T, \varepsilon_T)$  is the terminal value function, and represents the parental valuation of the skills acquired by children when they become adults ( $\eta$ ) and assets ( $\varphi$ ).

This simple model can be solved computationally. For our simulations, we fix parameters for preferences, the terminal value function, and the budget constraint to a set of arbitrary values (loosely informed by the available literature on similar models), and we then estimate the technology parameters to fit the data relating income fluctuations and the timing of income.<sup>21</sup> We simulate results incorporating different assumptions about borrowing constraints (below we show the results for the assumption that  $a = 0$ ). The parameters for which we fix values, and their description, is shown in Table 2.

## 6.2 Solution and Estimation

The model is solved numerically. Standard quadrature methods are used to integrate the value functions over the known distribution of income shocks. Obtaining values for the expected value function ( $EV_{t+1}$ ) also involves the approximation of this function at states lying outside the grid of assets and human capital, since they evolve continuously, and are governed by the dynamics of the budget constraint and the technology of skill formation.  $EV_{t+1}$  is approximated by using Cheyshev Polynomials, which allow us to evaluate the optimal investment and savings decisions in each state of the world, and in each particular period.<sup>22</sup> The resulting policy functions ( $x(y_t, a_t, \varepsilon_t)$  and  $a'(y_t, a_t, \varepsilon_t)$ ), are then used to simulate data from 100,000 random draws of income shocks, which

<sup>21</sup>It is not possible to estimate all parameters of the model. The model is not identified. Therefore we have proceeded by taking standard values for some parameters from the literature, and estimated the remaining ones. Notice that the goal of this section is to search for possible models that could be used to explain the main empirical patterns uncovered in this paper, as opposed to uncovering the unique model that justifies what we see in the data. Therefore, for our purpose, we believe that our procedure is adequate.

<sup>22</sup>More details of the approximation procedure are shown in Appendix 1.

are useful to build a large simulated dataset of incomes and human capital.

The estimation procedure adopted is Simulated Method of Moments (Gourieroux et al (2005), McFadden (1989)). The method consists in computing a set of moments with both actual and simulated data, and finding the structural parameters that minimize the sum of the quadratic distances between them. Denote the set of data moments by  $\alpha$ , and the set of simulated (which depend on the structural parameters) by  $\alpha^s(\theta)$ . The structural parameters  $\theta = \{\phi, \gamma_t, \delta\}$  are found by solving the following minimization problem:

$$\text{Min}_{\theta}(\alpha - \alpha^s(\theta))W(\alpha - \alpha^s(\theta))$$

where  $W$  is a weighting matrix. The set of moments chosen for estimation includes the mean value of years of schooling at percentiles 10, 25, 50, 75 and 90 of each per-period income. We use as a weighting matrix the diagonal of the optimal weighting matrix, which is computed using the standard errors of the income percentiles from the data:

$$W = \text{diag}(VCV(\alpha)^{-1})$$

where  $VCV(\alpha)$  is the Variance-covariance matrix of the set of data moments to be matched by the simulations.

Finally, using this set of estimated (and calibrated) parameters, we simulate per-period incomes, permanent income, and optimal human capital. We then use local linear regressions to estimate the relationship between human capital and income in different ages using simulated data, which are useful to construct two-dimensional graphs analogous to those shown in section 4.2. This allows us to check whether we can reproduce the main patterns shown in the figures in section 4.2 using simulated data from the models described in this section.

### 6.3 Simulations with income uncertainty

Our estimates of the parameters of the technology of skill formation are shown in Table 3, for a basic model where parents only face income shocks. Self-productivity parameters  $\gamma_t$  are roughly between 0.45 and 0.6 across periods, suggesting that the current stock of human capital is roughly as important as investments in children. The production function is concave since  $\rho < 1$ , and there is evidence of dynamic complementarity because i) the estimated elasticity of substitution is  $1/(1 - \phi) = 1.7$ ; and ii) at the optimum, cross derivatives  $\frac{\delta^2 y_{t+1}}{\delta x_i \delta x_j}$  are always larger than zero (indicating dynamic complementarity), for all combinations of periods  $i$  and  $j$ .

Using data simulated from our model, we analyze the relationship between human capital and the timing of income shocks, by constructing two-dimensional graphs analogous to those in section 4.2. These are shown in Figures 11. There are only three panels. In 11a we fix  $PI$  and  $I_3$  at their median values, and examine the relationship between  $Y$  and  $I_2$ . In panel 11b we fix  $PI$  and  $I_2$  at

their median values, and examine the relationship between  $Y$  and  $I_3$ . In panel 11c we fix  $PI$  and  $I_1$  at their median values, and examine the relationship between  $Y$  and  $I_3$ . The full set of figures is shown in the appendix, in Figures A20. Across all panels (in the text and in the appendix) the shape of the figures is an inverse-U, which means that, in the model, schooling is maximized when income is balanced across periods.

Our model allows us not only to describe the relationship between human capital and the timing of income, but also how we can understand this relationship by studying the impact of the timing of income on consumption, savings, and investments in children. In particular, we can ask how movements in these variables can potentially account for the inverse-U patterns of Figure 3.

If parents are credit constrained and they face income uncertainty, optimal investments react to income shocks. This is shown in Figures 12 and 13, where we show how investments in children and savings change with the timing of income. Again we consider only three panels for investments in children, and three panels for savings, where we evaluate the omitted income variables at their median values.

Panel 12a indicates that, as income shifts away from early to middle childhood (0-5 to 6-11), early investments ( $x_1$ ) decrease, investments in middle childhood ( $x_2$ ) increase, and investments in adolescence ( $x_3$ ) are unresponsive. Panel 12b indicates a similar behavior of investments when income is shifted from early childhood to adolescence (where middle-childhood income remains constant). In that case, early childhood investments ( $x_1$ ) decrease, while investments in adolescence ( $x_3$ ) sharply increase. Investments in middle childhood ( $x_2$ ) are fairly unresponsive in this simulation. Finally, panel 12c shows that when income is shifted from middle childhood to adolescence, investments in middle childhood and adolescence are also responsive in the expected direction, while investments in early childhood do not change once again.

Given the simple monotonic relationships between current income and investments in children (and savings), the inverse-U patterns of Figure 3 could be partly due to dynamic complementarity in the production function. The mechanism would be as speculated above: income shocks induce changes in investments in children, but an unbalanced path of child investments produces less human capital than a balanced path of investments, because of dynamic complementarity.

In Table 4, we check the robustness of our estimates of technology parameters to different choices of values for the remaining parameters of the model. In all cases the estimated elasticities of substitution of investments across different periods suggest that there is dynamic complementarity.

## 6.4 Uncertainty about Child Ability, or about the Parameters of the Technology

There is a growing literature documenting the importance of parental subjective expectations, for example regarding the parameters of the production function of skill, for parental investments (e.g.,

Cunha, Elo, and Culhane (2013)).<sup>23</sup> We now show that if we incorporate uncertainty about the technology into our model and allow parents to learn about the technology as children age, the human capital of children may increase as we shift income to later ages even with dynamic complementarity in the production function and in the presence of borrowing constraints. This could help explain some of the patterns shown in section 4.2.

We consider a slight change in the technology of skill formation, by adding technology shocks of the form;

$$y_{t+1} = \delta \left[ \gamma_t y_t^\phi + (1 - \gamma_t) x_t^\phi \right]^{\frac{\rho}{\phi}} + \tau + \nu_t \quad (13)$$

where  $\tau$  takes only two possible values and is fixed over time, and  $\nu_t \sim N(0, \sigma_{\nu t}^2)$ . This implies that we introduce a new dimension of heterogeneity in the model,  $\tau$ , which can only take a high and a low value and which is not observed by the parents. Assuming that parents know the remaining parameters of the production function, they observe  $\tau + \nu_t$  at the end of each period and then use this information in the following period's decision. We postulate a very simplistic (non-bayesian) learning model where the parent's best guess for  $\tau$  is their observation of  $\tau + \nu_t$  in the previous period. Parents do however know the value of  $\sigma_{\nu t}^2$  each period. We assume that  $\sigma_{\nu t}^2$  decreases over time, in order to keep the simplicity of the learning process and still capture the possibility that parents have a better idea of  $\tau$  at later ages than at earlier ages.

In contrast to income shocks presented in the basic model, technology shocks  $\nu_t$  are not part of the state space. This means that, when parents decide consumption and investments, they are not certain about the human capital of their children. However, parents do have a belief about  $\tau$ ,  $\hat{\tau}$ , which is equal to zero for everyone in period 0, and equal to  $y_t - \delta \left[ \gamma_{t-1} y_{t-1}^\phi + (1 - \gamma_{t-1}) x_{t-1}^\phi \right]^{\frac{\rho}{\phi}}$  in the remaining periods.  $\hat{\tau}$  is an additional state variable in the model. Parents know however that  $\hat{\tau}$  is a measure of  $\tau$  contaminated with measurement error, which has variance  $\sigma_{\nu t}^2$ .<sup>24</sup>

These ideas are captured by the following recursive specification:

$$V_t(y_t, a_t, \varepsilon_t, \hat{\tau}) = \text{Max}_{c_t, x_t} E_{\nu_t} \left\{ \frac{c_t^{1-\sigma}}{1-\sigma} + \beta E_{\varepsilon_{t+1}} [V_{t+1}(y', a', \varepsilon', \hat{\tau}') | h_t, a_t, \varepsilon_t] | a_t, \varepsilon_t \right\}$$

Under this formulation, technology shocks can also be interpreted as uncertainty about the child's ability,  $\tau$ . In this case parents do not know their child's ability before deciding consumption and investments, which is captured by the new expectation operator over technology shocks. Their knowledge of the world at the end of period  $t$  is limited to their assets, the current income shock, and last period's estimate of  $\tau$ , forming probabilistic distributions of child's human capital.

Figure 14 has three panels where we depict the relationship between human capital and income in a given period using simulated data from this model, keeping permanent income and income in

<sup>23</sup>Empirical literature on the relationship between knowledge and expectations about the state of the world and actual behavior includes Aizer and Stroud (2010), Glied and Lleras-Muney (2008), and Roy (2009).

<sup>24</sup>We realize this is a very naive and unsophisticated way of modelling beliefs and learning. The reason we do it is because it leads to models which are very easy to compute, and at the same time, are able to illustrate the main points we are making.

one other period fixed at their median values, just as we did before. In appendix Figure A21 we display the full set of figures for these simulations. Across panels, human capital increases as income is shifted to future periods of life of the child. In this model, parents seem to delay investments to a period where they face less uncertainty about the ability of the child (or about the technology).

## 7 Conclusion

This paper examines the importance of the timing of income shocks for the human capital development of children. Using a very large dataset, consisting of the entire population of children born in Norway between 1971 and 1980, we estimate semi-parametric regressions of human capital outcomes of children (measured in their adult years), on the average discounted father's income for the years when the child was between 0 and 17 years of age (which we label permanent income), and on income in different periods.

We find that the education of the child is maximized when fathers experience a stable and balanced flow of income across the first 17 years of life of the child. This is observed in fairly simple, additively separable, two variable regression models, as well as in much more complex and flexible semi-parametric models. However, this pattern is not consistent across different outcomes, which may indicate the importance of considering explicitly multiple skills in our models of the labor market.

We simulate simple models of parental investments in children which are able to explain our findings. These models are not the only ones consistent with our data, but they build very naturally on much of the central literature on this topic (e.g., Becker and Tomes (1986), Cunha, Heckman, and Schennach (2010)). In addition, they have enough richness to enable them to predict our empirical results fairly well.

Our simulations show a simple model of parental investments in children, where parents invest in different periods of development of the child, while they face income shocks and imperfect credit markets. The production function of skill is a CES function, where investments in children in different time periods are complementary inputs.

In this model, investments in children react to income shocks but there is only imperfect insurance against shocks. Since investments in children are complements over time, education is maximized when there is a balanced flow of investments. Since investments react to income shocks, a pattern of stable income leads to a pattern of stable investments. This is consistent with our finding that human capital of children is maximized when parents face a balanced flow of income.

We also consider models which add uncertainty and learning about either the child's ability, or the technology of skill formation, albeit in a very simplistic way. Such models are able to account for an increasing relationship between human capital of the child, and a shift in income away from the early years and towards the late adolescent years of the child.

## References

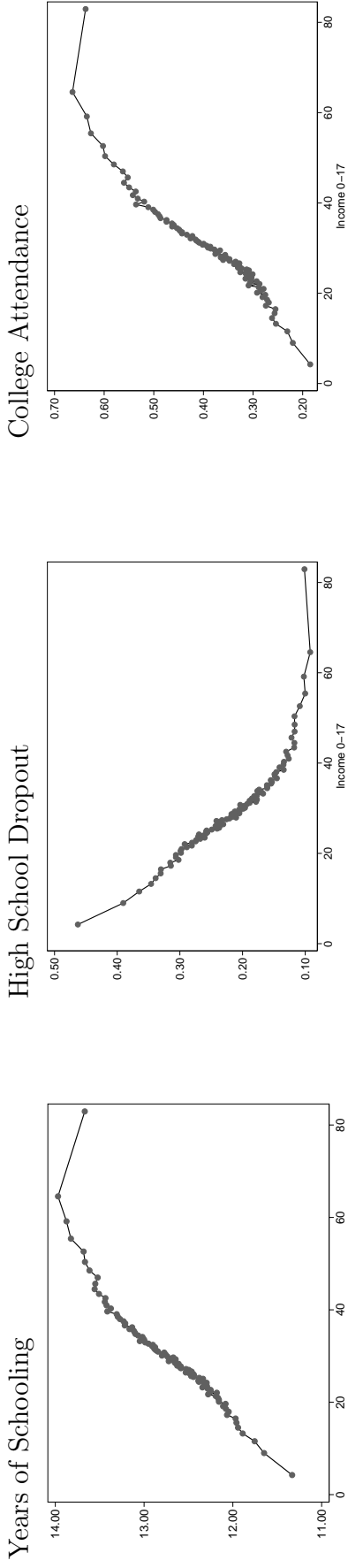
- AAKVIK, A., K. G. SALVANES, AND K. VAAGE (2005): “Educational Attainment and Family Background,” *German Economic Review*, 6(3), 377–394.
- AIZER, A., AND L. STROUD (2010): “Education, knowledge and the evolution of disparities in health,” Discussion paper, National Bureau of Economic Research.
- ALTONJI, J. G., F. HAYASHI, AND L. J. KOTLIKOFF (1997): “Parental Altruism and Inter Vivos Transfers : Theory and Evidence,” *Journal of Political Economy*, 105(6), 1121–1166.
- BECKER, G. S., AND N. TOMES (1979): “Becker-Tomes\_(JPoLE\_79).pdf,” *Journal of Political Economy*, 87(6).
- (1986): “Human capital and the rise and fall of families.,” *Journal of labor economics*, 4(3 Pt. 2), 1–47.
- BJÖRKLUND, A., AND K. G. SALVANES (2011): “Education and Family Background: Mechanisms and Policies,” in *Hanushek, Eric, Stephen Machin and Ludger Woessmann, Handbook in Economics of Education, 201-247, North-Holland.*, 3(11).
- BLACK, S. E., AND P. J. DEVEREUX (2011): “Recent Developments in Intergenerational Mobility,” in *Handbook of Labor Economics, Volume 4B*, 4(11), 1487–1541.
- BLUNDELL, B. R., L. PISTAFERRI, AND I. PRESTON (2008): “Consumption Inequality and Partial Insurance,” *American Economic Review*, 0214491(1998), 1887–1921.
- CARNEIRO, P., AND J. J. HECKMAN (2003): “Human Capital Policy,” in *Heckman, J. J. and Krueger, A. Inequality in America: What Role for Human Capital Policies, MIT Press.*, (2000).
- CARNEIRO, P., K. V. LØKEN, AND K. G. SALVANES (2015): “A Flying Start? Maternity Leave Benefits and Long-Run Outcomes of Children,” *Journal of Political Economy*, 123(2), 365–412.
- CARNEIRO, P., K. SALVANES, AND E. TOMINEY (2015): “Family Income Shocks and Adolescent Human Capital,” *Unpublished Manuscript*.
- CAUCUTT, E., AND L. LOCHNER (2012): “Early and late human capital investments, borrowing constraints, and the family,” *NBER Working Paper Series*.
- CUNHA, F. (2013): “Investments in children when markets are incomplete,” *Rev. Econ. Stud.*
- CUNHA, F., I. ELO, AND J. CULHANE (2013): “Eliciting maternal expectations about the technology of cognitive skill formation,” Discussion paper, National Bureau of Economic Research.

- CUNHA, F., AND J. HECKMAN (2007): “The Technology of Skill Formation,” *American Economic Review*, 97(2), 31–47.
- CUNHA, F., J. HECKMAN, AND S. SCHENNACH (2010): “Estimating the Technology of Cognitive and Noncognitive Skill Formation.,” *Econometrica*, 78(3), 883–931.
- DUNCAN, G. J., W. J. YEUNG, J. BROOKS-GUNN, AND J. R. SMITH (1998): “HOW MUCH DOES CHILDHOOD POVERTY AFFECT THE LIFE CHANCES OF CHILDREN ?,” *American Sociological Review*, 63(3), 406–423.
- FAN, J., AND I. GIJBELS (1996): *Local polynomial modelling and its applications: monographs on statistics and applied probability 66*, vol. 66. CRC Press.
- GLIED, S., AND A. LLERAS-MUNEY (2008): “Technological innovation and inequality in health,” *Demography*, 45(3), 741–761.
- HUMLUM, M. K. (2011): “Timing of Family Income , Borrowing Constraints and Child Achievement,” *Journal of Population Economics*, 24(3), 979–1004.
- JENKINS, S. P., AND C. SCHLUTER (2002): “The Effect of Family Income During Childhood on Later-Life Attainment : Evidence from Germany,” *IZA Discussion Paper Series*, (604).
- LEVY, D. M., AND G. DUNCAN (2000): “Using sibling samples to assess the effect of childhood family income on completed schooling,” Discussion paper, Northwestern University/University of Chicago Joint Center for Poverty Research.
- ROY, D. (2009): “New horizons in the study of child language acquisition,” .
- RUPPERT, D., AND M. P. WAND (1994): “Multivariate locally weighted least squares regression,” *The annals of statistics*, pp. 1346–1370.
- SOLON, G. (1999): “Intergenerational Mobility in the Labor Market,” *In Handbook of Labor Economics, Volume 3. O. Ashenfelter and D. Card, editors.*, 3, pp.1761–1800.



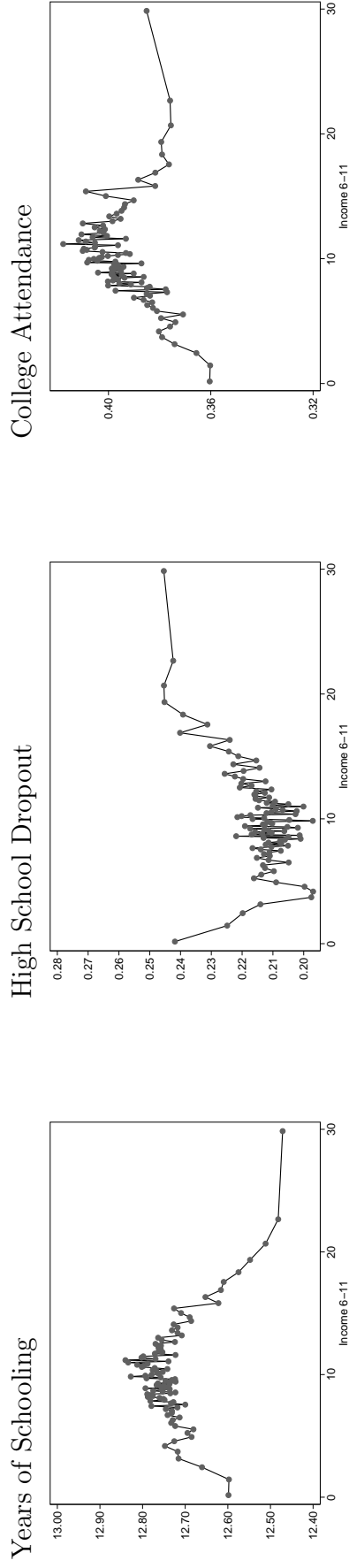
## 8 Figures and Tables

Figure 1: Parametric Estimates. Paternal Income 0-17 and Years of Schooling.



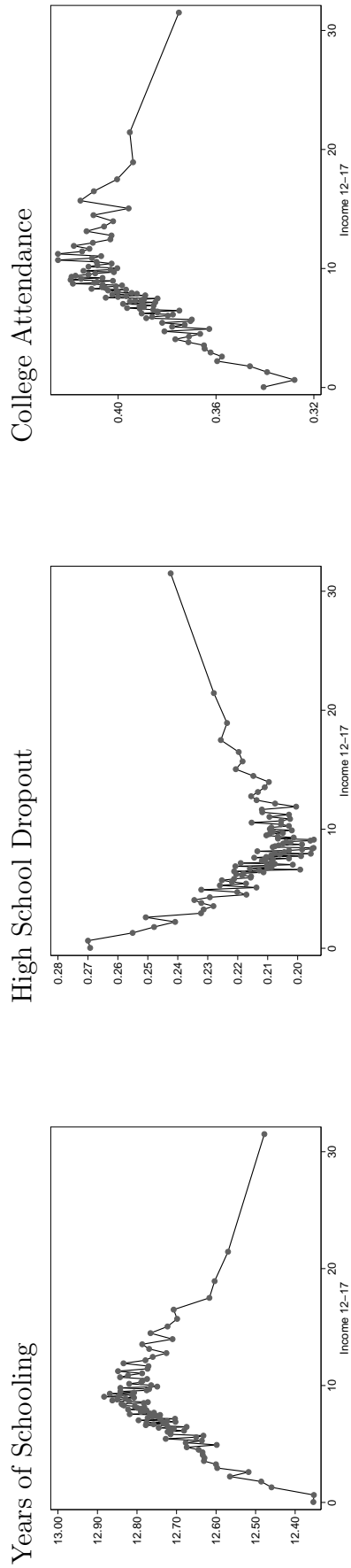
Graphs plot individual coefficients from regression of decile bins for PI upon child human capital. Income in 2000 prices, £ 10,000s.

Figure 2a: Parametric Estimates. Paternal Income 6-11 and Years of Schooling.



Graphs plot individual coefficients from regression of decile bins for I2, I3, PI upon child human capital controlling for heterogeneous income profile, dummy variables for paternal education interacted with paternal age, dummy variables for maternal education interacted with maternal age, gender and child year of birth dummies. Income in 2000 prices, £ 10,000s.

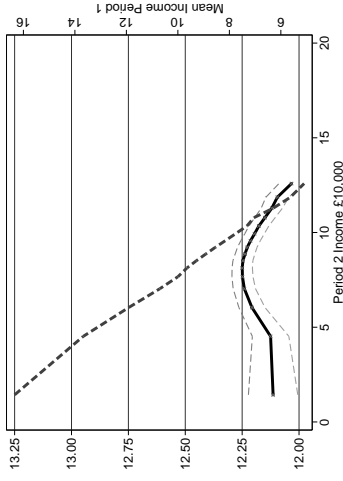
Figure 2b: Parametric Estimates. Paternal Income 12-17 and Years of Schooling.



Graphs plot individual coefficients from regression of decile bins for I2, I3, PI upon child human capital controlling for heterogeneous income profile, dummy variables for paternal education interacted with paternal age, dummy variables for maternal education interacted with maternal age, gender and child year of birth dummies. Income in 2000 prices, £ 10,000s.

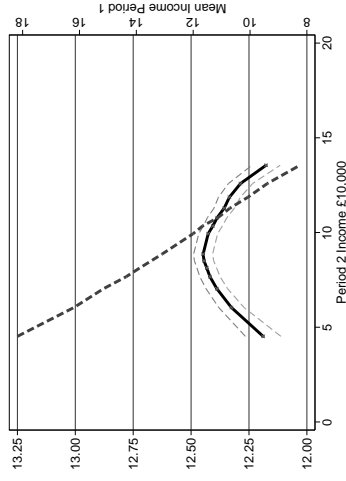
Figure 3: Semi-parametric Estimates. Dependent Variable is Years of Schooling. Fix Paternal Income 12-17.

ai) I3=6.34, PI=24.18



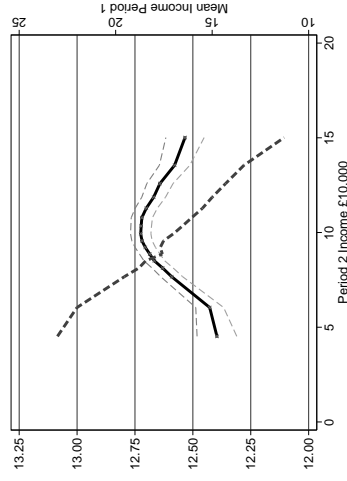
$$\alpha_1 = 0.12 (0.06) \alpha_2 = -0.20 (0.04)$$

bi) I3=6.34, PI=28.24

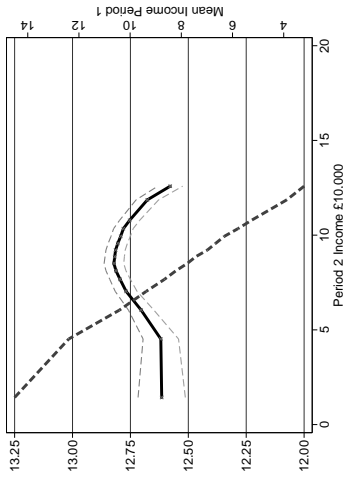


$$\alpha_1 = 0.26 (0.04) \alpha_2 = -0.27 (0.04)$$

ci) I3=6.34, PI=32.93

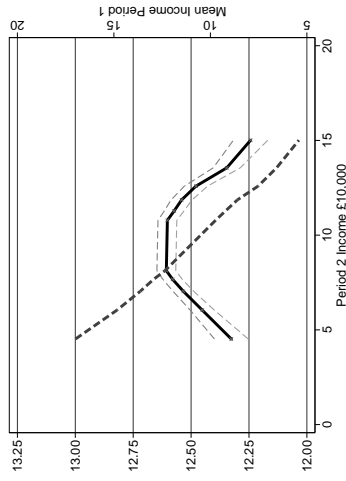


aii) I3=7.49, PI=24.18



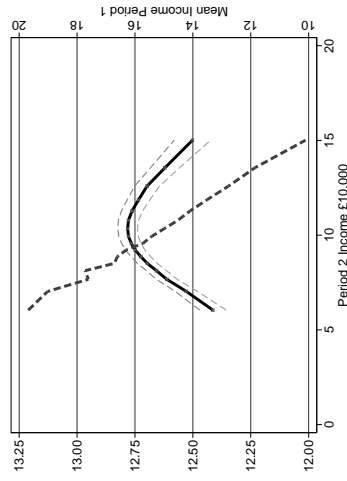
$$\alpha_1 = 0.20 (0.06) \alpha_2 = -0.24 (0.03)$$

bii) I3=7.49, PI=28.24

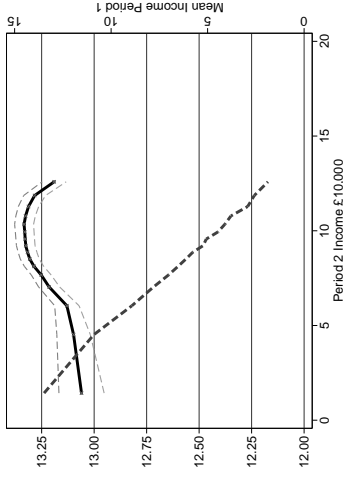


$$\alpha_1 = 0.31 (0.04) \alpha_2 = -0.40 (0.04)$$

cii) I3=7.49, PI=32.93

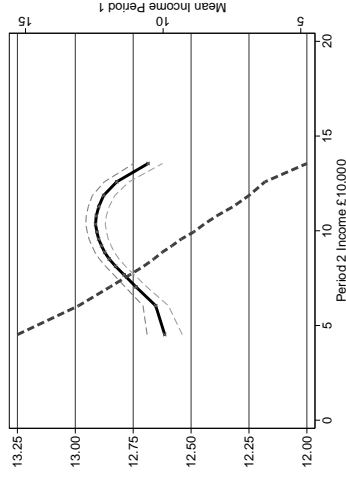


aiii) I3=9.32, PI=24.18



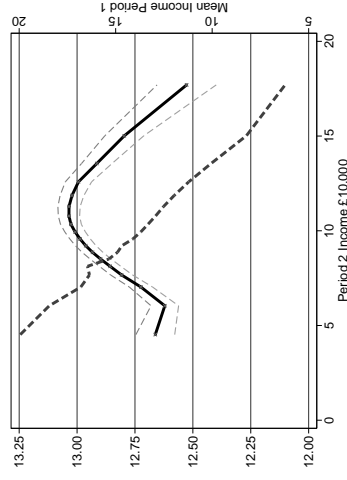
$$\alpha_1 = 0.26 (0.06) \alpha_2 = -0.13 (0.04)$$

biii) I3=9.32, PI=28.24



$$\alpha_1 = 0.24 (0.06) \alpha_2 = -0.20 (0.04)$$

ciii) I3=9.32, PI=32.93



$$\alpha_1 = 0.32 (0.05) \alpha_2 = -0.19 (0.05)$$

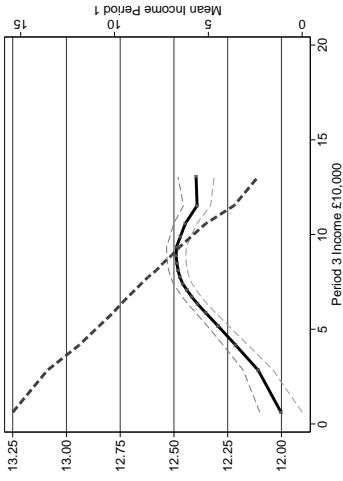
$$\alpha_1 = 0.35 (0.04) \alpha_2 = -0.26 (0.05)$$

$$\alpha_1 = 0.32 (0.05) \alpha_2 = -0.46 (0.07)$$

Note: 95% confidence intervals shown. Income in 2000 prices, £ 10,000s. Semi-parametric estimates control for paternal education interacted with age and maternal education interacted with age, paternal income profile, gender and child year of birth.

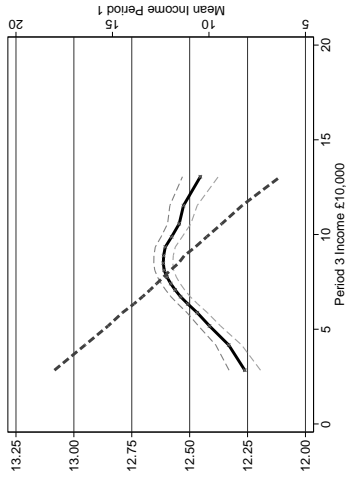
Figure 3: Semi-parametric Estimates. Dependent Variable is Years of Schooling. Fix Paternal Income 6-11.

di) I2=8.13, PI=24.18



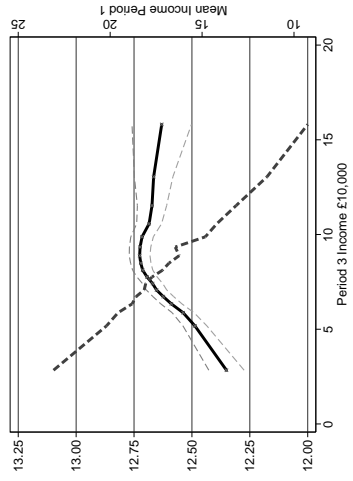
$\alpha_1 = 0.47$  (0.05)  $\alpha_2 = -0.35$  (0.07)

ei) I2=8.13, PI=28.24

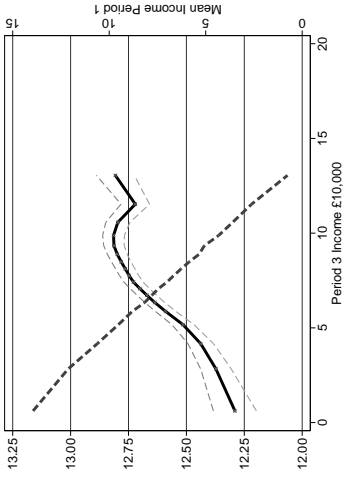


$\alpha_1 = 0.34$  (0.04)  $\alpha_2 = -0.14$  (0.04)

fi) I2=8.13, PI=32.93

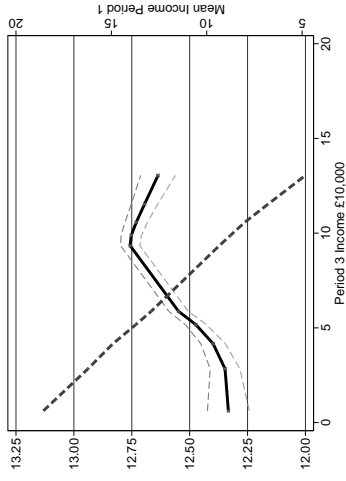


dii) I2=9.56, PI=24.18



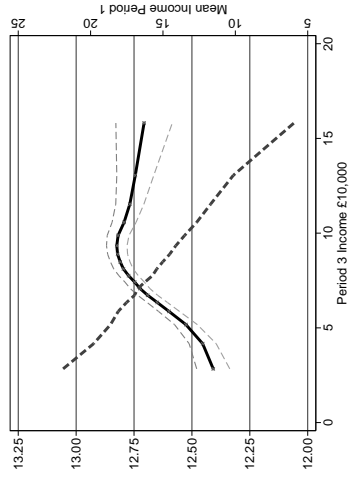
$\alpha_1 = 0.44$  (0.05)  $\alpha_2 = 0.08$  (0.05)

eii) I2=9.56, PI=28.24

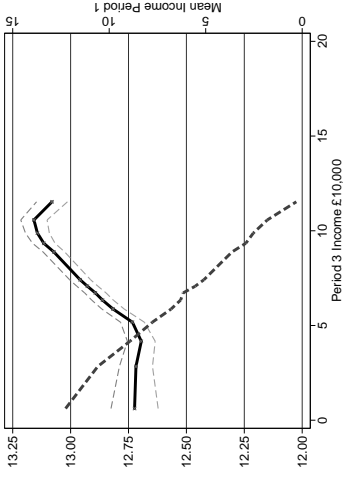


$\alpha_1 = 0.36$  (0.05)  $\alpha_2 = -0.05$  (0.04)

fii) I2=9.56, PI=32.93

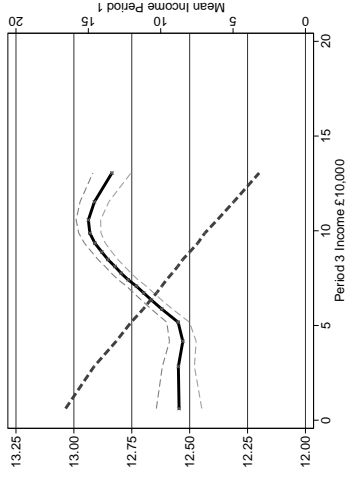


diii) I2=11.26, PI=24.18



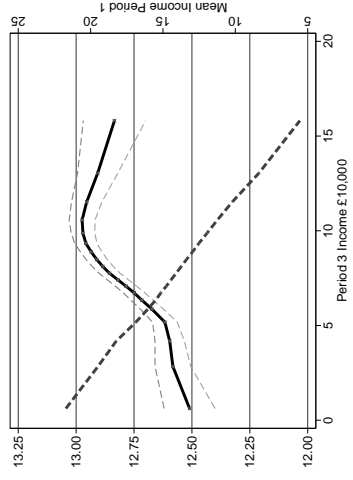
$\alpha_1 = 0.17$  (0.06)  $\alpha_2 = 0.19$  (0.04)

eiii) I2=11.26, PI=28.24



$\alpha_1 = 0.22$  (0.05)  $\alpha_2 = 0.07$  (0.05)

fiii) I2=11.26, PI=32.93



$\alpha_1 = 0.18$  (0.06)  $\alpha_2 = -0.06$  (0.07)

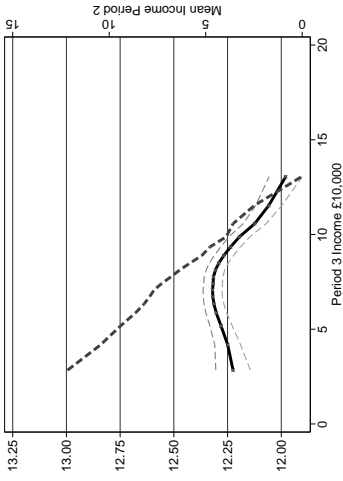
$\alpha_1 = 0.37$  (0.04)  $\alpha_2 = -0.07$  (0.07)

$\alpha_1 = 0.35$  (0.06)  $\alpha_2 = -0.02$  (0.07)

Note: 95% confidence intervals shown. Income in 2000 prices, £ 10,000s. Semi-parametric estimates control for dummies for paternal education interacted with age and maternal education interacted with age, paternal income profile, gender and child year of birth.

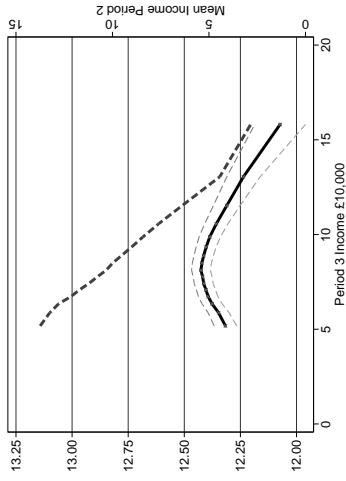
Figure 3: Semi-parametric Estimates. Dependent Variable is Years of Schooling. Fix Paternal Income 0-5.

gi) I1=10.91, PI=24.18



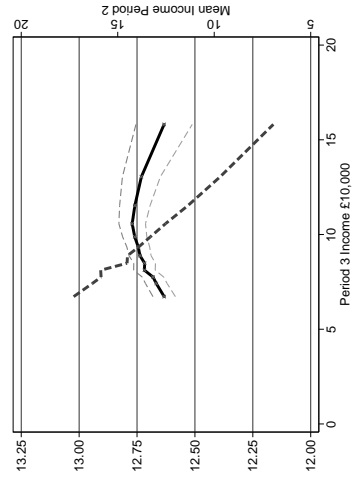
$\alpha_1 = 0.09$  (0.05)  $\alpha_2 = -0.26$  (0.04)

hi) I1=10.91, PI=28.24

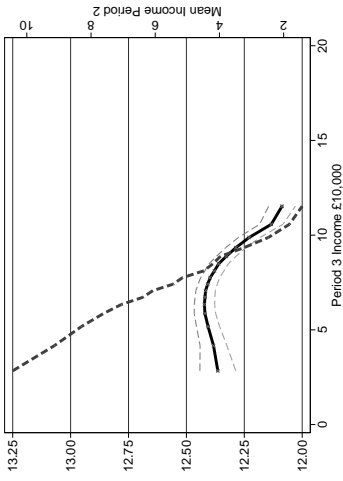


$\alpha_1 = 0.11$  (0.03)  $\alpha_2 = -0.19$  (0.04)

ji) I1=10.91, PI=32.93

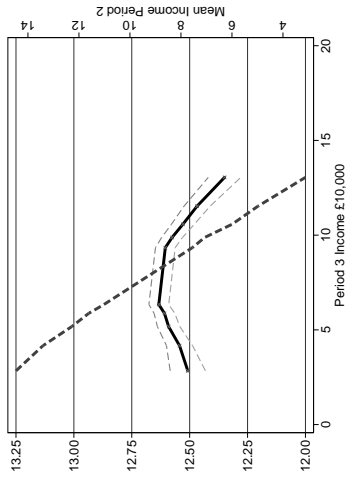


gii) I1=13.02, PI=24.18



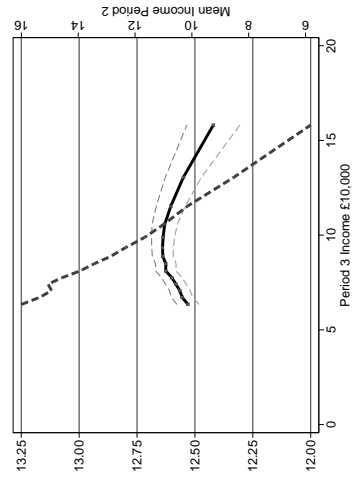
$\alpha_1 = 0.04$  (0.04)  $\alpha_2 = -0.27$  (0.03)

hii) I1=13.02, PI=28.24

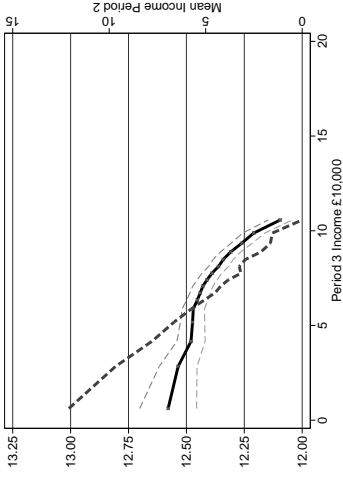


$\alpha_1 = 0.14$  (0.04)  $\alpha_2 = -0.30$  (0.04)

jii) I1=13.02, PI=32.93

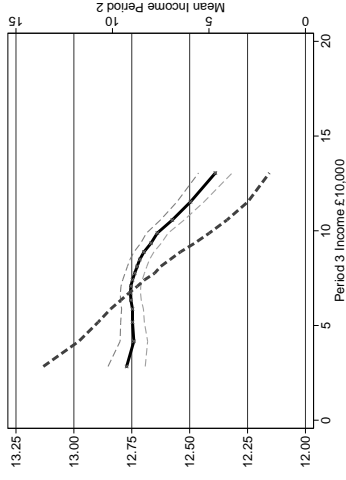


giii) I1=15.64, PI=24.18



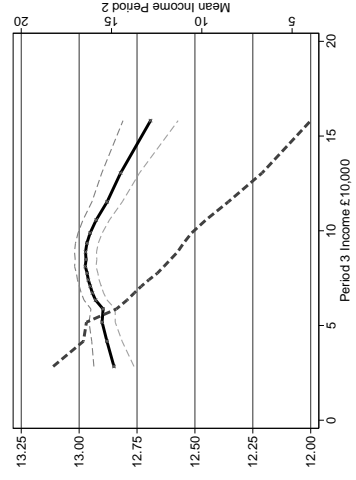
$\alpha_1 = -0.15$  (0.07)  $\alpha_2 = -0.22$  (0.03)

hiii) I1=15.64, PI=28.24



$\alpha_1 = -0.03$  (0.05)  $\alpha_2 = -0.35$  (0.04)

jiii) I1=15.64, PI=32.93



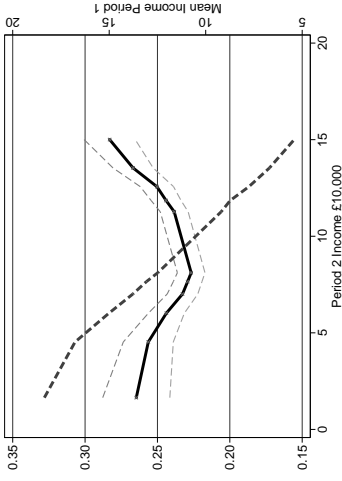
$\alpha_1 = 0.10$  (0.03)  $\alpha_2 = -0.21$  (0.06)

$\alpha_1 = 0.12$  (0.05)  $\alpha_2 = -0.27$  (0.07)

Note: 95% confidence intervals shown. Income in 2000 prices, £ 10,000s. Semi-parametric estimates control for dummies for paternal education interacted with age and maternal education interacted with age, paternal income profile, gender and child year of birth.

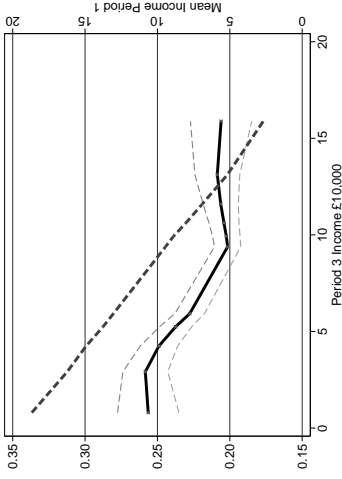
Figure 4: Semi-parametric Estimates. Dependent Variable is High School Dropout.

a) I3=7.49, PI=28.24



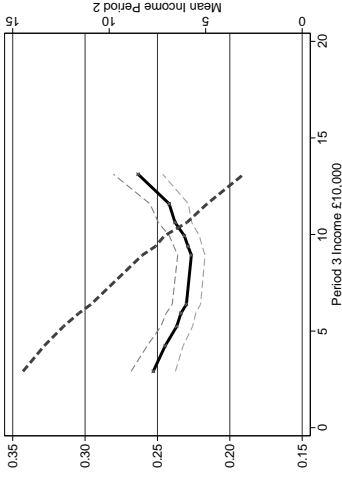
$$\alpha_1 = -0.03 (0.01) \quad \alpha_2 = 0.06 (0.01)$$

b) I2=9.56, PI=28.24



$$\alpha_1 = -0.05 (0.01) \quad \alpha_2 = -0.00 (0.01)$$

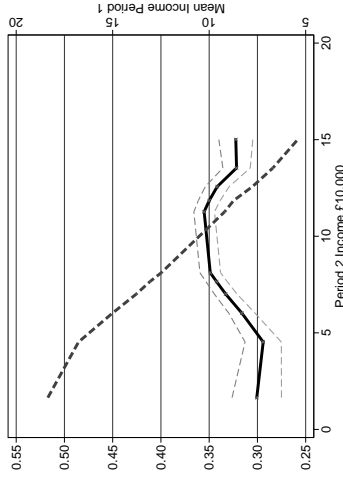
c) I1=13.02, PI=28.24



$$\alpha_1 = -0.03 (0.01) \quad \alpha_2 = 0.04 (0.01)$$

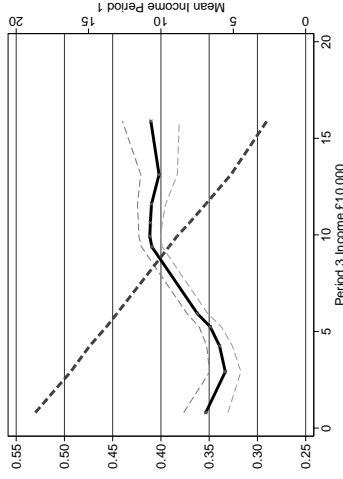
Figure 5: Semi-parametric Estimates. Dependent Variable is College.

a) I3=7.49, PI=28.24



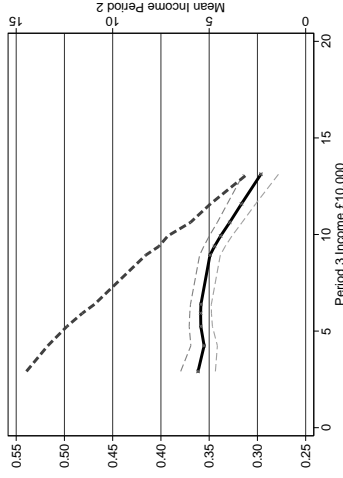
$$\alpha_1 = 0.07 (0.01) \quad \alpha_2 = -0.04 (0.01)$$

b) I2=9.56, PI=28.24



$$\alpha_1 = 0.04 (0.01) \quad \alpha_2 = 0.02 (0.01)$$

c) I1=13.02, PI=28.24

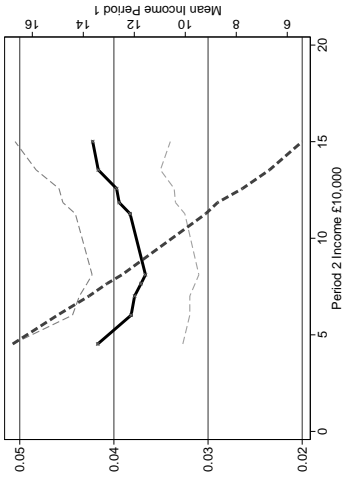


$$\alpha_1 = 0.00 (0.01) \quad \alpha_2 = -0.06 (0.01)$$

Note: 95% confidence intervals shown. Income in 2000 prices, £ 10,000s. Semi-parametric estimates control for dummies for paternal education interacted with age and maternal education interacted with age, paternal income profile, gender and child year of birth.

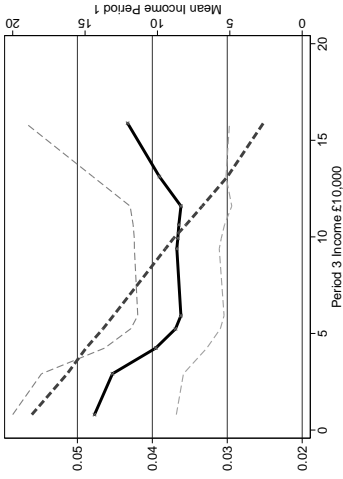
Figure 6: Semi-parametric Estimates. Dependent Variable is Low-birth Weight.

a) I3=7.49, PI=28.24



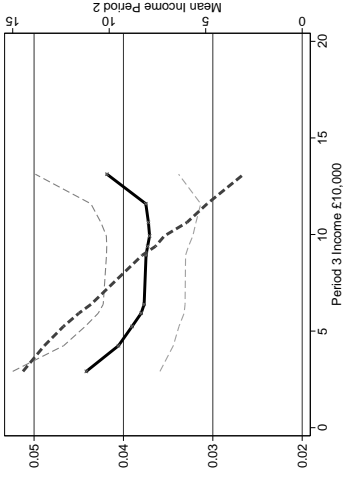
$\alpha_1 = -0.00$  (0.00)  $\alpha_2 = 0.01$  (0.00)

b) I2=9.56, PI=28.24



$\alpha_1 = -0.01$  (0.00)  $\alpha_2 = -0.00$  (0.00)

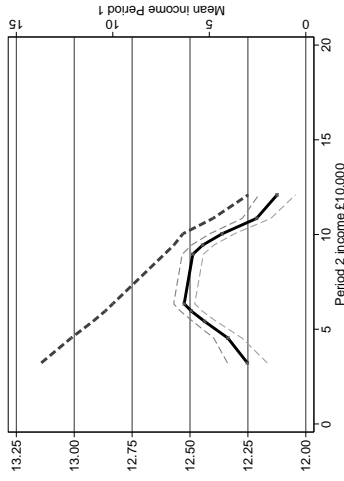
c) I1=13.02, PI=28.24



$\alpha_1 = -0.01$  (0.00)  $\alpha_2 = 0.00$  (0.00)

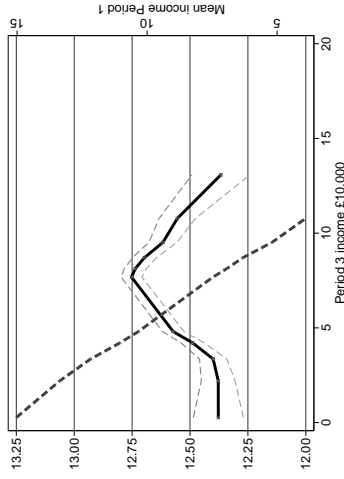
Figure 7: Exclude Early Years (0-2). Dependent Variable is Years of Schooling.

a) I3=7.49, PI=28.24



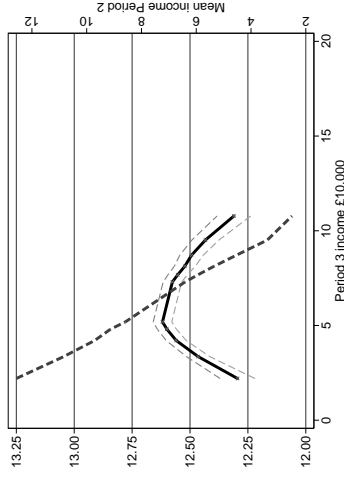
$\alpha_1 = 0.31$  (0.05)  $\alpha_2 = -0.44$  (0.05)

b) I2=9.56, PI=28.24



$\alpha_1 = 0.35$  (0.06)  $\alpha_2 = -0.36$  (0.07)

c) I1=13.02, PI=28.24

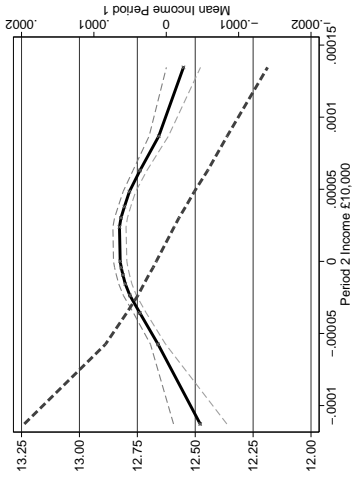


$\alpha_1 = 0.32$  (0.04)  $\alpha_2 = -0.31$  (0.04)

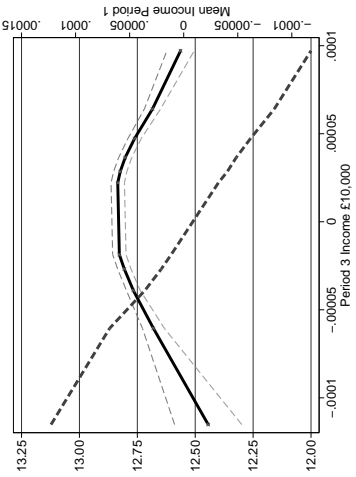
Note: 95% confidence intervals shown. Income in 2000 prices, £ 10,000s. Semi-parametric estimates control for dummies for paternal education interacted with age and maternal education interacted with age, paternal income profile, gender and child year of birth. Period 1 is 3-7, period 2 is 8-12, period 3 is 13-17.

Figure 8: Residualize Paternal Income Before Constructing Income Profiles. Dependent Variable is Years of Schooling.

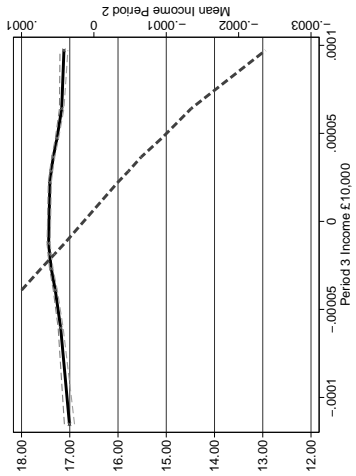
a) I3=7.49, PI=28.24



b) I2=9.56, PI=28.24



c) I1=13.02, PI=28.24



$$\alpha_1 = 0.32 (0.00) \quad \alpha_2 = -0.17 (0.00)$$

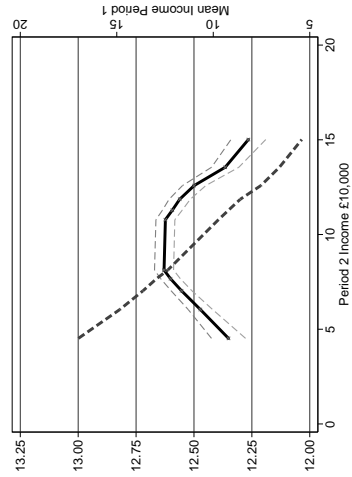
$$\alpha_1 = 0.40 (0.00) \quad \alpha_2 = -0.28 (0.00)$$

$$\alpha_1 = 0.14 (0.00) \quad \alpha_2 = -0.32 (0.00)$$

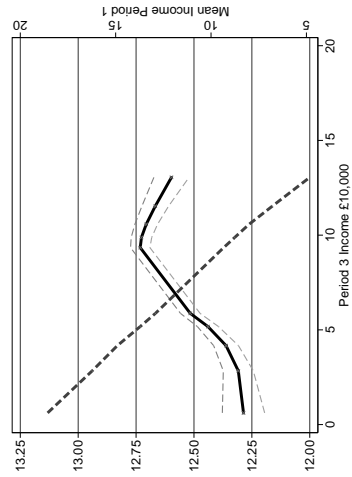
Note: 95% confidence intervals shown. Income in 2000 prices, £ 10,000s. Semi-parametric estimates control for dummies for paternal fixed effect, paternal education interacted with age and maternal education interacted with age, paternal income profile, gender and child year of birth.

Figure 9: Control for Pre-Birth and Post-17 Paternal Income Growth. Dependent Variable is Years of Schooling.

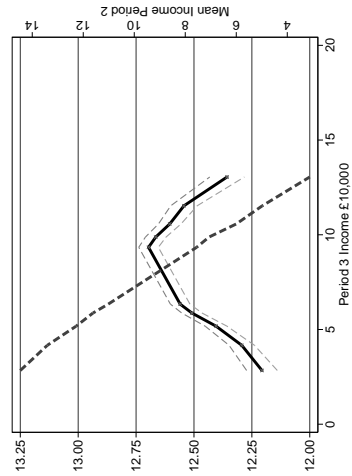
a) I3=7.49, PI=28.24



b) I2=9.56, PI=28.24



c) I1=13.02, PI=28.24



$$\alpha_1 = 0.31 (0.04) \quad \alpha_2 = -0.40 (0.04)$$

$$\alpha_1 = 0.37 (0.05) \quad \alpha_2 = -0.06 (0.04)$$

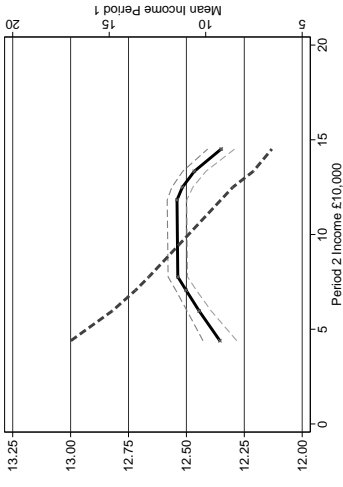
$$0.47 (0.04) \quad \alpha_2 = -0.32 (0.04)$$

Note: 95% confidence intervals shown. Income in 2000 prices, £ 10,000s. Semi-parametric estimates control for dummies for paternal education interacted with age and maternal education interacted with age, paternal income profile growth, gender and child year of birth.

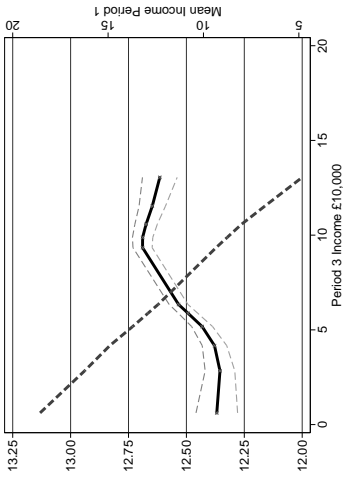


Figure 10: Control for Individual Income Volatility. Dependent Variable is Years of Schooling.

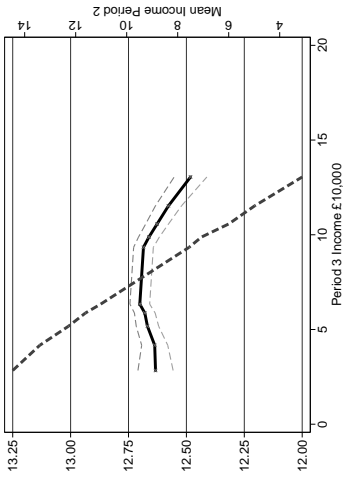
a) I3=7.49, PI=28.24



b) I2=9.56, PI=28.24



c) I1=13.02, PI=28.24



$$\alpha_1 = 0.24 (0.04) \quad \alpha_2 = -0.30 (0.04)$$

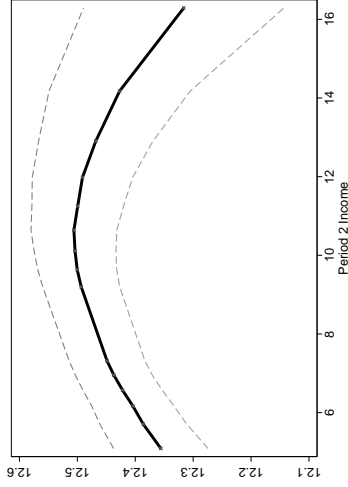
$$\alpha_1 = 0.24 (0.05) \quad \alpha_2 = 0.00 (0.04)$$

$$\alpha_1 = 0.08 (0.04) \quad \alpha_2 = -0.23 (0.04)$$

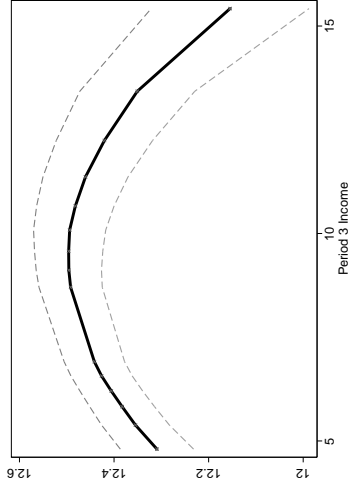
Note: 95% confidence intervals shown. Income in 2000 prices, £ 10,000s. Semi-parametric estimates control for dummies for paternal education interacted with age and maternal education interacted with age, paternal income profile, gender and child year of birth, variance of income.

Figure 11: Simulated Years of Schooling. Basic Model with Income Uncertainty.

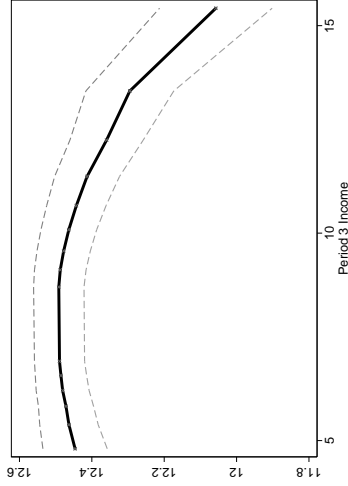
a) I3=decile 5; PI=decile 5



b) I2=decile 5; PI=decile 5



c) I1=decile 5; PI=decile 5



Note: Income in 2000 prices, £ 10,000s. Period 1, 2, 3 refer to ages 0-5, 6-11 and 12-17. Simulated data based on 100,000 draws of income shocks per period. Estimated technology parameters and years of schooling obtained by simulated method of moments, matching percentiles 10, 25, 50, 75 and 90 of each per-period income.

Figure 12: Simulated per-period Investments. Basic Model with Income Uncertainty.

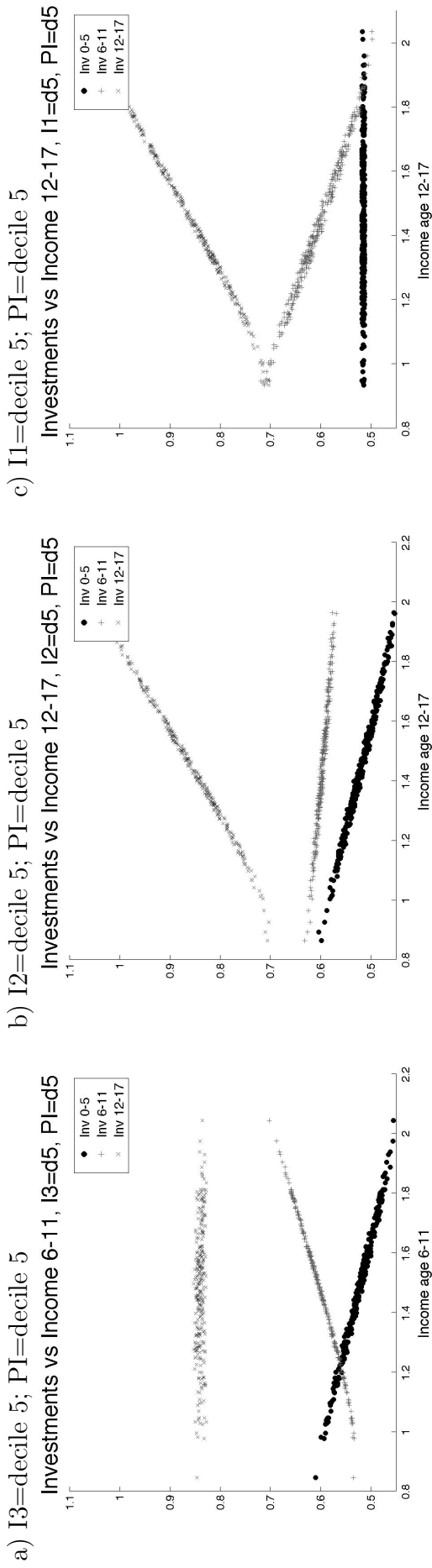
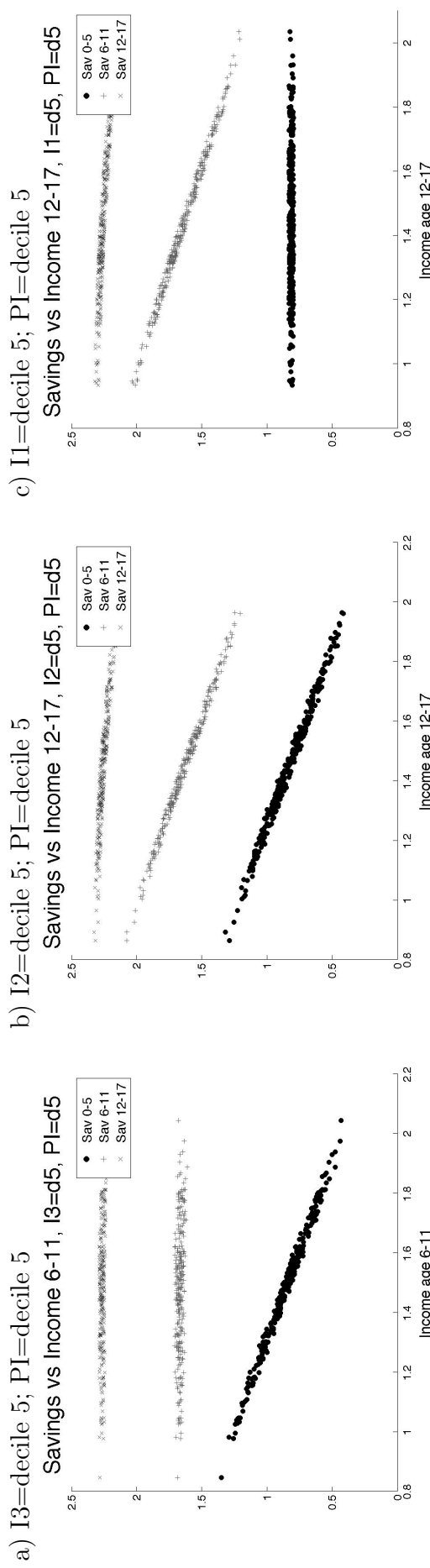
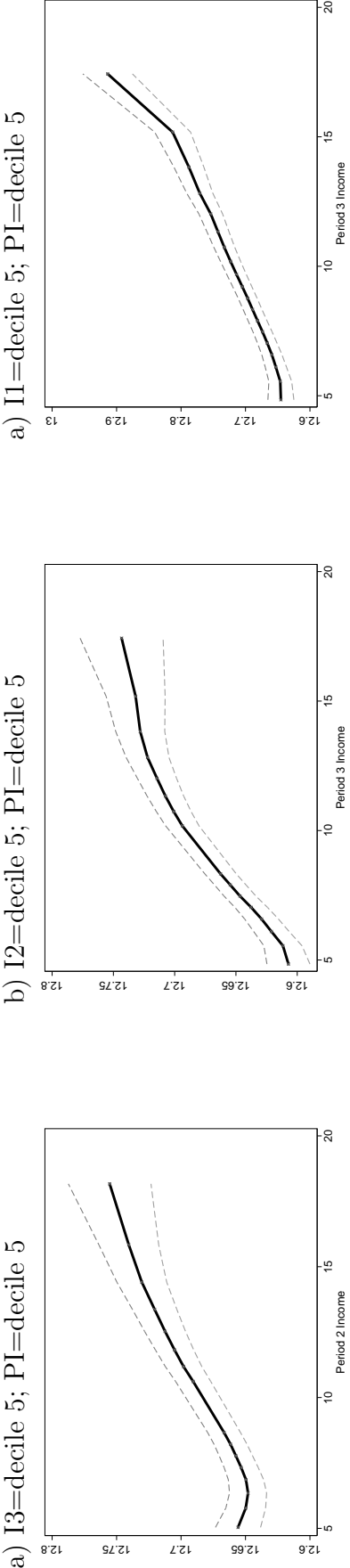


Figure 13: Simulated per-period Savings. Basic Model with Income Uncertainty.



Note: Income in 2000 prices, £ 10,000s. Period 1, 2, 3 refer to ages 0-5, 6-11 and 12-17. Simulated data based on 100,000 draws of income shocks per period. Estimated technology parameters and years of schooling obtained by simulated method of moments, matching percentiles 10, 25, 50, 75 and 90 of each per-period income.

Figure 14: Simulated Years of Schooling and Paternal Income 6-11. Model with Income Uncertainty and Learning about the Child's Ability



Note: Income in 2000 prices, £ 10,000s. Period 2 refers to age 6-11. Simulated data based on 100,000 draws of income and technology shocks per period. Estimated technology parameters and years of schooling obtained by simulated method of moments, matching percentiles 10, 25, 50, 75 and 90 of each per-period income.

Table 1: Descriptive Statistics

	N	Mean	Standard Deviation
Paternal Income Period 1, Age 0-5	522,490	11.83	4.23
Paternal Income Period 2, Age 6-11	522,490	10.25	4.41
Paternal Income Period 3, Age 12-17	522,490	8.53	4.68
Paternal Permanent Income, Age 0-17	522,490	30.61	11.69
Mother Years of Schooling	522,490	11.14	2.71
Father Years of Schooling	522,490	11.45	3.02
Mother Age at Birth	522,490	26.26	5.03
Father Age at Birth	522,490	29.02	5.74
Child Year of Birth	522,490	1975.29	2.88
Years of Schooling	520,752	12.73	2.41
High School Dropout	522,490	0.21	0.41
College Attendance	522,490	0.39	0.49
Log Earnings age 30	307,776	9.90	0.81
IQ (males only)	248,801	5.25	1.79
Health (males only)	265,959	8.44	1.52
Teenage Pregnancy (females only)	249,540	0.08	0.28
Grades	48,384	42.75	10.62

Note: Income and earnings variables in 2000 prices, £ 10,000s.

Table 2: Set of Calibrated Structural Parameters

Parameter	Value
Risk Aversion ( $\sigma$ )	0.5
Discount factor ( $\beta$ )	0.96
Interest rate ( $r$ )	0.5
Credit Constraint ( $-a$ )	0
Relative price investment/consumption ( $p$ )	1
Parental valuation of child's human capital ( $\eta$ )	12
Parental valuation of assets when children become adults ( $\varphi$ )	12
Minimum wage ( $w_{\min}$ )	1
Wage slopes by type ( $w_k$ )	{7,7.65,11}
Variance of income shocks ( $\sigma_\varepsilon^2$ )	0.1
Initial endowment ( $H_{0,k}$ )	{1,1,0282,1.0483}

Note: The table shows the set of structural parameters that were calibrated for our simulations. The sensitivity of our results to different calibrations is shown below.

Table 3: Estimated Structural Parameters

Parameter	Estimates
$\gamma_1$	0.5991
$\gamma_2$	0.4602
$\gamma_3$	0.6194
$\phi$	0.4282
$\rho$	0.7487
$\delta$	2.23

Note: The table shows the estimated parameters for the technology of skill formation presented in equation 11

Table 4: Sensitivity of the Estimated Structural Parameters

Parameter	Benchmark	No Credit Con- straints ( $a = -\infty$ )	Low Elasticity of Consumption ( $\sigma = 0.95$ )	High Elasticity of Consumption ( $\sigma = 0.1$ )	High valuation of child's human capital relative to assets ( $\frac{\eta}{\tau} = 5$ )	Low valuation of child's human capital ( $\frac{\eta}{\tau} = 0.2$ )
$\gamma_1$	0.59	0.39	0.54	0.37	0.48	0.42
$\gamma_2$	0.46	0.69	0.48	0.53	0.63	0.53
$\gamma_3$	0.62	0.56	0.63	0.70	0.73	0.43
$\phi$	0.43	-0.31	-0.36	0.30	0.49	0.50
$\rho$	0.75	0.52	0.58	0.71	0.69	0.49
$\delta$	2.23	2.97	3.60	2.45	3.03	2.56
$1/(1 - \phi)$	1.75	0.76	0.73	1.42	2	2

Note: The table shows the sensitivity of the estimated technology of skill formation under different combinations of the calibrated parameters in table 2

WEB APPENDIX  
Intergenerational Mobility and the Timing of Parental Income

Pedro Carneiro

Department of Economics  
University College London, IFS, CEMMAP

p.carneiro@ucl.ac.uk

Italo Lopez Garcia

RAND Corporation

ilopezga@rand.org

Kjell G. Salvanes

Department of Economics  
Norwegian School of Economics, IZA, CEE and CEPR

kjell.salvanes@nhh.no

Emma Tominey

University of York, IZA  
emma.tominey@york.ac.uk

October 2015

## Appendix 1: Approximation of the Expected Value Function by Chebyshev Polynomials

The input for the approximation procedure is the expected value function one period ahead. In a backward recursion approach, the process starts by calibrating the terminal value function which is approximated and used to evaluate the bellman equation and optimal investments and savings in the last period. In each subsequent period the evaluated Bellman equation is the input for approximation. This method allows obtaining the optimal investment and saving rules for each combination of state variables (schooling and assets).

The Expected Value Function is approximated with Chebyshev Polynomials

$$\Phi_{t+1}(h'_k, a'_l) = \sum_{p=1}^N \sum_{q=1}^N \alpha_{pq} T_p(z_k) T_q(z_l)$$

where we represent  $\Phi_{t+1}(h'_k, a'_l)$  is the approximating function,  $\alpha_{pq}$  is the vector of optimal coefficients  $T(z)$  is the polynomial basis evaluated in  $M$  extrema.

In each period, the approximation method relies on finding the optimal coefficients  $\alpha_{pq}^t$  minimizing

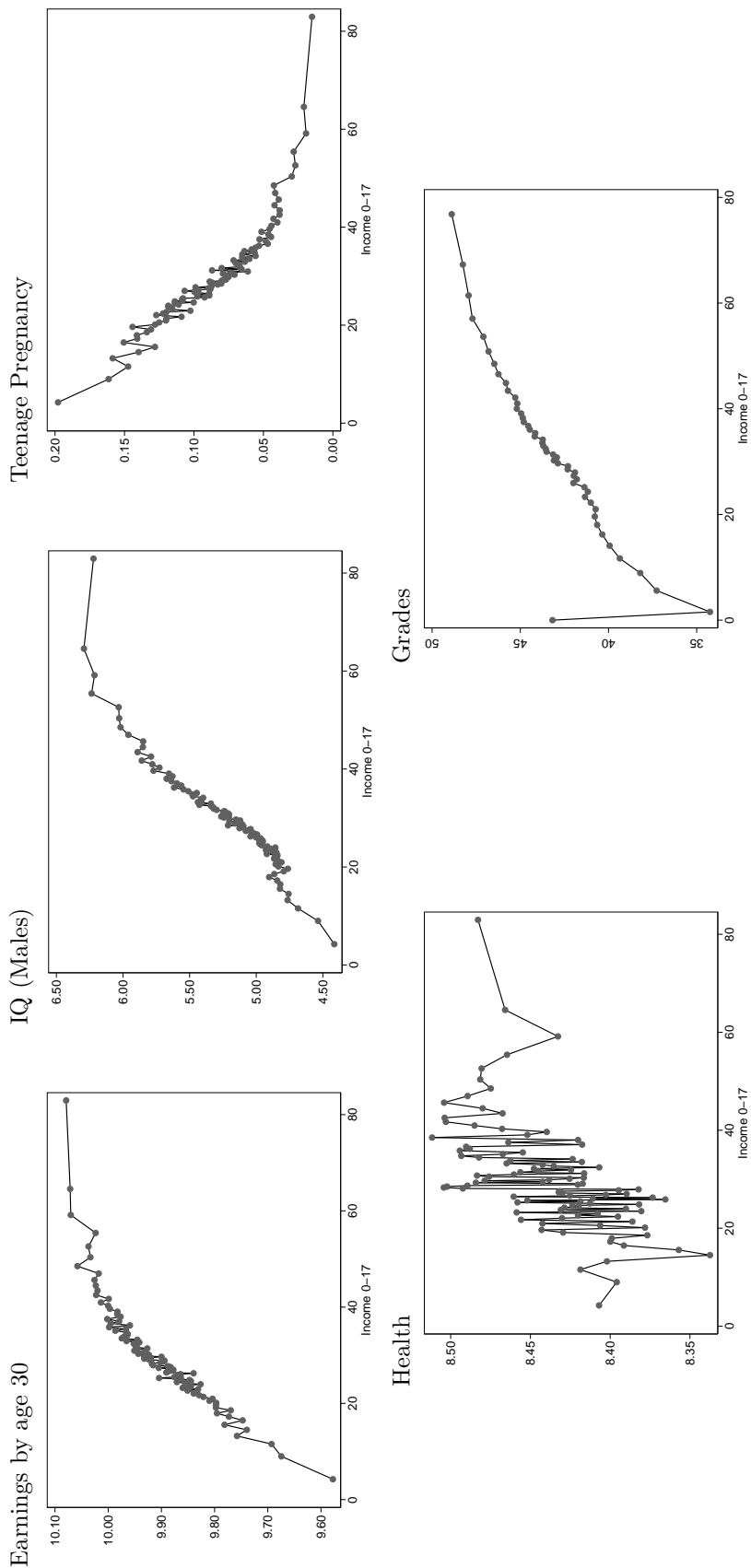
$$\text{Min}_{\alpha_{pq}^t} R(h, a, \alpha) = \sum_{k=1}^M \sum_{l=1}^M \left[ EV_{t+1}(h'_k, a'_l) - \sum_{p=1}^N \sum_{q=1}^N \alpha_{pq}^t T_p(z_k) T_q(z_l) \right]^2$$

The estimated coefficients are then used to evaluate the Bellman equation and maximizing

$$V_t(h_k, a_l) = \text{Max}_{a', i} \left\{ \frac{[we^{\varepsilon_j} + (1+r)a_l - pi - a'^{1-\sigma}]}{1-\sigma} + \beta \Phi_{t+1}([\gamma_t h_k^\phi + (1-\gamma_t)i^\phi]^{\rho/\phi}, a') \right\}$$

Taking F.O.C with respect to savings and investments we can obtain the optimal policy functions  $i(h_k, a_l)$  and  $a'(h_k, a_l)$

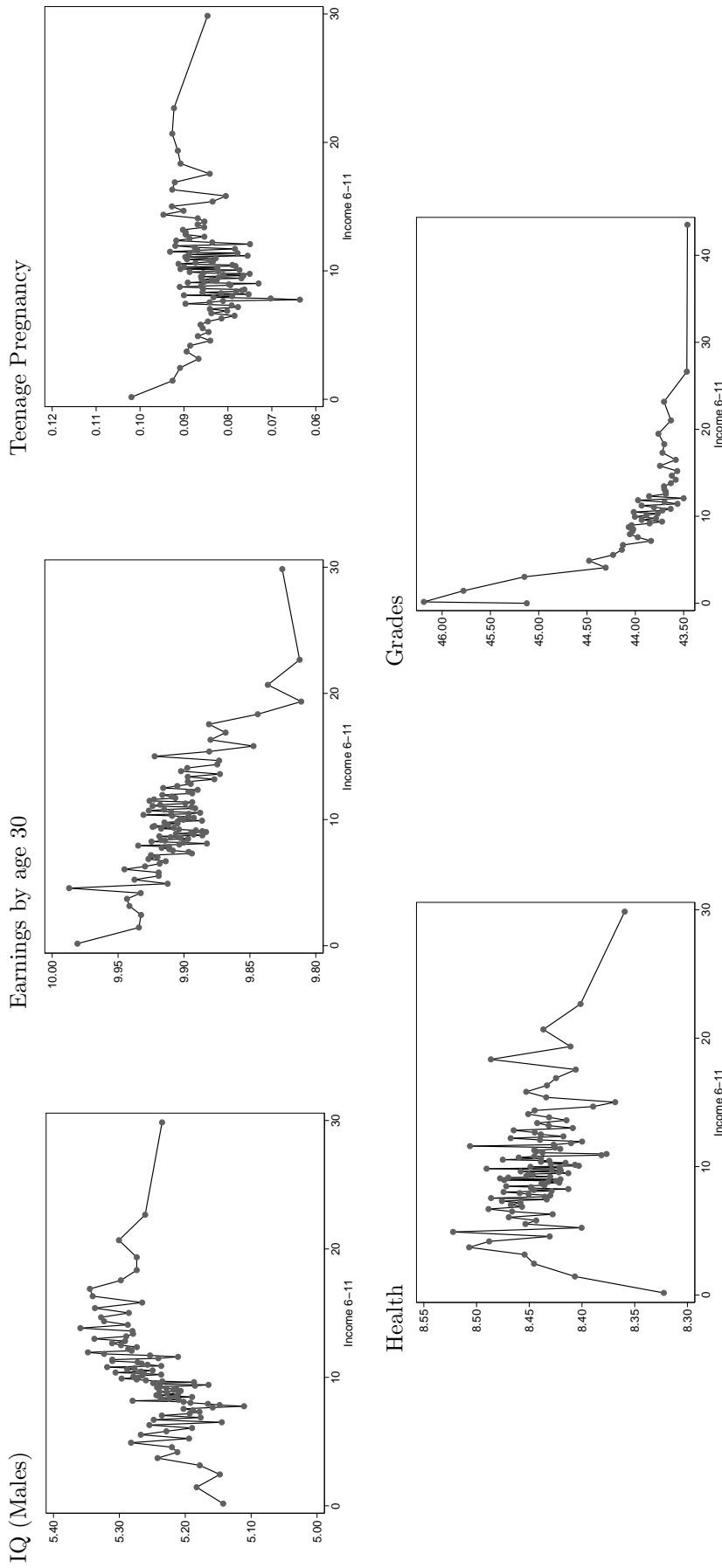
Figure A1: Parametric Estimates. Paternal Income 0-17 and Human Capital Outcomes.



Graphs plot individual coefficients from regression of decile bins for PI upon child human capital. Income in 2000 prices, £ 10,000s.

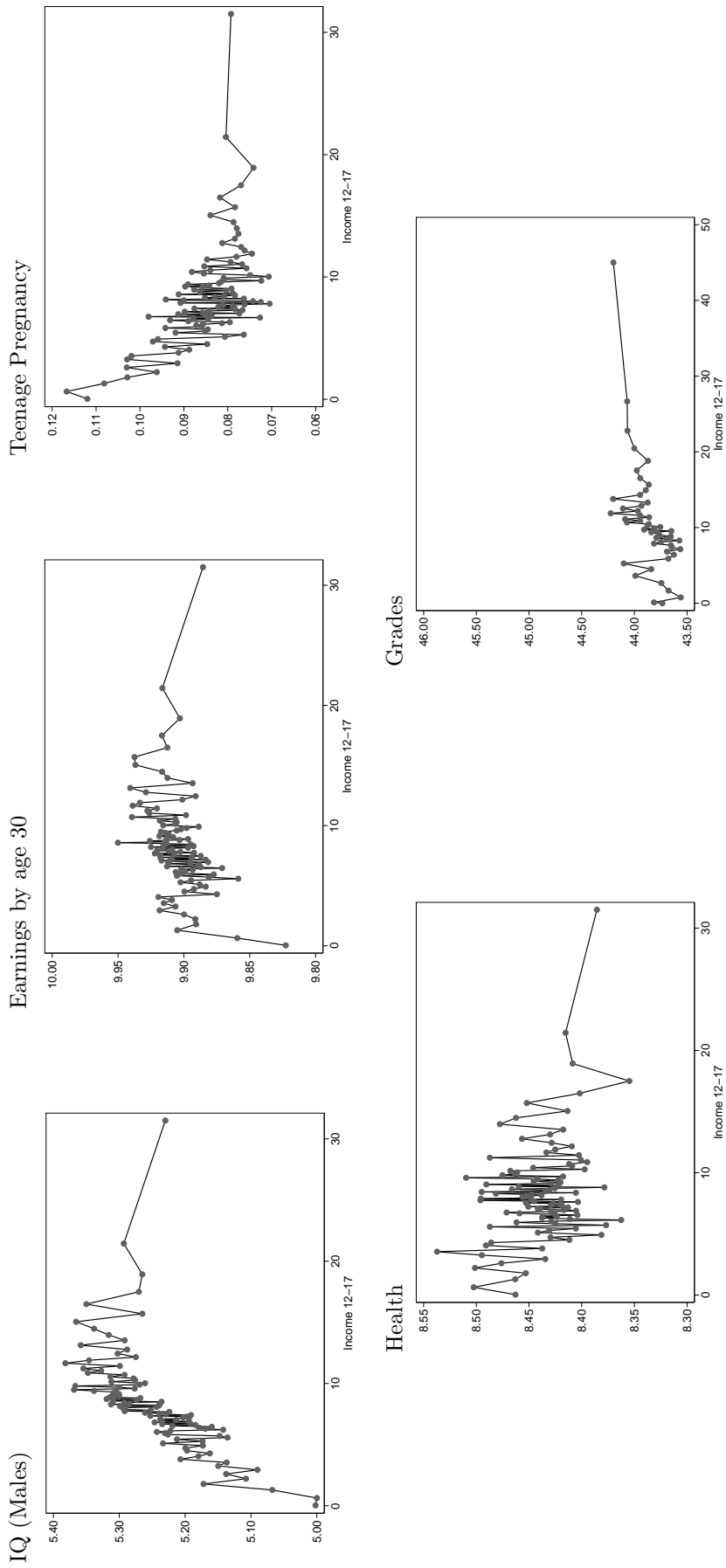


Figure A2a: Parametric Estimates. Paternal Income 6-11 and Human Capital Outcomes.



Graphs plot individual coefficients from regression of decile bins for I2, I3, PI upon child human capital controlling for heterogeneous income profile, dummy variables for paternal education interacted with paternal age, dummy variables for maternal education interacted with maternal age, gender and child year of birth dummies. Income in 2000 prices, £ 10,000s.

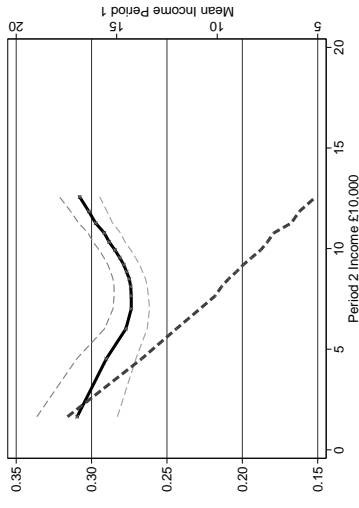
Figure A2b: Parametric Estimates. Paternal Income 12-17 and Human Capital Outcomes.



Graphs plot individual coefficients from regression of decile bins for 12, 13, PI upon child human capital controlling for heterogeneous income profile, dummy variables for paternal education interacted with paternal age, dummy variables for maternal education interacted with maternal age, gender and child year of birth dummies. Income in 2000 prices, £ 10,000s.

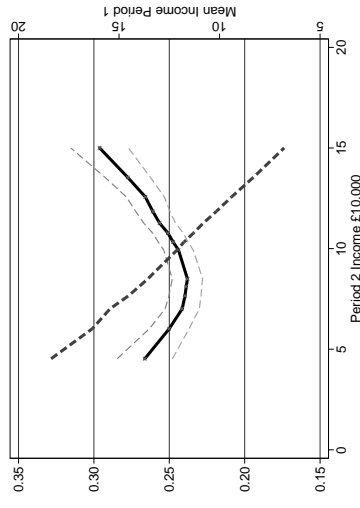
Figure A3: Semi-parametric Estimates. Dependent Variable is High School Dropout. Paternal Income 6-11.

ai) I3=6.34, PI=24.18



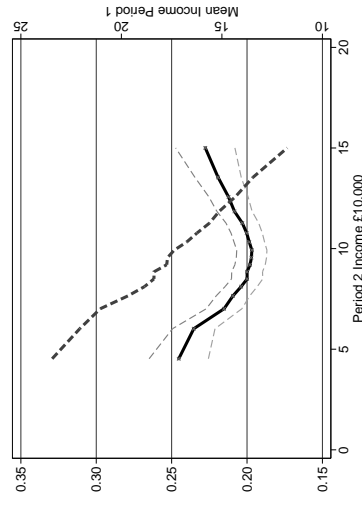
$\alpha_1 = -0.02 (0.01) \alpha_2 = 0.03 (0.01)$

bi) I3=6.34, PI=28.24



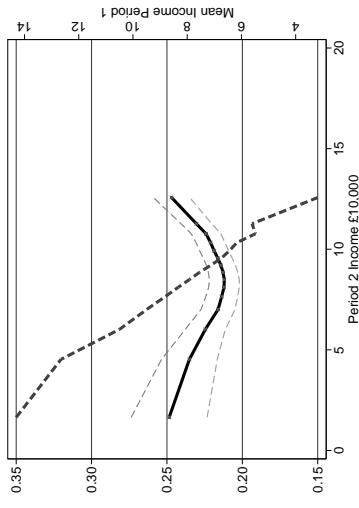
$\alpha_1 = -0.03 (0.01) \alpha_2 = 0.04 (0.01)$

ci) I3=6.34, PI=32.93



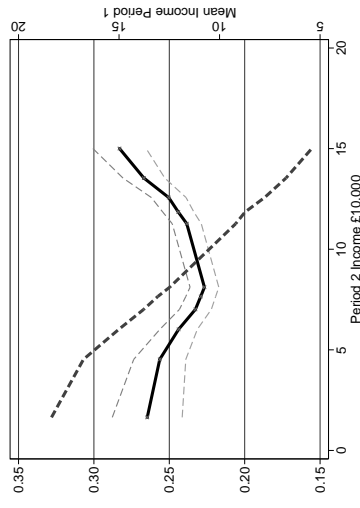
$\alpha_1 = -0.04 (0.01) \alpha_2 = 0.03 (0.01)$

aii) I3=7.49, PI=24.18



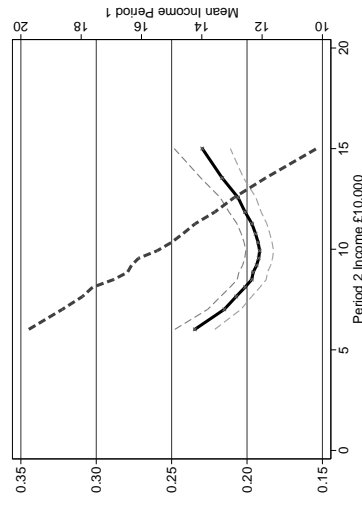
$\alpha_1 = -0.03 (0.01) \alpha_2 = 0.04 (0.01)$

bii) I3=7.49, PI=28.24



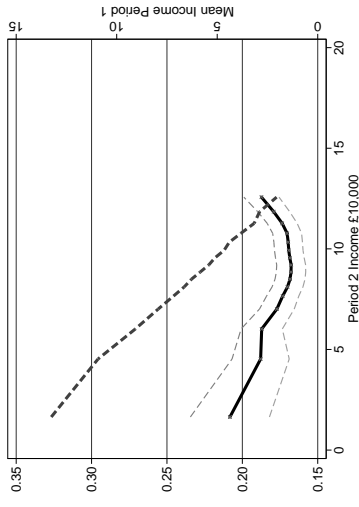
$\alpha_1 = -0.03 (0.01) \alpha_2 = 0.06 (0.01)$

cii) I3=7.49, PI=32.93



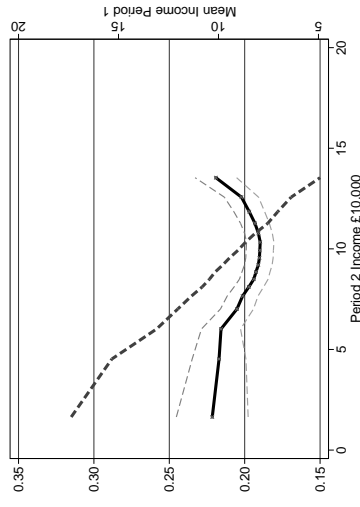
$\alpha_1 = -0.04 (0.01) \alpha_2 = 0.04 (0.01)$

aiii) I3=9.32, PI=24.18



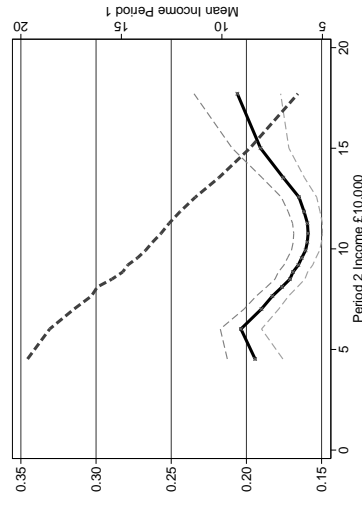
$\alpha_1 = -0.03 (0.01) \alpha_2 = 0.02 (0.01)$

biii) I3=9.32, PI=28.24



$\alpha_1 = -0.03 (0.01) \alpha_2 = 0.03 (0.01)$

ciii) I3=9.32, PI=32.93

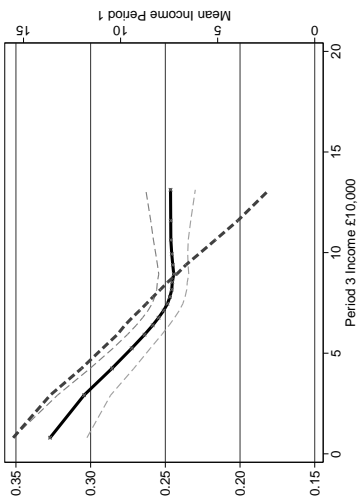


$\alpha_1 = -0.03 (0.01) \alpha_2 = 0.05 (0.01)$

Note: 95% confidence intervals shown. Income in 2000 prices, £ 10,000s. Semi-parametric estimates control for dummies for paternal education interacted with age and maternal education interacted with age, paternal income profile, gender and child year of birth.

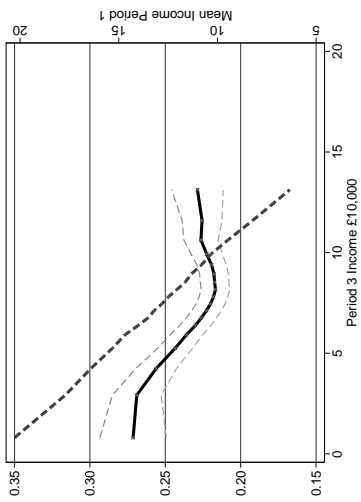
Figure A3: Semi-parametric Estimates. Dependent Variable is High School Dropout. Paternal Income 12-17.

di) I2=8.13, PI=24.18



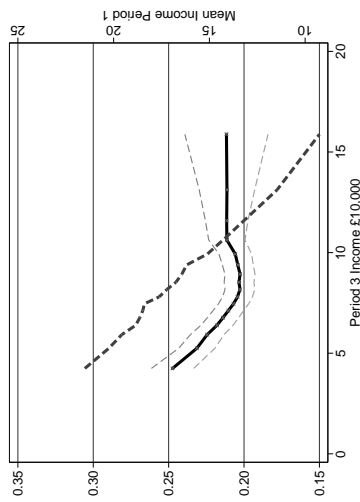
$\alpha_1 = -0.08 (0.01)$   $\alpha_2 = -0.00 (0.01)$

ei) I2=8.13, PI=28.24



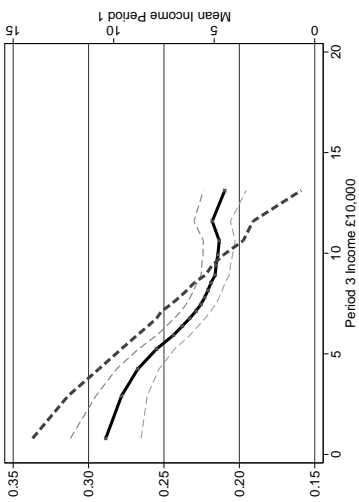
$\alpha_1 = -0.05 (0.01)$   $\alpha_2 = 0.01 (0.01)$

fi) I2=8.13, PI=32.93



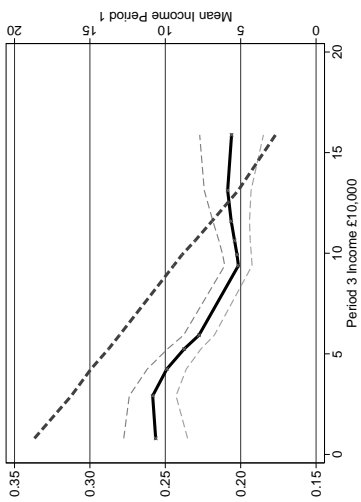
$\alpha_1 = -0.05 (0.01)$   $\alpha_2 = 0.01 (0.01)$

dii) I2=9.56, PI=24.18



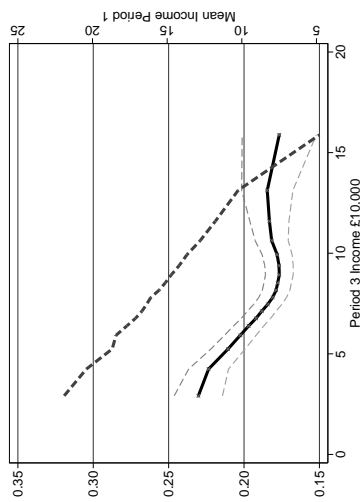
$\alpha_1 = -0.06 (0.01)$   $\alpha_2 = -0.03 (0.01)$

eii) I2=9.56, PI=28.24



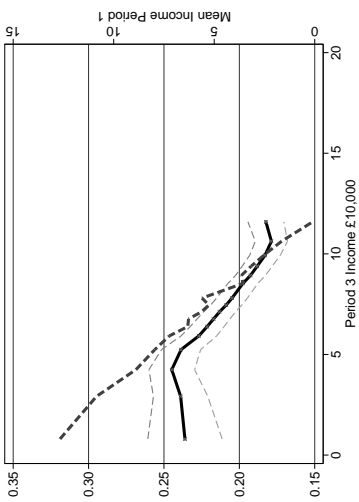
$\alpha_1 = -0.05 (0.01)$   $\alpha_2 = -0.00 (0.01)$

fi) I2=9.56, PI=32.93



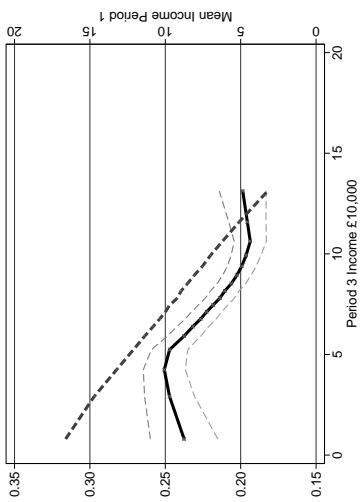
$\alpha_1 = -0.05 (0.01)$   $\alpha_2 = -0.01 (0.01)$

diii) I2=11.26, PI=24.18



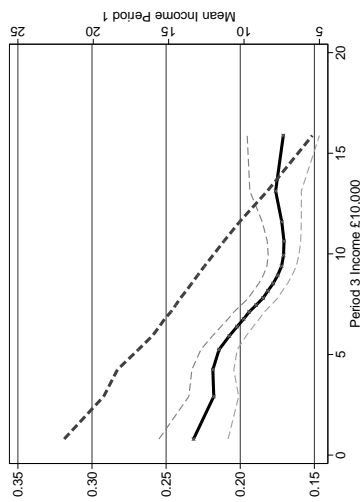
$\alpha_1 = -0.02 (0.01)$   $\alpha_2 = -0.04 (0.01)$

eiii) I2=11.26, PI=28.24



$\alpha_1 = -0.02 (0.01)$   $\alpha_2 = -0.02 (0.01)$

fi) I2=11.26, PI=32.93

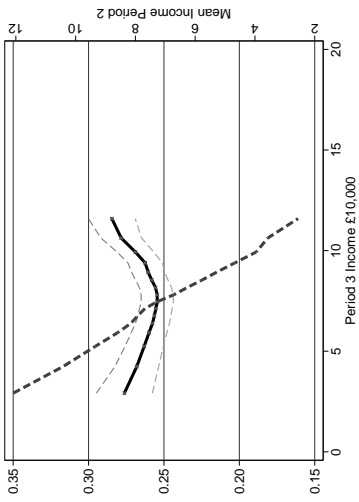


$\alpha_1 = -0.05 (0.01)$   $\alpha_2 = -0.01 (0.01)$

Note: 95% confidence intervals shown. Income in 2000 prices, £ 10,000s. Semi-parametric estimates control for dummies for paternal education interacted with age and maternal education interacted with age, paternal income profile, gender and child year of birth.

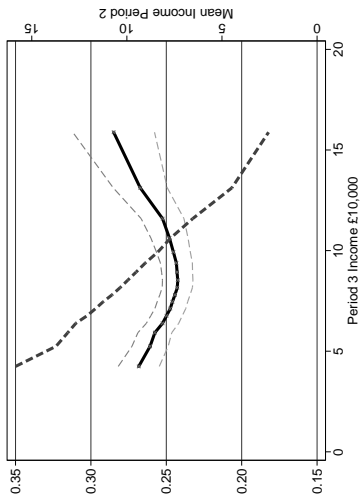
Figure A3: Semi-parametric Estimates. Dependent Variable is High School Dropout. Paternal Income 12-17.

gi)  $\Pi=10.91$ ,  $PI=24.18$



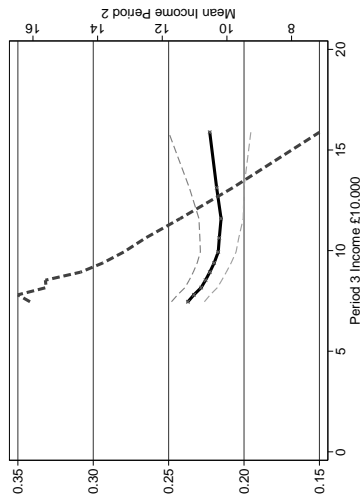
$\alpha_1 = -0.02$  (0.01)  $\alpha_2 = 0.03$  (0.01)

hi)  $\Pi=10.91$ ,  $PI=28.24$

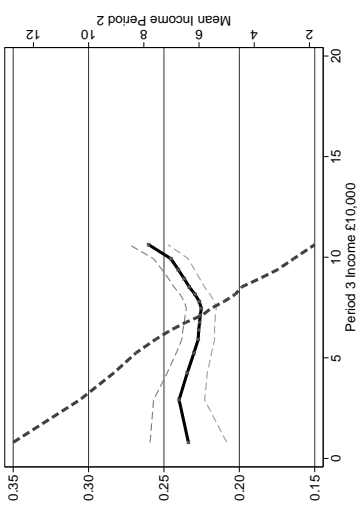


$\alpha_1 = -0.02$  (0.01)  $\alpha_2 = 0.02$  (0.01)

ji)  $\Pi=10.91$ ,  $PI=32.93$

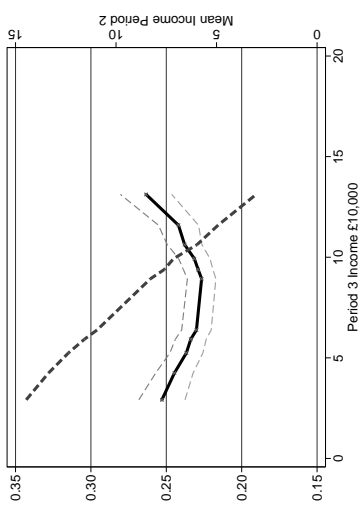


gii)  $\Pi=13.02$ ,  $PI=24.18$



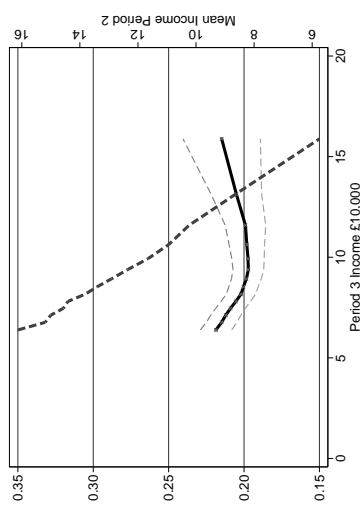
$\alpha_1 = -0.02$  (0.01)  $\alpha_2 = 0.03$  (0.01)

hii)  $\Pi=13.02$ ,  $PI=28.24$

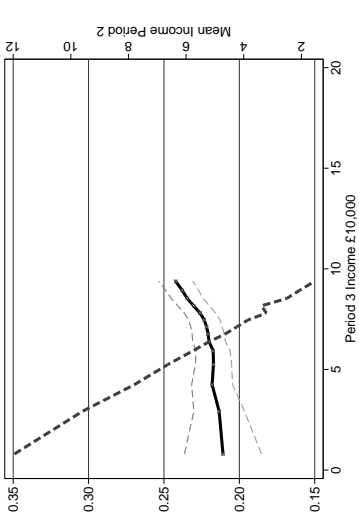


$\alpha_1 = -0.03$  (0.01)  $\alpha_2 = 0.04$  (0.01)

jii)  $\Pi=13.02$ ,  $PI=32.93$

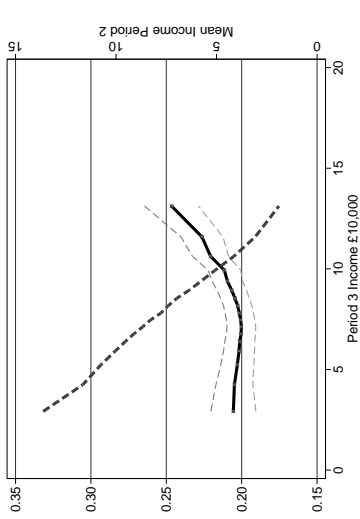


giii)  $\Pi=15.64$ ,  $PI=24.18$



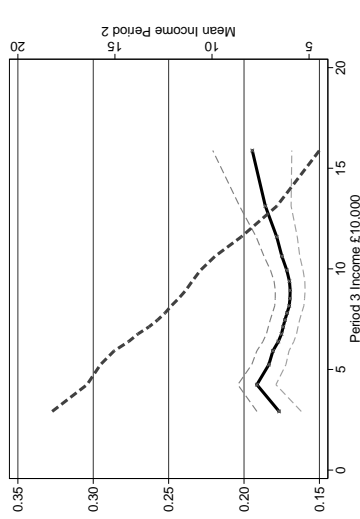
$\alpha_1 = 0.01$  (0.01)  $\alpha_2 = 0.02$  (0.01)

hiii)  $\Pi=15.64$ ,  $PI=28.24$



$\alpha_1 = -0.01$  (0.01)  $\alpha_2 = 0.05$  (0.01)

jiij)  $\Pi=15.64$ ,  $PI=32.93$



$\alpha_1 = -0.02$  (0.01)  $\alpha_2 = 0.00$  (0.01)

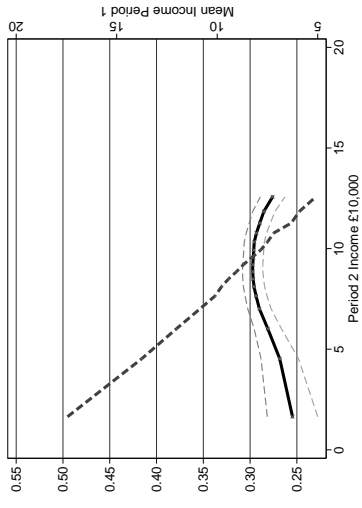
$\alpha_1 = -0.02$  (0.01)  $\alpha_2 = 0.02$  (0.01)

$\alpha_1 = -0.01$  (0.01)  $\alpha_2 = 0.03$  (0.01)

Note: 95% confidence intervals shown. Income in 2000 prices, £ 10,000s. Semi-parametric estimates control for dummies for paternal education interacted with age and maternal education interacted with age, paternal income profile, gender and child year of birth.

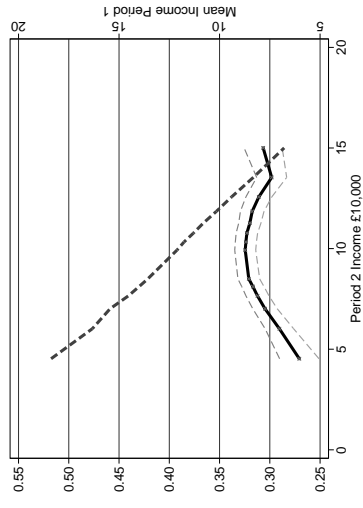
Figure A4: Semi-parametric Estimates. Dependent Variable is College. Paternal Income 6-11.

ai) I3=6.34, PI=24.18



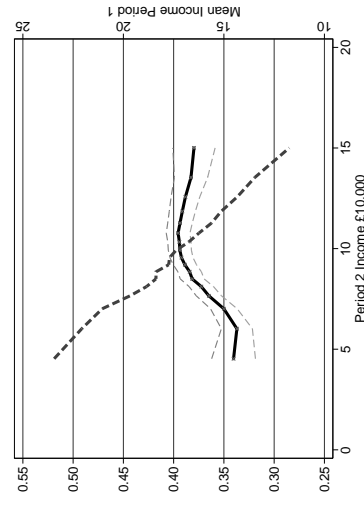
$\alpha_1 = 0.04$  (0.01)  $\alpha_2 = -0.02$  (0.01)

bi) I3=6.34, PI=28.24

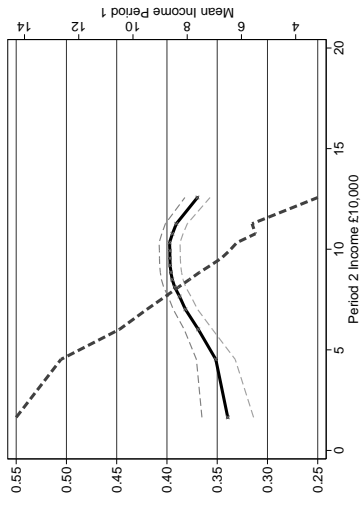


$\alpha_1 = 0.05$  (0.01)  $\alpha_2 = -0.03$  (0.01)

c) I3=6.34, PI=32.93

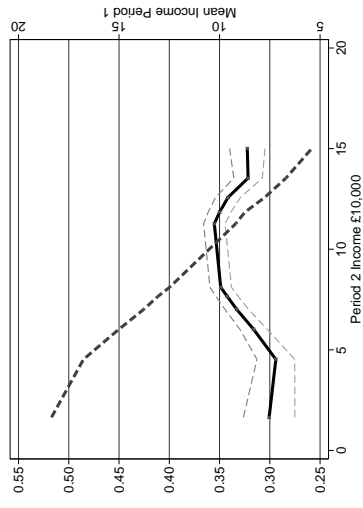


aii) I3=7.49, PI=24.18



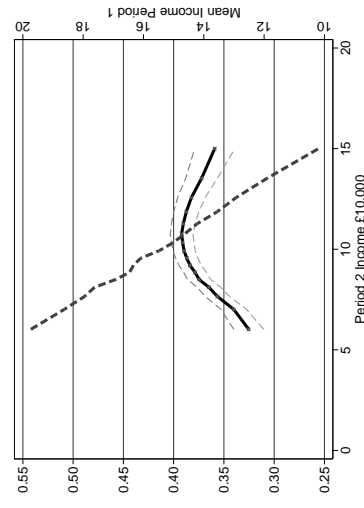
$\alpha_1 = 0.05$  (0.01)  $\alpha_2 = -0.03$  (0.01)

bii) I3=7.49, PI=28.24

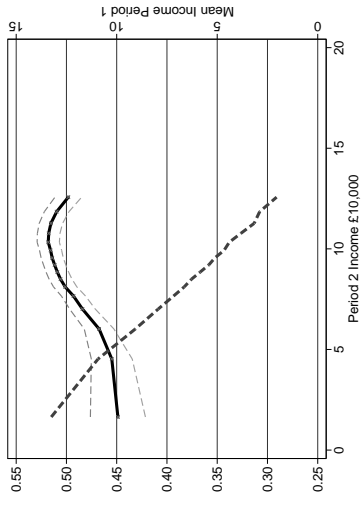


$\alpha_1 = 0.07$  (0.01)  $\alpha_2 = -0.04$  (0.01)

cii) I3=7.49, PI=32.93

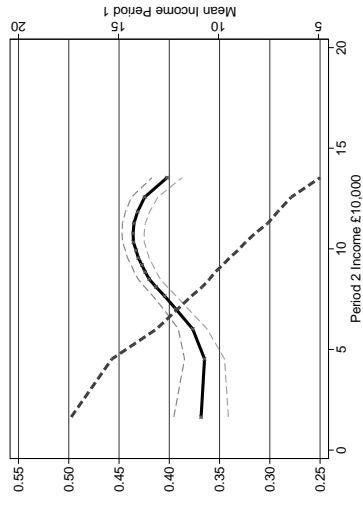


aiii) I3=9.32, PI=24.18



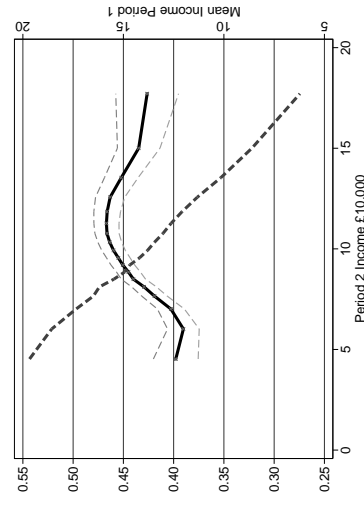
$\alpha_1 = 0.05$  (0.01)  $\alpha_2 = -0.02$  (0.01)

biii) I3=9.32, PI=28.24



$\alpha_1 = 0.05$  (0.01)  $\alpha_2 = -0.03$  (0.01)

ciii) I3=9.32, PI=32.93



$\alpha_1 = 0.06$  (0.01)  $\alpha_2 = -0.01$  (0.01)

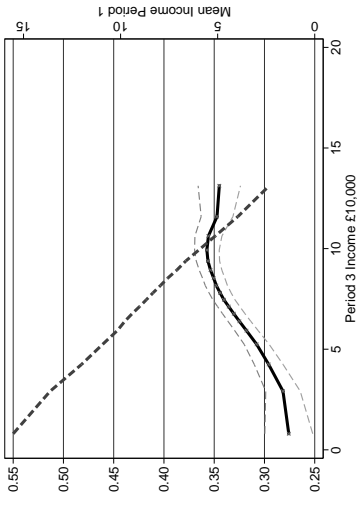
$\alpha_1 = 0.06$  (0.01)  $\alpha_2 = -0.03$  (0.01)

$\alpha_1 = 0.06$  (0.01)  $\alpha_2 = -0.03$  (0.01)

Note: 95% confidence intervals shown. Income in 2000 prices, £ 10,000s. Semi-parametric estimates control for dummies for paternal education interacted with age and maternal education interacted with age, paternal income profile, gender and child year of birth.

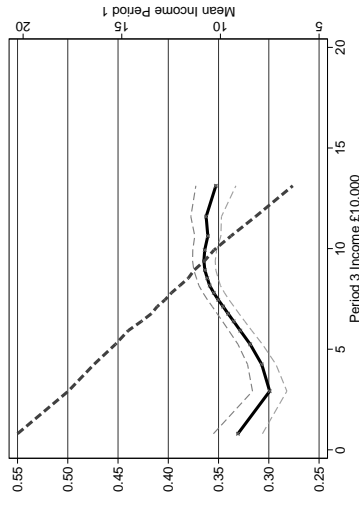
Figure A4: Semi-parametric Estimates. Dependent Variable is College. Paternal Income 12-17.

di) I2=8.13, PI=24.18



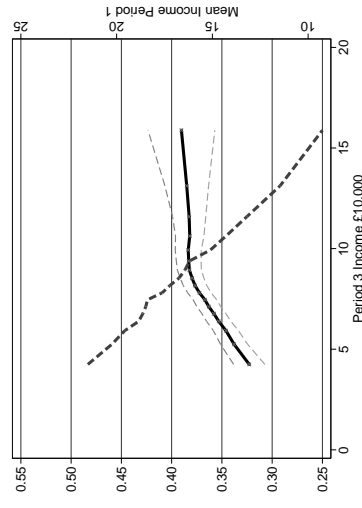
$\alpha_1 = 0.07 (0.01) \alpha_2 = -0.03 (0.01)$

ei) I2=8.13, PI=28.24



$\alpha_1 = 0.05 (0.01) \alpha_2 = -0.00 (0.01)$

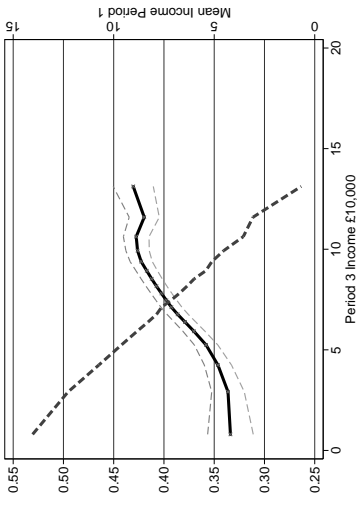
fi) I2=8.13, PI=32.93



$\alpha_1 = 0.01 (0.01) \alpha_2 = 0.02 (0.01)$

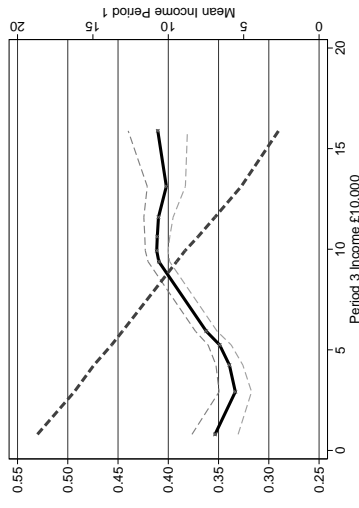
Note: 95% confidence intervals shown. Income in 2000 prices, £ 10,000s. Semi-parametric estimates control for dummies for paternal education interacted with age and maternal education interacted with age, paternal income profile, gender and child year of birth.

dii) I2=9.56, PI=24.18



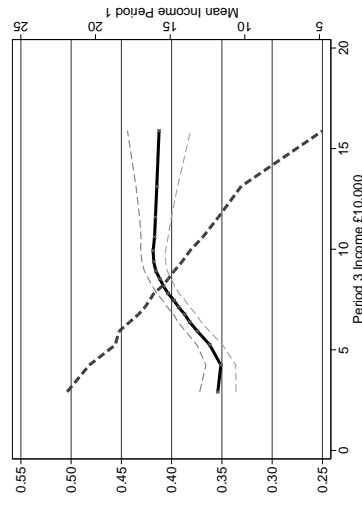
$\alpha_1 = 0.07 (0.01) \alpha_2 = 0.04 (0.01)$

eii) I2=9.56, PI=28.24



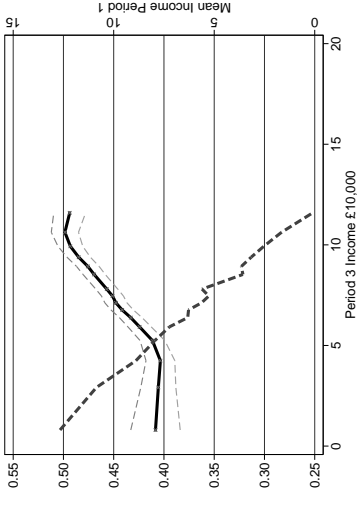
$\alpha_1 = 0.04 (0.01) \alpha_2 = 0.02 (0.01)$

fi) I2=9.56, PI=32.93



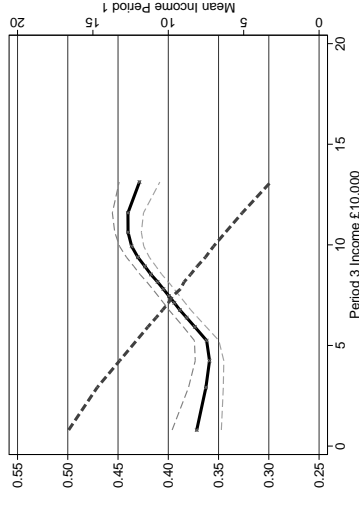
$\alpha_1 = 0.05 (0.01) \alpha_2 = 0.01 (0.01)$

diii) I2=11.26, PI=24.18



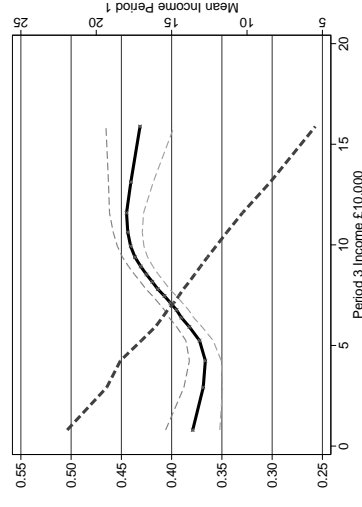
$\alpha_1 = 0.03 (0.01) \alpha_2 = 0.05 (0.01)$

eiii) I2=11.26, PI=28.24



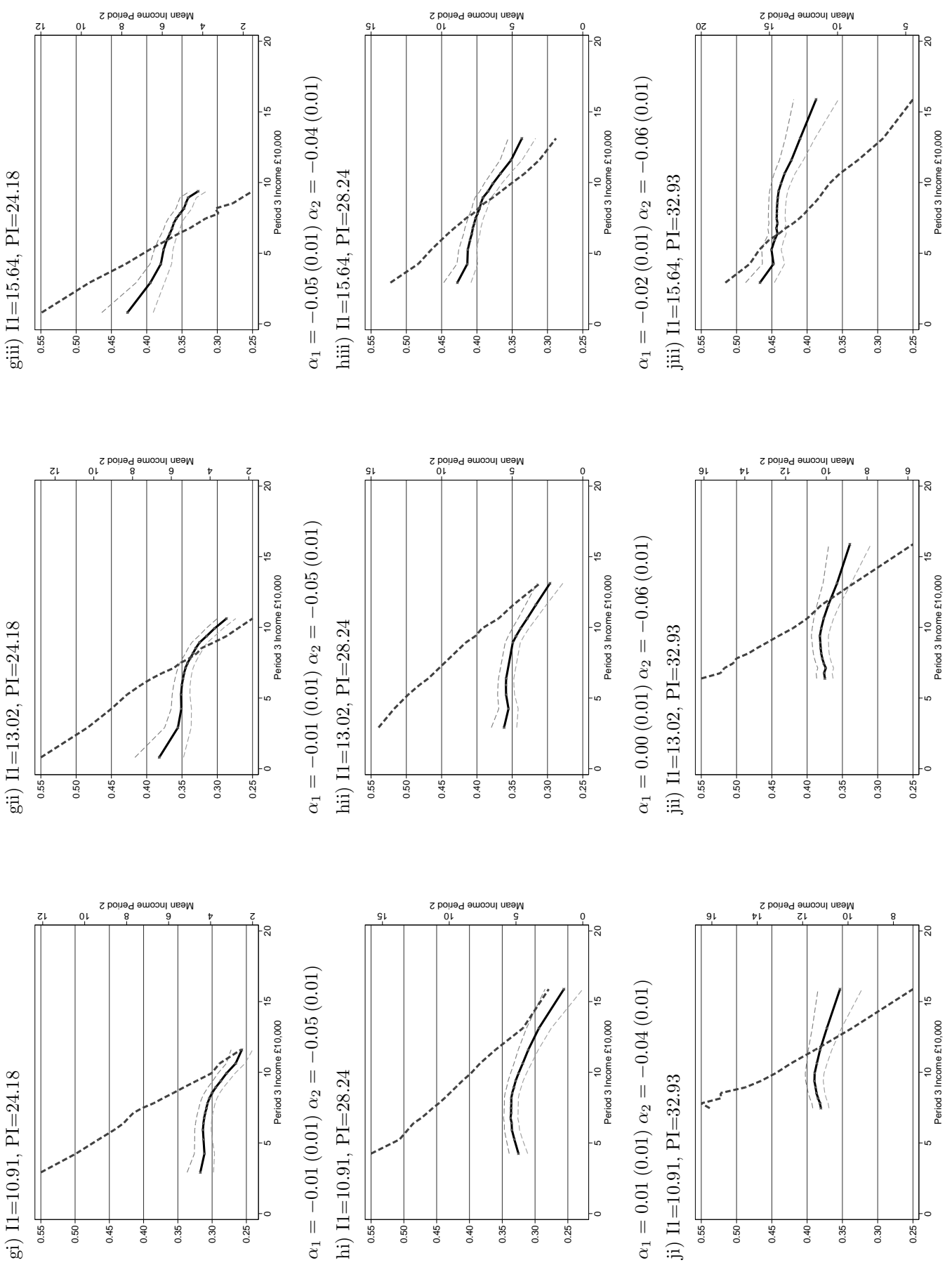
$\alpha_1 = 0.03 (0.01) \alpha_2 = 0.03 (0.01)$

fiii) I2=11.26, PI=32.93



$\alpha_1 = 0.04 (0.01) \alpha_2 = 0.02 (0.01)$

Figure A4: Semi-parametric Estimates. Dependent Variable is College. Paternal Income 12-17.

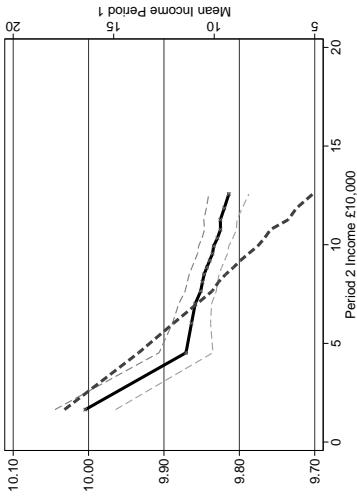


$\alpha_1 = 0.01 (0.01) \alpha_2 = -0.03 (0.01)$   $\alpha_1 = 0.00 (0.01) \alpha_2 = -0.04 (0.01)$   $\alpha_1 = -0.01 (0.01) \alpha_2 = -0.06 (0.01)$   
 Note: 95% confidence intervals shown. Income in 2000 prices, £ 10,000s. Semi-parametric estimates control for dummies for paternal education interacted with age and maternal education interacted with age, paternal income profile, gender and child year of birth.



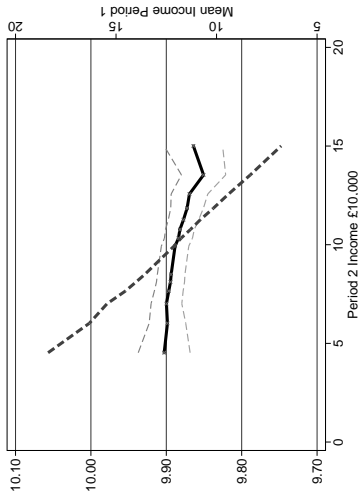
Figure A5: Semi-parametric Estimates. Dependent Variable is Log Earnings Age 30. Paternal Income 6-11.

ai) I3=6.34, PI=24.18



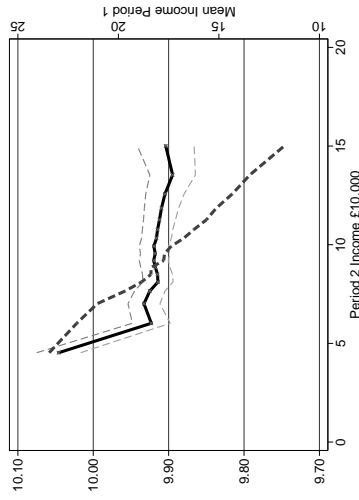
$\alpha_1 = -0.10 (0.02) \alpha_2 = -0.04 (0.01)$

bi) I3=6.34, PI=28.24



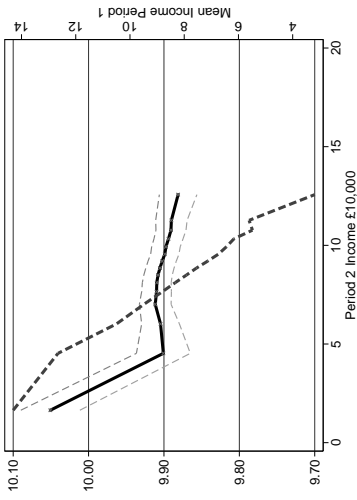
$\alpha_1 = 0.00 (0.02) \alpha_2 = -0.04 (0.01)$

ci) I3=6.34, PI=32.93



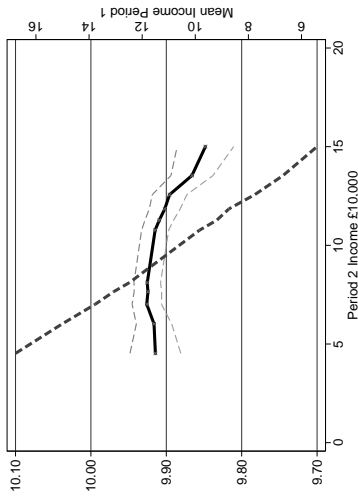
$\alpha_1 = -0.07 (0.01) \alpha_2 = -0.01 (0.02)$

aii) I3=7.49, PI=24.18



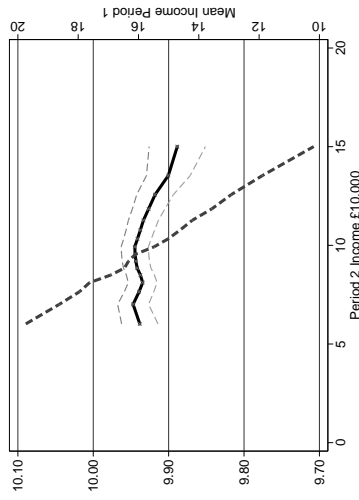
$\alpha_1 = -0.10 (0.02) \alpha_2 = -0.04 (0.01)$

bii) I3=7.49, PI=28.24



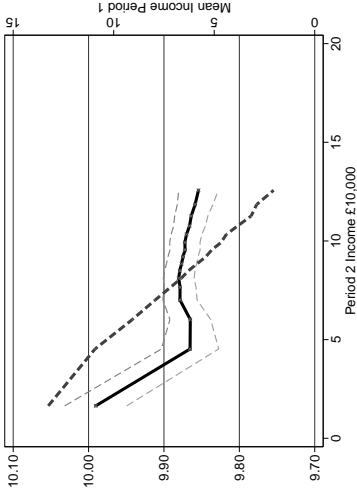
$\alpha_1 = 0.01 (0.02) \alpha_2 = -0.08 (0.02)$

cii) I3=7.49, PI=32.93



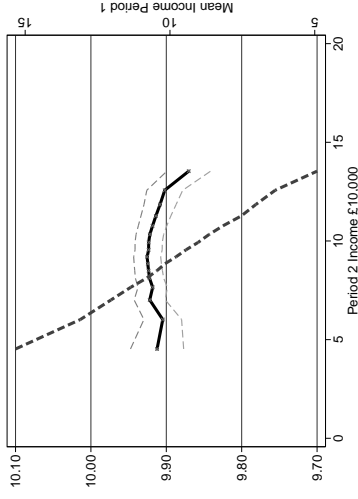
$\alpha_1 = 0.01 (0.01) \alpha_2 = -0.05 (0.02)$

aiii) I3=9.32, PI=24.18



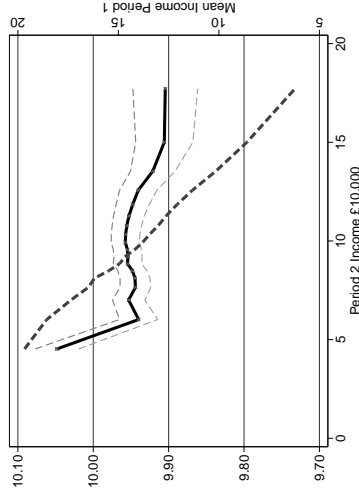
$\alpha_1 = -0.08 (0.02) \alpha_2 = -0.04 (0.01)$

biii) I3=9.32, PI=28.24



$\alpha_1 = -0.06 (0.02) \alpha_2 = -0.06 (0.01)$

ciii) I3=9.32, PI=32.93

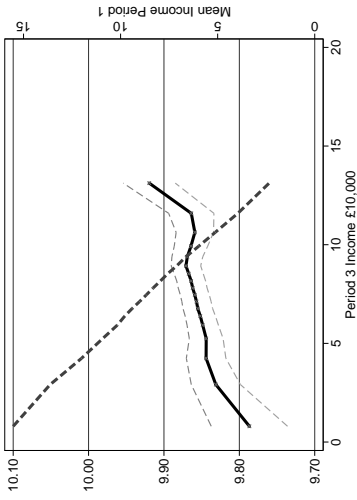


$\alpha_1 = -0.02 (0.02) \alpha_2 = -0.07 (0.02)$

Note: 95% confidence intervals shown. Income in 2000 prices, £ 10,000s. Semi-parametric estimates control for dummies for paternal education interacted with age and maternal education interacted with age, paternal income profile, gender and child year of birth.

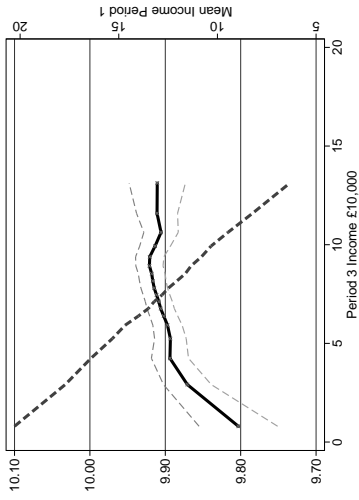
Figure A5: Semi-parametric Estimates. Dependent Variable is Log Earnings Age 30. Paternal Income 12-17.

di) I2=8.13, PI=24.18



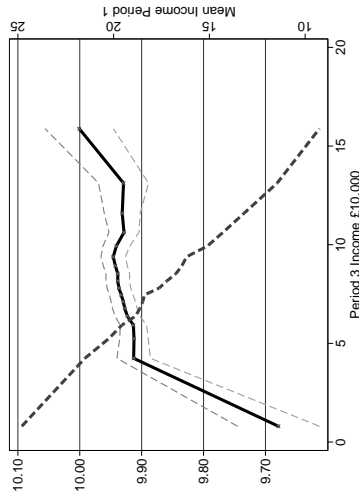
$\alpha_1 = 0.07 (0.02)$   $\alpha_2 = 0.01 (0.03)$

ei) I2=8.13, PI=28.24



$\alpha_1 = 0.04 (0.01)$   $\alpha_2 = -0.03 (0.02)$

fi) I2=8.13, PI=32.93

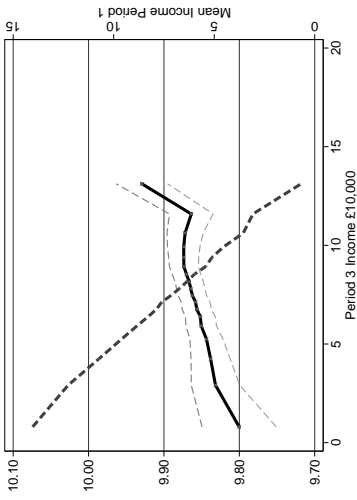


$\alpha_1 = 0.23 (0.03)$   $\alpha_2 = 0.04 (0.02)$

$\alpha_1 = 0.011 (0.02)$   $\alpha_2 = -0.01 (0.03)$

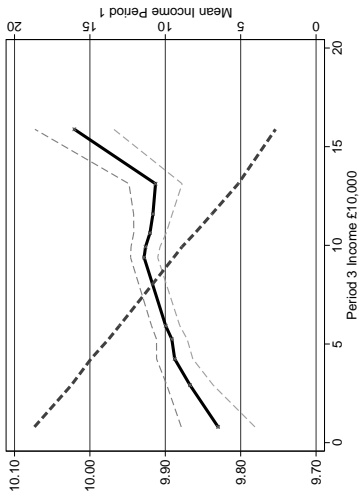
Note: 95% confidence intervals shown. Income in 2000 prices, £ 10,000s. Semi-parametric estimates control for dummies for paternal education interacted with age and maternal education interacted with age, paternal income profile, gender and child year of birth.

dii) I2=9.56, PI=24.18



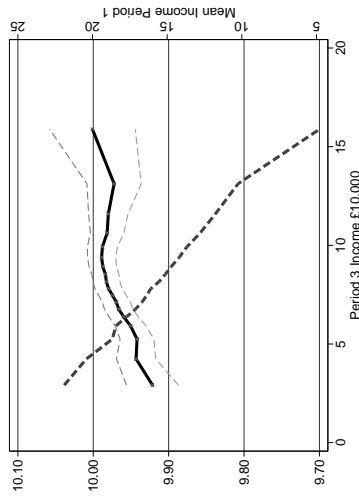
$\alpha_1 = 0.06 (0.02)$   $\alpha_2 = 0.02 (0.02)$

eii) I2=9.56, PI=28.24



$\alpha_1 = 0.09 (0.02)$   $\alpha_2 = -0.02 (0.02)$

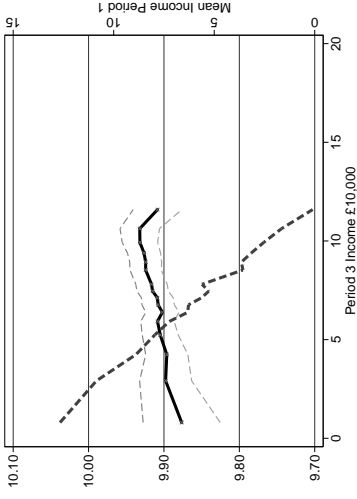
fi) I2=9.56, PI=32.93



$\alpha_1 = 0.05 (0.02)$   $\alpha_2 = 0.01 (0.02)$

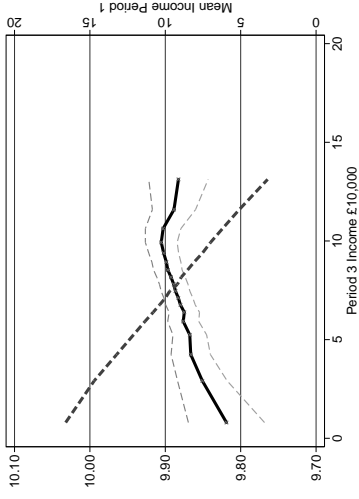
$\alpha_1 = 0.011 (0.02)$   $\alpha_2 = -0.01 (0.03)$

diii) I2=11.26, PI=24.18



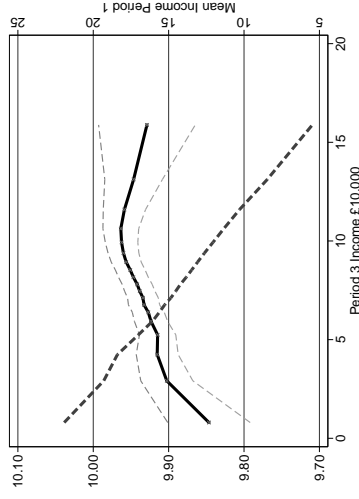
$\alpha_1 = 0.04 (0.02)$   $\alpha_2 = -0.01 (0.02)$

eiii) I2=11.26, PI=28.24



$\alpha_1 = 0.09 (0.02)$   $\alpha_2 = -0.02 (0.02)$

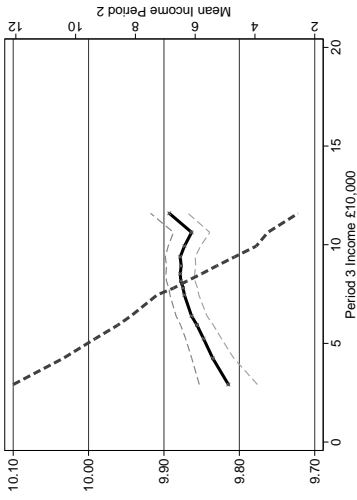
fii) I2=11.26, PI=32.93



$\alpha_1 = 0.011 (0.02)$   $\alpha_2 = -0.01 (0.03)$

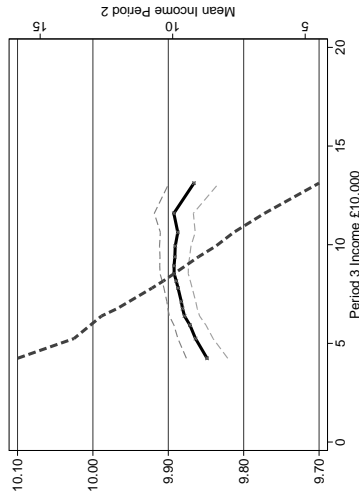
Figure A5: Semi-parametric Estimates. Dependent Variable is Log Earnings Age 30. Paternal Income 12-17.

gi)  $\text{II}=10.91, \text{PI}=24.18$



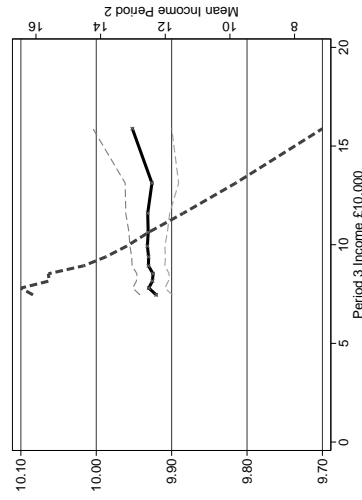
$\alpha_1 = 0.06 (0.02) \alpha_2 = 0.00 (0.01)$

hi)  $\text{II}=10.91, \text{PI}=28.24$



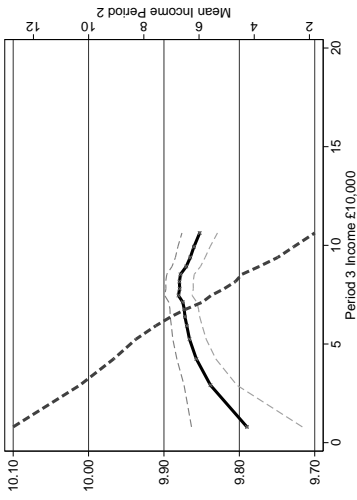
$\alpha_1 = 0.03 (0.01) \alpha_2 = -0.03 (0.02)$

ji)  $\text{II}=10.91, \text{PI}=32.93$



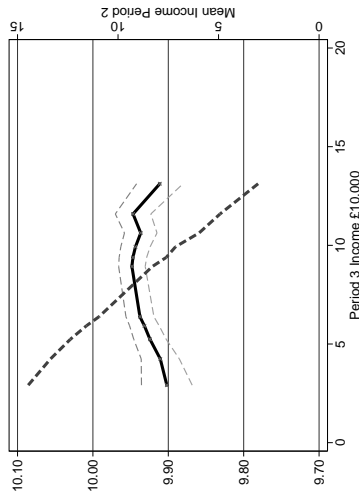
$\alpha_1 = 0.00 (0.01) \alpha_2 = 0.02 (0.02)$

gii)  $\text{II}=13.02, \text{PI}=24.18$



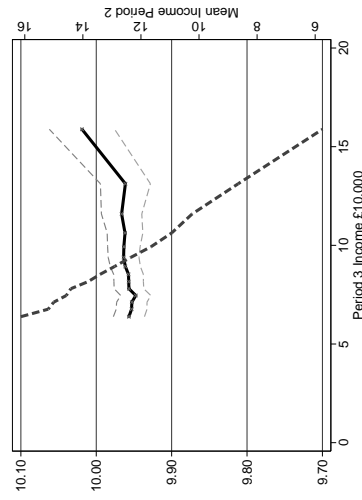
$\alpha_1 = 0.05 (0.02) \alpha_2 = -0.03 (0.01)$

hii)  $\text{II}=13.02, \text{PI}=28.24$



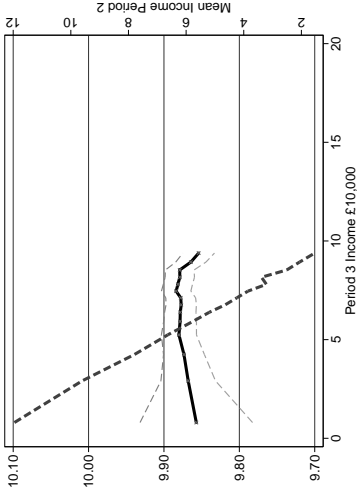
$\alpha_1 = 0.06 (0.02) \alpha_2 = -0.03 (0.01)$

jii)  $\text{II}=13.02, \text{PI}=32.93$



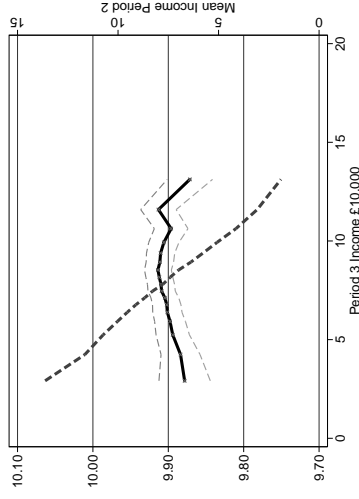
$\alpha_1 = 0.00 (0.01) \alpha_2 = 0.05 (0.02)$

giii)  $\text{II}=15.64, \text{PI}=24.18$



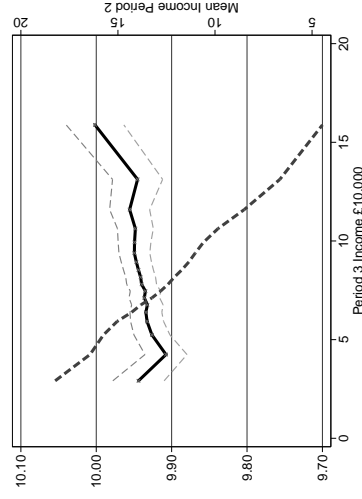
$\alpha_1 = 0.08 (0.03) \alpha_2 = -0.05 (0.01)$

7hiii)  $\text{II}=15.64, \text{PI}=28.24$



$\alpha_1 = 0.04 (0.02) \alpha_2 = -0.05 (0.02)$

jiij)  $\text{II}=15.64, \text{PI}=32.93$

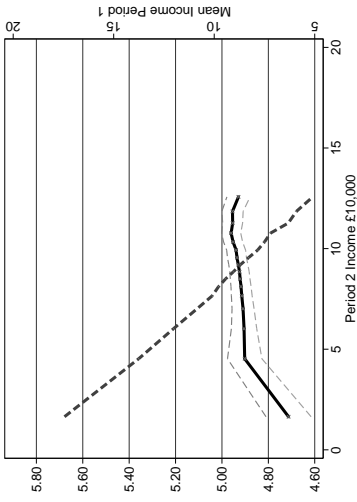


$\alpha_1 = 0.05 (0.02) \alpha_2 = 0.03 (0.02)$

Note: 95% confidence intervals shown. Income in 2000 prices, £ 10,000s. Semi-parametric estimates control for dummies for paternal education interacted with age and maternal education interacted with age, paternal income profile, gender and child year of birth.

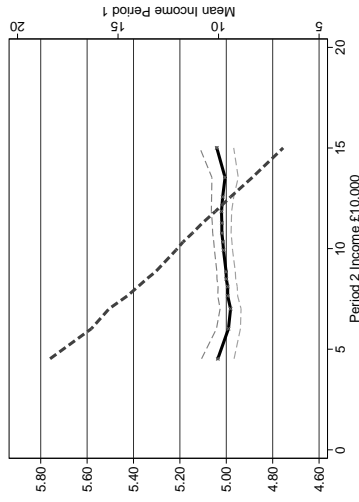
Figure A6: Semi-parametric Estimates. Dependent Variable is IQ. Paternal Income 6-11.

ai) I3=6.34, PI=24.18



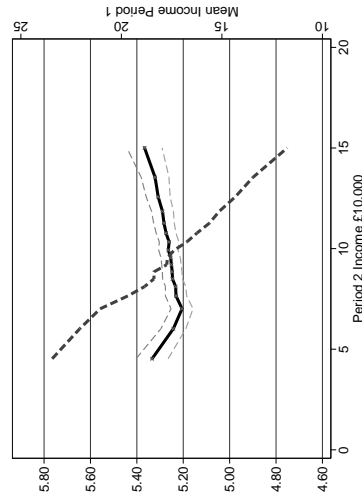
$\alpha_1 = 0.22$  (0.04)  $\alpha_2 = 0.01$  (0.03)

bi) I3=6.34, PI=28.24



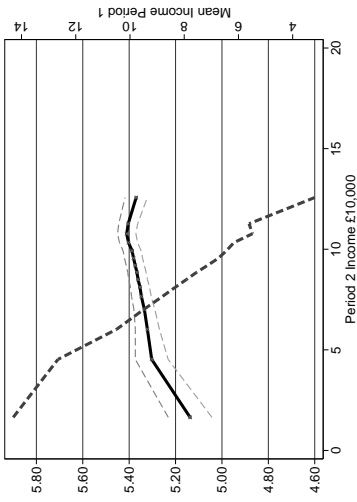
$\alpha_1 = -0.01$  (0.03)  $\alpha_2 = -0.00$  (0.03)

ci) I3=6.34, PI=32.93



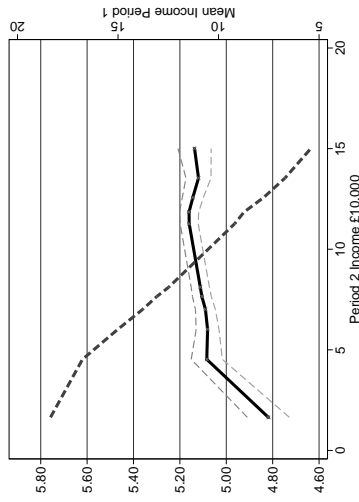
$\alpha_1 = -0.04$  (0.03)  $\alpha_2 = 0.12$  (0.04)

aii) I3=7.49, PI=24.18



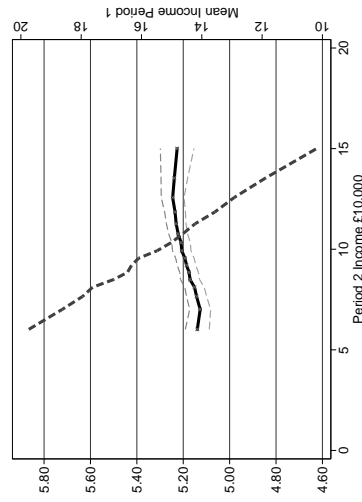
$\alpha_1 = 0.25$  (0.04)  $\alpha_2 = 0.01$  (0.03)

bii) I3=7.49, PI=28.24



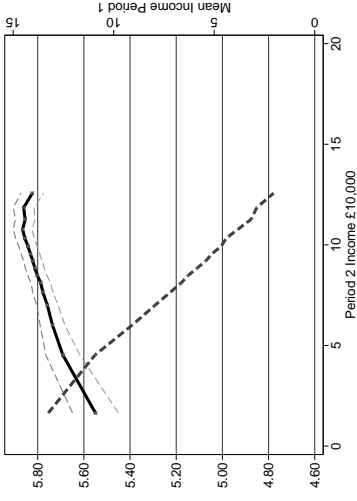
$\alpha_1 = 0.08$  (0.03)  $\alpha_2 = 0.00$  (0.03)

cii) I3=7.49, PI=32.93



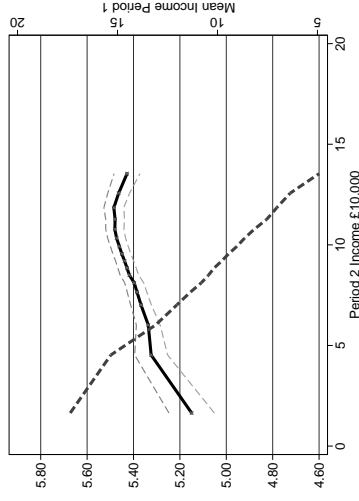
$\alpha_1 = 0.06$  (0.03)  $\alpha_2 = 0.07$  (0.03)

aiii) I3=9.32, PI=24.18



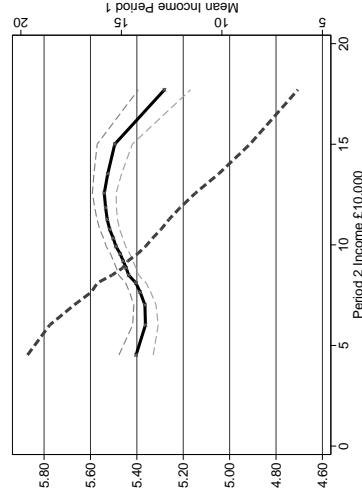
$\alpha_1 = 0.28$  (0.04)  $\alpha_2 = 0.02$  (0.03)

biii) I3=9.32, PI=28.24



$\alpha_1 = 0.30$  (0.04)  $\alpha_2 = -0.01$  (0.03)

ciii) I3=9.32, PI=32.93

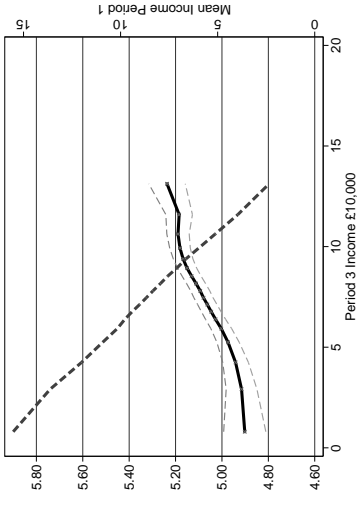


$\alpha_1 = 0.09$  (0.04)  $\alpha_2 = -0.12$  (0.05)

Note: 95% confidence intervals shown. Income in 2000 prices, £ 10,000s. Semi-parametric estimates control for dummies for paternal education interacted with age and maternal education interacted with age, paternal income profile, gender and child year of birth.

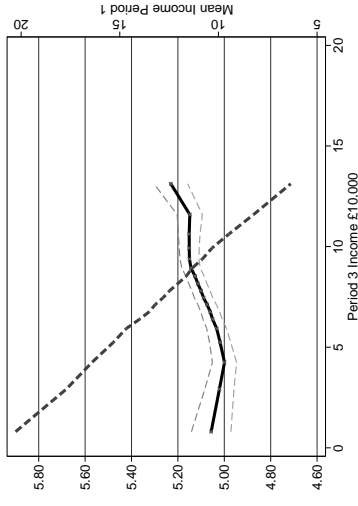
Figure A6: Semi-parametric Estimates. Dependent Variable is IQ Paternal Income 12-17.

di) I2=8.13, PI=24.18



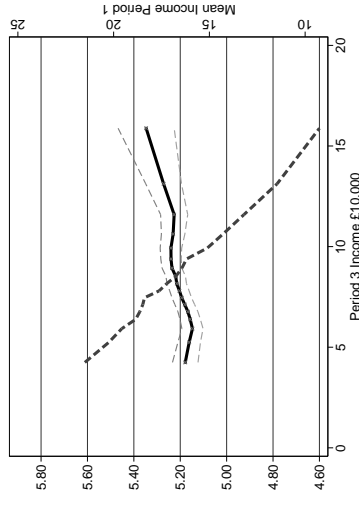
$\alpha_1 = 0.18$  (0.04)  $\alpha_2 = 0.33$  (0.06)

ei) I2=8.13, PI=28.24

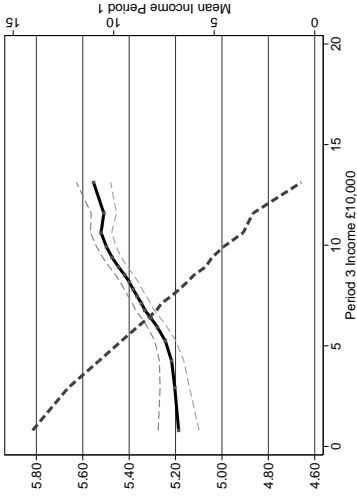


$\alpha_1 = 0.07$  (0.03)  $\alpha_2 = 0.14$  (0.03)

fi) I2=8.13, PI=32.93

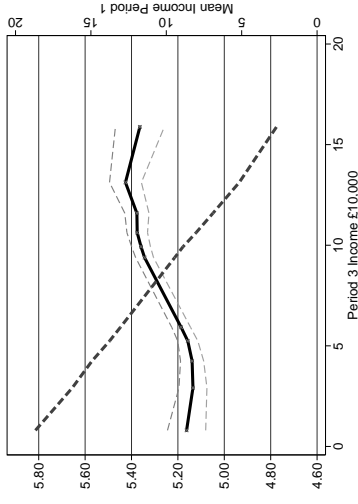


dii) I2=12.39, PI=24.18



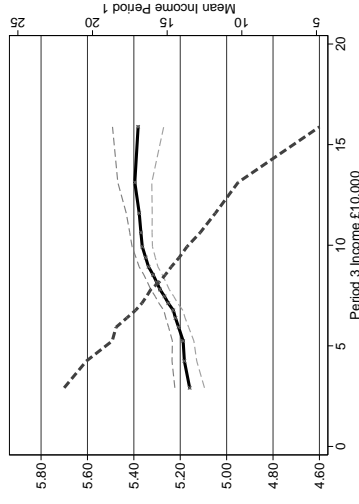
$\alpha_1 = 0.17$  (0.04)  $\alpha_2 = 0.23$  (0.03)

eii) I2=12.39, PI=28.24

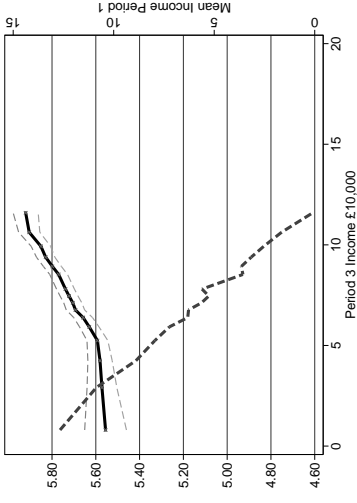


$\alpha_1 = 0.06$  (0.04)  $\alpha_2 = 0.18$  (0.03)

fi) I2=12.39, PI=32.93

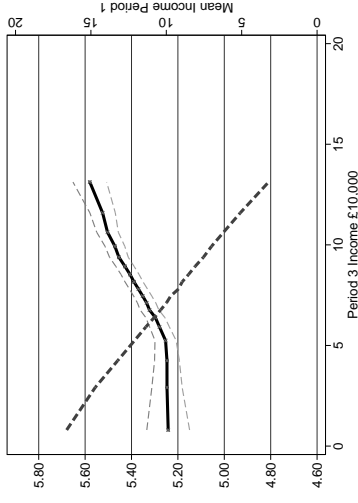


diii) I2=11.26, PI=24.18



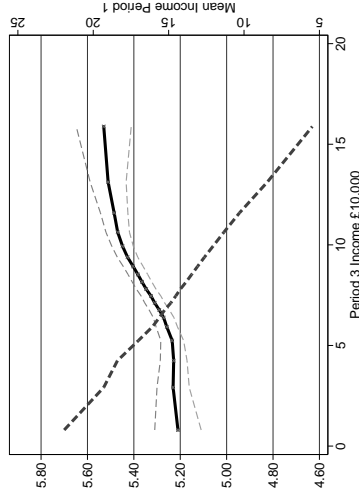
$\alpha_1 = 0.14$  (0.04)  $\alpha_2 = 0.24$  (0.03)

eiii) I2=11.26, PI=28.24



$\alpha_1 = 0.12$  (0.04)  $\alpha_2 = 0.23$  (0.03)

fiii) I2=11.26, PI=32.93

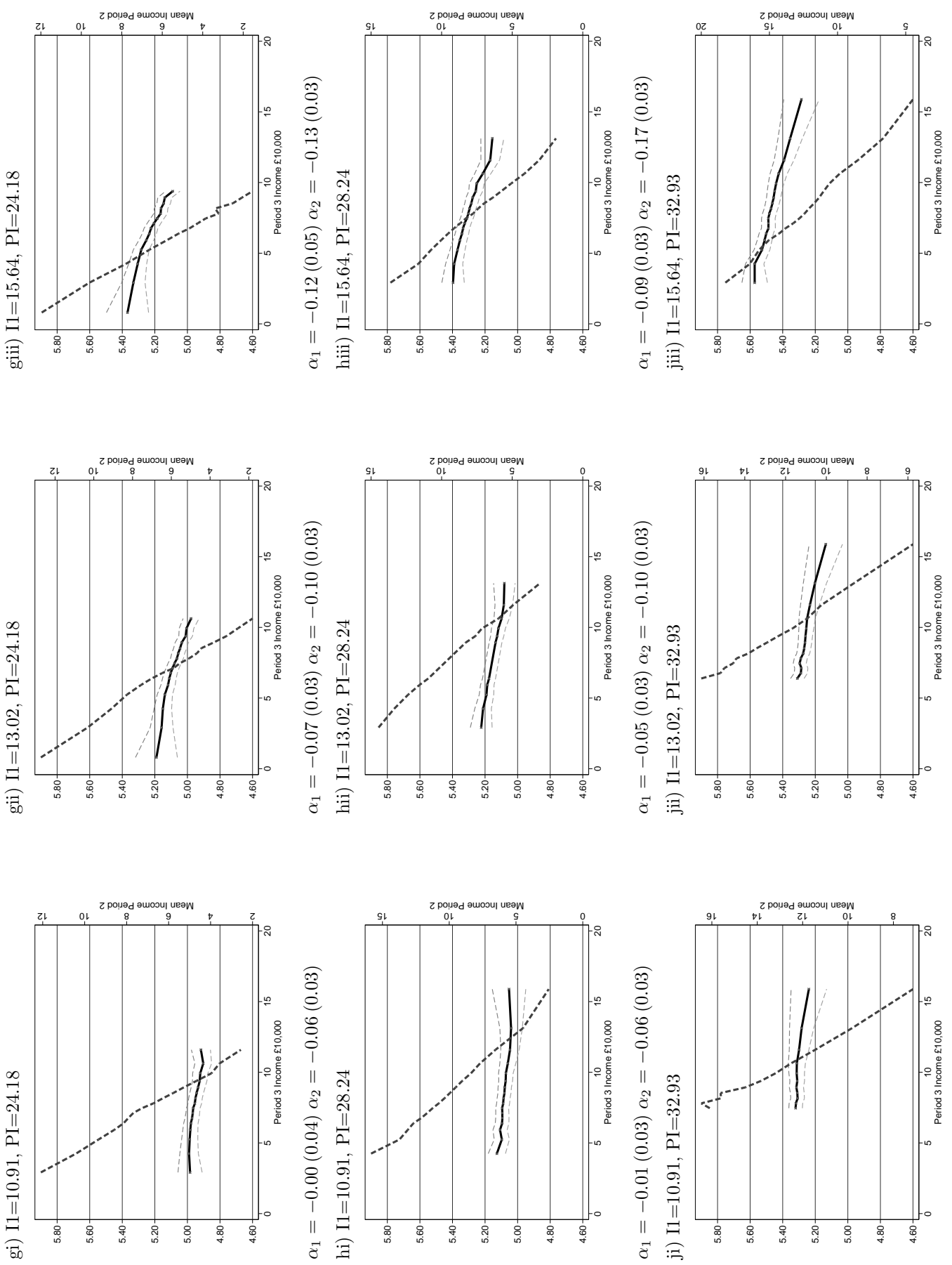


$\alpha_1 = -0.05$  (0.04)  $\alpha_2 = 0.19$  (0.05)

$\alpha_1 = 0.15$  (0.05)  $\alpha_2 = 0.19$  (0.05)

Note: 95% confidence intervals shown. Income in 2000 prices, £ 10,000s. Semi-parametric estimates control for dummies for paternal education interacted with age and maternal education interacted with age, paternal income profile, gender and child year of birth.

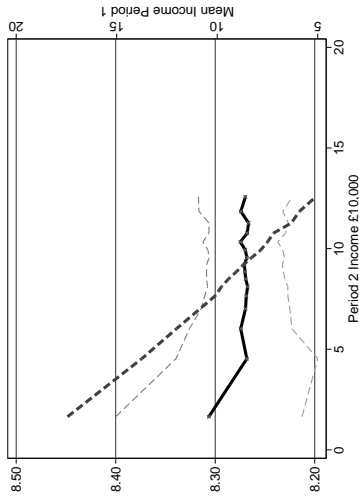
Figure A6: Semi-parametric Estimates. Dependent Variable is IQ. Paternal Income 12-17.



$\alpha_1 = -0.01 (0.03) \alpha_2 = -0.10 (0.05)$   $\alpha_1 = -0.06 (0.04) \alpha_2 = -0.23 (0.05)$   
 Note: 95% confidence intervals shown. Income in 2000 prices, £ 10,000s. Semi-parametric estimates control for dummies for paternal education interacted with age and maternal education interacted with age, paternal income profile, gender and child year of birth.

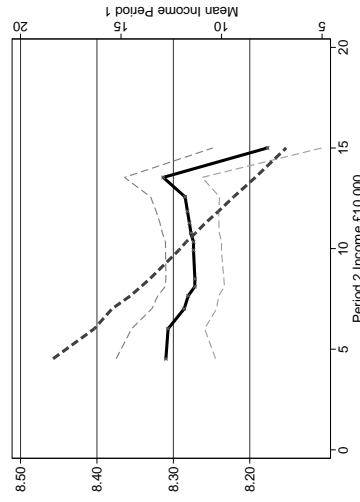
Figure A7: Semi-parametric Estimates. Dependent Variable is Health. Paternal Income 6-11.

ai) I3=6.34, PI=24.18



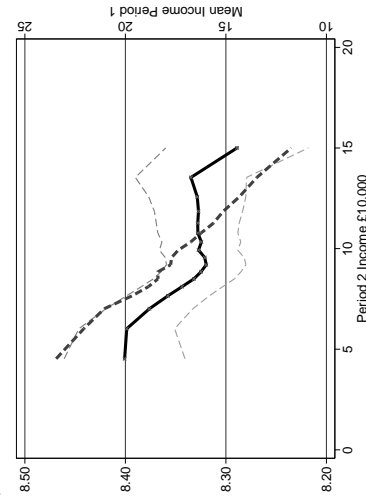
$\alpha_1 = -0.03 (0.04) \alpha_2 = 0.02 (0.02)$

bi) I3=6.34, PI=28.24

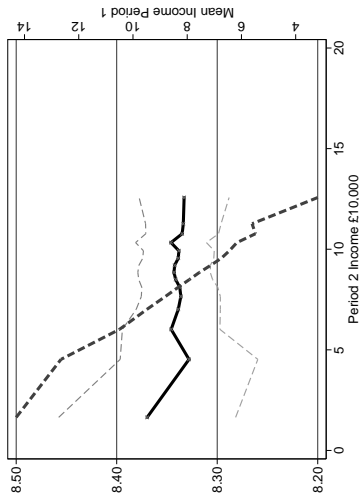


$\alpha_1 = -0.04 (0.03) \alpha_2 = 0.05 (0.03)$

ci) I3=6.34, PI=32.93

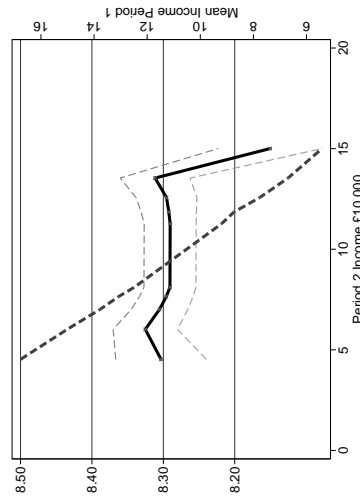


aii) I3=7.49, PI=24.18



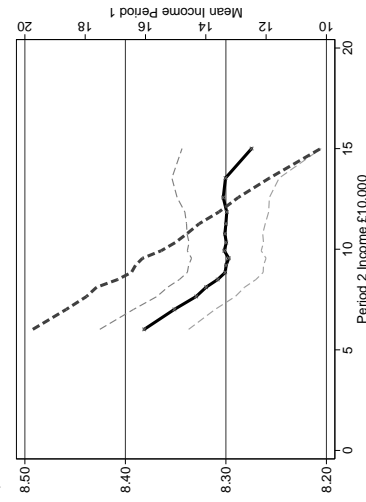
$\alpha_1 = 0.01 (0.04) \alpha_2 = 0.00 (0.02)$

bii) I3=7.49, PI=28.24

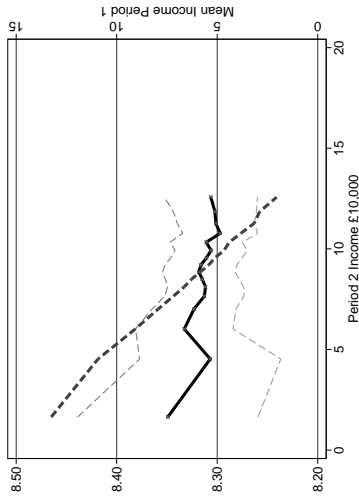


$\alpha_1 = -0.02 (0.03) \alpha_2 = -0.08 (0.03)$

cii) I3=7.49, PI=32.93

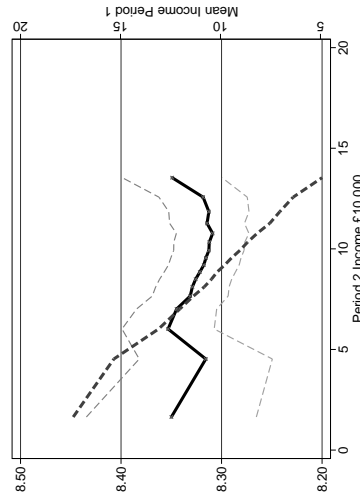


aiii) I3=9.32, PI=24.18



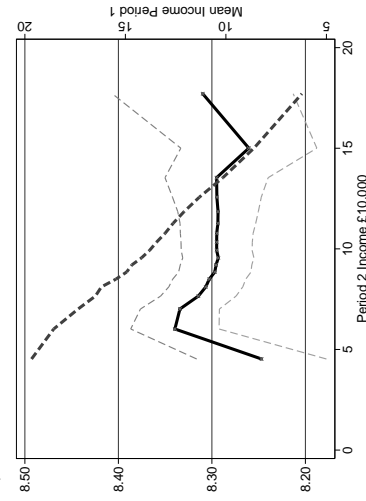
$\alpha_1 = -0.03 (0.04) \alpha_2 = 0.00 (0.02)$

biii) I3=9.32, PI=28.24



$\alpha_1 = -0.02 (0.04) \alpha_2 = 0.02 (0.03)$

ciii) I3=9.32, PI=32.93



$\alpha_1 = -0.09 (0.03) \alpha_2 = -0.01 (0.03)$

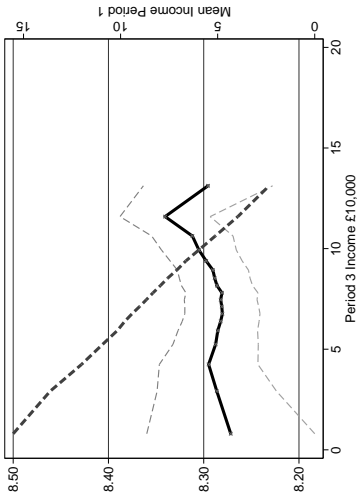
$\alpha_1 = -0.08 (0.02) \alpha_2 = -0.01 (0.03)$

$\alpha_1 = 0.00 (0.03) \alpha_2 = 0.05 (0.04)$

Note: 95% confidence intervals shown. Income in 2000 prices, £ 10,000s. Semi-parametric estimates control for dummies for paternal education interacted with age and maternal education interacted with age, paternal income profile, gender and child year of birth.

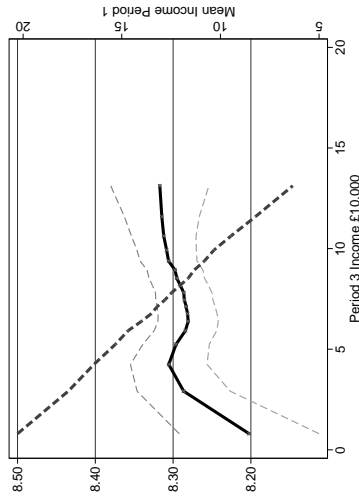
Figure A7: Semi-parametric Estimates. Dependent Variable is Health. Paternal Income 12-17.

di) I2=8.13, PI=24.18



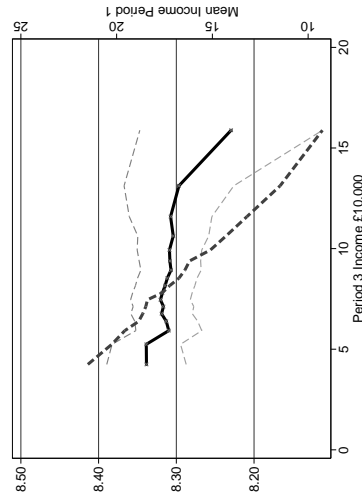
$\alpha_1 = 0.02$  (0.04)  $\alpha_2 = -0.14$  (0.05)

ei) I2=8.13, PI=28.24

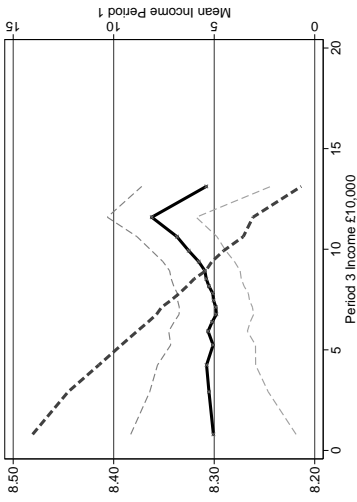


$\alpha_1 = -0.01$  (0.03)  $\alpha_2 = 0.03$  (0.04)

fi) I2=8.13, PI=32.93

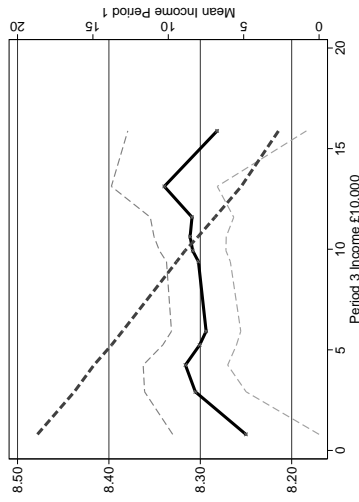


dii) I2=12.39, PI=24.18



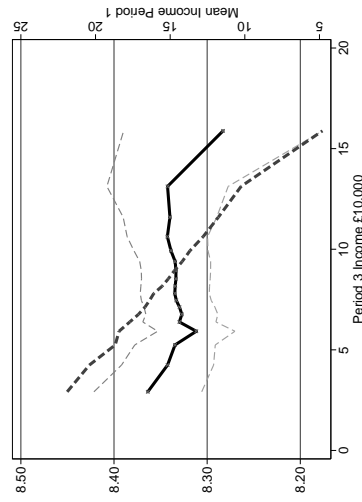
$\alpha_1 = 0.01$  (0.04)  $\alpha_2 = -0.01$  (0.03)

eii) I2=12.39, PI=28.24

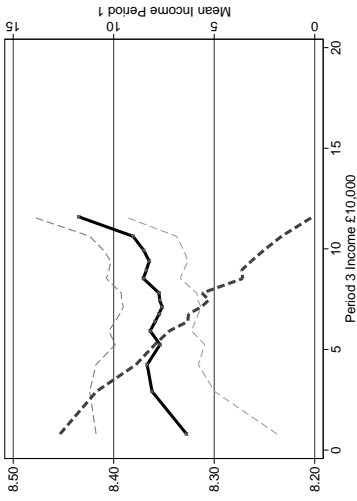


$\alpha_1 = 0.06$  (0.04)  $\alpha_2 = 0.04$  (0.03)

fi) I2=12.39, PI=32.93

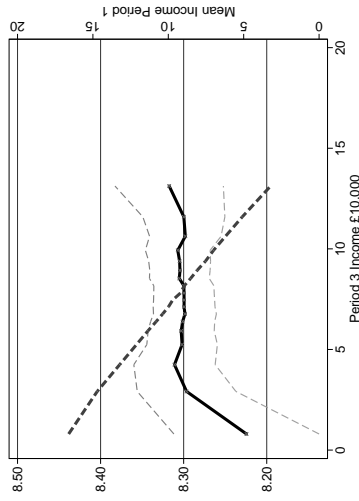


diii) I2=11.26, PI=24.18



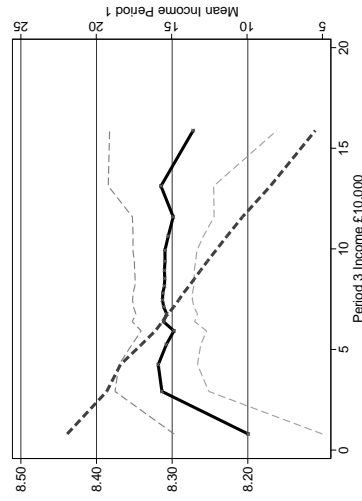
$\alpha_1 = 0.05$  (0.04)  $\alpha_2 = 0.06$  (0.02)

eiii) I2=11.26, PI=28.24



$\alpha_1 = 0.10$  (0.04)  $\alpha_2 = -0.01$  (0.03)

fii) I2=11.26, PI=32.93



$\alpha_1 = 0.22$  (0.05)  $\alpha_2 = -0.08$  (0.05)

$\alpha_1 = -0.05$  (0.03)  $\alpha_2 = -0.06$  (0.06)

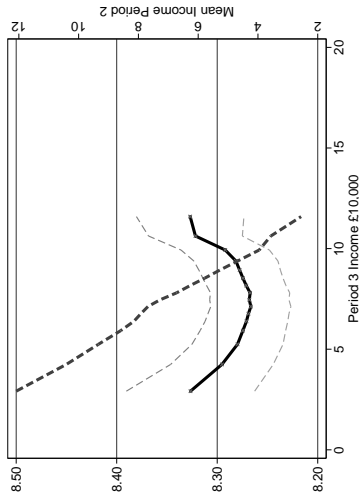
$\alpha_1 = 0.14$  (0.05)  $\alpha_2 = -0.07$  (0.05)

Note: 95% confidence intervals shown. Income in 2000 prices, £ 10,000s. Semi-parametric estimates control for dummies for paternal education interacted with age and maternal education interacted with age, paternal income profile, gender and child year of birth.



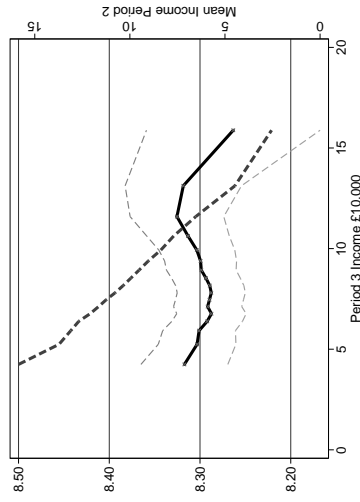
Figure A7: Semi-parametric Estimates. Dependent Variable is Health. Paternal Income 12-17.

gi)  $\text{II}=10.91, \text{PI}=24.18$



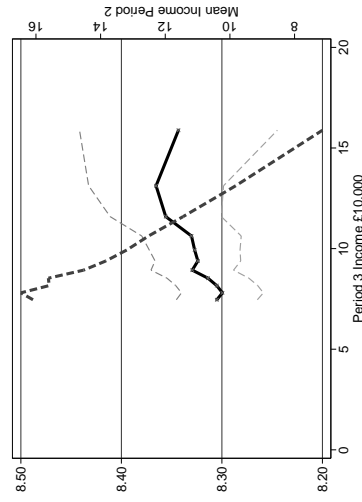
$\alpha_1 = -0.07 (0.03) \alpha_2 = 0.09 (0.03)$

hi)  $\text{II}=10.91, \text{PI}=28.24$



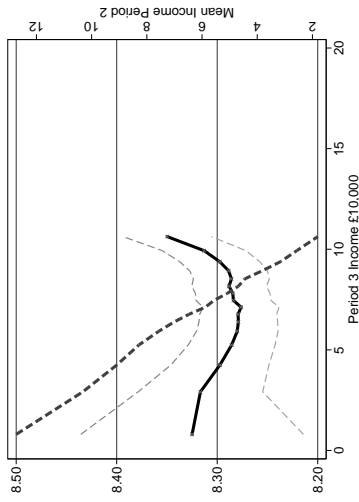
$\alpha_1 = -0.01 (0.02) \alpha_2 = 0.04 (0.03)$

ji)  $\text{II}=10.91, \text{PI}=32.93$



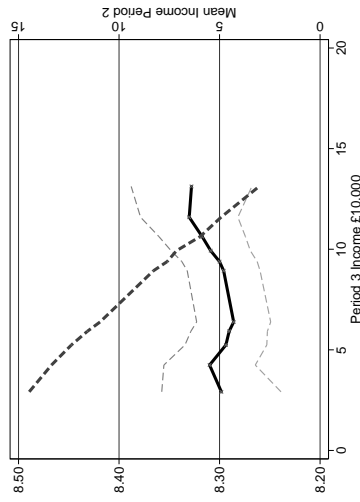
$\alpha_1 = 0.03 (0.02) \alpha_2 = 0.02 (0.04)$

gii)  $\text{II}=13.02, \text{PI}=24.18$



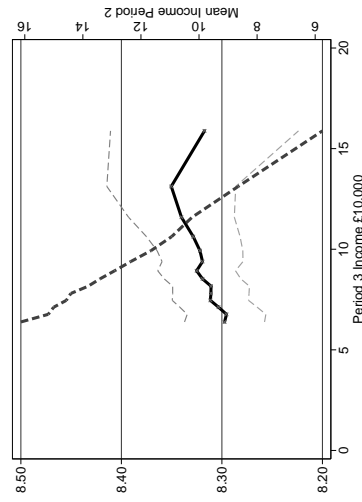
$\alpha_1 = -0.04 (0.03) \alpha_2 = 0.07 (0.02)$

hii)  $\text{II}=13.02, \text{PI}=28.24$



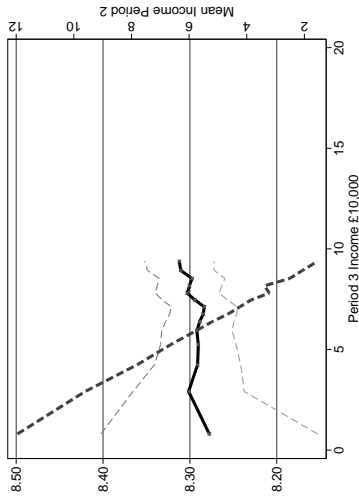
$\alpha_1 = -0.03 (0.03) \alpha_2 = 0.06 (0.03)$

jii)  $\text{II}=13.02, \text{PI}=32.93$



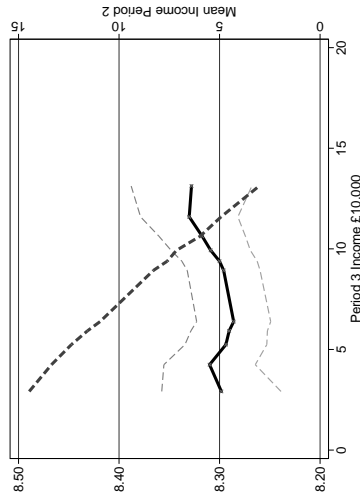
$\alpha_1 = 0.02 (0.02) \alpha_2 = 0.01 (0.04)$

giii)  $\text{II}=15.64, \text{PI}=24.18$



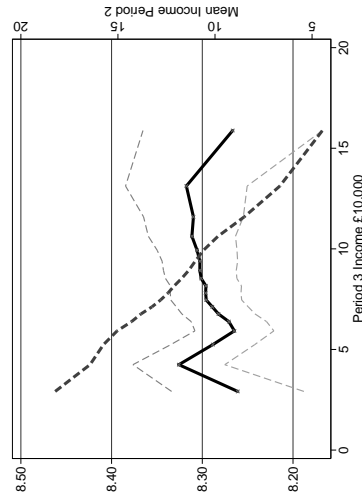
$\alpha_1 = 0.04 (0.05) \alpha_2 = 0.05 (0.02)$

hiii)  $\text{II}=15.64, \text{PI}=28.24$



$\alpha_1 = 0.00 (0.03) \alpha_2 = 0.06 (0.03)$

jiij)  $\text{II}=15.64, \text{PI}=32.93$

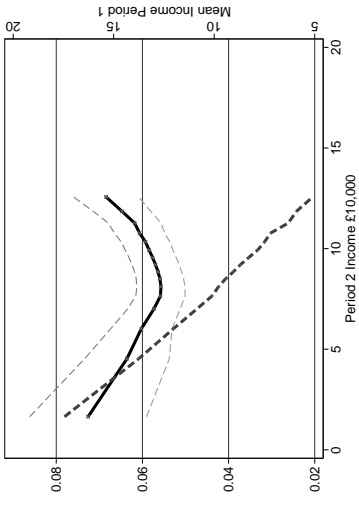


$\alpha_1 = 0.00 (0.03) \alpha_2 = -0.01 (0.04)$

Note: 95% confidence intervals shown. Income in 2000 prices, £ 10,000s. Semi-parametric estimates control for dummies for paternal education interacted with age and maternal education interacted with age, paternal income profile, gender and child year of birth.

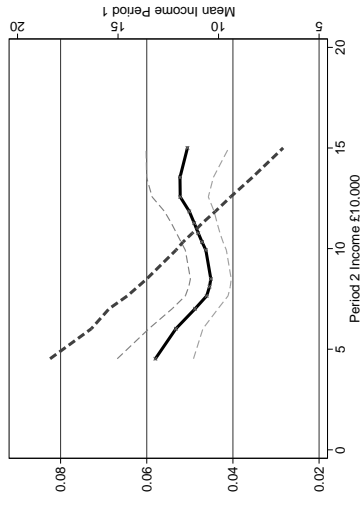
Figure A8: Semi-parametric Estimates. Dependent Variable is Teen Pregnancy. Paternal Income 6-11.

ai) I3=6.34, PI=24.18



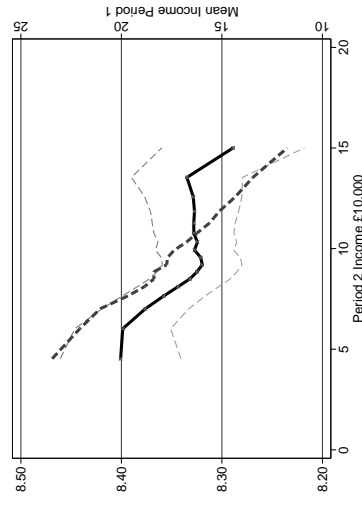
$\alpha_1 = -0.01 (0.01) \alpha_2 = 0.01 (0.00)$

bi) I3=6.34, PI=28.24



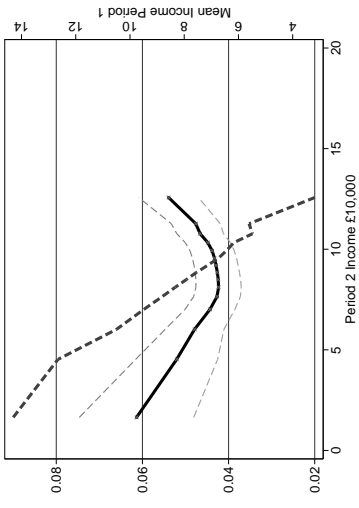
$\alpha_1 = -0.01 (0.00) \alpha_2 = 0.01 (0.00)$

ci) I3=6.34, PI=32.93



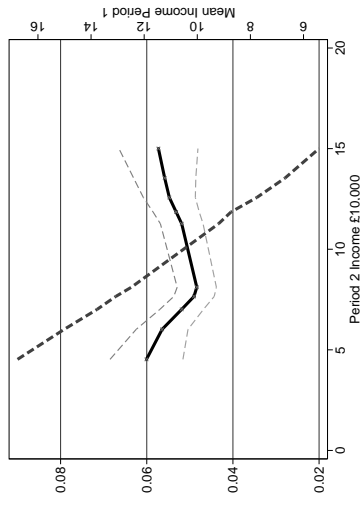
$\alpha_1 = -0.01 (0.00) \alpha_2 = 0.00 (0.00)$

aii) I3=7.49, PI=24.18



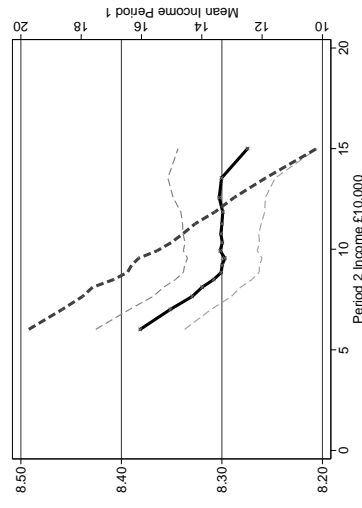
$\alpha_1 = -0.02 (0.01) \alpha_2 = 0.01 (0.00)$

bii) I3=7.49, PI=28.24



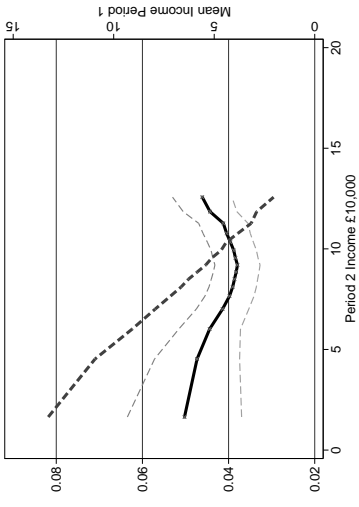
$\alpha_1 = -0.01 (0.00) \alpha_2 = 0.01 (0.00)$

cii) I3=7.49, PI=32.93



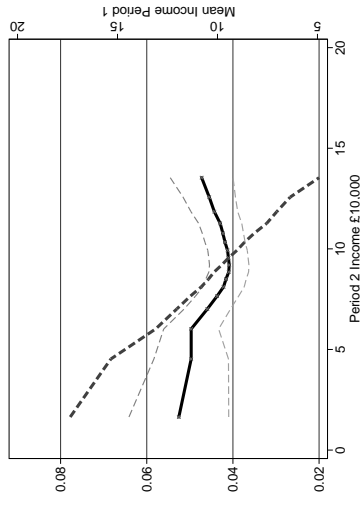
$\alpha_1 = -0.01 (0.00) \alpha_2 = 0.00 (0.00)$

aiii) I3=9.32, PI=24.18



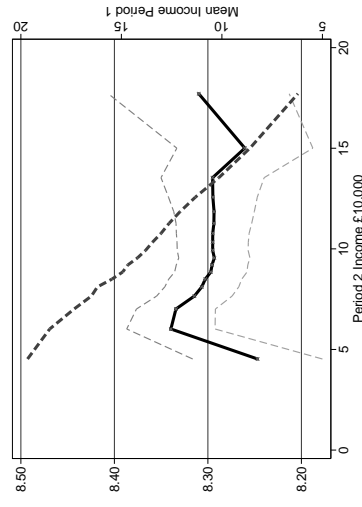
$\alpha_1 = -0.02 (0.01) \alpha_2 = 0.01 (0.00)$

biii) I3=9.32, PI=28.24



$\alpha_1 = -0.02 (0.01) \alpha_2 = 0.01 (0.00)$

ciii) I3=9.32, PI=32.93

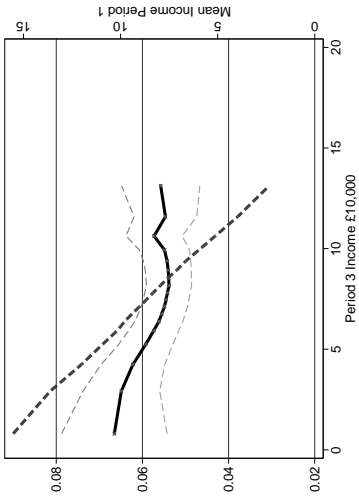


$\alpha_1 = -0.00 (0.00) \alpha_2 = 0.02 (0.01)$

Note: 95% confidence intervals shown. Income in 2000 prices, £ 10,000s. Semi-parametric estimates control for dummies for paternal education interacted with age and maternal education interacted with age, paternal income profile, gender and child year of birth.

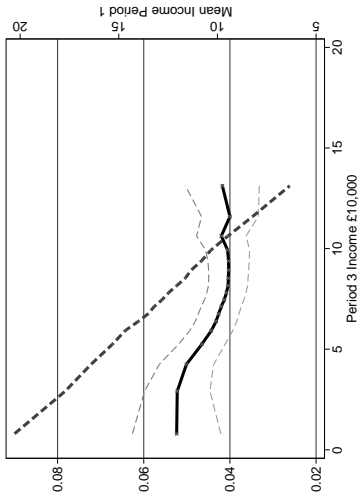
Figure A8: Semi-parametric Estimates. Dependent Variable is Teen Pregnancy. Paternal Income 12-17.

di) I2=8.13, PI=24.18



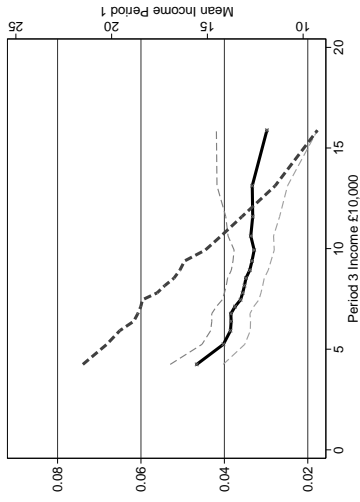
$\alpha_1 = -0.01 (0.01) \alpha_2 = -0.04 (0.04)$

ei) I2=8.13, PI=28.24



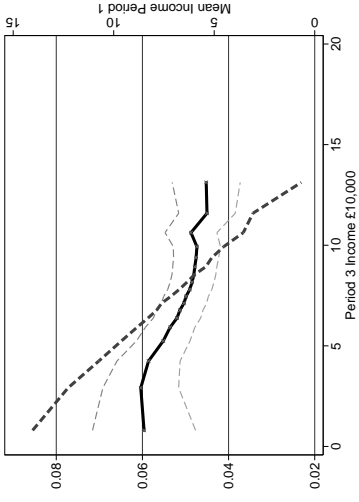
$\alpha_1 = -0.01 (0.00) \alpha_2 = 0.00 (0.00)$

fi) I2=8.13, PI=32.93



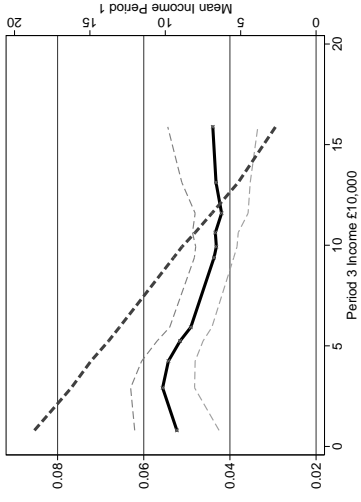
$\alpha_1 = 0.00 (0.00) \alpha_2 = -0.00 (0.01)$

dii) I2=12.39, PI=24.18



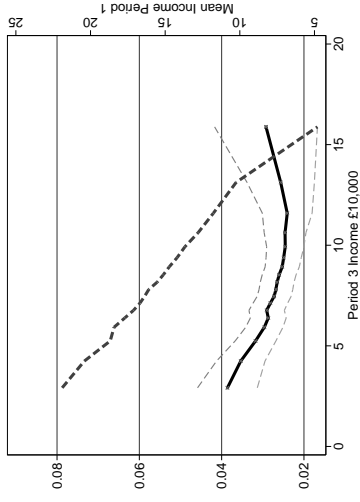
$\alpha_1 = -0.01 (0.01) \alpha_2 = -0.00 (0.00)$

eii) I2=12.39, PI=28.24



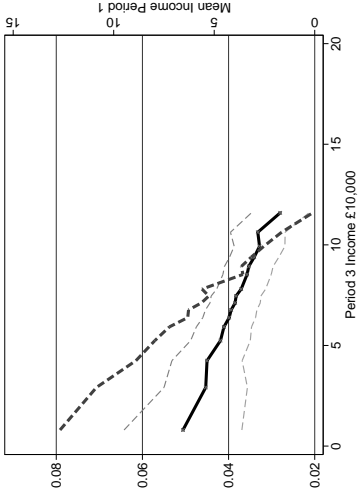
$\alpha_1 = -0.00 (0.00) \alpha_2 = -0.00 (0.00)$

fii) I2=12.39, PI=32.93



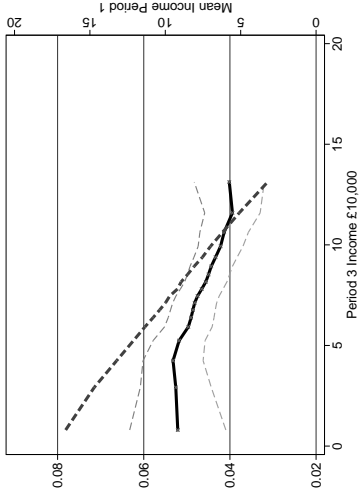
$\alpha_1 = -0.01 (0.00) \alpha_2 = 0.00 (0.01)$

diii) I2=11.26, PI=24.18



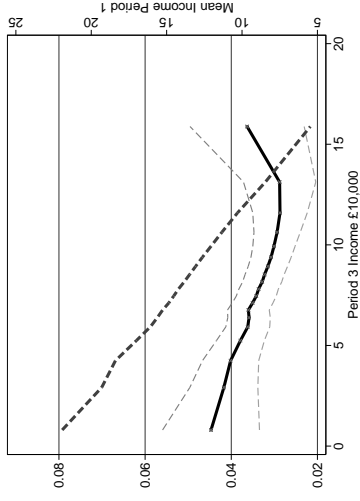
$\alpha_1 = -0.01 (0.01) \alpha_2 = -0.01 (0.00)$

eiii) I2=11.26, PI=28.24



$\alpha_1 = -0.00 (0.00) \alpha_2 = -0.01 (0.00)$

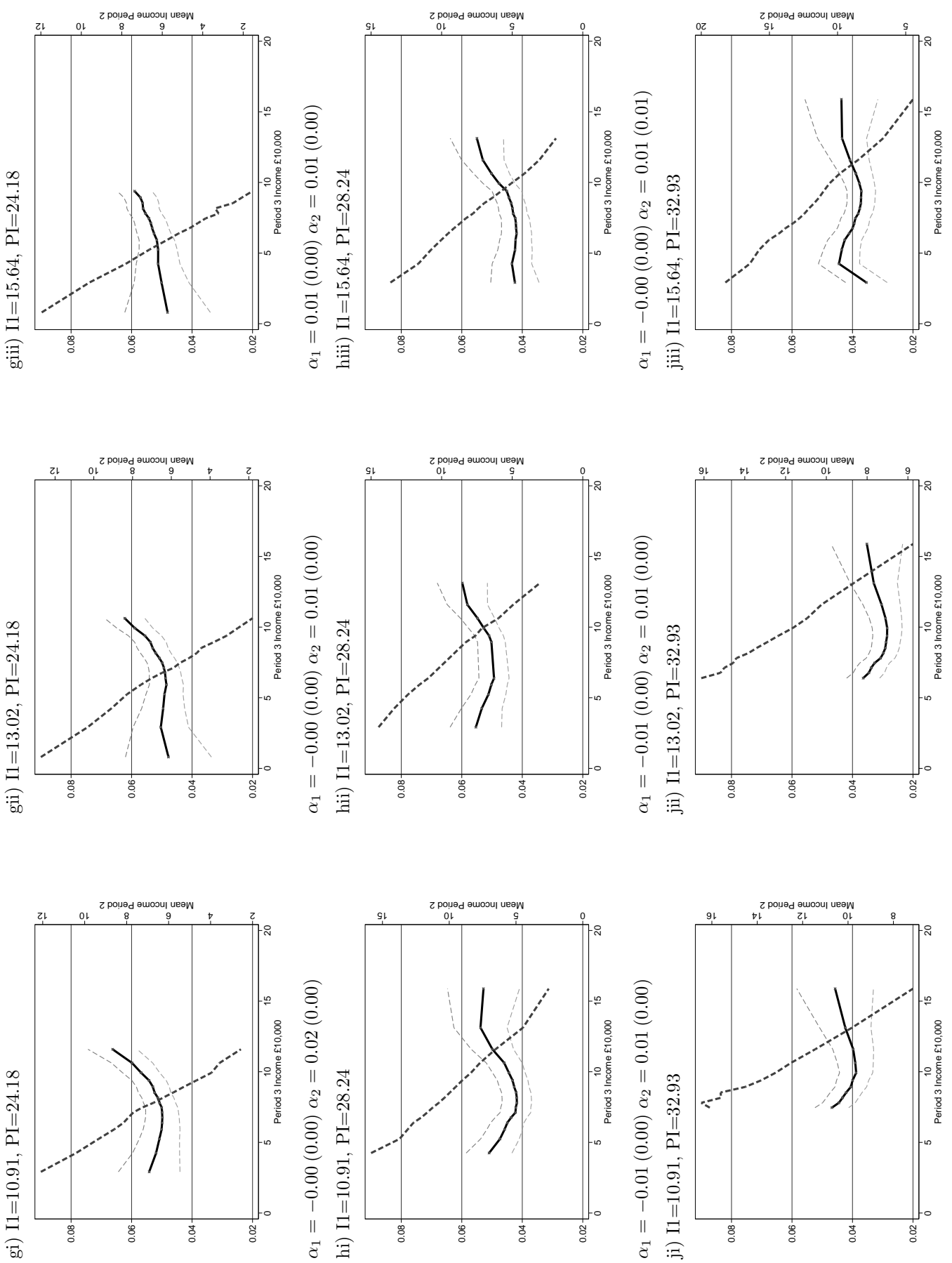
fiii) I2=11.26, PI=32.93



$\alpha_1 = -0.00 (0.00) \alpha_2 = 0.00 (0.01)$

Note: 95% confidence intervals shown. Income in 2000 prices, £ 10,000s. Semi-parametric estimates control for dummies for paternal education interacted with age and maternal education interacted with age, paternal income profile, gender and child year of birth.

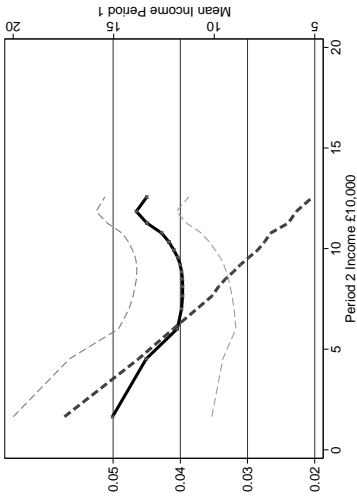
Figure A8: Semi-parametric Estimates. Dependent Variable is Teen Pregnancy. Paternal Income 12-17.



$\alpha_1 = -0.01 (0.00) \alpha_2 = 0.01 (0.00)$   $\alpha_1 = -0.01 (0.00) \alpha_2 = 0.01 (0.01)$   
 Note: 95% confidence intervals shown. Income in 2000 prices, £ 10,000s. Semi-parametric estimates control for dummies for paternal education interacted with age and maternal education interacted with age, paternal income profile, gender and child year of birth.

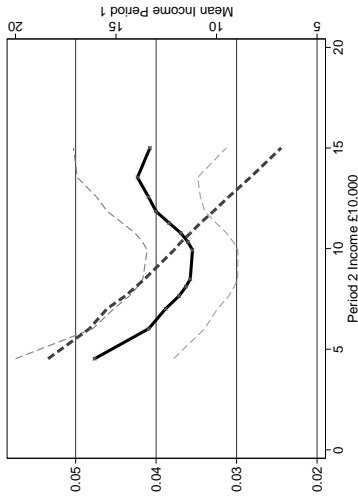
Figure A9: Placebo Test. Dependent Variable is Low-birth weight. Paternal Income 6-11.

ai) I3=6.34, PI=24.18



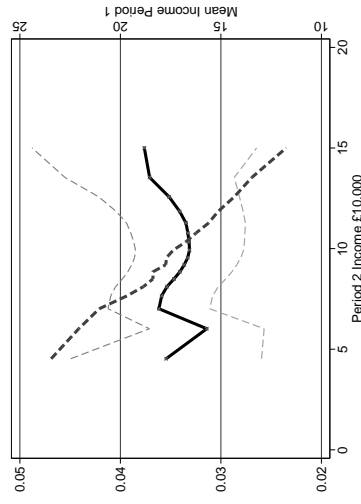
$\alpha_1 = -0.01 (0.01) \alpha_2 = 0.00 (0.00)$

bi) I3=6.34, PI=28.24



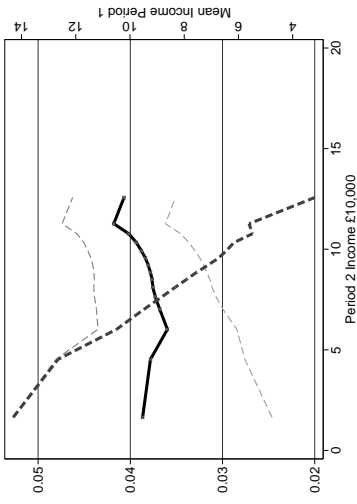
$\alpha_1 = -0.01 (0.00) \alpha_2 = 0.01 (0.00)$

ci) I3=6.34, PI=32.93



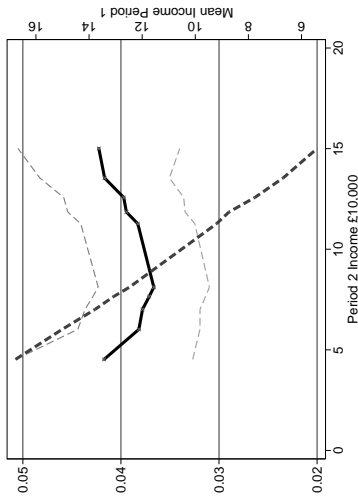
$\alpha_1 = -0.00 (0.00) \alpha_2 = 0.00 (0.00)$

aii) I3=7.49, PI=24.18



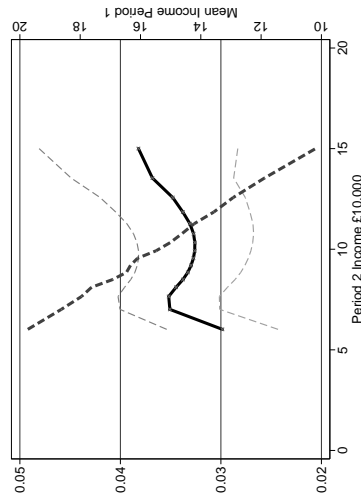
$\alpha_1 = -0.00 (0.01) \alpha_2 = 0.01 (0.00)$

bii) I3=7.49, PI=28.24



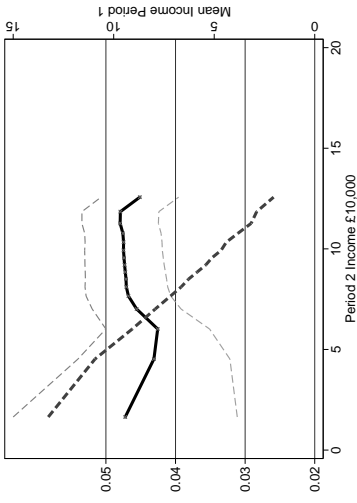
$\alpha_1 = -0.00 (0.00) \alpha_2 = 0.01 (0.00)$

cii) I3=7.49, PI=32.93



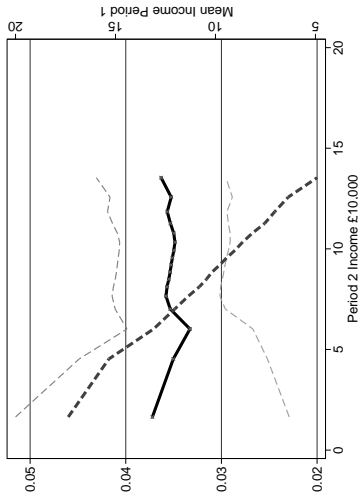
$\alpha_1 = -0.00 (0.00) \alpha_2 = 0.01 (0.00)$

aiii) I3=9.32, PI=24.18



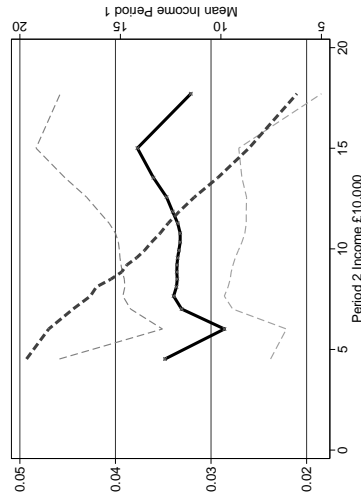
$\alpha_1 = -0.00 (0.01) \alpha_2 = 0.00 (0.00)$

biii) I3=9.32, PI=28.24



$\alpha_1 = -0.00 (0.01) \alpha_2 = 0.00 (0.00)$

ciii) I3=9.32, PI=32.93

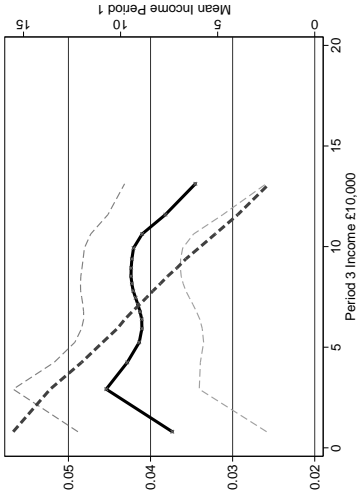


$\alpha_1 = -0.00 (0.00) \alpha_2 = -0.00 (0.01)$

Note: 95% confidence intervals shown. Income in 2000 prices, £ 10,000s. Semi-parametric estimates control for dummies for paternal education interacted with age and maternal education interacted with age, paternal income profile, gender and child year of birth.

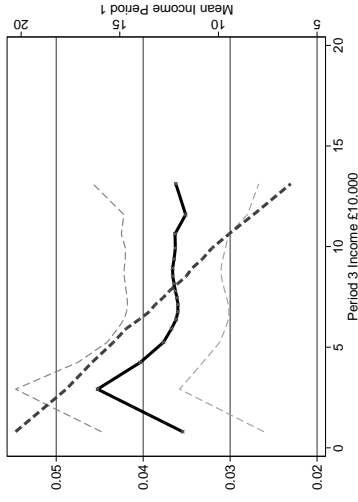
Figure A9: Placebo Test. Dependent Variable is Low-birth weight. Paternal Income 12-17.

di) I2=8.13, PI=24.18



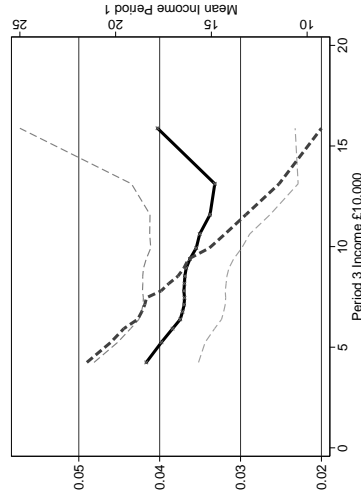
$\alpha_1 = 0.00 (0.00)$   $\alpha_2 = 0.01 (0.01)$

ei) I2=8.13, PI=28.24

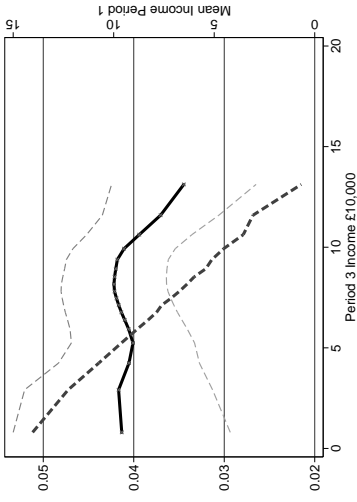


$\alpha_1 = -0.01 (0.00)$   $\alpha_2 = 0.00 (0.00)$

fi) I2=8.13, PI=32.93

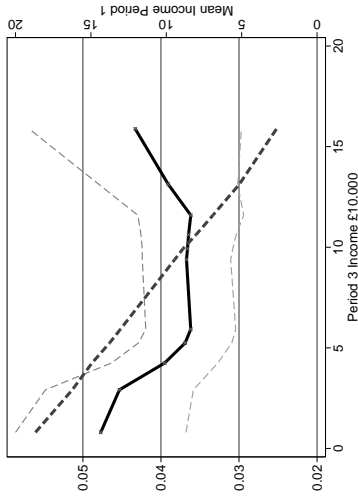


dii) I2=9.56, PI=24.18



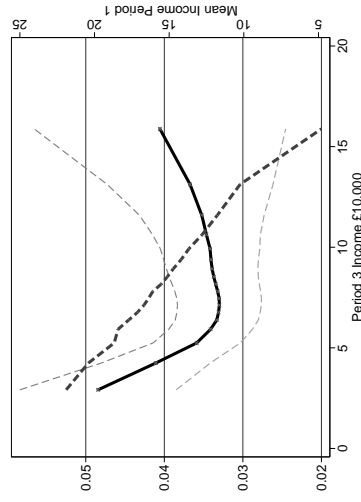
$\alpha_1 = -0.00 (0.00)$   $\alpha_2 = -0.00 (0.00)$

eii) I2=9.56, PI=28.24

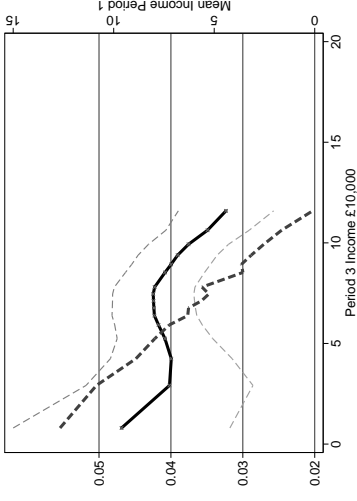


$\alpha_1 = -0.01 (0.00)$   $\alpha_2 = -0.00 (0.00)$

fi) I2=9.56, PI=32.93

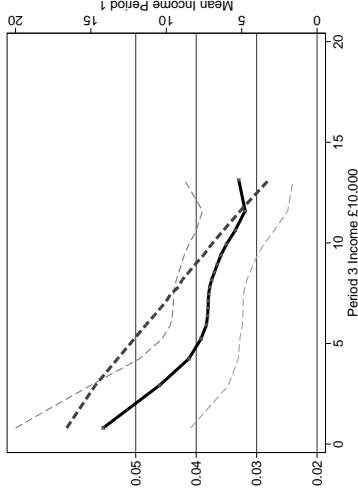


diii) I2=11.26, PI=24.18



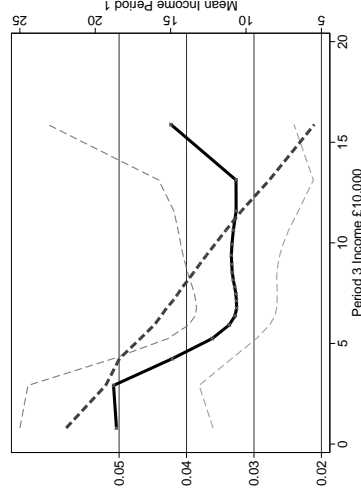
$\alpha_1 = -0.01 (0.01)$   $\alpha_2 = -0.01 (0.00)$

eiii) I2=11.26, PI=28.24



$\alpha_1 = -0.01 (0.01)$   $\alpha_2 = -0.00 (0.00)$

fii) I2=11.26, PI=32.93



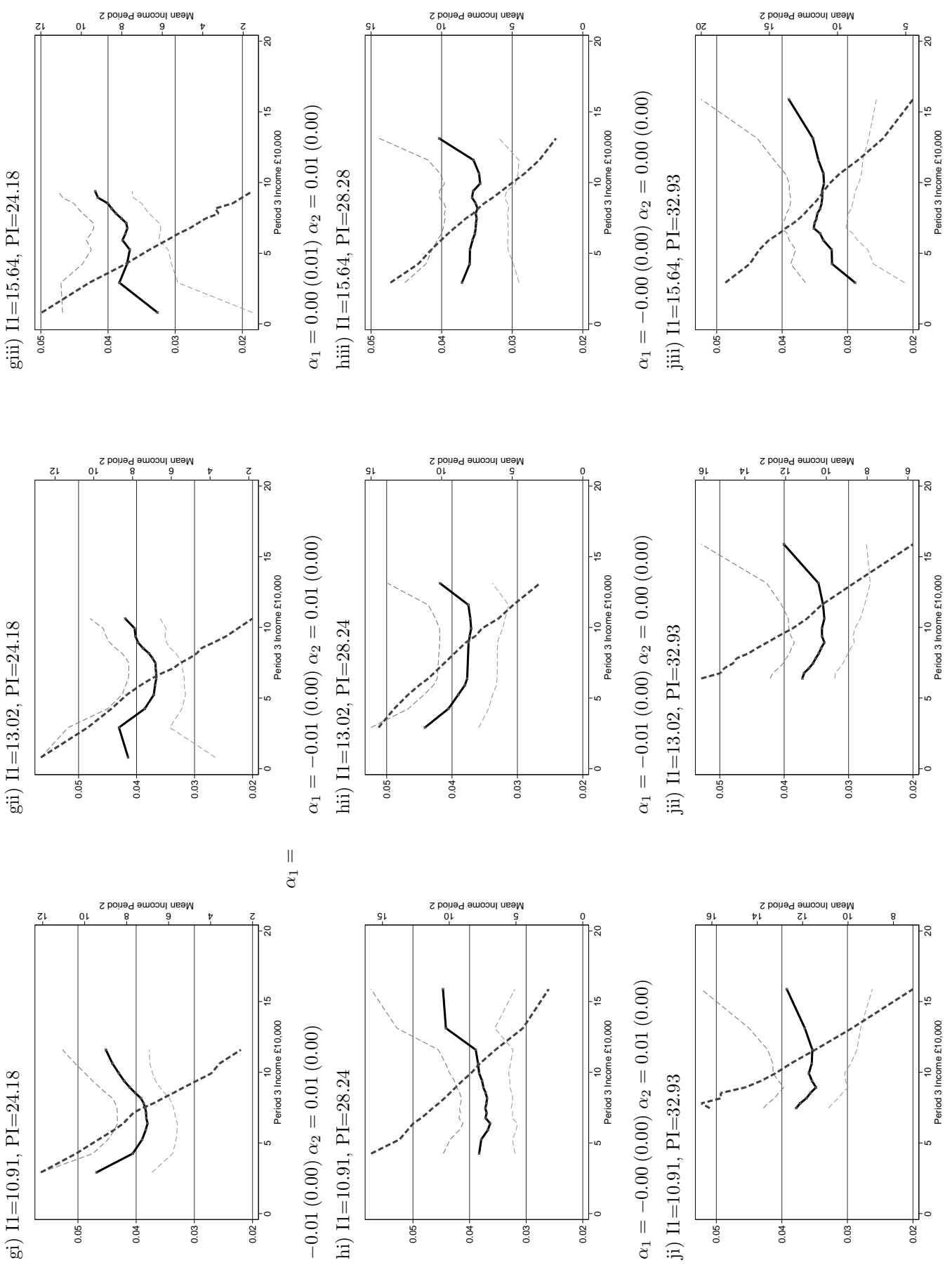
$\alpha_1 = -0.00 (0.00)$   $\alpha_2 = -0.00 (0.01)$

$\alpha_1 = -0.02 (0.00)$   $\alpha_2 = 0.00 (0.01)$

$\alpha_1 = -0.02 (0.01)$   $\alpha_2 = 0.01 (0.01)$

Note: 95% confidence intervals shown. Income in 2000 prices, £ 10,000s. Semi-parametric estimates control for dummies for paternal education interacted with age and maternal education interacted with age, paternal income profile, gender and child year of birth.

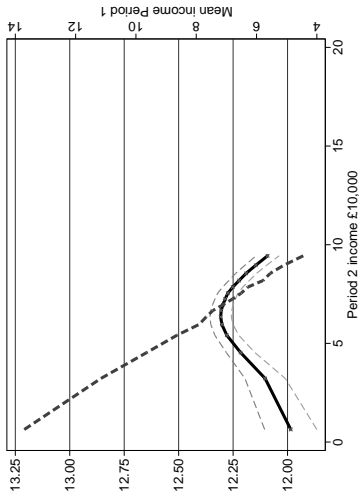
Figure A9: Placebo Test. Dependent Variable is Low-birth weight. Paternal Income 12-17.



$\alpha_1 = -0.00 (0.00) \alpha_2 = 0.00 (0.01)$   $\alpha_1 = 0.01 (0.00) \alpha_2 = 0.01 (0.01)$   
 Note: 95% confidence intervals shown. Income in 2000 prices, £ 10,000s. Semi-parametric estimates control for dummies for paternal education interacted with age and maternal education interacted with age, paternal income profile, gender and child year of birth.

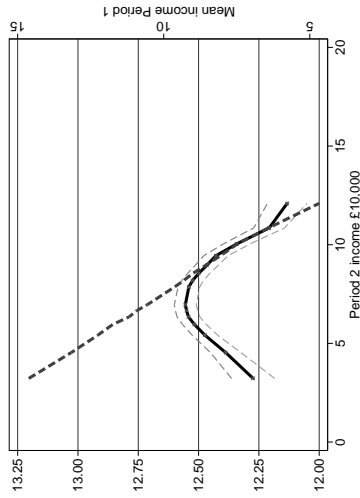
Figure A10: Excluding Early Years (0-2). Dependent Variable is Years of Schooling. Paternal Income 8-12.

ai) I3=6.34, PI=24.18



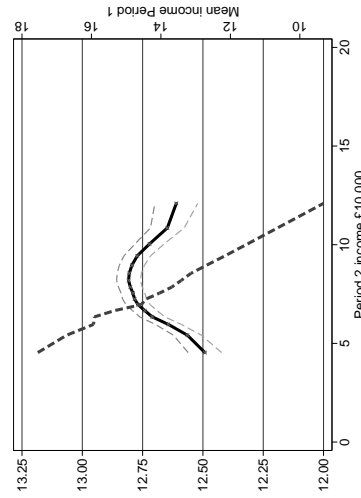
$\alpha_1 = 0.31$  (0.07)  $\alpha_2 = -0.21$  (0.04)

bi) I3=6.34, PI=28.24

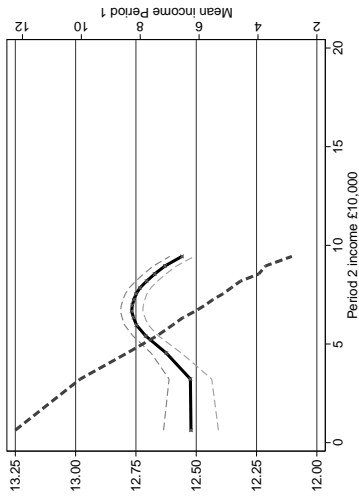


$\alpha_1 = 0.28$  (0.05)  $\alpha_2 = -0.42$  (0.05)

ci) I3=6.34, PI=32.93

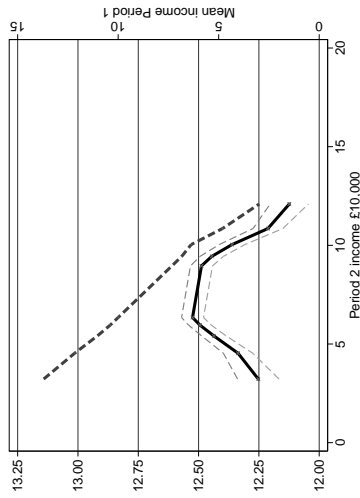


aii) I3=7.49, PI=24.18



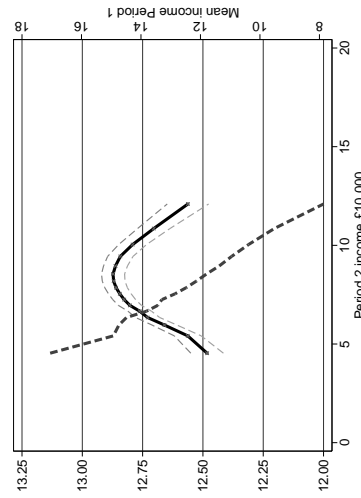
$\alpha_1 = 0.24$  (0.06)  $\alpha_2 = -0.21$  (0.03)

bii) I3=7.49, PI=28.24

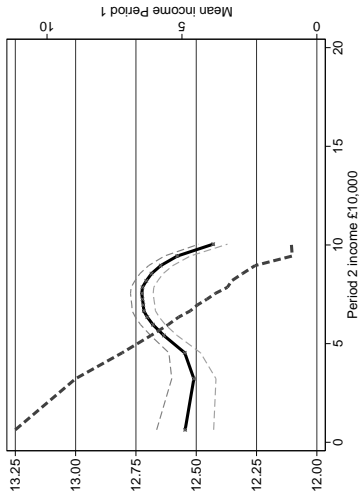


$\alpha_1 = 0.31$  (0.05)  $\alpha_2 = -0.44$  (0.05)

cii) I3=7.49, PI=32.93

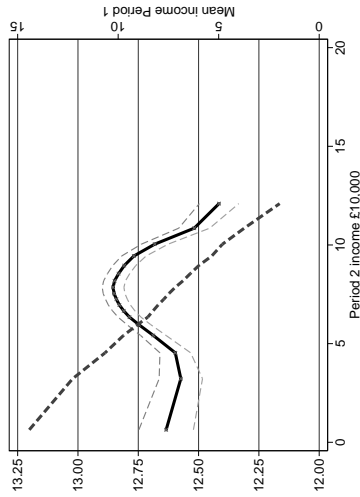


aiii) I3=9.32, PI=24.18



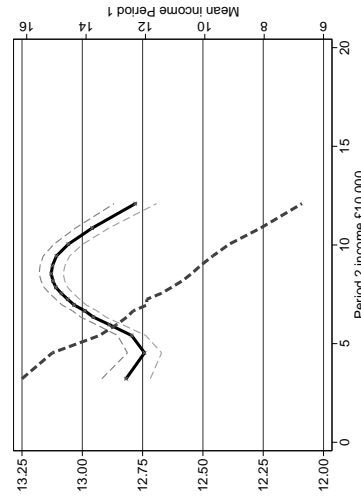
$\alpha_1 = 0.17$  (0.07)  $\alpha_2 = -0.29$  (0.04)

biii) I3=9.32, PI=28.24



$\alpha_1 = 0.21$  (0.06)  $\alpha_2 = -0.43$  (0.05)

ciii) I3=9.32, PI=32.93



$\alpha_1 = 0.78$  (0.06)  $\alpha_2 = -0.18$  (0.04 = 5)

$\alpha_1 = 0.36$  (0.04)  $\alpha_2 = -0.28$  (0.05)

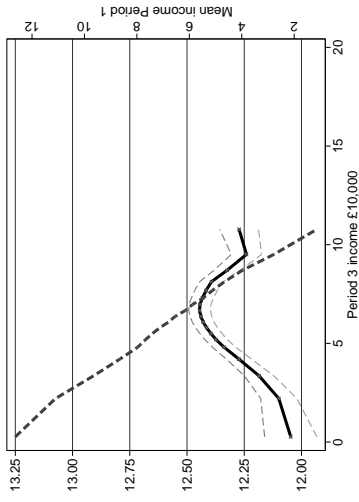
$\alpha_1 = 0.27$  (0.06)  $\alpha_2 = -0.31$  (0.05)

Note: 95% confidence intervals shown. Income in 2000 prices, £ 10,000s. Semi-parametric estimates control for dummies for paternal education interacted with age and maternal education interacted with age, paternal income profile, gender and child year of birth. Period 1 is 3-7, period 2 is 8-12, period 3 is 13-17.



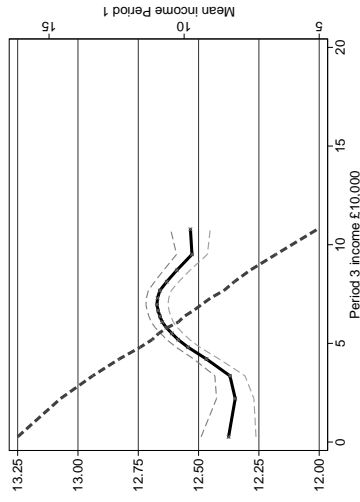
Figure A10: Excluding Early Years (0-2). Dependent Variable is Years of Schooling. Paternal Income 13-17.

di) I2=8.13, PI=24.18



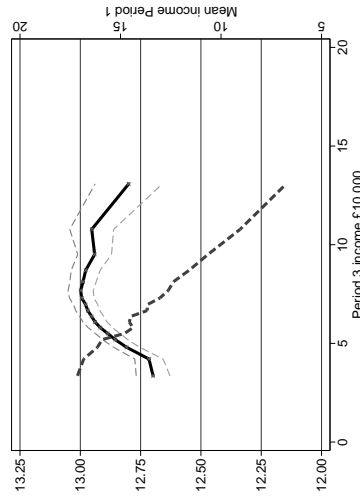
$\alpha_1 = 0.38$  (0.06)  $\alpha_2 = -0.16$  (0.05)

ei) I2=8.13, PI=28.24

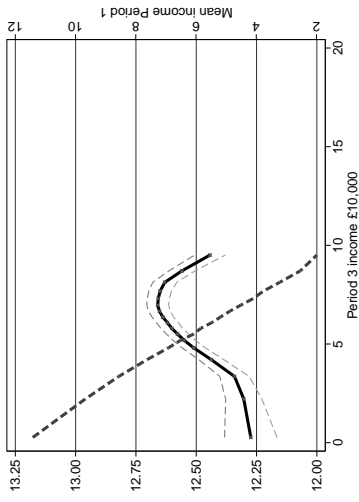


$\alpha_1 = 0.27$  (0.06)  $\alpha_2 = -0.12$  (0.05)

fi) I2=8.13, PI=32.93

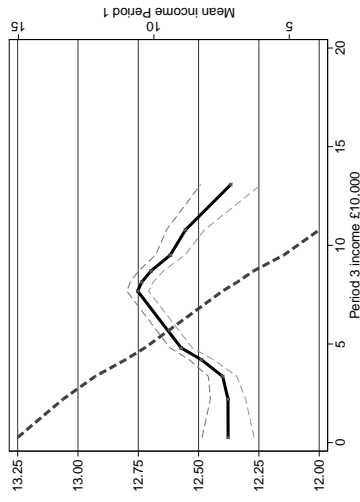


dii) I2=9.56, PI=24.18



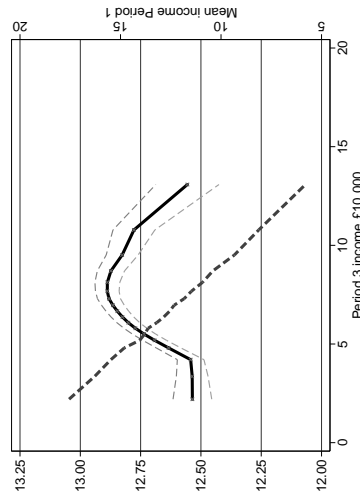
$\alpha_1 = 0.35$  (0.06)  $\alpha_2 = -0.18$  (0.04)

eii) I2=9.56, PI=28.24

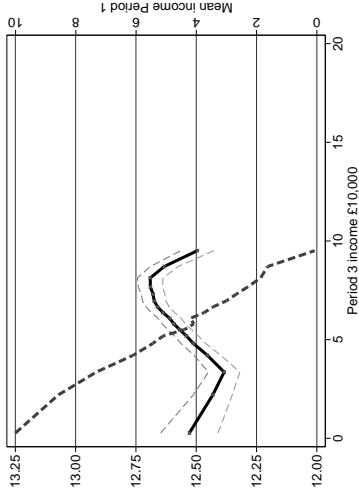


$\alpha_1 = 0.35$  (0.06)  $\alpha_2 = -0.36$  (0.07)

fi) I2=9.56, PI=32.93

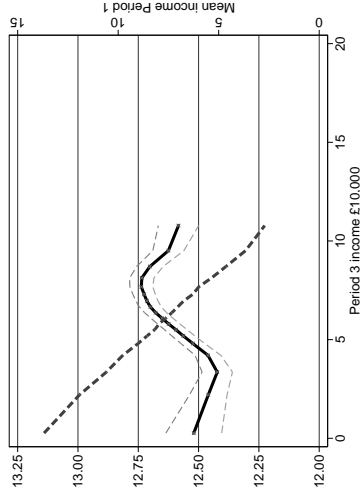


diii) I2=11.26, PI=24.18



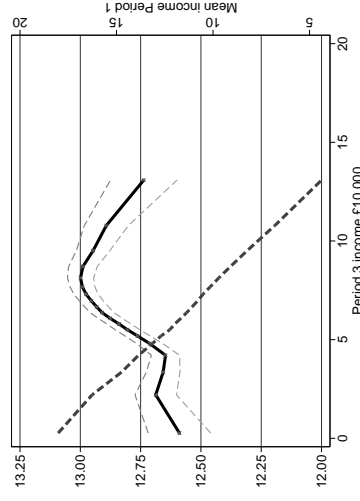
$\alpha_1 = 0.08$  (0.07)  $\alpha_2 = -0.11$  (0.04)

ei) I2=11.26, PI=28.24



$\alpha_1 = 0.13$  (0.06)  $\alpha_2 = -0.07$  (0.05)

fii) I2=11.26, PI=32.93



$\alpha_1 = 0.27$  (0.04)  $\alpha_2 = -0.17$  (0.08)

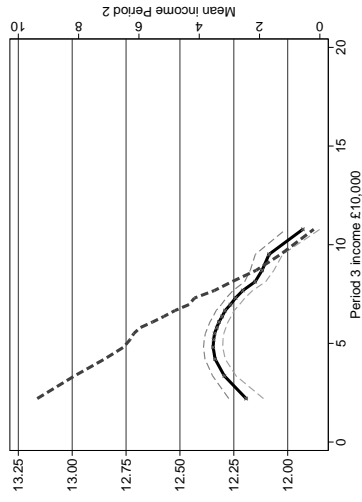
$\alpha_1 = 0.29$  (0.05)  $\alpha_2 = -0.27$  (0.07)

$\alpha_1 = 0.32$  (0.07)  $\alpha_2 = -0.17$  (0.07)

Note: 95% confidence intervals shown. Income in 2000 prices, £ 10,000s. Semi-parametric estimates control for dummies for paternal education interacted with age and maternal education interacted with age, paternal income profile, gender and child year of birth. Period 1 is 3-7, period 2 is 8-12, period 3 is 13-17.

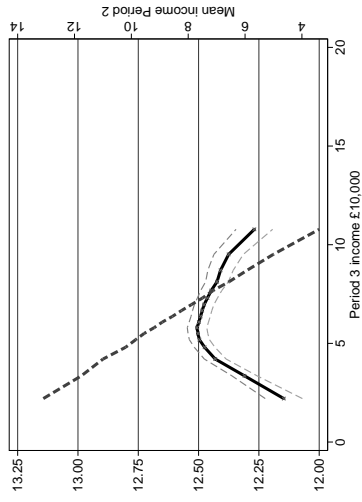
Figure A10: Excluding Early Years (0-2). Dependent Variable is Years of Schooling. Paternal Income 13-17.

gi)  $\text{II}=10.91, \text{PI}=24.18$



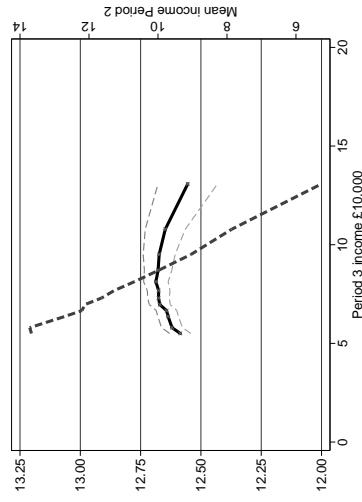
$\alpha_1 = 0.13 (0.05) \alpha_2 = -0.23 (0.04)$

hi)  $\text{II}=10.91, \text{PI}=28.24$

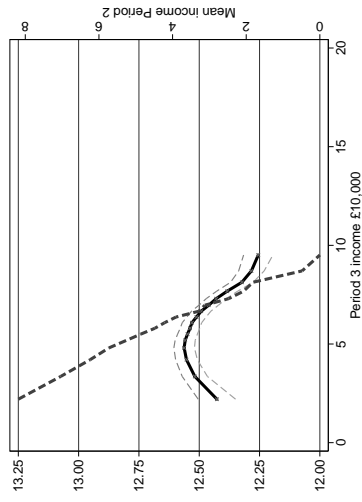


$\alpha_1 = 0.18 (0.03) \alpha_2 = -0.22 (0.04)$

ji)  $\text{II}=10.91, \text{PI}=32.93$

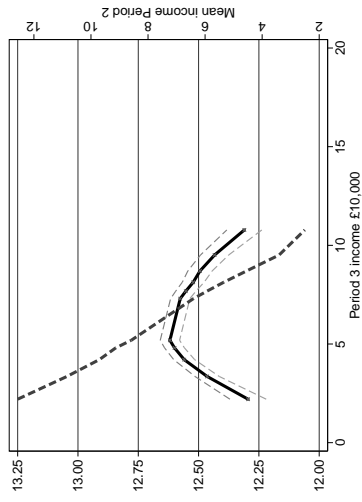


gii)  $\text{II}=13.02, \text{PI}=24.18$



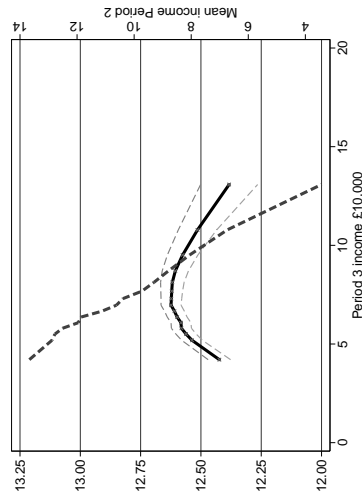
$\alpha_1 = 0.10 (0.04) \alpha_2 = -0.27 (0.04)$

hii)  $\text{II}=13.02, \text{PI}=28.24$

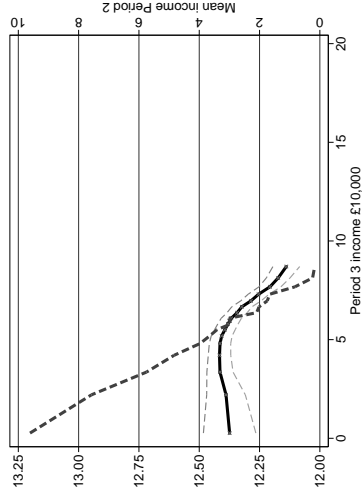


$\alpha_1 = 0.32 (0.04) \alpha_2 = -0.31 (0.04)$

jii)  $\text{II}=13.02, \text{PI}=32.93$

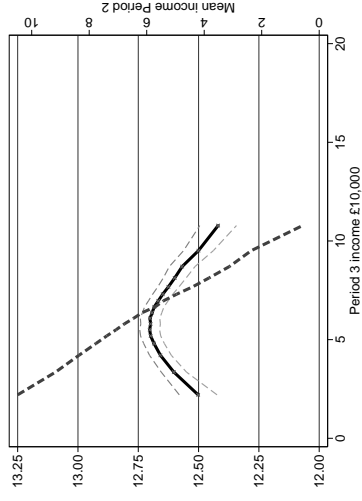


giii)  $\text{II}=15.64, \text{PI}=24.18$



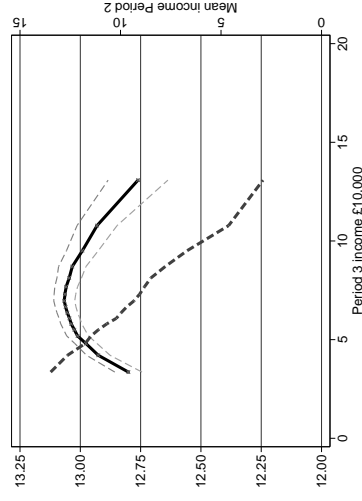
$\alpha_1 = 0.01 (0.06) \alpha_2 = -0.24 (0.04)$

hiii)  $\text{II}=15.64, \text{PI}=28.24$



$\alpha_1 = 0.20 (0.04) \alpha_2 = -0.20 (0.04)$

ji)  $\text{II}=15.64, \text{PI}=32.93$



$\alpha_1 = 0.09 (0.03) \alpha_2 = -0.12 (0.07)$

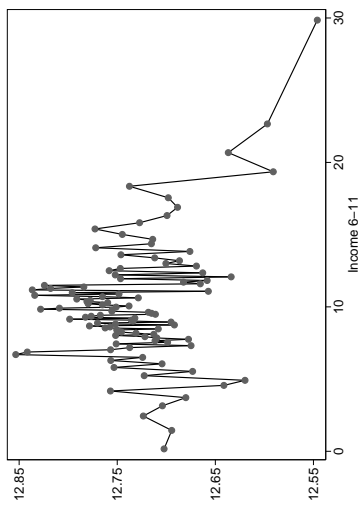
$\alpha_1 = 0.20 (0.03) \alpha_2 = -0.24 (0.06)$

$\alpha_1 = 0.26 (0.04) \alpha_2 = -0.30 (0.07)$

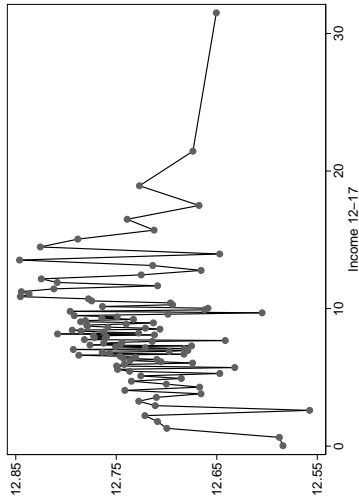
Note: 95% confidence intervals shown. Income in 2000 prices, £ 10,000s. Semi-parametric estimates control for dummies for paternal education interacted with age and maternal education interacted with age, paternal income profile, gender and child year of birth. Period 1 is 3-7, period 2 is 8-12, period 3 is 13-17.

Figure A11: Parametric Estimates. Years of Schooling Controlling for Family Fixed Effects.

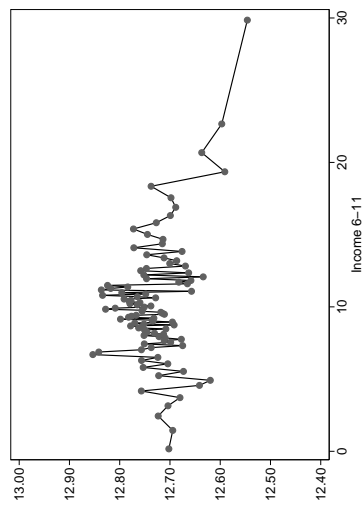
a) Paternal Income 6-11



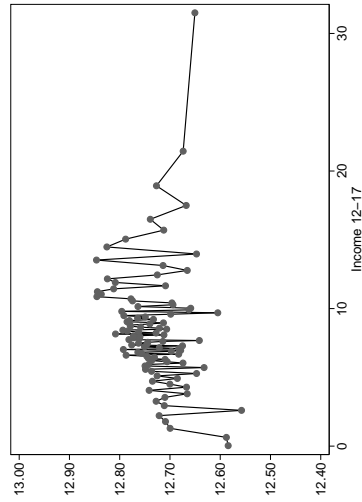
b) Paternal Income 12-17



c) Maternal Income 6-11



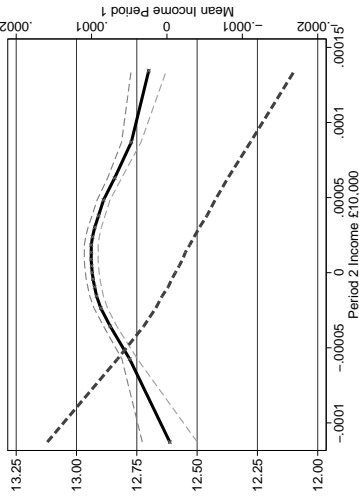
d) Maternal Income 12-17



Graphs plot individual coefficients from regression of decile bins for PI upon child human capital. Income in 2000 prices, £ 10,000s.

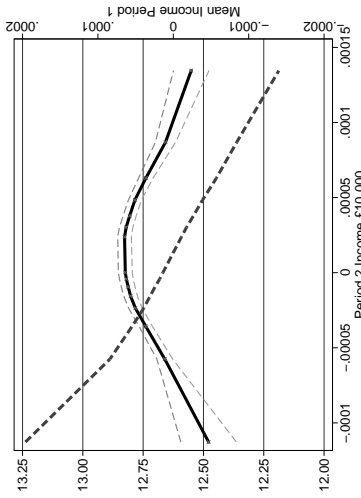
Figure A12: Paternal Age-education Dummies and Fixed Effects. years of Schooling. Paternal Income 6-11.

ai) I3=6.34, PI=24.18



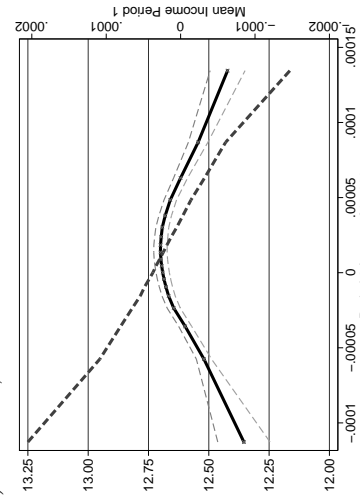
$\alpha_1 = 0.33$  (0.00)  $\alpha_2 = -0.24$  (0.00)

bi) I3=6.34, PI=28.24

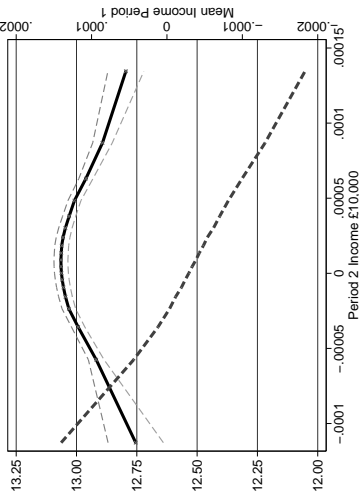


$\alpha_1 = 0.35$  (0.00)  $\alpha_2 = -0.28$  (0.00)

ci) I3=6.34, PI=32.93

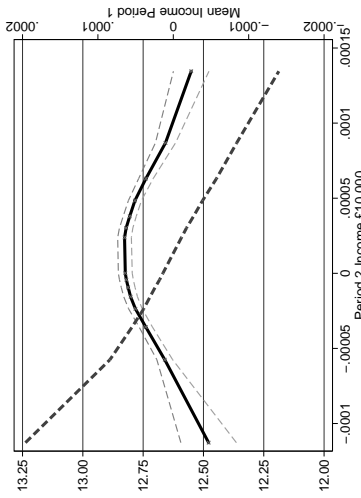


aii) I3=7.49, PI=24.18



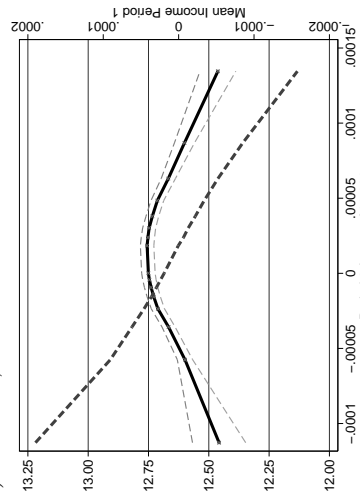
$\alpha_1 = 0.31$  (0.00)  $\alpha_2 = -0.27$  (0.00)

bii) I3=7.49, PI=28.24

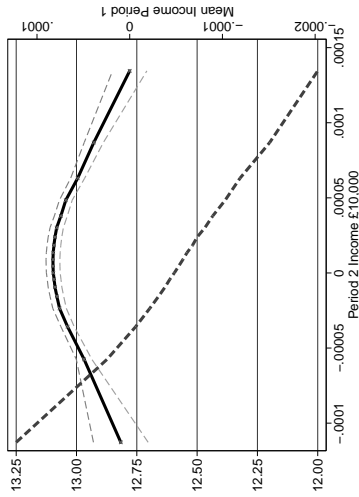


$\alpha_1 = 0.32$  (0.00)  $\alpha_2 = -0.17$  (0.00)

cii) I3=7.49, PI=32.93

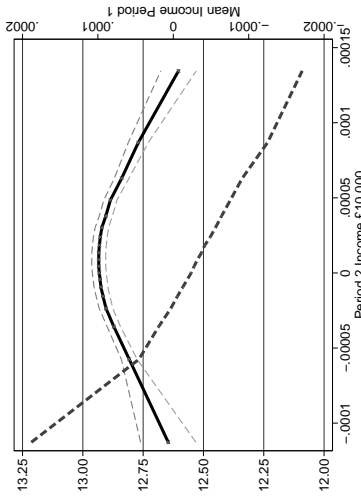


aiii) I3=9.32, PI=24.18



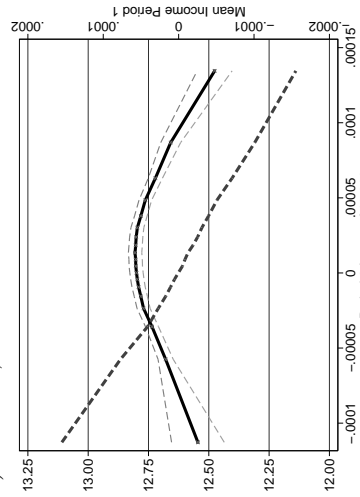
$\alpha_1 = 0.28$  (0.00)  $\alpha_2 = -0.32$  (0.00)

biii) I3=9.32, PI=28.24



$\alpha_1 = 0.29$  (0.00)  $\alpha_2 = -0.33$  (0.00)

ciii) I3=9.32, PI=32.93



$\alpha_1 = 0.34$  (0.00)  $\alpha_2 = -0.28$  (0.00)

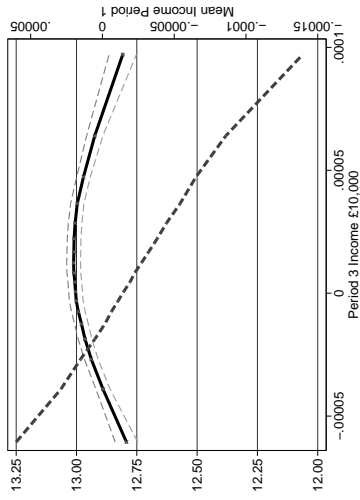
$\alpha_1 = 0.30$  (0.00)  $\alpha_2 = -0.29$  (0.00)

$\alpha_1 = 0.26$  (0.00)  $\alpha_2 = -0.33$  (0.00)

Note: 95% confidence intervals shown. Income in 2000 prices, £ 10,000s. Semi-parametric estimates control for dummies for paternal fixed effect, paternal education interacted with age and maternal education interacted with age, paternal income profile, gender and child year of birth.

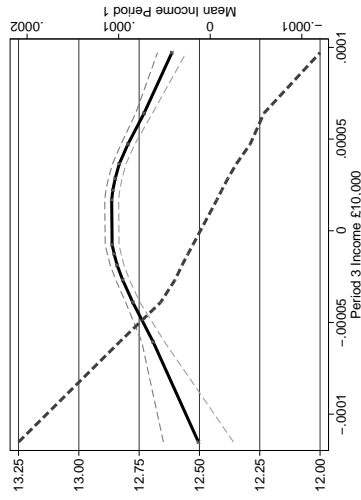
Figure A12: Paternal Age-education Dummies and Fixed Effects. years of Schooling. Paternal Income 12-17.

di) I2=8.13, PI=24.18



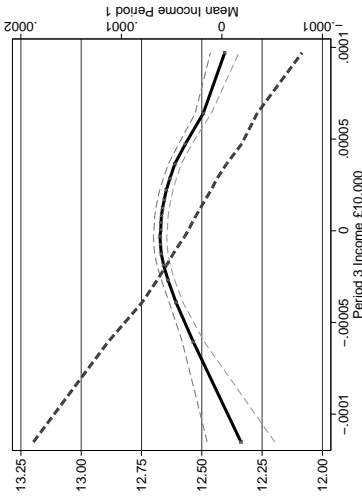
$\alpha_1 = 0.42$  (0.00)  $\alpha_2 = -0.20$  (0.00)

ei) I2=8.13, PI=28.24



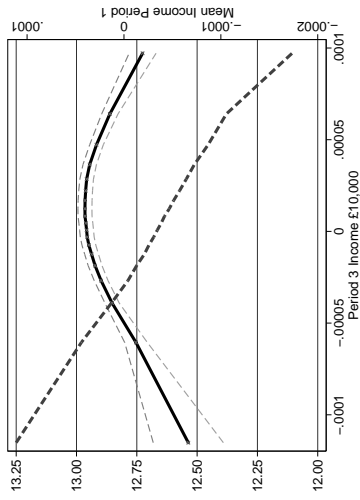
$\alpha_1 = 0.36$  (0.00)  $\alpha_2 = -0.25$  (0.00)

fi) I2=8.13, PI=32.93



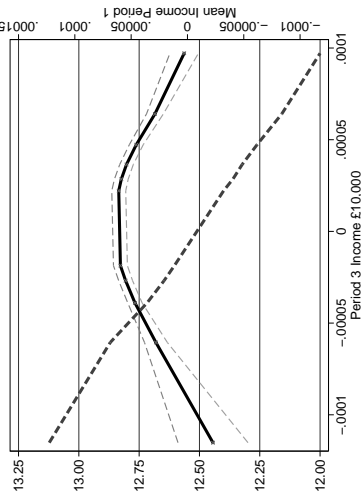
$\alpha_1 = 0.33$  (0.00)  $\alpha_2 = -0.26$  (0.00)

dii) I2=9.56, PI=24.18



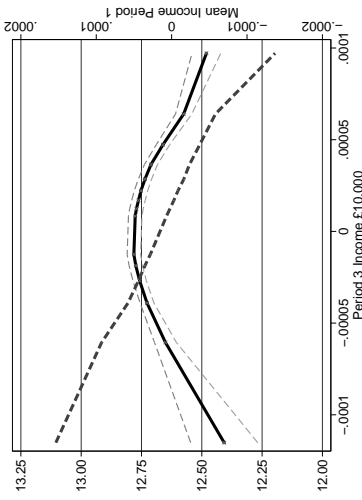
$\alpha_1 = 0.42$  (0.00)  $\alpha_2 = -0.24$  (0.00)

eii) I2=9.56, PI=28.24



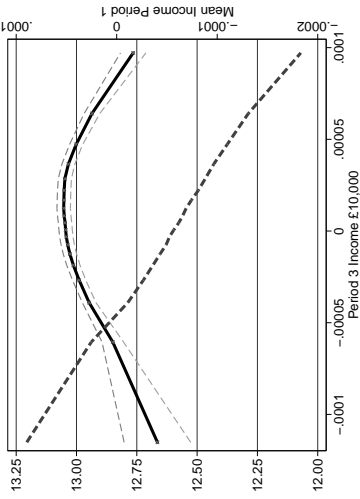
$\alpha_1 = 0.40$  (0.00)  $\alpha_2 = -0.28$  (0.00)

fi) I2=9.56, PI=32.93



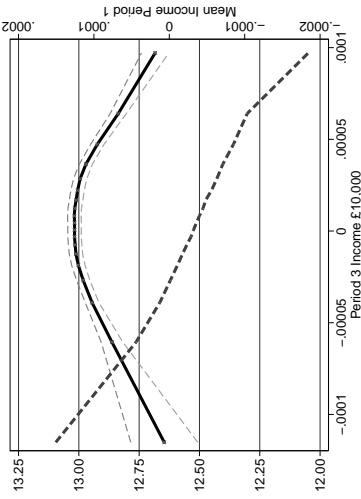
$\alpha_1 = 0.37$  (0.00)  $\alpha_2 = -0.30$  (0.00)

diii) I2=11.26, PI=24.18



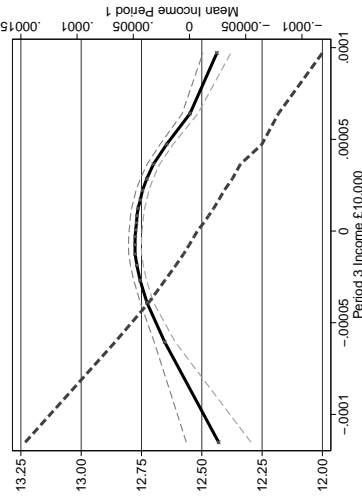
$\alpha_1 = 0.38$  (0.00)  $\alpha_2 = -0.28$  (0.00)

eiii) I2=11.26, PI=28.24



$\alpha_1 = 0.37$  (0.00)  $\alpha_2 = -0.33$  (0.00)

fiii) I2=11.26, PI=32.93

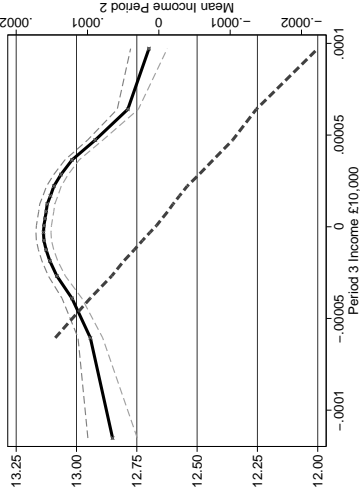


$\alpha_1 = 0.34$  (0.00)  $\alpha_2 = -0.33$  (0.00)

Note: 95% confidence intervals shown. Income in 2000 prices, £ 10,000s. Semi-parametric estimates control for dummies for paternal fixed effect, paternal education interacted with age and maternal education interacted with age, paternal income profile, gender and child year of birth.

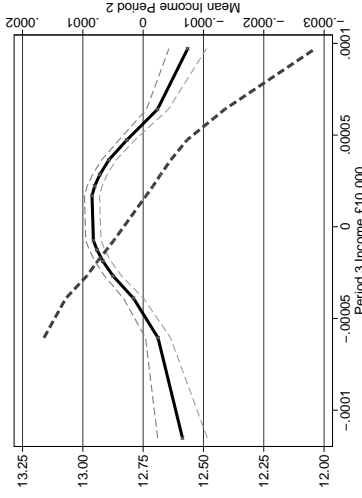
Figure A12: Paternal Age-education Dummies and Fixed Effects. years of Schooling. Paternal Income 12-17.

gi)  $\text{II}=10.91, \text{PI}=24.18$



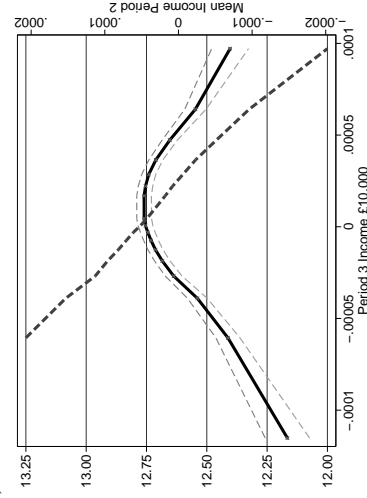
$\alpha_1 = 0.19 (0.00) \alpha_2 = -0.43 (0.00)$

hi)  $\text{II}=10.91, \text{PI}=28.24$



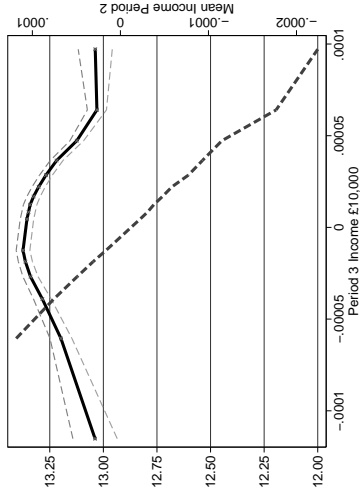
$\alpha_1 = 0.28 (0.00) \alpha_2 = -0.41 (0.00)$

ji)  $\text{II}=10.91, \text{PI}=32.93$



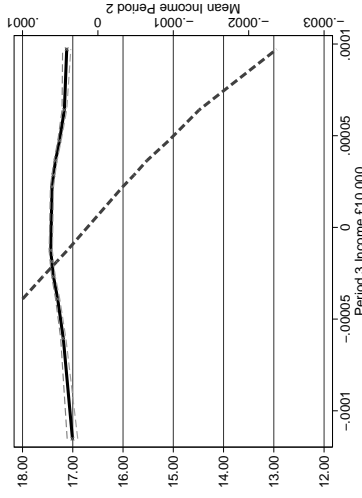
$\alpha_1 = 0.35 (0.00) \alpha_2 = -0.36 (0.00)$

gii)  $\text{II}=13.02, \text{PI}=24.18$



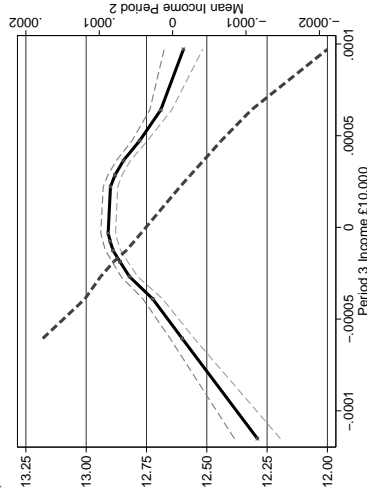
$\alpha_1 = 0.16 (0.00) \alpha_2 = -0.32 (0.00)$

hii)  $\text{II}=13.02, \text{PI}=28.24$



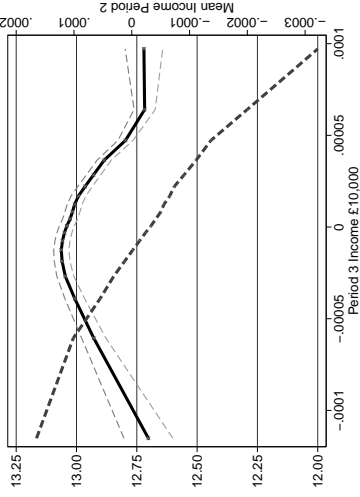
$\alpha_1 = 0.14 (0.00) \alpha_2 = -0.32 (0.00)$

jii)  $\text{II}=13.02, \text{PI}=32.93$



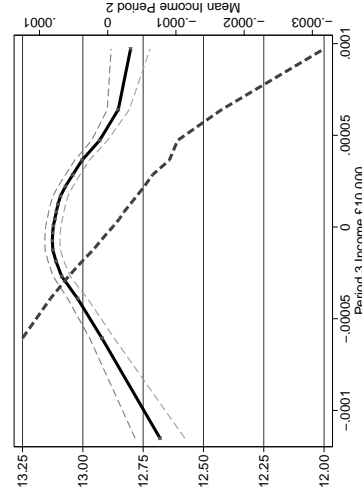
$\alpha_1 = 0.32 (0.00) \alpha_2 = -0.32 (0.00)$

giii)  $\text{II}=15.64, \text{PI}=24.18$



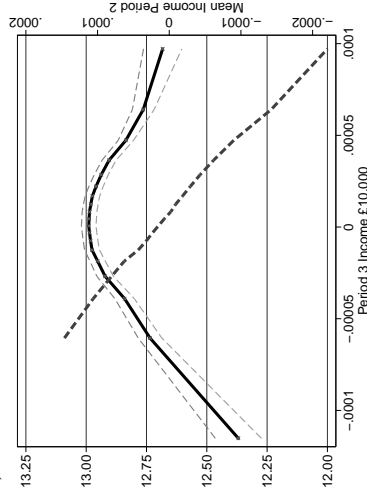
$\alpha_1 = 0.32 (0.00) \alpha_2 = -0.31 (0.00)$

hiii)  $\text{II}=15.64, \text{PI}=28.24$



$\alpha_1 = 0.19 (0.00) \alpha_2 = -0.31 (0.00)$

jiii)  $\text{II}=15.64, \text{PI}=32.93$

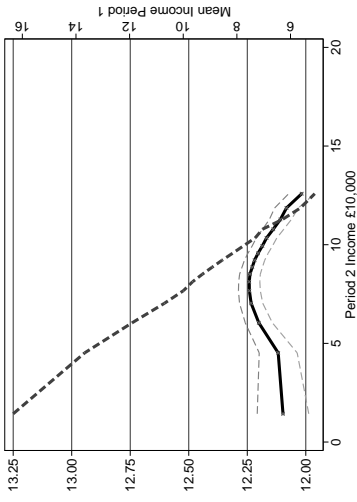


$\alpha_1 = 0.25 (0.00) \alpha_2 = -0.30 (0.00)$

Note: 95% confidence intervals shown. Income in 2000 prices, £ 10,000s. Semi-parametric estimates control for dummies for paternal fixed effect, paternal education interacted with age and maternal education interacted with age, paternal income profile, gender and child year of birth.

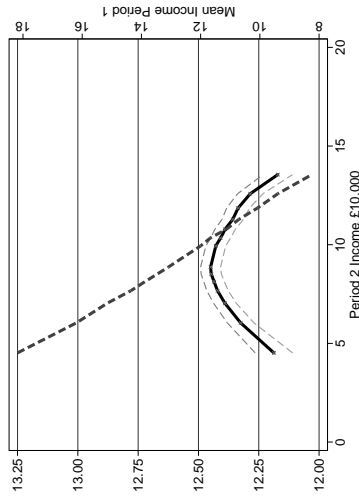
Figure A13: Control for Paternal Income Growth. Years of Schooling. Paternal Income 6-11.

ai) I3=6.34, PI=24.18



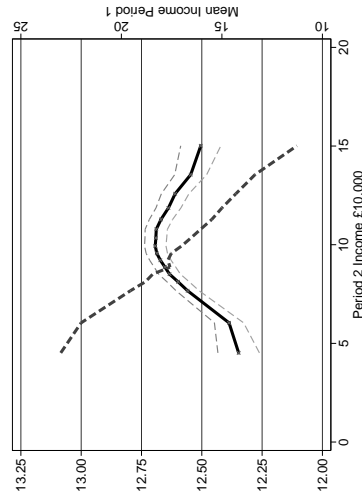
$\alpha_1 = 0.13 (0.06)$   $\alpha_2 = -0.21 (0.04)$

bi) I3=6.34, PI=28.24



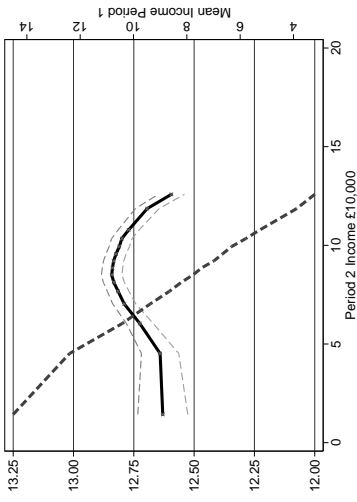
$\alpha_1 = 0.26 (0.04)$   $\alpha_2 = -0.28 (0.04)$

ci) I3=6.34, PI=32.93



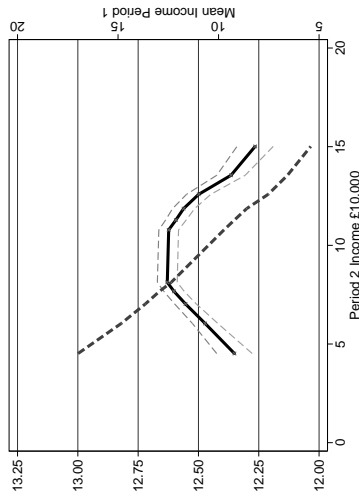
$\alpha_1 = 0.34 (0.05)$   $\alpha_2 = -0.18 (0.05)$

aii) I3=7.49, PI=24.18



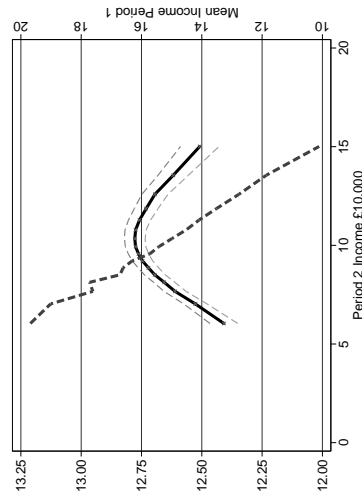
$\alpha_1 = 0.21 (0.06)$   $\alpha_2 = -0.24 (0.04)$

bii) I3=7.49, PI=28.24



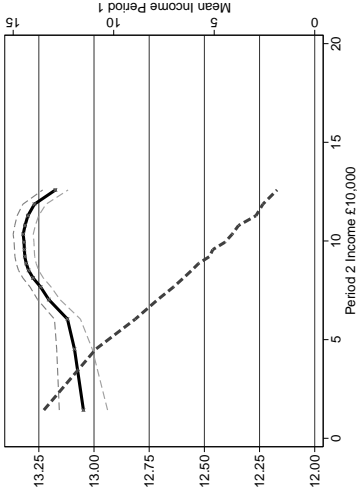
$\alpha_1 = 0.31 (0.04)$   $\alpha_2 = -0.40 (0.04)$

cii) I3=7.49, PI=32.93



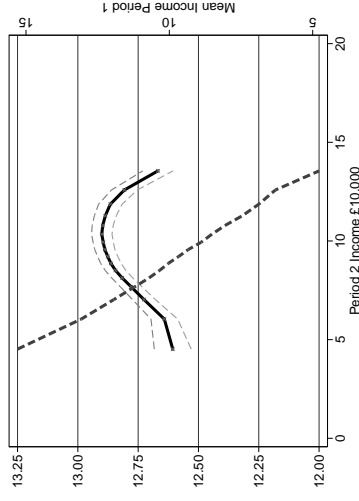
$\alpha_1 = 0.35 (0.04)$   $\alpha_2 = -0.25 (0.05)$

aiii) I3=9.32, PI=24.18



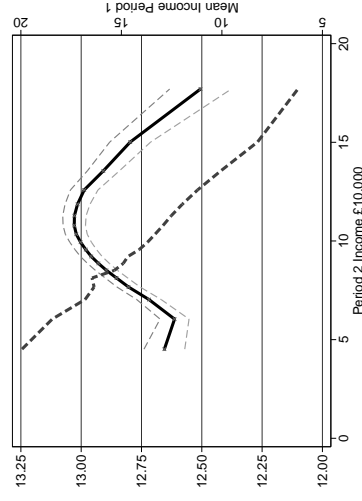
$\alpha_1 = 0.26 (0.06)$   $\alpha_2 = -0.13 (0.04)$

biii) I3=9.32, PI=28.24



$\alpha_1 = 0.33 (0.06)$   $\alpha_2 = -0.21 (0.04)$

ciii) I3=9.32, PI=32.93

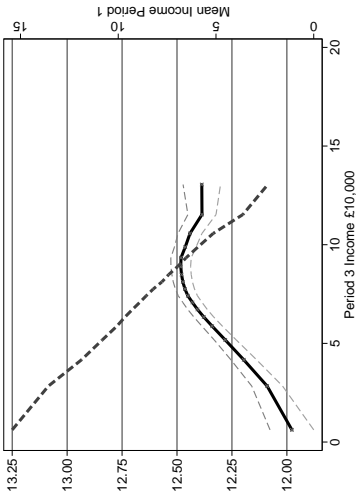


$\alpha_1 = 0.33 (0.05)$   $\alpha_2 = -0.24 (0.07)$

Note: 95% confidence intervals shown. Income in 2000 prices, £ 10,000s. Semi-parametric estimates control for dummies for paternal education interacted with age and maternal education interacted with age, paternal income profile growth, gender and child year of birth.

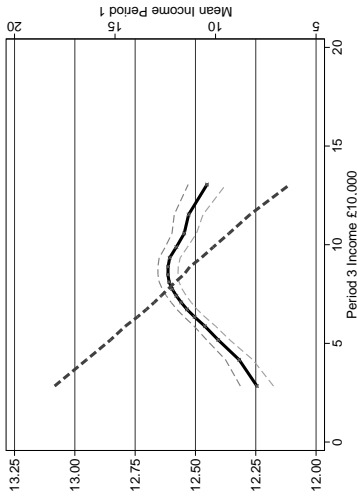
Figure A13: Control for Paternal Income Growth. Years of Schooling. Paternal Income 12-17.

di) I2=8.13, PI=24.18



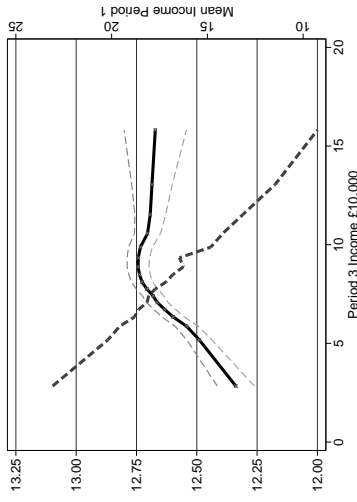
$\alpha_1 = 0.49$  (0.06)  $\alpha_2 = -0.30$  (0.04)

ei) I2=8.13, PI=28.24



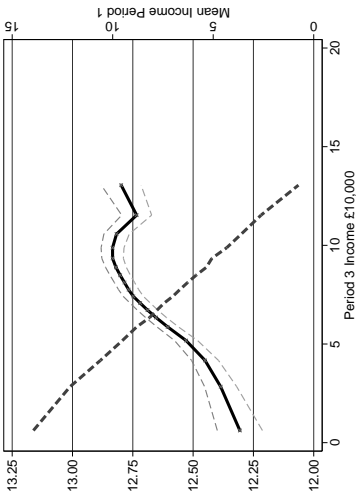
$\alpha_1 = 0.35$  (0.04)  $\alpha_2 = -0.14$  (0.05)

fi) I2=8.13, PI=32.93



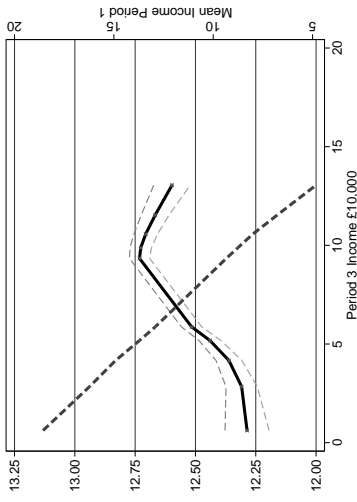
$\alpha_1 = 0.20$  (0.06)  $\alpha_2 = -0.03$  (0.07)

dii) I2=9.56, PI=24.18



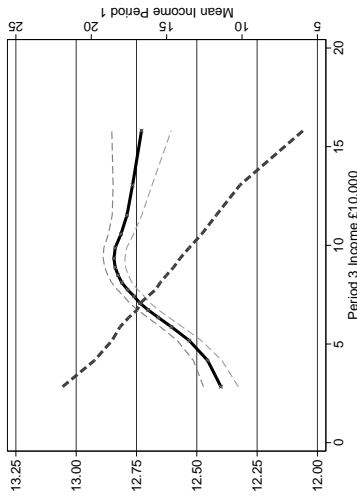
$\alpha_1 = 0.44$  (0.05)  $\alpha_2 = -0.05$  (0.05)

eii) I2=9.56, PI=28.24



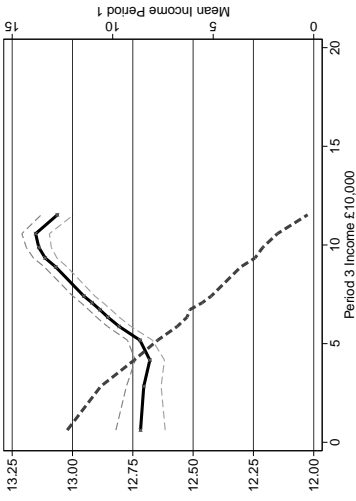
$\alpha_1 = 0.37$  (0.05)  $\alpha_2 = -0.06$  (0.04)

fii) I2=9.56, PI=32.93



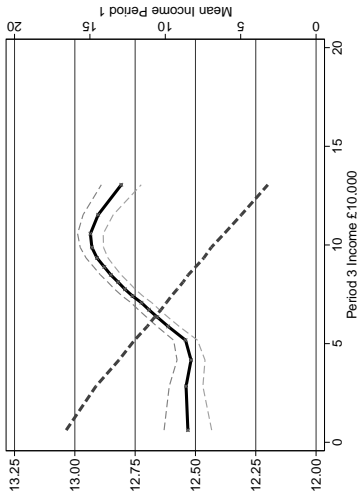
$\alpha_1 = 0.39$  (0.04)  $\alpha_2 = -0.06$  (0.07)

diii) I2=11.26, PI=24.18



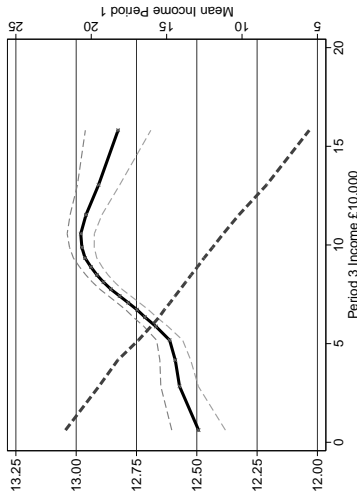
$\alpha_1 = 0.17$  (0.06)  $\alpha_2 = -0.18$  (0.04)

eiii) I2=11.26, PI=28.24



$\alpha_1 = 0.23$  (0.05)  $\alpha_2 = 0.05$  (0.05)

fiii) I2=11.26, PI=32.93



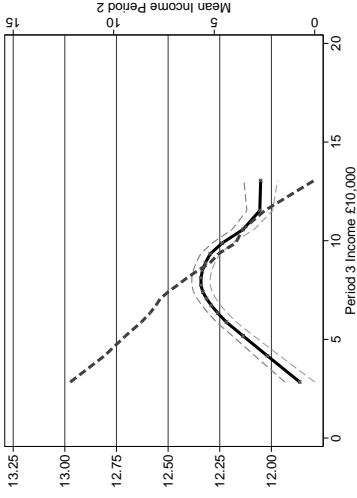
$\alpha_1 = 0.36$  (0.06)  $\alpha_2 = -0.03$  (0.07)

Note: 95% confidence intervals shown. Income in 2000 prices, £ 10,000s. Semi-parametric estimates control for dummies for paternal education interacted with age and maternal education interacted with age, paternal income profile growth, gender and child year of birth.



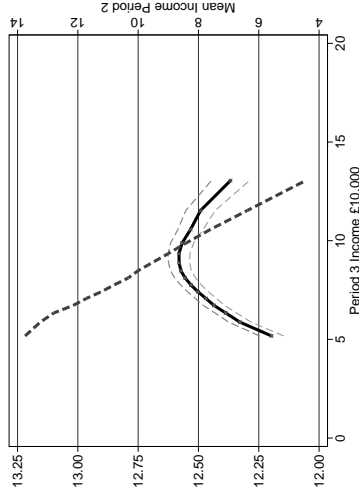
Figure A13: Control for Paternal Income Growth. Years of Schooling. Paternal Income 12-17.

gi)  $\text{II}=10.91, \text{PI}=24.18$



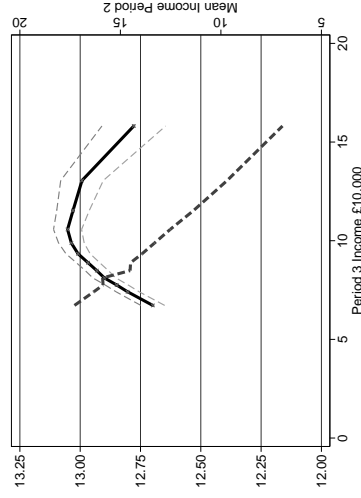
$\alpha_1 = 0.47 (0.04) \alpha_2 = -0.20 (0.04)$

hi)  $\text{II}=10.91, \text{PI}=28.24$



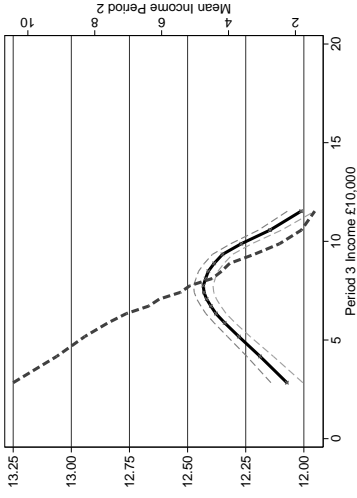
$\alpha_1 = 0.50 (0.04) \alpha_2 = -0.04 (0.04)$

ji)  $\text{II}=10.91, \text{PI}=32.93$



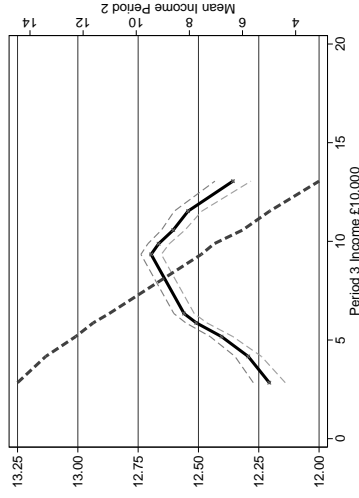
$\alpha_1 = 0.68 (0.04) \alpha_2 = 0.09 (0.05)$

gii)  $\text{II}=13.02, \text{PI}=24.18$



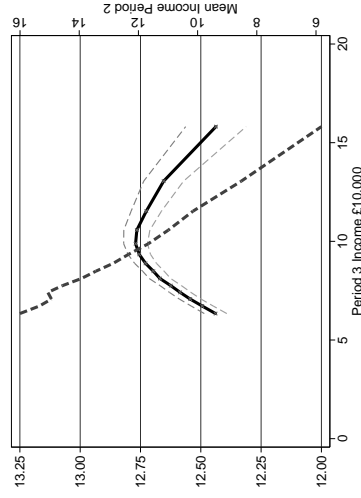
$\alpha_1 = 0.42 (0.05) \alpha_2 = -0.27 (0.03)$

hii)  $\text{II}=13.02, \text{PI}=28.24$



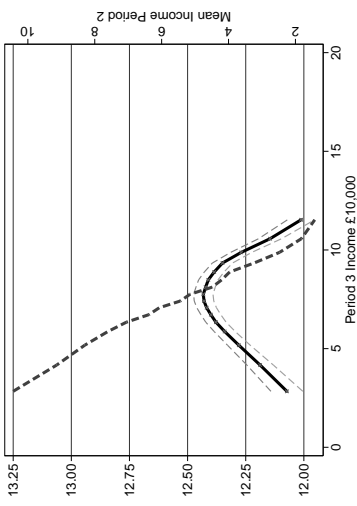
$\alpha_1 = 0.47 (0.04) \alpha_2 = -0.32 (0.04)$

jii)  $\text{II}=13.02, \text{PI}=32.93$



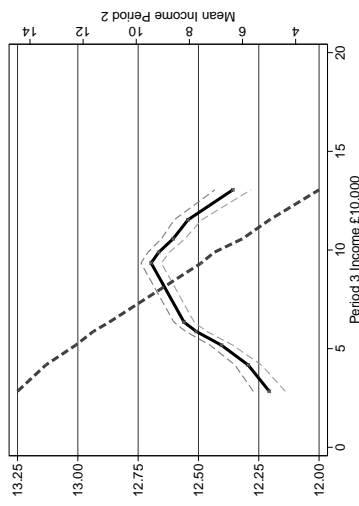
$\alpha_1 = 0.53 (0.04) \alpha_2 = 0.03 (0.05)$

giii)  $\text{II}=15.64, \text{PI}=24.18$



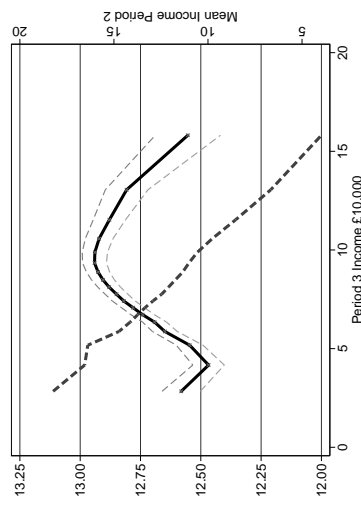
$\alpha_1 = 0.28 (0.06) \alpha_2 = -0.19 (0.03)$

hiii)  $\text{II}=15.64, \text{PI}=28.24$



$\alpha_1 = 0.19 (0.06) \alpha_2 = -0.16 (0.04)$

ji)  $\text{II}=15.64, \text{PI}=32.93$

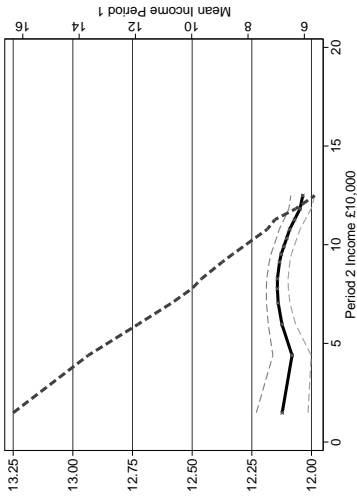


$\alpha_1 = 0.27 (0.05) \alpha_2 = -0.30 (0.07)$

Note: 95% confidence intervals shown. Income in 2000 prices, £ 10,000s. Semi-parametric estimates control for dummies for paternal education interacted with age and maternal education interacted with age, paternal income profile growth, gender and child year of birth.

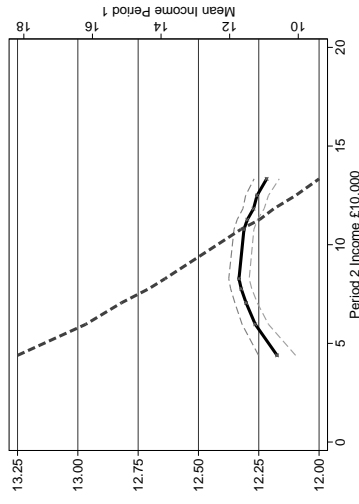
Figure A14: Control for Variance of Income. Years of Schooling. Paternal Income 6-11.

ai) I3=6.34, PI=24.18



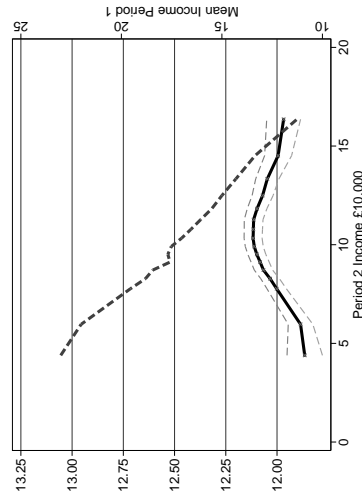
$\alpha_1 = 0.01 (0.06) \alpha_2 = -0.15 (0.04)$

bi) I3=6.34, PI=28.24



$\alpha_1 = 0.17 (0.04) \alpha_2 = -0.22 (0.04)$

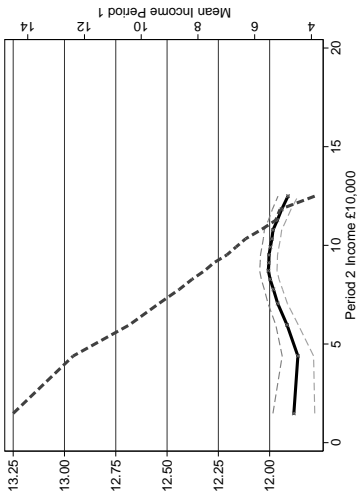
ci) I3=6.34, PI=32.93



$\alpha_1 = 0.23 (0.05) \alpha_2 = -0.14 (0.05)$

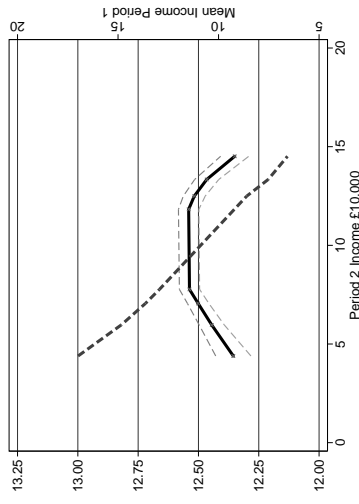
$\alpha_1 = 0.28 (0.04) \alpha_2 = -0.23 (0.05)$

aii) I3=7.49, PI=24.18



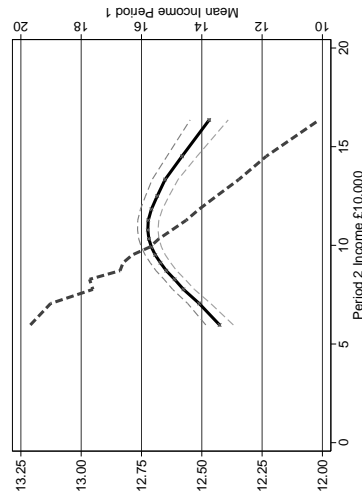
$\alpha_1 = 0.12 (0.06) \alpha_2 = -0.17 (0.03)$

bii) I3=7.49, PI=28.24



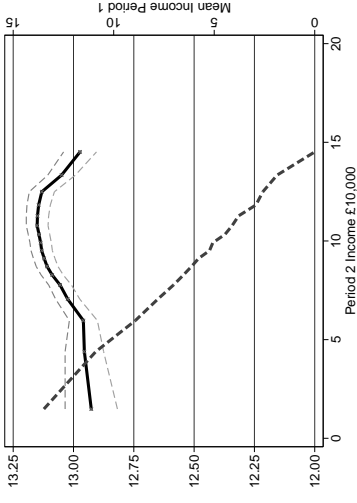
$\alpha_1 = 0.24 (0.04) \alpha_2 = -0.30 (0.04)$

cii) I3=7.49, PI=32.93



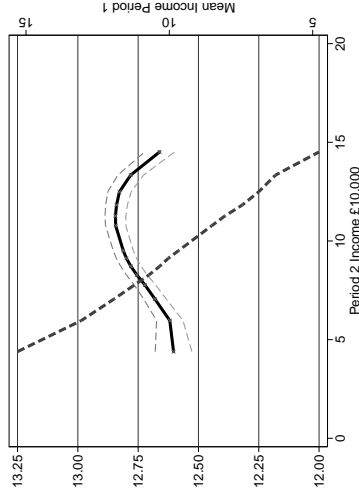
$\alpha_1 = 0.25 (0.05) \alpha_2 = -0.40 (0.07)$

aiii) I3=9.32, PI=24.18



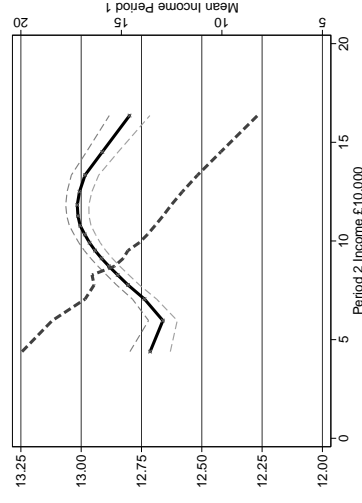
$\alpha_1 = 0.19 (0.06) \alpha_2 = -0.06 (0.04)$

biii) I3=9.32, PI=28.24



$\alpha_1 = 0.19 (0.06) \alpha_2 = -0.14 (0.04)$

ciii) I3=9.32, PI=32.93

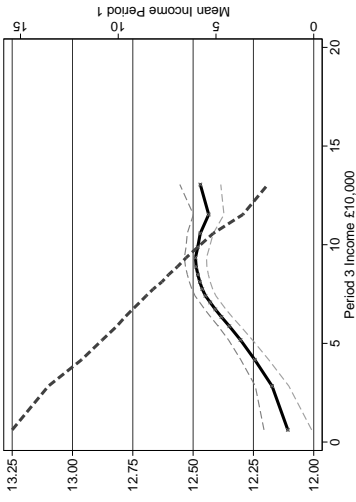


$\alpha_1 = 0.25 (0.05) \alpha_2 = -0.40 (0.07)$

Note: 95% confidence intervals shown. Income in 2000 prices, £ 10,000s. Semi-parametric estimates control for dummies for paternal education interacted with age and maternal education interacted with age, paternal income profile, gender and child year of birth, variance of income.

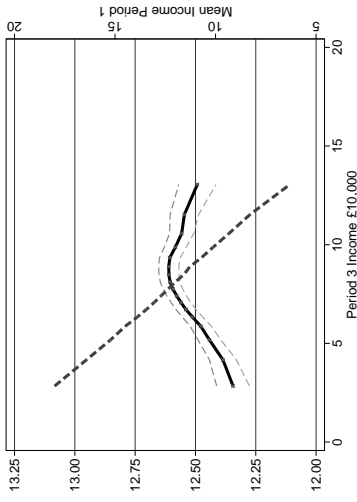
Figure A14: Control for Variance of Income. Years of Schooling. Paternal Income 12-17.

di) I2=8.13, PI=24.18



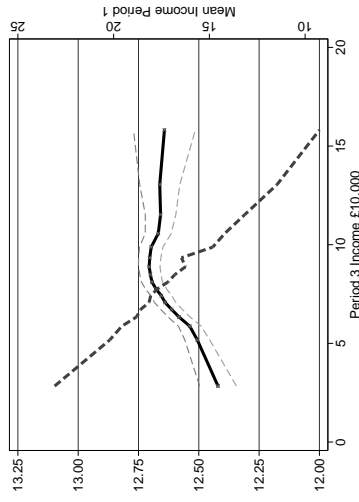
$\alpha_1 = 0.35 (0.05) \alpha_2 = 0.04 (0.05)$

ei) I2=8.13, PI=28.24



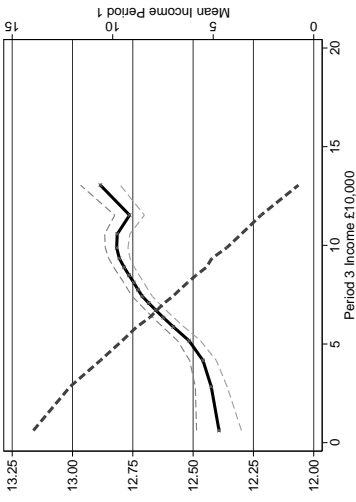
$\alpha_1 = 0.25 (0.04) \alpha_2 = -0.09 (0.04)$

fi) I2=8.13, PI=32.93



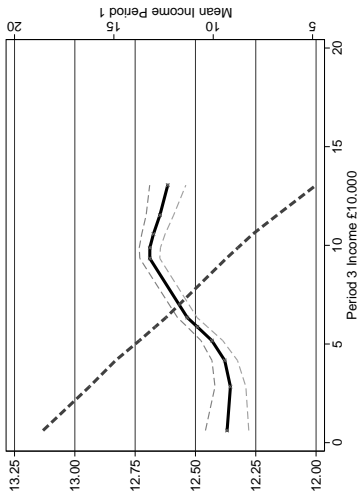
$\alpha_1 = 0.02 (0.06) \alpha_2 = -0.03 (0.07)$

dii) I2=9.56, PI=24.18



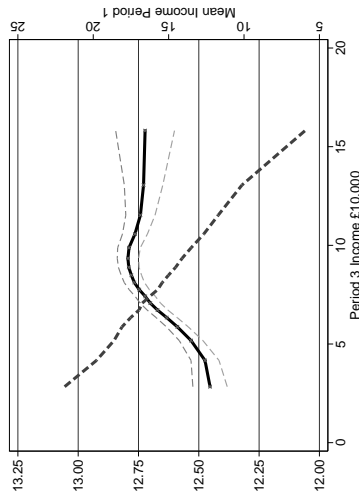
$\alpha_1 = 0.32 (0.05) \alpha_2 = 0.18 (0.05)$

eii) I2=9.56, PI=28.24



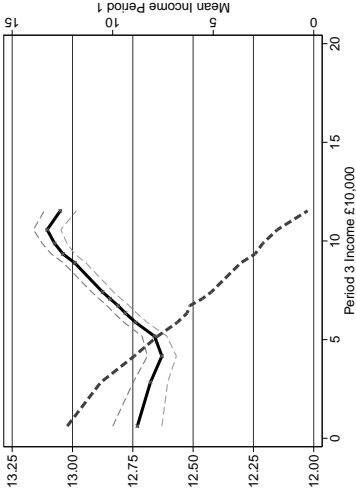
$\alpha_1 = 0.24 (0.05) \alpha_2 = 0.00 (0.04)$

fii) I2=9.56, PI=32.93



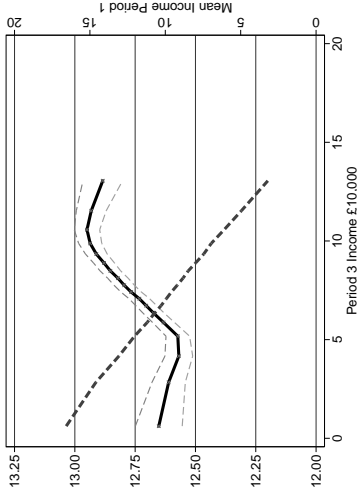
$\alpha_1 = 0.28 (0.04) \alpha_2 = -0.02 (0.07)$

diii) I2=11.26, PI=24.18



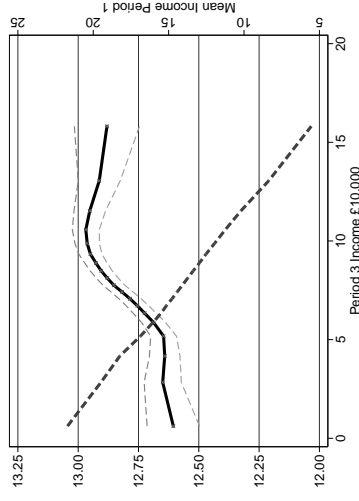
$\alpha_1 = 0.09 (0.06) \alpha_2 = 0.25 (0.04)$

eiii) I2=11.26, PI=28.24



$\alpha_1 = 0.12 (0.05) \alpha_2 = 0.13 (0.05)$

fi) I2=11.26, PI=32.93

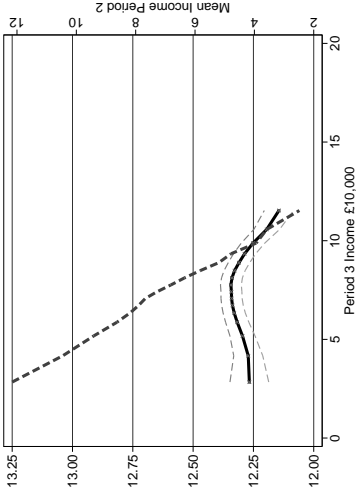


$\alpha_1 = 0.23 (0.06) \alpha_2 = 0.04 (0.07)$

Note: 95% confidence intervals shown. Income in 2000 prices, £ 10,000s. Semi-parametric estimates control for dummies for paternal education interacted with age and maternal education interacted with age, paternal income profile, gender and child year of birth, variance of income.

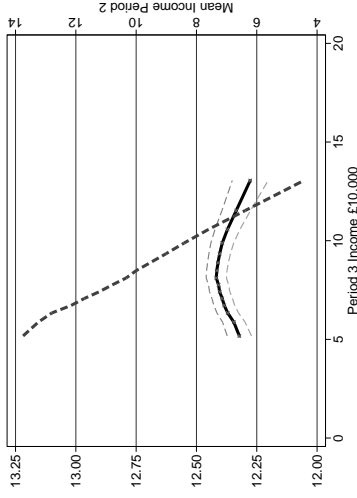
Figure A14: Control for Variance of Income. Years of Schooling. Paternal Income 12-17.

gi)  $\text{II}=10.91, \text{PI}=24.18$



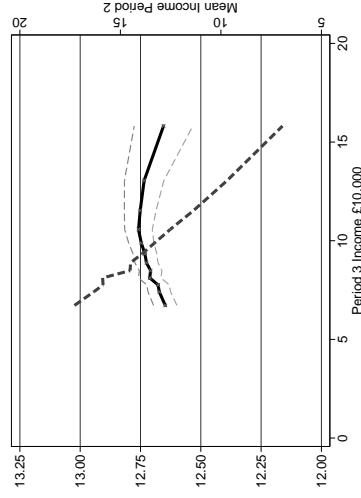
$\alpha_1 = 0.07 (0.05) \alpha_2 = -0.20 (0.04)$

hi)  $\text{II}=10.91, \text{PI}=28.24$



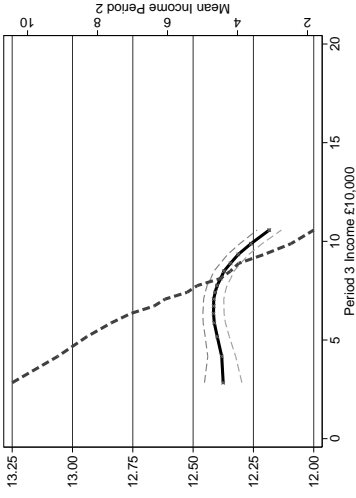
$\alpha_1 = 0.09 (0.03) \alpha_2 = -0.14 (0.04)$

ji)  $\text{II}=10.91, \text{PI}=32.93$



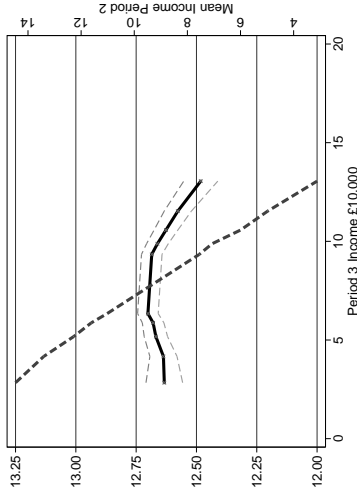
$\alpha_1 = 0.08 (0.03) \alpha_2 = -0.07 (0.07)$

gii)  $\text{II}=13.02, \text{PI}=24.18$



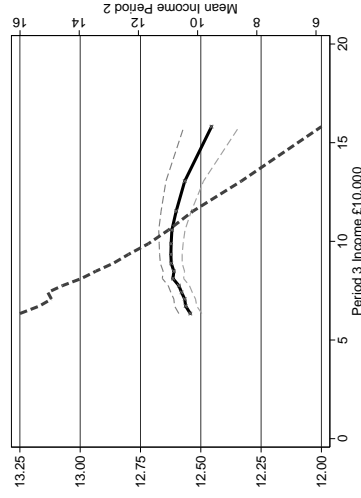
$\alpha_1 = 0.03 (0.04) \alpha_2 = -0.22 (0.03)$

hii)  $\text{II}=13.02, \text{PI}=28.24$



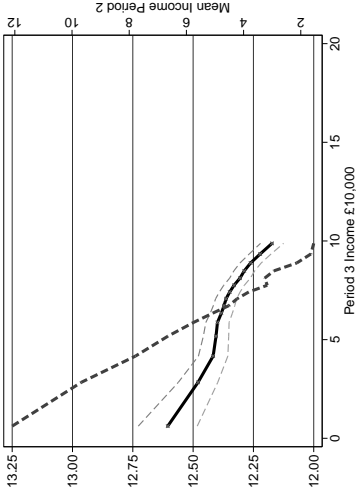
$\alpha_1 = 0.08 (0.04) \alpha_2 = -0.23 (0.04)$

jii)  $\text{II}=13.02, \text{PI}=32.93$



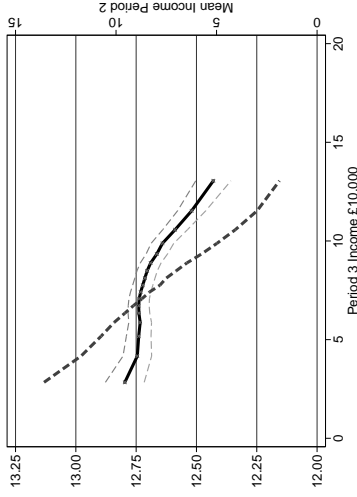
$\alpha_1 = 0.07 (0.03) \alpha_2 = -0.15 (0.06)$

giii)  $\text{II}=15.64, \text{PI}=24.18$



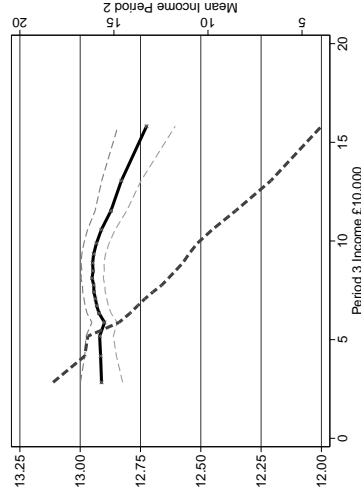
$\alpha_1 = -0.26 (0.07) \alpha_2 = -0.19 (0.03)$

hiii)  $\text{II}=15.64, \text{PI}=28.24$



$\alpha_1 = -0.08 (0.05) \alpha_2 = -0.28 (0.04)$

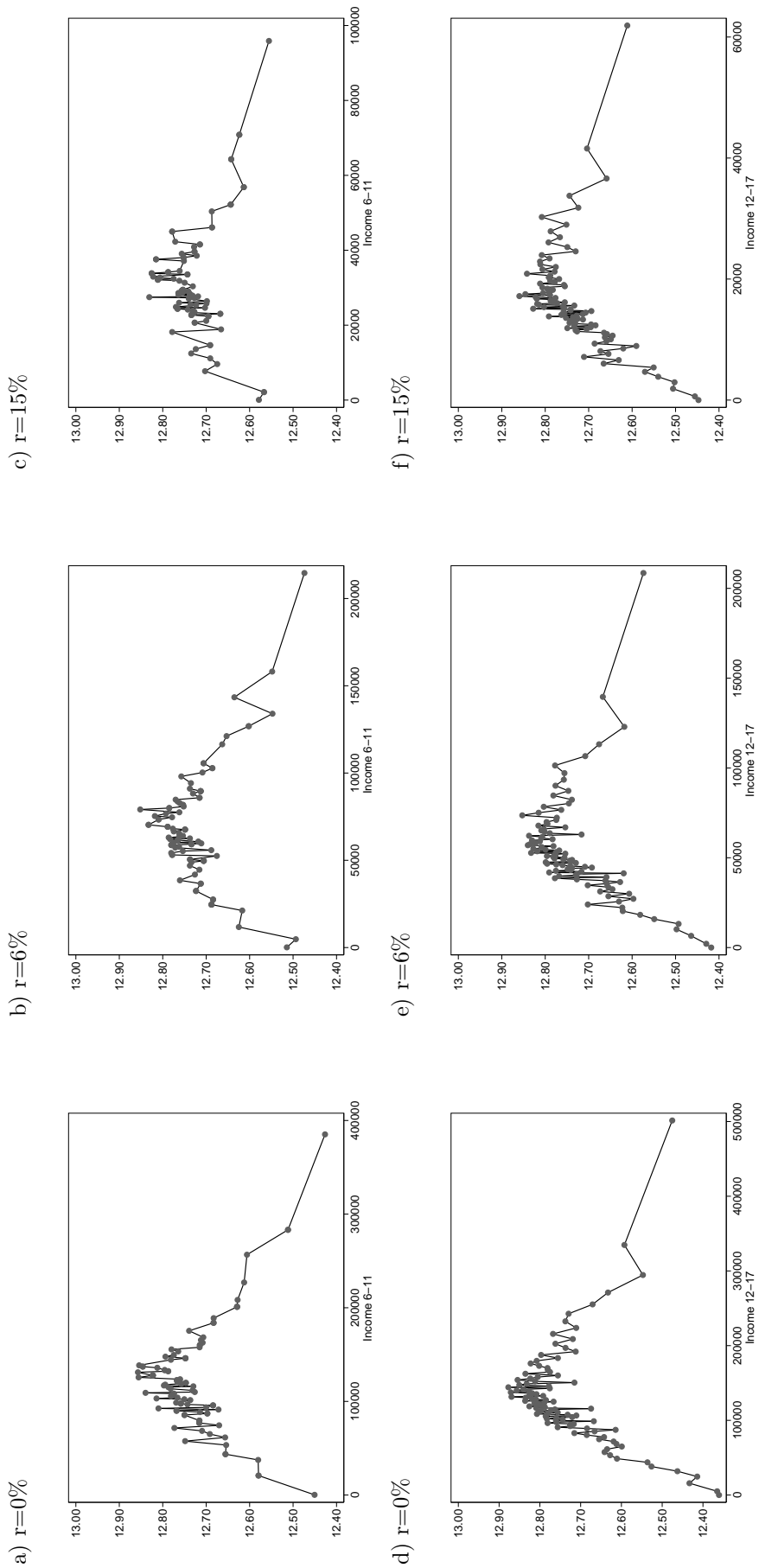
jiij)  $\text{II}=15.64, \text{PI}=32.93$



$\alpha_1 = 0.02 (0.05) \alpha_2 = -0.21 (0.07)$

Note: 95% confidence intervals shown. Income in 2000 prices, £ 10,000s. Semi-parametric estimates control for dummies for paternal education interacted with age and maternal education interacted with age, paternal income profile, gender and child year of birth, variance of income.

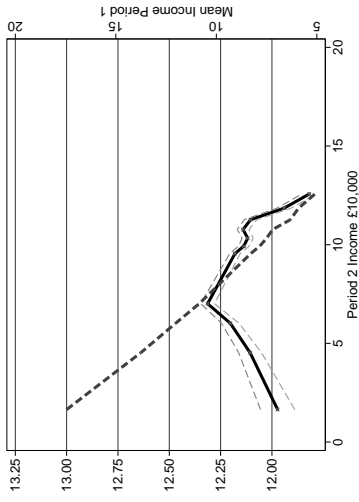
Figure A15: Parametric Estimates. Years of Schooling. Different Discount Rates.



Graphs plot individual coefficients from regression of decile bins for PI upon child human capital. Income in 2000 prices, £ 10,000s.

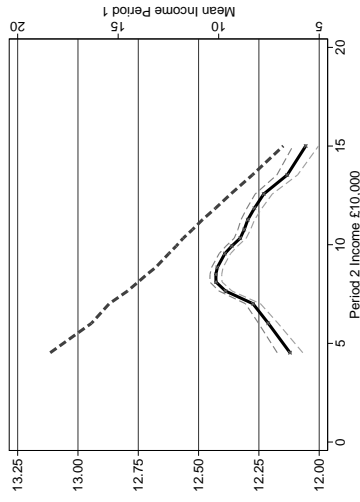
Figure A16: Smaller Bandwidth (C=2). Dependent Variable is Years of Schooling. Paternal Income 6-11.

ai) I3=6.34, PI=24.18



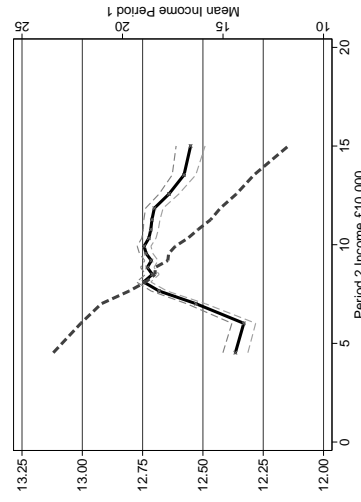
$\alpha_1 = 0.40$  (0.04)  $\alpha_2 = -0.46$  (0.02)

bi) I3=6.34, PI=28.24

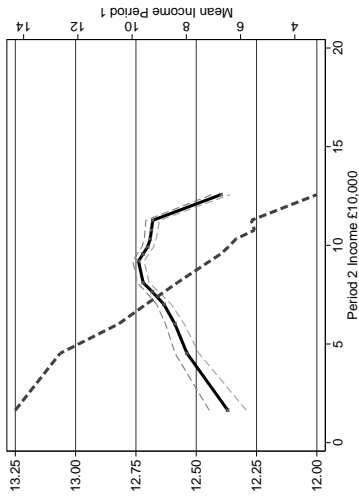


$\alpha_1 = 0.27$  (0.02)  $\alpha_2 = -0.28$  (0.02)

ci) I3=6.34, PI=32.93

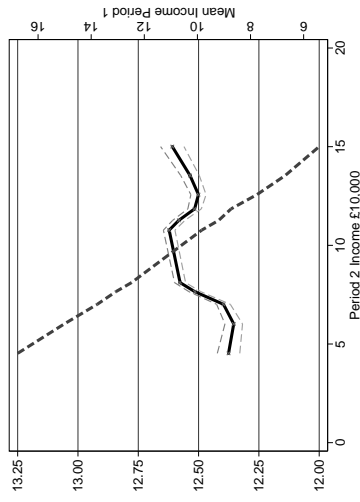


aii) I3=7.49, PI=24.18



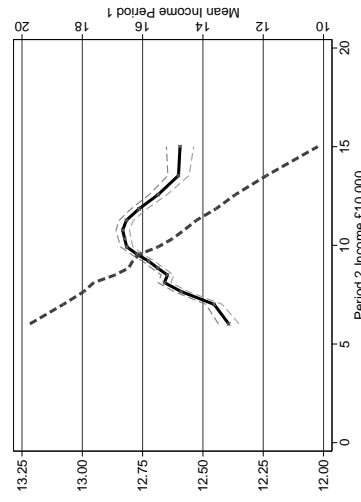
$\alpha_1 = 0.40$  (0.03)  $\alpha_2 = -0.37$  (0.02)

bii) I3=7.49, PI=28.24

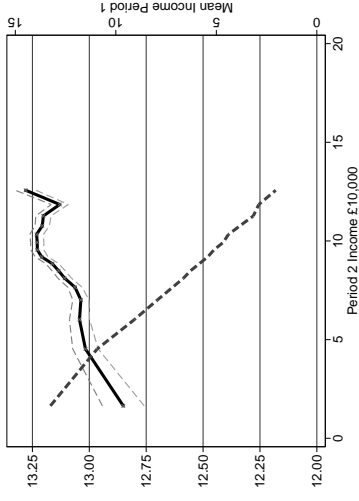


$\alpha_1 = 0.28$  (0.02)  $\alpha_2 = -0.03$  (0.02)

cii) I3=7.49, PI=32.93

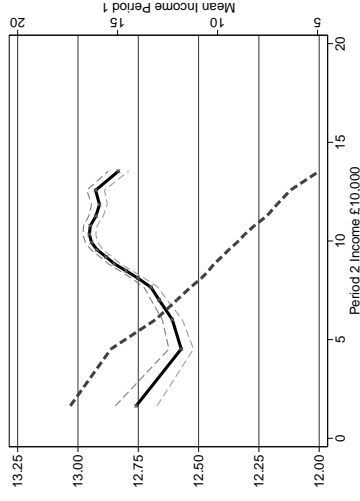


aiii) I3=9.32, PI=24.18



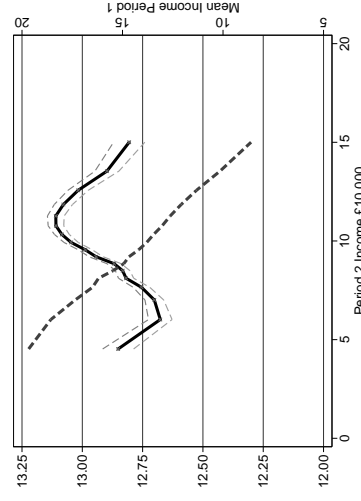
$\alpha_1 = 0.30$  (0.04)  $\alpha_2 = -0.03$  (0.02)

biii) I3=9.32, PI=28.24



$\alpha_1 = 0.06$  (0.04)  $\alpha_2 = -0.08$  (0.02)

ciii) I3=9.32, PI=32.93



$\alpha_1 =$

0.35 (0.02)  $\alpha_2 = -0.15$  (0.03)

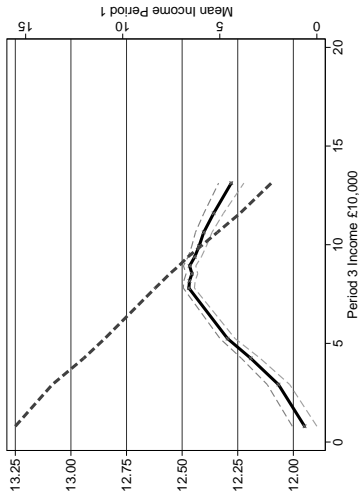
0.39 (0.02)  $\alpha_2 = -0.20$  (0.03)

0.14 (0.03)  $\alpha_2 = -0.18$  (0.04)

Note: 95% confidence intervals shown. Income in 2000 prices, £ 10,000s. Semi-parametric estimates control for dummies for paternal education interacted with age and maternal education interacted with age, paternal income profile, gender and child year of birth.

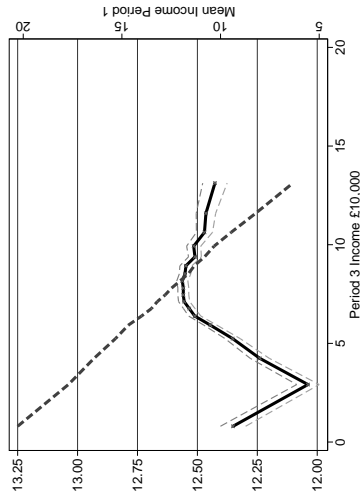
Figure A16: Smaller Bandwidth (C=2). Dependent Variable is Years of Schooling. Paternal Income 12-17.

di) I2=8.13, PI=24.18



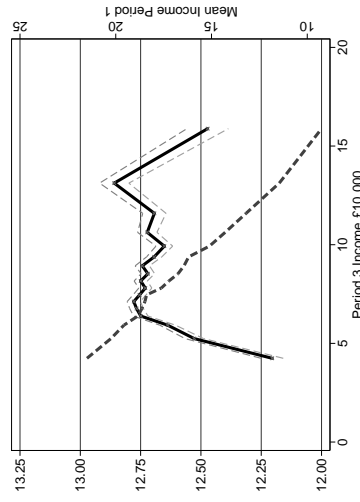
$\alpha_1 = 0.47$  (0.02)  $\alpha_2 = 0.18$  (0.04)

ei) I2=8.13, PI=28.24

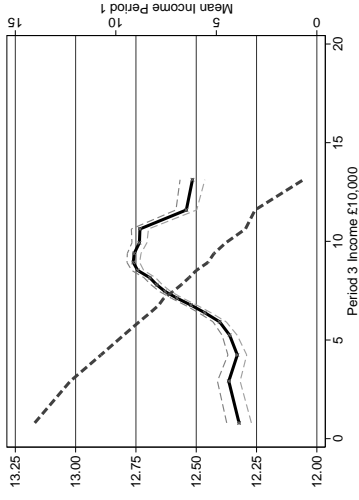


$\alpha_1 = 0.57$  (0.02)  $\alpha_2 = -0.17$  (0.02)

fi) I2=8.13, PI=32.93

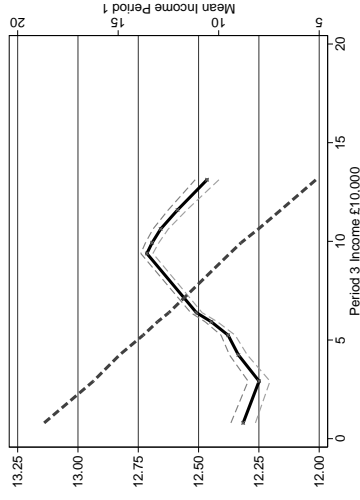


dii) I2=12.39, PI=24.18



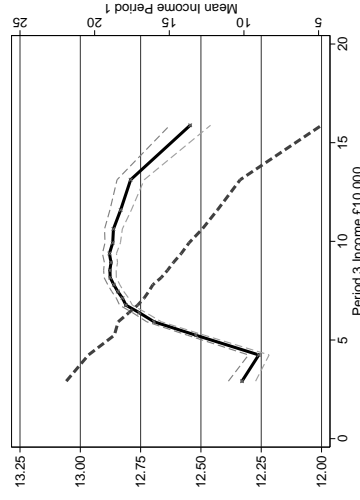
$\alpha_1 = 0.31$  (0.02)  $\alpha_2 = -0.10$  (0.02)

eii) I2=12.39, PI=28.24

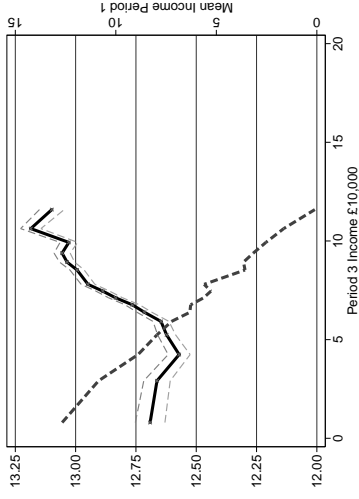


$\alpha_1 = 0.36$  (0.02)  $\alpha_2 = -0.17$  (0.02)

fi) I2=12.39, PI=32.93

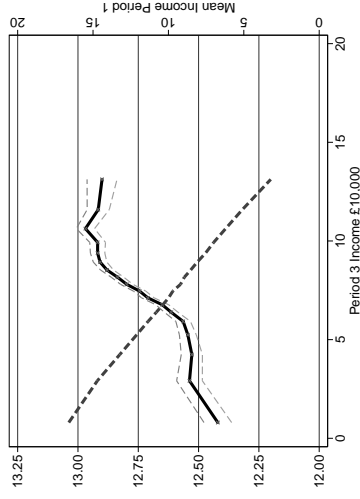


diii) I2=11.26, PI=24.18



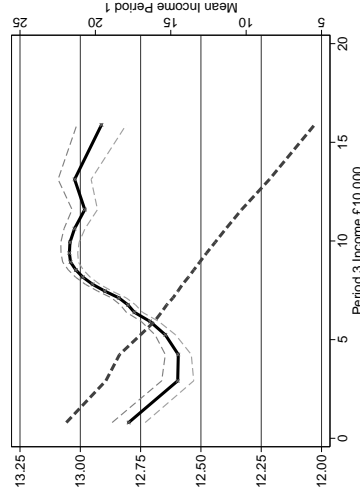
$\alpha_1 = 0.11$  (0.03)  $\alpha_2 = 0.35$  (0.02)

eiii) I2=11.26, PI=28.24



$\alpha_1 = 0.38$  (0.03)  $\alpha_2 = 0.16$  (0.03)

fii) I2=11.26, PI=32.93



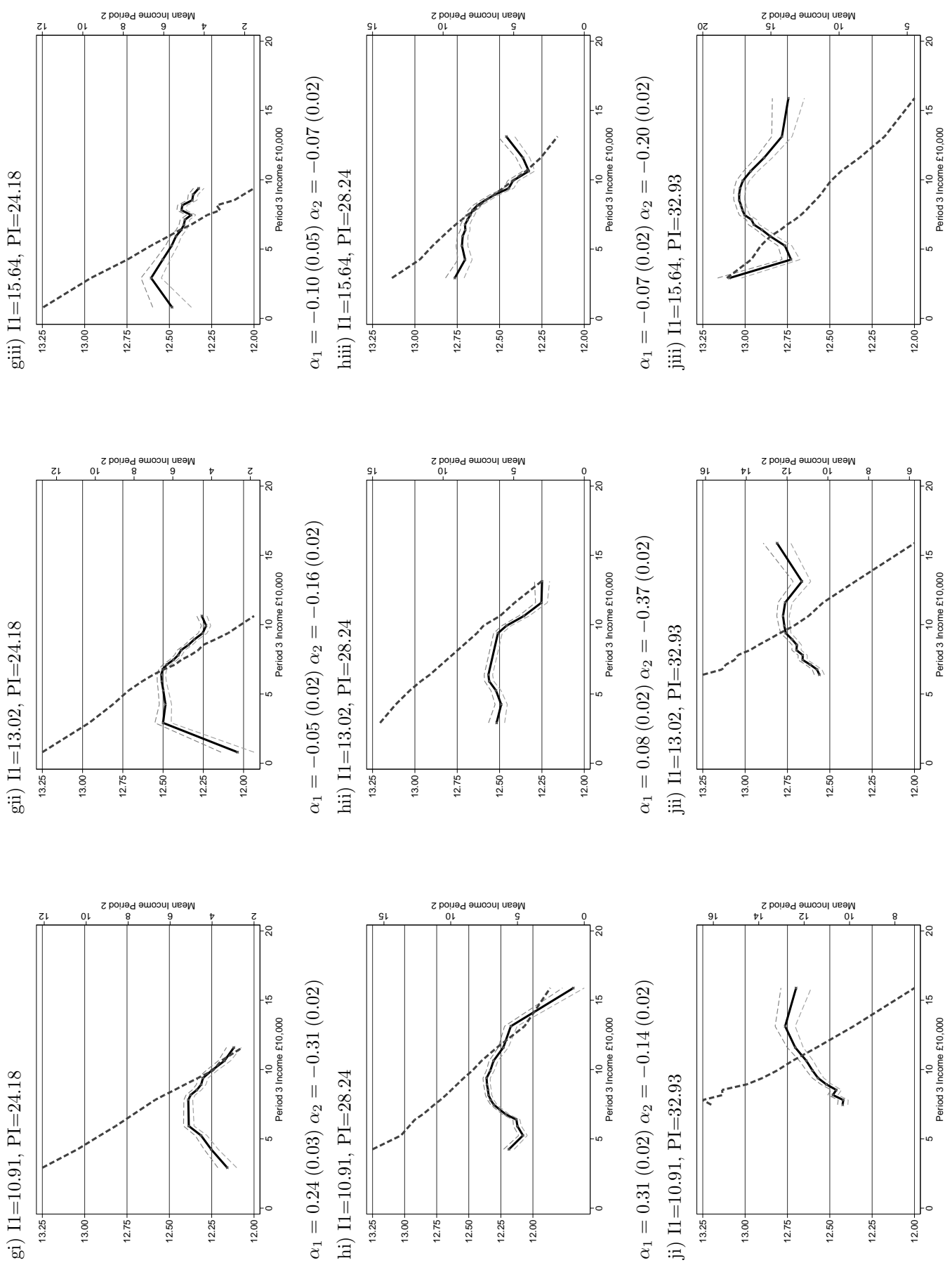
$\alpha_1 = -0.88$  (0.03)  $\alpha_2 = -0.25$  (0.04)

$\alpha_1 = 0.47$  (0.03)  $\alpha_2 = -0.28$  (0.03)

$\alpha_1 = 0.21$  (0.03)  $\alpha_2 = -0.09$  (0.04)

Note: 95% confidence intervals shown. Income in 2000 prices, £ 10,000s. Semi-parametric estimates control for dummies for paternal education interacted with age and maternal education interacted with age, paternal income profile, gender and child year of birth.

Figure A16: Smaller Bandwidth (C=2). Dependent Variable is Years of Schooling. Paternal Income 12-17.

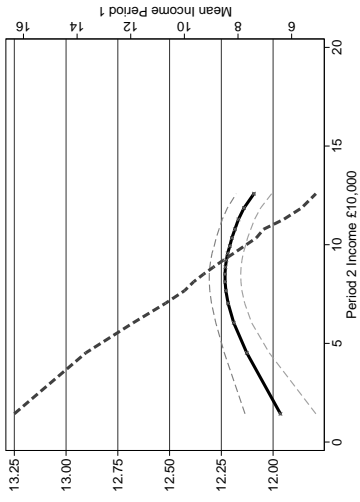


$\alpha_1 = 0.22 (0.02) \alpha_2 = 0.14 (0.04)$   $\alpha_1 = 0.11 (0.02) \alpha_2 = 0.06 (0.04)$   $\alpha_1 = -0.02 (0.03) \alpha_2 = -0.27 (0.04)$   
 Note: 95% confidence intervals shown. Income in 2000 prices, £ 10,000s. Semi-parametric estimates control for dummies for paternal education interacted with age and maternal education interacted with age, paternal income profile, gender and child year of birth.



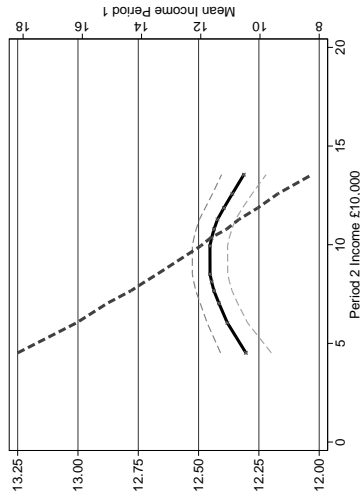
Figure A17: Larger Bandwidth (C=6). Dependent Variable is Years of Schooling. Paternal Income 6-11.

ai) I3=6.34, PI=24.18



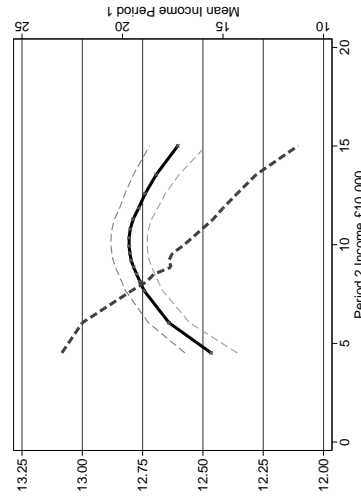
$\alpha_1 = 0.27 (0.10) \alpha_2 = -0.14 (0.06)$

bi) I3=6.34, PI=28.24

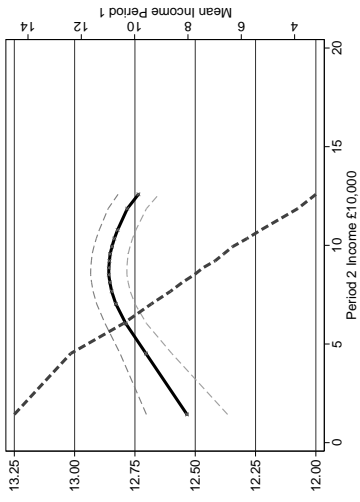


$\alpha_1 = 0.15 (0.07) \alpha_2 = -0.15 (0.06)$

ci) I3=6.34, PI=32.93

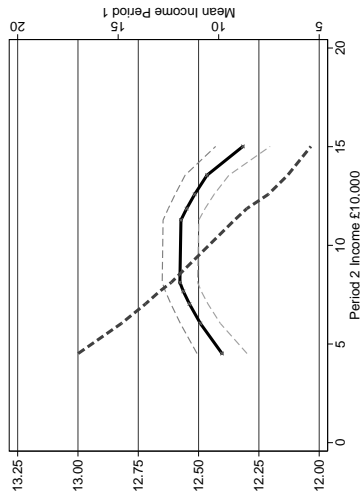


aii) I3=7.49, PI=24.18



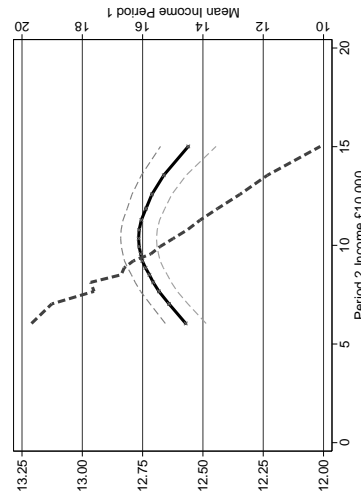
$\alpha_1 = 0.32 (0.09) \alpha_2 = -0.12 (0.06)$

bii) I3=7.49, PI=28.24

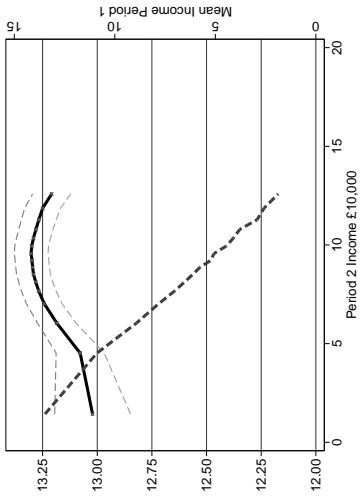


$\alpha_1 = 0.20 (0.06) \alpha_2 = -0.28 (0.07)$

cii) I3=7.49, PI=32.93

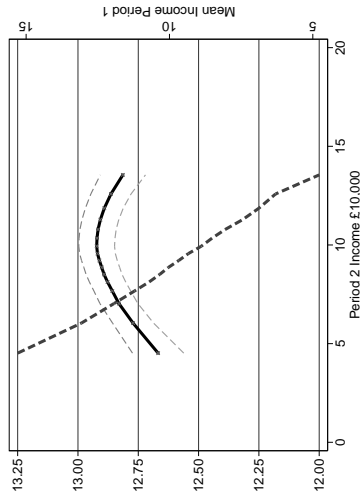


aiii) I3=9.32, PI=24.18



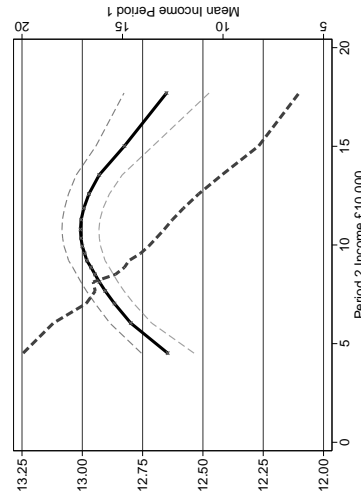
$\alpha_1 = 0.27 (0.10) \alpha_2 = -0.09 (0.06)$

biii) I3=9.32, PI=28.24



$\alpha_1 = 0.30 (0.09) \alpha_2 = -0.10 (0.06)$

ciii) I3=9.32, PI=32.93



$\alpha_1 = 0.34 (0.07) \alpha_2 = -0.20 (0.07)$

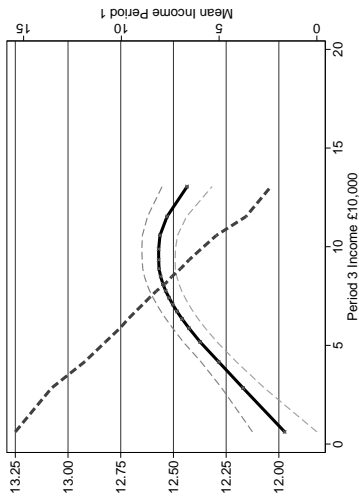
$\alpha_1 = 0.19 (0.06) \alpha_2 = -0.20 (0.07)$

$\alpha_1 = 0.34 (0.07) \alpha_2 = -0.34 (0.10)$

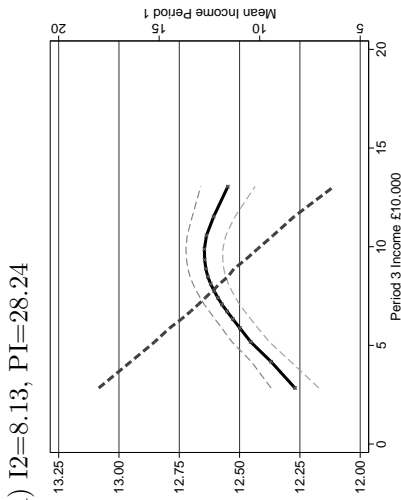
Note: 95% confidence intervals shown. Income in 2000 prices, £ 10,000s. Semi-parametric estimates control for dummies for paternal education interacted with age and maternal education interacted with age, paternal income profile, gender and child year of birth.

Figure A17: Larger Bandwidth (C=6). Dependent Variable is Years of Schooling. Paternal Income 12-17.

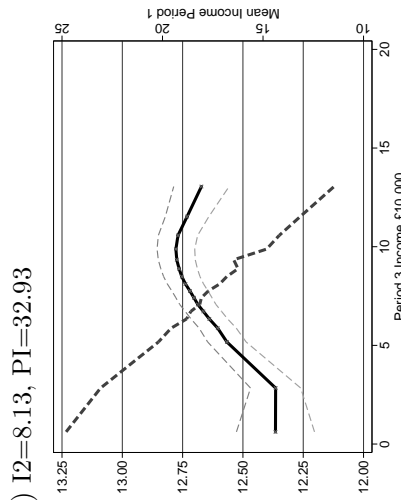
di) I2=8.13, PI=24.18



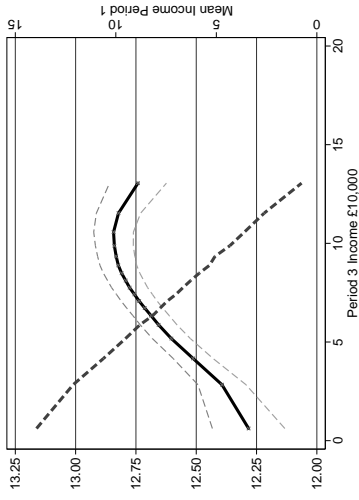
ei) I2=8.13, PI=28.24



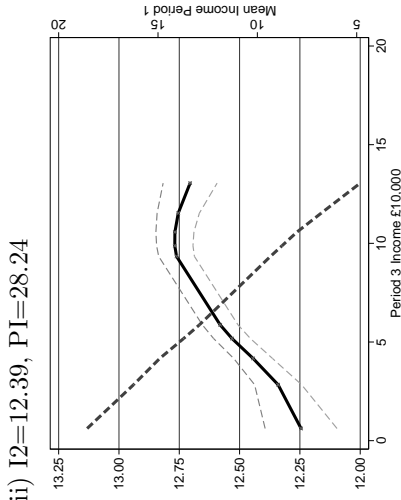
fi) I2=8.13, PI=32.93



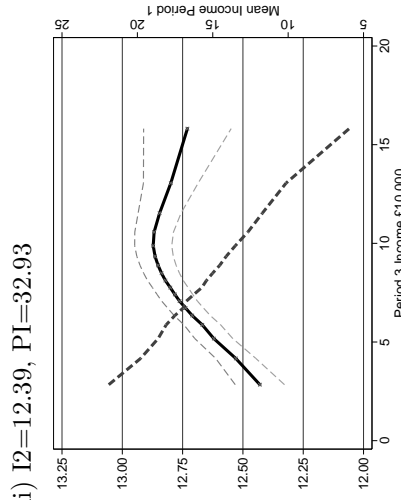
dii) I2=12.39, PI=24.18



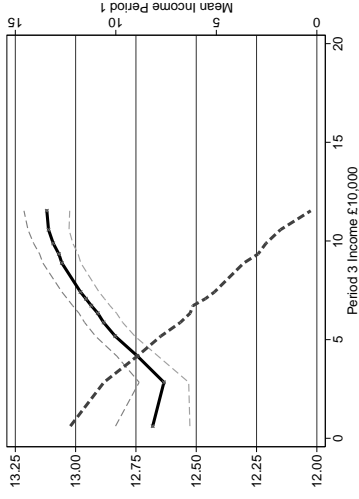
eii) I2=12.39, PI=28.24



fi) I2=12.39, PI=32.93

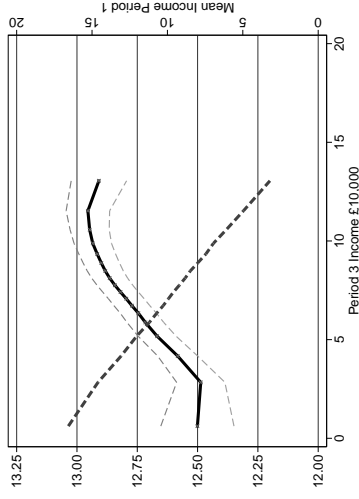


diii) I2=11.26, PI=24.18



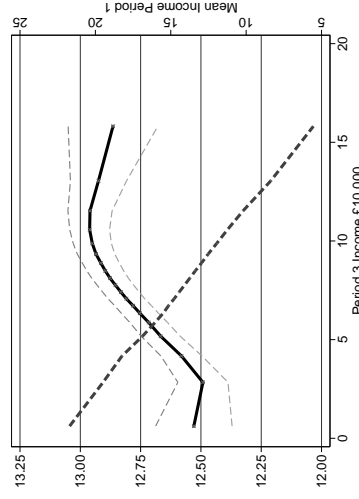
α<sub>1</sub> = 0.25 (0.09) α<sub>2</sub> = 0.18 (0.06)

eiii) I2=11.26, PI=28.24



α<sub>1</sub> = 0.32 (0.09) α<sub>2</sub> = 0.09 (0.07)

fi) I2=11.26, PI=32.93



α<sub>1</sub> = 0.35 (0.09) α<sub>2</sub> = -0.09 (0.10)

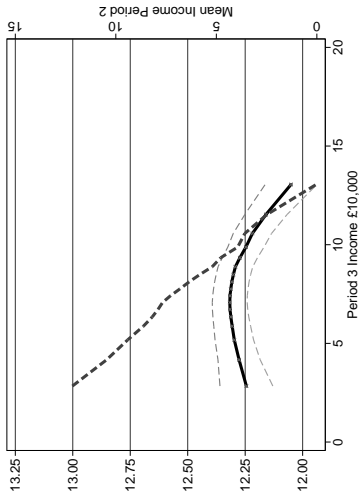
α<sub>1</sub> = 0.37 (0.06) α<sub>2</sub> = -0.07 (0.10)

α<sub>1</sub> = 0.32 (0.09) α<sub>2</sub> = 0.01 (0.10)

Note: 95% confidence intervals shown. Income in 2000 prices, £ 10,000s. Semi-parametric estimates control for dummies for paternal education interacted with age and maternal education interacted with age, paternal income profile, gender and child year of birth.

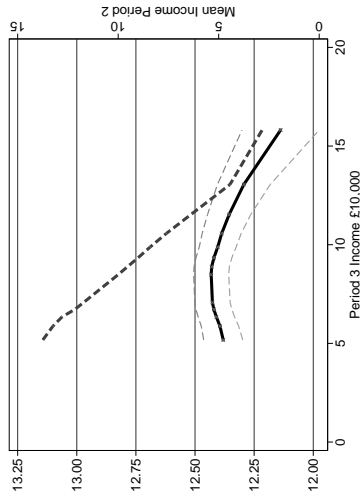
Figure A17: Larger Bandwidth (C=6). Dependent Variable is Years of Schooling. Paternal Income 12-17.

gi)  $II=10.91, PI=24.18$



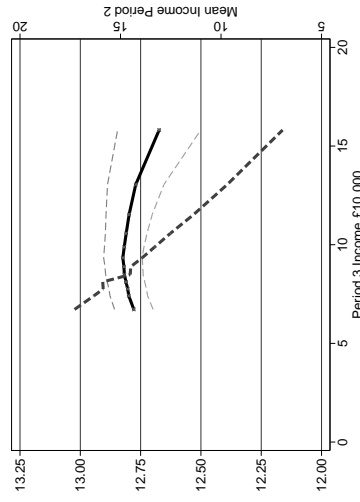
$\alpha_1 = 0.07 (0.07) \alpha_2 = -0.16 (0.06)$

hi)  $II=10.91, PI=28.24$

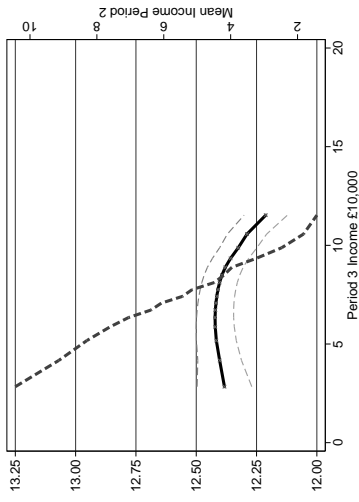


$\alpha_1 = 0.05 (0.06) \alpha_2 = -0.14 (0.07)$

ji)  $II=10.91, PI=32.93$

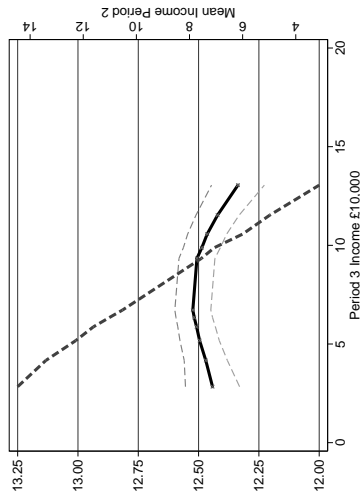


gii)  $II=13.02, PI=24.18$



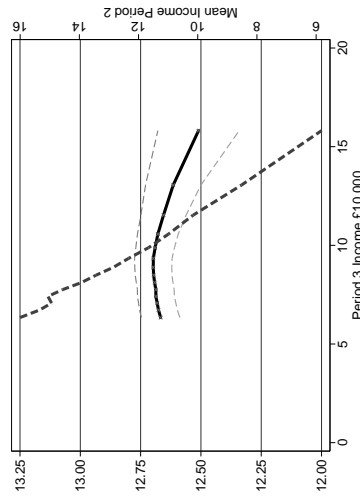
$\alpha_1 = 0.03 (0.07) \alpha_2 = -0.13 (0.06)$

hii)  $II=13.02, PI=28.24$

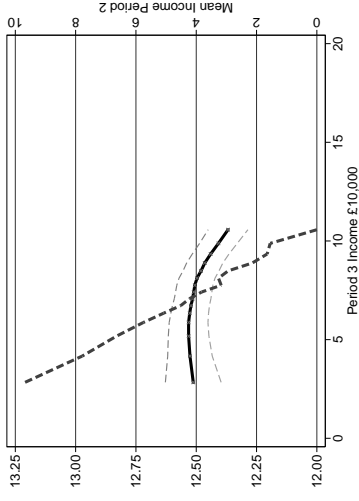


$\alpha_1 = 0.09 (0.07) \alpha_2 = -0.19 (0.07)$

jii)  $II=13.02, PI=32.93$

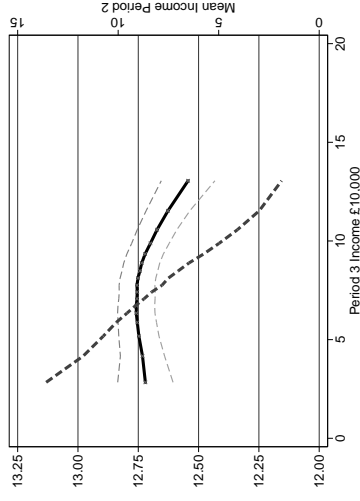


giii)  $II=15.64, PI=24.18$



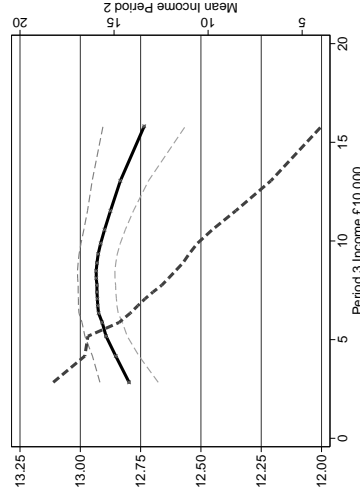
$\alpha_1 = -0.06 (0.11) \alpha_2 = -0.11 (0.06)$

hiii)  $II=15.64, PI=28.24$



$\alpha_1 = 0.03 (0.07) \alpha_2 = -0.21 (0.07)$

jiij)  $II=15.64, PI=32.93$



$\alpha_1 = 0.04 (0.06) \alpha_2 = -0.15 (0.10)$

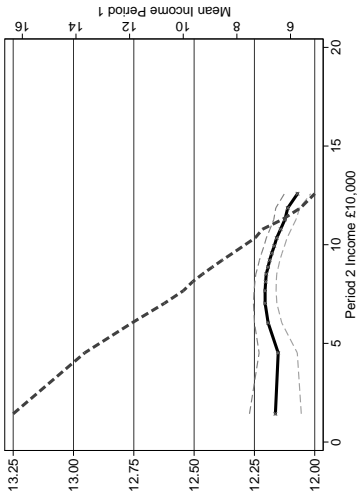
$\alpha_1 = 0.03 (0.06) \alpha_2 = -0.19 (0.09)$

$\alpha_1 = 0.13 (0.07) \alpha_2 = -0.20 (0.10)$

Note: 95% confidence intervals shown. Income in 2000 prices, £ 10,000s. Semi-parametric estimates control for dummies for paternal education interacted with age and maternal education interacted with age, paternal income profile, gender and child year of birth.

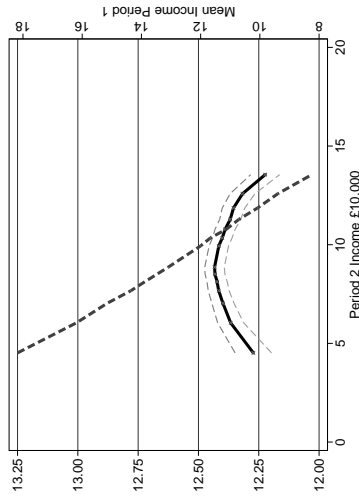
Figure A18: Endogenous Controls. Dependent Variable is Years of Schooling. Paternal Income 6-11.

ai) I3=6.34, PI=24.18



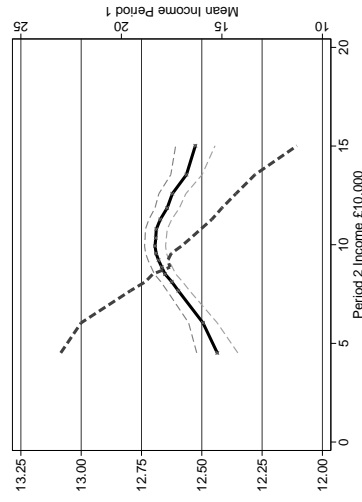
$\alpha_1 = 0.03$  (0.06)  $\alpha_2 = -0.12$  (0.04)

bi) I3=6.34, PI=28.24

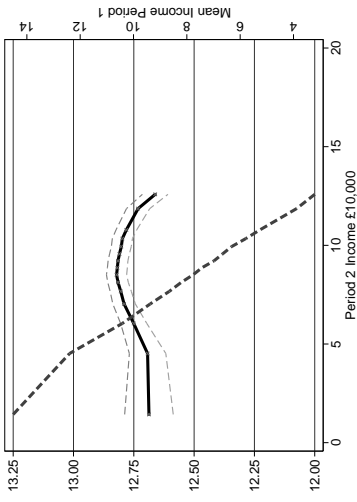


$\alpha_1 = 0.16$  (0.04)  $\alpha_2 = -0.21$  (0.04)

ci) I3=6.34, PI=32.93

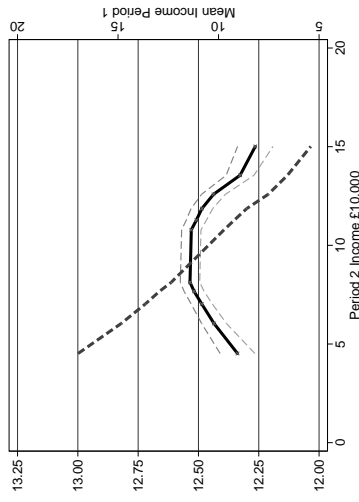


aii) I3=7.49, PI=24.18



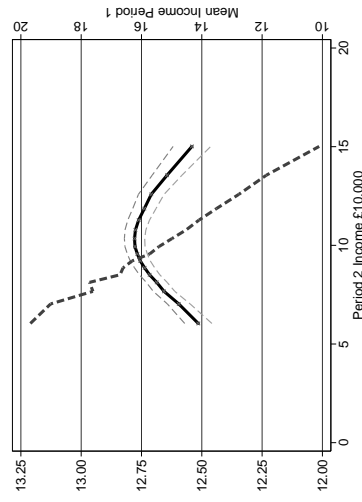
$\alpha_1 = 0.13$  (0.06)  $\alpha_2 = -0.16$  (0.03)

bii) I3=7.49, PI=28.24

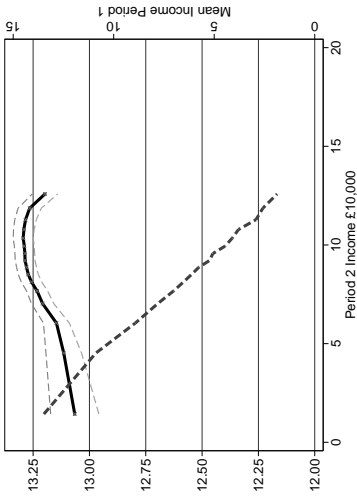


$\alpha_1 = 0.22$  (0.04)  $\alpha_2 = -0.29$  (0.04)

cii) I3=7.49, PI=32.93

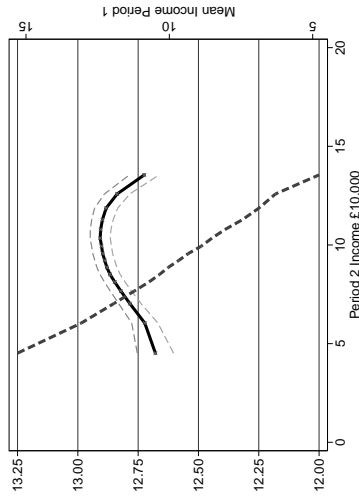


aiii) I3=9.32, PI=24.18



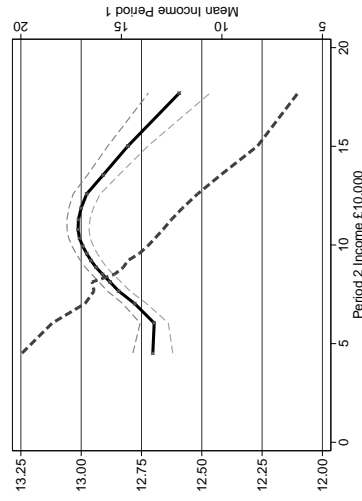
$\alpha_1 = 0.21$  (0.06)  $\alpha_2 = -0.08$  (0.04)

biii) I3=9.32, PI=28.24



$\alpha_1 = 0.19$  (0.06)  $\alpha_2 = -0.16$  (0.04)

ciii) I3=9.32, PI=32.93



$\alpha_1 = 0.25$  (0.05)  $\alpha_2 = -0.16$  (0.05)

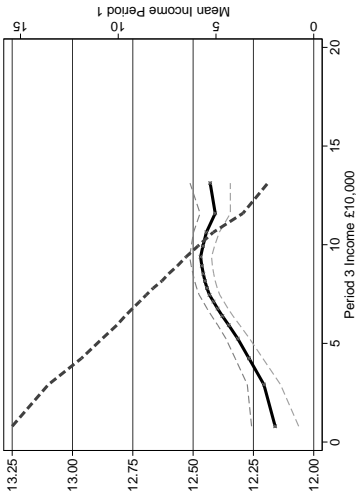
$\alpha_1 = 0.25$  (0.04)  $\alpha_2 = -0.23$  (0.05)

$\alpha_1 = 0.27$  (0.05)  $\alpha_2 = -0.38$  (0.07)

Note: 95% confidence intervals shown. Income in 2000 prices, £ 10,000s. Semi-parametric estimates control for dummies for paternal education interacted with age and maternal education interacted with age, paternal income profile, gender, child year of birth, marital status and number of children.

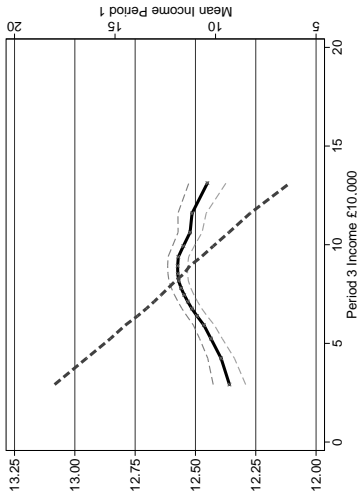
Figure A18: Endogenous Controls. Dependent Variable is Years of Schooling. Paternal Income 12-17.

di) I2=8.13, PI=24.18



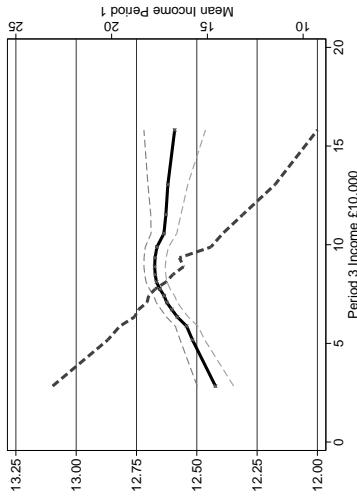
$\alpha_1 = 0.28$  (0.05)  $\alpha_2 = -0.32$  (0.07)

ei) I2=8.13, PI=28.24



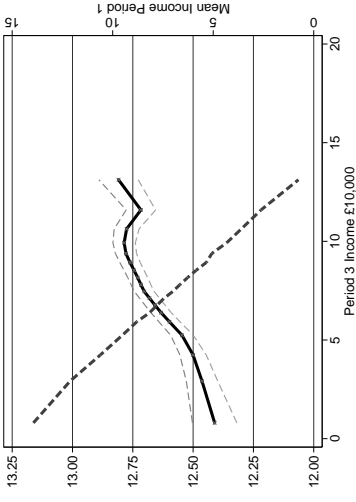
$\alpha_1 = 0.20$  (0.04)  $\alpha_2 = -0.11$  (0.04)

fi) I2=8.13, PI=32.93



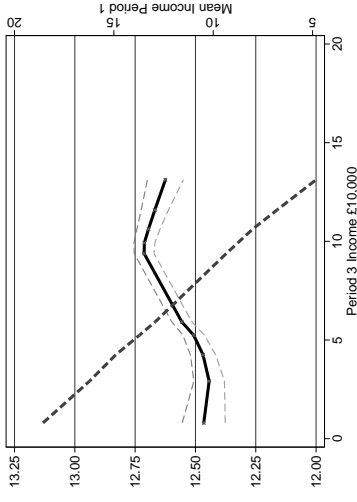
$\alpha_1 = 0.02$  (0.06)  $\alpha_2 = -0.06$  (0.07)

dii) I2=12.39, PI=24.18



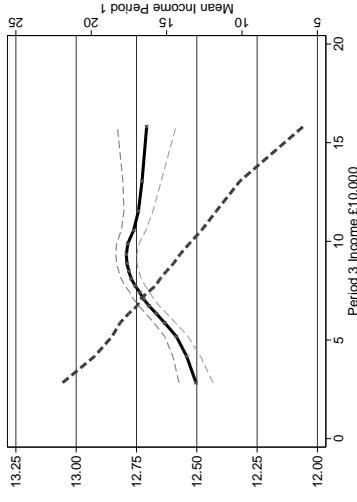
$\alpha_1 = 0.29$  (0.05)  $\alpha_2 = 0.11$  (0.05)

eii) I2=12.39, PI=28.24



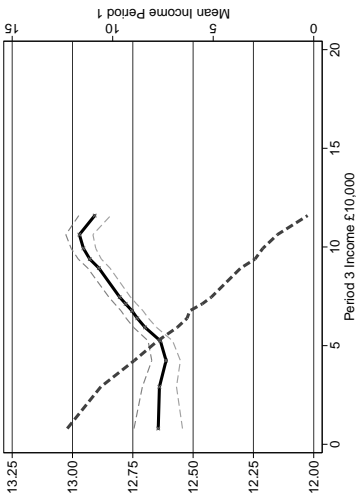
$\alpha_1 = 0.19$  (0.05)  $\alpha_2 = -0.03$  (0.04)

fii) I2=12.39, PI=32.93



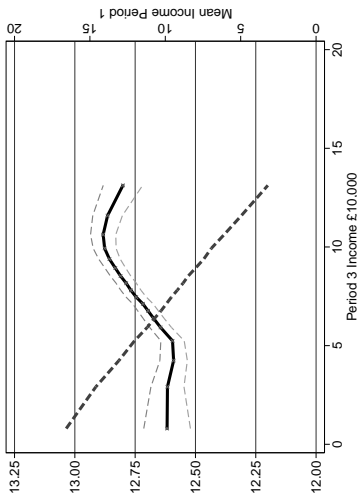
$\alpha_1 = 0.25$  (0.04)  $\alpha_2 = -0.05$  (0.07)

diii) I2=11.26, PI=24.18



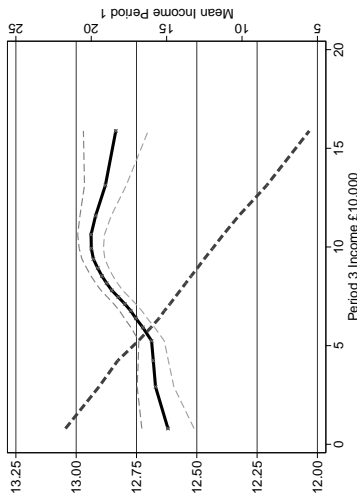
$\alpha_1 = 0.11$  (0.06)  $\alpha_2 = 0.15$  (0.04)

eiii) I2=11.26, PI=28.24



$\alpha_1 = 0.13$  (0.05)  $\alpha_2 = 0.06$  (0.05)

fiii) I2=11.26, PI=32.93

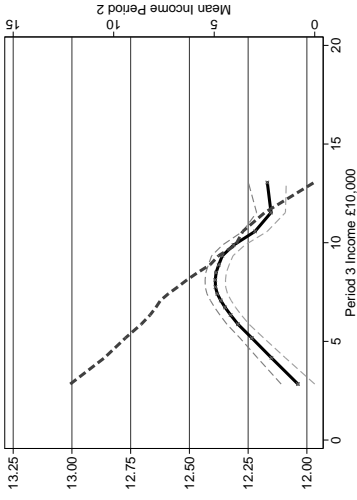


$\alpha_1 = 0.23$  (0.06)  $\alpha_2 = -0.02$  (0.07)

Note: 95% confidence intervals shown. Income in 2000 prices, £ 10,000s. Semi-parametric estimates control for dummies for paternal education interacted with age and maternal education interacted with age, paternal income profile, gender, child year of birth, marital status and number of children

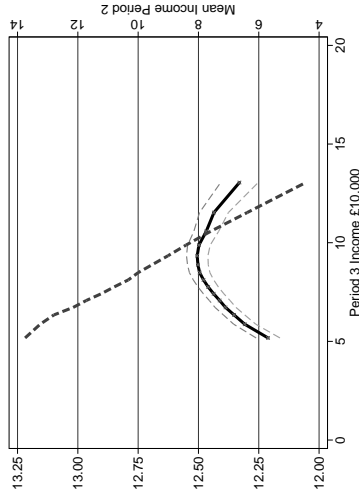
Figure A18: Endogenous Controls. Dependent Variable is Years of Schooling. Paternal Income 12-17.

gi)  $\text{II}=10.91, \text{PI}=24.18$



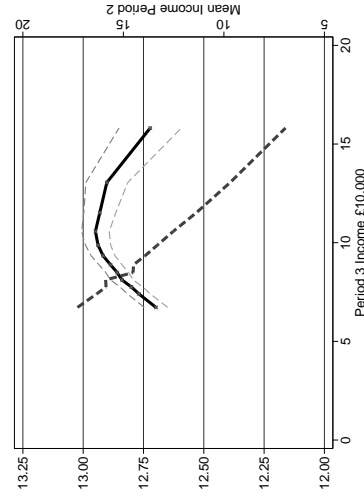
$\alpha_1 = 0.33 (0.04) \alpha_2 = -0.05 (0.03)$

hi)  $\text{II}=10.91, \text{PI}=28.24$



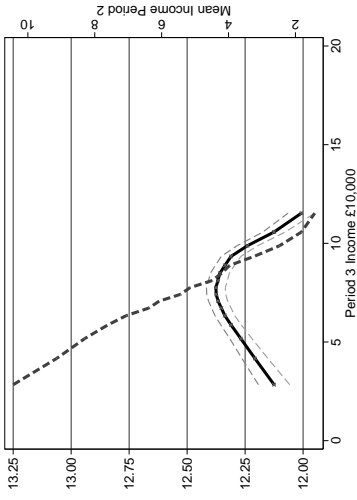
$\alpha_1 = 0.25 (0.03) \alpha_2 = -0.02 (0.04)$

ji)  $\text{II}=10.91, \text{PI}=32.93$



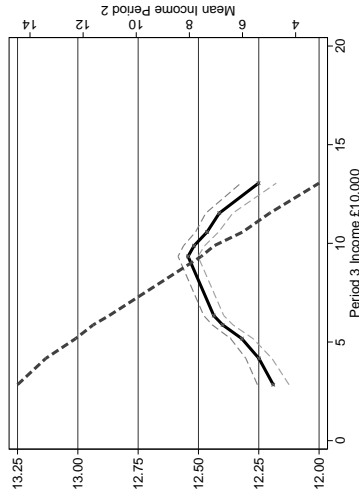
$\alpha_1 = 0.19 (0.03) \alpha_2 = 0.02 (0.05)$

gii)  $\text{II}=13.02, \text{PI}=24.18$



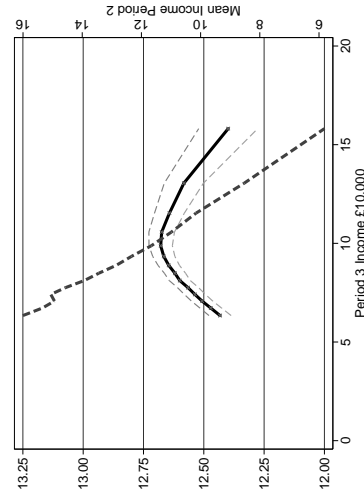
$\alpha_1 = 0.24 (0.04) \alpha_2 = -0.13 (0.03)$

hii)  $\text{II}=13.02, \text{PI}=28.24$



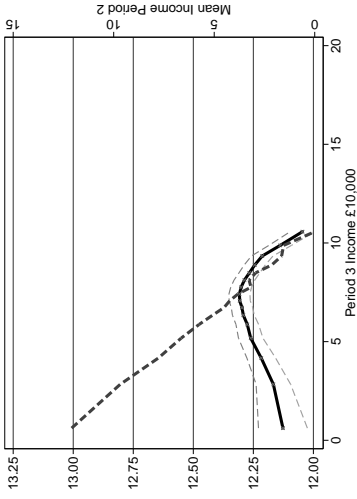
$\alpha_1 = 0.21 (0.03) \alpha_2 = -0.11 (0.03)$

jii)  $\text{II}=13.02, \text{PI}=32.93$



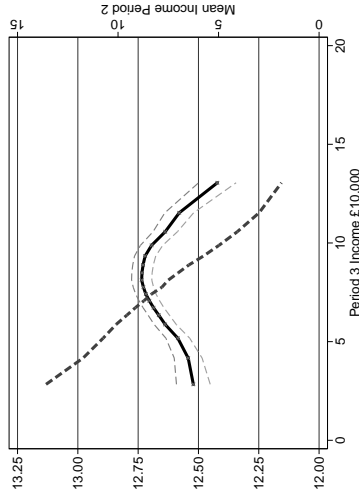
$\alpha_1 = 0.19 (0.03) \alpha_2 = -0.04 (0.05)$

giii)  $\text{II}=15.64, \text{PI}=24.18$



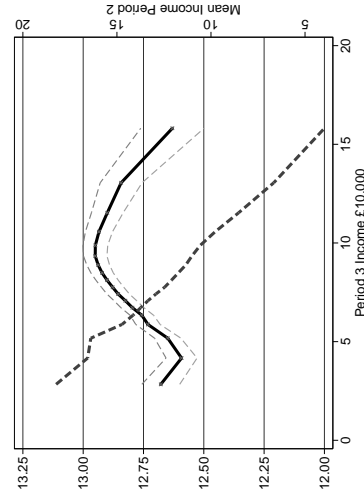
$\alpha_1 = 0.14 (0.04) \alpha_2 = -0.17 (0.03)$

hiii)  $\text{II}=15.64, \text{PI}=28.24$



$\alpha_1 = 0.14 (0.03) \alpha_2 = -0.15 (0.04)$

ji)  $\text{II}=15.64, \text{PI}=32.93$

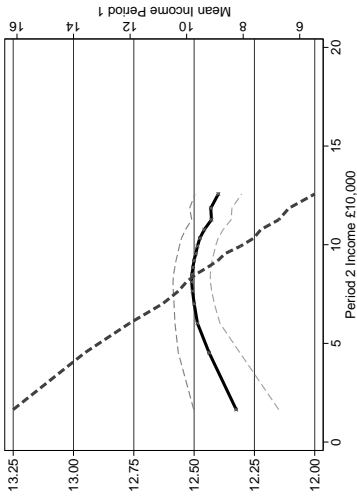


$\alpha_1 = 0.16 (0.03) \alpha_2 = -0.08 (0.05)$

Note: 95% confidence intervals shown. Income in 2000 prices, £ 10,000s. Semi-parametric estimates control for dummies for paternal education interacted with age and maternal education interacted with age, paternal income profile, gender, child year of birth, marital status and number of children

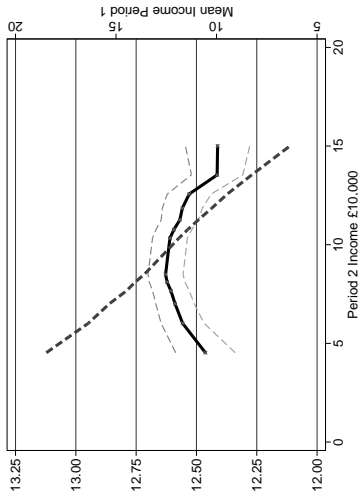
Figure A19: Continuously Married Sample. Dependent Variable is Years of Schooling. Paternal Income 6-11.

ai) I3=6.34, PI=24.18



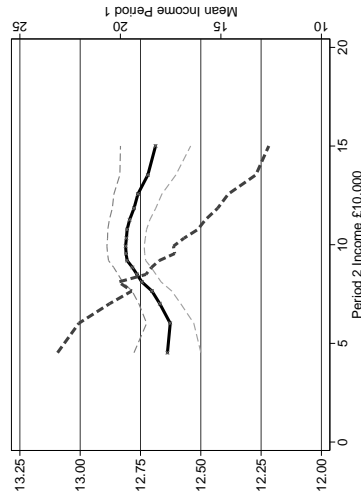
$\alpha_1 = 0.19$  (0.08)  $\alpha_2 = -0.11$  (0.05)

bi) I3=6.34, PI=28.24



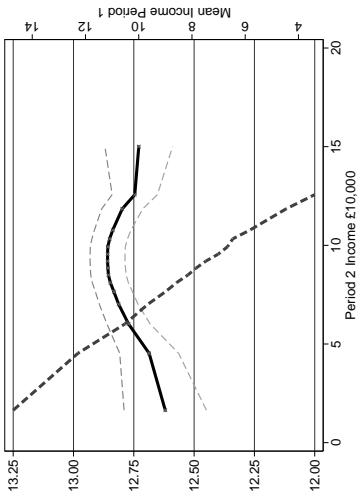
$\alpha_1 = 0.15$  (0.06)  $\alpha_2 = -0.20$  (0.06)

ci) I3=6.34, PI=32.93



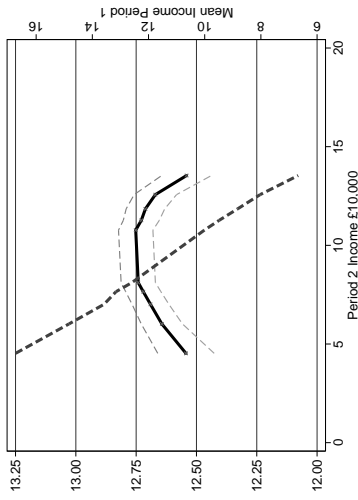
$\alpha_1 = 0.16$  (0.07)  $\alpha_2 = -0.24$  (0.09)

aii) I3=7.49, PI=24.18



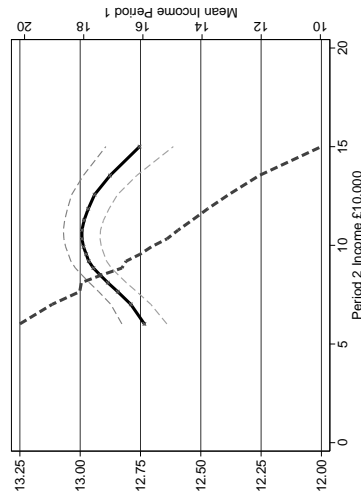
$\alpha_1 = 0.23$  (0.08)  $\alpha_2 = -0.21$  (0.07)

bii) I3=7.49, PI=28.24



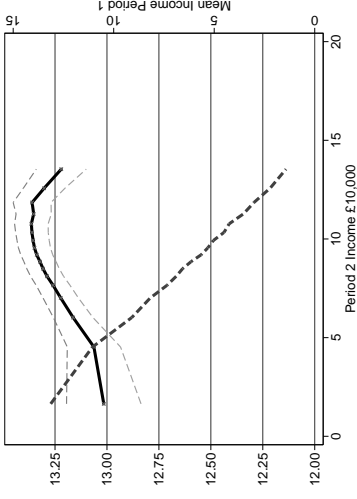
$\alpha_1 = 0.21$  (0.06)  $\alpha_2 = -0.22$  (0.05)

cii) I3=7.49, PI=32.93



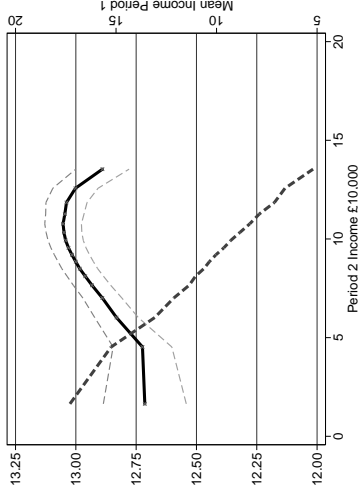
$\alpha_1 = 0.27$  (0.06)  $\alpha_2 = -0.21$  (0.07)

aiii) I3=9.32, PI=24.18



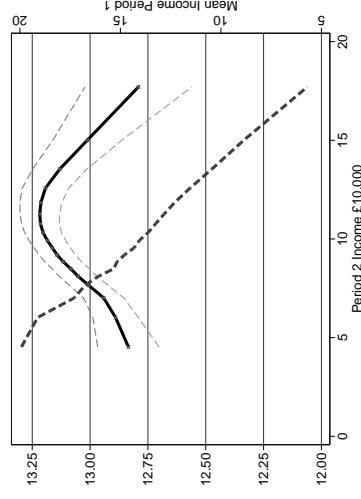
$\alpha_1 = 0.32$  (0.08)  $\alpha_2 = -0.13$  (0.06)

biii) I3=9.32, PI=28.24



$\alpha_1 = 0.28$  (0.08)  $\alpha_2 = -0.14$  (0.06)

ciii) I3=9.32, PI=32.93

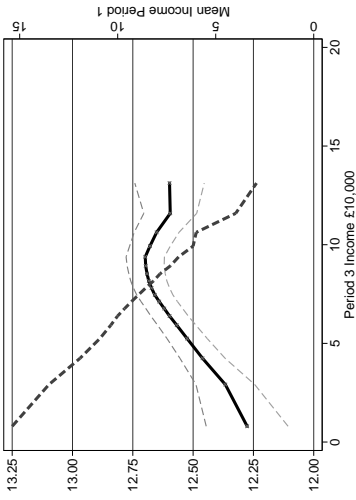


$\alpha_1 = 0.31$  (0.06)  $\alpha_2 = -0.45$  (0.10)

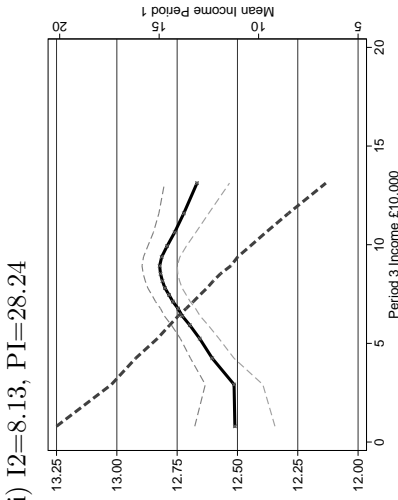
Note: 95% confidence intervals shown. Income in 2000 prices, £ 10,000s. Semi-parametric estimates control for dummies for paternal education interacted with age and maternal education interacted with age, paternal income profile, gender and child year of birth.

Figure A19: Continuously Married Sample. Dependent Variable is Years of Schooling. Paternal Income 12-17.

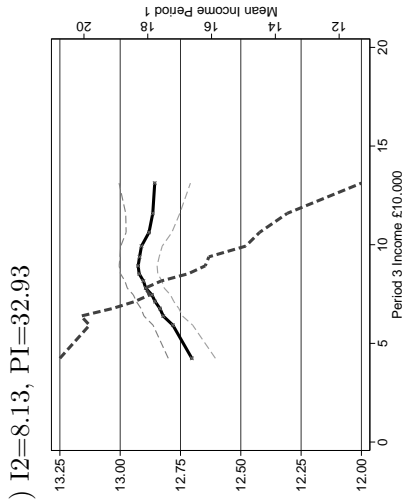
di) I2=8.13, PI=24.18



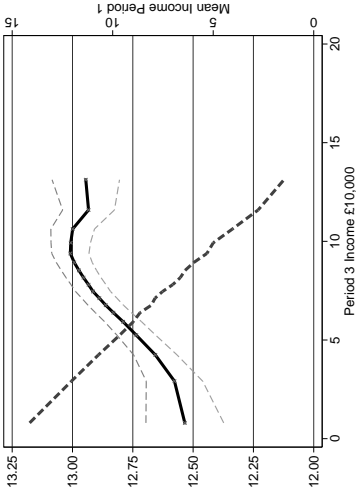
ei) I2=8.13, PI=28.24



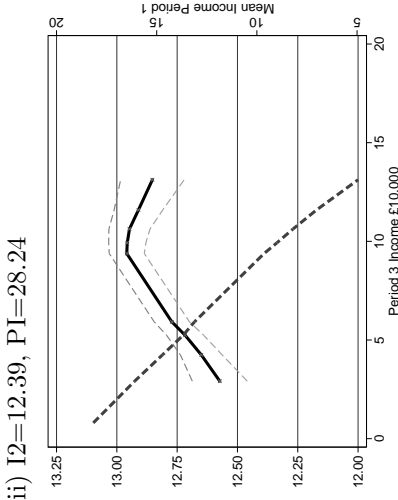
fi) I2=8.13, PI=32.93



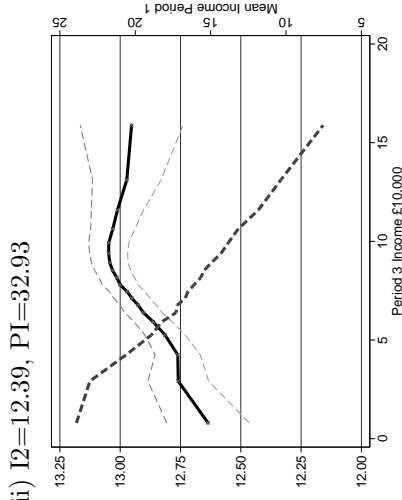
dii) I2=12.39, PI=24.18



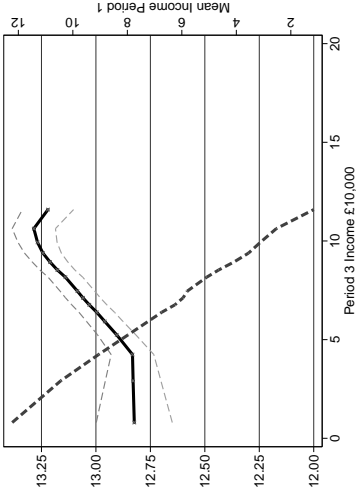
eii) I2=12.39, PI=28.24



fi) I2=12.39, PI=32.93

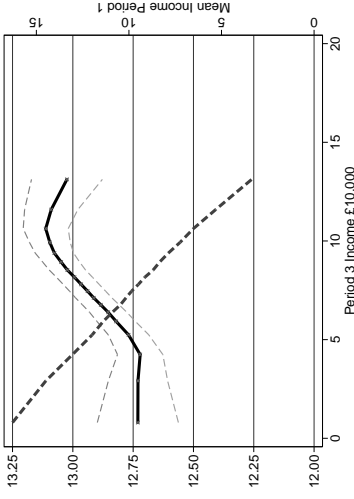


diii) I2=11.26, PI=24.18



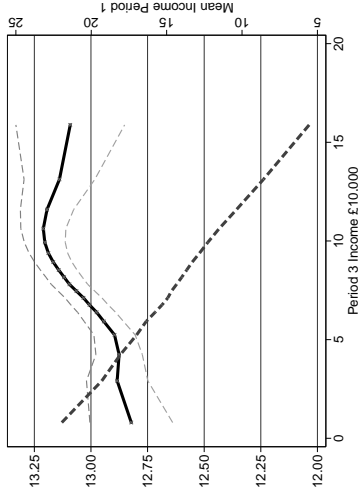
α<sub>1</sub> = 0.24 (0.08) α<sub>2</sub> = 0.17 (0.06)

eiii) I2=11.26, PI=28.24



α<sub>1</sub> = 0.25 (0.08) α<sub>2</sub> = -0.01 (0.10)

fi) I2=11.26, PI=32.93



α<sub>1</sub> = 0.23 (0.06) α<sub>2</sub> = -0.05 (0.10)

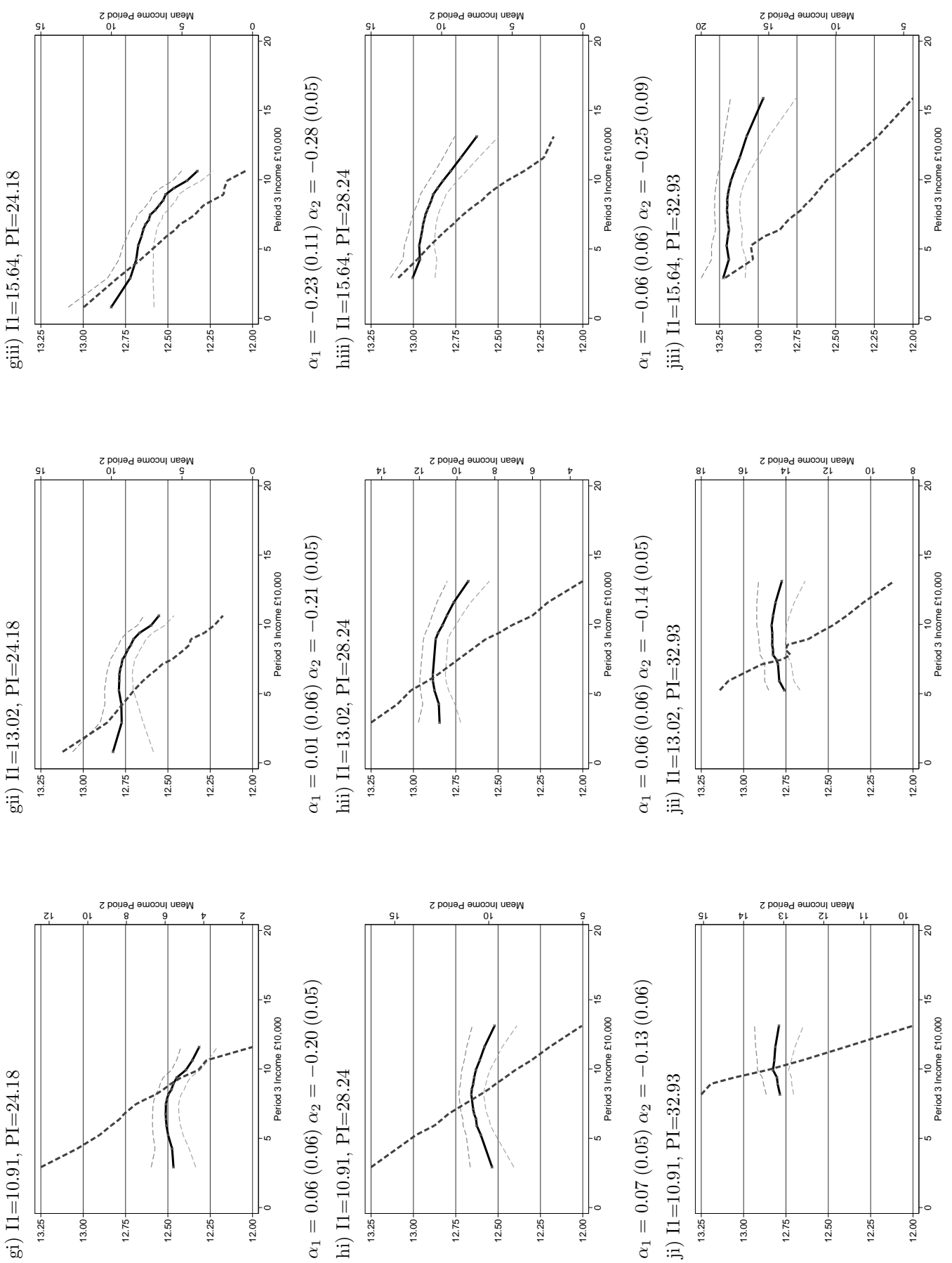
α<sub>1</sub> = 0.43 (0.08) α<sub>2</sub> = -0.06 (0.09)

α<sub>1</sub> = 0.34 (0.08) α<sub>2</sub> = -0.02 (0.11)

Note: 95% confidence intervals shown. Income in 2000 prices, £ 10,000s. Semi-parametric estimates control for dummies for paternal education interacted with age and maternal education interacted with age, paternal income profile, gender and child year of birth.

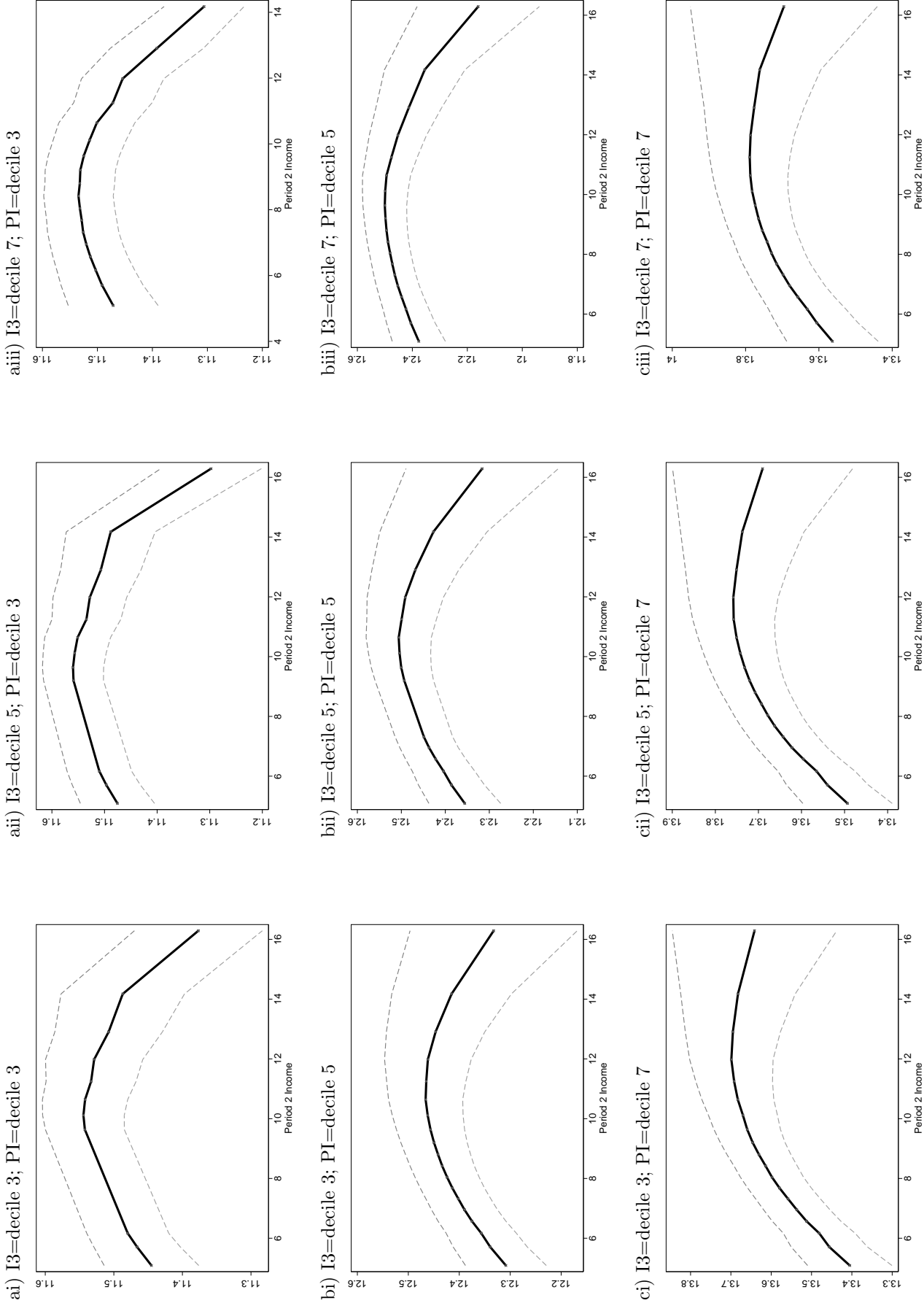


Figure A19: Continuously Married Sample. Dependent Variable is Years of Schooling. Paternal Income 12-17.



$\alpha_1 = 0.17 (0.06) \alpha_2 = -0.07 (0.10)$   $\alpha_1 = 0.07 (0.05) \alpha_2 = -0.06 (0.07)$   $\alpha_1 = 0.01 (0.07) \alpha_2 = -0.23 (0.09)$   
 Note: 95% confidence intervals shown. Income in 2000 prices, £ 10,000s. Semi-parametric estimates control for dummies for paternal education interacted with age and maternal education interacted with age, paternal income profile, gender and child year of birth.

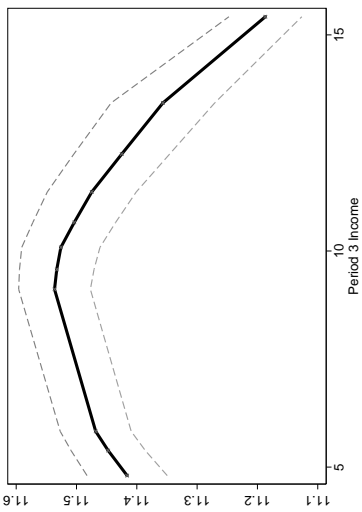
Figure A20: Simulated Years of Schooling and Paternal Income 6-11. Basic Model with Income Uncertainty.



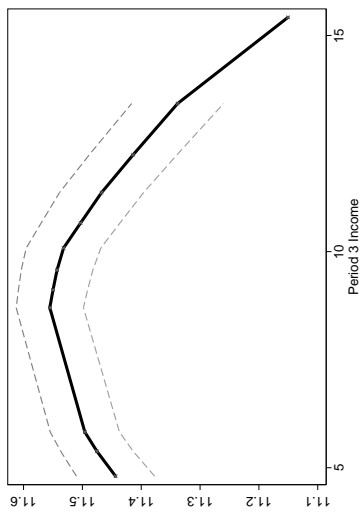
Note: Income in 2000 prices, £ 10,000s. Period 2 refers to age 6-11. Simulated data based on 100,000 draws of income shocks per period. Estimated technology parameters and years of schooling obtained by simulated method of moments, matching percentiles 10, 25, 50, 75 and 90 of each per-period income.

Figure A20: Simulated Years of Schooling and Paternal Income 12-17. Basic Model with Income Uncertainty.

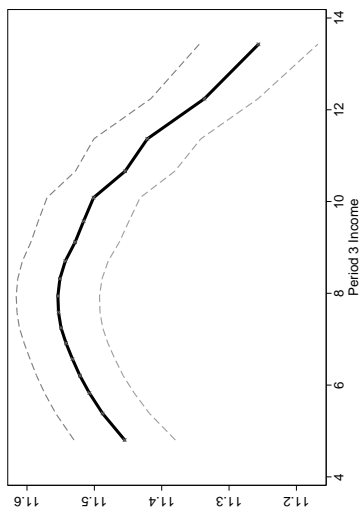
di) I2=decile 3; PI=decile 3



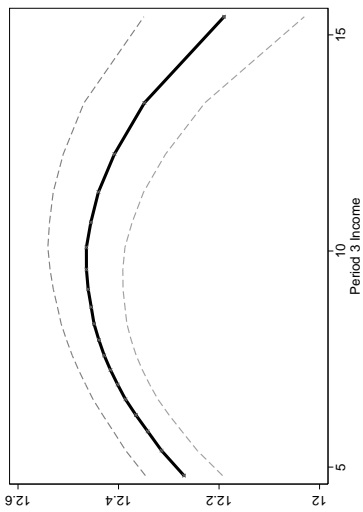
dii) I2=decile 5; PI=decile



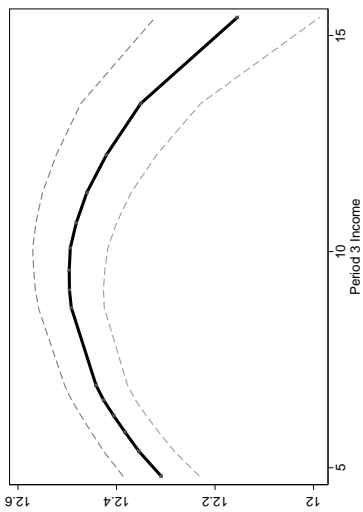
diii) I2=decile 7; PI=decile 3



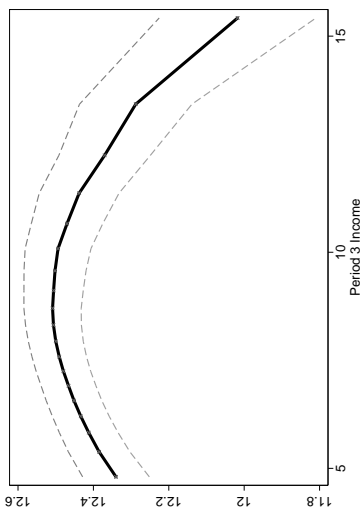
ei) I2=decile 3; PI=decile



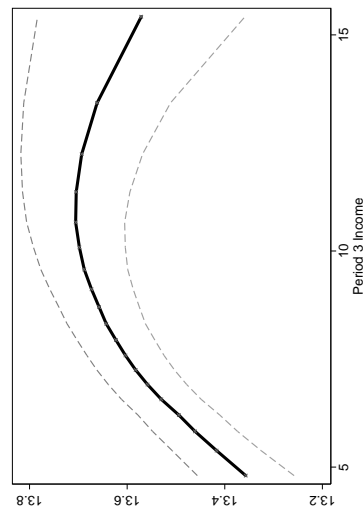
eii) I2=decile 5; PI=decile 5



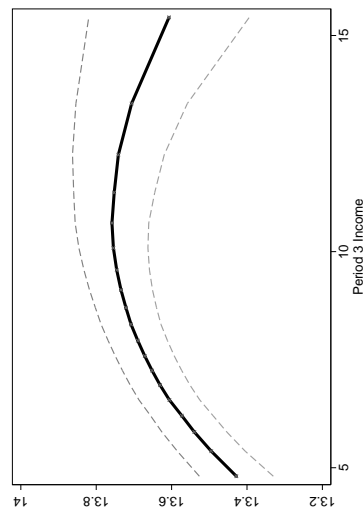
eiii) I2=decile 7; PI=decile



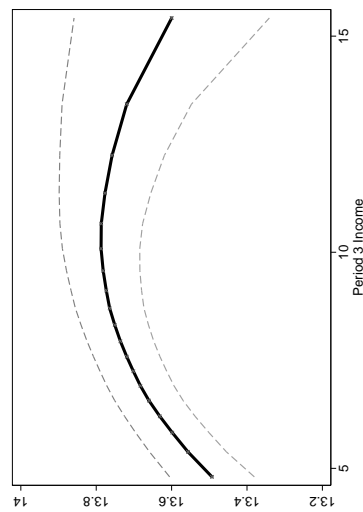
fi) I2=decile 3; PI=decile 7



fii) I2=decile 5; PI=decile 7



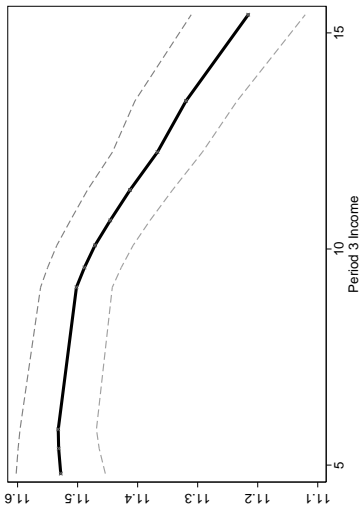
fiii) I2=decile 7; PI=decile 7



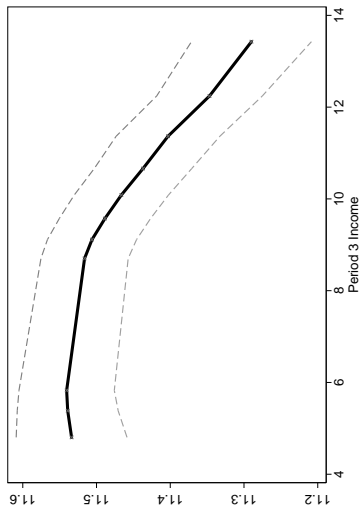
Note: Income in 2000 prices, £ 10,000s. Period 3 refers to age 12-17. Simulated data based on 100,000 draws of income shocks per period. Estimated technology parameters and years of schooling obtained by simulated method of moments, matching percentiles 10, 25, 50, 75 and 90 of each per-period income.

Figure A20: Simulated Years of Schooling and Paternal Income 12-17. Basic Model with Income Uncertainty.

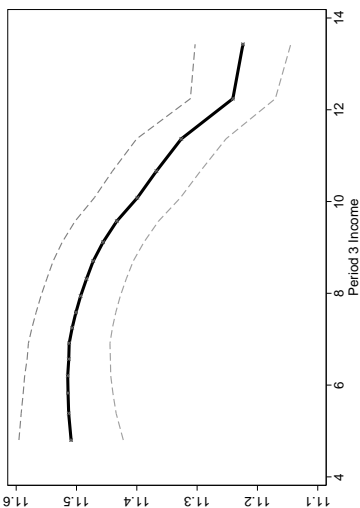
gi)  $\Pi$ =decile 3;  $PI$ =decile 3



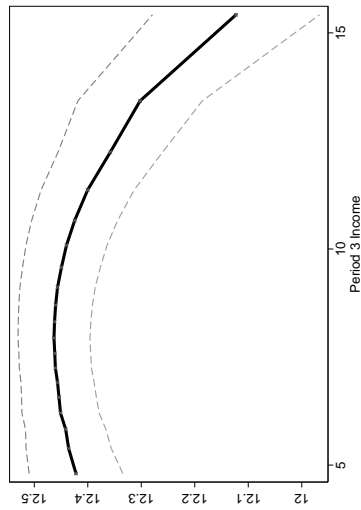
gii)  $\Pi$ =decile 5;  $PI$ =decile



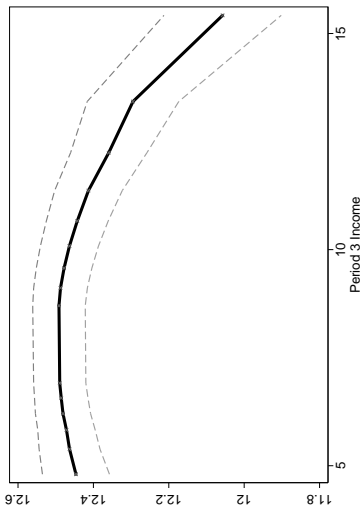
giii)  $\Pi$ =decile 7;  $PI$ =decile 3



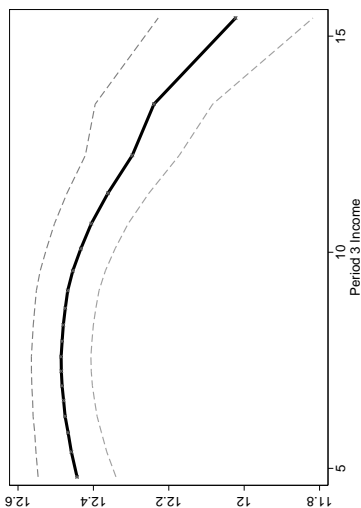
hi)  $\Pi$ =decile 3;  $PI$ =decile



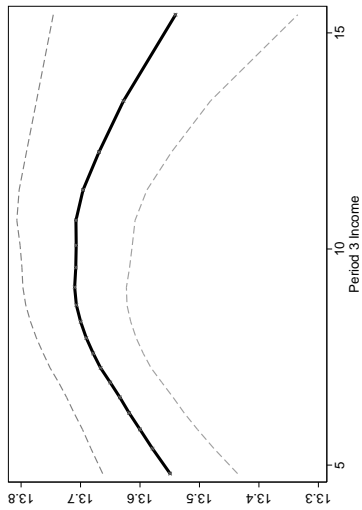
hii)  $\Pi$ =decile 5;  $PI$ =decile 5



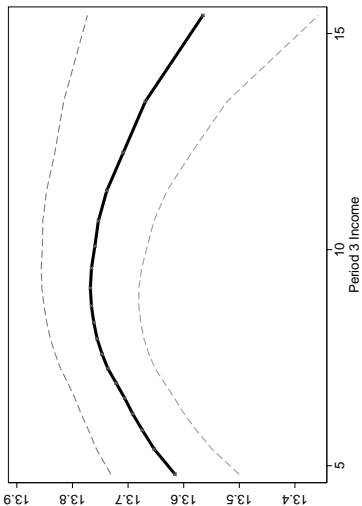
hiii)  $\Pi$ =decile 7;  $PI$ =decile



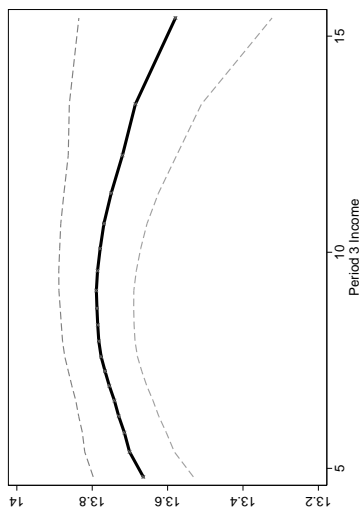
ji)  $\Pi$ =decile 3;  $PI$ =decile 7



jii)  $\Pi$ =decile 5;  $PI$ =decile 7



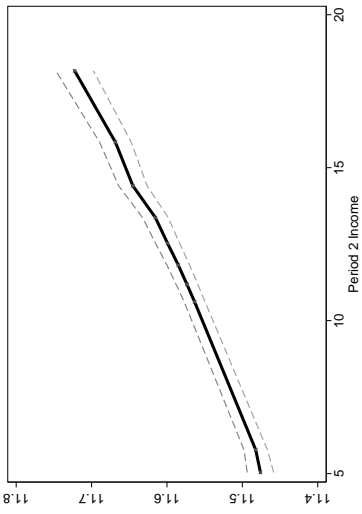
jiii)  $\Pi$ =decile 7;  $PI$ =decile 7



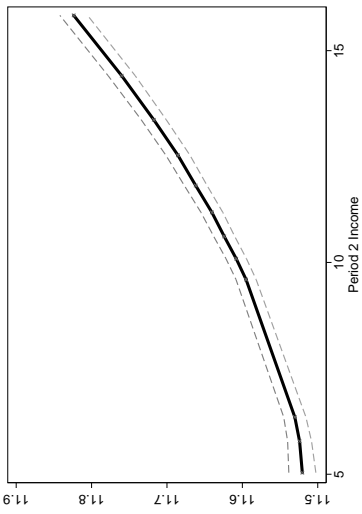
Note: Income in 2000 prices, £ 10,000s. Period 3 refers to age 12-17. Simulated data based on 100,000 draws of income shocks per period. Estimated technology parameters and years of schooling obtained by simulated method of moments, matching percentiles 10, 25, 50, 75 and 90 of each per-period income.

Figure A21: Simulated Years of Schooling and Paternal Income 6-11. Model with Learning about Child Ability

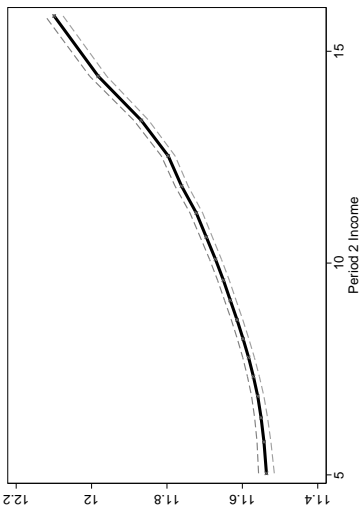
ai) I3=decile 3; PI=decile 3



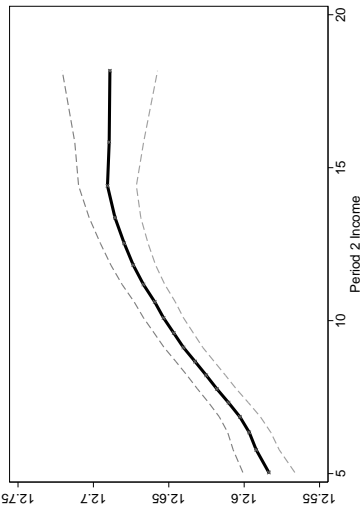
aii) I3=decile 5; PI=decile 3



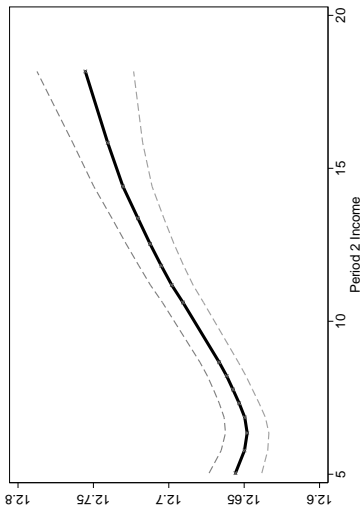
aiii) I3=decile 7; PI=decile 3



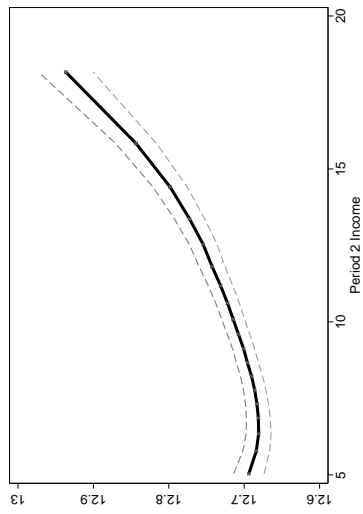
bi) I3=decile 3; PI=decile 5



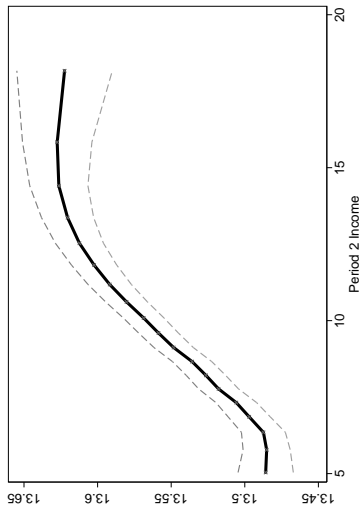
bii) I3=decile 5; PI=decile 5



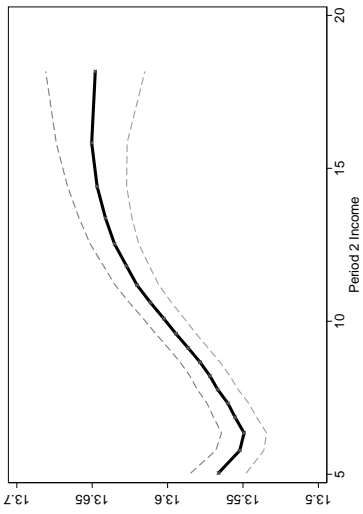
biii) I3=decile 7; PI=decile 5



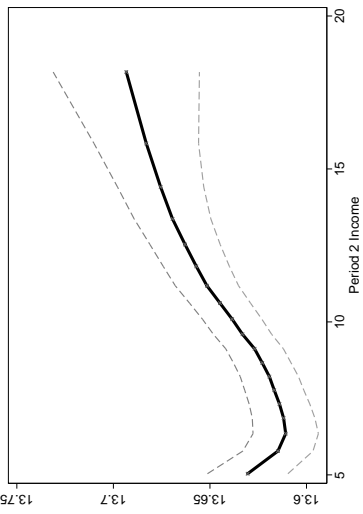
ci) I3=decile 3; PI=decile 7



cii) I3=decile 5; PI=decile 7



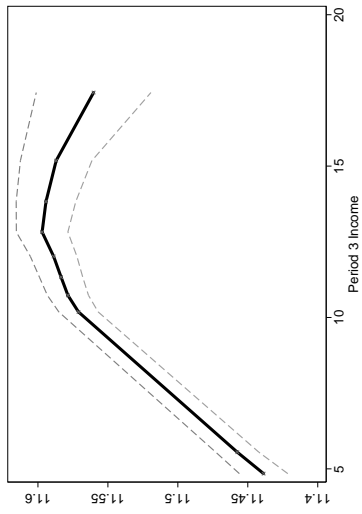
ciii) I3=decile 7; PI=decile 7



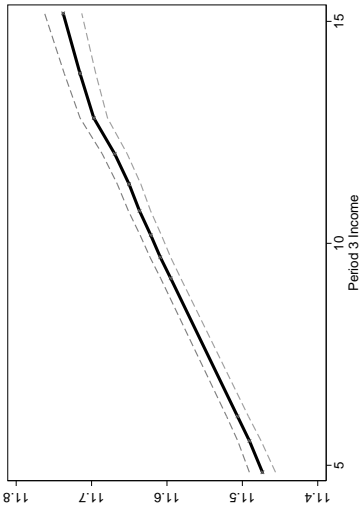
Note: Income in 2000 prices, £ 10,000s. Period 2 refers to age 6-11. Simulated data based on 100,000 draws of income shocks per period. Estimated technology parameters and years of schooling obtained by simulated method of moments, matching percentiles 10, 25, 50, 75 and 90 of each per-period income.

Figure A21: Simulated Years of Schooling and Paternal Income 12-17. Model with Learning about Child Ability

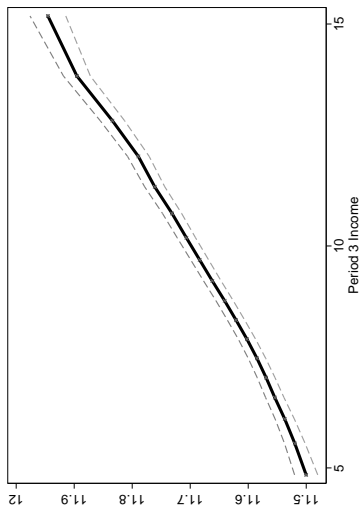
di) I2=decile 3; PI=decile 3



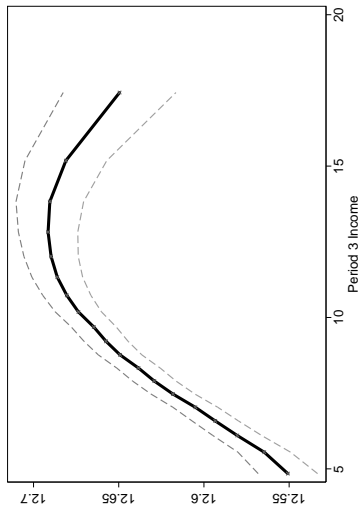
dii) I2=decile 5; PI=decile



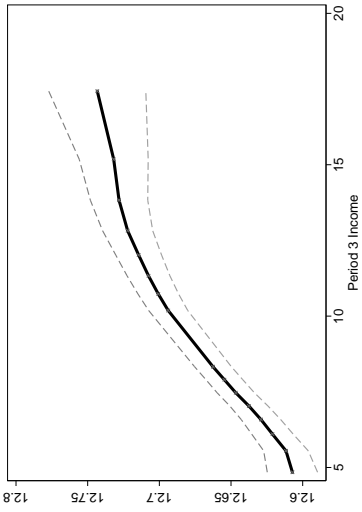
diii) I2=decile 7; PI=decile 3



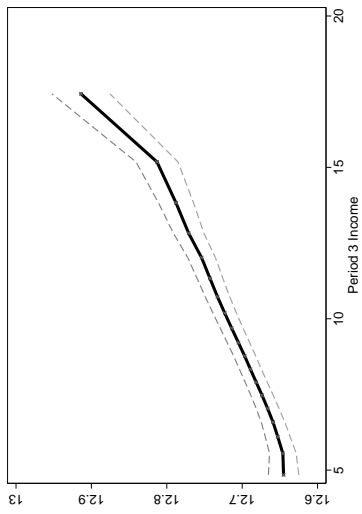
ei) I2=decile 3; PI=decile



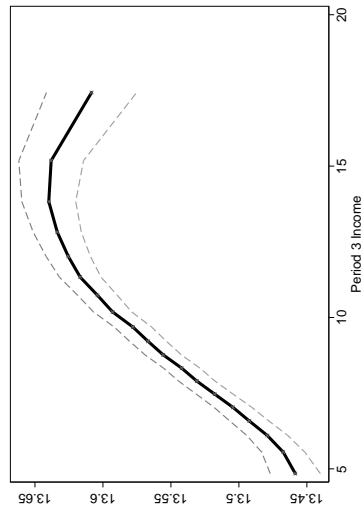
eii) I2=decile 5; PI=decile 5



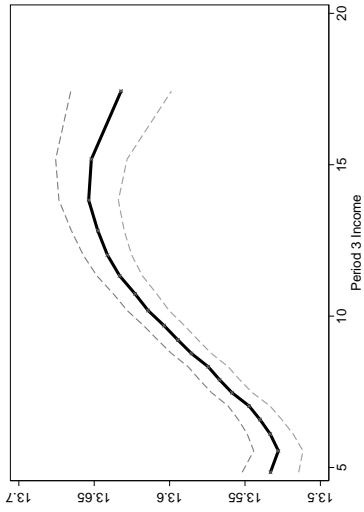
eiii) I2=decile 7; PI=decile



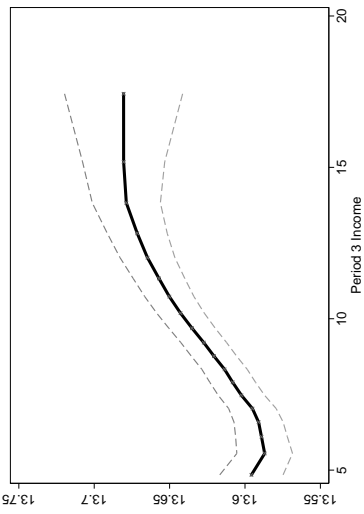
fi) I2=decile 3; PI=decile 7



fii) I2=decile 5; PI=decile 7

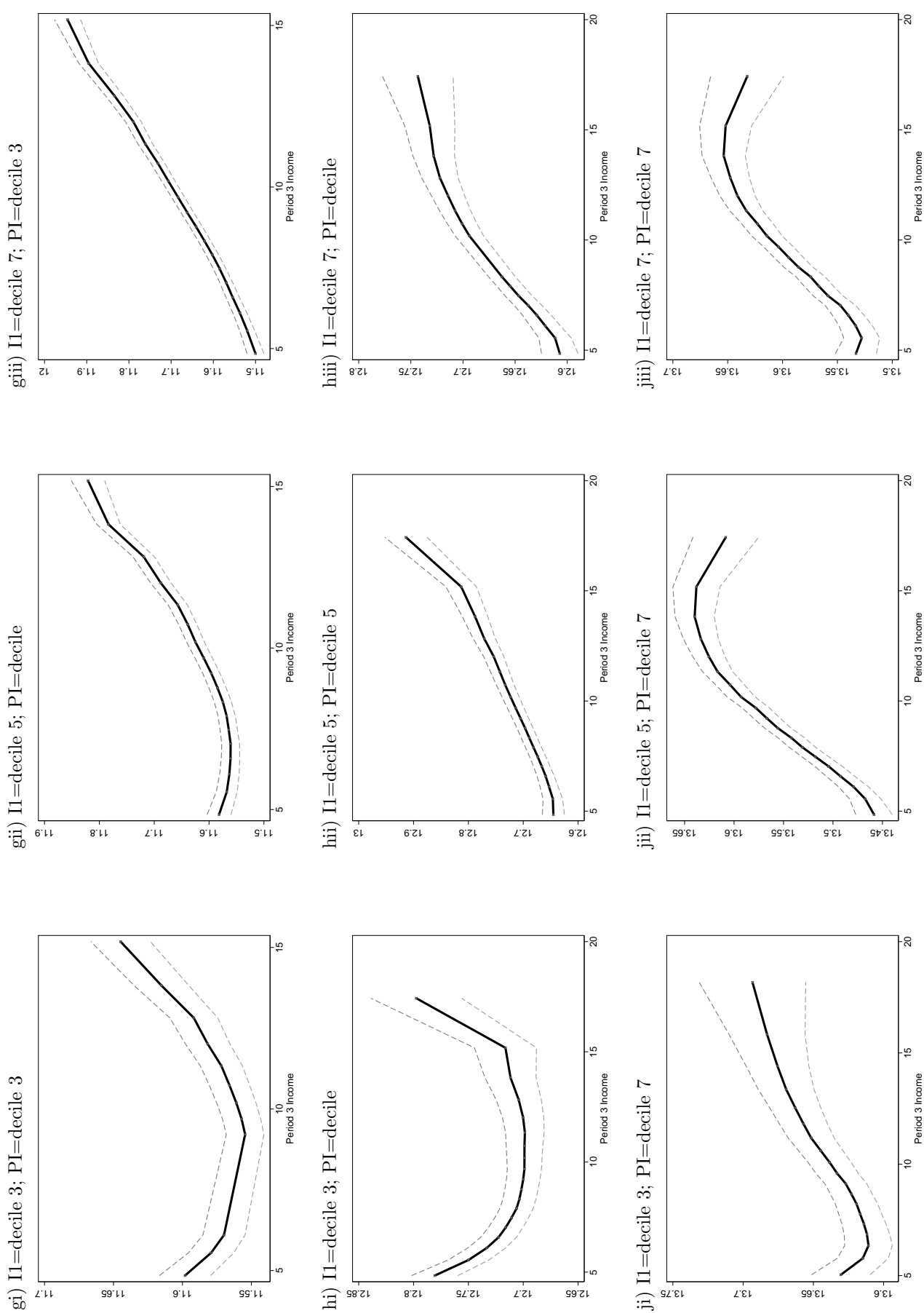


fiii) I2=decile 7; PI=decile 7



Note: Income in 2000 prices, £ 10,000s. Period 3 refers to age 12-17. Simulated data based on 100,000 draws of income shocks per period. Estimated technology parameters and years of schooling obtained by simulated method of moments, matching percentiles 10, 25, 50, 75 and 90 of each per-period income.

Figure A21: Simulated Years of Schooling and Paternal Income 12-17. Model with Learning about Child Ability



Note: Income in 2000 prices, £ 10,000s. Period 3 refers to age 12-17. Simulated data based on 100,000 draws of income shocks per period. Estimated technology parameters and years of schooling obtained by simulated method of moments, matching percentiles 10, 25, 50, 75 and 90 of each per-period income.