

Buhr, Walter

Working Paper

Regional Economic Growth by Policy-Induced Capital Flows: II. Policy Simulation Results

Volkswirtschaftliche Diskussionsbeiträge, No. 34-92

Provided in Cooperation with:

Fakultät III: Wirtschaftswissenschaften, Wirtschaftsinformatik und Wirtschaftsrecht, Universität Siegen

Suggested Citation: Buhr, Walter (1992) : Regional Economic Growth by Policy-Induced Capital Flows: II. Policy Simulation Results, Volkswirtschaftliche Diskussionsbeiträge, No. 34-92, Universität Siegen, Fakultät III, Wirtschaftswissenschaften, Wirtschaftsinformatik und Wirtschaftsrecht, Siegen

This Version is available at:

<https://hdl.handle.net/10419/118733>

Standard-Nutzungsbedingungen:

Die Dokumente auf EconStor dürfen zu eigenen wissenschaftlichen Zwecken und zum Privatgebrauch gespeichert und kopiert werden.

Sie dürfen die Dokumente nicht für öffentliche oder kommerzielle Zwecke vervielfältigen, öffentlich ausstellen, öffentlich zugänglich machen, vertreiben oder anderweitig nutzen.

Sofern die Verfasser die Dokumente unter Open-Content-Lizenzen (insbesondere CC-Lizenzen) zur Verfügung gestellt haben sollten, gelten abweichend von diesen Nutzungsbedingungen die in der dort genannten Lizenz gewährten Nutzungsrechte.

Terms of use:

Documents in EconStor may be saved and copied for your personal and scholarly purposes.

You are not to copy documents for public or commercial purposes, to exhibit the documents publicly, to make them publicly available on the internet, or to distribute or otherwise use the documents in public.

If the documents have been made available under an Open Content Licence (especially Creative Commons Licences), you may exercise further usage rights as specified in the indicated licence.

**VOLKSWIRTSCHAFTLICHE
DISKUSSIONSBEITRÄGE**

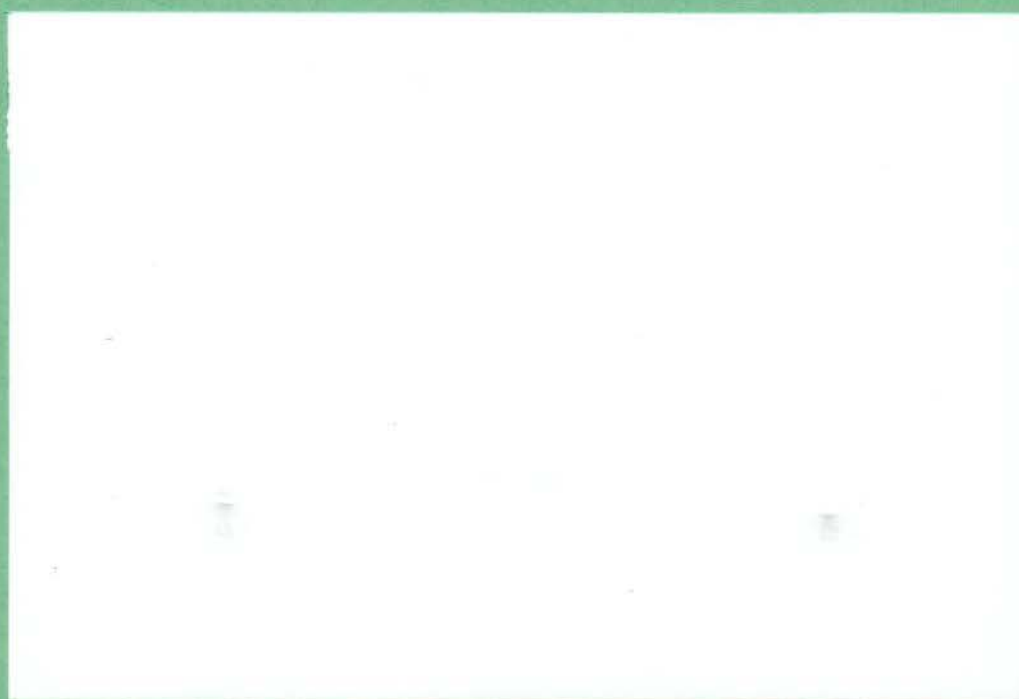

**UNIVERSITÄT - GESAMTHOCHSCHULE - SIEGEN
FACHBEREICH WIRTSCHAFTSWISSENSCHAFTEN**

**REGIONAL ECONOMIC GROWTH BY POLICY-INDUCED CAPITAL
FLOWS: I. POLICY SIMULATION RESULTS**

Walter Buhr

Department of Economics
University of Siegen, Germany

Discussion Paper No. 34-92

This paper is for discussion purposes only. It must not be quoted
without the author's written consent.

ABSTRACT

This second part of the paper refers to a model, described in Part I, that has been designed to analyze alternative allocation strategies of regional economic growth policy: "movement of the workers to the jobs" (passive factor stocks adjustment) or "jobs to the workers" (active factor stocks adjustment). After concentrating on the main properties of the model structure, the references of the parameters and initial values to empirical data are discussed. Model results derived on the basis of parameters representative for the case of passive adjustment policy are studied, also extensively taking account of the impacts of parameter variations. Then follows the analysis of simulation results of active adjustment. The main purpose of all calculations is to demonstrate that the model is able to generate reasonable and consistent policy effects. Moreover, with respect to the model and its parameters this paper attempts to contribute to finding a solid standpoint as to the preconditions of a successful active regional economic policy.

The author is indebted to Petra Leutloff, Darmstadt, for setting up and running the computer program for the numerical implementation of the model. At later dates numerical results were produced by Georg Zink and Hagen Bobzin, Siegen.

1 EMPIRICAL ASPECTS OF THE UNDERLYING MODEL

1.1 On the Structure of the Model

In Buhr 1993 a dynamic, real and non-monetary two-regions model is described to evaluate the two basic policy strategies of regional factor stocks adjustment: passive and active regional government policy. Whereas the passive policy supports the flow of labor from the underdeveloped regions to capital located in the prosperous regions of the economy, the active policy of factor mobility aims at the transfer of private and public capital from the agglomeration centers to engage unemployed labor force in the retarded regions.

This second part of the paper deals with the structure of the underlying model and its empirical aspects. We then shall study the properties of the model on the basis of parameters representative for the case of passive adjustment policy, also discussing variations of parameters. Subsequently, the implications of active regional economic policy will be analyzed by varying three policy parameters: the underdeveloped regions' share in national public savings, the volume of the backward areas' public funds for capital subsidies competing with public expenditures on infrastructure investments and the percentage of these capital subsidies in relation to matching private capital attracted from the developed regions. We are aware that, in a comprehensive sense, investments in infrastructural facilities and capital subsidies are the two most important sets of instruments of regional growth policy (cf. Funck 1990).

By assumption, all spatial subsections of the nation are assigned to either of the two categories of areas called region R1 and region

R2. Region R1 includes spatial entities of agglomeration showing a high level of income and infrastructure provision (absolute and per head), a tendency towards immigration and shortage of either private capital, labor, or material infrastructure. R2 refers to areas with an insufficient degree of development which is characterized by a low level of income and infrastructure provision (absolute and per head), a tendency towards outmigration and, above all, a lack of private capital.

The model embodies regional supply-side growth barriers determined by the availability of the regional factor stocks private capital, material infrastructure and labor. Factor demand is expressed by means of Leontief production functions. Regional demand-supply equilibrium is guaranteed by a simple approach which takes regional investments as residuals of resources available from the income streams, after other categories of demand have been determined. Interregional linkages refer to trade flows, interest payments and migration between the regions.

The basic structure of the model may be depicted by Figure 1 (read the figure from the right to the left). The regions R1 and R2 are indirectly related to each other by the super-ordinate state. ① Public transfers F_1^{Apu} of R1 and F_2^{Apu} of R2 form the state's total revenues F^{pu} which are identical with total public savings S^{pu} (cf. the list of symbols in Appendix A). ② Total revenues F^{pu} are allotted to R1 and R2 applying the national active policy distribution parameter ν . Each region i ($i = 1, 2$) may use its assigned resources F_i^{Epu} either for infrastructure investment I_i^{puj} or public means G_i^{pu} to attract private capital from the other region. On the level of the individual region these public resources are apportioned by means of the regional active policy distribution parameters h_i , respectively.

In addition, regions R1 and R2 are also directly related to each other by trade flows and migration, as indicated in the figure. ③ Private exports Z_1^{Pr} of R1 represented by $\bar{i}_{12}(r_2/r_1)X_1$ (\bar{i}_{12} = export parameter of R1, r_1 = interest rate applied to private capital of R1, r_2 = private interest rate of R2, X_1 = R1's real production) and by private

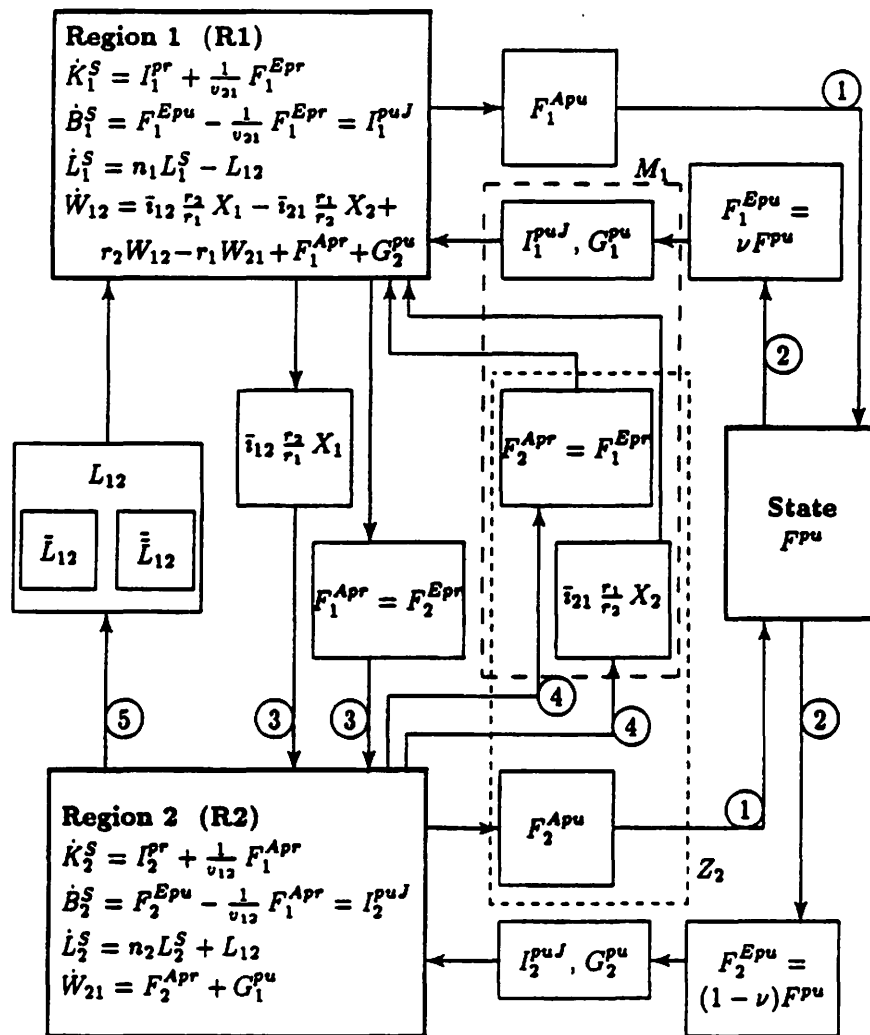

Figure 1: Basic Structure of the Model

capital outflow F_1^{Apr} (= capital inflow F_2^{Epr} of R2) are equal to private imports M_2^{Pr} of R2. (4) Correspondingly, private exports Z_2^{Pr} of R2 indicated by $\bar{i}_{21}(r_1/r_2)X_2$ (\bar{i}_{21} = export parameter of R2, X_2 = R2's real production) plus private capital outflow F_2^{Apr} (= capital inflow F_1^{Epr} of R1) amount to private imports M_1^{Pr} of R1. Total exports Z_2 of R2 are given by the sum of private exports Z_2^{Pr} and R2's public resources F_2^{Apu} transferred to the state; this sum is referred to by a rectangle drawn in dashed lines and marked by Z_2 . Analogously, total imports M_1 of R1 are visualized in the upper part of the figure. Note that public resources F_1^{Epu} imported by R1 from the state are spent on infrastructure investment I_1^{puj} and attraction means G_1^{pu} in R1. (5) Net migration L_{12} between R1 and R2 depends on the difference in the regions' wage rates (\bar{L}_{12}) and on the difference of the regions' percentages of unemployment (L_{12}).

The boxes on the left-hand side of Figure 1 enclose the changes-of-stocks relationships of R1 and R2, respectively. With reference to region i ($i = 1, 2$), private investment I_i^{Pr} is the essential determinant of the change in the private capital stock, \dot{K}_i^S ($= dK_i^S/dt$); infrastructure investment I_i^{puj} is equal to the variation of the public capital stock, \dot{B}_i^S ($= dB_i^S/dt$); the sum of the change in the natural labor force, $n_i L_i^S$ (n_i = natural rate of growth of the working population, L_i^S = labor supply of region i), and net migration between the regions, L_{12} , makes up the variation of the regional labor supply, \dot{L}_i^S ($= dL_i^S/dt$); the symbol \dot{W}_{ij} ($= dW_{ij}/dt$) refers to the change of private assets held by region i in region j . For further details compare the presentation of the model in Part I of the paper.

The main purpose of all subsequent calculations is to demonstrate that the model is able to generate reasonable and consistent policy results, especially in view of the existence of regional growth

barriers. The pertinent considerations exclusively refer to the model as formulated and to the underlying parameters (for the case of the passive policy cf. Appendix B). Generalizations about regional economic policy or direct applications to economic policy in practice are not intended.

It is important to observe that the analytical possibilities of simulation are limited since the model does not include any feedback relationships. In addition, parameter variations are carried out under the assumption that all other parameters are held constant during the period of research (*ceteris paribus* analysis), unless otherwise specified. Therefore the time span under consideration is restricted to fifteen years. As far as model results have been generated, they show monotonous behavior without exception.

The Runge-Kutta solution method has been applied with constant step size of a thousandth part of the year. The computer program has checked at these points in time only whether the prevailing combination of growth restricting factor stocks must be changed.

The way in which the model is solved may be derived from the sketch of Figure 2.¹

¹The symbols used in Figure 2 have the following meaning: $W_{ij}(W_{ji})$ = private assets held by region i (region j) in region j (region i), $i, j = 1, 2$; $r_i(r_j)$ = rate of interest applied to private capital in region i (region j); terms with the region-specific subscript i : K^S = supply of private capital, B^S = supply of material infrastructure, L^S = labor supply, Y^S = supply-side income, Y^D = demand-side income, X = production, C^{pr} = private consumption, C^{pu} = public consumption, I^{pr} = private investment, I^{pu} = public investment, Z = exports, M = imports; the F -terms refer to resource transfers between the regions and the state.

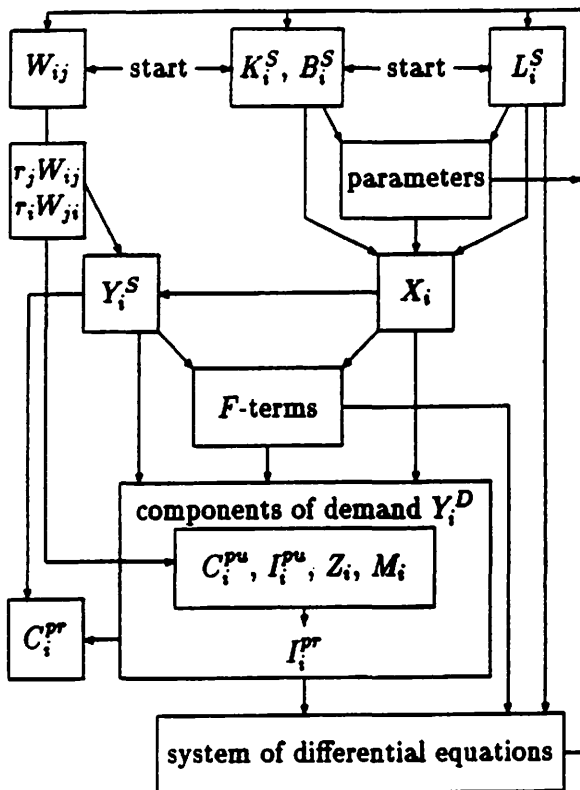

Figure 2: Sketch of Model Solution

1.2 References to Empirical Data

Strictly speaking, the values of the parameters used for calculation must be called hypothetical, although many of them refer to empirical data with or without modification. There are two reasons for this situation. On the one hand, we concentrate on two polar types of regions for which no representative empirical data are directly available. On the other hand, the underlying model represents a very crude picture of reality so that not all parameters must be related to empirical data. Therefore a consistent set of data is to be

generated for the model which may be considered as a sensible approximation to economic indicators in reality (cf. Appendix B). In this sense, we shall subsequently refer to some important empirical aspects of regional economics.

The initial values of the capital stocks K_1^S and B_1^S , the labor supplies L_1^S and the wealth terms W_{ij} were selected more or less freely. However, relevant ratios of these variables have been observed. The regional ratios of private capital to public capital implied in the initial values (R1: .87, R2: .88) show a higher emphasis on private capital than do the data for the Federal Republic of Germany (FRG) (capital stock of enterprises including housing for rent/total capital stock = .83 (1960), .81 (1980); prices of 1976; Statistisches Bundesamt 1985, p. 127). The assumed bias to private capital has led us to postulate lower private capital productivities, that is higher private capital-output ratios than the data for FRG suggest. This means that the total capital-output ratios (based on supplied capital stocks!) corresponding to the capital productivities used in the model (at the start R1: 5.5, R2: 6.1; at year 15 R1: 4.8, R2: 5.8) lie above the FRG-values 3.9 for 1967 and 4.7 for 1984 (capital-output ratios of all sectors calculated as total capital stock/gross national product, since 1950 decreasing, fluctuating and then increasing up to the maximum value for 1984, in prices of 1976; Statistisches Bundesamt 1985, p. 127). Observe that the just given total capital-output ratios for R1 and R2 imply that capital productivity in R1 is higher than in R2. The capital intensities (for R1 higher than for R2) stemming from the initial capital and labor stock values of the model are in accordance with data for FRG in the sixties (prices of 1976; Statistisches Bundesamt 1985, p. 127). These rather low figures fit to the assumption of lower capital productivities and are in harmony with

cautiously selected parameters for labor productivities.

The rates of unemployment used in the model for R1 (3.4 %) and R2 (17.1 %) have been chosen in view of the polar development contexts of the two regions. The resulting national rate of 8.2 % does not seem to be implausible.

As to the growth rates of the natural labor forces the value $n_1 = .011$ may be found for agglomerated areas in Northern Europe and Canada, 1960-1980 (Butzin 1986, pp. 22-24), while $n_2 = .015$ is representative for smaller underdeveloped economies in the eighties (Statistisches Bundesamt 1990, p. 700).

The migration parameters e_{12}^1 , e_{12}^2 , d_{12}^1 and d_{12}^2 have been selected so as to guarantee acceptable rates of net migration from R2 to R1 up to 1.8 % and to determine 40 % of net migration by differences in interregional wage rates and 60 % by differences in the interregional rates of unemployment at the start of the calculations.

With regard to the income shares of the factors of production we must consider that the shares of private capital g_1 and the shares of public capital c_1 are calculated by the model for capital productivities k_1 and b_1 (to be discussed later) and assumed interest rates $r_1 = .06$, $r_2 = .045$, $r_1^* = .021$ (pay-off period of public capital 47.6 years), $r_2^* = .018$ (pay-off period 55.6 years). R1's labor share $q_1 = 69.8$ % at the start of the calculations lies within the range of German data, 1950-1990 (Institut der deutschen Wirtschaft 1991, Table 29). R2's corresponding labor share $q_2 = 74.7$ % seems to be reasonable in view of its low level of development.

Tax rates $t_1 = .2075$ and $t_2 = .1975$ have been oriented at the 20 %

mark representative for a 4-persons-household with median income according to German income tax law for many years. In connection with the tax rates the public consumption ratios $c_1^{pu} = .195$, $c_2^{pu} = .19$ have been chosen so that public investments are predominantly financed by public interest receipts.

The average private savings ratio $s_1^{pr} = .105$ related to gross income of R1 corresponds to a savings ratio of .14 related to disposable income which is a realistic figure according to German data (Stobbe 1980, p. 138). R2's ratio $s_2^{pr} = .055$ (in relation to disposable income .07) has been selected to take account of R2's low level of development and to be able to increase this ratio in the context of model simulation in order to demonstrate the effects of R2's own initiative. The ratios of private consumption are nearly invariant at .67 for R1 and .73 for R2 during all computer runs.

Also no data are directly available on the parameters \bar{i}_{12} and \bar{i}_{21} of the export functions. These parameters were determined by the consideration for the start of the calculations to create a (very small) current account deficit for R1 (net resource inflow from R2 to R1 further weakening the economic situation of the underdeveloped region R2) and to generate small trade-income ratios in order to indicate a low level of integration between R1 and R2.

The parameters of average factor productivities k_i , b_i and a_i were selected (a) because of a compromise between the following aspects: consistency of total data set, availability of empirical data, theoretical considerations on ratios of factor stocks, and model requirements (reasonable rates of factor idleness, change among regional growth barriers); (b) in view of the following assumptions: the largest part of the productivities is exogenously determined;

exceptions: effect of technical progress on labor productivities and private capital productivities, (location) effects of material infrastructure on private capital productivities and (neoclassical) effect of the amount of private capital on the productivities of private capital (cf. Table 1).

R1's labor force participation rate (42.03 %) corresponds well to German data (Institut der deutschen Wirtschaft 1990, Table 20). The rate of R2 (34.9 %) was assumed with regard to R2's low level of development. Population densities are realistically assumed figures.

The policy parameters ν , h_1 , and v_{ij} ($i, j = 1, 2$) were selected according to a reasonable concept of the policy of passive adjustment. The parameter $\nu = .8$ means that 80 % state funds will be distributed to R1, 20 % to R2. These resources R1 will solely spend on infrastructure investment ($h_1 = 1$), whereas R2 will dedicate a very small amount on expenditures to attract private capital from R1 ($1-h_2 = .005$) and the rest on infrastructure investment ($h_2 = .995$). R2's attraction resources or capital subsidies are matched by private capital from R1 in the assumed relationship of $1/v_{12} = 1.25$ ($v_{12} = .8$). Observe $v_{21} = 0$. If we keep in mind that the model takes account of net migration, we understand that labor mobility and interregional capital investment are considered as mixed phenomena as they happen in the real world.

Share of	in Total Productivity of ... (in percent)	
	year 1	year 15
	labor	
term of technical progress		
a_{11}^t	+ 1.7	+ 20.8
a_{21}^t	+ 2.3	+ 25.9
term of public capital*	below 1.0	
term of private capital	below 1.0	
	private capital	
term of technical progress		
k_{11}^t	+ 1.4	+ 17.8
k_{21}^t	+ .53	+ 7.3
term of public capital*		
$k_{12}^{B_1^S}$	+ 4.6	+ 6.5
$k_{22}^{B_2^S}$	+ 9.5	+ 12.9
terms of private capital		
$k_{13}^{K_1^S}$	- 9.4	- 11.2
$k_{23}^{K_1^S}$	- 18.6	- 19.6
	public capital	
term of technical progress	below 1.0	

* The correction term dated back in relationships (13) and (15) of the model has been omitted.

Table 1: Determinants of Factor Productivities

2. SIMULATION RESULTS OF PASSIVE ADJUSTMENT

2.1 Passive Regional Economic Policy

The main calculation results for the passive policy are as follows for the fifteen years period (cf. parameters of Appendix B). We start with the growth restricting system of factor stocks B_1/K_2 which is changed to K_1/K_2 after 3.5 years, to B_1/K_2 after 10.5 years and finally to L_1/K_2 after 12.3 years. While R2's capital stock K_2^S represents the growth limiting factor of production during the entire research period, in R₁ the successive growth barriers are infrastructure capital B_1^S , private capital K_1^S , and labor L_1^S . This sequence depends on the specific circumstances of growth for each of the mentioned factor stocks.

During the fifteen years R1's absolute income, per capita income (referring to the L^S -variable or the population variable E), private capital stock and public capital stock are distinctly higher and grow faster than the corresponding variables of R2. National income growth is dominated by R1's income development (cf. Figure 3).

Whereas the labor force L_1^S (population E_1) of R₁ increases by 31.9 %, L_2^S (E_2) of R2 is virtually stagnant (growth rate -1,5 %). The net outmigration rate of R2 rises from 1.3 % to 1.8 % in the fifteenth year. Average infrastructure provision is substantially higher in R1 than in R2, but is faster growing in R₂.

The interregional wealth transfer W_{12} decreases slightly, W_{21} remains constant.

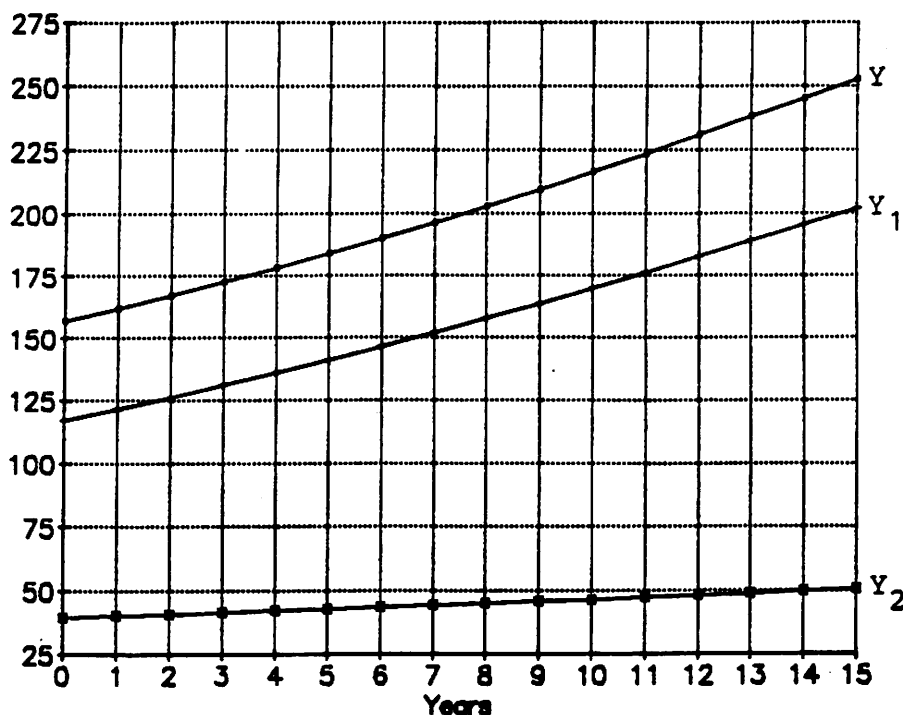

Figure 3: Regional Incomes Y_1 ($i = 1,2$) and National Income Y under the Strategy of Passive Adjustment (incomes in billions)

The rates of factor stock idleness² (development during the fifteen years period for each factor in brackets) are: UK_1 (from .4 % to 1.5 % with an intermediate period of full utilization), UK_2 (fully employed during the entire period), UB_1 (from 0 % (full use) to 1.0 %), UB_2 (from 1.6 % to 19.2 %), UL_1 (from 3.4 % to 0 % (full

² Utilization of private capital of only up to 80 % per year is by no means an unrealistic event in reality (Institut der deutschen Wirtschaft 1991, Table 72). In individual branches of industry the rates may be lower. See Winston 1974 for the theoretical implications. As to public infrastructure the rates of excess capacities may easily go up to 40 % even in developed areas considering, for example, monopolistic market structures (public utilities) or special supply conditions as they exist for roads.

employment)), and UL_2 (from 17.1 % to 20.5 %).

As far as the shares of private capital (g_1), public capital (c_1), and labor (q_1) in production are concerned (development described as before), we note: g_1 (from 28.6 % to 23.7 %), g_2 (from 24.0 % to 21.8 %), c_1 (constant at 1.6 %), c_2 (constant at 1.3 %), q_1 (from 69.8 % to 74.7 %), and q_2 (from 74.7 % to 76.9 %). R1's wage rate stays at a higher level than that of R2, although R2's wage rate rises (slightly) faster.

The private investment-income ratio of R1 develops from 10.8 % to 10.5 %, the ratio of R2 from 4.5 % to 5.5 %; the public investment ratio of R1 starts at 2.8 % and ends up at 2.7 %, while the public ratio for R2 ranges from 2.1 % to 2.6 %³.

R1's and R2's ratios of private goods exports remain constant (1.1 % and 4.0 %, respectively). The import ratio of R1 decreases from 1.4 % to 1.0 %, that of R2 rises from 3.3 % to 4.5 %. There is also a thin stream of private capital from R1 to R2 resulting from public action in R2. The initially very small current account deficit of R1 (.003 % of R1's income) decreases nearly to the zero level. These figures indicate a low interregional trade and capital dependency between R1 and R2.

³ The model could be used to investigate the impact of the composition of public expenditures in the lagging region R2 on, for instance, the rate of growth of the economy. We would have to form R2's ratio of infrastructure investment to the sum of public consumption and public investment and must study the effects of this varying ratio on the different variables.

2.2 Parameter Variations

In the following the main results of sensitivity analysis on the basis of the passive policy parameters will be summarized. Predominantly, these results are expressed in terms of elasticities. In the present context an elasticity is defined as the relative change of a variable divided by the relative change of the parameter. As interesting variables have been selected (cf. Table 2): the capital and labor stocks K_1^S , K_2^S , B_1^S , B_2^S , L_1^S , L_2^S , the rates of factor idleness UK_1 , UK_2 , UB_1 , UB_2 , UL_1 , UL_2 , and regional incomes Y_1 and Y_2 (note that the rates of idleness are very sensitive variables). The selection of relevant parameters had to be restricted to essential considerations. As to the determinants of the factor productivities a_i (labor), k_i (private capital), and b_i (public capital) parameters were chosen according to the results of Table 1. Other parameters were taken considering their relevance for the model. Changes of initial values refer to the regional growth barriers under passive regional economic policy. Active policy parameters ν , h_i , and v_{ij} ($i, j = 1, 2$) were excluded from this investigation.

Parameters must not be varied arbitrarily, as indicated before, since the model has a simple structure and essentially embodies linear relationships. Parameter variations find their limits in unrealistic results such as negative investments or excessive rates of factor idleness.

Table 2 indicates the absolute values of the variables in its first line. As to the parameters, their percentage changes are given in brackets. Thus the absolute values of the variables for the changed

parameters may be derived⁴. All figures of Table 2 refer to the year 15.

The most important overall result of Table 2 is that the variables are robust with respect to changes of parameters. The values of the elasticities lie within reasonable bounds (cf. Leamer 1985).

In addition, also with respect to Table 2, we have found the following noteworthy results. If we assume that R1 will reach an agglomeration optimum at a certain time and that agglomeration diseconomies decrease labor productivity in particular (decrease of the autonomous term a_{10} of this productivity), then the model correctly indicates a fall in R1's income and thus in national income.

⁴ For example, R1's tax rate t_1 is increased by +10 % from .2075 to .2283. The elasticity for R1's rate of public capital idleness UB_1 is given as +211.3. Thus UB_1 is raised by the variation of t_1 from .0098 to .2169.

The highest absolute values of the rates of factor idleness for the year 15 due to parameter variation are: UK_1 (.0934), $UK_2(0)$, UB_1 (.2169), UB_2 (.3155), UL_1 (.0803), UL_2 (.2859). This value for UL_2 is an exception; it refers to the change of a_{21} (= R2's coefficient of technical progress as determinant of R2's labor productivity).

**Table 2: Elasticities of Selected Parameters
(Passive Policy Case)**

Changed Parameters	K_1^S	K_2^S	B_1^S	B_2^S	L_1^S	L_2^S	UK_1	UK_2	UB_1	UB_2	UL_1	UL_2	Y_1	Y_2
PP: Absolute Values of Year 15*)	811.6	245.0	151.0	45.9	8.0	3.2	.0147	0	.0098	.1921	0	.2051	202.1	50.8
a_{10} = 20905.5 (+5%)	+.005	0	0	0	0	+.625	-13.3	0	-20.0	+.010	$+\infty$	+.653	+.228	0
= 18914.5 (-5%)	+.165	+.090	+.225	+.174	0	0	-21.6	0	-39.6	+5.8	0	-.731	+.841	+.079
a_{20} = 15330 (+5%)	+.002	0	0	0	+.250	0	-4.3	0	-6.3	+.010	0	+2.1	+.059	0
= 13870 (-5%)	+.007	0	0	0	0	-.625	-.503	0	-7.3	+.010	0	-2.1	+.079	0
b_{10} = 1.4154 (+5%)	0	0	-.185	-.131	0	0	-.952	0	+78.2	-.552	0	+.020	0	0
= 1.2806 (-5%)	+.281	+.155	+.185	+.131	+.250	-.625	-4.9	0	+20.0	+.021	$-\infty$	-2.7	+.386	+.039
b_{20} = 1.4102 (+5%)	-.002	0	0	0	0	0	0	0	-2.2	+2.0	0	+.029	-.010	0
= 1.2759 (-5%)	+.002	0	-.040	-.044	0	0	+.408	0	-3.9	+4.2	0	+.117	-.010	0
k_{10} = .231 (+5%)	+.002	0	0	0	+.250	0	+53.7	0	-3.3	+.010	0	-.390	+.040	0
= .209 (-5%)	+.278	+.155	+.371	+.305	+.250	-.625	+20.0	0	-48.6	+.593	$-\infty$	-3.1	+.861	+.118
k_{20} = .2153 (+5%)	+.030	-.008	+.053	+.044	0	+.625	+16.1	0	+26.7	-4.0	0	-1.7	-.218	+1.0
= .1948 (-5%)	+.054	0	+.093	+.044	-.250	+.625	+11.0	0	+20.0	-2.4	$-\infty$	-1.9	-.109	+1.0

*) Capital stocks and incomes in billions, labor supplies in millions. PP = Passive Policy.

Changed Parameters		K_1^S	K_2^S	B_1^S	B_2^S	L_1^S	L_2^S	UK_1	UK_2	UB_1	UB_2	UL_1	UL_2	Y_1	Y_2
$a_{11} = 525$	(+50%)	0	0	0	0	0	+0.063	-1.3	0	-2.0	+0.002	$+\infty$	+0.010	+0.021	0
$a_{21} = 510$	(+50%)	0	0	0	0	+0.025	0	-0.707	0	-1.1	+0.001	0	+0.790	+0.010	0
$k_{11} = .0045$	(+50%)	0	0	0	0	+0.025	0	+10.7	0	-0.367	+0.001	0	-0.044	+0.004	0
$k_{21} = .0015$	(+50%)	+0.001	0	+0.001	+0.004	0	+0.063	+0.694	0	+1.2	-0.300	0	-0.192	-0.010	+0.075
$k_{12} = .1635 \cdot 10^{-12}$	(+50%)	0	0	0	0	0	0	+4.1	0	-0.184	+0.001	0	-0.025	+0.002	0
$k_{22} = .873 \cdot 10^{-12}$	(+50%)	+0.003	0	+0.005	+0.004	-0.025	+0.063	+1.8	0	-2.9	-0.526	0	-0.265	-0.025	+0.134
$k_{13} = -.0525 \cdot 10^{-12}$	(+50%)	+0.030	+0.016	+0.040	+0.035	+0.025	-0.063	+2.0	0	-7.2	+0.065	$-\infty$	-0.331	+0.112	+0.012
$k_{23} = -.2475 \cdot 10^{-12}$	(+50%)	+0.011	+0.001	+0.017	+0.013	-0.050	+0.063	+0.898	0	+2.0	-0.782	$-\infty$	-0.410	-0.004	+0.201

Table 2 (continued)

Changed Parameters		K_1^S	K_2^S	B_1^S	B_2^S	L_1^S	L_2^S	UK_1	UK_2	UB_1	UB_2	UL_1	UL_2	Y_1	Y_2
$r_1 = .066$	(+10%)	+2.202	-.743	-.026	-.022	0	0	+10.7	0	-4.0	+2.5	0	+2.2	-.054	-.335
$s_1^{pr} = .1155$	(+10%)	+3.304	0	0	0	0	0	+17.7	0	-9.0	+0.005	0	-.005	0	0
$s_2^{pr} = .0605$	(+10%)	+0.001	+0.151	0	0	0	0	+1.0	0	+1.7	-.505	0	-.351	+0.035	+0.118
$t_1 = .2283$	(+10%)	+0.015	+0.012	+2.6	+2.2	0	0	+13.3	0	+211.3	+6.4	0	-.926	-.020	+0.295
$c_1^{pu} = .1755$	(-10%)	-.015	-.012	-2.5	-2.0	0	0	-12.6	0	-201.2	-6.1	0	+0.873	+0.020	-.276
$c_2^{pu} = .171$	(-10%)	-.006	-.004	-.693	-.566	0	0	-3.6	0	-65.6	-1.9	0	+0.258	+0.005	-.079
$n_1 = .0099$	(-10%)	+0.011	+0.004	-.053	0	+0.125	0	-9.0	0	-13.3	+0.026	0	+0.073	+0.148	0
$L_1^S = 6\ 204\ 326$	(+1.8%)*	+0.014	0	0	0	+0.694	+1.7	-37.0	0	-55.6	+0.058	$+\infty$	+1.8	+0.577	0
$K_1^S = 566\ 711\ 000\ 000$	(+1%)	+0.702	0	0	0	0	0	+41.5	0	+1.0	+0.052	0	-.049	0	0
$K_2^S = 213\ 514\ 000\ 000$	(+1%)	+0.025	+0.857	+0.066	0	0	0	+10.9	0	+18.4	-3.0	0	-1.4	-.148	+0.787
$B_1^S = 87\ 870\ 000\ 000$	(+1%)	+0.012	0	+0.596	0	0	0	+3.4	0	+60.2	+0.052	0	-.244	0	0

*) This value was chosen in order to guarantee that at the same time the rate of unemployment will increase by 50 %. Observe that this rate is an initial value of the model.

Correspondingly, the same outcome for R2 and the nation holds if growing spatial diseconomies have a reducing effect on the absolute component k_{20} of R2's capital productivity.

If the interest rate r_2 representative for R2 is increased, for instance with the aim of equalizing the rates of interest in the two regions, then according to the relationships (28) and (40) of the model private investment and thus private capital stock of R2 will grow, while private investment and private capital stock of R1 will fall. The calculation results also state that, at the beginning of the fifteen years period, R2's income will be reduced and R1's income augmented, as we learn from looking at model relationships (1), (3), (9), (28), (29), (30), and (48a), to the effect that national income will increase. However, the initial regional income changes are reversed due to the capital stock growth of R1 and R2, with the consequence of raising total income even more. The numerical results finally suggest that the impact of income variations on the variables of the regional public sectors may be neglected and that the rising interest rate r_2 - even considering other parameter constellations - may reach an optimum value as far as the desired increase of national income is concerned.

An assumed inflow of private capital from the rest of the world as a third region to R2, for instance in the magnitude of $M_{20}^{PR} = 4$ billion for each year of the research period (= 2.2 fold of R2's private investment at the start of the calculations), has throughout stimulating effects on economic activities located in R2. In the model such a capital inflow increases R2's private imports and private investment, thus augmenting the private capital stock in the backward

areas. For the above given value of M_{20}^{PR} , additional capital is fully absorbed so that R2's income substantially grows. Accordingly, R2's rates of factor idleness UB_2 , UL_2 and its outmigration rate drop markedly. The essential effect is that R2's labor supply increases, while R1's labor supply decreases within the fifteen years period, as compared to the case of $M_{20}^{PR} = 0$. This reduction of R1's labor supply is mainly responsible for R1's reduced income growth. With respect to year 15, national income reaches a higher level in comparison to the case of non-existing capital inflows from the outside to R2.

If these inflows M_{20}^{PR} are further increased, say to 6.0 billion, then R2's time pattern of growth barriers will change. At year 1.9 public capital substitutes private capital as the growth limiting factor in R2, the rate of private capital idleness being 2 % at year 15. All other tendencies of development, as described before, become strongly reinforced now.

To conclude these considerations, capital imports from the rest of world as a third region do not seem to create any stability problems. There are no particular problems whatsoever for any of the two regions in absorbing additional capital from outside the two-regions sphere.

Another important question is whether the model can deal with the no-growth case, since many economic growth models are unable to do so (Polenske 1981). We find that this model may cope with stagnation under the assumptions outlined: (a) Set equal to zero: the variable W_{ij} , $i, j = 1, 2$; the parameters \bar{i}_{12} , \bar{i}_{21} , s_1^{pr} , s_2^{pr} , e_{12}^1 , e_{12}^2 , d_{12}^1 , d_{12}^2 , n_1 , n_2 , t and ρ (= new additional parameter). (b) Change the following relationships to

$$(5) \quad F_i^{Apu} = \rho (T_i - c_i^{pu} Y_i) = \rho \left[(t_i - c_i^{pu}) Y_i + r_i^* B_i^D \right], \text{ using (23) and (24)}$$

$$(24) \quad C_i^{pu} = c_i^{pu} Y_i + (1 - \rho) (T_i - c_i^{pu} Y_i)$$

$$(25) \quad \sum_i (s_i^{pr} + \rho f_i^{pu}) Y_i + \sum_i \rho r_i^* B_i^D = \sum_i I_i^{pr} + \sum_i I_i^{pu}$$

$$(27) \quad \rho \sum_i (\dots) = F^{pu}$$

$$(38a) - (41) \quad \text{all } F_i^{\dots} = \rho(\dots)$$

(42a), (42b) multiply φ by ρ .

3. SIMULATION RESULTS OF ACTIVE ADJUSTMENT

The policy of active adjustment may refer to changes of three parameters related to specific instruments of regional economic growth policy. (a) In this model, at first sight, the most important parameter is the backward regions' share $(1-\nu)$ in national public savings. If $\nu = .7$, then 70 % of total savings go to R1 and 30 % to R2. Decreasing ν as a state-controlled parameter means R2's increasing participation in total public savings. In this case R2's public means available for alternative purposes will be augmented. According to the model these funds may be spent on infrastructure investment, on the one hand, and on public means to attract private capital from R1, that are capital subsidies, on the other hand. In a comprehensive sense, investments in infrastructural facilities and capital subsidies are the two outstanding sets of instruments of regional development policy (cf. Funck 1990). (b) Thus, R2's public funds given, infrastructure investments compete with capital subsidies, as expressed by the

parameter h_2 typifying R2's public investment behavior. If $h_2 = .8$, then 80 % of R2's funds are invested in infrastructure facilities and 20 % are dedicated to attraction means. A reduction of h_2 implies less means for infrastructure investments and more funds for capital subsidies designated to attract private capital from R1. (c) The matching relationship of R2's capital subsidies and private capital attracted from R1 is expressed by v_{12} as a parameter characterizing the public-private relationship of R2 to R1. This important parameter (cf. Franz and Schalk 1982) may be interpreted in two ways. First, the parameter v_{12} is defined as amount of private capital attracted from R1 per unit of capital subsidy; in this context v_{12} may be taken as a parameter indicating the investment behavior of private entrepreneurs in R1. Second, the parameter $1/v_{12}$ is defined as the amount of capital subsidy per unit of private capital attracted from R1; here $1/v_{12}$ may be considered as a politically determined parameter. Both interpretations may be applied subsequently. Note that, for example, $v_{12} = 2$ means that, per unit of capital subsidy, twice the amount of private capital will be attracted from R1; $1/v_{12} = .5$ means that the volume of the capital subsidy is 50 % of the amount of private capital attracted from R1. If we increase v_{12} (reduce $1/v_{12}$), we increase the amount of private capital transferred from R1 to R2 due to R2's expenditure of public funds to support private capital formation in R2 (we decrease the amount of capital subsidy per unit of private capital attracted from R1). In the following we shall refer to v_{12} as the private capital attraction parameter and to $1/v_{12}$ as the rate of capital subsidy.

For realistic changes of active policy parameters Table 3 indicates elasticities of selected model variables on the basis of the values of passive policy parameters ($v = .8$, $h_2 = .995$, $v_{12} = .8$). The

elasticities are calculated with reference to the numerical data of the year 15.

Parameter Variation (ceteris paribus)	Selected Variables						
	K_1^S	K_2^S	B_1^S	B_2^S	Y_1	Y_2	Y
$\nu = .75$	+ .0669	+ .0312	+ .5047	-1.2980	+ .3535	- .1511	+ .2521
$= .65$	+ .0703	+ .0328	+ .4975	-1.2565	+ .4525	- .1442	+ .3326
$= .50$	+ .0695	+ .0326	+ .4799	-1.2027	+ .4612	- .1364	+ .3411
$h_2 = .90$	+ .0285	- .1596	- .0003	+ .3465	- .0009	- .0478	- .0104
$= .75$	+ .0288	- .1594	0	+ .3466	- .0008	- .0459	- .0099
$= .60$	+ .0289	- .1593	+ .0002	+ .3467	- .0009	- .0440	- .0095
$\nu_{12} = .9$	- .0001	+ .0004	0	0	0	0	0
$= 2.0$	- .0001	+ .0004	0	0	0	+ .0002	0
$= 3.0$	- .0001	+ .0004	0	0	0	+ .0002	0

Table 3: Elasticities of Selected Variables with Regard to Active Policy Parameters

Although the magnitude of the elasticities of model variables depends on the relative weights of the parameters in the assumed parameter reference set, this table gives some important information for regional economic policy under the given circumstances. Particularly noteworthy is the negative impact of a reduction of ν as the state distribution parameter (additional public funds for R2) on the selected variables, except for B_2^S and Y_2 . If regional policy is pursued solely in this form at the state level, then the policy of passive adjustment will always be clearly superior. But with respect to variations of R2's distribution parameter h_2 (additional attraction funds, reduced infrastructure investments) we note the growth (although modest) of capital stock K_2^S - the development of B_1^S is

difficult to assess - and regional incomes Y_1 , Y_2 , and national income Y beyond the fifteen years regional and national development under passive adjustment. Regarding the capital attraction parameter v_{12} (additional private capital attracted from R1) the elasticities of the table only seem to indicate that, on the basis of the passive policy parameters, the changes of v_{12} shown by the table are too small to significantly raise regional incomes and national income within the fifteen years period. Thus we may suspect that, in general terms, a policy of active adjustment will be the more successful the smaller the relative reduction of ν and the larger the relative decrease of h_2 and the relative increase of v_{12} , with particular emphasis on the rise of v_{12} , as we shall see in a later context. Thus, this regional policy parameter of interregional investment interaction merits our special attention.

Let us assume that policy-makers understand the general policy rule described above; however, they only vaguely know the assumptions and content of the model that shall be taken as an adequate picture of economic reality. Under these circumstances policy-makers will choose and can realize a particular realistic set of active adjustment parameters (percentage changes as related to passive adjustment in brackets): $\nu = .7$ (-12.5 %), $h_2 = .75$ (-24.6 %), and $v_{12} = 1.5$ (+87.5 %). These active policy parameters imply that 30 % of national savings are dedicated to R2, that 75 % of R2's funds are spent on infrastructure investments (25 % on attraction means) and that R2's rate of capital subsidy is 66.7 %. The model results may again be compared to those of the passive policy. This comparison will reveal some positive aspects, but on the whole the outcome will turn out to be disappointing - as is often the case in the reality of regional economic policy.

Again we start in the growth restricting system B_1/K_2 which prevails throughout the entire period. During this time income and capital stocks of R1 are significantly higher and grow faster than the corresponding variables of R2. In comparison to the results of the passive policy the growth rates are now lower for R1 and higher for R2. Regarding the development of regional incomes we note that national income decreases under the active strategy (cf. Figure 4; AP = Active Policy, PP = Passive Policy). Under this policy per capita income of R1 is still distinctly higher than that of R2, but does not grow so fast. The comparison with the results of the passive strategy is as before so that the interregional difference in per capita incomes falls in the active policy case (cf. Kuehn 1971).

As far as national income is concerned (cf. Figure 4) we must stress that, in the present context, the income reduction relative to the passive policy outcome $((Y^{AP} - Y^{PP})/Y^{PP})$ is substantial (2.8 % in year 15), however rather small in view of percentage figures ranging up to 20 % and more for alternative parameter constellations of active adjustment policy within the fifteen years period.

While now L_1^S increases by 30.1 %, L_2^S rises by 1.9 % during fifteen years. A salient point is that the net outmigration rate of R2 only goes up from 1.3 % to 1.4 % in the fifteenth year.

Average infrastructure provision in R1 remains higher than in R2, but grows faster in R2 so that the interregional provision relationship improves in favor of R2. As compared with the results of the passive strategy the fifteen years growth rates of regional infrastructure provision for R1 are now lower and those for R2 are higher.

The wealth transfer from R1 to R2, W_{12} , increases, whereas W_{21} remains

constant.

With respect to the rates of factor stock idleness we get: UK_1 (from .4 % to 4.1 % (now increased)), UK_2 (fully employed), UB_1 (fully utilized), UB_2 (from 1.6 % to 16.9 % (now reduced)), UL_1 (from 3.4 % to 3.9 %), and UL_2 (from 17.1 % to 18.1 % (now reduced)).

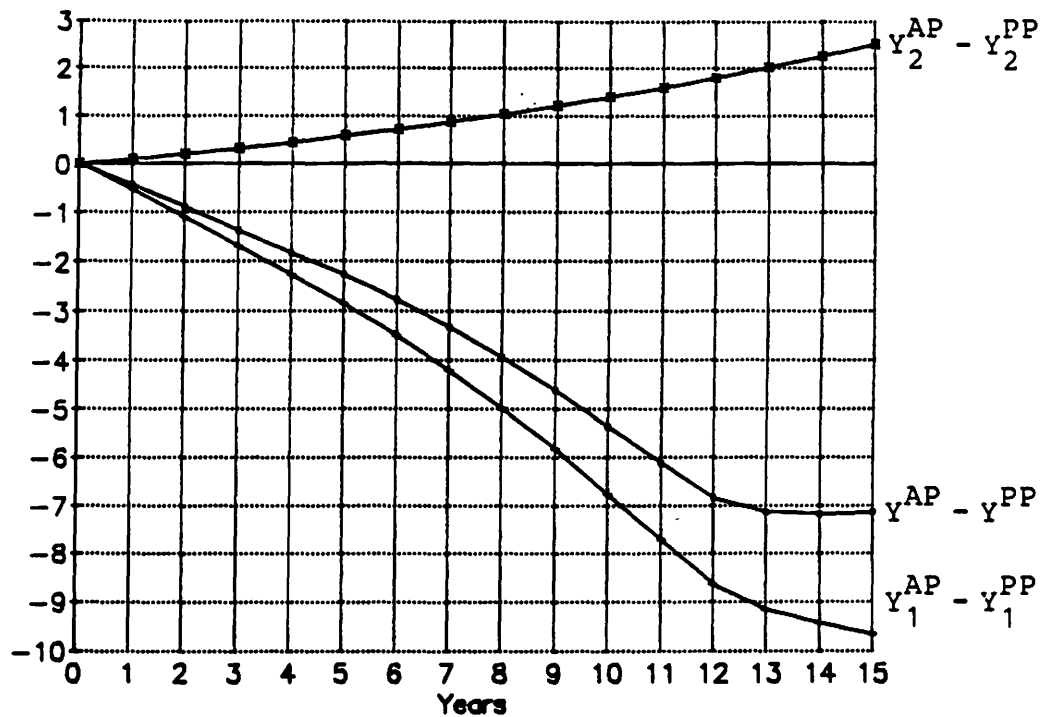

Figure 4: Regional and National Income Differences under the Active Policy (AP) as Compared to the Calculation Results of the Passive Policy (PP) (in billions)

The shares of the factors in regional production either do not change at all or change very little as compared with the passive policy case. The latter statement also holds for the development of regional wage rates.

The investment and trade ratios are: R1's ratio of private investment (from 10.8 % to 9.8 % (percentage level now reduced));

R2's ratio (from 4.5 % to 7.9 % (percentage level now increased)); ratio of public investment for R1 (from 2.8 % to 2.4 % (percentage level now reduced)); ratio for R2 (from 2.1 % to 3.7 % (percentage level now raised)); R1's ratio of private goods exports (from 1.1 % to 1.5 % (percentage level now increased)); R2's ratio remains unchanged (4.0 %); ratio of private goods imports of R1 (from 1.4 % to 1.1 % (level now slightly increased)); and ratio of R2 (from 3.3 % to 5.4 % (percentage level now increased)).

Under active policy there is a substantial stream of private capital flowing from R1 to R2 due to public activity in R2 (see the increase of R2's ratio of private goods imports under the active policy as compared with the passive policy). Region R1's initially very small current account deficit turns into a modest surplus. However, as before, interregional trade and capital transfers are made at a rather low level.

In all, we may conclude that the present active policy approach is characterized by some positive aspects such as the rise of R2's income and capital stock, the slowed increase of R2's rate of unemployment and the shrinkage of the interregional per capita income difference. However, these results are disappointing, since they turn out to be small in impact. In addition - and that is even more important - national income decreases substantially. Thus we may observe a conflict of goals between R2's interests and the national growth objective. This situation will be intensified by the active policy parameter set of $\nu = .65$, $h_2 = .8$, and $v_{12} = 3.0$, meaning that 35 % of national savings are dedicated to R2, that 80 % of R2's available funds are spent on infrastructure investments (20 % on attraction means) and that R2's rate of capital subsidy is 33.3 %.

If we give priority to the national growth objective, we must put the question of whether the policy of active adjustment can be successful within the fifteen years period. There are three cases in which an affirmative answer can be given; the preconditions for each case are discussed in the following.

(a) Policy-makers have the good luck to decide in favor of the following "bull's-eye" solution: $\nu = .75$, $h_2 = .75$, and $v_{12} = 5.0$ ($1/v_{12} = 20\%$). The implied fifteen years development of selected variables is as follows (percentage changes of the variables under the passive strategy in brackets; the rates of unemployment concern the fifteenth year): national income 61.4% (61.2%), R1's income 69.0%

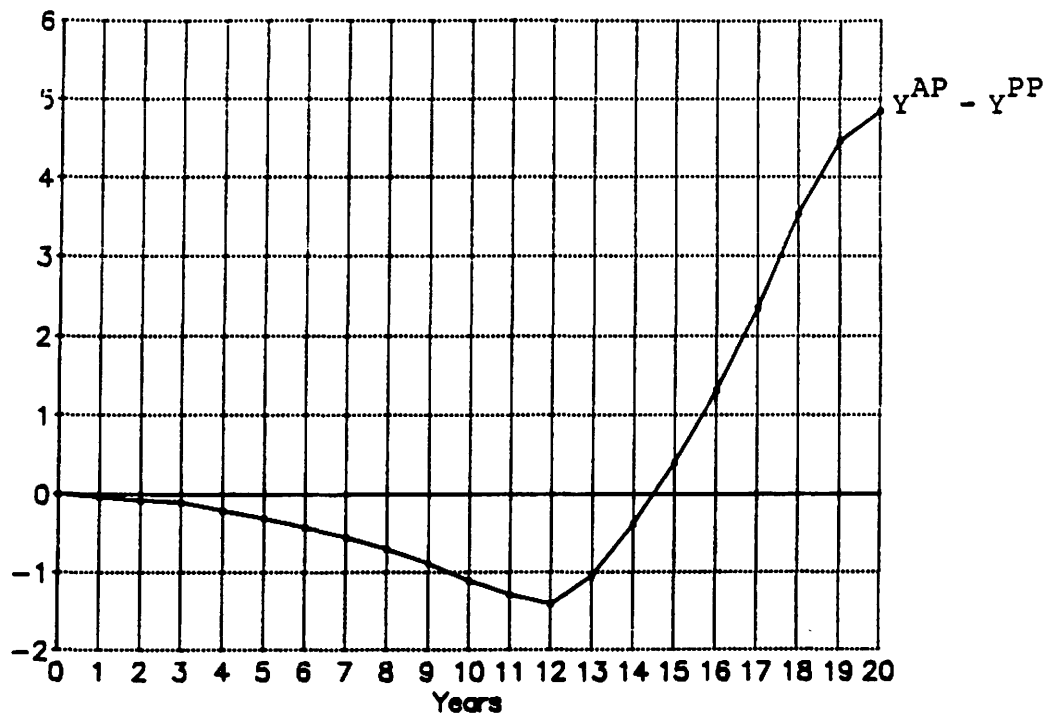

Figure 5: A Solution of the Policy Problem: National Income Differences (in billions)

(72.5 %), R2's income 39.1 % (27.8 %), R2's capital stock 34.9 % (15.9 %), R2's rate of unemployment 14.0 % (20.5 %), interregional per capita income difference decreasing, interregional per capita infrastructure provision increasing (for national income cf. Figure 5 that is extended to twenty years to indicate total income growth beyond year fifteen). Under this solution there are no (other) unacceptable model results. In all, this solution must be considered outstanding, in particular regarding the relatively short period of nearly fifteen years during which national income will fall under the active regional economic policy in order then to rise substantially. However, we must admit that this argument implies that the income gains to be expected in the future, beyond year 15, are valued higher than the income losses experienced within the fifteen years period.

This approach shows that the present policy problem cannot be solved by massive investment in R2. What is needed is a policy differentiated according to the growth barriers of R1 and R2. The main problem of this approach is how to find the favorable parameters and how to implement them in practice (observe the character of $v_{12}!$).

(b) Another possible solution of the present policy problem may be derived from the calculation results referred to above. This solution can be implemented by changing the parameter ν by a certain sufficiently small percentage from its passive adjustment value to ν^1 (path of income differences OAI in Figure 6) and then by successively augmenting the parameters $(1-h_2)$ and v_{12} in time, then again lowering ν to ν^2 and successively increasing $(1-h_2)$ and v_{12} and so on. According to Figure 6 the path of income differences OABCDEFGH would clearly be preferable.

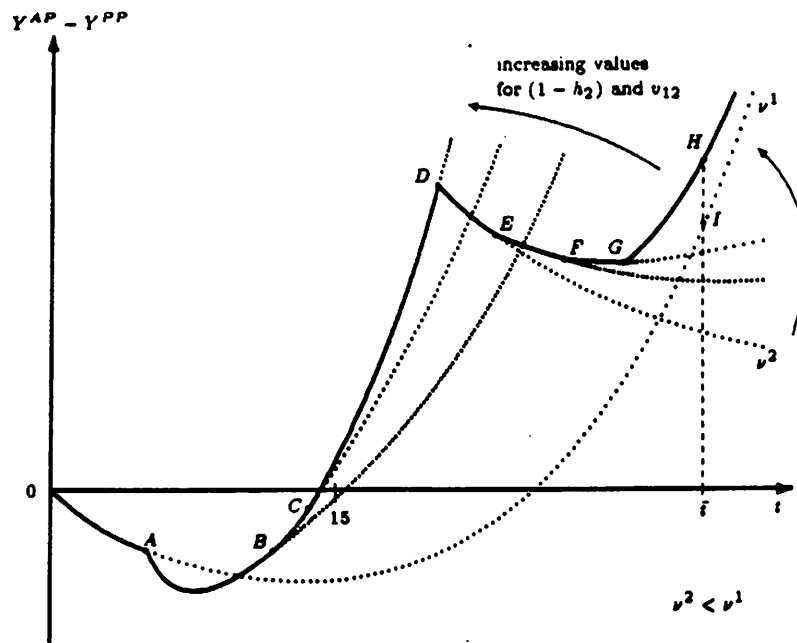

Figure 6: Another Solution of the Policy Problem: National Income Differences (in billions)

The problem of this approach obviously lies in its realization in the political practice of decision-making.

(c) The third solution may originate from additional initiatives of R2 and R1. Let us take the active policy approach described above ($v = .7$, $h_2 = .75$, $v_{12} = 1.5$) as a basis and additionally consider the following alternatives: (1) increase of R2's savings ratio to $s_2^{pr} = .11$ (100 % increase); (2) support of alternative (1) by raising R2's interest rate to $r_2 = .055$; and (3) reduction of R1's ratio of public consumption to $c_1^{pu} = .18$. The changes of selected variables over fifteen years are given in Table 4 (the rates of unemployment again concern the fifteenth year).

	National income Y	R1's income Y ₁	R2's income Y ₂	R2's capital stock K ₂ ^S	R2's rate of unemploy- ment UL ₂	Interregional per capita income diff. infrastr. provision diff.
P-changes alternatives	61.2 %	72.5 %	27.8 %	15.9 %	20.5 %	
1	61.3 %	65.1 %	50.3 %	44.2 %	10.9 %	decreasing
2	63.7 %	65.4 %	58.7 %	65.2 %	4.1 %	decreasing
3	63.6 %	71.4 %	40.6 %	29.8 %	13.3 %	decreasing

Table 4: Growth under Additional Initiatives of the Regions

The main problem of this solution approach is bringing about the necessary changes in the economic behavior of R2's and R1's populations.

4. CONCLUDING REMARKS

The discussion of our case of selected parameters suggests the following general summary statements. First, the empirically relevant results of both strategies depend on the adequate description of reality by the model and the political feasibility of parameter determination. The choice of a particular set of political parameters may imply the failure and thus the rejection of a development strategy aspired to. Finding the "correct" or "successful" combination of parameters is a substantial problem in the practice of regional economic policy. Thus the main policy insight of this paper is that an active regional policy in favor of the lagging regions may be overall successful, if the effects of the political parameters are studied with care, if the necessary corrections of the parameters are made successively and if political decision-making is strongly tied to the objective of raising R2's income during a period of definitely more than fifteen years. Economic insight, patience and persistency are in demand conceptualizing regional economic policy. The logic of this argument underlies the discussion of Figure 6.

Second, the policy of active factor stocks adjustment seems to be the more successful the more direct is the access of regional economic policy to the politically established parameters of the backward areas and the more readily can private initiative (in the form, for instance, of private exports or private savings) be mobilized by political action. High-ranking state regional policy seems to be characterized by a low level of efficiency. The message of the model and its parameters is that regional economic policy for the regions should be substituted by a regional policy by the regions.

Third, the description of the given regional economic policy example showed which restrictive preconditions may have to be fulfilled by a successful policy of active capital stocks adjustment. Regional policy then must persistently concentrate on the limiting growth barriers of the developed and underdeveloped regions, always striving to stimulate private incentives favorable to regional economic development as are related, for instance, to the private savings ratio or the rate of technical progress to be enforced in the developing areas.

Fourth, we must note that an active regional economic policy that is favorable in terms of increasing national income must not necessarily be identical with the policy best suited to improve the lot of the backward regions, for instance to increase their absolute incomes, their per capita incomes and their capital stocks as well as to reduce their rates of unemployment. The resolution of conflicts between national and regional policy objectives will be a further complication in the formulation of acceptable development strategies. Here additional initiatives of the regions may help.

A more realistic description of the present problem implies the construction and use of a more extensive and sophisticated model. Its implementation will have to account for changing parameters in time. The approach adopted above has been consciously simplified with the aim of exposing the basic elements of the argument.

Appendices

A. Symbols Used

B	state budget surplus (deficit)
B_i	stock of public capital (material infrastructure) in region i ($i = 1, 2$)
B_i^D	demand for public capital (material infrastructure) in region i
B_i^S	supply of public capital (material infrastructure) in region i
C_i^{pr}	private consumption of region i
C_i^{pu}	public consumption of region i
E	national population
E_i	population of region i
F_i^{Apr}	private capital outflow from region i
F_i^{Epr}	private capital inflow into region i
F_i^{pu}	total regional transfers to the state
F_i^{Apu}	public resources of region i transferred to the state
F_i^{Epu}	resources re-transferred to region i from the state
G_i^{pu}	capital subsidies of region i
H_i	current account surplus (deficit) of region i
I_i	total investment of region i
I^{pr}	national private investment
I_i^{pr}	private investment of region i
I^{pu}	national public investment
I_i^{pu}	public investment of region i
I_i^{puJ}	infrastructure investments of region i
K_i	private capital stock in region i
K_i^D	capital demand of region i
K_i^S	capital supply of region i
L^S	national labor force
L_i	labor force of region i
L_i^D	labor demand of region i

L_i^S	labor supply of region i
L_{ij}	net migration between region i and region j
\tilde{L}_{ij}	net migration between region i and region j related to interregional differences in wage rates
\approx	
L_{ij}	net migration between region i and region j related to interregional differences in rates of unemployment
M_i	imports of region i
M_i^{pr}	private imports of region i
M_{io}^{pr}	private capital imports of region i from the rest of the world
M_o^{pu}	total public capital imports from the rest of the world
M_{io}^{pu}	public capital imports of region i from the rest of the world
P	national price level
P_i	price level of region i
S_i	total savings of region i
S_i^{pr}	private savings of region i
S^{pu}	total public savings
S_i^{pu}	public savings of region i
T_i	volume of direct taxes and public interest receipts of region i
UB_i	rate of public capital idleness in region i
UK_i	rate of private capital idleness in region i
UL_i	rate of unemployment in region i
W_i	private wealth of region i
W_i^K	private wealth of region i in the form of region i's private capital stock
W_{ij}	private assets held by region i in region j
X_i	output of region i
Y	national net social product at factor prices or national income
Y_i	income of region i
Y_i^D	demand-side income of region i
Y_{in}^D	nominal demand-side income of region i
Y_i^S	supply-side income of region i

Z_i	exports of region i
Z_i^{pr}	private exports of region i
a_i	average labor productivity of region i
a_{i0}	autonomous term of labor productivity of region i
a_{i1}	technical progress parameter of labor productivity of region i
a_{i2}	public capital parameter of labor productivity of region i
a_{i3}	private capital parameter of labor productivity of region i
b_i	average productivity of public capital (material infrastructure) of region i
b_{i0}	autonomous term of public capital productivity of region i
b_{i1}	technical progress parameter of public capital productivity of region i
c_i	share of public capital in production of region i
c_i^{pu}	marginal (average) public propensity to consume of region i
$d_{ij}^{i(j)}$	unemployment oriented parameter of net migration between region i and region j related to labor supply in region i (j)
$e_{ij}^{i(j)}$	wage rate oriented parameter of net migration between region i and region j related to labor supply in region i (j)
f_i^{pu}	marginal (average) propensity to transfer resources for public purposes from region i to the state
g_i	share of private capital in production of region i
h_i	share of region i's infrastructure investments in region i's available public funds ((1 - h_i) = share of region i's capital subsidies in region i's available public funds)
\bar{i}_{ij}	parameter of exports from region i to region j
k_i	average productivity of private capital in region i
k_{i0}	autonomous term of private capital productivity in region i
k_{i1}	technical progress parameter of private capital productivity in region i
k_{i2}	public capital parameter of private capital productivity in region i
k_{i3}	private capital parameter of private capital productivity in region i
n_i	growth rate of natural labor force (population) in region i

q_i share of labor in production in region i
 r_i rate of interest applied to private capital in region i
 r_i^* rate of interest applied to public capital in region i
 s_i^{pr} marginal (average) private propensity to save in region i
 t time
 t_i marginal (average) direct tax rate of region i
 v_{ij} parameter of private capital attracted from region i to region j ($1/v_{ij}$ = rate of capital subsidy of region j in relation to region i)
 w_i wage rate of region i
 ν developed regions' share in national public savings ($(1 - \nu)$ = backward regions' share in national public savings)
 ρ additional parameter for the no-growth case
 τ parameter adjusting the national price level
 τ_i parameter adjusting the price level of region i
 φ summation term in model relationship (42a)

B. Parameters and Initial Values for the Model Version of Passive Adjustment

R1

R2

(1) Parameters

$$a_{10} = 19\ 910; a_{11} = 350$$

$$a_{20} = 14\ 600; a_{21} = 340$$

$$a_{12} = .000\ 000\ 000\ 05$$

$$a_{22} = .000\ 000\ 000\ 128$$

$$a_{13} = .000\ 000\ 000\ 016$$

$$a_{23} = .000\ 000\ 000\ 067$$

$$b_{10} = 1.348; b_{11} = .0004$$

$$b_{20} = 1.343; b_{21} = .0013$$

$$k_{10} = .22; k_{11} = .003$$

$$k_{20} = .205; k_{21} = .001$$

$$k_{12} = .000\ 000\ 000\ 000\ 109$$

$$k_{22} = .000\ 000\ 000\ 000\ 582$$

$$k_{13} = -.000\ 000\ 000\ 000\ 035$$

$$k_{23} = -.000\ 000\ 000\ 000\ 165$$

$$r_1 = .06; r_1^* = .021$$

$$r_2 = .045; r_2^* = .018$$

$$s_1^{pr} = .105$$

$$s_2^{pr} = .055$$

$$t_1 = .2075; c_1^{pu} = .195$$

$$t_2 = .1975; c_2^{pu} = .19$$

$$\bar{i}_{12} = .015; v_{12} = .8$$

$$\bar{i}_{21} = .03; v_{21} = 0$$

$$v = .8; h_1 = 1.0;$$

$$h_2 = .995$$

$$n_1 = .011$$

$$n_2 = .015$$

$$e_{12}^1 = 0; d_{12}^1 = 0$$

$$e_{12}^2 = .000\ 0017; d_{12}^2 = 180\ 000$$

(2) Initial Values

$$K_1^S = 561\ 100\ 000\ 000$$

$$K_2^S = 211\ 400\ 000\ 000$$

$$B_1^S = 87\ 000\ 000\ 000$$

$$B_2^S = 30\ 000\ 000\ 000$$

$$L_1^S = 6\ 093\ 700$$

$$L_2^S = 3\ 272\ 000$$

$$W_{12} = 120\ 000\ 000\ 000$$

$$W_{21} = 92\ 000\ 000\ 000$$

$$UL_1 = \frac{L_1^S - L_1^D}{L_1^S} = 3.4\ \%$$

$$UL_2 = \frac{L_2^S - L_2^D}{L_2^S} = 17.1\ \%$$

$$M_{20}^{pr} = 0$$

Notes on population:

R1: Using a labor force participation rate of 42.03 % the labor force $L_1^S = 6\,093\,700$ gives 14 500 000 inhabitants; if population density is 1 000 persons per square kilometer, then R1 has the area of 14 500 square kilometers.

R2: The work force $L_2^S = 3\,272\,000$ implies a population of 9 375 000 people, if the labor force participation rate is 34.9 %; applying a population density of 60 inhabitants per square kilometer R2 has an area of 156 250 square kilometers.

Totals:

national labor force $L^S = L_1^S + L_2^S = 9\,365\,700$ employable persons,

national population $E = E_1 + E_2 = 23\,875\,000$ inhabitants,

total area = 170 750 square kilometers.

At the outset the average national rate of unemployment is 8.2 %.

References

- Buhr W. (1993) Regional Economic Growth by Policy-Induced Capital Flows: I. Theoretical Approach. The Annals of Regional Science 27.
- Butzin B (1986) Zentrum und Peripherie im Wandel, Erscheinungsformen und Determinanten der "Counterurbanization" in Nordeuropa und Kanada. Ferdinand Schöningh, Paderborn.
- Franz W und Schalk H-J (1982) Investitionsfördernde Maßnahmen als Mittel der Regionalpolitik: Eine ökonomische Analyse. Jahrbuch für Regionalwissenschaft 3, 5-35.
- Funck RH (1990) Reflections on Regional Development Policy and the Concept of Region, pp. 173-183. In: Chatterji M and Kuenne RE (eds.), New Frontiers in Regional Science, Essays in Honour of Walter Isard, Vol. 1. Macmillan, Basingstoke.
- Institut der deutschen Wirtschaft (ed.) (1990) Zahlen zur wirtschaftlichen Entwicklung der Bundesrepublik Deutschland 1990. Deutscher Instituts-Verlag, Köln.
- (1991) Zahlen zur wirtschaftlichen Entwicklung der Bundesrepublik Deutschland 1991. Deutscher Instituts-Verlag, Köln.
- Kuehn JA (1971) Income Convergence - A Delusion. Review of Regional

- Studies 2: 41-51.
- Leamer EE (1985) Sensitivity Analysis Would Help. *The American Economic Review* 75: 308-313.
- Polenske KR (1981) Regional Methods of Analysis for Stagnating Regions, pp. 111-141. In: Buhr W and Friedrich P (eds.), *Lectures on Regional Stagnation*. Nomos, Baden-Baden.
- Stobbe A (1980) *Volkswirtschaftslehre I: Volkswirtschaftliches Rechnungswesen*, fifth ed. Springer-Verlag, Berlin Heidelberg New York.
- Statistisches Bundesamt (ed.) (1985) Reihe S.7: Lange Reihen 1950 bis 1984, *Volkswirtschaftliche Gesamtrechnungen, Fachserie 18*. W. Kohlhammer, Stuttgart Mainz.
- (1990) *Statistisches Jahrbuch 1990 für die Bundesrepublik Deutschland*. Metzler-Poeschel Verlag. Stuttgart.
- Winston GC (1974) The Theory of Capital Utilization and Idleness. *Journal of Economic Literature* 12: 1301-1320.

- 01 **Axel A. Weber**, Stochastic Process Switching and Intervention in Exchange Rate Target Zones: Empirical Evidence from the EMS
- 01 **Axel A. Weber**, The Role of Policymakers' Reputation in the EMS Disinflations: An Empirical Evaluation
- 01 **Klaus Schöler**, Business Climate as a Leading Indicator? An Empirical Investigation for West Germany from 1978 to 1990
- 01 **Jürgen Ehlgen, Matthias Schlemper, Klaus Schöler**, Die Identifikation branchenspezifischer Konjunkturindikatoren
- 01 **Reiner Wolff**, On the Existence of Structural Saddle-Points in Variational Closed Models of Capital Formation
- 01 **Axel A. Weber**, Time-Varying Devaluation Risk, Interest Rate Differentials and Exchange Rates in Target Zones: Empirical Evidence from the EMS
- 01 **Walter Buhr and Reiner Wolff**, Partial versus Global Optimization in Economic Dynamics: The Case of Recursive Programming
- 01 **Klaus Schöler**, Preisvariationen und beschränkte Informationen in einem räumlichen Oligopol
- 02 **Jürgen Ehlgen**, Lösen des stochastischen Wachstumsmodells durch Parameterisieren der Entscheidungsfunktion
- 02 **Alfred W. Marusev und Andreas Pfingsten**, Zur arbitragefreien Fortrechnung von Zinsstruktur-Kurven
- 02 **Jürgen Ehlgen, Matthias Schlemper, Klaus Schöler**, Die Anwendung branchenspezifischer Konjunkturindikatoren
- 02 **Klaus Schöler**, Zum strategischen Einsatz räumlicher Preistechniken
- 02 **Günter Knieps and Rüdiger Pethig**, Uncertainty, Capacity Costs and Competition in the Electric Power Industry

Seit 1989 erschienene Diskussionsbeiträge:
Discussion papers released as of 1989/1990/1991/1992:

- 1-89 **Klaus Schöler**, Zollwirkungen in einem räumlichen Oligopol
- 2-89 **Rüdiger Pethig**, Trinkwasser und Gewässergüte. Ein Plädoyer für das Nutzerprinzip in der Wasserwirtschaft
- 3-89 **Rüdiger Pethig**, Calculus of Consent: A Game-theoretic Perspective. Comment
- 4-89 **Rüdiger Pethig**, Problems of Irreversibility in the Control of Persistent Pollutants
- 5-90 **Klaus Schöler**, On Credit Supply of PLS-Banks
- 6-90 **Rüdiger Pethig**, Optimal Pollution Control, Irreversibilities, and the Value of Future Information
- 7-90 **Klaus Schöler**, A Note on "Price Variation in Spatial Markets: The Case of Perfectly Inelastic Demand"
- 8-90 **Jürgen Eichberger and Rüdiger Pethig**, Constitutional Choice of Rules
- 9-90 **Axel A. Weber**, European Economic and Monetary Union and Asymmetries and Adjustment Problems in the European Monetary System: Some Empirical Evidence
- 10-90 **Axel A. Weber**, The Credibility of Monetary Target Announcement: An Empirical Evaluation
- 11-90 **Axel A. Weber**, Credibility, Reputation and the Conduct of Economic Policies Within the European Monetary System
- 12-90 **Rüdiger Ostermann**, Deviations from an Unidimensional Scale in the Unfolding Model
- 13-90 **Reiner Wolff**, Efficient Stationary Capital Accumulation Structures of a Biconvex Production Technology
- 14-90 **Gerhard Brinkmann**, Finanzierung und Lenkung des Hochschulsystems – Ein Vergleich zwischen Kanada und Deutschland
- 15-90 **Werner Güth and Rüdiger Pethig**, Illegal Pollution and Monitoring of Unknown Quality – A Signaling Game Approach
- 16-90 **Klaus Schöler**, Konsistente konjekturale Reaktionen in einem zweidimensionalen räumlichen Wettbewerbsmarkt
- 17-90 **Rüdiger Pethig**, International Environmental Policy and Enforcement Deficits
- 18-91 **Rüdiger Pethig and Klaus Fiedler**, Efficient Pricing of Drinking Water
- 19-91 **Klaus Schöler**, Konsistente konjekturale Reaktionen und Marktstrukturen in einem räumlichen Oligopol

