

Sasaki, Kuniaki; Nishii, Kazuo; Kitamura, Ryuichi; Kondo, Katsunao

Conference Paper

A Time-Space Analysis of Urban Activities with Focus on the Relationship between ICT and Activity-Travel

45th Congress of the European Regional Science Association: "Land Use and Water Management in a Sustainable Network Society", 23-27 August 2005, Amsterdam, The Netherlands

Provided in Cooperation with:

European Regional Science Association (ERSA)

Suggested Citation: Sasaki, Kuniaki; Nishii, Kazuo; Kitamura, Ryuichi; Kondo, Katsunao (2005) : A Time-Space Analysis of Urban Activities with Focus on the Relationship between ICT and Activity-Travel, 45th Congress of the European Regional Science Association: "Land Use and Water Management in a Sustainable Network Society", 23-27 August 2005, Amsterdam, The Netherlands, European Regional Science Association (ERSA), Louvain-la-Neuve

This Version is available at:

<https://hdl.handle.net/10419/117732>

Standard-Nutzungsbedingungen:

Die Dokumente auf EconStor dürfen zu eigenen wissenschaftlichen Zwecken und zum Privatgebrauch gespeichert und kopiert werden.

Sie dürfen die Dokumente nicht für öffentliche oder kommerzielle Zwecke vervielfältigen, öffentlich ausstellen, öffentlich zugänglich machen, vertreiben oder anderweitig nutzen.

Sofern die Verfasser die Dokumente unter Open-Content-Lizenzen (insbesondere CC-Lizenzen) zur Verfügung gestellt haben sollten, gelten abweichend von diesen Nutzungsbedingungen die in der dort genannten Lizenz gewährten Nutzungsrechte.

Terms of use:

Documents in EconStor may be saved and copied for your personal and scholarly purposes.

You are not to copy documents for public or commercial purposes, to exhibit the documents publicly, to make them publicly available on the internet, or to distribute or otherwise use the documents in public.

If the documents have been made available under an Open Content Licence (especially Creative Commons Licences), you may exercise further usage rights as specified in the indicated licence.

A Time-Space Analysis of Urban Activities with Focus on the Relationship between ICT and Activity-Travel

By

Kuniaki Sasaki

Institute of Materials and Environmental Technology

University of Yamanashi

E-mail: sasaki@yamanashi.ac.jp

Kazuo Nishii

Institute of Materials and Environmental Technology

University of Yamanashi

E-mail: knishii@yamanashi.ac.jp

Ryuichi Kitamura

Department Urban Management

Kyoto University

E-mail: rkitamura@term.kuciv.kyoto-u.ac.jp

Katsunao Kondo

Department of Information and Economics

University of Marketing and Distribution Sciences

E-mail: kondo@umds.ac.jp

1. INTRODUCTION

1-1 Background of This Study

Information and communications technology (ICT) has evolved substantially and impacted urban residents' everyday life quite substantially in the past decade. The rapid spread of mobile telecommunications technologies has produced significant changes in relationships among communications, marketing and distribution, and transportation. As mobile technologies diminish time-space constraints (that have governed telecommunication, they are prompting the emergence

of new life styles with unprecedented ways in which urban space is consumed.

The focus of this study is on how mobile telecommunication technologies have influenced daily activity and travel behaviors of urban residents as Anderson (2004) did. Temporal and spatial characteristics of their activity-travel patterns are empirically analyzed using activity diary data sets collected by the authors in the Kofu area of Japan. The survey is designed with the intent of capturing both patterns of movements in the urban area and patterns of activities that induced the movements. Questions regarding telecommunications activities are introduced into the activity-travel diary that had been developed by the authors to facilitate the acquisition of information on the occurrence and contents of telecommunications activities.

1-2 Analytical Framework of This Study

The analytical framework of this study is formed by the relationship analysis between time use, travel behavior and telecommunication. Conventional means of inter-individual communication (meeting, stationary telephones, mailed letters and telegrams) are all subject to certain constraints in the time-space domain. On the other hand, telecommunications activities by mobile technologies are not subjected to many of the constraints and can influence travel decisions more spontaneously than do conventional means of communication. Several hypotheses concerning ICT and activity patterns are postulated and empirically examined with the results of the diary surveys.

The Survey of Communication, Activity and Travel, denoted by “SCAT,” was conducted twice to form the database of this study. The first survey involved about 150 university students and data on weekly activity patterns and mobile telecommunication incidents were collected. The second survey addressed about 150 households (322 individuals) and activity diaries on two consecutive days and mobile telecommunication information were obtained.

The first SCAT data are used to examine basic properties of ICT–activity-travel relationships of “heavy mobile-informed travelers” because students are certainly standing on the forefront of ICT use. On the other hand, the second SCAT data are used to analyze characteristics of joint activity engagement by household members as a result of ICT use among household members. Then, using both of the SCAT data sets, the hypotheses are examined and statistical evidence is presented. Finally, implications of the findings are summarized and directions are suggested for future research on ICT, activity and travel.

2. SCAT (Survey on Communication, Activity and Travel) DATA

In this study, results of the SCAT (Survey on Communication, Activity and Travel behaviors) are analyzed. SCAT was conducted on about 150 students of five Universities in Japan.

Approximately thirty students are sampled from each university. The main contents of this survey are divided into two parts: One is the activity diary survey that out-of-home and in-home activities and all trips are recorded on each day in their entirety for a week. The other is the communication records, on which the objectives of the survey answer their telecommunication usage in the surveyed day (on either Sunday or Monday). Using these activity diary data, activities are classified in seven typical patterns.

For the analyzing the individuals' decision making mechanism underlying their activities, the relationships between communication profiles and the activity diary data are empirically examined in this study. We focus on telecommunication related to their planned activities. Hypotheses should be therefore postulated for the identification of causal relationships between the activity data and the mobile communication records.

The survey denoted by SCAT aims to identify relationships between activity and mobile communication. In this survey, the total number of distributed questionnaire sheets is 258, and the collecting ratio is 65.5%. The 153 sampled students are selected from five universities; UMDS, Univ. of Tokyo, Kyoto Univ., Osaka City Univ., and Univ of Yamanashi. They consist of 80% for male and 20% for female. About 88% of the samples are under-graduated students. Their ownership ratio of cellular phones is almost 100% and that of mobile PCs with the high-speed Internet service is 22%. The distribution of the year when they started to use cellular phones is 22% in 1998, 35% in 1999, 30% in 2000, and 13% in other years.

Table 2-1 shows the contents of SCAT. One-week activity diary contains information of the whole of in-home and out-of-home activities and travel; activity content, the starting and ending time, travel mode, and trip destination. In this survey, one-week planned activities are recorded before the day starting to answer the AD questionnaire sheet. The surveyed items also include telecommunication time, tools, and contents of communication. The aggregated results are presented in the next section.

3. EMPIRICAL OBSERVATIONS of SCAT DATA

3-1. Basic characteristics of activity and telecommunication patterns

Let us introduce the basic characteristics of telecommunication activities as a result of the aggregation analysis on the data of SCAT. In this survey, the sampled students are divided into two groups: One group consists of the students who record the whole of telecommunication activities on Sunday, and the other is those who do it on Monday. **Figures 3-1** and **Figure 3-2** show the frequencies of telecommunications in a day for Sunday and Monday. From these figures, it can be found that the average of the number of telecommunications per day per person is 9.1 on Sunday

and 12.6 on Monday. It is noted that both of frequencies are widely distributed. **Table 3-1** shows the average of the number of telecommunication activities by mode. The mode is here defined as follows; dialing phone, receiving phone call, sending e-mails, receiving e-mails, viewing web sites. Also, the correlation coefficient between the distribution of the number of telephones and e-mail on the weekdays is 0.406, although those coefficients for other cases are low values. **Figure 3-3** and **Figure 3-4** show distributions of the starting time of telecommunications by mode. It can be found from these figures that the distribution of phone use is different from that of e-mail.

3-2. A cluster analysis of Telecommunication and Time Use

A cluster analysis here consists of two steps as follows: In the first step, a principal component analysis is applied using the data of time use patterns and telecommunication behaviors, respectively. This step enables us to extract several principal components and define their values for each of the sampled individuals to apply them to the second step. The 16 variables such as the duration time of each activity, the frequencies of both in-home and out-of-home activities, and number of trips are used in the analysis of time-use patterns. On the other hand, in the case of telecommunication behaviors, the following 18 variables are used. They are listed as below.

The total numbers of telecommunications in a day

The frequencies of telecommunication by each communication mode

The frequencies of telecommunications by content

These variables are applied to each case of communication partner, time-interval and place, respectively.

As a result, the analysis of time use patterns on a week day and a non-workday indicates that seven principal components can be extracted from each data sets with approximately 80% accumulative proportion. The analysis of telecommunication behaviors on a non-workday resulted that six components are extracted with 79% accumulative proportion and five components for workday data with 75% are found out.

In the second step, a cluster analysis is applied to the values of principal components extracted from both time use and telecommunication behavior patterns. This results that there exist 4 clusters for non-workday patterns and 5 clusters for workday patterns. **Table 3-2** and **Table 3-3** present the keywords by cluster-group characterizing activity and telecommunication behaviors. **Figure 3-5** also shows the relationship between activity patterns and telecommunication patterns among these groups. For example, in the case of non-workday data set, the major group is named as the in-home activity and less telecommunication type (Group 1). In this type, it is featured that the average duration of the in-home activities for two days (Saturday and Sunday) is over 30 hours. It is shown that the average duration per day for studying is about two hours and the average duration for hobby activity including the Internet servicing is about four hours. On the contrary, this table

indicates that, on non-workdays, the more out-of-home activity and less telecommunication type is a minor group (Group4).

In the case of weekday data set, the obligatory in-home activity and low telecommunication type corresponds to the Group 1 on non-workdays. It features that other four groups (Group 1,3,4 and 5) are classified into high telecommunication level. This figure indicates that these four groups have variation in their activity patterns.

4. SCAT2 (Survey on Communication, Activity and Travel 2) DATA

The survey was questionnaire form and was implemented in November, 2003. The survey was conducted in sequential two days in weekend and weekday. In other words, the survey was carried out in Sunday and Monday. 158 households were selected from Kofu City. The contents of this survey are divided into two parts, too. One is the activity diary. In this part, all the in-home and out-home activities and trips are recorded. The time and place sharing activities among household members is also recorded to the records of each member in activity diary survey as joint activities. Another part is the telecommunication record. In this part, respondents are required to record the number and its purpose of their use of telecommunication tools of the survey day. Individual and household attributes were also collected in the survey as additional information to the activity and telecommunication diary. The outline of the questionnaire in this survey is summarized in **Table 4-1**.

5. EMPIRICAL OBSERVATIONS of SCAT2 DATA

5-1. The Relation between the Telecommunication, Travel and Activity

In this section, we are going to show the relation among the telecommunication, travel and activities using SCAT2 data. Then, we focused on the weekend activity and investigate the detail of its features, because we expected that we can find the relationships clearly in weekend because of its weakness of time-space constraint. **Figure 5-1** shows the composition of samples by the number of trips. The "1~3 trips" category occupies about half. **Figure 5-2** shows the composition of samples by the number of telecommunications. 1~3 telecommunications category possesses the highest percentage, while 0 telecommunication category is positioned in the second.

Figure 5-3 shows the share of the number of telecommunication and the number of travel on a day. This chart implies that there is positive correlation between telecommunication frequency and the number of trip. This means that there is a complementary relationship between

telecommunication and travel. The difference of average number of trip is statistically significant between the category "0 telecommunication" and the category "others" especially in weekend. That is, those who did not telecommunicate with other person in weekend did not go out on that day. It is noted that this result shows a fact there is a significant relation between telecommunication and travel. **Figure 5-4** shows the relationship between telecommunication and trips. The sample is categorized by the number of trips and the horizontal axis in this figure is the number of telecommunication. The number of telecommunication takes the highest value at 1~3 telecommunications in all category. However, the shapes of the lines are different for each. The significance of difference was confirmed by ANOVA. In the same way, **Figure 5-5** shows the average trip duration time and total time of trips on the category of the telecommunication frequency. It is clear that both average and total time is long on 0 telecommunicated samples and short in over10 communicated samples. There is no significant difference among 1~9 telecommunicated samples. The result of ANOVA for three categories indicates that both average duration time and total trip time in three segments, which are 0 telecommunication segment, 1~9 telecommunications segment and over 10 telecommunications segment, are different at 1% level. These results extract two hypotheses. One hypothesis is that many telecommunications tend to make short travels more, while zero telecommunication yields long travel. Another hypothesis is that long travel tends not to make telecommunication, while short trip tends to make more telecommunication. Here we focus on the characteristics of activities of each group to check the possibility of these hypotheses.

Figure 5-6 shows the average rate of involving in each out-home activity in every 10 minute of non-telecommunicated samples. **Figure 5-7** is the average rate of involving in each out-home activity in over 10 telecommunication frequency category. From the comparison of two figures, the samples in non-telecommunication category are highly engaged in obligatory activities such as work/study or family shopping. The rate of involving in discretionary activity such as meal or private activity is low in non-telecommunicated samples. From these results, the frequency of telecommunication becomes high when obligatory activity is not in the weekend day. This implies that telecommunication is related to discretionary activities. Obligatory activity generally decides far precedently and it is difficult to change its place. This is one of the reasons of geographical characteristics in Figure 5-5. However, it is difficult to explain that the place of discretionary activity is closer to home than obligatory activities because there is no evidence of it.

From these results, it is possible to think that telecommunication might be used to confirm or to make appointment just before such discretionary activities. Additionally, considering the result that frequency of telecommunication is related to travel, telecommunication is possibly used for joint activity. For verifying this hypothesis, the timing of telecommunication for the activity of the day and the timing of out-home discretionary activity is shown together in **Figure 5-8**.

Telecommunication is aggregate number of each hour, and the graph of out-home discretionary activity is the rate of involving in each 10 minutes. This graph clearly shows the difference of two peaks. The peak of telecommunication is at 11 A.M., however the peak of out-home discretionary activity is at around 3 P.M. The difference is about 4 hours. The telecommunication is increasing rapidly at 10 A.M. and decreasing gradually in the afternoon. On the other hand, the ratio of out-home discretionary activity starts to decrease in the evening and keeps higher rate until evening. This is one of the situational evidence that the telecommunication is used for making appointment or confirmation of joint activity before noon.

6. SUMMARY AND DISCUSSION

In this study, we showed some evidences about the relationships between telecommunication and activities. We conducted two surveys; SCAT and SCAT2. The former survey was designed to capture the relationship between telecommunication and activity scheduling among university students. The latter survey was designed to illustrate the role of telecommunication in a household. These two data are not designed for analyzing the spatial features of activity. However, we analyzed activities in the data from the time-space characteristics and relation with ICT (Mainly Mobile Phone) usage. In the first part, the result of the cluster analysis of the SCAT data shows the positive relationship between the number of telecommunication and travel. In the second part, we focused on the trip length as average trip duration and total trip time on weekend. The result shows the statistically significant negative relation between the number of telecommunication and average time of trip duration. That is, when the number of telecommunication increases, the average time of trip duration decreases. We suggested that this relation was caused by the difference of activity from the analysis of involving rate of activity. This relation is summarized like this. The frequency of telecommunication is related with the activity pattern and activity pattern affects the trip length.

References

Anderson, B. (2004): Everyday Time Use in Britain in 1999 -Implications for telecommunication strategy-, Working Paper, University of Essex.

Table 2-1 Questioned Items and Contents of SCAT

Questioned Items	Contents
Weekly planned activities	Contents, starting time, and destination of the out-of-home activities planned in a week
Activity and travel patterns in a week (Activity Diary Survey)	The entire records of in-home activities, out-of-home activities, and trips in a week
Mobile telecommunications in a surveyed day	The records of all telecommunications on either Sunday or Monday: Contents, timing, partners, contents, and modes (receiving/sending by voice call and by SMS
Mobile telecommunications in relation to planned activities of the surveyed day	Contents in detail of telecommunications concerned planned activities of the surveyed day
Individual attributes and preferences	Individuals' attributes such as, sex, age, residence type, and participation in part-time job working, and their preferences on mobile telecommunication

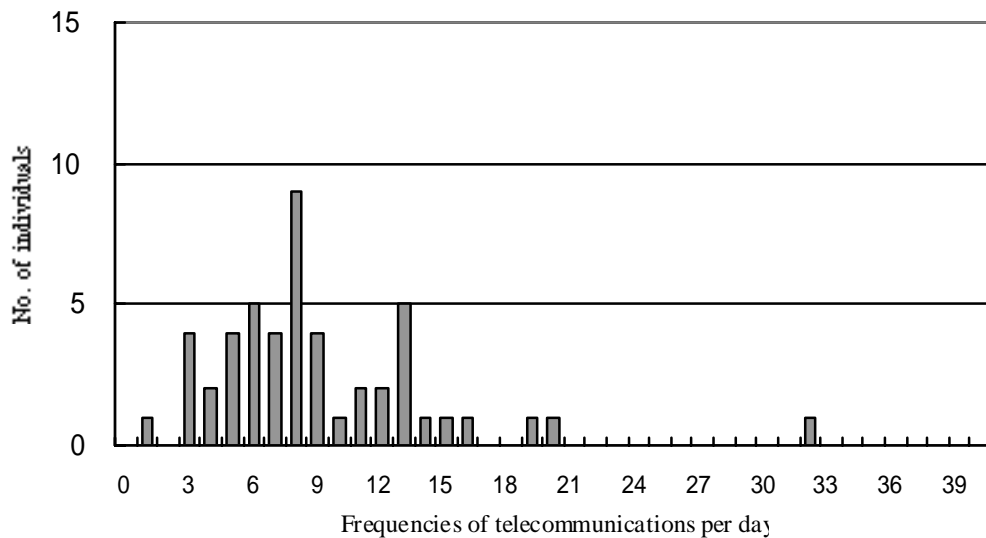

Figure 3-1 Frequency distribution of telecommunications (Sunday)

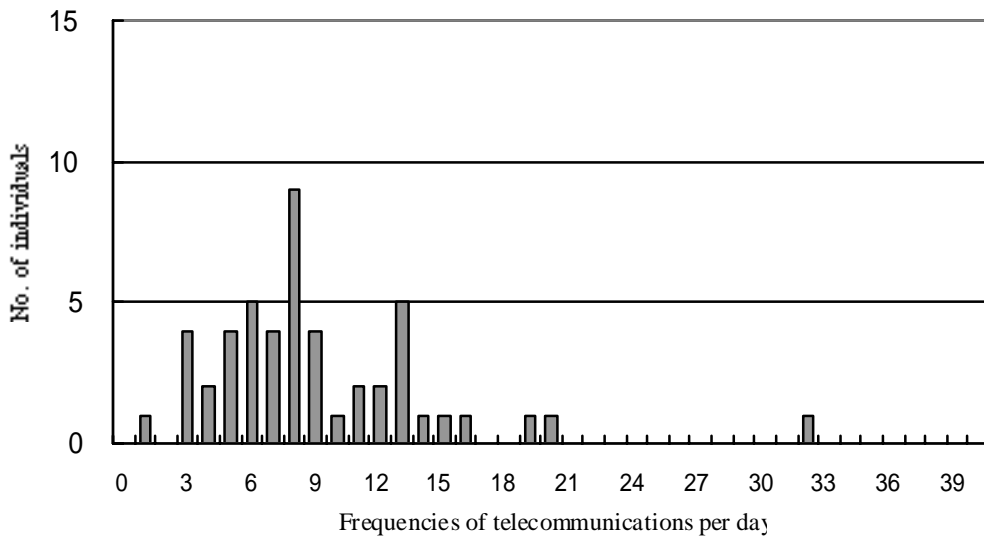

Figure 3-2 Frequency distribution of telecommunication (Monday)

Table 3-1 Average of the number of telecommunication activities by mode

	Average of communications	
	Sunday	Monday
All telecommunication modes	9.1	12.6
Receiving by phone	1.4	1.9
Sending by phone	1.1	1.4
Receiving by e-mail	3.2	4.8
Sending by e-mail	2.2	3.5
Use of web sites	1.2	1.2

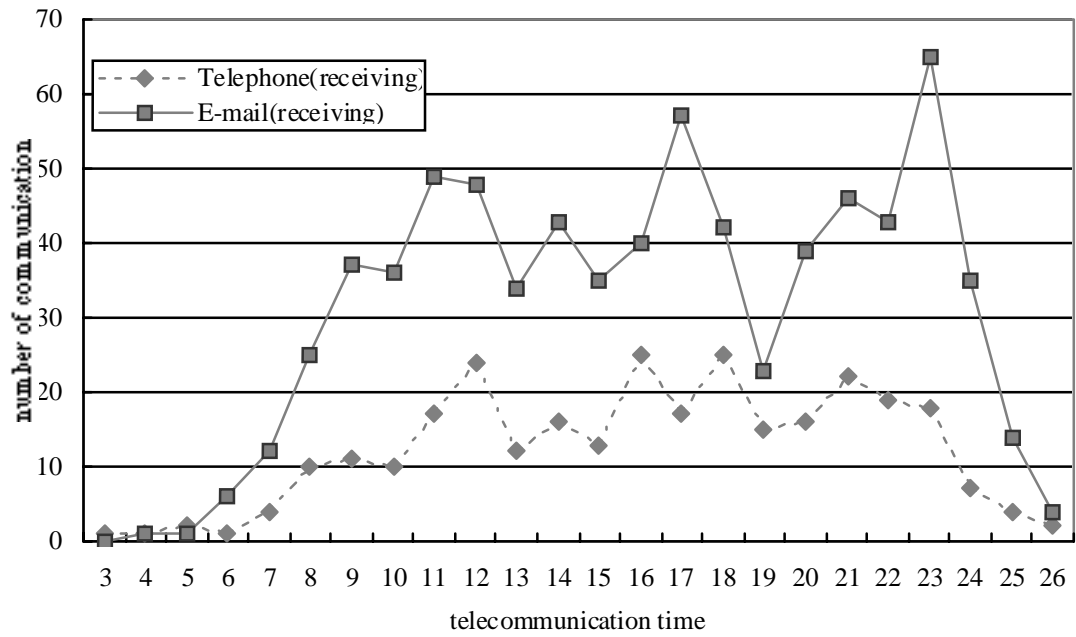

Figure 3-3 Distribution of telecommunication time by mode (receive)

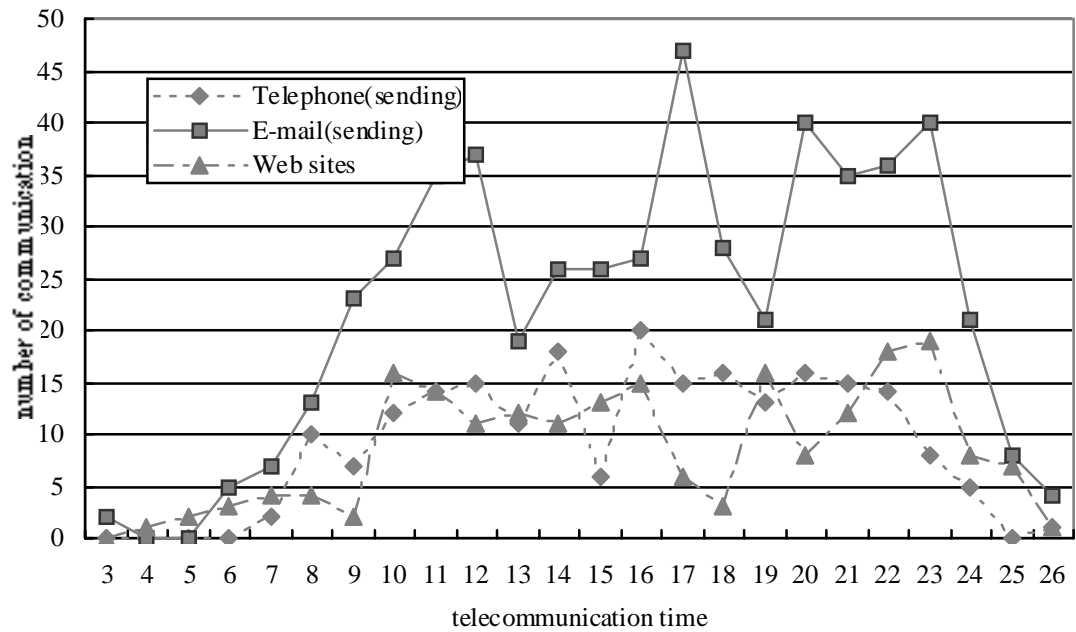

Figure 3-4 Distribution of telecommunication time by mode (send)

Table 3-2 Four groups of activity and telecommunication patterns on non-workdays

Group (No. of individuals)	The features on time use patterns	The features on telecommunication behaviors
Group 1 (26) In-home activity / low telecom.	In-home activity frequency is high (8.8), the duration is long (taste (4hrs), studying (2hrs), house keeping (2hrs)). The total is over 15 hrs.	The total frequency is low (7.8), and cellular phone frequency is also low (5.7).
Group 2 (6) Discretionary out-of-home activity / high tele-communication	Travel time is long (2.5hrs), out-of-home activity frequency is high (4.1), and discretionary activity duration (social recreation:4.5 hrs) is long.	The total frequency is high (15.3), and cellular phone frequency is high (13.7). Especially, the frequency of chattering with friends is high (11.0-12.5)
Group 3 (12) Obligatory in-home and out-of home activity / high telecom.	Obligatory activity duration is long. (For example, eating(2hrs), working(2.3hrs), personal business (2hrs)).	The total frequency is high (9.8), (cellular phone frequency :8.9). The contents are the planned activities on the surveyed day (2.8) and urgent issue calls (1.4).
Group 4 (5) Sport & leisure activity / low telecom.	The total out-of-home activity duration is over 11hrs. Sport & leisure activity duration is about 8.5 hrs.	The total frequency is low (6.6), and cellular phone frequency is also low (6.4).

Table 3-3 Five groups of activity and telecommunication patterns on workdays

Group (No. of individuals)	The features on time use patterns	The features on telecommunication behaviors
Group 1 (43) In-home activity and movement / high telecom.	In-home activity frequency is high (8.0), the duration is long (taste (2hrs), house keeping (2hrs), studying (4hrs)). The total duration is 8hrs. (work:2hrs). Travel time is long (2.5hrs).	The total frequency is high (13.2), and cellular phone frequency is also high (11.6).
Group 2 (37) Obligatory in-home activity and sport & leisure / low tele-communication	In-home activity frequency is high (8.6), the duration is long (taste (2hrs), house keeping (2hrs)). The total is over 16 hrs. Out-of-home activity is Sport & leisure (1hrs). Activity duration for studying is 4hrs.	The total frequency is low (6.6), and cellular phone frequency is also low (5.4).
Group 3 (20) Discretionary and Obligatory out-of home activity / high telecom.	Discretionary out-of-home activity duration is long, (social recreation (2hrs), sport & leisure (1hrs)). Obligatory activity is long (working: 2hrs) The total is over 12 hrs.	The total frequency is high (20.8), and cellular phone is also high (18.1). The contents are concerned with planned activities on the surveyed day (4.8) , the other day (5.0), and chattering (9.5).
Group 4 (9) In-home activity / high telecom.	In-home activity frequency is high (8.6), the duration is long (sleeping (8.3hrs), rest & refreshment (2.5hrs)). The total is over 14 hrs. Out-of-home activity duration is 8hrs. (work:2.5hrs).	The total frequency is high (15.1), and cellular phone frequency is high (13.4). Especially, frequency of chattering is high (11.1)
Group 5 (11) In-home activity & movement / high telecom.	The total out-of-home activity duration is over 11hrs. (medical care, work: 1.5hrs.) Activity duration for studying is 4hrs. Similar to Group 1	The total frequency is high (15.5), and cellular phone frequency is but low (6.8).

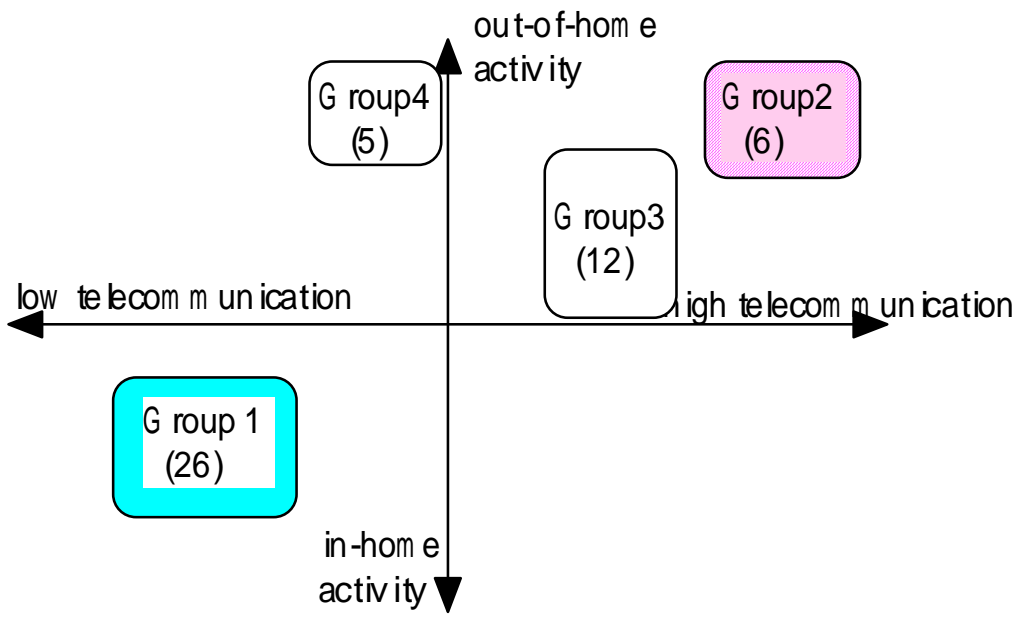

In the case of non-workdays data set

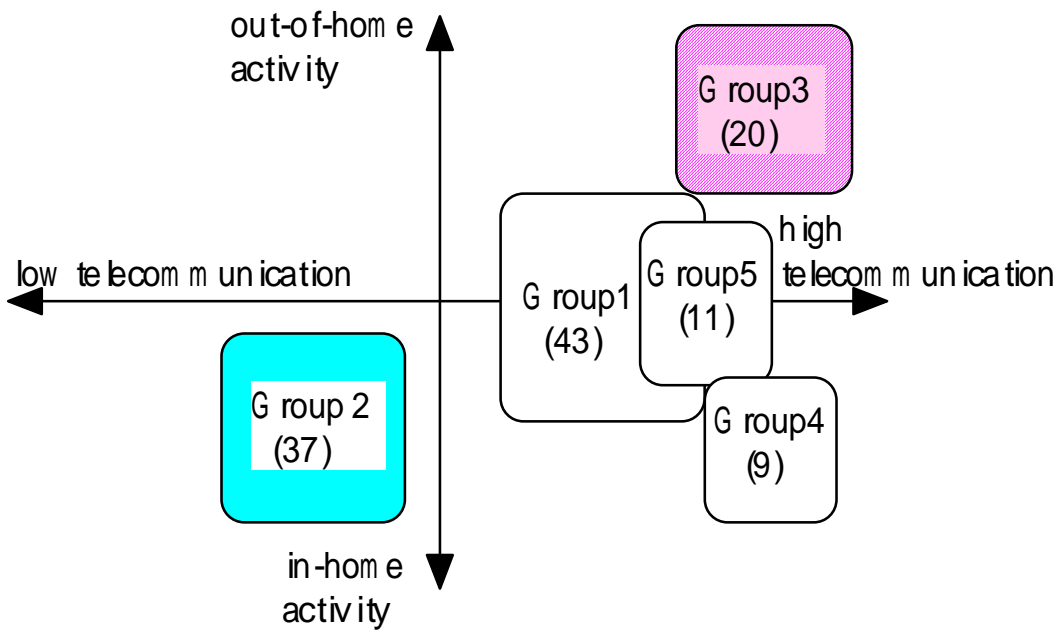

In the case of workdays data set

Figure 3-5 The result of cluster analysis

Table 4-1 Questioned Items and Contents of SCAT2

Questioned Items	Contents
Activity and travel patterns in a week (Activity Diary Survey)	The entire records of in-home activities, out-of-home activities, and trips in a week. If an activity is a joint activity, the respondents mark a check on the questionnaire sheet.
Mobile telecommunications in a surveyed day	The records of all telecommunications on either weekday and weekend: Contents, timing, partners, contents, and modes (receiving/sending by voice call and by SMS)
Mobile telecommunications in relation to planned activities of the surveyed day	Contents in detail of telecommunications concerned planned activities of the surveyed day
Individual attributes and household attributes	Individuals' attributes such as, sex, age, job status and car license status. Household attributes such as car ownership, the number of household members, residential type.

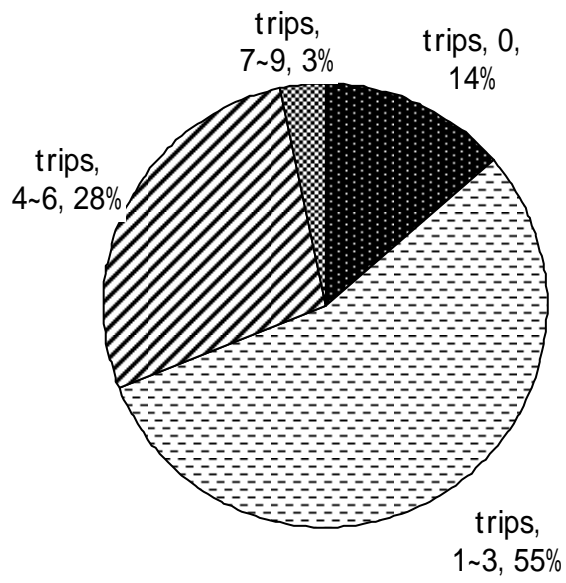

Figure 5-1 The number of trips

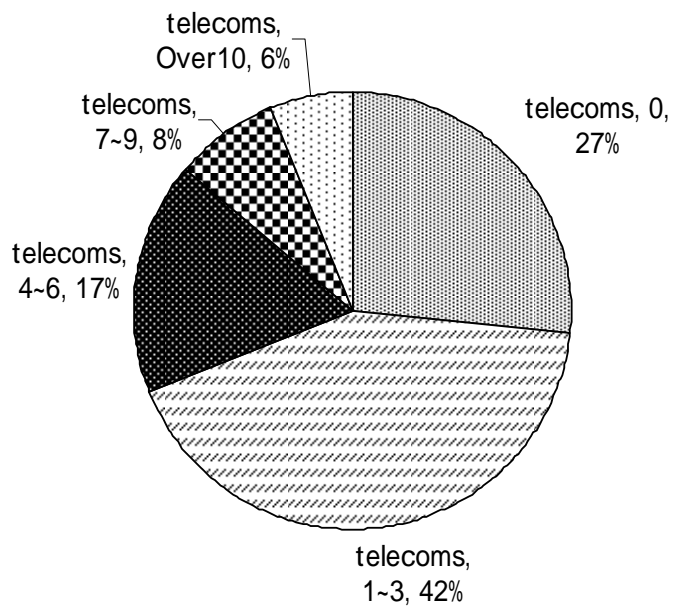

Figure 5-2 The number of telecommunications

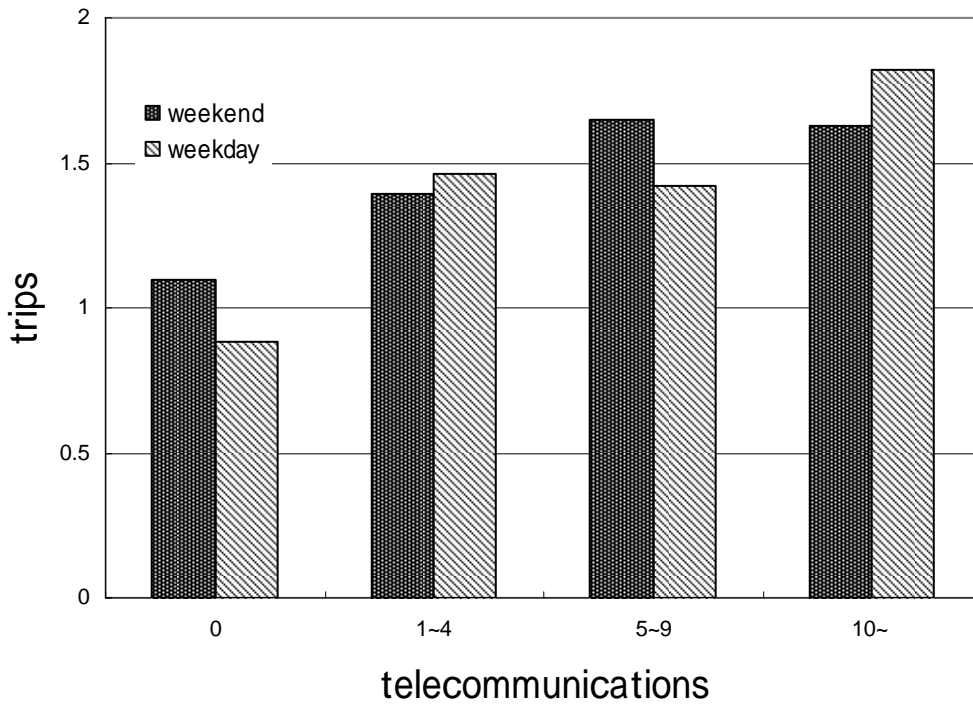

Figure 5-3 The relationship between telecommunication and trips

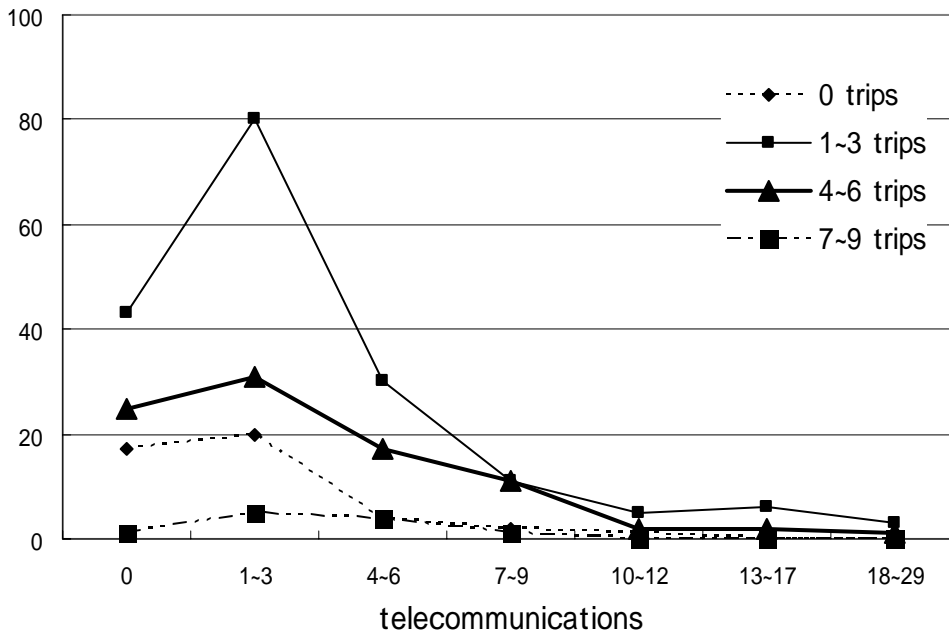

Figure 5-4 The relationship between telecommunication and trip

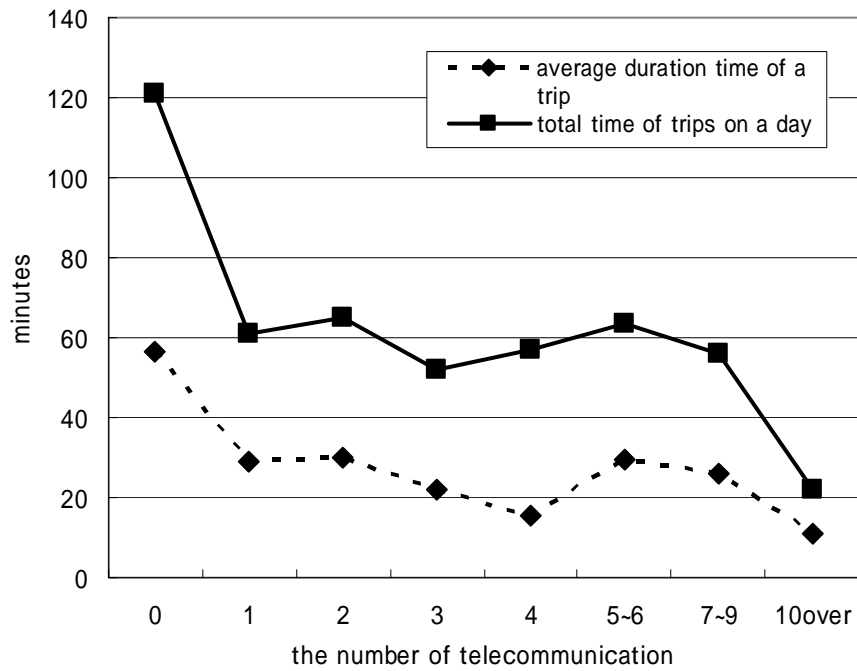

Figure 5-5 Average trip time duration and total time of trip

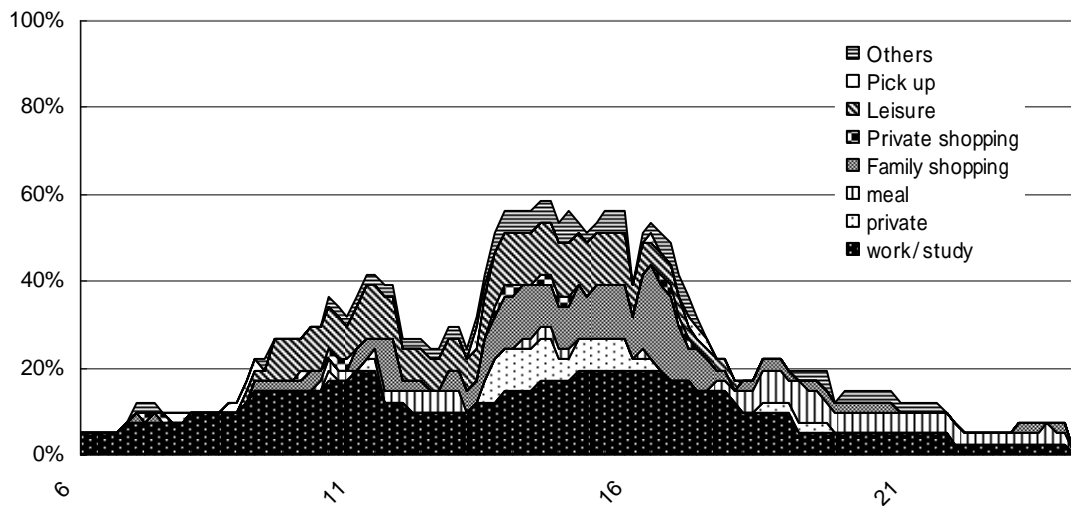

Figure 5-6 the rate of involving in each activity (0 telecommunication segment)

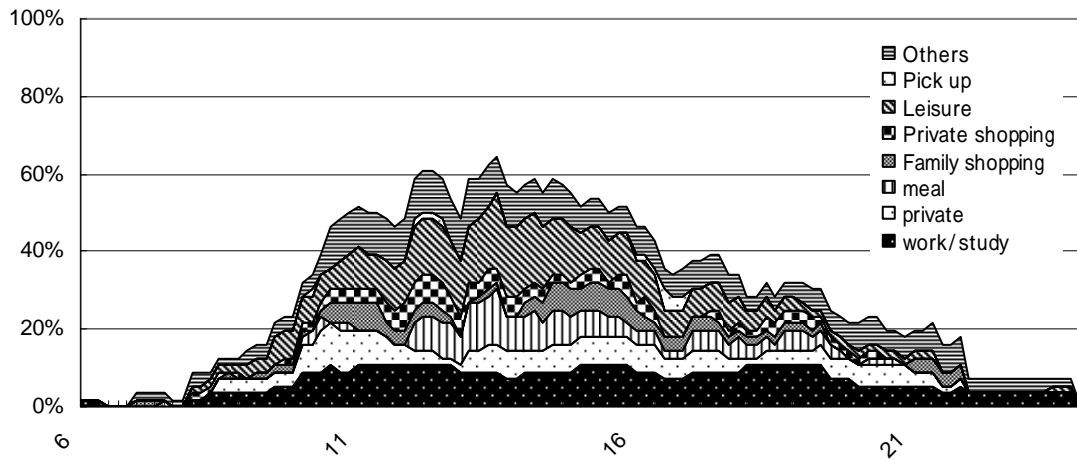

Figure 5-7 the rate of involving in each activity (over 10 telecommunication segment)

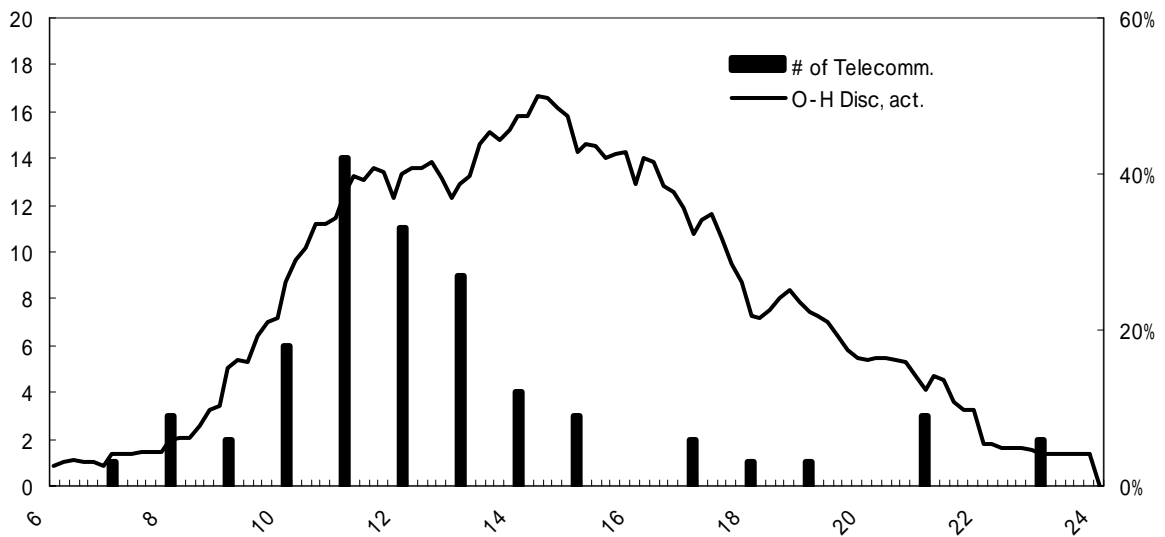

Figure 5-8 timing of telecommunication and out-of-home discretionary activity