

Feijoo, Claudio; Gómez-Barroso, José-Luis; Ramos, Sergio; Coomonte, Rafael

Conference Paper

The mobile communications role in next generation networks: The case of Spain

22nd European Regional Conference of the International Telecommunications Society (ITS): "Innovative ICT Applications - Emerging Regulatory, Economic and Policy Issues", Budapest, Hungary, 18th-21st September, 2011

Provided in Cooperation with:

International Telecommunications Society (ITS)

Suggested Citation: Feijoo, Claudio; Gómez-Barroso, José-Luis; Ramos, Sergio; Coomonte, Rafael (2011) : The mobile communications role in next generation networks: The case of Spain, 22nd European Regional Conference of the International Telecommunications Society (ITS): "Innovative ICT Applications - Emerging Regulatory, Economic and Policy Issues", Budapest, Hungary, 18th-21st September, 2011, International Telecommunications Society (ITS), Calgary

This Version is available at:

<https://hdl.handle.net/10419/52201>

Standard-Nutzungsbedingungen:

Die Dokumente auf EconStor dürfen zu eigenen wissenschaftlichen Zwecken und zum Privatgebrauch gespeichert und kopiert werden.

Sie dürfen die Dokumente nicht für öffentliche oder kommerzielle Zwecke vervielfältigen, öffentlich ausstellen, öffentlich zugänglich machen, vertreiben oder anderweitig nutzen.

Sofern die Verfasser die Dokumente unter Open-Content-Lizenzen (insbesondere CC-Lizenzen) zur Verfügung gestellt haben sollten, gelten abweichend von diesen Nutzungsbedingungen die in der dort genannten Lizenz gewährten Nutzungsrechte.

Terms of use:

Documents in EconStor may be saved and copied for your personal and scholarly purposes.

You are not to copy documents for public or commercial purposes, to exhibit the documents publicly, to make them publicly available on the internet, or to distribute or otherwise use the documents in public.

If the documents have been made available under an Open Content Licence (especially Creative Commons Licences), you may exercise further usage rights as specified in the indicated licence.

**22nd European Regional ITS Conference
Budapest, 18-21 September, 2011**

**Claudio Feijoo¹, José-Luis Gómez-Barroso²,
Sergio Ramos¹, Rafael Coomonte¹**

**THE MOBILE COMMUNICATIONS ROLE IN NEXT
GENERATION NETWORKS: THE CASE OF SPAIN**

Abstract (150-300 words)

Next generation access networks (NGAN) will support a renewed electronic communication market where main opportunities lie in the provision of ubiquitous broadband connectivity, applications and content. From their deployment it is –much– expected a wealth of innovations. Within this framework this paper reviews the technical architecture of a mobile network as a candidate for a NGAN deployment, derives a simple method for approximate cost calculations, and then discusses the results obtained. Data for Spain are used for practical calculations, but the model is applicable with minor modifications to most of the EU countries. The final part of the paper is devoted to reflect on the technical and economic feasibility of mobile communications as part of NGAN, as well as the adequacy and possible developments of the current regulatory framework.

JEL codes

O33 Technological Change: Choices and Consequences

L16 Industrial Structure and Structural Change

L52 Industrial Policy

L96 Telecommunications

Keywords

LTE, 4G, Mobile communications, Next Generation Networks, Spain

Authors' affiliation and corresponding author's e-mail address

¹ Technical University of Madrid, Spain

cfeijoo@cedint.upm.es

² National University for Distance Learning, Spain

1. INTRODUCTION

The rise of what has been called the knowledge economy or new economy has reinforced the role of telecommunications as a strategic investment. The consensus regarding the importance of telecommunications has changed the reasoning at play. It no longer includes the existence of an adequate infrastructure as a factor affecting regional development. Instead, its absence is considered a sign of underdevelopment. Precisely, Next Generation Networks (NGN) will be the supporting infrastructure of ubiquitous broadband telecommunications. The uncertainties on the deployment of NGN have prompted a growing amount of studies, reports and papers from the industry, regulation authorities and academia about the circumstances for their future deployment (Analysis Mason, 2009; CMT, 2009; Claudio Feijóo & Jose Luis Gómez-Barroso, 2010).

The subset of NGN which specifically will support the evolution from today's mobile communications infrastructures is usually called Next Generation Mobile Networks (NGMN). They can be viewed as the next step in the evolution of current industry consolidating the heterogeneity of wireless infrastructures managed by mobile network operators (Ramos, Feijóo, González, Rojo, & Gómez-Barroso, 2004). The first stage in this evolution is already happening with the transition from 3G mobile networks to 3,5G networks. However, from a technological perspective the access part of NGMN begins at 4G-type mobile technologies, a short list that comprises LTE (Long Term Evolution) and Release 2 of (Mobile) WiMAX (Ring, 2008), and complementary convergent technologies like femtocells, short range wireless technologies - NFC, for instance - completing a "network of sensors and tags located on surrounding objects" (Schwarz-da-Silva, 2008).

Within this framework, Next Generation Mobile Networks (NGMN) are regarded as a future platform for ubiquitous broadband, facilitating the smooth migration from existing mobile infrastructures, and allowing for the commercial launch of new mobile services and applications, while at the same time providing a wireless access path to NGN.

The role that mobile solutions can play in the NGAN domain is precisely the research question in this paper. For this purpose an initial analysis of the economic resources required for the adequate deployment of these networks is developed here. Despite the simplifying assumptions of the model presented, this exercise will allow extracting some interesting conclusions on the main advantages and drawbacks of mobile networks and, specifically, shall allow discerning the feasibility and profitability of their deployment. The paper is structured into the following sections. Next section explains, without trying to be exhaustive, the relevant technical aspects of mobile access networks. Section 3 reviews the methodology and assumptions for the NGMN deployment cost model used, particularised for the case of Spain. The following section summarises the cost model, both for capital and operating expenditures. Section 5 displays and discusses the main numerical results obtained. Finally, the last section reflects on the techno-economic implications of NGMN deployment and its impact on the current regulatory framework. The paper includes also two annexes with the data used for the deployment calculations.

2. NEXT GENERATION MOBILE NETWORKS

In general, broadband access technologies are classified by the physical medium in two major groups: wired –or fixed line- technologies and wireless technologies. When classifying wireless technologies two main sets of characteristics are considered: being terrestrial or satellite-based and being fixed wireless or mobile wireless. Due to the requisites of NGAN – very high bandwidth for each user- only the terrestrial solutions will be considered in the following¹. As a summary, Table 1 overviews some of the main milestones and features of the mobile technologies involved in the deployment of NGMN compiled from publicly available industry data and forecasts.

Note that wireless and mobile technologies are seldom considered as suitable competitors of fibre and cable for NGN deployments. However, from authors’ perspective there are a number of reasons that advise for their inclusion. First, some new technologies are approaching the 100 Mb/s threshold, at least with regard to peak data rates. Second, these technologies are also arguably the only viable solution for rural and remote areas with very low population density. Last but not least, the advantages of ubiquitous broadband access for customers are considerable and they could well compensate for lower guaranteed speeds.

From a different perspective, it can also be considered that these technologies are approximately 3 to 5 years behind fixed technologies in terms of data rates per user. However, they are not far from reaching the 10 Mb/s level per user with some consistency. As a result, mobile broadband connections are predicted to overcome fixed wireless sometime in 2011-2013 (Aguado, 2009; Nerandzic, 2008; Ouvrier, 2008), and therefore, mobile broadband connections will be considered a suitable (stand-alone or complementary) alternative to be used as access technologies for NGN.

Obviously, as a necessary condition for the effective evolution of NGMN, access to new spectrum and/or a much more efficient management of it will be required. Without these spectrum improvements it will be impossible to deploy rapidly enough the required technologies that satisfy users’ demands or to compete –and complement- satisfactorily with fixed broadband technologies. In the long run, the massive deployment of femtocells, mobile devices with cognitive radio capabilities and mesh network topologies could make wireless networks almost indistinguishable from most of today’s ultra-broadband fixed solutions.

Table 1: Summary of main milestones in the evolution of mobileNGAN. Source: own compilation from industry data

| | LTE (4G) | Mobile WiMAX (4G) | 4,5 G | Wireless LAN / PAN |
|---------------------------------------|--------------------------|--------------------------|--------|-----------------------|
| Theoretical maximum data rates | 300 Mb/s (downstream) | 100 Mb/s (downstream) | 1 Gb/s | 10 Gb/s |
| | 75 Mb/s | 50 Mb/s (upstream) | | |

¹ For the sake of comparison, according to Eutelsat the next generation of satellites at Ka-band (scheduled to be launched in 2011) will provide 35 times more throughput than traditional Ku-band satellites, will use spot beam technology, and it will be able to provide typically dedicated coverage in 80 set areas delivering shared downstream speeds of 10 Mb/s and 2 Mb/s upstream to users in those areas.

| | (upstream) | | | |
|--|--------------------------|----------------------------------|-----------------------------|-----------------------------|
| Typical data rates practically available per user | - | - | 100 Mb/s | 1 Gb/s |
| Begin of massive deployment in EU | 2011 – 2013 | 2012 -2014 | 2014 - 2017 | 2012 – 2015 |
| Enhanced version – max data rate | LTE Evolution 1 Gb/s | | 5G | - |
| Critical technologies | OFDMA | OFDMA | Dynamic spectrum management | UWB |
| Main advantages | Evolutionary from 3,5 G | Not a legacy technology | Evolutionary from 4G | Wireless smart home |
| Main barrier (May 2010) | Availability of handsets | Business case for new technology | Early stages of development | Early stages of development |

Regarding network architecture (as depicted in Figure 1), the base station is where the spectrum allocated to the mobile operator is used to connect the subscribers to the network. Due to the cellular structure of the network and within the current regulatory framework, not all the spectrum can be used at a single base station and it shall be divided into neighbouring cells to avoid interferences.

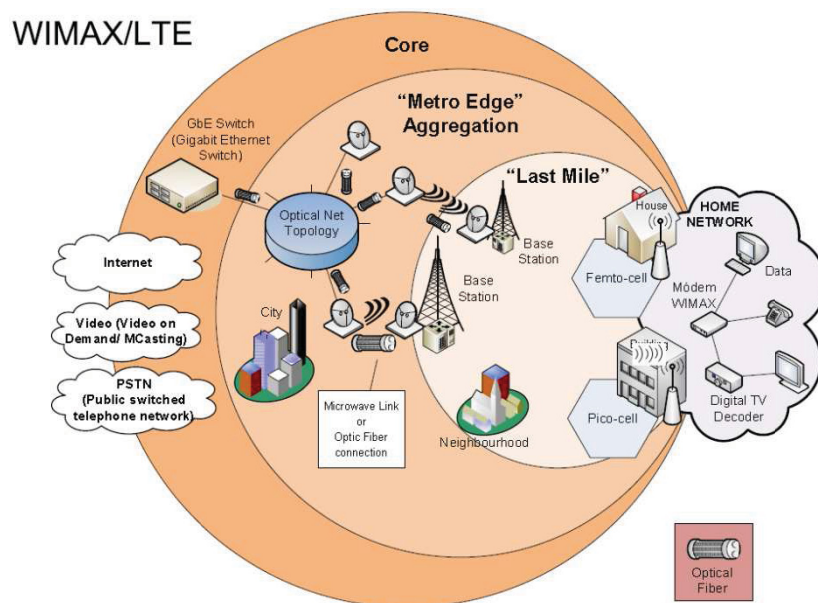

Figure 1: Mobile/Wireless 4G network architecture

To increase coverage in high population density areas or in presence of obstacles –a case most frequent in urban environments- cells are complemented by smaller cells –picocells- serving a reduced number of subscribers. Note that base stations are one of the critical elements for the cost calculations in the deployment of 4G technologies, since these require a much higher density of radio stations than 3G to deliver the promised data rates, a factor that depends on the number of concurrent users sharing this

resource, their proximity to the base station and a number of other events related with existing obstacles and interferences.

The other critical element in new wireless systems is the backhaul. The backhauling part of cellular systems can be either by fibre –typical again in urban environments- or by some radio link at specific frequency bands –a usual scenario for remote / rural areas and/or low amount of traffic coming from the cell. There are two main reasons for the relevance of backhauling costs in NGMN: its capacity needs to be increased as consumers expand their mobile usage and their data rates in cellular systems sparking a tremendous amount of data traffic across the network, and it needs to be extended to reach the denser network of new base stations. Therefore, it comes as a no surprise the recent interest of mobile operators in the topic.

3. METHODOLOGY AND ASSUMPTIONS

The approach in the paper will use data from Spain² as the demographic and geographic framework for what could be considered an average European scenario. The method used for cost calculations departs from a classification of geotypes. This geotypes are based on the population density as the basic parameter affecting the cost of rolling out a NGAN. This is the most used approach to network deployment cost calculations, see for instance Analysis Mason (Analysis Mason, 2008).

For the particular case of Spain, a division into 10 different zones (numbered I to X) has been chosen. See Annex for a detailed description of the main parameters for the geotypes used in the calculations. Apart from the direct relevance of the case of Spain as a main European instance for NGAN deployment, it is interesting to note that data for Spain are relatively similar to the Euroland scenario (Forge, Blackman, & Bohlin, 2005)³. It is also worth to note that previous studies usually considered 3 to 7 zones. For instance, in the Euroland scenario (Forge, et al., 2005) it was assumed that 50% of the population lived in urban areas (6,000 inhab/km² population density), 35% in suburban areas (500 inhab/km² density) and around 15% in rural areas (30 inhab/km² density). Gómez-Barroso and Robles-Rovalo (2008) chose a division into 7 zones for WiMAX calculations in México, including rural areas. This is also the number used in Jeanjean (2010) for NGAN calculations. Analysis Mason (2009), apart from London, also selected 7 zones for its study on fibre deployment in the UK, however leaving aside the rural and remote areas. The motivation for using 10 different zones lies in enjoying more precise estimations in the “grey” areas that the competitive market providers could reach in the medium term as a function of technology, demand and public policies. In fact in the case of Spain about one quarter of the population lives in the 500 – 100 inhabitants/Km² area, where the population density typical of suburban

² See Annex 2 for a detailed description of the main demographic parameters and geotypes used in the calculations.

³ The population in this area adds up to 46.4 million inhabitants, which is the mean of seven European states: France, Germany, Italy, Holland, Spain, Sweden and the United Kingdom. Demographically, Euroland is made up by a few urban areas with a high population density, a greater number of suburban areas, many rural areas and very few remote areas. Last, there are 15.4 million households in Euroland and, of the total inhabitants, 17.3 million are employed in 3.2 million companies.

zones finishes and the rural type-of-density begins. Also in Spain, about 46% of the population lives in urban areas (above 1000 inhabitants/Km²), with an additional 10% in lower-density suburban areas. Remote rural areas (below 50 inhabitants/Km²) made up 12% of the population, but 77% of the territory.

However, the main drawback of a classification based on population density is the lack of information on buildings clustering, mainly for suburban and rural areas. Therefore, to enhance the modelling of the deployment costs, each of the zones has been divided into two types, (a) and (b), resulting in a total of 18 geotypes for the calculations (in zones IX and X the population density is so low that all population is assumed to be distributed according to the b model). Looking from the perspective of network deployment, the key element for this additional categorisation is the location of the local exchange or base station (in the case of mobile networks). For instance, exchanges tend to cover the central core of a settlement and, at the same time, some wider areas where the settlement is sparser (Analysis Mason, 2008), as shown in **Error! No se encuentra el origen de la referencia.**

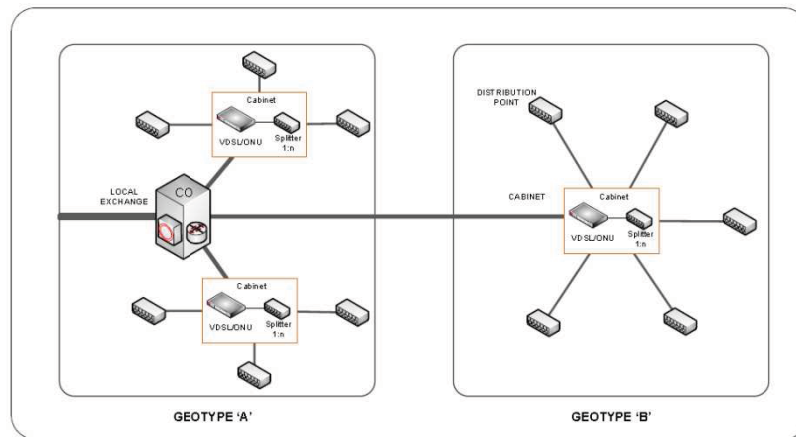

Figure 2: Different geotypes within an access area. Source: Analysis Mason (2008)

The share of potential subscribers (inhabitants, households and businesses) among these two geotypes has been calculated using 5 prototypical municipalities (those closer to the average population and surface) for each of the zones. In each of these municipalities it has been possible to obtain the percentage of surface for dense urban⁴ and scattered urban and suburban areas⁵ using data from Spanish Housing Ministry (2007). The resulting population-weighted average has been regarded as representative of the situation in each of the zones. At this point it is important to notice that this approach is valid for a gross estimation of the deployment costs of a NGMN. However, in a practical deployment case the optimal topology should be calculated by some –typically heuristic- procedure⁶ that takes into account exact data on base stations, location of existing ducts for potential re-use and customer location for each town and municipality.

⁴ When more than 80% of the surface is covered with buildings and roads.

⁵ When the surface is covered with buildings and roads associated with areas of vegetation or land occupying between 30-80% of the total surface.

⁶ For instance, the Steiner tree problem tries to solve the problem of connecting N points to each other with a minimal cost tree structure, see Casier et al (2008).

The methodology for the calculation of the deployment costs for mobile NGAN technologies also uses a number of additional assumptions. First, the backbone network will not be included in the calculations⁷. Secondly, legacy networks will be considered where possible to re-use part of the infrastructure previously built by the same or other operators. Data on lengths, types of terrain and re-use of existing infrastructures will be based on own estimations. The model has chosen all of these parameters for a situation reasonably as close to reality as possible, see Annex for details.

Also the potential sharing of infrastructures between competitive providers has not been considered. On the one side, the presence of several operators leads to a potential lower utilization of assets per customer, as the customer base is shared among players, and therefore, increases the costs with regard to a monopolistic situation. On the other side, several operators, depending on their commercial agreements or due to the imposed regulations, can share different combinations of the infrastructures, decreasing the incurred costs per customer. Some implications of sharing infrastructures among operators are briefly considered in the results section.

Next, the model presented in this paper intends to be as agnostic as possible with regard to demand⁸. However it is required to include some assumptions about it since some of the costs calculations are dependent on the actual number of customers in the network. To simplify the calculations take-up is assumed to represent net additions to the network (therefore including the effect of churn) and it is also assumed that it will happen at 10% constant rate with regard to the total of potential subscribers. This means that if, for instance, the network is deployed in 4 years the level of 80% of the total potential subscribers would be reached in 9.5 years. Once the maximum level of subscribers is attained it will remain indefinitely at that number. Obviously, this is an optimistic scenario for each technology in terms of adoption, but from the perspective of costs is a worst-case scenario. The churn rate will be 20% of existing customer base or, equivalently, on average each customer changes operator every five years, a figure similar to the existing churn in mobile networks.

Finally, to calculate the present value of investments, a weighted average cost of capital (WACC) of 12% is considered in accordance to previous studies⁹ and financial conditions for European broadband operators (Analysis Mason, 2009). The rate of average yearly inflation is estimated at 2%, the objective of the European Central Bank. Operating expenses are calculated just for the 10 first years of operation.

⁷ For the interested reader the paper from De Antonio et al (2006) offers some estimation on the capex and opex for building such a backbone network from the scratch, using both a top-down analysis and a bottom-up approximation. For example, considering a case similar to Spain, the backbone network included 8 core routers, 77 service edge routers and 23,000 aggregation devices for the access traffic and the appropriate length of fibre. It was calculated that the investment needed (including the backbone, aggregation and edge sections) amounted to 8.300 M€. (De-Antonio, Feijóo, Gómez-Barroso, Rojo, & Marín, 2006)

⁸ Other potential choice would be to decide that the network is absolutely universal and minimum demand assumptions are made, an approach used for instance in De Antonio et al (De-Antonio, et al., 2006). However, this is thought as too unrealistic, leading to increased cost estimations.

⁹ This value has been calculated adding the interest rates (around 2 to 3%) to a 7-9% representing investment-related financial and market risks.

4. DEPLOYMENT MODEL

As regards the deployment model, it is considered that the network will reach 100% both of individual and business users¹⁰ in 10 years. From here it should be noted that potential users are not the same for fixed and mobile technologies. The total number of potential users of fixed networks is 17.9 million. However, only up to 80% of them will subscribe to a given network, i.e., they will be customers of a particular broadband service offering. The total number of potential users of mobile networks is 53.3 million, representing a 114% mobile penetration, similar to the latest data available for Spain (EC, 2009)¹¹. Again, only up to 80% of them will belong to a given network at a certain time and in a certain area.

Figure 3 displays the detailed model used in the calculations of the CAPEX and OPEX of a NGMN. The wireless access network is broken down into three separate sections. A node (mobile switching centre, MSC), where the traffic coming from base stations is gathered, is included in the access part. Note that the MSC does not have to stand in the same place of a wired local exchange, although this could allow for a certain re-use of ducts and facilities, but in any case it requires the same type of optical and switching equipment.

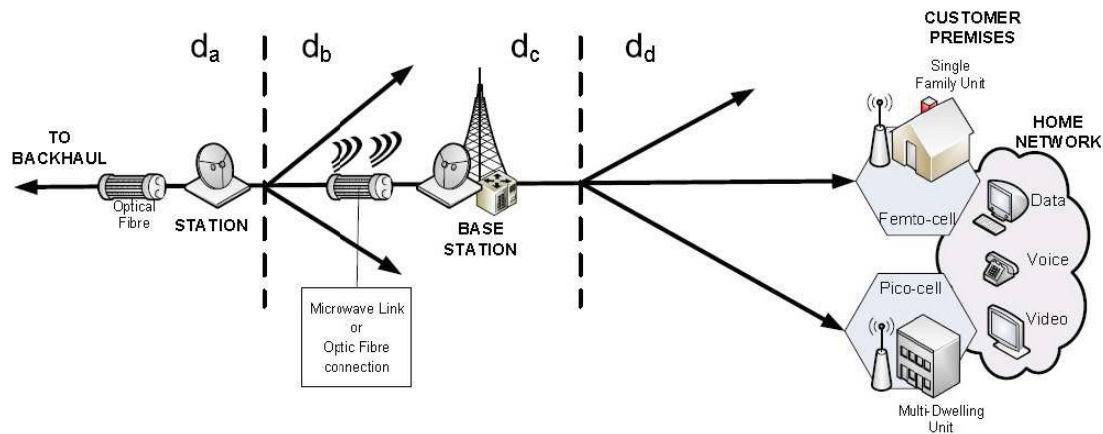

Figure 3: Sections of wireless access networks for cost calculations

There are up to eight “a” segments per node in the access area for the best coverage from the MSC, and one “b” and “c” segments per base station. The “a” and “b” segments consist in general of an optic fibre cable, but in the low density areas a microwave link can be sufficient to interconnect the base station with the node at the edge of the transport network. The base station reaches customer premises with sectorised coverage using antennas with directional capabilities. However, in some multi-dwelling units it could be needed to install a picocell to improve coverage.

¹⁰ For comparison, in the Analysis Mason report for Ofcom the fibre network only reaches 66% of potential users (2009)

¹¹ While writing the paper, mobile penetration has changed slightly in Spain and the latest data show a 117,2% mobile penetration at the end of 2010 (CMT, 2011).

For the calculation of the deployment costs it should be acknowledged that wireless networks confront two main limits for the radius of the cell served by a base station: the guaranteed data rate per user (quality) and the transmission losses. The former is the usual limiting factor in urban and suburban areas while the latter limitation happens mostly in low density rural areas. Therefore, to arrive at a practical figure of cell users per zone, some additional assumptions are needed as explained in the following.

The objective of quality consists of 5Mb/s guaranteed per user, a figure lower than in wired cases but considerably ambitious for the mobile environment. It is also supposed that each base station is able to manage up to three sectors of 20 MHz of bandwidth each, a typical figure for the 2.6 GHz frequency band. In addition (and this is probably the most hypothetical assumption), the operator has been allocated enough spectrum (40 MHz and above) to be able to deploy such a network. Finally, the spectrum efficiency is established at 15 b/s/Hz, in the technological limit as of 2010 (Etemad, 2008).

With these assumptions, each cell would be able to manage up to 1800 Mb/s of traffic, or equivalently 360 subscribers at full 5 Mb/s speed simultaneously. As this figure is lower than the average municipality mobile subscribers in any zone (except for zones IX and X where the averages are 223 and 106 subscribers), it will be the quality the limiting factor. Table 6 summarizes the main figures resulting from this distribution of users per access area for this type of wired networks. Note also that this deployment is only valid for coverage of users at the premises location, and not necessarily for mobility situations (roads, spaces out of urban developments, etc).

For NGMN, moving from the node to the customer premises, the total deployment cost per access area (CA_{dp}^i) is given by:

$$\begin{aligned}
CA_{dp}^i = & c_{ODF} + c_{cab-e} + (c_{OLT} + c_{switch})Int \left[\frac{n_{area}^i}{640} + 1 \right] \\
& + d_{total}^i (c_{inst} + c_{fibre} + c_{sduct} fr_{sduct}) + d_a^i c_{duct-ad}^i (1 - fr_{ab}^i) n_{divAB}^i \\
& + c_{div}^i n_{divAB}^i + d_b^i c_{duct-ad}^i (1 - fr_{ab}^i) n_{bs}^i + (c_{bs-d} + 2c_{bs} + 12c_{tr} \\
& + 2c_{pow}) n_{bs}^i + \frac{c_{spect} bw}{n_{area-total}}
\end{aligned}$$

Now, the total length (d_{total}) refers just to the total fibre length used from the equivalent access area to base stations and it is given by:

$$d_{total}^i = d_a^i n_{divAB}^i + d_b^i n_{bs}^i$$

The present value of the total deployment cost per access area ($NPVCA_{dp}$) requires the choice of the number of years for the network roll-out. The costs are considered to be spread evenly as to reach all the potential users in the access area in the number of years specified. The costs incurred each year are discounted at the WACC ratio:

$$NPVCA_{dp}^i = CA_{dp-year 1}^i + \sum_{n=2}^{ny} \frac{CA_{dp-year n}^i}{(1 + WACC)^{n-1}}$$

The present value of the total deployment cost per zone (NPVCZ_{dp}) is, therefore:

$$NPVCZ_{dp}^i = NPVCA_{dp}^i \frac{n_{user}^i}{n_{area}^i}$$

where n_{area} is the number of potential users in each zone as given in Table 6. Finally the present value of the total deployment cost per zone and per user (npvcz_{dp}) is:

$$npvcz_{dp}^i = \frac{NPVCA_{dp}^i}{n_{area}^i}$$

The approach considered for OPEX calculations in wireless networks is the following

WIRELESS NETWORK OPEX

$$= \text{Equipments and network structure maintenance} \\ + \text{Other Costs involved (Marketing, Billing, ...)}$$

The first part of this equation combines the costs assigned to the active parts of the network (fibres, nodes, base stations...), and the network operation costs of the physical network. Those costs can be described as the fixed cost due to the network operation and can be divided into various groups as: civil works, passive equipment maintenance and active equipment maintenance. In addition to the network operation cost, additional costs for marketing, customer service, billing, or administrative sanctions, among others, must be considered (included as general management costs).

For the sake of comparison with wired deployments, two other different network models (FTTH and FTTx-VDSL) are also considered. Figure 4 displays the models used in the calculations of these networks.

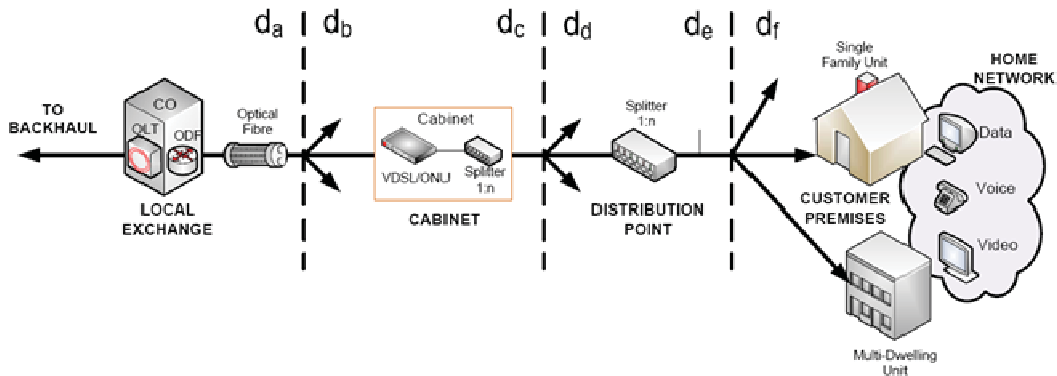

Figure 4: Sections of wired access networks for cost calculations

The detailed information about ratios and distributions of the distances, as well as the cost of every item involved in the deployment, operation maintenance and management of the networks considered are presented also in the Annex and the calculations involved can be found at Feijóo & Gómez-Barroso (2010). In any case, the limiting factor for quality in a FTTH-GPON and in a FTTC/VDSL2 deployment is the shared OLT card managing one fibre at the local exchange. For the calculations it has been supposed that each OLT card can manage 2,5 Gb/s per 64 users maximum. It has been also assumed that in FTTC/VDSL 20% of the users (those very close to it) can be served directly from the local exchange using existing copper wire and without installing any fibre.

5. RESULTS AND DISCUSSION

Following the approach outlined in previous sections, the first graph, see Figure 5, shows the total investment (capex and opex) required per user in each of Spain's geotypes, over a ten year period at net present value. It also shows what proportion of the total expenditure is required in each of the geotypes, over the same ten year period at net present value.

The total expenditure per user remains relatively flat for zones I to VIII but then increases 8,2% and 20% for the most sparsely populated geotypes, IX and X respectively. Interestingly, the proportion of the total investment peaks (22,5%) at geotype VI, that is, the area with population from 500 to 100 inh/km², because of the combination of scattered population and the high proportion of the total population in this area. Geotypes II and IV also required a significant proportion of the total investments (14,4% and 18,6%, respectively) because of their high share of the total population. Note that the calculations assume coverage for the location of premises, that is, coverage of the population, not for the coverage of the total surface of each geotype. This is the reason why the proportion of the total expenditure is so low in geotypes IX and X in spite of their higher cost per user. In conclusion, the graph shows a pattern of investment relatively close to the distribution of the proportion of the total population among the different geotypes.

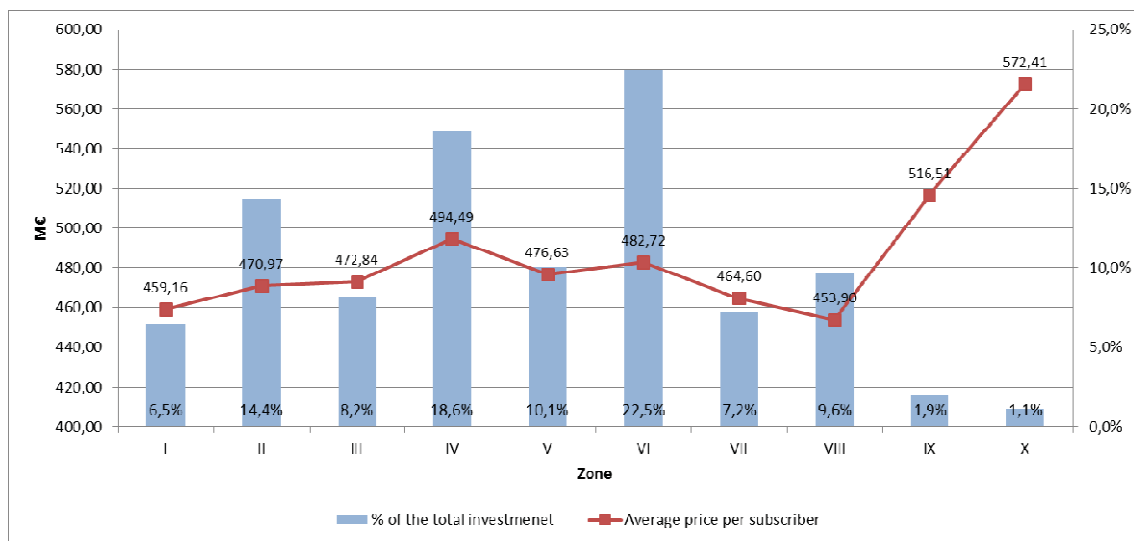

Figure 5 – Percentage of the total investment and price per user per zones.

Figure 6 displays the comparison in total investment (capex and opex) in the case of Spain between LTE and two main technologies for wired NGAN: FTTH-GPON and FTTC-VDSL. The figure shows the total investment required to complete the network (100% coverage of premises) over a ten year period at net present value. As can be easily noticed, an 4G-LTE deployment is considerably cheaper (20% less) than a FTTH deployment. On the contrary, the FTTC-VDSL deployment is less costly than a LTE deployment (27% less). The reason lies, evidently, in the re-use of existing infrastructure in the case of VDSL. Note that for LTE the deployment model includes the part of fibre that would run from a node of the transport network to each of the base stations. The re-use of existing ducts and dark fibre is much less in this case. The figure also presents the percentage of capex and opex to total expenditure. The proportion is similar – opex about one third of total expenditure- in the case of new infrastructures such as LTE and FTTH. However, in the case of FTTC-VDSL capex and opex have almost the same proportion of expenditures with regard to the total. This is again due to the re-use of existing infrastructure.

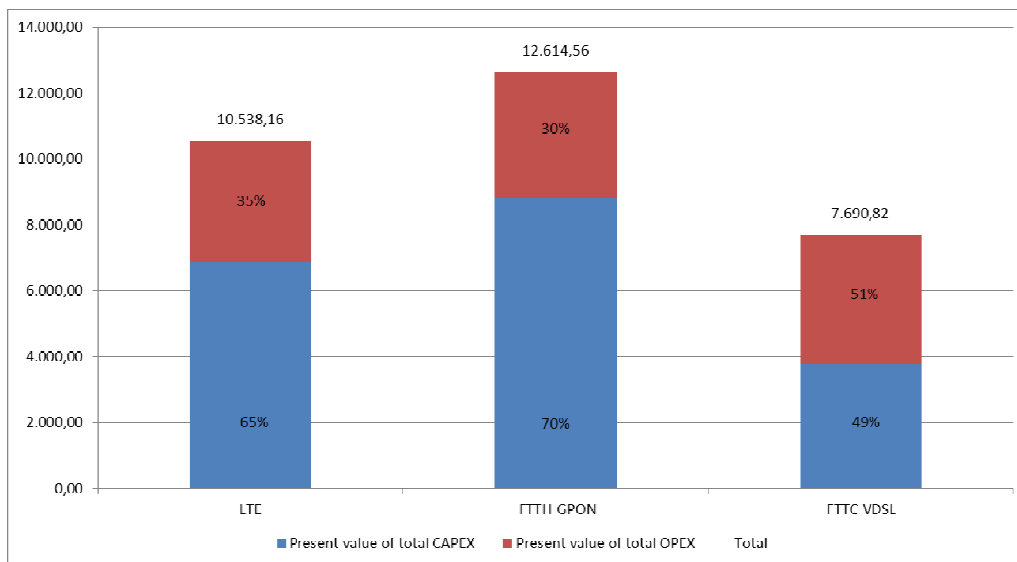

Figure 6 - Percentage of CAPEX and OPEX in the total cost of different technologies NGAN deployments.

The relationship between population density and deployment cost deserves to be further explored as operators invest in areas that are profitable. As dense areas require less investment per user, dense areas will be served first. If we consider geographic density as a continuum, there is a point where operators stop investing because it is no longer profitable. In fact, in most rural areas low population density and high deployment costs discourage private investments, creating a negative feedback of limited capacity, high prices, and low service demand. As the profitability of any area depends basically on infrastructure costs, which tend to decrease slowly over time, there are some possibilities of less dense areas to become profitable as time passes by (Jeanjean, 2010), all other parameters equal. However, this effect could be too slow and meanwhile it would impact significantly on equity in territorial terms for a potential long period of time. In fact, currently there is little or no commitment to connect areas that include smaller

towns and rural villages (Pereira, 2007). Data collected by OECD have shown that, among the developed countries, those with a large urban population such as South Korea, Japan, France and the Netherlands are more likely to achieve a higher rate of broadband penetration than those with significant rural communities such as the United States and Canada (Sherif & Maeda, 2010).

Precisely, Figure 7 presents the total investment required per user to deploy two types of NGAN: FTTH-GPON and LTE at 2,6 GHz. This is the expenditure needed to complete the network (100% coverage of premises) over a ten year period at net present value. The figure is provided to supply an easy comparison as a minimum floor with annual ARPU levels. From the numbers presented, it can be seen that, rather obviously, the costs increase with lower densities of population, although the costs for the deployment of a NGMN remain relatively flat in comparison with the costs of FTTH. From geotype IV (population density below 3.000 inh/km²) the costs are significantly higher in FTTH, but it is from population densities lower than 50 inh/km² (geotype VII) where the deployment costs more than double from FTTH to LTE. Therefore, wireless technologies are more cost-efficient in these lower density areas. On the contrary, it is in the higher density areas where FTTC-VDSL and DOCSIS (not shown in the graph), or even FTTH, are the less expensive as they re-use the existing infrastructures. Note that, as in previous graphs, the calculations assume complete coverage for the location of premises, that is, coverage of the population, not the coverage of the total surface of each geotype. Note also that the calculations have not taken into account, beyond the actual distribution of population, possible effects from the exact geography (mountains, valleys, etc) of these low density areas, see for instance Salman & Ibrahim (2010) for additional details.

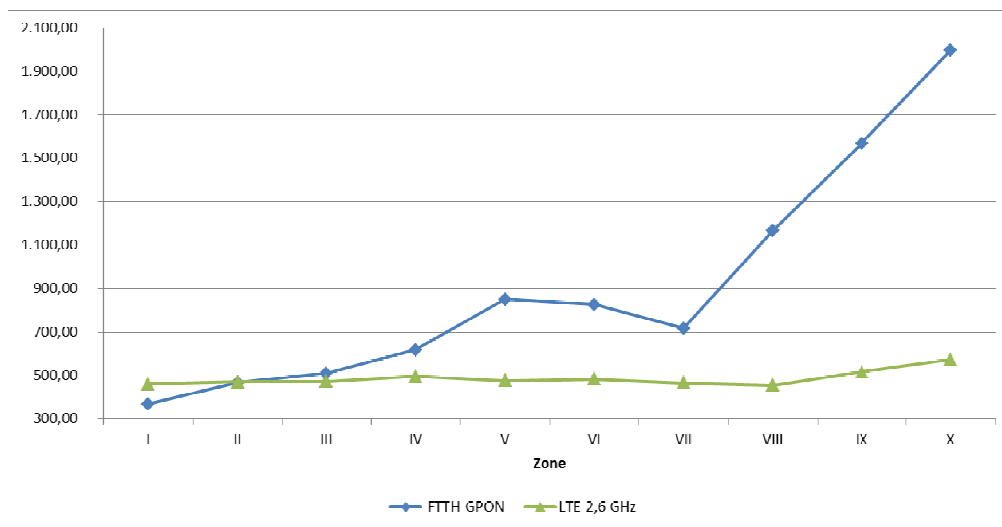

Figure 7 – Average price per subscriber for the different density zones for LTE (green) and FTTH-GPON (blue) access areas.

Another very relevant aspect of comparison among NGMN and other wired NGAN technologies refers to the cost of guaranteed data rate per user. Usually, when comparing these technologies, this very fundamental perspective is not clearly considered, if at all. Table 2 shows the cost of 10 Mb/s of guaranteed data rate per user for different NGAN technologies and by geotype. Note that for these

calculations, the size of the access area in the case of wireless technologies has had to be reduced, therefore increasing the costs of deployment with regard to above results. Also cable infrastructures have assumed to be already deployed and, therefore, only the upgrade to DOCSIS 3.0 would be needed. As a consequence, from this other perspective the situation is reversed and LTE is by far the most expensive solution.

Table 2 – Cost of 10 Mb/s guaranteed data rate per user (€) by geotype (50% penetration)

| Geotype | NGAN Technology | | | |
|-----------------------------------|------------------------------|------------------------------|-----------------------------------|-----------------------------|
| | <i>FTTH GPON^a</i> | <i>FTTC VDSL^b</i> | <i>HFC DOCSIS 3.0^c</i> | <i>LTE (4G)^d</i> |
| VI (500-100 inh/km ²) | 1,149 | 632 | 251 | 6,075 |
| VII (100-50 inh/km ²) | 259 | 161 | 84 | 1,901 |
| VIII (50-10 inh/km ²) | 678 | 220 | 114 | 2,508 |
| IX (10-5 inh/km ²) | 182 | 123 | 20 | 550 |
| X (<5 inh/km ²) | 131 | 32 | 11 | 328 |

a. 40 Mbps b. 30 Mbps c. 30 Mbps d. 10 Mbps

Departing from the base calculations presented in the previous graphs and tables, Table 3 introduces a sensitivity analysis with the effects on the costs of several other situations.

Table 3 - Sensitivity analysis

| <i>Effect</i> | <i>LTE-2,6 GHz</i> |
|---|--------------------|
| Baseline (M€) | 10.538,16 |
| Deployment in 5 years instead of 10 years | 34% |
| Maximum coverage of 80% instead of 100% of premises | -19% |
| Maximum coverage of 60% instead of 100% of premises | -40% |
| Increase in 10 Mb/s per user of guaranteed speed | 69% |
| Increase of the WACC from 12 to 15% | -8% |
| Decrease in 30% of civil work costs | -14% |
| Sharing passive infrastructures between 2 operators | -5% |
| Increase of 40 MHz in the allocated spectrum to mobile operators | -10% |

In accordance with the previous table the most dramatic change is related with the increase in guaranteed speed per user (69%). For instance an increase of 10 Mb/s for FTTH would translate only in an increase of 1% of the total cost, and in a 12% if this was done in an FTTx-VDSL roll-out. It is also worth to note the very relevant decrease if only the first 60% (that is, those living in denser areas) of the population needs to be served. The number of years of the deployment also influence significantly on the costs, signalling the potential effects derived from conditions on 4G licenses. Sharing passive infrastructures with other operators and decrease of civil works costs (fibre to the base stations, mainly) also diminish total costs. And, finally, enjoying more spectrum per operator also decreases costs. These

last three results all together are paving the way for the sharing of network infrastructure in the core and radio access networks among multiple operators (Frisanco, Tafertshofer, Lurin, & Ang, 2008).

6. CONCLUSIONS

Undoubtedly, the deployment of NGAN is the technical and business element around which the future evolution of the information and technology sector revolves. However, numerous uncertainties remain regarding their development. Some operators have started to invest but maintain their doubts over whether the applications and services offered over a NGAN shall be sufficient to provide a return to investment in rural areas and, at present, they are not sure which killer application, if any, will develop to provide sufficiently a new revenue stream for ultra-broadband networks. At the same time, next generation of mobile networks are already under way and they seem as an incremental logical step ahead for the mobile industries. In this scenario the issue at stake is whether this 4G of mobile communications impacts or belongs to NGAN. The analysis that has been presented here, although quite simple and rough, allows extracting a few important consequences to this regard.

First, and the datum is not less important despite being expected, it is clear that –any- NGAN requires major investments. Also, and as a consequence, the recovery of these investments implies that the prices charged for access and usage of the services will not differ much of current prices. Every study agrees on this point (Analysis Mason, 2008, 2009; De-Antonio, et al., 2006; Jeanjean, 2010).

Secondly, should the demand for large bandwidths appear, the case could be that no access technology by itself, at least with the technical and economic conditions expected as of today, could present the optimal characteristics for satisfying all the requirements demanded by the users in every circumstance. This has been shown in the model presented where the cheapest technologies per user are those offering the lowest speeds and the contrary being also true. However, the prices per 10 Mb/s show a different picture. Here, those technologies, such as FTTH, able to supply higher speeds appear as more competitive. They are also the technologies more easily scalable if the target is to increase significantly the speed over the existing infrastructure in some future. Wireless technologies lie in some middle ground: low speeds and intermediate costs. Therefore, the case of different advantages and drawbacks for each technology, backed by the need to achieve a return on the investments, is leading operators to create platforms capable of integrating different access technologies over the same backbone network. The future market of the information and communications sector, characterised by “comprehensive” operators, would be, in this case, quite different from the current one, where there is a clear separation between technologies. Thus, any –policy, regulatory- measure to facilitate the “mix” of technologies without compromising competition would help to produce the case for the deployment of NGAN. However, the departure point for the different types of operators (historic, cable, wireless, alternative and even new agents) is not the same. These initial differences are conditioning, and shall do so in the future, the path followed for the transformation of their networks into NGAN. The cost calculations carried out support this first impression. As a consequence, each operator will have a different set of drivers for

migrating to NGAN (Sadiku & Nguyen, 2002). These drivers will dictate their base timeframes for investing in this advanced infrastructure, and subsequently migrating services from existing networks.

Also, comparing different types of NGAN from the supply side is a difficult exercise with significant risks. In fact, a careful look into NGAN reveals that there are no easy conclusions. And not each NGAN addresses the same type –and amount- of users. Wired networks are typically for premises and wireless networks for persons. Therefore wireless systems can serve about three times the subscribers of a fixed network (and enjoy up to triple revenues). At the same time boundaries blur: picocells and femtocells create a convergence where both fibre and radio are needed and no longer is the distinction between technologies valid.

Sharing infrastructures has already been considered in the regulation, see Ruhle & Lundborg (2010) and it is an area where operators are showing renewed interest. According to the model developed, sharing infrastructures can decrease costs significantly. This is not only important for wired solutions, but for wireless players, where they can achieve higher savings if they go beyond the mere civil works to share some types of active equipment –up to 30% according to Norman (2010)- or even spectrum. Apart from reducing costs, infrastructure sharing can accelerate roll-out, stimulate competition, decrease the troubles of deployment for the public and have environmental benefits (sharing power supplies for instance). There are also some evident risks of collusion.

Looking specifically into wireless access technologies, it has not been properly understood their role as a fundamental part of NGAN. In fact, their use for access from mobile operators it is just a different way to address the same broadband target, but, adding along the road, the mobile advantages: a maybe much more reasonable approach in terms of financing and technology evolution, avoiding the disruptive leaps required in fixed infrastructures. In addition, wireless NGAN are the only scalable solution in terms of infrastructures for areas of low density of population. They are also a complement to NGAN competition in almost any area.

At the same time, it is true that radio-based systems are able to provide today about one tenth of sustained speed compared to wireline solutions and that this difference has been kept constant for the last years. But it is also true that the developments required to improve the capabilities of radio-based systems are at –close- sight: opening of additional spectrum, more efficient spectrum management practices, much smarter radios to access appropriate frequencies at each moment and process signals more efficiently. Therefore, although there is “a limit to the ability of wireless technology to be full players in high-speed Telecom 3.0” (Noam, 2010) and the investments are considerable, there is still room enough for wireless to play a role in medium-speed uses or even higher at low density of population rural areas. As the model shows, 5 Mb/s of mobile sustained speed, with much higher peaks depending on the number of concurrent users, and at a cost below that of FTTH could have a significant impact of the NGAN market. This result is coincident with some recent studies. For instance, according to Analysis Mason, terrestrial wireless technology could be used to provide broadband connections to the final 15% of UK homes not covered by fiber connections. They also acknowledge that the wireless element would be sufficient for households of average usage, after modeling low, medium and high-use scenarios, but only if the number

of base stations and spectrum available was increased (Analysis Mason, 2010). Therefore, the usage of spectrum for wireless solutions appears as a main element in configuring the NGAN landscape.

To this regard, two are the main relevant parameters for allocation of spectrum to wireless operators: the amount of spectrum (bandwidth) and the band of operation.

The amount of spectrum required per mobile operator depends fundamentally on the level of quality of service, including the number of users concurrently accessing mobile data –density of users-, type of usage –more than 90% of traffic non-voice in 2013 (Aguado, 2009), evolution of user perceptions about service quality, and the size of the cell relative to the population density. But also depends on the ability of the mobile transmission technology to manage and re-use frequencies and on the topology and type of the network. In the calculations for the model it was allocated at least 40 MHz of spectrum (already a considerable quantity) to achieve a relatively modest 5Mb/s data rate. It is obvious that, maintaining the level of investment, more bandwidth would be required to offer higher speeds to users. Therefore, a significant new quantity of spectrum should be freed up and allocated to operators so as to turn wireless solutions in an actual opportunity. This road is precisely being taken by a number of countries. For instance, the FCC has the ambitious goal to make 500 MHz of spectrum available for mobile broadband over the next 10 years, 300 MHz of them in the next five years. In the case of the EU, the need for spectrum has prompted to adopt a decision aimed at harmonising the allocation of the 790-862 MHz band spectrum, the well known digital dividend. In addition, the amount of frequency spectrum allocated to an operator has also a direct impact on costs, as it allows delivering more speed per user without decreasing the size of the cell.

The choice of the frequency band for the allocation has a significant impact on costs. For instance, the EU claims that infrastructure equipment for the 800MHz band was expected to be 70 % cheaper than that required for the radio frequencies in use on 3G networks. It has also advantages in terms of propagation, since it should provide operators with improved coverage and in-building penetration in comparison with most current 3G bands. Due to this propagation effects in theory it would look like the lower frequencies of operation saving a significant amount of base stations. But this is only partially true. The limiting factor in a wireless NGAN of the type described in this report is the quality of the service per user, and not the maximum coverage of the cell as a function of the frequency of operation. However, using lower frequencies allows an initial deployment with much less base stations that later could be completed at the same or other frequencies, and it still valid as the best solution for low density areas.

Finally, the above considerations translate in a baseline for market behaviour. In 2015 it would be relatively possible for Spain to enjoy a “2+” infrastructures-based competition (incumbent, cable operator and mobile operators) for NGAN at about 50% of premises (i.e., 9 million of households and businesses). Beyond this point the required investments would be much higher. The cheapest choice would be for a “1+” infrastructures-based competition (incumbent using VDSL-type technology and mobile operators) in an additional 10% of the population,. For the rest of the population, the most probable option would be no access to NGAN except maybe some scattered local initiatives and some mobile 4G deployments in some particular areas, very dependent on the conditions on new spectrum licences.

7. REFERENCES

- Aguado, A. (2009). Innovación tecnológica y espectro. *Regulatory and economic policy in telecommunications*, 2(March 2009), 41-48.
- Analysis Mason. (2008). The costs of deploying fibre-based next-generation broadband infrastructure. London: Final report for the Broadband Stakeholder Group.
- Analysis Mason. (2009). Competitive models in GPON. London: Ofcom.
- Analysis Mason. (2010). The costs and capabilities of wireless and satellite technologies - A 2016 snapshot. London: Broadband Stakeholder Group.
- Casier, K., Verbrugge, S., Meersman, R., Colle, D., Pickavet, M., & Demeester, P. (2008). *A clear and balanced view on FTTH deployment costs*. Paper presented at the FITCE Congress 2008, London.
- CMT. (2009). Informe final sobre los resultados del modelo de despliegue de redes FTTH/GPON en España. Barcelona: Comisión del Mercado de las Telecomunicaciones.
- CMT. (2011). Nota mensual Mayo 2011. Barcelona: Comisión Nacional del Mercado de las Telecomunicaciones.
- De-Antonio, J., Feijóo, C., Gómez-Barroso, J., Rojo, D., & Marín, A. (2006). A European perspective on the deployment of next generation networks. *The Journal of the Communications Network*, Vol 5, part 2(April – June), 47-55.
- EC. (2009). *Progress report on the single European electronic communications market 2008 (14th report)*. (COM(2009) 140 final). Brussels: Retrieved from http://ec.europa.eu/information_society/policy/ecomm/doc/implementation_enforcement/annualreports/14threport/commen.pdf.
- Etemad, K. (2008). Overview of mobile WiMAX technology and evolution. *IEEE Communications Magazine*, 46(10 October 2008), 31-40.
- Feijóo, C., & Gómez-Barroso, J. L. (2010). A prospective analysis of the deployment of next generation access networks: looking for the limits of market action. The case of Spain. Madrid, Spain: NEREC.
- Feijóo, C., & Gómez-Barroso, J. L. (2010). *A prospective analysis of the deployment of next generation access networks: looking for the limits of market action. The case of Spain*. NEREC Workshop. Madrid.
- Forge, S., Blackman, C., & Bohlin, E. (2005). The demand for future mobile communications markets and services in Europe *Technical Report Series*: Institute for Prospective Technological Studies - JRC - EC.
- Frisanco, T., Tafertshofer, P., Lurin, P., & Ang, R. (2008, 7-11 April 2008). *Infrastructure sharing and shared operations for mobile network operators From a deployment and operations view*. Paper presented at the Network Operations and Management Symposium, 2008. NOMS 2008. IEEE.
- Gomez-Barroso, J., Robles-Rovalo, A. . (2008). Wireless hopes for universal service in developing countries: an assessment of the Mexican context. *info*, 10(5-6), 83-91.
- INE. (2004). Censo nacional de población y viviendas 2001. from Instituto Nacional de Estadística <http://www.ine.es/jaxi/menu.do?type=pcaxis&path=%2Ft20%2Fe242&file=inebase&L=>
- INE. (2009). Directorio central de empresas 2009. from Instituto Nacional de Estadística <http://www.ine.es/jaxi/menu.do?type=pcaxis&path=%2Ft37%2Fp201&file=inebase&L=0>
- Jeanjean, F. (2010). *Financing the next generation infrastructures. Consumer subsidies or infrastructure subsidies?* Paper presented at the EuroCPR 2010, Brussels.
- Ministerio de Vivienda. (2007). Atlas estadístico de las áreas urbanas 2006. from Dirección General de Suelo y Políticas Urbanas, Secretaría de Vivienda, Ministerio de Vivienda de España http://siu.vivienda.es/portal/index.php?view=article&catid=19%3Aatlas-digital-de-las-reas-urbanas&id=57%3Aatlas-estadistico-de-las-areas-urbanas-2006&option=com_content&Itemid=73&lang=es
- Nerandzic, D. (2008). *Emerging technologies and their implications on regulatory policy*. Paper presented at the 17th Biennial Conference of the International Telecommunications Society "The changing role of the telecommunications industry and the new role for regulation", Montreal, Canada. <http://www.canavents.com/its2008/plenary1/2.pdf>
- Noam, E. (2010). Regulation 3.0 for telecom 3.0. *Telecommunications Policy*, 34(1-2), 4-10.
- Norman, T. (2010). Wireless infrastructure sharing saves operators 30% in capex and 15% in opex. Retrieved from <http://www.analysismason.com/About-Us/News/Insight/Wireless-infrastructure-sharing-saves-operators-capex-and-opex/?journey=117,55>

- Ouvrier, S. (2008). *Driving key technologies for next generation mobile networks*. Paper presented at the ICT Mobile Summit 2008, Stockholm, Sweden.
- Pereira, J. P. R. (2007). *A cost model for broadband access networks: FTTx versus WiMAX* Paper presented at the Access Networks & Workshops, 2007. AccessNets '07. Second International Conference on
- Ramos, S., Feijóo, C., González, A., Rojo, D., & Gómez-Barroso, J. (2004). Barriers to widespread use of mobile Internet in Europe. An overview of the new regulatory framework market competition analysis. *The Journal of the Communications Networks*, 3(3), 76-83.
- Ring, S. (2008). *IMT-Advanced, a global platform for the next generations of mobile services*. Paper presented at the International Converging Mobile Media Conference, Copenhagen, Denmark. <http://conf.cmi.aau.dk/presentations/IMT-Advanced%20at%20AAU.pdf>
- Ruhle, E.-O., & Lundborg, M. (2010). EU policy for next generation access – an innovative or incremental step forward? *Telecommunications Policy*, 34(1-2), 36-44.
- Sadiku, M. N. O., & Nguyen, T. H. (2002). Next generation networks. *IEEE Potentials*, 21(2), 6-8.
- Salman, H. A., & Ibrahim, L. F. (2010, 20-25 Sept. 2010). *Efficient Mobile Network Planning Algorithm in the Presence of Obstacles*. Paper presented at the Wireless and Mobile Communications (ICWMC), 2010 6th International Conference on.
- Sherif, M. H., & Maeda, Y. (2010). Standards for broadband access and beyond. *IEEE Communications Magazine*, 48(10), 136 - 138.

ANNEX 1 – DEMOGRAPHIC AND GEOGRAPHIC DATA

Table 4: Summary of demographic data for Spain (2001 for population and households, 2009 for businesses). Source: INE (2004, 2009)

| Zone | I | II | III | IV | V | VI | VII | VIII | IX | X | Total |
|----------------------------------|--------------------------------|---------------------------------|---------------------------------|---------------------------------|-----------------------------------|---------------------------------|--------------------------------|-------------------------------|------------------------------|------------------------|------------|
| Population density | >10 000 hab/km ² | 10-5 000 hab/km ² | 5 -3 000 hab/km ² | 3 -1 000 hab/km ² | 1 000 -500 hab/km ² | 500 -100 hab/km ² | 100 -50 hab/km ² | 50 -10 hab/km ² | 10 -5 hab/km ² | <5 hab/km ² | |
| Number of municipalities | 17 | 28 | 46 | 175 | 209 | 946 | 745 | 2705 | 1444 | 1797 | 8112 |
| Total population | 2 707 360 | 6 300 119 | 3 832 203 | 8 596 709 | 5 016 333 | 11 326 891 | 3 574 008 | 4 406 394 | 668 735 | 3 17 055 | 46 745 807 |
| Population per municipality | 159 256 | 225 004 | 83 309 | 49 124 | 24 002 | 11 973 | 4 797 | 1 628 | 463 | 176 | 5 763 |
| % of national population | 5,79 % | 13,48 % | 8,20 % | 18,39 % | 10,73 % | 24,23 % | 7,65 % | 9,43 % | 1,43 % | 0,67 % | 100 % |
| % of national population (acc) | 5,79 % | 19,27 % | 27,47 % | 45,86 % | 56,59 % | 80,82 % | 88,47 % | 97,90 % | 99,33 % | 100 % | 100 % |
| Total surface (km ²) | 179,14 | 1 086,33 | 969,99 | 5 278,55 | 7 103,38 | 50 561,39 | 52 638,58 | 185 348,40 | 92 937,96 | 108 573,47 | 504 677,19 |
| Surface per municipality | 10,54 | 38,80 | 21,09 | 30,16 | 33,99 | 53,45 | 70,66 | 68,52 | 64,36 | 60,42 | 62,21 |
| % of national surface | 0,04 % | 0,22 % | 0,19 % | 1,05 % | 1,41 % | 10,02 % | 10,43 % | 36,73 % | 18,42 % | 21,49 % | 100 % |
| % of national surface (acc) | 0,04 % | 0,26 % | 0,45 % | 1,50 % | 2,91 % | 12,93 % | 23,36 % | 60,09 % | 78,51 % | 100 % | 100 % |

| Zone | I | II | III | IV | V | VI | VII | VIII | IX | X | Total |
|--|-----------------------------|------------------------------|-----------------------------|-----------------------------|-------------------------------|-----------------------------|----------------------------|---------------------------|--------------------------|------------------------|------------|
| Population density | >10 000 hab/km ² | 10-5 000 hab/km ² | 5-3 000 hab/km ² | 3-1 000 hab/km ² | 1 000-500 hab/km ² | 500-100 hab/km ² | 100-50 hab/km ² | 50-10 hab/km ² | 10-5 hab/km ² | <5 hab/km ² | |
| Population density (h/km ²) | 15 113 | 5 799 | 3 951 | 1 629 | 706 | 224 | 67,9 | 23,8 | 7,20 | 2,92 | 92,63 |
| Number of buildings | 150,991 | 349,457 | 292,268 | 1.001.308 | 768.534 | 2.546.655 | 1.195.033 | 2.088.085 | 517.713 | 374.469 | 9 284 513 |
| Inhabitants per building | 17,93 | 18,03 | 13,11 | 8,59 | 6,53 | 4,45 | 2,99 | 2,11 | 1,29 | 0,85 | 5,03 |
| Buildings density (b/km ²) | 842,87 | 321,69 | 301,31 | 189,69 | 108,19 | 50,37 | 22,70 | 11,27 | 5,57 | 3,45 | 18,40 |
| Number of households | 956.677 | 2.076.924 | 1.170.050 | 2.509.817 | 1.406.991 | 3.106.774 | 1.056.207 | 1.486.870 | 273.065 | 143.794 | 14.187.169 |
| Persons per household ¹² | 2,63 | 2,74 | 2,95 | 2,88 | 2,91 | 2,96 | 2,93 | 2,78 | 2,55 | 2,37 | 2,85 |
| Number of businesses ¹³ | 247.676 | 536.081 | 311.978 | 709.653 | 400.875 | 880.898 | 270.780 | 330.552 | 50.376 | 24.361 | 3.763.229 |
| Number of households and businesses (n _{user}) | 1.204.353 | 2.613.005 | 1.482.028 | 3.219.470 | 1.807.866 | 3.987.672 | 1.326.987 | 1.817.422 | 323.441 | 168.155 | 17.950.398 |

¹² INE data only gives number of households with 1, 2, 3, 4, 5, 6 and 7 or more persons. The figures in the table have been obtained supposing a maximum number of 7 persons per household

¹³ Businesses per municipality are obtained from businesses per province distributed proportionally to the population of the municipality. This approach includes the number of different locations for the same business.

| Zone | I | II | III | IV | V | VI | VII | VIII | IX | X | Total |
|--|-----------------------------|------------------------------|-----------------------------|-----------------------------|-------------------------------|-----------------------------|----------------------------|---------------------------|--------------------------|------------------------|------------------|
| Population density | >10 000 hab/km ² | 10-5 000 hab/km ² | 5-3 000 hab/km ² | 3-1 000 hab/km ² | 1 000-500 hab/km ² | 500-100 hab/km ² | 100-50 hab/km ² | 50-10 hab/km ² | 10-5 hab/km ² | <5 hab/km ² | |
| Households and businesses per building | 7,82 | 7,34 | 4,96 | 3,14 | 2,29 | 1,53 | 1,08 | 0,85 | 0,61 | 0,44 | 1,89 |
| Multi-dwelling units | 110.542 | 236.055 | 146.786 | 395.617 | 254.702 | 678.233 | 274.232 | 383.016 | 72.718 | 49.757 | 2.601.658 |
| % of total buildings | 73% | 68% | 50% | 39% | 32% | 27% | 23% | 18% | 14% | 13% | 28% |
| Single-unit buildings | 40.449 | 113.402 | 145.482 | 614.181 | 542.133 | 1.833.646 | 921.000 | 1.706.285 | 442.955 | 323.816 | 6.683.349 |
| % of total buildings | 27% | 32% | 50% | 61% | 68% | 73% | 77% | 82% | 86% | 87% | 72% |

Table 5: Number of potential subscribers to NGAN as a function of geotype. Source: own estimations from INE (2004, 2009) and Ministerio de Vivienda (2007)

| Geotype | <i>Total potential subscribers (households + businesses)</i> | <i>Total population</i> | <i>% of potential subscribers and population per zone</i> |
|---------------------------------|--|-------------------------|---|
| Ia (> 10 000 inh/km2) | 1.021.201 | 2.295.639 | 85% |
| Ib (> 10 000 inh/km2) | 183.152 | 411.721 | 15% |
| IIa (10-5 000 inh/km2) | 1.643.385 | 3.962.304 | 63% |
| IIb (10-5 000 inh/km2) | 969.620 | 2.337.815 | 37% |
| IIIa (5-3 000 inh/km2) | 1.032.731 | 2.670.418 | 70% |
| IIIb (5-3 000 inh/km2) | 449.297 | 1.161.785 | 30% |
| IVa (3-1 000 inh/km2) | 1.235.055 | 3.297.873 | 38% |
| IVb (3-1 000 inh/km2) | 1.984.415 | 5.298.836 | 62% |
| Va (1000 – 500 inh/km2) | 379.034 | 1.051.714 | 21% |
| Vb (1000 – 500 inh/km2) | 1.428.832 | 3.964.619 | 79% |
| VIa (500 – 100 inh/km2) | 1.232.210 | 3.500.065 | 31% |
| VIb (500 – 100 inh/km2) | 2.755.461 | 7.826.826 | 69% |
| VIIa (100 – 50 inh/km2) | 741.787 | 1.997.873 | 56% |
| VIIb (100 – 50 inh/km2) | 585.200 | 1.576.135 | 44% |
| VIIIa (50 – 10 inh/km2) | 790.356 | 1.916.242 | 43% |
| VIIIb (50 – 10 inh/km2) | 1.027.066 | 2.490.152 | 57% |
| IX (10 – 5 inh/km2) | 323.441 | 668.735 | 100 % |
| X (<5 inh/km2) | 168.155 | 317.055 | 100 % |
| Total | 17.950.398 | 46.745.807 | |

ANNEX 2 – COST CALCULATION DATA

Table 6: Number of potential subscribers per zone and cell area and number of base stations for wireless access. Source: own estimations

| <i>Zone</i> | <i>Total number of potential subscribers per zone (n_{zonal})</i> | <i>Number of users per cell area (n_{cell})</i> | <i>Average radius of cell area (m) (d_c)</i> | <i>Number of base stations per zone</i> | <i>Number of users per access area (n_{accd})</i> | <i>Number of base stations per equivalent access area (n_{eq})</i> | <i>Number of fibres at each B segment ($n_{fibresB}$)</i> | <i>Number of division points at A-B per access area (n_{divAB})</i> | <i>Number of fibres at each A segment ($n_{fibresA}$)</i> |
|--------------------------------|--|--|---|---|--|---|--|--|--|
| I (> 10 000 inh/km2) | 1.204.353 | 360 | 131 | 3.345 | 16384 | 46 | 8 (min 2) | 8 | 16 |
| II (10-5 000 inh/km2) | 2.613.005 | 360 | 218 | 7.258 | 16384 | 46 | 8 (min 2) | 8 | 16 |
| III (5-3 000 inh/km2) | 1.482.028 | 360 | 274 | 4.117 | 16384 | 46 | 8 (min 2) | 8 | 16 |
| IV (3-1 000 inh/km2) | 3.219.470 | 360 | 433 | 8.943 | 16384 | 46 | 8 (min 2) | 8 | 16 |
| V (1000 – 500 inh/km2) | 1.807.866 | 360 | 671 | 5.022 | 16384 | 46 | 8 (min 2) | 8 | 16 |
| VI (500 – 100 inh/km2) | 3.987.672 | 360 | 1205 | 11.077 | 16384 | 46 | 8 (min 2) | 8 | 16 |
| VII (100 – 50 inh/km2) | 1.326.987 | 360 | 2132 | 3.686 | 4096 | 12 | 8 (min 2) | 8 | 16 |
| VIII (50 – 10 inh/km2) | 1.817.422 | 360 | 3419 | 5.048 | 2048 | 6 | 8 (min 2) | 4 | 16 |
| IX (10 – 5 inh/km2) | 323.441 | 223 | 4516 | 1.450 | 512 | 1 | 8 (min 2) | - | 16 |
| X (<5 inh/km2) | 168.155 | 106 | 4668 | 1.586 | 256 | 1 | 8 (min 2) | - | 16 |