

Koop, Michael J.

Working Paper

The Influence of Capital Market Integration on Production and Market Structures

Kiel Working Paper, No. 1040

Provided in Cooperation with:

Kiel Institute for the World Economy – Leibniz Center for Research on Global Economic Challenges

Suggested Citation: Koop, Michael J. (2001) : The Influence of Capital Market Integration on Production and Market Structures, Kiel Working Paper, No. 1040, Kiel Institute of World Economics (IfW), Kiel

This Version is available at:

<https://hdl.handle.net/10419/17729>

Standard-Nutzungsbedingungen:

Die Dokumente auf EconStor dürfen zu eigenen wissenschaftlichen Zwecken und zum Privatgebrauch gespeichert und kopiert werden.

Sie dürfen die Dokumente nicht für öffentliche oder kommerzielle Zwecke vervielfältigen, öffentlich ausstellen, öffentlich zugänglich machen, vertreiben oder anderweitig nutzen.

Sofern die Verfasser die Dokumente unter Open-Content-Lizenzen (insbesondere CC-Lizenzen) zur Verfügung gestellt haben sollten, gelten abweichend von diesen Nutzungsbedingungen die in der dort genannten Lizenz gewährten Nutzungsrechte.

Terms of use:

Documents in EconStor may be saved and copied for your personal and scholarly purposes.

You are not to copy documents for public or commercial purposes, to exhibit the documents publicly, to make them publicly available on the internet, or to distribute or otherwise use the documents in public.

If the documents have been made available under an Open Content Licence (especially Creative Commons Licences), you may exercise further usage rights as specified in the indicated licence.

Kiel Institute of World Economics

Düsternbrooker Weg 120, D-24105 Kiel

Working Paper No. 1040

**The Influence of Capital Market Integration
on Production and Market Structures**

by

Michael J. Koop

March 2001

The author himself, not the Kiel Institute of World Economics, is solely responsible for the contents and distribution of Kiel Working Papers. Since the series involves manuscripts in a preliminary form, interested readers are requested to direct their criticisms and suggestions directly to the author and to clear any quotations with him.

The Influence of Capital Market Integration on Production and Market Structures

by Michael J. Koop

Abstract: The paper analyzes the effects of increasing capital market integration on production and market structures, trade and capital flows as well as national and global welfare. In order to facilitate the analysis of the integration process, three stages of capital market integration are defined. First, capital is internationally immobile, secondly, capital is partly mobile, and finally perfect capital mobility is considered. The analysis is carried by means of a general equilibrium model of international trade which incorporates the new trade theory as well as aspects of the theory of multinational enterprises. Simulations of each of the three versions of the model for different absolute and relative factor endowments provide insights into the changes that are brought about by capital market integration

Key Words: Market Structure, International Trade, Foreign Direct Investment, Multinational Enterprise

JEL Classification: F12, F21, L11

Table of Contents:

1. Introduction
2. A Model of International Trade and Capital Flows
3. Separated Capital Markets – The Benchmark of Immobile Capital
 - 3.1 Allocation of Production and Market Structure
 - 3.2 International Trade
 - 3.3 Goods and Factor Prices
 - 3.4 Welfare Effects
 - 3.5 The International Division of Labor When Capital Is Immobile
4. Partial Capital Mobility
 - 4.1 Allocation of Production and Market Structure
 - 4.3 International Trade and Foreign Direct Investment
 - 4.4 Goods and Factor Prices
 - 4.5 Trade and Capital Mobility
 - 4.6 Welfare Effects
5. International Capital Market Integration
 - 5.1 Allocation of Production and Market Structure
 - 5.2 International Trade and Foreign Direct Investment
 - 5.3 Goods and Factor Prices
6. Conclusions

Michael J. Koop

Phone: 0391 – 886 4672 / Fax: 0391 – 886 4123

e-mail: mkoop@maschinenbau.hs-magdeburg.de

This paper has been written as part of the research project Internationale Arbeitsteilung bei Kapitalmobilität: Eine theoretische Analyse der Globalisierung. Funding by Deutsche Forschungsgemeinschaft (DFG) is gratefully acknowledged.

The Influence of Capital Market Integration on Production and Market Structures

1. Introduction

In the final decades of the last millenium, international capital market integration made rapid progress. Technological advances made worldwide transactions possible at significantly reduced transaction costs. Many industrialized countries abolished restrictions on international capital flows and developing countries started to welcome foreign direct investment as a source of economic growth and prosperity. The result was a tremendous increase in foreign portfolio investment and in FDI (UNCTAD 2000).

This paper will analyze the impact of FDI on the source as well as the host country, i.e. on the specialization of economies, international production patterns, trade and capital flows. It will do so by integrating various types of trade (interindustry, intraindustry, intrafirm), foreign direct investment and multinational enterprises (vertically and horizontally integrated) into the framework of a two country general equilibrium model. This model was developed in Koop (1997, 2000). The results will be based on numerical simulations for different degrees of international capital market integration.

2. A Model of International Trade and Capital Flows

The model consists of two countries, with fixed stocks of the two factors of production, capital and labor¹. Both factors are mobile across sectors within the same country. Whereas labor can never migrate there are three degrees of international capital mobility representing the different stages of capital market integration: immobile capital, partly mobile capital, and perfectly mobile capital. There are two homogeneous goods, X and Y. Good Y is produced in both countries according to some standard CES technology.

Whatever the degree of international capital market integration is, good X can always be produced by national exporters. If capital is partly or perfectly mobile good X can also be produced by multinational enterprises (MNEs) (Konan, Markusen, Venables, Zhang 1996). In any case, good X is produced with increasing returns to scale at the firm as well as at the plant level (Markusen 1984). Research and development is carried out at the firm level. The results (R&D) are public goods throughout the firm. In order to implement the results of R&D activities, the firm incurs additional fixed costs (T) at each plant. These fixed costs are specific to each plant and lead to increasing returns to scale at the plant level. Therefore adding more plants raises total fixed costs at the plant level but not at the firm level. An intermediate input I which is used in the X sector is produced with constant returns to scale and constant marginal costs.

Exporters produce in their home countries only, so that the respective factor demand is restricted to domestic suppliers. When exporting, the firms incur fixed transport costs which are independent of the direction of trade. Contrary to good X, good Y and the intermediate input can be transported at no cost.

Multinational enterprises serve both markets by producing the final output where they will sell it. They produce firm-specific fixed costs in the home country and incur plant-specific

fixed costs in both countries. By transferring R&D to foreign affiliates, the multinational firms engage in international trade in services. Because this transfer is carried out within the firm it constitutes intrafirm trade. Production of the intermediate input is completely carried out in the foreign country. Part of the intermediate inputs is then shipped back to the home country where it is used for final production. Because there are no independent suppliers of the intermediate input, trade in intermediate inputs is a strictly internal transaction, constituting the model's second type of intrafirm trade (Klau 1995).

When capital is partly mobile, multinational firms fulfill their capital requirements of their foreign affiliate for plant-specific fixed costs as well as for intermediate and final production by deploying part of their domestic capital stocks in the foreign country. This constitutes the FDI part of the model. It is a restricted form of capital mobility as it does not allow domestic firms to draw directly on the foreign capital stock but only indirectly by moving some production activities abroad. It is assumed that the minimum rate of return on capital deployed abroad is equal to the company's domestic return on investment. With full capital market integration, all firm types fulfill their capital needs on the unified world market.

In the oligopolistic market, free entry and exit prevail. The approach followed is the static entry concept (Shapiro 1983, Friedman 1983) in which positive profits immediately induce new firms to enter and negative profits immediately trigger the exit of some firms. With free entry and exit, no profits are made in the oligopolistic sector.

Exporters and MNEs maximize their profits subject to the constraints that production quantities and profits be nonnegative. Their behavior is strictly noncooperative, i.e. there is Cournot competition. The ensuing equilibrium is the standard single-period Cournot-Nash equilibrium. In order to maximize profits firms set marginal revenues to be not higher than marginal costs. In other words, if marginal costs exceed marginal revenues the company will not exist in equilibrium.

In order to recover their fixed costs, firms charge markups. The markups are defined as the relative difference between price and marginal costs, i.e. they are applied on a gross basis. In a Cournot model with homogeneous products, the optimal markups can be approximated by dividing a firm's market share by the Marshallian price elasticity of demand in the respective market (Markusen, Venables 1995).

Given that there are no barriers to free entry and exit in the oligopolistic sector, companies must make zero profits, i.e. total markup revenues must be equal to total fixed costs. Since the number of firms present in equilibrium is endogenous it might turn out that in some situations the zero profit condition cannot be fulfilled by one or more firm types. In other words, the set of possible solutions is not by assumption restricted to interior solutions but may very well contain corner solutions.

In equilibrium exporters from both countries and therefore intraindustry trade in identical products can exist. When transport costs are zero exporters from both countries basically operate in an integrated goods market although factor markets remain separated. Even with positive transport costs intraindustry trade in identical products is profitable as exporters engage in „reciprocal dumping“, i.e. they undercut the price in the other country as they only have to cover their marginal costs which are below prices due to fixed costs (Brander, Krugman 1983). For all levels of transport costs it is assumed that there are no resale activities. Therefore a product sold at a lower price in the foreign market cannot profitably be re-imported to the country of origin.

Because of the complexity of the model, analytical solutions could not be derived and numerical simulations were carried out instead. In the simulations, the model was calibrated so that good X was the capital-intensive good whereas Y was the labor-intensive one. However, firms can split up the production of X into three different stages: the production of fixed costs (R&D, T), the intermediate input (I) and final assembly (F). Each step requires capital and labor to be used, albeit in different proportions. The assumption on relative factor endowments (in the benchmark scenario) was that R&D and T were the most capital-intensive production stages followed by final assembly (F) which in turn was more capital-intensive than good Y and the most labor-intensive intermediate input.

3. Separated Capital Markets – The Benchmark of Immobile Capital

The simulations of the benchmark scenario were carried out, assuming that the capital markets of the two countries were completely closed so that capital was effectively immobile across borders.

3.1 Allocation of Production and Market Structure

For different factor endowment distributions, Figure 1 shows which types of firms are active in equilibrium, i.e. produce the increasing returns to scale good X. Since there are only two firm types the number of different market structures is limited to three: oligopolies exclusively with firms from either one country or a joint oligopoly with firms from both countries. Surprisingly, the major determinant of market structures appears to be market size, not relative factor endowments, as could be expected in a model without factor mobility.

Figure 1: Active Types of Firms with Immobile Capital^h

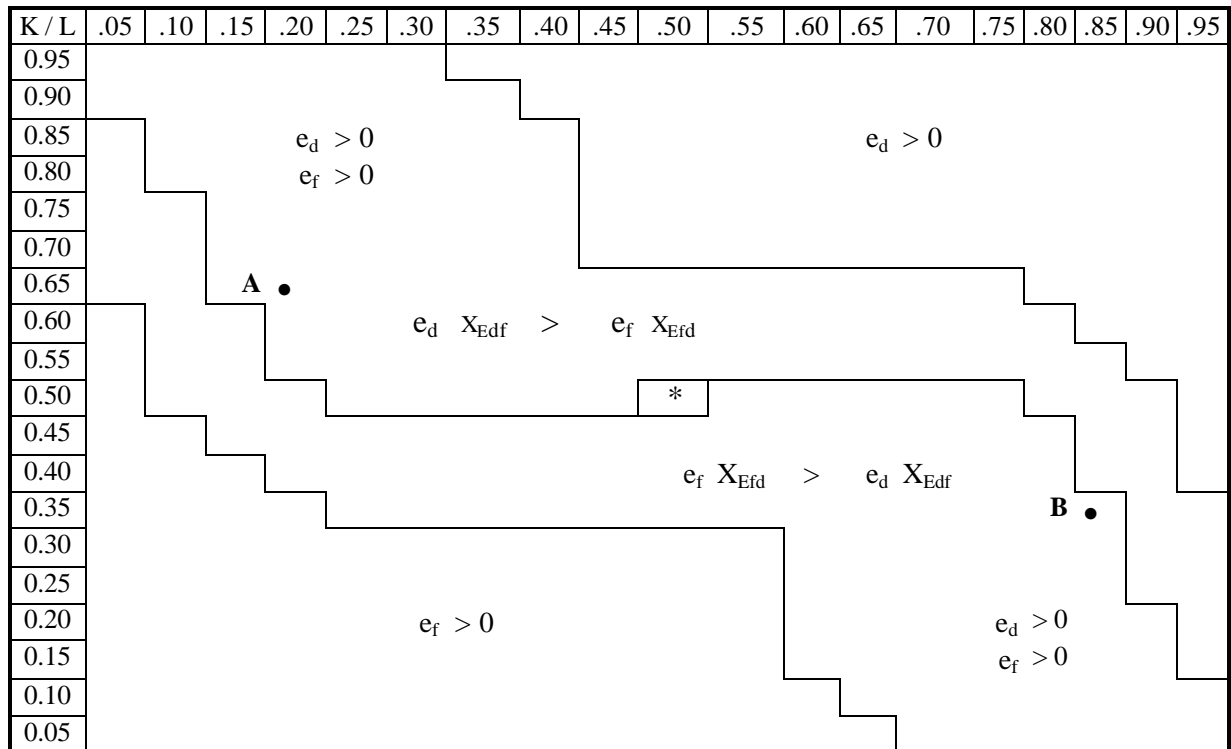

^h The notation for the figures is defined in the Appendix; * $e_d \cdot X_{Edf} = e_f \cdot X_{Efd}$

The production of good X is either carried out in both countries if they are not too dissimilar in absolute factor endowments or it is concentrated in one country if that country is sufficiently big. Since exporters cannot separate the production stages, R&D and the intermediate input I are only produced in a country if that country's exporters are competitive. Otherwise all stages of the production of good X are terminated and the country fully specializes in the other final output Y which is always produced in both countries (Figure 2). Even if the small country fully specializes in the production of good Y it is too small to satisfy the demand in the big country and the big country remains a producer of Y as well.

Figure 2: Production of Good Y and Intermediate Input I with Immobile Capital

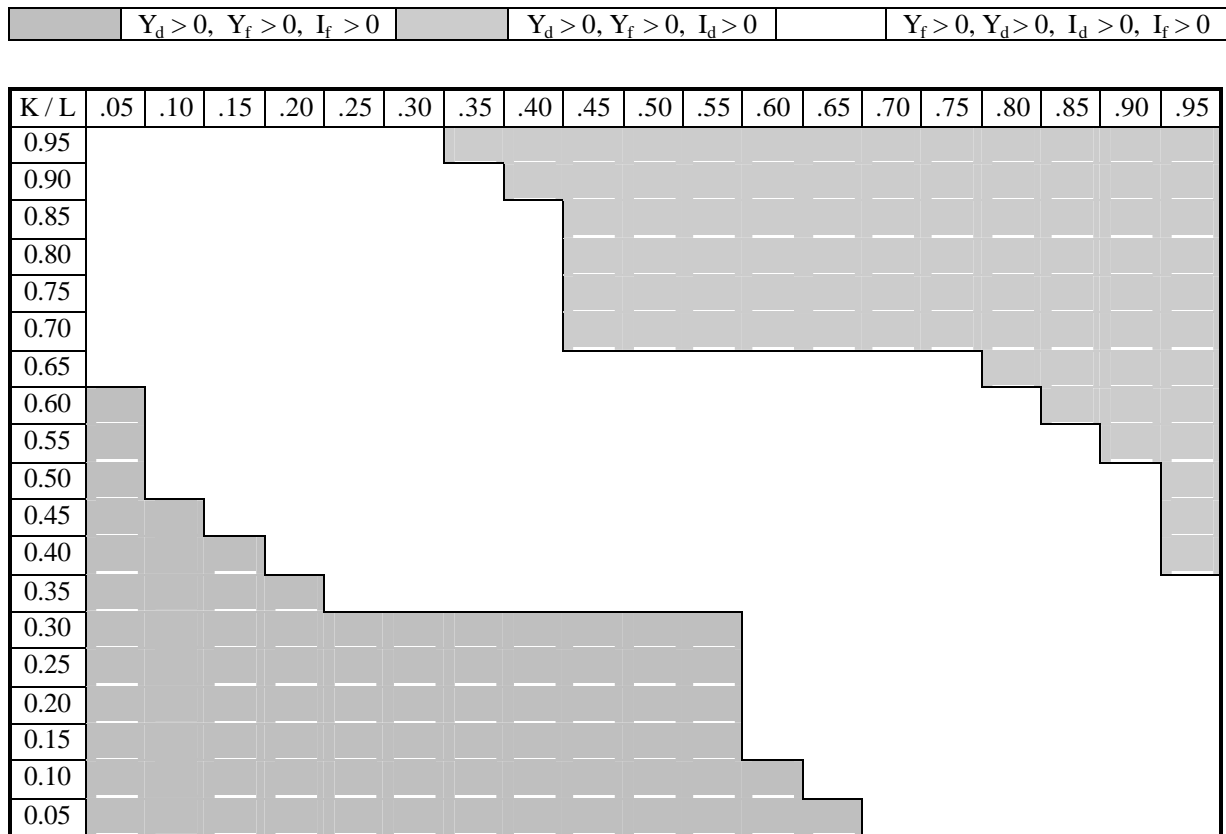

3.2 International Trade

Figure 1 can also be used to analyze trade flows between the two countries. For countries of similar size, intraindustry trade in good X prevails, independent of relative factor endowments. With sufficiently big differences in country size, the big country is always the sole exporter of the increasing returns to scale good X. Since factors of production are internationally immobile trade can only be balanced if the small country exports the same value of the constant returns to scale good Y. It is obvious that in addition to country size relative factor endowments determine production and trade patterns. For instance, a small country can be the net exporter of the increasing returns to scale good if it is very capital-abundant. Point A in Figure 1 depicts one such factor distribution. In this case, the advantage of relatively cheap capital in the small domestic country more than offsets the disadvantage of having a small home market. Similarly, point B is an example for a factor distribution for which the big

domestic country imports the capital-intensive good X because it is the labor-abundant country. In short, actual trade flows depend on the relative strength of the size and the relative factor abundance effect.

3.3 Goods and Factor Prices

Factor prices are never fully equalized unless the two countries are identical in terms of absolute and relative factor endowments. Although goods prices differ accordingly trade is insufficient to equalize prices. The reason is that in the case of a favorable factor redistribution the home-market bias allows the producers of the bigger country to increase production, thereby reducing their average costs. This in turn enables them to lower their prices at home. Due to positive transport costs the reduction in the export price is smaller as transport costs gain in relative importance. Moreover, the exporters in the small country — if there are any — gain market shares in their home market, reduce production per firm and raise prices due to higher average costs and higher markups (due to higher market shares). Exporters of the bigger country cannot profitably increase production and exports (thereby narrowing the relative price gap) because additional production would raise the relative factor price of capital in the big country, making production relatively more expensive compared to the small country.

3.4 Welfare Effects

Welfare in this model can be measured in terms of the Hicksian equivalent. For the benchmark equilibrium, utility levels for both countries are normalized to equal one. Of course, interpreting changes in national utility levels due to the redistribution of factors of production is not meaningful. However, some interesting insights with respect to the welfare effects can be gained by looking at world welfare levels. Moreover, these utility levels will serve as benchmark values for examining the welfare effects of increasing capital mobility.

Figure 4: World Welfare Levels

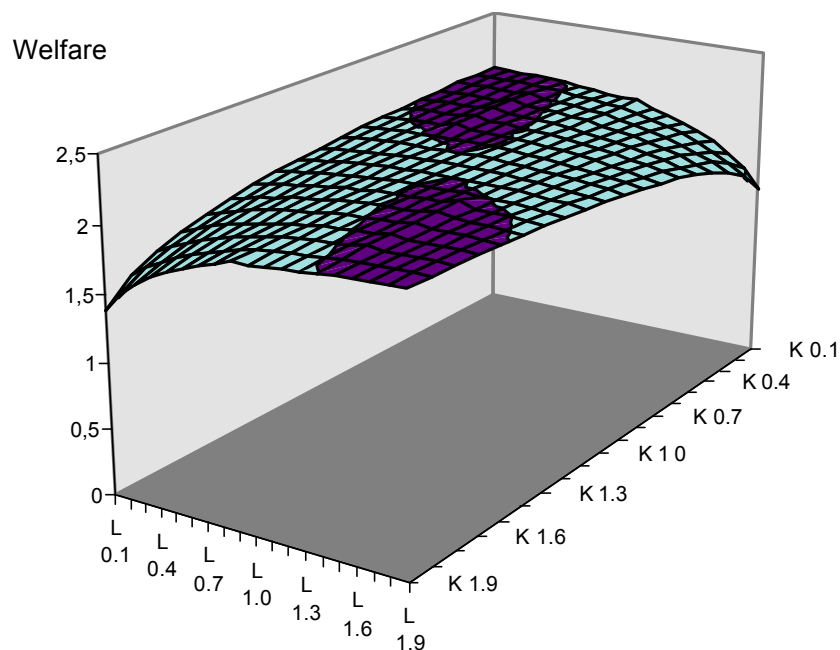

Figure 4 depicts the sum of utility levels for all distributions of the world factor endowment. For identical countries this sum is two. Starting in the center and moving along the diagonal, i.e. leaving relative factor endowments unchanged, slowly increases the world welfare level. In the dark shaded areas, world welfare levels exceed the benchmark level of two. There are three reasons for this increase in the world welfare level. First, the average size of X producers increases so that average costs decrease. Secondly, moving closer to the corners erases the exporters of the small country and thereby wasteful intraindustry trade. Therefore resources used up for transporting good X can now be used to produce the two goods. Thirdly, with one country becoming increasingly small, absolute trade volumes diminish further so that the highest world welfare level is attained for extreme size differences of countries with identical relative endowments. The lowest levels of world welfare are reached when countries are of similar size but have very different relative factor endowments. This occurs because trade volumes and transport costs are high and relative factor price differences big.

3.5 The International Division of Labor When Capital Is Immobile

The two major determinants of production and trade structures are absolute and relative factor endowment differences. As can be seen from Figure 1, the stronger force in this calibration of the model is country size. The bigger a country is the more it dominates the production of the capital-intensive, increasing returns to scale good. This changes only somewhat when differences in relative factor endowments are introduced. In particular, the relative endowment asymmetry affects the position of the net exporters of the capital-intensive good. When countries are of similar size the smaller but capital-abundant country is the net exporter of the capital-intensive good. The reason that relative endowment differences do not play an even more important role is that the „average“ factor intensity of good X is only modestly above that of good Y. Because exporters cannot separate the different production stages geographically the fact that factor intensities of the three stages of X production differ greatly is of minor importance. All that matters are the average factor intensities of the final goods. Obviously, this will change when companies are allowed to invest abroad and separate the production stages.

4. Partial Capital Mobility

The introduction of partial capital market integration now allows some firms (MNEs) to invest capital in the foreign country. International capital market integration, however, will remain incomplete at this point because neither MNEs nor exporters or producers of good Y have access to the foreign capital market.

4.1 Allocation of Production and Market Structure

Figure 5 shows which types of firms are active in equilibrium. The most interesting part of the figure is the core where the two countries have similar income levels and similar relative factor endowments. In this area, where factor proportions differences are small and proximity advantages roughly balance concentration advantages, exporters and MNEs from both countries exist. By containing intraindustry trade in final goods, intermediate inputs and services as well as multinational enterprises and two-way FDI, the equilibria appear to be a fair image of economic exchange between industrial countries. Evidently, factor price differences vanish

and multinational enterprises exist purely as the horizontal type. In addition, since no country is sufficiently bigger than the other, neither firm type can exploit economies of scale to an extent that allows it to outcompete other firm types. The competitiveness of firm types is mainly determined on the basis of the tradeoff between transport costs and additional fixed costs.

Figure 5: Active Types of Firms with Partly Mobile Capital

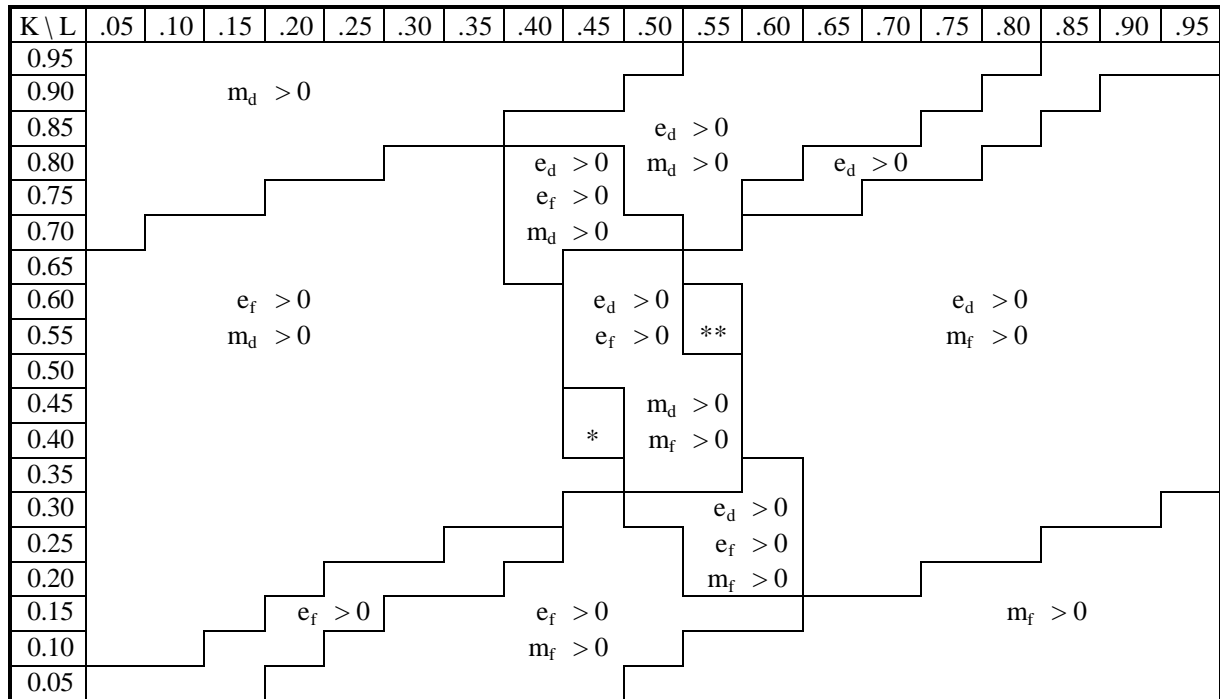

* $e_d > 0, e_f > 0, m_d > 0$; ** $e_d > 0, e_f > 0, m_f > 0$.

Moving away from the central region, one of the two MNE types loses competitiveness and exits the market. Shifting factors along the diagonal, these uncompetitive MNEs come from the labor-abundant country. Although goods and factor prices are still equalized across countries they are unable to compete because initial relative factor endowments are sufficiently different to make exporters and MNEs of the capital-abundant and exporters of the labor-abundant country competitive. Redistributing factors along the diagonal of identical relative factor endowments, the MNEs of the big country exit the market as the smaller country's market does not generate sufficient markup revenues to recover the additional fixed costs of a second plant abroad.

Starting in the lower part of Figure 5, the left-hand corner of the diagram where the home country possesses only five percent of the world's resources but has the same relative endowment as the foreign country, only foreign exporters produce good X. Obviously, with identical relative endowments there are no vertically integrated MNEs. Because the domestic country's market is too small it is also not profitable for horizontally integrated MNEs to operate a second plant in the domestic country. Due to the large foreign market foreign exporters exploit economies of scale and outcompete domestic exporters.

Increasing the domestic country's share in the world capital stock and raising its labor supply to a smaller extent, makes the country relatively capital-abundant and raises domestic income.

The country's wage-rental ratio exceeds that of the foreign country. This fosters domestic MNEs' competitiveness which deploy some of the relatively cheap domestic capital in the foreign country to take advantage of the relatively cheap foreign labor. Thus they seem to be driven by vertical integration compared to the domestic exporters. Compared to foreign exporters they appear at least partially as horizontal MNEs which save on transport costs by supplying the foreign market through foreign production.

Moving the capital endowment axis further up, domestic multinationals outcompete all foreign exporters owing to substantial factor price differences but also because they are able to exploit significant returns to scale. In addition, differences in market size become very small which also tends to favor MNEs.

Raising the domestic share in the world's labor supply beyond 50 percent increases domestic income and lowers the domestic wage-rental ratio at the same time. Because exporters' production is marginally more labor-intensive (due to positive transport costs and lower fixed costs) some domestic exporters enter the market. Since they only incur the fixed costs of one plant they can charge lower markups than MNEs. Since optimal markups equal market shares it follows that the output of individual exporters is *ceteris paribus* always smaller than that of individual MNEs. Which of the firm types is dominant in this region of the diagram in terms of accumulated market share is indeterminate as the number of firms of each type can vary according to factor distribution. Close to the diagonal, the domestic country gets so big that the foreign country's market is too small to generate sufficient markup revenues for a second MNE plant abroad and domestic exporters supplant all other firm types.

Beyond the analysis of market structures, Figure 5 can also be used for determining where the different production stages are located. In the overwhelming number of cases, final production of X is carried out in both countries. Merely the small area underneath (above) the diagonal in the left (right) part where foreign (domestic) exporters outcompete all other firm types, X is only produced in the capital-abundant foreign (domestic) country (except for the two corners where relative endowments are identical).

With respect to the location of R&D activities, three different areas are discernible. If a country's share in the world capital stock is below 25 percent it (almost) never produces R&D, independent of its size. The only exception to this is when the country is tiny but capital-abundant. In this situation, a small number of fairly big domestic MNEs engages in R&D. This might reflect the cases of Sweden and the Netherlands which are small, capital-abundant and home to a number of big MNEs. For capital shares in the range of 25-75 percent, both countries produce R&D although the share of R&D in GDP is significantly higher for the capital-abundant country. If a country's share in the world's capital stock exceeds 75 percent, this country is almost always the sole producer of R&D, more or less independent of its share in the world's labor supply.

Figure 6 briefly highlights where the labor-intensive activities, i.e. production of good Y and the intermediate input I, are carried out. Both countries always produce some amount of good Y. The intermediate input I is solely produced in one country when this country owns at least 65 percent of the world labor supply. With the exception of some very extreme distributions of the world capital stock this is true independent of the size of that country's capital stock. Only if the world's labor supply is divided up fairly evenly do both countries engage in the production of I.

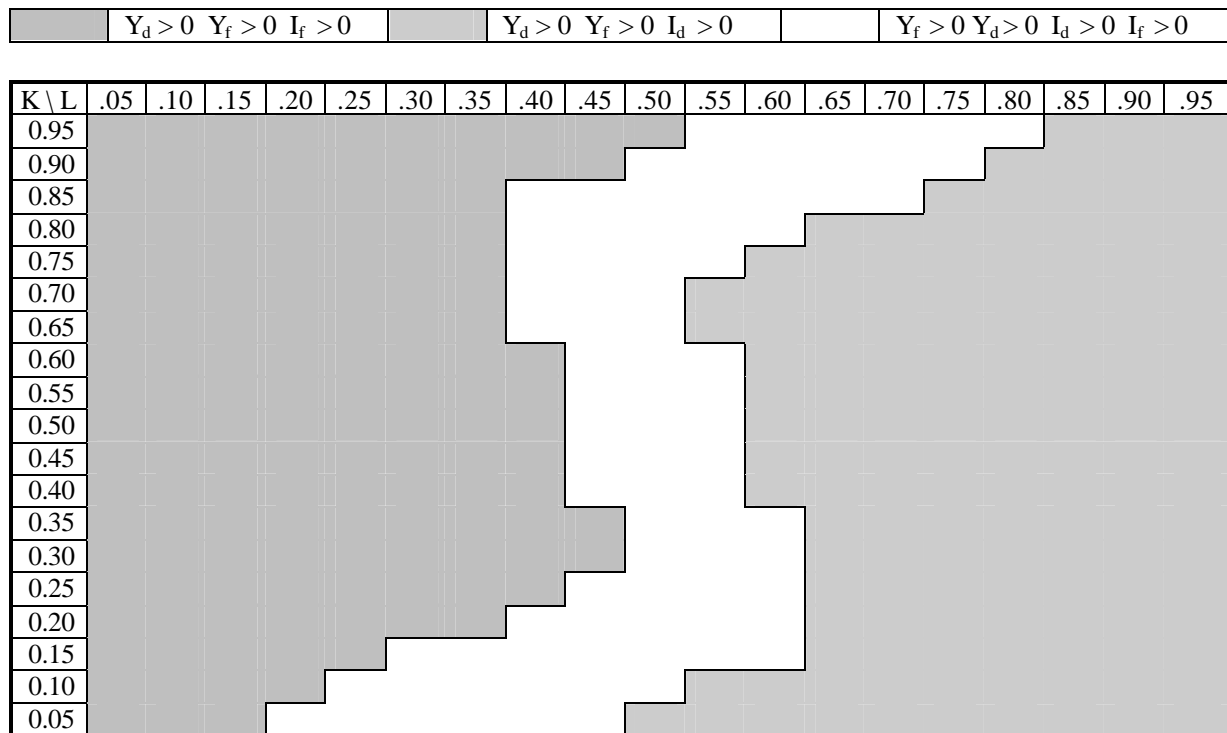
Figure 6: Production of Good Y and Intermediate Input I with Partly Mobile Capital

The simulation results with respect to the geographic allocation of production can be condensed into 3 hypotheses:

- *Concentration of production with partly mobile capital:* The most capital-intensive production of R&D is concentrated in the (very) capital-abundant country, (almost) independent of the country's labor endowment. If the world capital stock is divided fairly evenly among the two countries, both engage in R&D. On the contrary, the most labor-intensive production of the intermediate input is concentrated in the labor-abundant country, independent of the country's capital endowment. Production of the moderately labor-intensive good Y is always and the moderately capital-intensive final assembly of good X is (almost) always carried out in both countries unless one country is big and slightly capital-abundant.
- *Specialization of countries with partly mobile capital:* Even with big absolute and/or relative factor endowment differences, countries seldom fully specialize. Only when a country is small and slightly labor-abundant will it fully specialize in the labor-intensive good Y.
- *Existence of multinational enterprises with partly mobile capital:* The importance of MNEs increases:
 - (a) the more uneven relative factor endowments become (vertical integration) and
 - (b) the more similar income and relative endowments become (horizontal integration).

One general result emerges that is not fully in line with economic intuition. In the pure trade equilibrium, the major determinant of market structures and the allocation of production was market size. With partial capital mobility, which can level off relative factor endowment

differences to some extent, these relative differences stand side by side with absolute endowment differences in explaining market and production structures.

4.2 Factor Redistribution and Structural Change

Combining these findings allows to discuss structural change within one economy. The general result is that structural change is a fairly smooth process rather than one characterized by abrupt changes in the production patterns. For positive transport costs, the moderately capital-intensive final assembly of X and the moderately labor-intensive production of Y are carried out in both countries for most factor endowment distributions. Changes in a country's specialization pattern mainly occur with respect to the heavily capital-intensive production of R&D and the heavily labor-intensive production of the intermediate input. For example, Figure 7 presents a labor-abundant developing country with 5 percent of the world's capital stock and 20 percent of the world's labor supply (which may be called Korea). Initially, this country does not have an R&D sector of its own and MNEs of the foreign country produce only a small quantity of good X in the domestic market. The main part of this country's production consists of the two labor-intensive goods. When the country starts accumulating capital (faster than the developed country) its capital-labor ratio and relative size increase. As a consequence it discontinues the production of the most labor-intensive good I and extends the production of Y, adjusting the overall factor intensity of its production to its new relative factor endowment. Since foreign MNEs exit the market, the production of X is discontinued in the developing country. When the country accumulates more capital, some domestic MNEs emerge and the country starts producing capital-intensive R&D as well as good X. Continuing capital accumulation, the country increases production of R&D and X further and lowers its production of Y, eventually turning from an exporter of Y to an importer.

Figure 7: Factor Redistribution and Structural Change

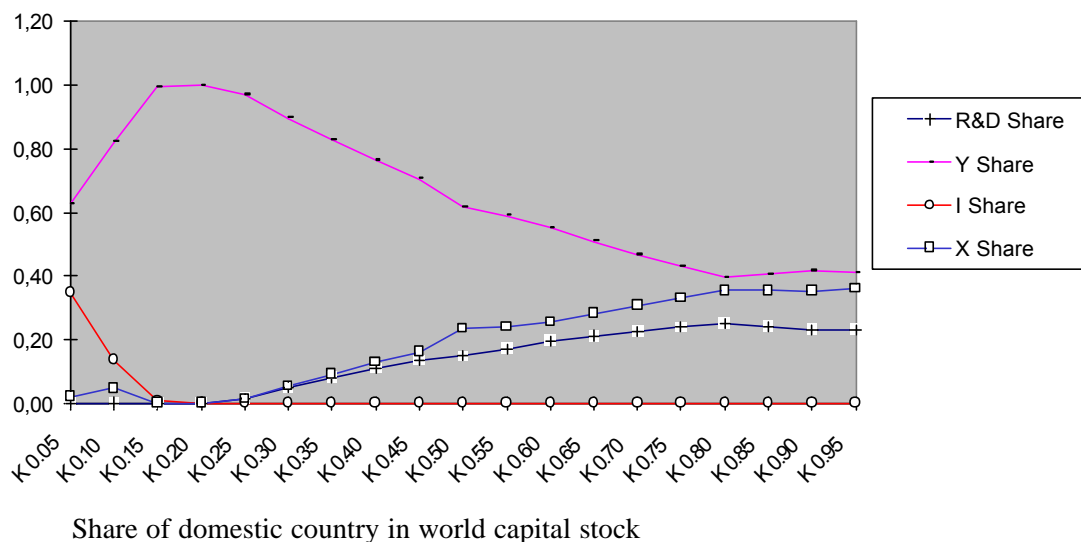

Similarly, an initially big labor-abundant country such as China develops along these lines. Starting out with no domestic R&D, the accumulation of capital leads to a shift towards the production of good X. Later on, a domestic R&D sector emerges while the output of the labor-intensive sectors declines as the country turns from an exporter of Y to an importer and as domestic MNEs shift the production of the intermediate input abroad. In short, structural change mostly appears to be a rather smooth undertaking for both countries. In the process of (relative) capital accumulation, the countries gradually reduce the most labor-intensive activi-

ties for more capital-intensive ones. They do not close down big industries at once and replace them with others. In this respect, the results differ from Horstmann, Markusen (1992, p. 109), who find in a similar model that nature proceeds by leaps („natura facit saltum“).

4.3 International Trade and Foreign Direct Investment

The international division of labor in this version of the model with partial capital mobility is substantially more complex than in the trade version because the existence of MNEs gives rise to trade in additional commodities (R&D, I) as well as capital flows. Figure 8 presents the simulation results for trade in good X and foreign direct investment flows. The figure closely corresponds with Figure 5 which depicts the types of firms active in equilibrium. Since the market structures were explained there the focus will now be on the resulting trade and capital flows.

The most interesting part of Figure 8, again, is its center where absolute and relative endowments differ only slightly (Point A). In this area, intraindustry trade as well as cross-hauling of foreign direct investment occurs. As multinational firms exist in both countries there is also intraindustry intrafirm trade in intermediate inputs and R&D. Evidently, with similar relative and absolute factor endowments factor proportions considerations play no important role. With factor prices equalized, multinationals survive because they do not have to pay transport costs, whereas exporters save the costs of operating a second plant abroad. Proximity and concentration advantages just balance so that neither firm type has a significant competitive advantage.

Figure 8: Trade in X and FDI with Partly Mobile Capital

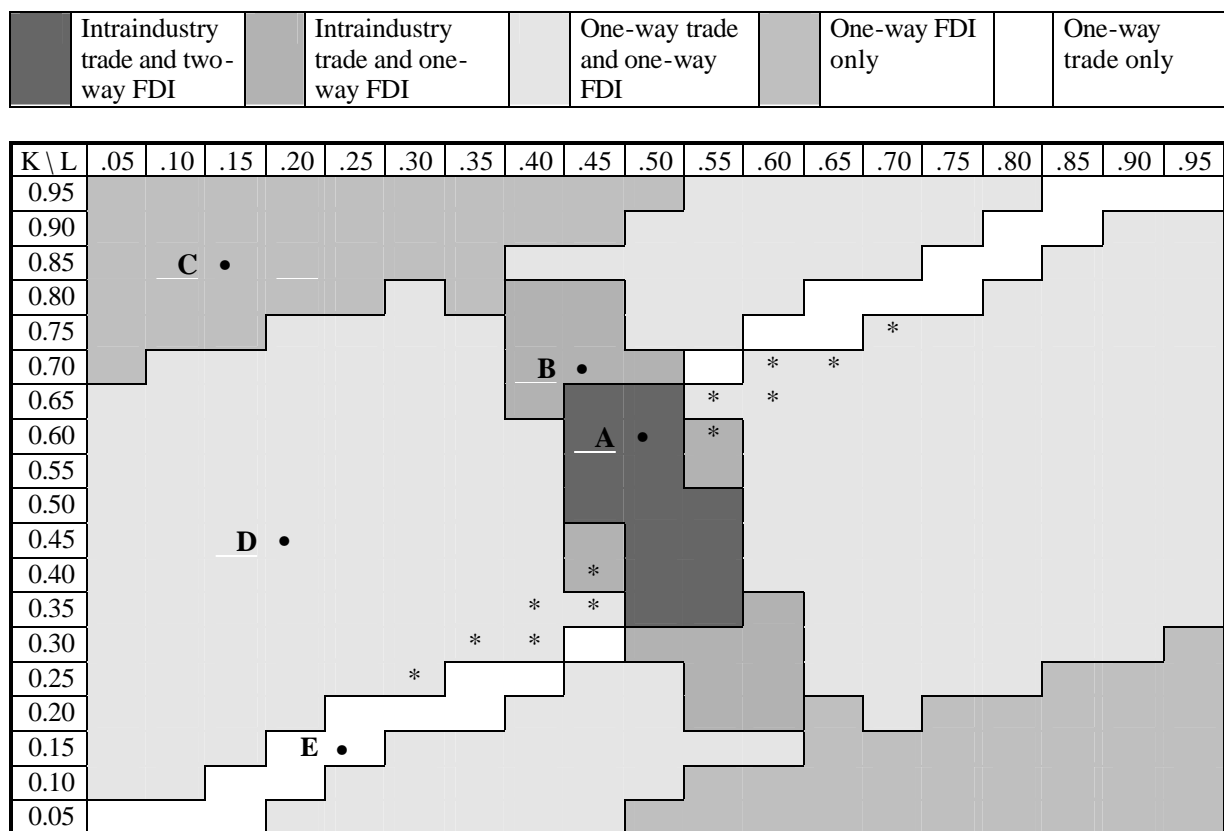

* Capital flows from the labor-abundant to the capital-abundant country.

In the region above the center along the equal-income line (Point B), intraindustry trade continues to exist and the capital-abundant country becomes the net exporter of the increasing returns to scale product. In contrast to this, two-way-capital flows cease to exist and capital only flows from the capital-abundant country to the labor-abundant one. Capital flows in the opposite direction dry up because the retrenched supply of capital in the foreign market renders foreign MNEs uncompetitive and forces them to exit the market. In the extreme upper left-hand corner (Point C), vertical multinational enterprises prevail, taking advantage of substantial factor price differences. Capital is so scarce in the foreign country that the domestic country switches from the indirect export of capital services embodied in the exported goods to the direct export of capital by means of FDI. Thus, the capital-abundant country continues to export capital whereas trade in the final product X comes to a halt. Below that area (Point D), the biggest section of the figure is made up of equilibria with one way-trade and one-way FDI, with good X and capital flowing in opposite directions. Finally, close to the diagonal (Point E) there is a narrow band where the exporters of the capital-abundant country displace all other firm types so that there is only one-way trade in X but no capital flows.

With respect to FDI, one would expect that capital flows from the capital-abundant to the labor-abundant country to take advantage of differences in the marginal product of capital. Although this hypothesis is generally corroborated, the simulation results indicate that there are exceptions from that rule. The first one is the cross-hauling of FDI between almost identical countries which is based on the advantage of producing close to the market. The second exception is that capital flows upstream when the two countries are similar (but not identical) in relative and not too different in absolute endowments. In this case, the labor-abundant country still has a marginally higher wage-rental ratio because the other country's exporters exert a high demand for their domestic capital. In addition to exporting capital, the labor-abundant country also has substantial exports of the labor-intensive good Y. Therefore the capital-abundant country remains the net exporter of capital services despite its direct capital imports.

Since trade in services (R&D) is bound to an MNE's foreign investment, exporting (importing) capital always implies exporting (importing) services. Therefore a capital-abundant country (almost) always exports services. When relative endowments and income levels are similar and transport costs are positive both countries export services (intraindustry trade in services) but the capital-abundant country remains the net exporter of services. As with capital flows, the only exception is when a country is only somewhat capital-abundant and slightly bigger at the same time. In this case, capital flows upstream and so do services. Trade in services increases when both relative factor endowments and income levels either converge or diverge. Only when one of the two is similar while the other is very different will trade in services be small.

Figure 9 analyzes trade in the labor-intensive products Y and I. Here, the trade patterns with positive transport costs are straightforward when relative factor endowments differ substantially. This is the case in the triangle starting in the upper left-hand (lower right-hand) corner where the capital-abundant country imports both labor-intensive products. When moving closer to similar relative endowments, the smaller but capital-abundant country continues to import the most labor-intensive product I but starts to export the somewhat less labor-intensive product Y. This is also the case when the world labor supply is split fairly evenly but one country owns the overwhelming part of the capital stock. When countries are identical good Y

is not traded and trade in intermediate inputs is balanced. Close to the diagonal, the two lightly shaded stripes correspond to the trade-only equilibria of Figure 5. The exports of Y from the small labor-abundant country to the big capital-abundant one are the counterflows to the X exports of the big to the small country.

Figure 9: Trade in Good Y and Intermediate Input I with Partly Mobile Capital

Country d imports Y and I	Country d exports Y and I	Country d imports I, exports Y
Country d imports Y, I not traded	Country d exports Y, imports I	Country d exports Y, I not traded

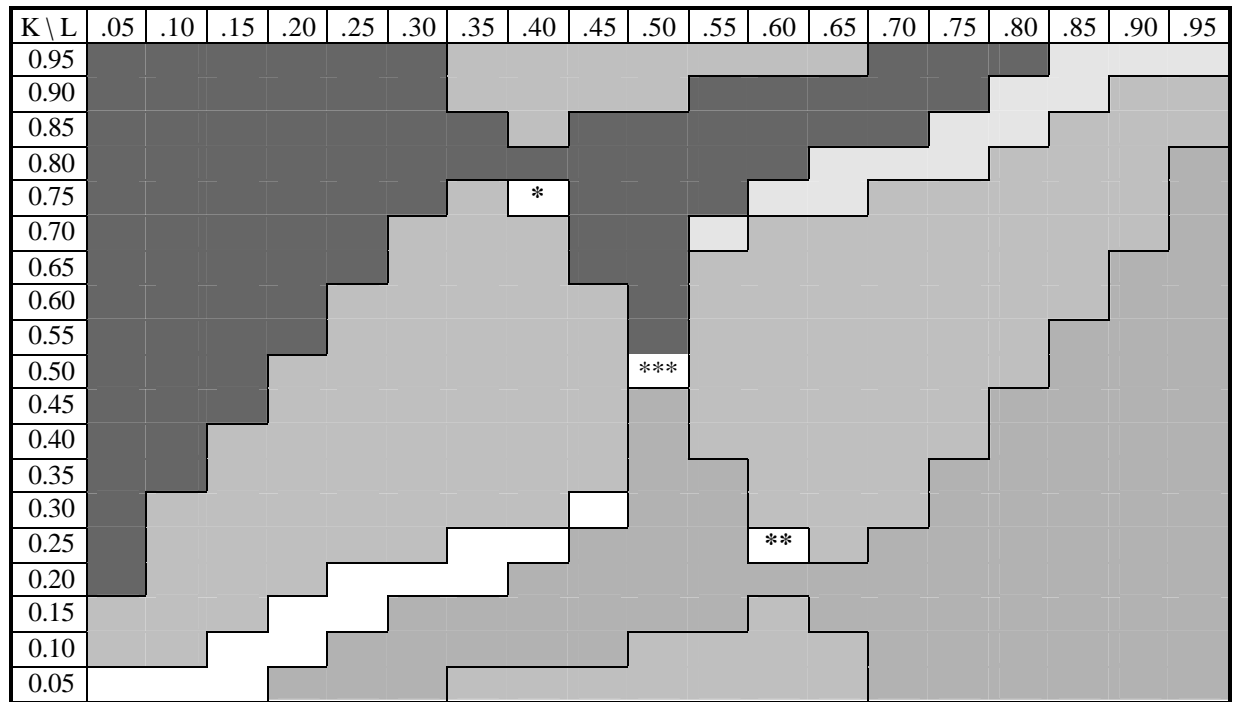

* Country d imports I, Y not traded; ** Country d exports I, Y not traded; *** Y not traded, trade in I is balanced.

Figure 10 takes a closer look at intrafirm trade in intermediate inputs. The iso-trade lines indicate factor endowments with identical volumes of intrafirm trade. The numbers in the figure are a cardinal measure for comparing intrafirm trade levels and bear no other meaning. With positive transport costs, the highest level of intrafirm trade in the intermediate input can be found when capital is concentrated in one country while labor is distributed fairly evenly among the two countries. In this region of the figure, MNEs of the capital-abundant country dominate, producing the intermediate input entirely in the labor-abundant country. Since the markets are of similar size exports of I from the foreign affiliate to the parent company are biggest. Trade in the intermediate input declines with relative endowment differences as the role of vertically integrated MNEs diminishes. Only in the center of the figure where horizontally integrated MNEs gain some prominence, intrafirm trade continues to exist. Here, the third type of intraindustry trade can be observed (in addition to intraindustry trade in good X and services): cross-hauling of the intermediate input.

Figure 10: Intrafirm Trade in Intermediate Inputs with Partly Mobile Capital

Figure 11 presents a summary of the direction of trade and investment flows. Without covering the details of all the different production and trade scenarios, some general results can be derived:

- Intraindustry trade only occurs when countries converge in income levels and relative factor endowments are not too different.
- Pure interindustry (Heckscher-Ohlin) trade only exists when the smaller country is slightly labor-abundant.
- The volume of service trade increases when both relative factor endowments and income levels either converge or diverge. When income levels diverge and relative endowments converge trade in services is either small or absent. With similar absolute and relative endowments there is intraindustry trade in services.
- Intrafirm trade in intermediate inputs increases with converging income levels. With positive transport costs there is also a local intrafirm trade maximum when relative and absolute factor endowments converge. Here, intraindustry trade in intermediate inputs can occur.
- Whereas capital often flows to the labor-abundant country, there are circumstances under which the capital-abundant country directly imports capital from the labor-abundant country. When countries are very similar in terms of relative as well as absolute factor endowments cross-hauling of FDI occurs.
- For a wide range of factor distributions with unequal relative endowments capital (as well as services) and good X flow in opposite directions. The more labor-abundant a country is in this region the more likely it is to import Y.

Figure 11: Direction of Trade and Investment Flows with Partly Mobile Capital*

Country d imports Y, I, exports K, R&D, no trade in X	Country d imports I, exports Y, R&D, K, no trade in X	Country d imports I, X, Y, exports K, R&D	Country d imports I, X, exports Y, K, R&D**
Country d imports Y, exports X, no trade in R&D, I, K	Country d imports I, exports X, Y, K, R&D	Country d imports Y, I exports X, K, R&D	Country d imports I, X, exports K, R&D; no trade in Y

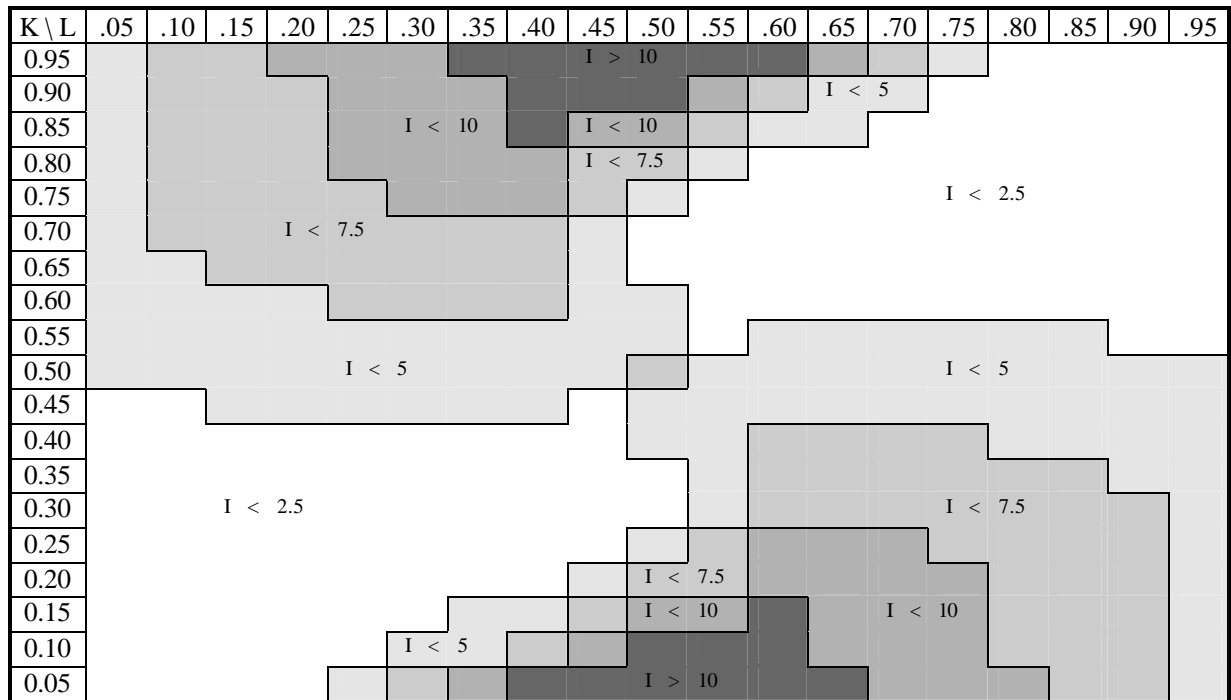
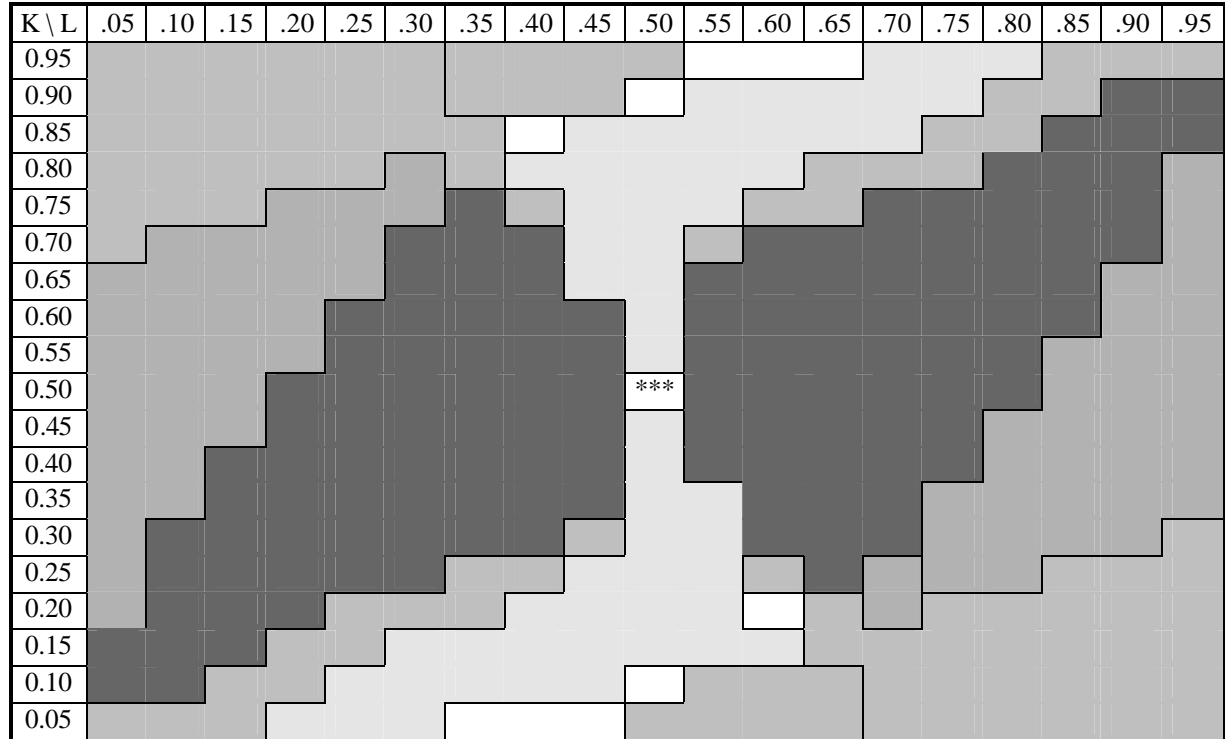

* Directions of trade and investment flows are given for endowment distributions above the diagonal. For distributions below the diagonal read country f instead of country d. ** For distributions to the left of the (vertical) equal-labor-distribution line. *** No trade in Y; no net trade in R&D, X, I; no net capital flows.

The trade and investment results also bear some meaning for policy making. Economic policies often limit the openness of countries with respect to trade and investment. The damage done by such restrictions can be expected to be most severe for countries which would substantially specialize in the absence of such restrictions. When total exports include services, the two final products and the intermediate input, the simulation results support the empirical observation that the share of exports in GDP is lower in large countries than in small countries. More interestingly, however, small countries turn out to be more open when they are labor-abundant rather than capital-abundant². The reason for this is that labor is immobile internationally. Therefore labor services can only be traded in terms of the labor content of goods so that labor-abundant countries must export all their labor embodied in goods. Contrary to labor, capital is internationally mobile so that capital-abundant countries can export capital services indirectly embodied in goods as well as directly in the form of FDI. Since FDI does not enter export shares small labor-abundant countries are more open with respect to trade in goods and services. The results are roughly the same for import shares and total trade shares. Consequently, trade policies which restrict exports out of (or imports into) small labor-abundant countries are more harmful than in the case of either small or big capital-abundant countries.

4.4 Goods and Factor Prices

The existence of positive transport costs should by itself lead to a low degree of factor price equalization because it inhibits trade. Evidently, this effect is more than offset by the emergence of MNEs which promote factor price equalization by transferring capital from the low rental rate country to the high rental rate country. As it turns out this direct mechanism of factor price equalization is much more effective than the indirect way via the factor content of trade. The existence of an area with full factor price equalization in the center of Figure 12 does therefore not come as a surprise as there are now MNEs complementing intraindustry trade. Somewhat astonishing is that MNEs bring forth (near) factor price equalization in most parts of the figure. The reason for this is that direct production abroad replaces intraindustry trade, switching from the indirect mechanism of factor price equalization to the direct one. Only in the most divergent factor distributions, capital movements, though existing, fail to achieve factor price equalization.

Figure 12: Degree of Factor Price Equalization with Partly Mobile Capital

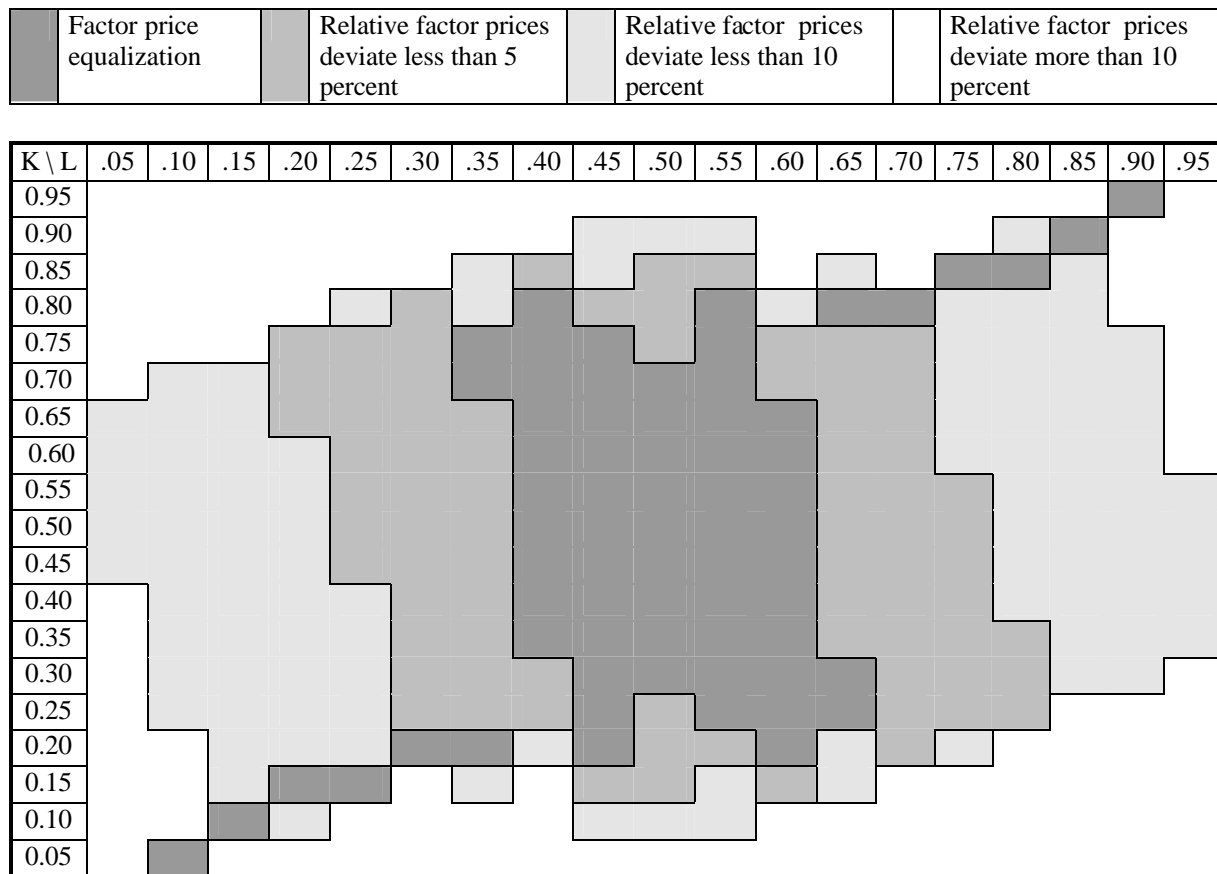

For countries with very similar absolute and relative factor endowments goods prices are almost equalized. For most other factor distributions, differences in relative goods prices occur. Only for very different relative factor endowments, however, tend these deviations to be large. Generally, two forces determine the relative goods price ratio between the two countries. First, the small country tends to be the (net) importer of good X. Therefore the share of good X supplied free of transport cost is lower in the small country and its relative price is higher. Secondly, capital abundance tends to make a country's MNEs competitive. These firms invest cheap domestic capital abroad to take advantage of cheap foreign labor. For a

vertically integrated MNE of a capital-abundant country, the only difference in the production cost at home and abroad is that plant specific fixed cost and final assembly of good X use cheap labor abroad while they have to use expensive domestic labor at home to carry out the respective production stages. Therefore a capital-abundant country tends to have a higher relative goods price. In short, a small, capital-abundant country has a higher relative price than a big labor-abundant country. In the case of a big, capital-abundant country, the sign of the relative price deviation is ambiguous as the two forces work in opposite directions.

4.5 Trade and Capital Mobility

With respect to foreign direct investment, a contentious policy issue is whether domestic jobs are exported in the wake of increasing investment abroad. Contrary to this „national“ point of view, the theoretical literature has discussed the issue from a more global perspective, i.e. whether the relationship between goods trade and factor mobility is one of substitutability or complementarity (e.g. Mundell 1957, Markusen 1983). While these studies conceptualize substitutability and complementarity in a number of different ways, Wong (1995, p. 99) proposes two intuitive definitions. In the price-equalization sense, trade and capital mobility are substitutes if free capital flows lead to goods price equalization and/or free commodity trade leads to factor price equalization. In the quantitative-relationship sense capital movements and goods trade are substitutes if increasing capital flows lower trade volumes and/or if bigger trade volumes diminish factor flows³.

The two formulations of the price-equalization test of the trade-investment relationship will be applied first. The introduction of partial capital mobility leads to the equalization of goods prices only if relative and absolute factor endowments are very similar, i.e. in the center of the Edgeworth box. Thus, only if countries are similar, appear trade and capital flows to be substitutes. As can be seen from Figure 12 in the preceding section, the factor price test leads to a similar result, except that there are more factor distributions for which factor prices are equalized and therefore trade and investment are substitutes. Again, these distributions are located in the center of the Edgeworth box. These results obviously hinge upon the fact that relative factor endowments are similar and therefore the scope for price equalizing activities is limited. Another caveat applies with respect to the conditions under which the tests are valid. First, goods trade has to be free which it is not because of positive transport cost. Secondly, capital is not perfectly mobile as it is linked to MNEs. Therefore the price tests are of limited use and the quantitative-relationship definition is likely to be more instructive when assessing the trade-investment link.

Three factors determine whether capital mobility fosters or curtails trade. First, any change in market structures from an exporters-only equilibrium to one that at least has some MNEs necessarily lowers the total volume of X-trade. Secondly, the emergence of MNEs generates trade in R&D and intermediate inputs which unambiguously increases total trade. The third factor influencing the change in trade volumes is the development of Y-trade which can change either way, depending on the particular pattern of specialization. Thus, trade and partial capital mobility are complements if the sum of increases in I and R&D-trade and the change in Y-trade more than offset the reduction in X-trade. Otherwise, trade and investment are substitutes unless market structures do not change at all. In this case nothing can be said about the trade-investment nexus as there are no capital flows and trade volumes remain unchanged⁴.

Figure 13 presents the results for the quantitative test, comparing the pure trade equilibrium and the equilibrium with partial capital mobility. Factor distributions for which the introduction of partial capital mobility leads to increases in trade volumes are represented by the white areas. In all shaded areas declining X-trade surpasses the increases in traded volumes of goods R&D, I, and Y. The factor distributions for which the complementarity hypothesis holds true are located in the center close to the diagonal representing identical relative factor distributions and secondly, where differences in relative factor endowments and country size are substantial. The complementarity relationship for countries of similar size and relative endowments can be explained by two factors. First, though MNEs of the capital-abundant country are competitive exporters of the bigger country remain the dominant suppliers of good X. This in turn leads to moderate declines in X trade and positive volumes of trade in R&D and I. Secondly, partial capital mobility allows for a higher degree of specialization. By investing abroad, MNEs of the capital-abundant country locate their production of the intermediate input in the labor-abundant country which in turn emerges as the sole supplier of the intermediate input. Since the production of I binds a substantial fraction of its labor supply the production of Y is partly shifted to the capital-abundant country which expands its exports of Y. Thus, moderate declines in the traded volume of X are more than offset by higher volumes of trade in R&D, I, and Y and trade and capital flows are complements.

Figure 13: Change in World Trade (CWT) due to the Introduction of Partial Capital Mobility²

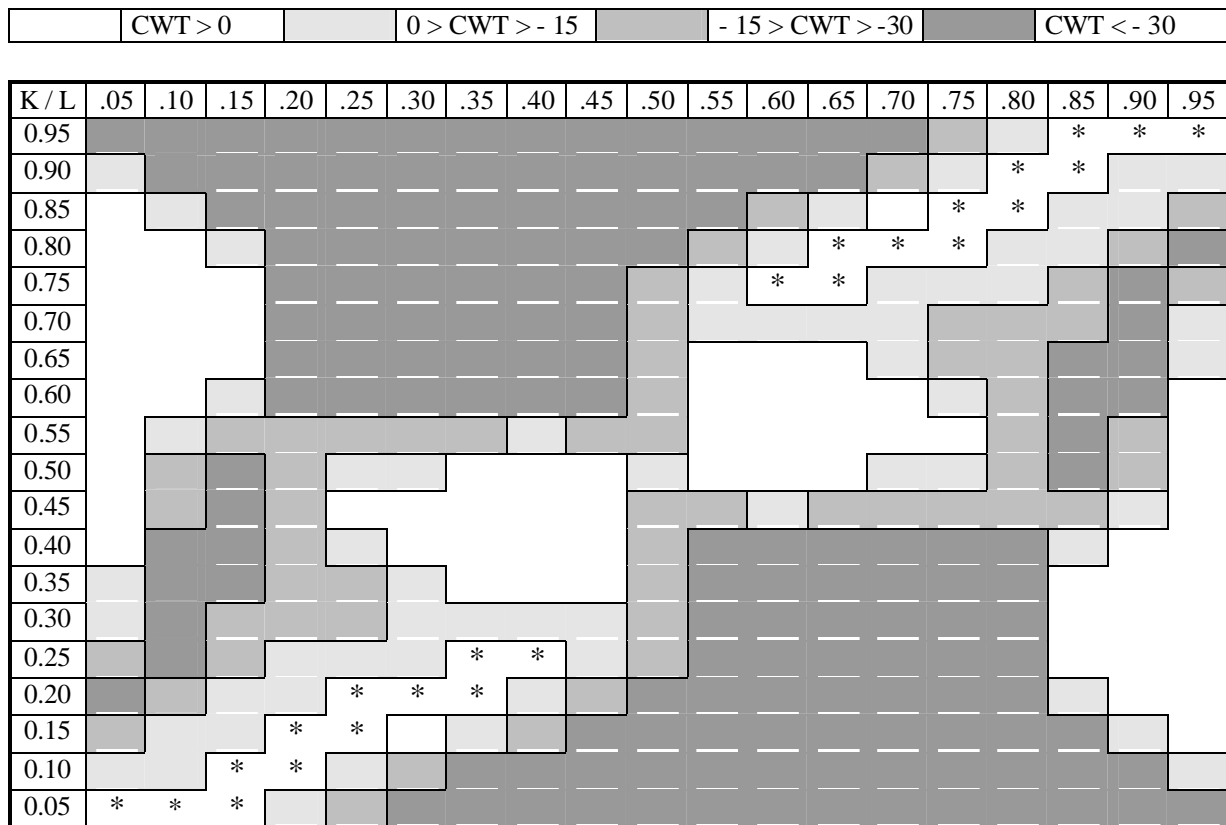

² Change in total trade volumes (in percent); * CWT = 0.

Complementarity at the upper left-hand (lower right-hand) to a large extent stems from increases in service trade as MNEs of the capital-abundant country are the sole producer of good X. Since the labor-abundant country is bigger in terms of income, markup revenues that

can be repatriated by the MNEs are large. In addition, positive intrafirm trade and in most cases increases in the volume of Y-trade contribute to offset abolishment or drastic reduction in the trade of good X.

Summarizing the findings, it is obvious that there is no generally applicable answer to the question whether trade and capital flows are complements or substitutes. Rather, this answer depends on how the specific factors shaping market structures are affected by the introduction of partial capital mobility. Two crude generalizations, however, can be made with some confidence. First, for industrialized countries the change in total trade volumes can take place either way depending on the relative size of the absolute and relative factor endowment differences. Secondly, substitutability is — cum grain sails — more likely the bigger relative factor endowment differences are.

The simulation results presented so far contribute to the debate in terms of clarifying the role of different relative and absolute factor endowments in the trade-investment relationship. However, since the model is strictly static, arguments advanced, for instance, in the literature on the optimal timing of investment cannot be dealt with. In addition, it can be expected that the introduction of a growth process would tend to change the trade investment relationship in favor of the complementarity hypothesis because even without changes in market structures, international exchange would be strengthened. Moreover, the question whether trade precedes or follows investment is irrelevant in this context because trade and investment are driven by common factors, i.e. factor proportions differences and the proximity-concentration tradeoff.

4.6 Welfare

The introduction of partial capital mobility changes the original trade equilibrium in a number of ways on the production side of the economy as well as on the demand side. The first issue related to welfare considerations is in which ways the welfare of individual countries is affected. Welfare changes can be expected to differ depending on the country's relative positions as either capital- or labor-abundant or as the small or the big country. The second issue is what the net welfare effect for the world is, whether welfare gains in one country are always sufficiently big to offset possible welfare losses in the other country. In order to analyze these questions, the welfare effects of partial capital mobility are laid out first. Secondly, a full account of the total welfare effect for one country will be given taking into account the relevant country asymmetries. Thirdly, it will be checked what the total welfare effect for both countries taken together is.

Introducing partial capital mobility allows capital to flow from the low marginal productivity country to the high marginal productivity country to the extent that capital is used in the production of good X. Since MNEs only move capital abroad if the returns earned there equal at least the domestic rate of return it is necessarily true that capital exports increase the income of the capital exporting country. For the capital-importing country this is not necessarily true as higher labor income (brought about by additional capital) is at least partly offset by lower capital income.

The opportunity to move capital abroad coincides with a change in market structures which also affects national welfare levels in a number of ways. First, as export volumes of good X are partly replaced by local production, world demand for transport services declines and therefore demand for labor which should result in a lower relative wage in the exporting

country. At the same time, production of MNEs requires additional plants which are relatively capital-intensive. Therefore relative rates of return can be expected to rise. Finally, changes in market structures can be expected to exert a significant influence on the demand side of the economy by changing relative prices within one country and between countries (terms of trade).

Figure 14: Change in Domestic Welfare due to the Introduction of Partly Mobile Capital

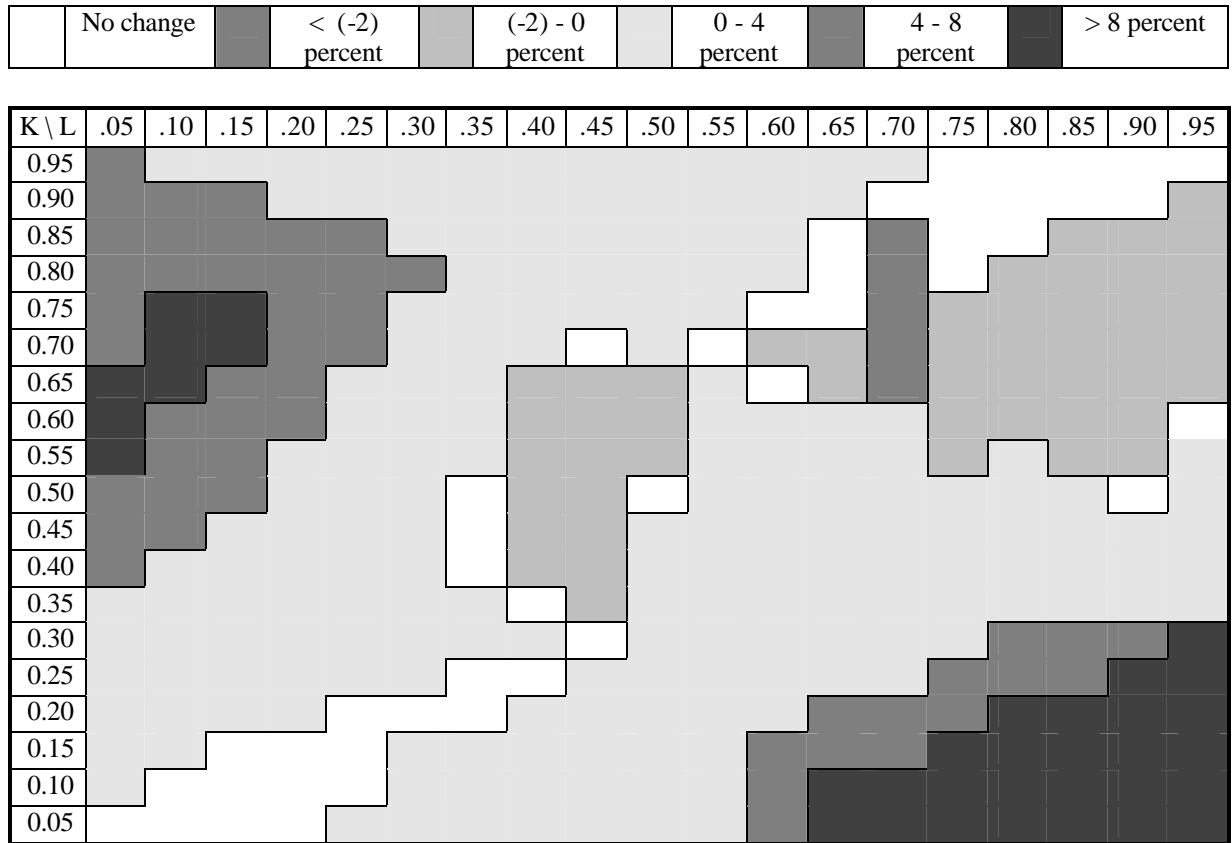

According to the results concerning the welfare of an individual country presented in Figure 14, the introduction of partial capital mobility almost always proves to be a welfare enhancing measure. Only very similar countries and very big and slightly labor-abundant countries see their welfare levels reduced by a small fraction. As explained above, welfare gains are indeed strongest where relative factor endowment differences are biggest.

The changes in global welfare are presented in Figure 15. As could be expected from the results for individual countries (Figure 14), the world gains little from the introduction of partial capital market integration when relative factor endowments are similar. The welfare gains, however, tend to increase with the difference in relative factor endowments. It should be noted that under no circumstances is world welfare reduced by the introduction of partly mobile capital

Figure 15: Change in World Welfare Level due to Partly Mobile Capital

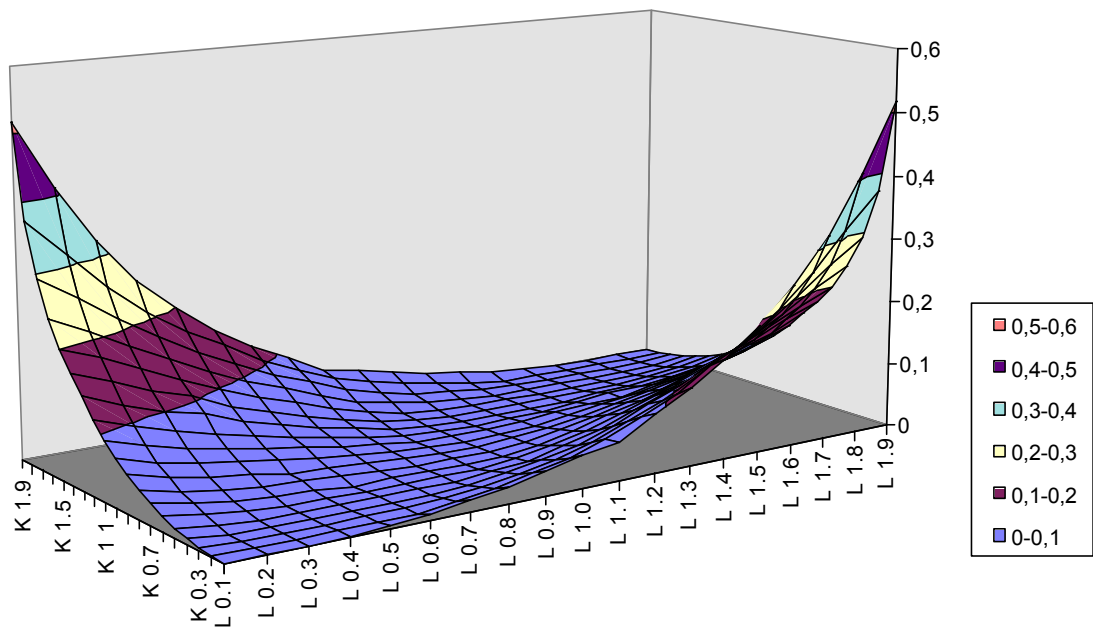

5. International Capital Market Integration

This chapter extends the international mobility of capital to exporters and producers of good Y. Capital requirements of all productive activities in both countries can now be fulfilled in a global capital market at the same global rental rate. This is also true for MNEs which do not necessarily have to deploy part of their domestic capital stock abroad but can also finance their foreign direct investments in the global capital market.

For identical countries, the equilibrium exhibits exactly the same properties as the equilibrium with partial capital mobility. Multinational enterprises and exporters of both countries co-exist. All X-related production as well as production of good Y is carried out in both countries. Since goods and factor prices are equalized between the two countries multinational are solely of the horizontal type and determining which firm types are competitive boils down to the proximity-concentration tradeoff. Internationally, balanced intraindustry trade in good X as well as in R&D, and the intermediate input I exists. Good Y is not traded and capital flows in both directions just balance. The reason that enhancing capital mobility between two identical countries does not induce changes is that trade and partial capital mobility were sufficient to equalize goods and factor prices so that there are no gains to be had from further specialization or reallocation of production.

5.1 Allocation of Production and Market Structure

Figure 16 depicts which types of firms are active in equilibrium. Except for situations in which country sizes are similar, exporters of the big country dominate the market for good X, regardless of the two countries' relative factor endowments. Their dominance depends on two

factors. First, with factor prices being the same for all firm types, vertically integrated multi-nationals which previously exploited relative factor price differences disappear. Secondly, exporters of the small country are not competitive because their home market is too small to earn sufficient markup revenues to engage in reciprocal dumping in the big country. Situations in which more than one firm type is active are confined to factor distributions which generate similar income levels in both countries. Decreasing differences in country size first lead to market entry of exporters from the small country. With very similar income levels but diverging relative factor endowments, MNEs of the capital-abundant country become competitive and enter the market. Finally, all four firm types exist in the center region of the figure, again with transport cost and fixed cost of a second plant abroad roughly being the same.

Figure 16: Active Types of Firms with Capital Mobility

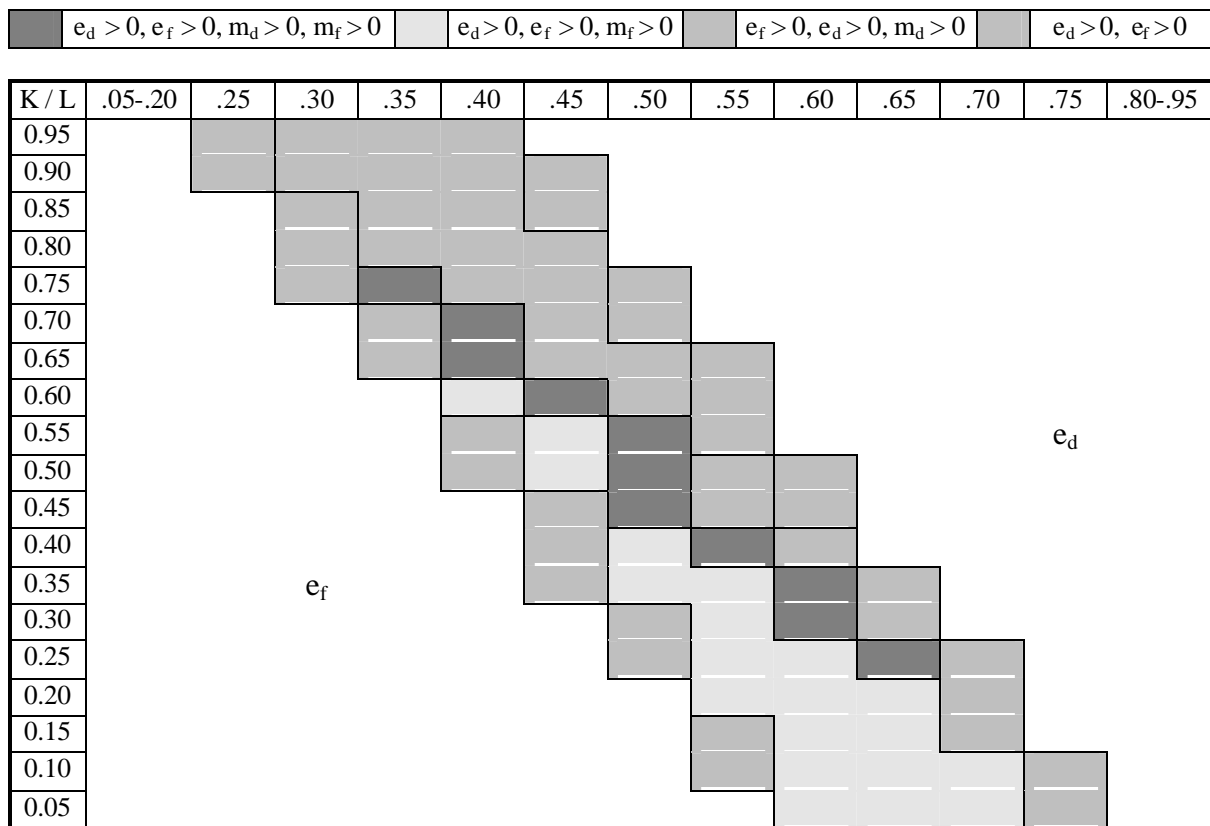

The allocation of production is significantly simplified through the introduction of full capital mobility. Since exporters cannot separate individual production stages R&D, the intermediate input I, and the final assembly of good X are always carried out in the bigger country. If income levels are sufficiently similar all X-related production stages are located in both countries. This is also true for the labor-intensive good Y (Figure 17) irrespective of the distribution of factor endowments.

With perfect capital mobility, the global capital market always allocates capital so that the marginal product of capital is identical in all uses and in both countries. At first glance, this can be expected to lead to identical allocations of production, independent of a country's capital endowment as long as labor endowments do not change. Since consumer preferences are identical across countries differences in income levels due to the redistribution of capital endowment would be inconsequential. However, this is not true. Because factor price

equalization and sufficiently big differences in income levels eliminate all MNEs only exporters survive. Due to the home market bias only exporters from the big country will produce and export good X.

Figure 17: Production of Good Y and Intermediate Input I with Capital Mobility

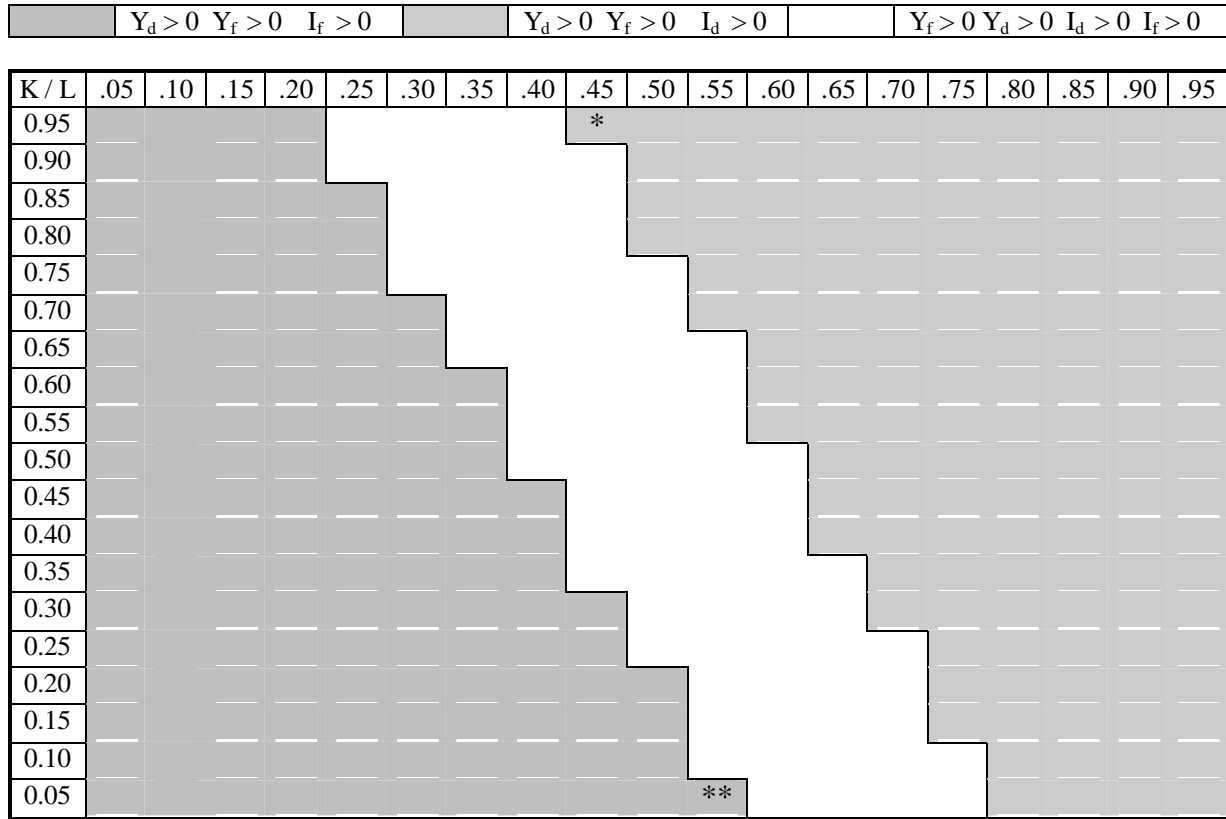

* $Y_f > 0, e_d > 0$ ** $Y_d > 0, e_f > 0$

Summarizing the results with respect to the allocation of production the following hypotheses can be derived:

- *Concentration of production with perfectly mobile capital:* The introduction of perfect capital mobility leads to a higher degree of concentration, with country size becoming the major determinant for production patterns. Capital-intensive R&D and the final assembly of good X are always concentrated in the big country as well as the labor-intensive production of the intermediate input. This is true regardless of the two countries' initial relative factor endowments. Only if countries are of similar size are all X-related activities carried out in both countries. Merely the production of good Y is never concentrated in any one country.
- *Specialization of countries with perfectly mobile capital:* Similarly, the introduction of perfect capital mobility leads to an increase in the degree of specialization and a shift towards country size as the major force determining production patterns. For most factor distributions, the small country fully specializes in the production of the labor-intensive good Y. Only for similar income levels do both countries sustain a diversified production structure.
- *Existence of multinational enterprises with perfectly mobile capital:* Since perfect capital mobility leads to universal factor price equalization vertical multinationals are not competitive. Only for very similar income levels, do horizontal multinationals exist.

5.2 International Trade and Foreign Direct Investment

Perfect capital mobility exerts a significant influence on international economic exchange. Figure 18 depicts the capital flows between the two countries. The difference between capital exports of a country and foreign direct investment is that the first covers capital flows generated by all firm types while FDI is simply that part of capital exports for which foreign production of MNEs is responsible. For all factor distributions above and to the left of the solid line, the domestic country exports capital while below and to the right, the foreign country is the capital exporter. For most factor distributions, relative factor endowments lead to capital flowing from the capital- to the labor-abundant country. There are only two exceptions from that rule. Similarity of income levels leads to cross-hauling of FDI. This is simply due to the competitiveness of MNEs from both countries and does not interfere with the expected overall capital flows from the capital-abundant to the labor-abundant country. In addition, there is a small band close to the diagonal where capital flows upstream. The reason for this counterintuitive result is that only exporters of the big country are competitive so that the big country is the sole producer of the capital-intensive good X. Even though the big country is slightly capital-abundant, the demand for capital is so vast that the marginal rate of return on capital is higher in the capital-abundant country, unless capital is imported from the labor-abundant country.

Figure 18: Capital Exports and Foreign Direct Investment

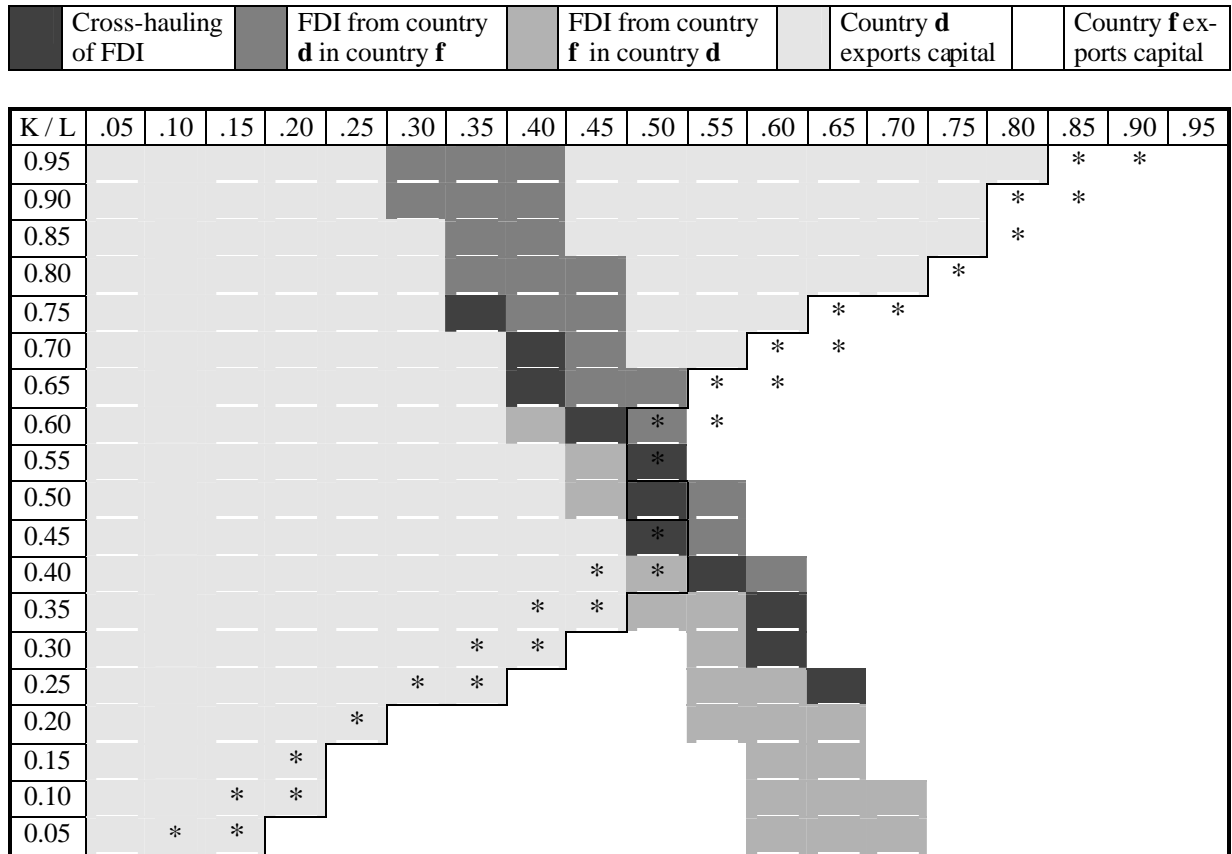

* Capital flows from the labor-abundant to the capital-abundant country.

The trade structure is simplified by the introduction of perfect capital mobility as well. The solid line in the middle of Figure 19 is the border between the positions of net importer and

net exporter of good X. To the left of it, the domestic country is the net importer of good X, to the right it is the net exporter. The other two lines define the areas where intraindustry trade in X occurs. Therefore factor distributions between the two lines on the left-hand side represent situations in which there is intraindustry trade with the foreign country being the net exporter. While the position of (net) exporter of X is now clearly a function only of country size, determining the direction of trade in good Y is less straightforward. On the one hand, the smaller country fully specializes in the production of Y turning international trade into pure intraindustry trade. On the other hand, this is not true any longer once a country is (very) capital-abundant. In this situation, income from capital invested abroad is so high that - despite the country's full specialization in the production of good Y - it can afford to import Y along with good X. Therefore capital and goods flow in opposite directions.

Figure 19: International Trade with Capital Mobility

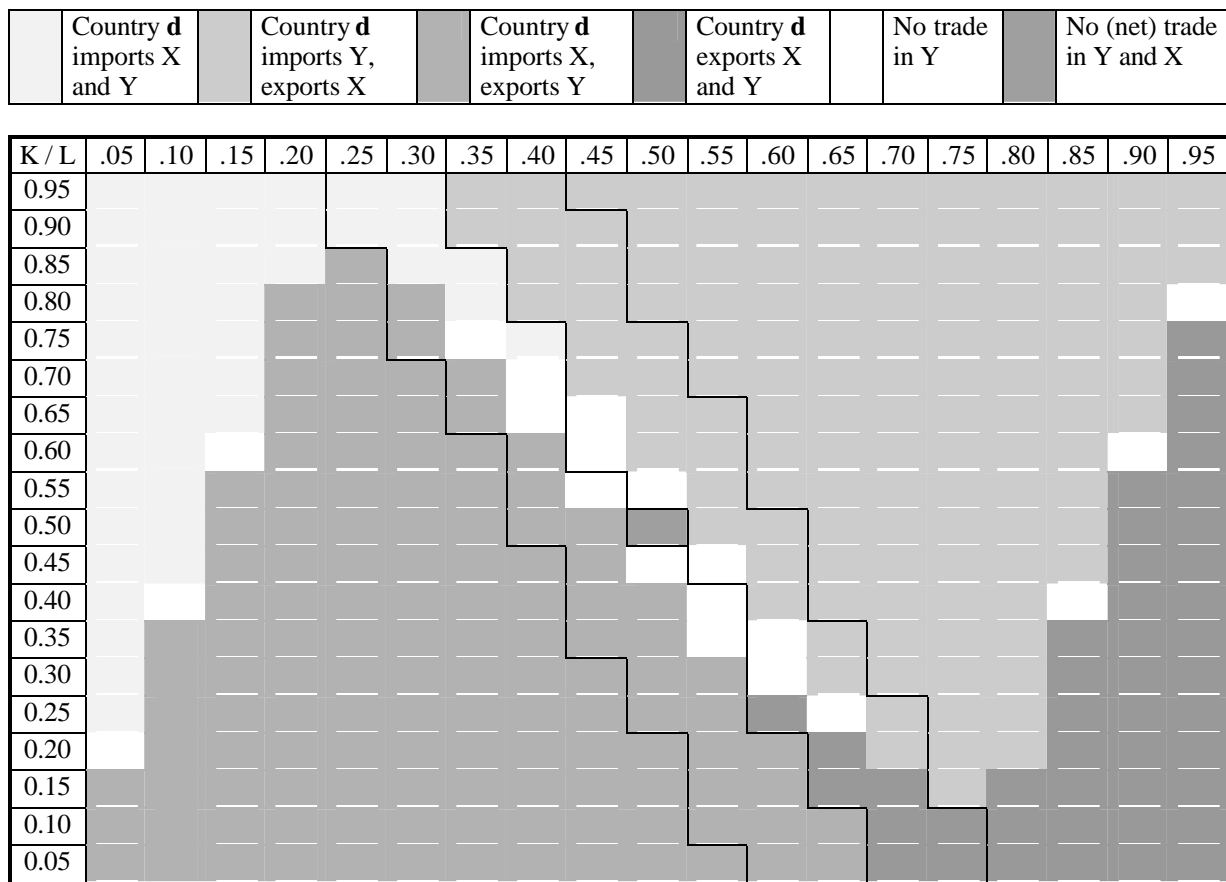

Changing capital mobility from the restricted to the unrestricted type also influences the relationship between trade and capital mobility. The trade-based version of the price-equalization test shows that goods trade and capital flows are substitutes because free trade equalizes factor prices. In addition, free capital flows equalize goods prices (except for transport costs) so that trade and capital mobility are substitutes in the strong version of the test. With respect to the quantitative-relationship test the results are not as clear-cut. Figure 20 compares trade and capital mobility when capital flows are free and restricted to MNEs whereas Figure 21 compares the capital mobility case with the trade-only scenario.

Figure 20: Change in World Trade (CWT) due to the Introduction of Perfect Capital Mobility¹

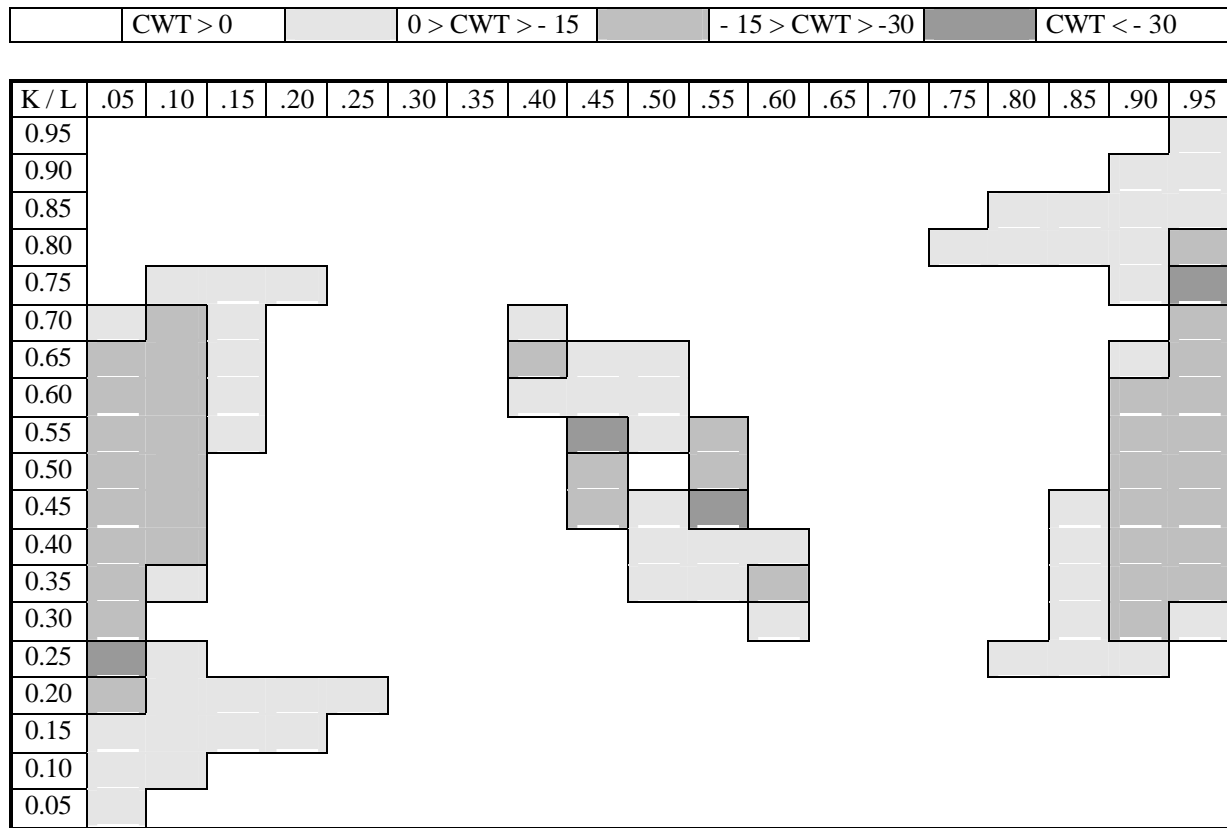

¹ Change in total trade volumes (in percent)

Relaxing the restrictions on capital mobility unambiguously increases capital flows. In most cases this leads to increased trade volumes. As was pointed out above, freeing capital flows leads to a higher degree of specialization which facilitates higher trade volumes. An additional factor, not present in the previous analysis, is that capital mobility allows exporters to take advantage of cheap foreign capital as well. This makes vertically integrated MNEs uncompetitive and brings about a renaissance of exporters and therefore a surge in X-trade. Merely in the center of Figure 21 where all four firm types are active in equilibrium and secondly, where income levels are very different, tend trade and capital mobility to be substitutes.

Figure 21 compares the situations when capital is immobile and fully mobile, thus comparing the results for the quantitative-relationship presented in Figures 13 and 20. Without covering the results in any detail, it is obvious that a substitutive relationship prevails when countries are very similar in income levels, but differ with respect to their relative factor endowments. In contrast to this, the complementarity hypothesis is supported for countries similar in relative endowments and but different in income levels. However, a more general hypothesis as to whether trade and capital mobility are substitutes or complements cannot be detected and the answer much depends on the specific factor determining the market structures.

Figure 21: Change in World Trade (CWT) due to the Introduction of Perfect Capital Mobility¹

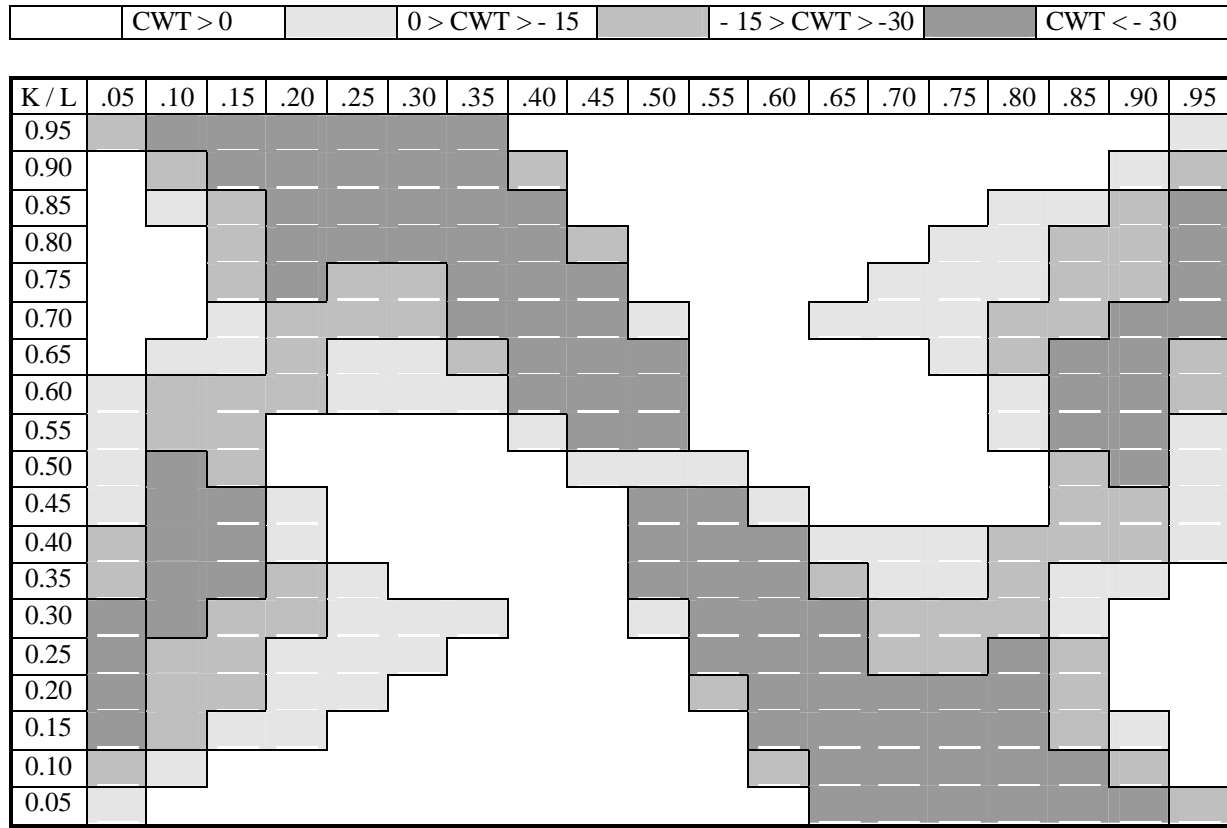

¹ Change in total trade volumes (in percent)

5.3 Goods and Factor Prices

Capital mobility and trade suffice to equalize factor prices even for the most divergent factor endowment distributions. Except for the case of identical countries, goods prices are, however, never equalized, with the small country facing the higher relative price of good X. For factor distributions which only allow one firm type (exporters of the big country) the difference in relative prices exactly covers transport costs because exporters of the big country have the same market shares in both countries and therefore charge exactly the same markups. In situations where there is intraindustry trade, the relative price differential is reduced as reciprocal dumping forces exporters of the big country to lower their markups in the small country so that they can compete with the indigenous exporters which sell free of transport cost. Entrance of multinational enterprise in the center region further reduces relative price differences. However, full goods price equalization only occurs when countries are identical.

6. Conclusions

The model analyzed the effects of increasing capital market integration which was modelled as a three-step-process, i.e. moving from a situation with immobile capital to one in which capital was partly to one in which an integrated global capital market existed. Making capital more mobile exerted a significant influence on national production and market structures, on international trade and capital flows as well as on welfare levels.

Capital market integration also changed the importance of the factors shaping production structures and international exchange. In the pure trade model, country size was the main determinant for the international division of labor with the big country taking on the role as exporting nation. When capital was made partly mobile differences in relative factor endowments played a more prominent role in determining production structures and international trade. The reason for this somewhat unexpected result was the emergence of MNEs. Because MNEs could geographically separate individual production stages they were able to bring the factor intensities of production closer in line with the relative factor endowments of the two countries. With perfect capital market integration, the pendulum swung back and differences in size regained their position as the predominant determinants of the international division of labor.

References

- Brander, James A, Paul R. Krugman (1983): *A 'Reciprocal Dumping' Model of International Trade*, Journal of International Economics, Vol. 15, 313-323.
- Friedman, James W. (1983): *Oligopoly Theory*, Cambridge.
- Horstmann, Ignatius J., James R. Markusen (1992): *Endogeneous Market Structures in International Trade (Natura Facit Saltum)*, Journal of International Economics, Vol. 32, No. 1, 109-129.
- Klau, Arne Ragnar (1995): *Firmeninterner Handel. Eine theoretische und empirische Analyse des unternehmensinternen Aussenhandels multinationaler Unternehmen*, Berlin.
- Konan, Eby, James R. Markusen, Anthony J. Venables, Kevin Zhang (1996): *A Unified Treatment of Horizontal Direct Investment, Vertical Direct Investment and the Pattern of Trade in Goods and Services*, paper presented at the European Trade Workshop in International Trade, Glasgow, September 5-8, 1996.
- Koop, Michael J. (1997): *Trade, Foreign Direct Investment, and Multinational Enterprises in a General Equilibrium Framework*, Kiel Working Paper No. 833, Kiel.
- Koop, Michael J. (2000): *Market Structures in International Trade: The Role of Partial Capital Mobility*, in: G. Rübel (ed.), *Real and Monetary Issues of International Integration*, Schriften zu internationalen Wirtschaftsfragen, Vol. 28, 15-30, Berlin.
- Markusen, James R. (1983): *Factor Movements and Commodity Trade as Complements*, Journal of International Economics, Vol. 14, 341-356.
- Markusen, James R. (1984): *Multinationals, Multi-plant Economies, and the Gains from Trade*, Journal of International Economics, Vol. 16, No. 1, 205-226.
- Markusen, James R., Anthony J. Venables (1995): *Multinational Firms and the New Trade Theory*, NBER Working Paper No. 5036, Cambridge, Mass.
- Mundell, Robert (1957): *International Trade and Factor Mobility*, American Economic Review, Vol. 67, 321-335.

- Rutherford, Thomas F. (1989): *General Equilibrium Modeling with MPSGE*, The University of Western Ontario.
- Shapiro, Daniel M. (1983): *Entry, Exit, and the Theory of the Multinational Corporation*, in: Charles P. Kindleberger and David B. Audretsch (eds.), *The Multinational Corporation in the 1980s*, 103-122, Cambridge, Mass.
- United Nations Conference on Trade and Development [UNCTAD] (2000): *World Investment Report 2000*, New York, Geneva.
- Wong, Kar-yiu (1986): *Are International Trade and Factor Mobility Substitutes?*, *Journal of International Economics*, Vol. 21, No. 1, 25-43.
- Wong, Kar-yiu (1995): *International Trade in Goods and Factor Mobility*, Cambridge, Mass.

Endnotes

¹ For mathematical details see Koop (1997). For an overview of the simulation techniques applied see Rutherford (1989).

² For small and medium-sized countries the results indicate that export shares are highest when relative factor endowment are close to the world factor endowment ratio. In most of these cases factor price equalization prevailed so that there were no vertical MNEs. Hence all exchange of factors occurs in terms of factor content of trade.

³ Wong (1995) further divides the two definitions into a strong and a weak version according to whether the statements hold in the „and“ or only in the „or“ form. For additional conceptualizations of the substitutability-complementarity issue see Wong (1986).

⁴ Another formulation of the quantitative relationship test was suggested by Koop (1997). The idea was to calculate the correlation coefficient between trade and investment for all distributions of the world factor endowment and define complementarity as a situation where trade and capital flows are both either above or below their average levels.

Appendix

d, f	subscript for domestic (foreign) country
e_d (e_f)	number of exporters in country d (f)
X_{Edf} (X_{Efd})	exports from country d (f) to country f (d)
m_d (m_f)	number of MNEs with headquarters in country d (f)
R&D	fixed costs at the firm level
T	fixed costs at the plant level
F	final assembly of good X
I	intermediate input used in the production of good X